

READ ME FIRST

Macintosh®

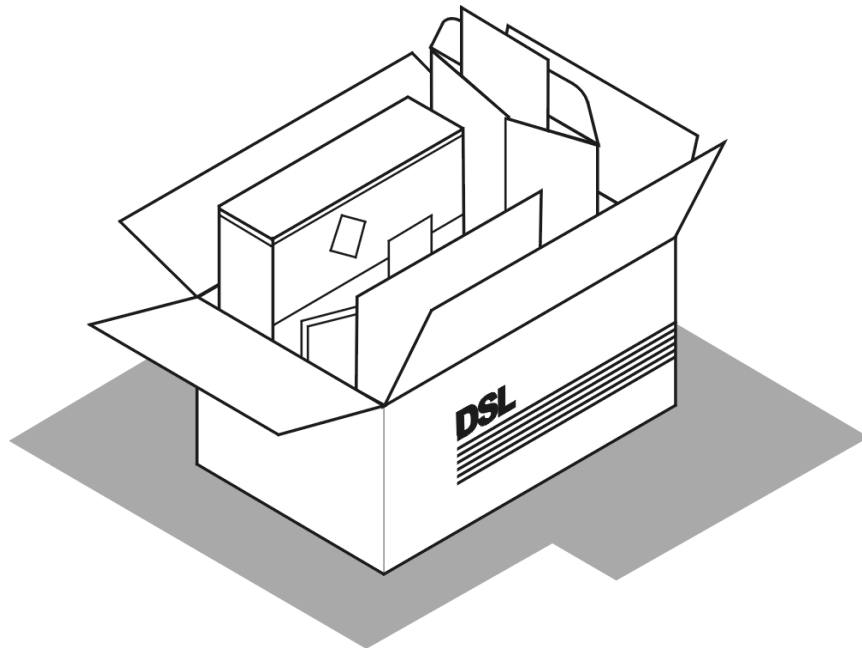

***DSL Equipment Installation Guide:
Westell® 516**



***Digital Subscriber Line**

**Part Number: W516MC01
Version 1.1**

©2001 SBC Advanced Solutions, Inc. All rights reserved.

Table of Contents

Follow Steps 1 through 8 to complete the DSL Equipment Installation

Step 1: Verify Your System Requirements and Documents	2
Step 2: Verify the Contents of Your DSL Equipment Kit	3
Step 3: Install a Telephone Filter on Every Telephone Line	4
Step 4: Choose Your Modem and Check Your Minimum Requirements	7
Step 5: Installing the Kingston® Software and Hardware	10
Step 6: Install the Westell® DSL Modem	11
Step 7: Finish Configuring your System	13
Step 8: Follow Internet Service Provider Instructions	15
APPENDICES	16
Having Trouble?	17
Installing the Kingston® Software and Hardware	18
DESKTOP Systems - Installing the Kingston® Ethernet Adapter	19
LAPTOP Systems - Installing the Kingston® Ethernet Adapter	21
Uninstalling/Reinstalling the Kingston® Adapter	23
Troubleshooting SBC Express	28

For Support:

- Review the **troubleshooting** in this guide on **page 17**
- Call your Internet Service Provider 'help desk' for further information on Internet Service Provider connection, and registration.

IMPORTANT NOTE: This guide portrays the typical flow for the installation process. Please follow the instructions, including running the SBC Express software BEFORE installing any NIC cards or modems. Some computer or network configurations may cause software windows to appear that are not depicted in this guide. Please read and follow the instructions on those screens to continue the installation process.

Verify that you are installing your DSL equipment AFTER the “Service Completion Date” given to you when you ordered your DSL Internet Service.

SBC Advanced Solutions, Inc. and affiliates have no responsibility for any personal injury or property damage which may result from your installation of DSL Equipment as discussed in this Guide. SBC Advanced Solutions, Inc. and its affiliates specifically disclaim any liability for such injury or damage. By proceeding with this installation, you assume all risk of personal injury or property damage. Please consult the documentation provided by your PC vendor to identify any impacts to your warranty. SBC, SBC EXPRESS and the SBC Logo are registered trademarks of SBC Communications, Inc.

***Step 1*: Verify Your System Requirements and Documents**

This Installation Guide is for Macintosh® users only.

The SBC Express installation software will ensure that you meet the following minimum requirements. You will not be able to complete the installation without meeting these requirements.

- **Macintosh®** system with any one of the following:
 - a) A built-in Ethernet port (consult your system's documentation for details)*
 - b) An available PCI slot (if Ethernet port not available)
 - c) An available PCMCIA slot and a floppy disk drive

****Please note: many Macintosh® systems already have a Network Interface Card installed. The SBC Express software will detect if you have a Network Interface Card installed. If your system already has a card installed, you DO NOT need to install an additional one. If you have any questions, please consult the information that came with your Macintosh® system.***

Other items you may need during the installation process:

- Your system manufacturer Owner's Manual.
- Documentation and/or software from your Internet Service Provider.

Call your Internet Service Provider if you have questions regarding System Requirements or System Documentation.

Step 2: Verify the Contents of Your DSL Equipment Kit

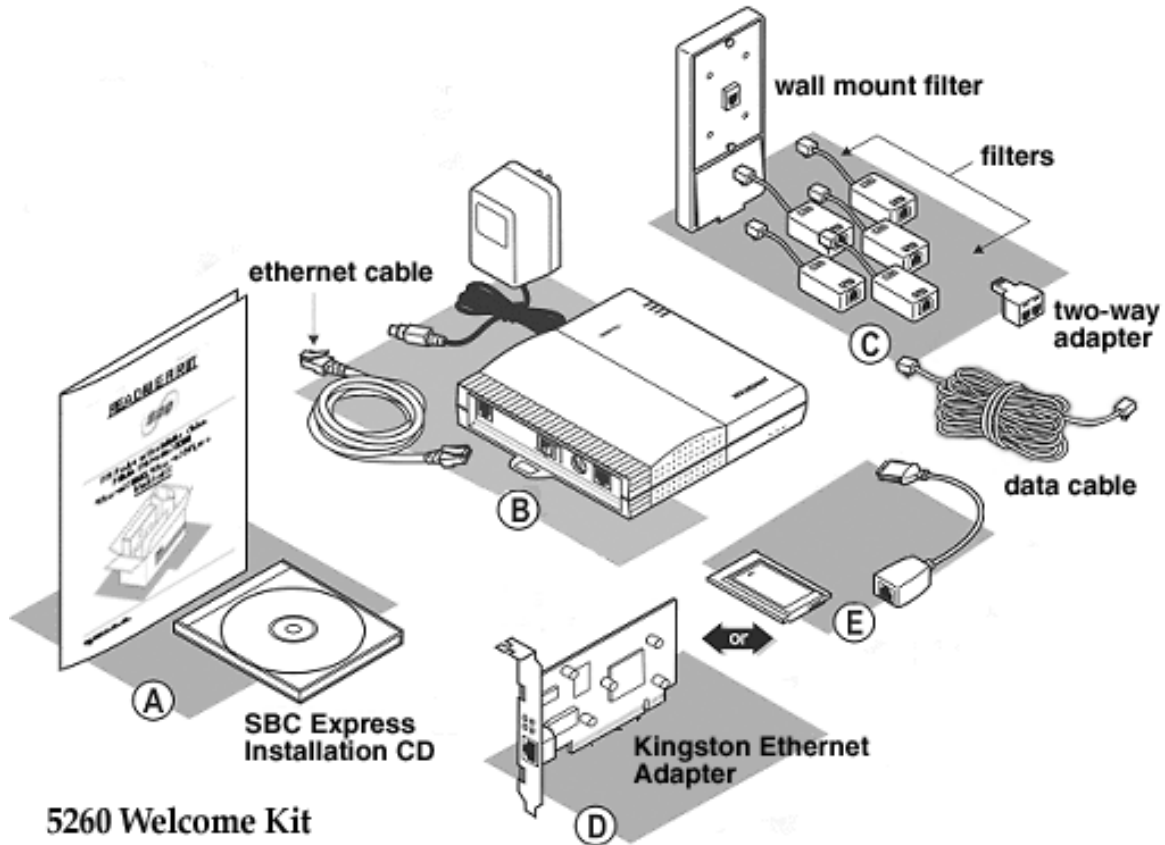

Your DSL Equipment Kit Contains:

- A: This Installation Guide and the SBC Express Installation CD.
- B: 1 Westell® 516 DSL Modem with Ethernet cable (connects to Adapter, below), and power cable.
- C: 1 Filter Pack containing: 5 in-line filters, 1 wall-mount filter, 1 two-way adapter, and 1 data cable.
- D: 1 Kingston® Ethernet Adapter for Desktop Macintosh (KNE110TX or KNE111TX)

--OR--

- E: 1 Kingston® Ethernet Adapter for Laptop Macintosh (KNE-PC2T)

Note: Internet Software and/or instructions may be provided separately by your Internet Service Provider.

Step 3: Install a Telephone Filter on Every Telephone Line

3-1 Set up the phone jack where your DSL modem will go.

1) Locate the phone jack where you want to connect your DSL

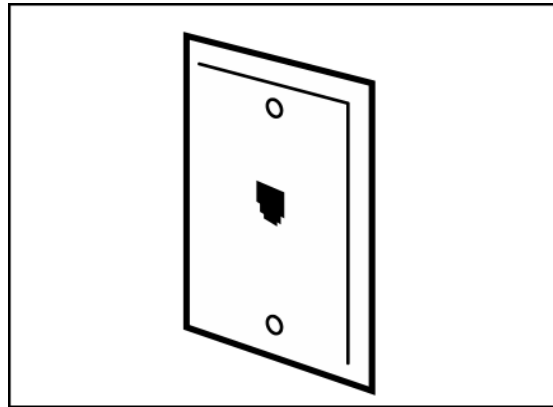

2) Insert the 2-way adapter in the phone jack

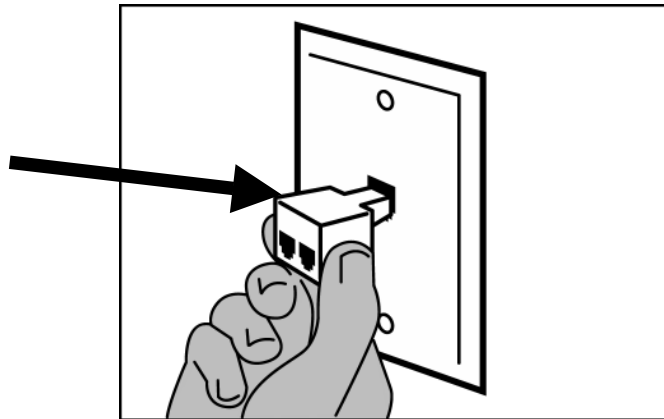

3) Connect a filter to one side of the 2-way adapter

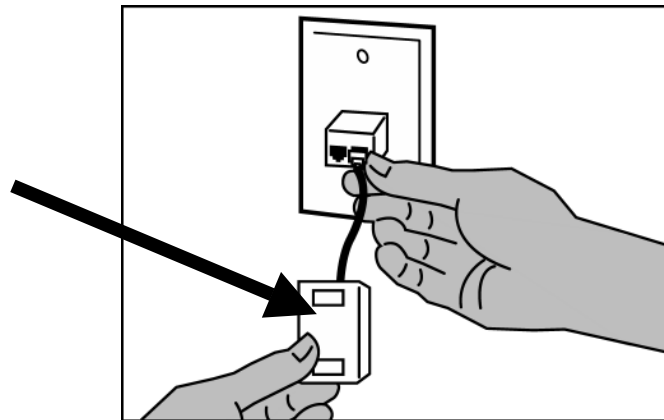

4) If you have a phone, fax machine, analog modem or other phone device at this location, connect it to the filter

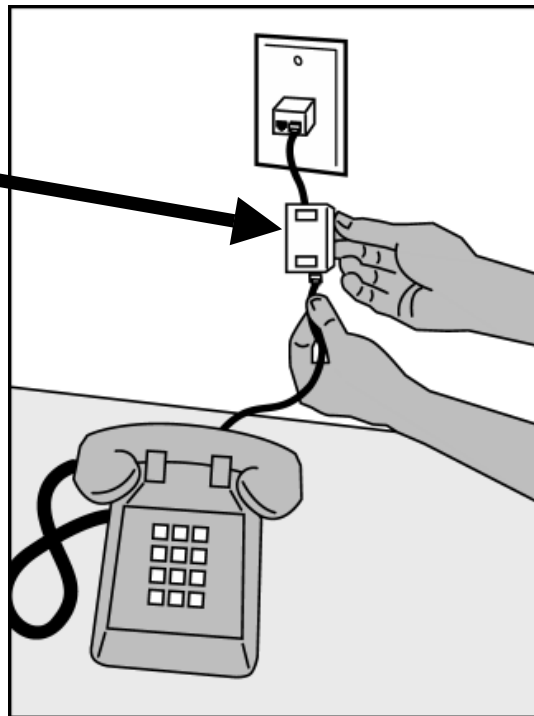

5) Connect the data cable that will go to your DSL modem to the unfiltered side of the 2-way adapter

To the DSL modem

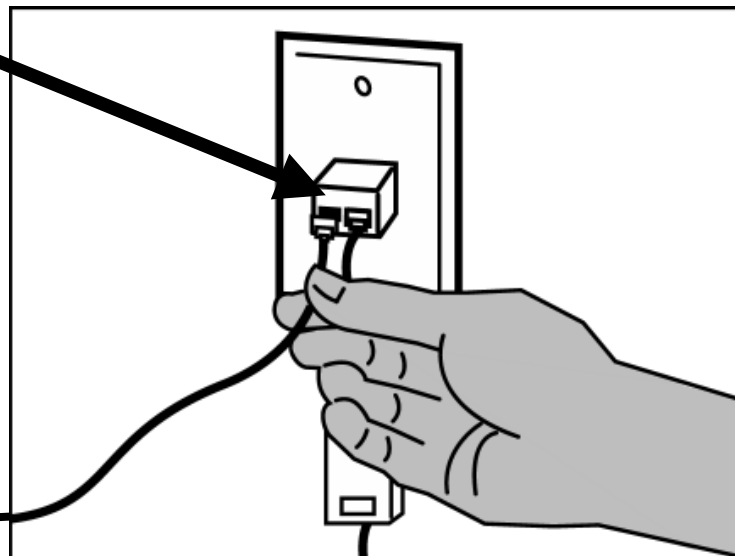

3-2 Install a filter on all other phones and phone devices.



Why do I need a filter on all my other phones and phone devices?

Converting your regular phone line into a high-speed Digital Subscriber Line (DSL) can cause audible noise (high pitched tones and static) when you talk on the phone. You need to install a filter on every telephone or device that shares the same phone number as your DSL line to eliminate this noise.

Other phones

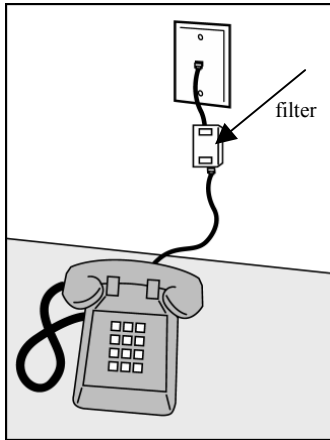

Answering machines

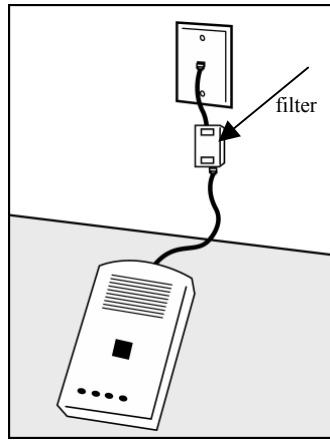

Caller ID boxes

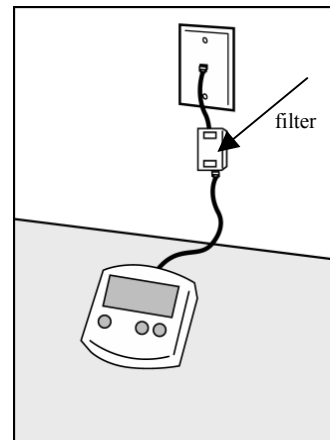

Analog computer modems

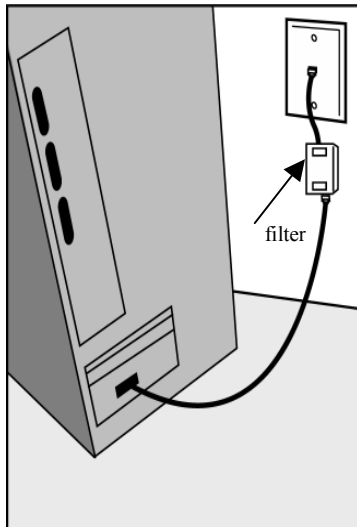

Fax machines

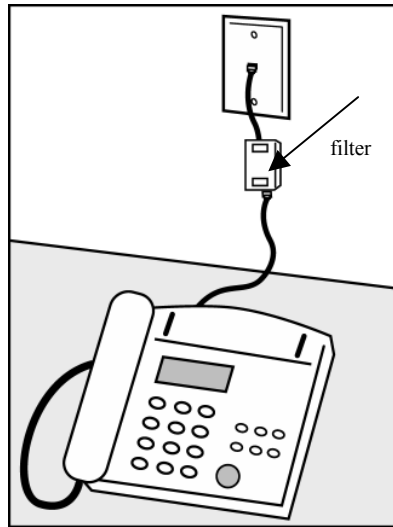

Wall mount phones

Use the wall mount filter shown

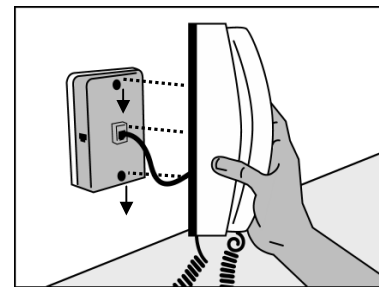
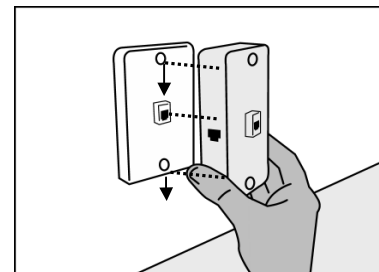

Remember! Don't install a filter on the data cable that you are connecting to your DSL modem.

Step 4: Choose Your Modem and Minimum Requirements Check

4-1 Insert the SBC Express CD into your CD-ROM drive. Double click the “SBC Express” icon.



4-2 SBC Express displays the Welcome screen. Click **Start** to proceed.

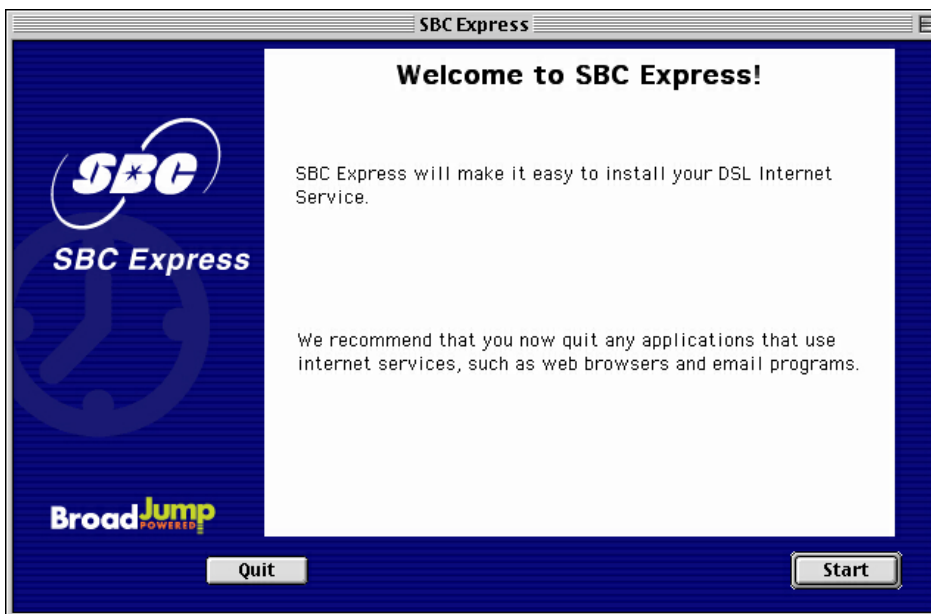

- 4-3 SBC Express displays the license agreement. If you agree to the terms, click **Accept**. If you do not accept, installation cannot continue.

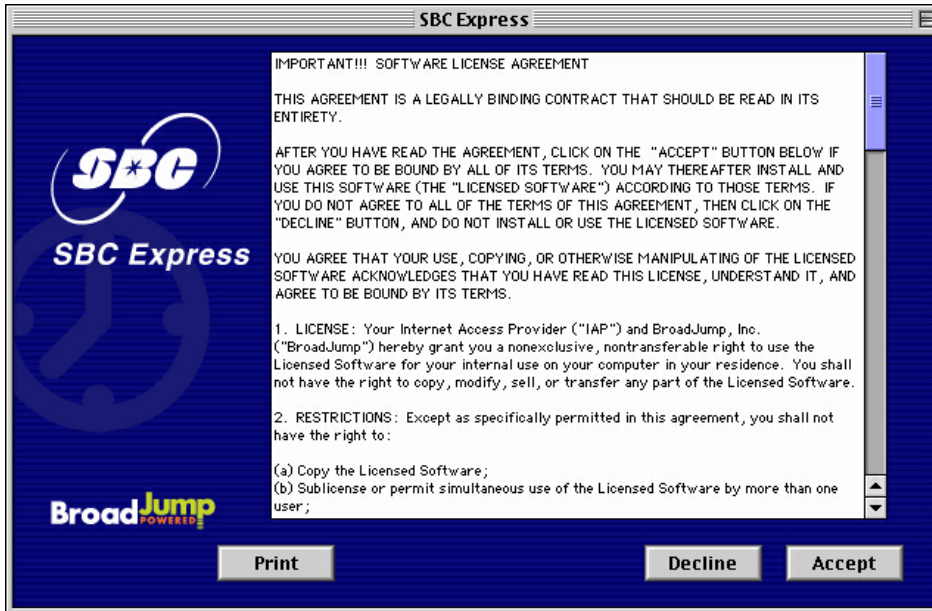

- 4-4 SBC Express quickly checks your computer system to ensure that it meets the minimum requirements for DSL service. Click **Next** to proceed if you meet all requirements.

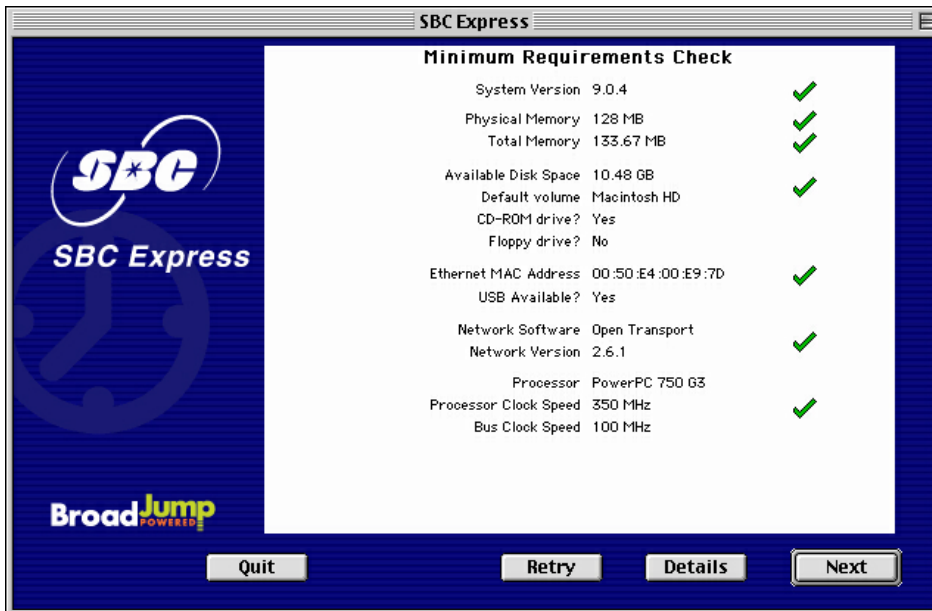

If your computer meets the minimum requirements, SBC Express automatically proceeds to the next step. You should continue to Step 6 on page 11.

If you shutdown your computer, **leave the CD in the CD-ROM drive**, and SBC Express will continue after you restart.

If your computer does not meet the minimum requirements, SBC Express displays a message with details of the problem. Your computer must meet the minimum requirements before you proceed.

If your computer fails the minimum requirements check because it does not have a Ethernet Adapter installed, please go to Appendix B on page 18.

If your network card is incorrectly installed, SBC Express will help you fix it. See *Troubleshooting SBC Express* on page 26 for help troubleshooting network card and minimum requirement problems.

Step 5: Installing the Kingston® hardware (if needed)

IMPORTANT NOTE: Most Macintosh computers already have an Ethernet card installed. If this is the case with your Macintosh, SBC Express would have reported that you passed the minimum requirements. If you see the following screen, it is **not necessary** to install the Kingston® Ethernet Adapter provided in this equipment package.

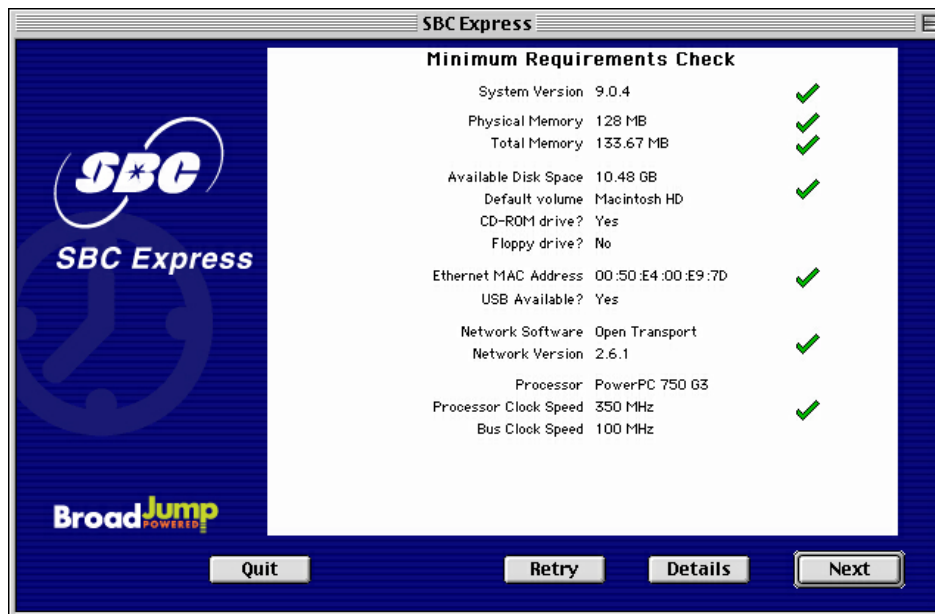

You may proceed directly to Step 6 on page 11 if you see the screen above. If not, you will need to install the Ethernet Adapter provided, and this requires that you open your computer. Please follow the instructions in Appendix B and consult the documentation provided by your computer vendor to identify any impacts to your warranty.

Step 6: Install the Westell® 516 DSL Modem

Your computer should be turned on. Your modem should be turned OFF.

You should be at the following screen in the SBC Express Software. Only click **Next** AFTER modem is setup.

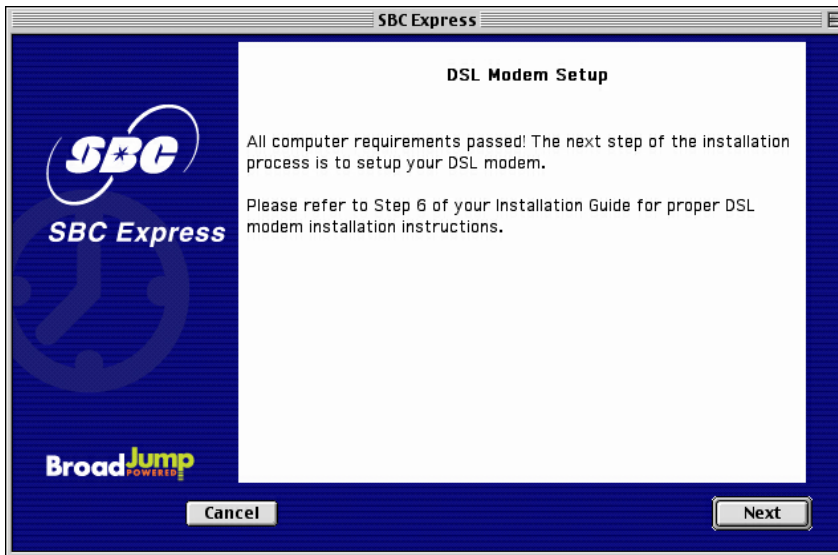

6-1 Consult the following diagram.

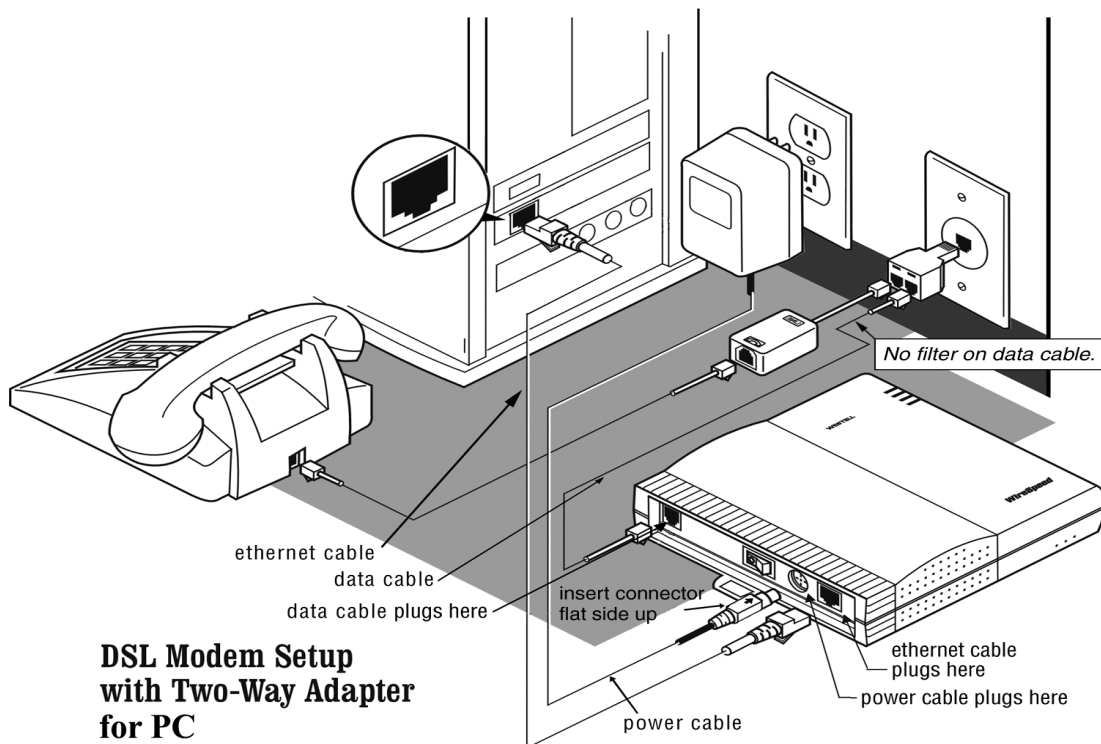

- 6-2 Plug the power cable into the DSL modem and an electrical outlet.
- 6-3 Connect the data cable to your telephone jack and your DSL modem. There should NOT be a filter between the data cable and the wall jack.
- 6-4 Connect the Ethernet cable to the Kingston® Ethernet Port or the built –in Ethernet Port on the back of your PC and to the Ethernet Port on the back of your DSL modem.
- 6-5 Turn the DSL Modem power switch **ON**.
- 6-6 The **Power**, **Link** and **Ready** lights should all turn solid green within two minutes.
- If the **Power** light does not turn solid green, check your power cable. Are you connected to a live electrical outlet? Are connections secured? Is the modem turned on?
 - If the **Link** light does not turn solid green, check your Ethernet connections. Are they secure? Is the PC turned on?
 - If the **Ready** light does not turn solid green:
 - Verify that there is NO in-line filter on the data cable from your DSL modem to the telephone jack.
 - Try another telephone jack in your home.
 - Turn off the modem, reboot the computer and then turn the modem back on.
 - Verify that you are installing your DSL equipment AFTER the “Service Completion Date” given to you when you ordered your DSL Internet Service.
 - If none of these steps cause the DSL light to turn green, please call your Internet Service Provider 'help desk'.
- 6-7 Proceed to Step 7 by clicking **Next** on the DSL Modem Setup screen.

Step 7: Finish Configuring Your System

- 7-1 SBC Express now prompts you for your first and last name. Please type your first and last name and then click **Next** to proceed.

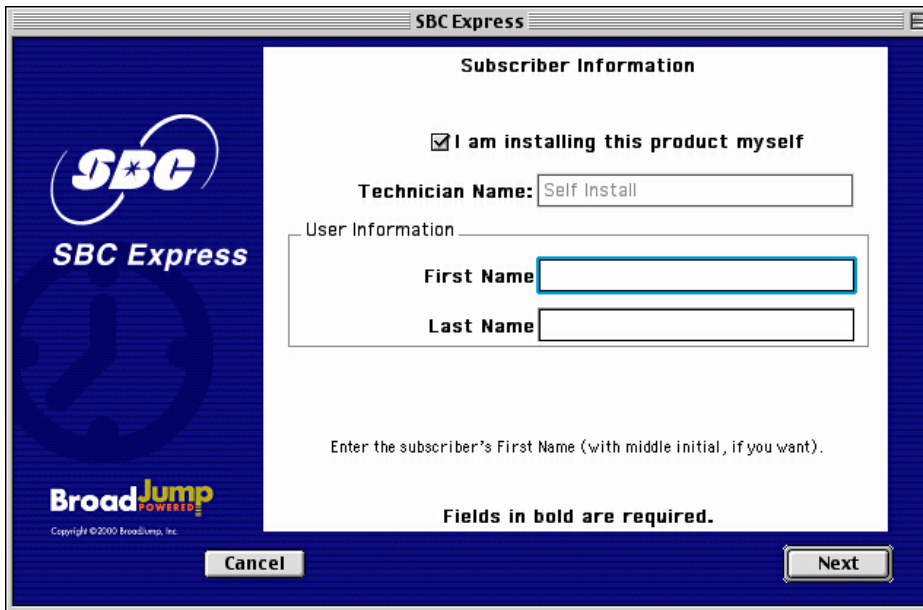

The screenshot shows the SBC Express installation window. The title bar reads "SBC Express". The window has a dark blue background with the SBC logo and "SBC Express" text on the left. The main content area is white and titled "Subscriber Information". It contains a checked checkbox "I am installing this product myself" and a "Technician Name" field with "Self Install" entered. Below this is a "User Information" section with "First Name" and "Last Name" fields. A note says "Enter the subscriber's First Name (with middle initial, if you want)." and a warning "Fields in bold are required." is at the bottom. "Cancel" and "Next" buttons are at the bottom.

- 7-2 Enter your 10-digit phone number in the next screen. Click **Next** to proceed.

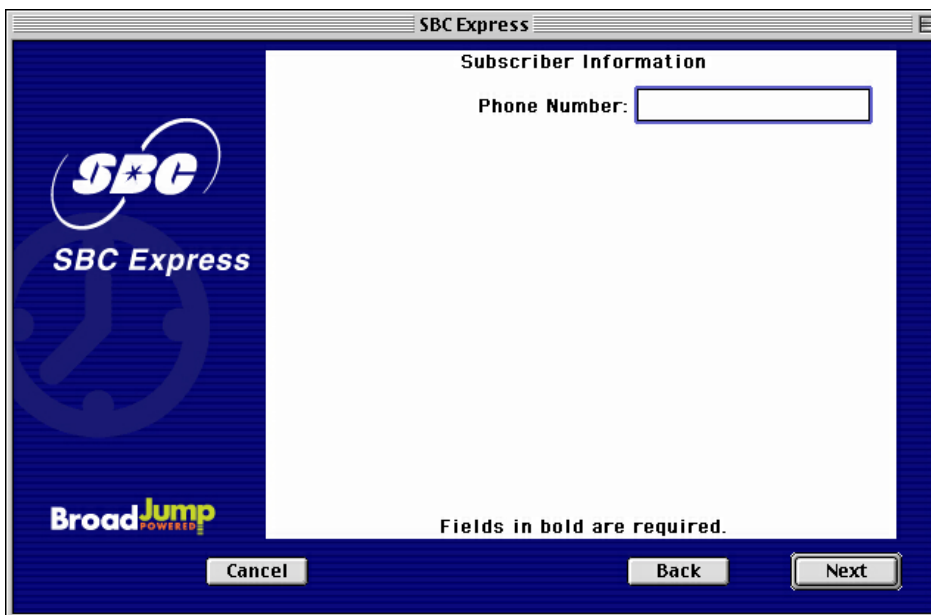

The screenshot shows the SBC Express installation window. The title bar reads "SBC Express". The window has a dark blue background with the SBC logo and "SBC Express" text on the left. The main content area is white and titled "Subscriber Information". It contains a "Phone Number:" field. A warning "Fields in bold are required." is at the bottom. "Cancel", "Back", and "Next" buttons are at the bottom.

- 7-3 Congratulations! You have finished setting up your DSL hardware. Click **Quit** in SBC Express and then proceed to Step 8.

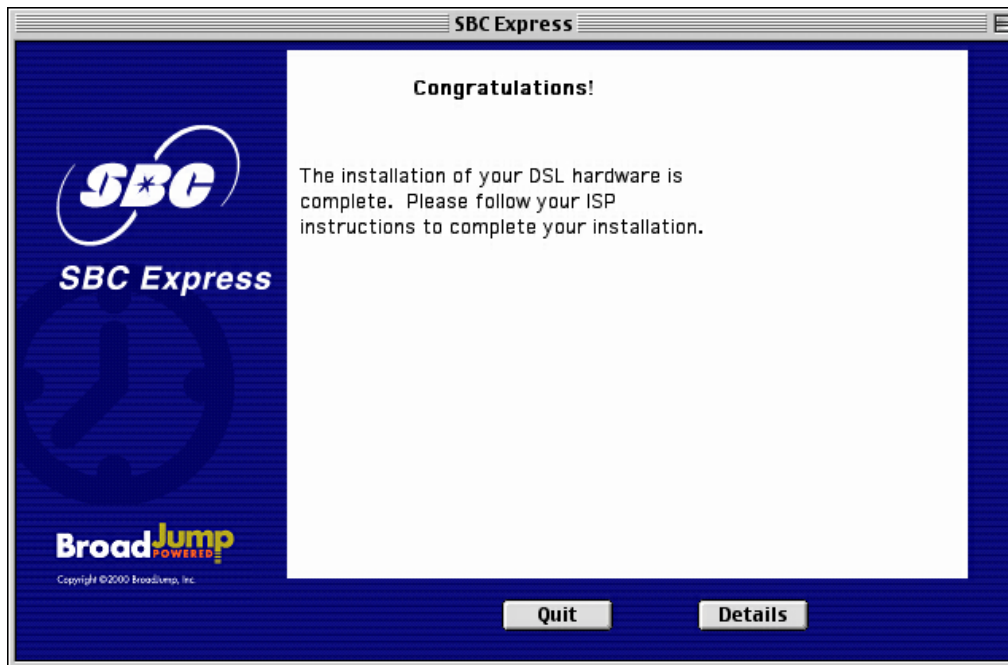

***Step 8:* Follow the Instructions Supplied Separately by your Internet Service Provider**

Your Internet Service Provider may have provided you additional instructions. These instructions may contain information about account setup, additional software installation, and/or Internet usage. Please follow those instructions to complete your Internet connection setup. Your Internet Service Provider will offer technical assistance if you need help connecting to the Internet.

Appendices

APPENDIX A

Having Trouble?

If the suggestions below don't resolve your problem, technical support is available from your Internet Service Provider. Please refer to the Internet Service Provider's information on how to contact them for technical assistance.

I can't open my computer case. What do I do?

- Consult your computer manufacturer's Owner's Manual.
- Call your computer manufacturer's Support Line.

I can't connect. What do I do?

- Make sure there is no filter on the phone jack/cord connected to your DSL modem
- Check your Ethernet cable connection. Is it secure?
- Verify that you are installing your DSL equipment AFTER the "Service Completion Date" given to you when you ordered your DSL Internet Service.
- Call your Internet Service Provider 'help desk' for further information on Internet Service Provider connection, and registration.

APPENDIX B: Installing the Kingston® hardware (if needed—see Step 5)

IMPORTANT NOTE: If your computer already has an Ethernet card installed and you passed the minimum requirements step in the SBC Express Installation Software, it is not necessary to install the Kingston® Ethernet Adapter provided in this equipment package. If you have a newer Macintosh (iMac®, iBook®, and G4 Cube®) with a built in Ethernet port you do not need to install the provided Kingston® Ethernet Adapter.

If you shutdown your computer, **leave the CD in the the CDRom drive,** and SBC Express will continue after you restart.

Installing the Kingston® Ethernet Adapter

- Follow steps B-1 through B-10 below for **Desktop** Macintosh installations.
- For **Laptops**, skip to step B-11.

DESKTOP Systems

- B-1 **Click Quit in SBC Express and then turn off all peripheral devices. Remember to leave the SBC Express CD in the CD-ROM drive.**
- B-2 Unplug the power cord for your computer from the electrical outlet.
- B-3 Open the case of your computer (review your computer manufacturer's Owner's Manual for specific instructions).
- B-4 Touch the computer chassis (metal frame) before touching the Kingston® Ethernet Adapter. This helps to protect the Kingston® Adapter from static electricity.
- B-5 Locate an available PCI slot (usually white in color). You may use any available PCI slot. Make sure you are looking downwards on the PCI slot. You may need to turn the computer on its side to accomplish this (*review your computer manufacturer's Owner's Manual for specific instructions*).
- B-6 Remove the metal PCI slot cover from the unused PCI slot, and retain the screw.

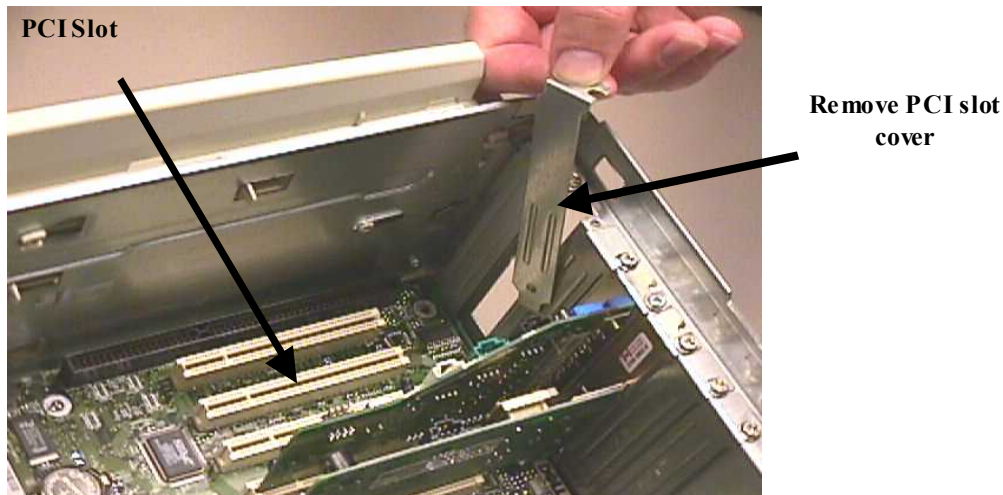

- B-7 Carefully insert the Kingston® Ethernet Adapter into any empty PCI slot. Make sure the card is completely seated by pressing firmly.

- B-8 Verify that the end bracket is flush against the chassis. Make sure the gold connectors along the base of the Kingston® Ethernet Adapter are completely and evenly inserted into the PCI slot.

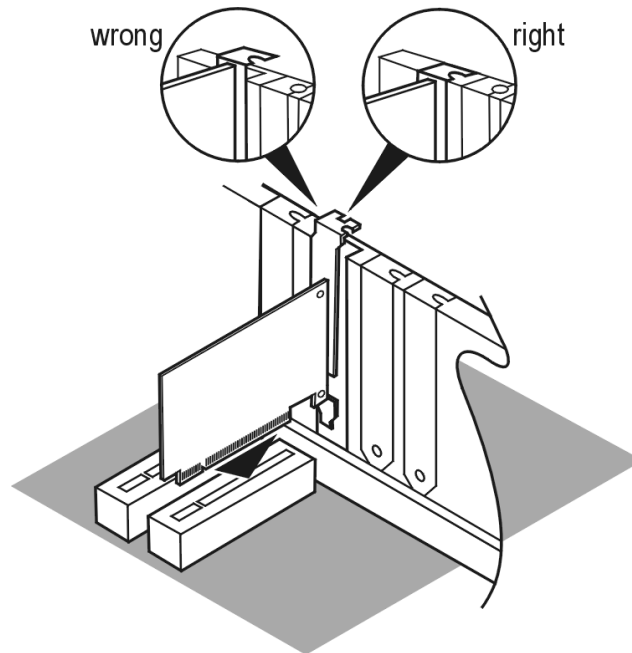

- B-9 Fasten the card into the computer chassis with the screw you set aside earlier.
- B-10 Replace the computer cover. Plug the power cord back into the electrical outlet and turn on your Macintosh, making sure the SBC Express CD is in the CD-ROM drive. Proceed to step B-14.

LAPTOP Systems- Installing the Kingston® Ethernet Adapter

B-11 Insert the Kingston® Card into your computer's PCMCIA Type II or Type III slot.

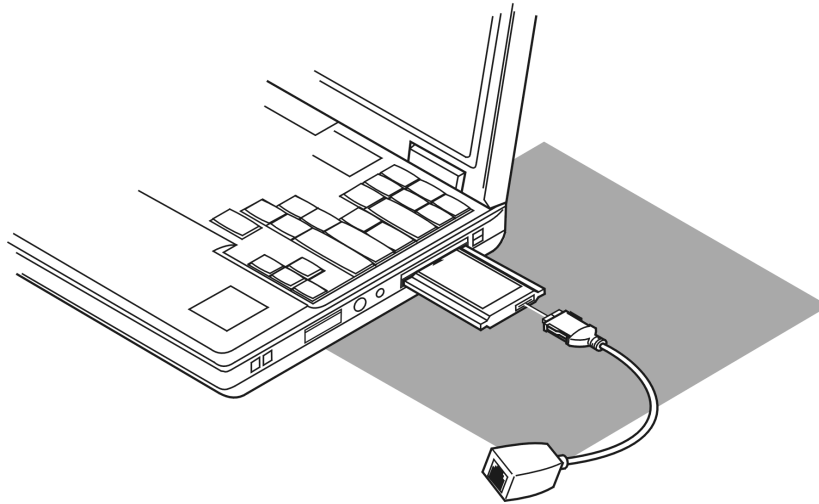

B-12 Carefully push the Media Access Module (MAM) into the socket on the Card until the locking tabs click into place.

B-13 Power up your laptop after making sure the SBC Express CD is still in the CD-ROM drive.

Installing the Kingston® Software

B-14 Insert the SBC Express Installation CD. Open the "Drivers" folder. Open the "Kne111tx" (desktop) or "Knepc2t" (laptop) folder.

B-15 Double click on the **Installer** icon.

B-16 From the Kingston® Welcome screen, click on **Continue** to proceed.



B-17 Click on the **Install** button in the bottom right corner of the Kingston® Installer window to proceed with the default Easy Install option. This option will install the Kingston® driver and diagnostics application.

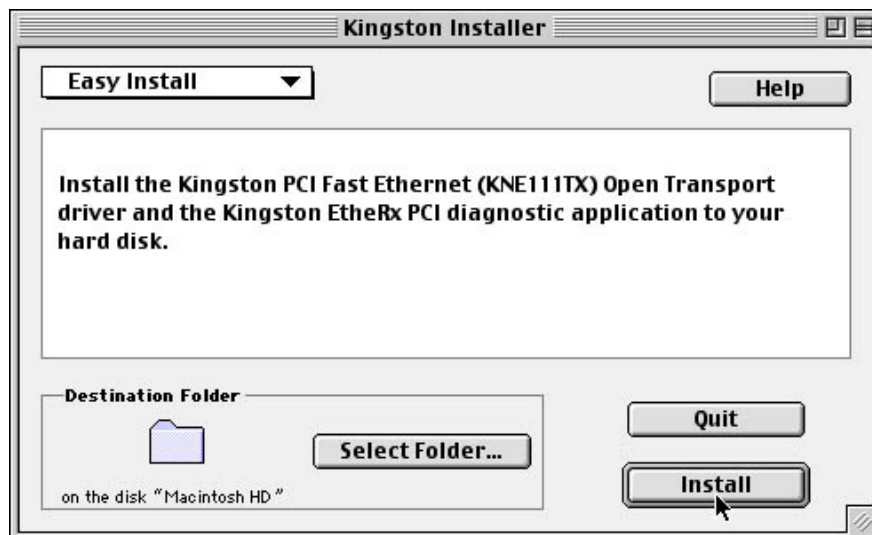

B-18 **Restart** the System when prompted to complete the installation.

B-19 Proceed to Step 6 (page 11).

Appendix C

I want to uninstall/reinstall the Kingston® Adapter. What do I do?

1. Insert the SBC Express Installation CD. Open the “Drivers” folder. Open the “Kne111tx” (desktop) or “Knepc2t” (laptop) folder.
2. Double click on the **Installer** icon.
3. From the Kingston® Welcome screen, click on **Continue** to proceed.

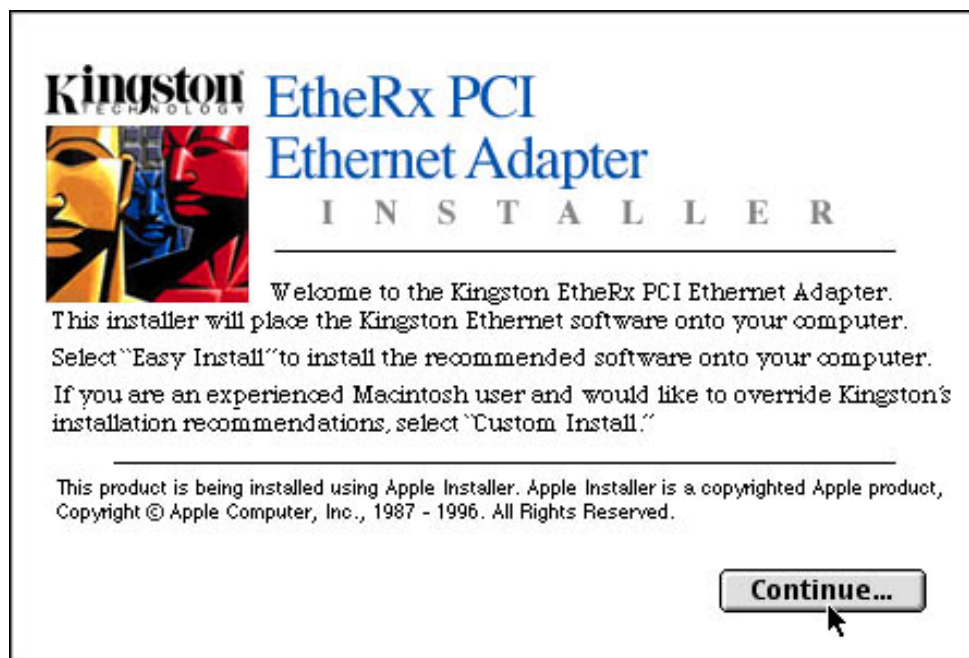

4. Select the **Custom Remove** option from the pulldown menu in the upper left corner.

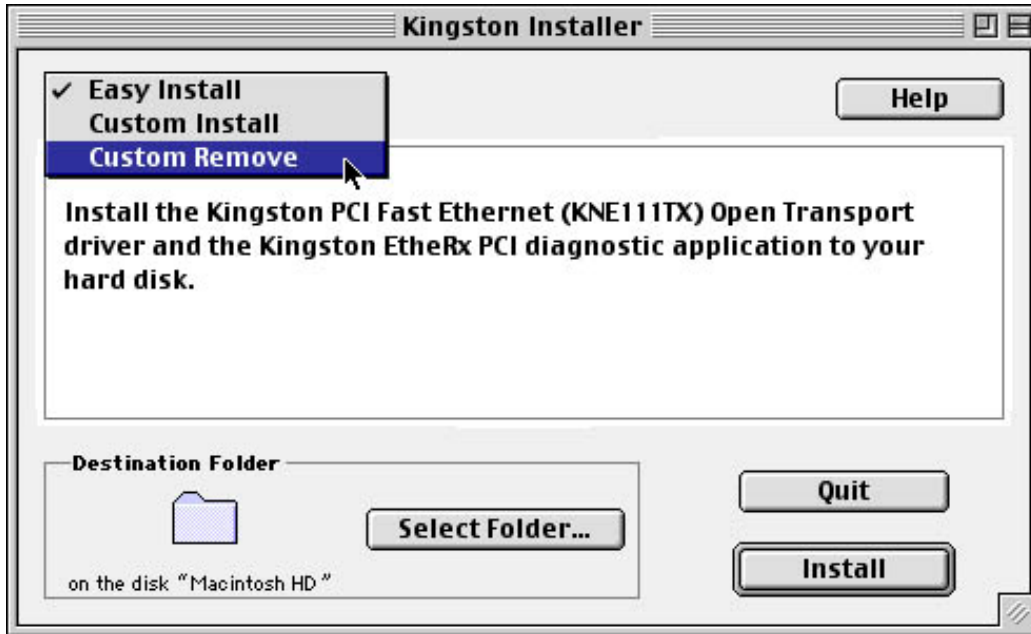

5. Place an **X** in the boxes to select the components to remove and click the **Remove** button in the lower right corner of the window.

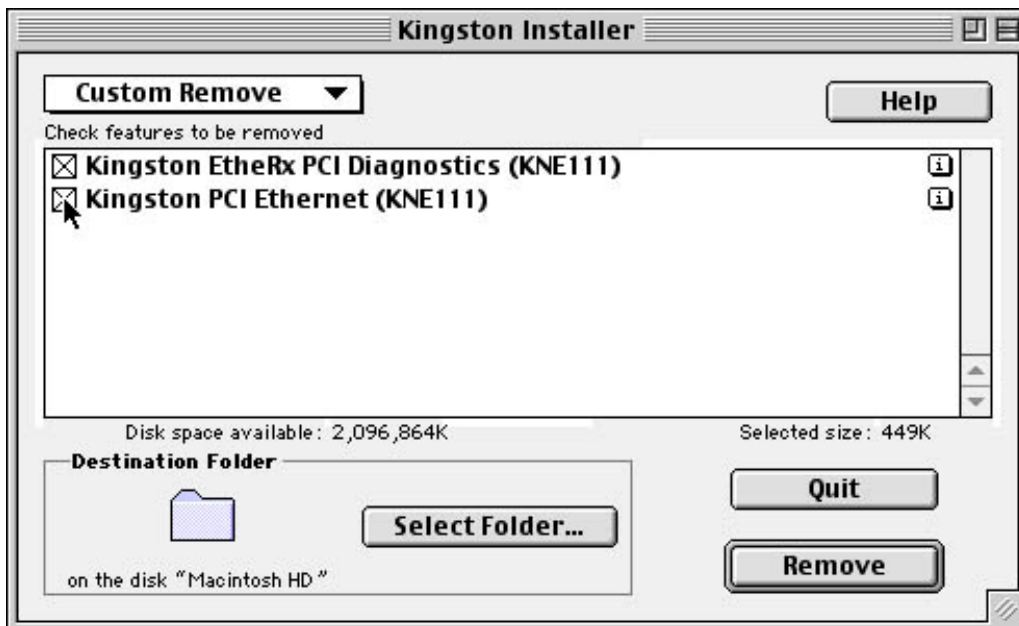

6. Click **Restart** to complete the Kingston® software removal.

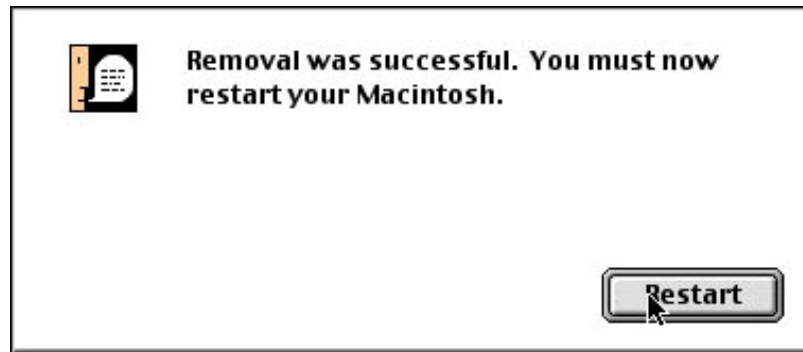

7. Once the computer has restarted, select Shut Down to power down the desktop or laptop.
8. After the computer shuts down, unplug the computer and any peripheral devices.
9. Remove the Kingston® Adapter Card

DESKTOP: For the Internal Kingston® Ethernet Adapter Card:

- Open the computer case using your computer manufacturer's instructions and then remove the screw holding card in place.
- Carefully remove the Kingston® Adapter card from the PCI slot.

LAPTOP For the PCMCIA Card

- Press the release button (consult your computer manufacturer's Owner's Manual if you don't know where this button is located).
 - Slide the Card completely out of the slot.
10. Reinstall the card following procedures in Step 4. Desktop users should try a different PCI slot, if possible.

APPENDIX D

Troubleshooting SBC Express

Please refer to this list if you are having problems using SBC Express or if you receive an error message. If after troubleshooting, you are still having problems, then you should contact your Internet Service Provider 'help desk' for further information.

Step	Problem	Solution
Minimum Resources	<p>SBC Express verifies minimum requirements on several resources including hard drive space, RAM, operating system level, and processor speed and family.</p> <p>If any of these resources are under the required value, an error will display describing which resource did not meet the requirement.</p>	Update your computer to the recommended resource level.
Installing Network Interface Card	When installing Network Interface Cards the installation process may ask for the original installation disk.	You may have to provide an installation CD-ROM for the installation of the drivers to be successful.
Incompatible Adapter	This scenario can occur when a machine had a previous NIC or Network Adapter installed, but the physical device is missing or was misconfigured.	Use the "Fix" button to launch the appropriate system control panel along with context sensitive help. The help provided will guide you through the steps to disable or remove the adapter.
Missing Internet Protocol	This scenario can occur if Client for Microsoft Networks is not installed with the TCP/IP protocol or if the NIC is installed without binding TCP/IP to the NIC.	Use the "Fix" button to launch the appropriate control panel and context sensitive help to guide you in binding TCP/IP to the network adapter.
Disabled Network Adapter	This scenario can occur when a NIC is present in the system, yet the adapter has been disabled.	Use the "Fix" button with context sensitive help to guide you through enabling the adapter.

Ping Test	The Ping Test is usually accomplished within the Configure TCP/IP step, where SBC Express pings the default gateway. An explicit IP address can also be used.	Failure during this test can occur from invalid network settings, the Ethernet cable not being plugged in, the DSL modem not being in synch, or if the specified IP address does not allow a ping. Make sure your Ethernet cable is plugged in and powercycle your DSL modem. Use the "Retry" button to try the test again.
DNS Test	The DNS Test will determine the currently defined DNS servers, attempt to ping them, and upon a successful ping, will resolve a specified hostname to an IP address.	This test can fail if the DNS server is invalid. If you entered static IP information, ensure you entered the DNS servers correctly.

This concludes the DSL Equipment Installation Guide