

A 300  
**Outlander**

A 300  
**Outlander**  
Instruction Manual



**Fabbrica d'Armi Pietro Beretta S.p.A.**  
Via Pietro Beretta, 18 - Casella Postale 160  
25063 Gardone Val Trompia (BS) Italia  
Tel. (030) 8341.11 - [www.beretta.com](http://www.beretta.com)



The illustrations and descriptions given in this brochure are intended as a general guide only, and must not be taken as binding. The Company, therefore, reserves the right to make, at any moment and without notice, any changes it thinks necessary to improve its models or to meet any requirements of manufacturing or commercial nature.

09/2011  
Cod. 62271

Printed in Italy  
Batan - Gardone V.T.

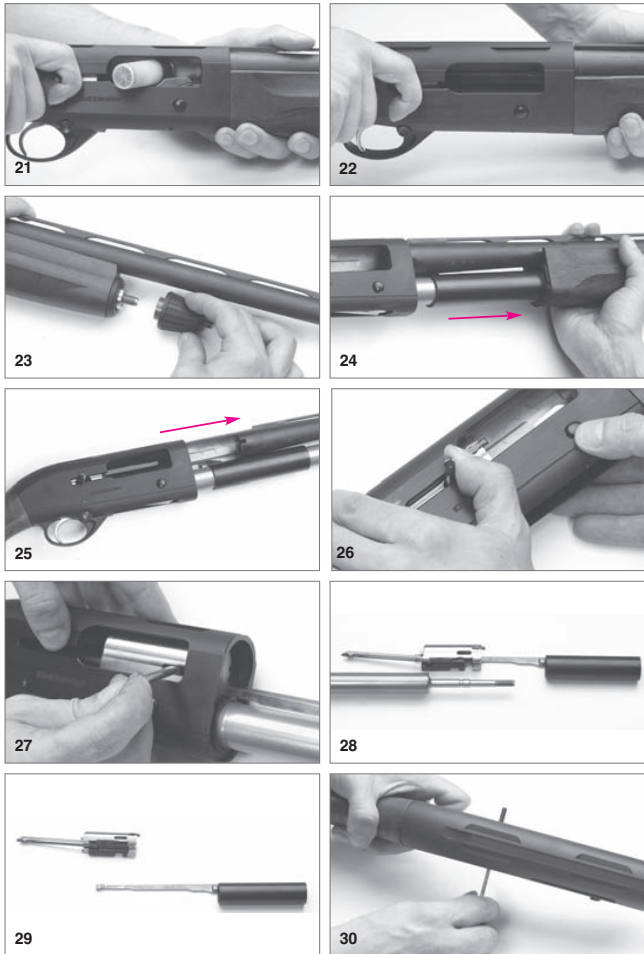

IV

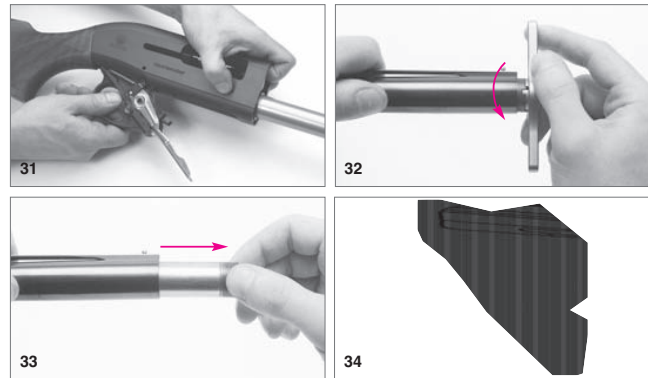

V

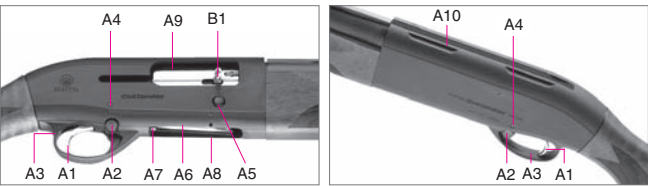
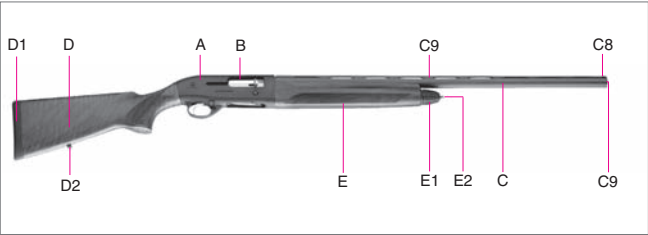

EN

English

\_\_\_\_\_

\_\_\_\_\_

\_\_\_\_\_

\_\_\_\_\_

\_\_\_\_\_

\_\_\_\_\_

\_\_\_\_\_

\_\_\_\_\_

\_\_\_\_\_

\_\_\_\_\_

\_\_\_\_\_

Dülander

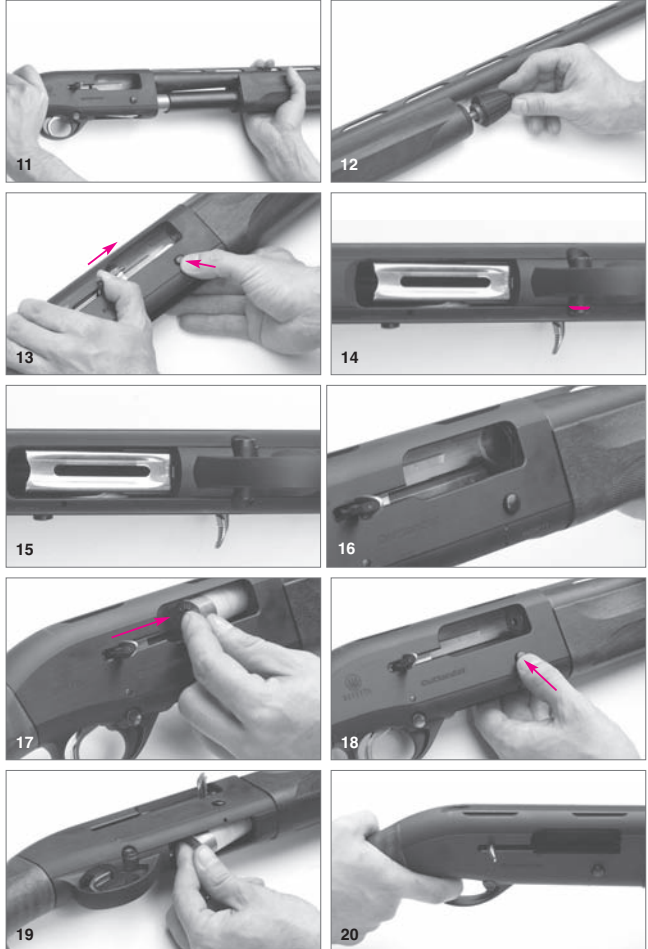





**EN**

**English**

ALWAYS KEEP THIS MANUAL WITH YOUR FIREARM. INCLUDE IT WITH THE FIREARM WHEN IT CHANGES OWNERSHIP.

**WARNING:** FIREARMS CAN BE DANGEROUS AND CAN POTENTIALLY CAUSE SERIOUS INJURY, DAMAGE TO PROPERTY OR DEATH, IF HANDLED IMPROPERLY. THE FOLLOWING SAFETY RULES ARE AN IMPORTANT REMINDER THAT FIREARM SAFETY IS YOUR RESPONSIBILITY.

**WARNING:** Always ensure that the safety is fully engaged until ready to fire.

**NOTICE:** The Manufacturer and/or its Local Official Distributors assume no liability for product malfunction or for physical injury or property damage resulting in whole or in part from criminal or negligent use of the product, improper or careless handling, unauthorised modifications, use of defective, improper, hand-loaded, reloaded or remanufactured ammunition, customer misuse or neglect of the product, or other factors beyond manufacturer's direct and immediate control.

In addition to the Basic Safety Rules, there are other Safety Rules pertaining to the loading, unloading, disassembly, assembly and use of this firearm, located throughout this manual.

**WARNING:** READ THE ENTIRE MANUAL CAREFULLY BEFORE USING THIS FIREARM. MAKE SURE THAT ANY PERSON USING OR HAVING ACCESS TO THIS FIREARM READS AND UNDERSTANDS THIS ENTIRE MANUAL PRIOR TO USE OR ACCESS.

**NOTICE:** As the interchangeable barrel of this shotgun has a serial number different from that stamped on the receiver, it may be necessary, when referring to the gun, to specify also the serial number of the barrel/s.

WE RECOMMEND THE USE OF ORIGINAL BERETTA SPARE PARTS AND ACCESSORIES. THE USE OF OTHER MANUFACTURER'S SPARE PARTS AND ACCESSORIES COULD CAUSE MALFUNCTIONS AND/OR BREAKAGES THAT WILL NOT BE COVERED BY THE BERETTA WARRANTY.

**WARNING:** Do not attempt to load more cartridges into your Beretta shotgun than local legislation permits. Beretta will not be held responsible for any product malfunction, property damage, physical injury or legal repercussions which have been caused through not abiding by the loading instructions as stated in the Beretta product manual. Alterations or adjustments (not contemplated by the manufacturer) to any part of the shotgun which change the ammunition capacity voids the manufacturer's warranty.



# BASIC SAFETY RULES

**CAUTION:** READ THIS MANUAL CAREFULLY BEFORE USING THE SHOTGUN.

**CAUTION:** FIREARMS CAN BE DANGEROUS AND CAN POTENTIALLY CAUSE SERIOUS INJURY, DAMAGE TO PROPERTY OR DEATH, IF HANDLED IMPROPERLY. THE FOLLOWING SAFETY RULES ARE AN IMPORTANT REMINDER THAT FIREARM SAFETY IS YOUR RESPONSIBILITY.

## 1. NEVER POINT A FIREARM AT SOMETHING THAT IS NOT SAFE TO SHOOT.

Never let the muzzle of a firearm point at any part of your body or at another person. This is especially important when loading or unloading the firearm. When you are shooting at a target, know what is behind it. Some bullets can travel over a mile. If you miss your target or if the bullet penetrates the target, it is your responsibility to ensure that the shot does not cause unintended injury or damage.



## 2. ALWAYS TREAT A FIREARM AS IF IT WERE LOADED.

Never assume that a firearm is unloaded. **The only certain way to ensure there are no cartridges in a firearm is to open the chamber and visually and physically examine the inside to see if a round is present. Removing or unloading the magazine will not guarantee that a firearm is unloaded or cannot fire.** Shotguns and rifles can be checked by cycling or removing all rounds and by then opening and inspecting the chamber so that a visual inspection of the chamber for any remaining rounds can be made.

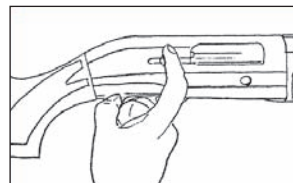
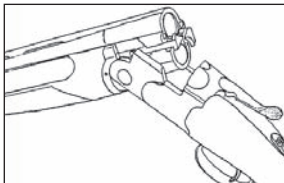

**3. STORE YOUR FIREARM SO THAT CHILDREN CANNOT GAIN ACCESS TO IT.**

It is your responsibility to ensure that children under the age of 18 or other unauthorised persons do not gain access to your firearm. **To reduce the risk of accidents involving children, unload your firearm, lock it and store the ammunition in a separate locked location.** Please note that devices intended to prevent accidents - for example, cable locks, chamber plugs, etc., - may not prevent use or misuse of your firearm by a determined person. Firearm storage in a steel gun safe may be more appropriate to reduce the likelihood of intentional misuse of a firearm by a child or unauthorised person.

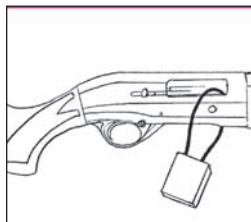

**4. NEVER SHOOT AT WATER OR AT A HARD SURFACE.**

Shooting at the surface of water or at a rock or other hard surface increases the chance of ricochets or fragmentation of the bullet or shot, which can result in the projectile striking an unintended or peripheral target.

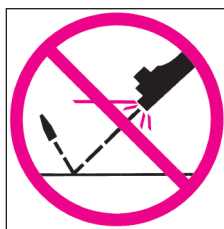

**5. KNOW THE SAFETY FEATURES OF THE FIREARM YOU ARE USING, BUT REMEMBER: SAFETY DEVICES ARE NOT A SUBSTITUTE FOR SAFE HANDLING PROCEDURES.**

Never rely solely on a safety device to prevent an accident. It is imperative that you know and use the safety features of the particular firearm you are handling, but accidents can best be prevented by following the safe handling procedures described in these safety rules and elsewhere in the product manual. To further familiarise yourself with the proper use of this or other firearms, take a Firearms Safety Course taught by an expert in firearms use and safety procedures.

**6. PROPERLY MAINTAIN YOUR FIREARM.**

Store and carry your firearm so that dirt or lint does not accumulate in the working parts. Clean and oil your firearm, following the instructions provided in this manual, after each use to prevent corrosion, damage to the barrel or accumulation of impurities which can prevent use of the firearm in an emergency. Always check the bore and chamber(s) prior to loading to ensure that they are clean and free from obstructions. **Firing with an obstruction**

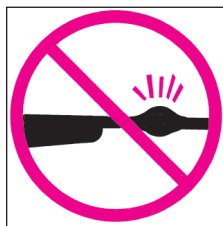

EN



**in the barrel or chamber can rupture the barrel and injure you or others nearby.** In the event you hear an unusual noise when shooting, stop firing immediately, engage the manual safety and unload the firearm. Make sure the chamber and barrel are free from any obstruction, like a bullet blocked inside the barrel due to defective or improper ammunition.

## 7. USE PROPER AMMUNITION.

Only use factory-loaded, new ammunition manufactured to industry specifications: CIP (Europe and elsewhere), SAAMI® (U.S.A.). Be certain that each round you use is in the proper calibre or gauge and type for the particular firearm. The calibre or gauge of the firearm is clearly marked on the barrels of shotguns and on the slide or barrel of pistols. The use of reloaded or remanufactured ammunition can increase the likelihood of excessive cartridge pressures, case-head ruptures or other defects in the ammunition that can cause damage to your firearm and injury to yourself or others nearby.

## 8. ALWAYS WEAR PROTECTIVE GLASSES AND EARPLUGS WHEN SHOOTING.

The chance that gas, gunpowder or metal fragments will blow back and injure a shooter who is firing a gun is rare, but the injury that can be sustained in such circumstances can be severe, including the possible loss of eyesight. A shooter must always wear impact resistant shooting glasses when firing any firearm. Noise-reducing earplugs or headphones will reduce the risk of damage to hearing caused by prolonged shooting activity.



## 9. NEVER CLIMB A TREE, FENCE OR OBSTRUCTION WITH A LOADED FIREARM.

Open and empty the chamber(s) of your firearm and engage the manual safety before climbing or descending a tree or before climbing a fence or jumping over a ditch or other obstruction. Never pull or push a loaded firearm toward yourself or another person. Always unload a firearm, visually and physically check to see that the magazine, loading mechanism and chamber are unloaded, and action is open before handing it to another person.



Never take a firearm from another person unless it is unloaded, visually and physically checked to confirm it is unloaded, and the action is open.



**10. AVOID ALCOHOLIC BEVERAGES OR JUDGEMENT/REFLEX IMPAIRING MEDICATION WHEN SHOOTING.**

Do not drink and shoot. If you take medication that can impair motor reactions or judgement, do not handle a firearm while you are under the influence of the medication.



**11. NEVER TRANSPORT A LOADED FIREARM.**

Unload a firearm before putting it in a vehicle (chamber empty, magazine empty). Hunters and target shooters should load their firearm only at their destination, and only when they are ready to shoot. If you carry a firearm for self-protection, leaving the chamber unloaded can reduce the chance of an unintentional discharge.

**12. LEAD WARNING.**

Discharging firearms in poorly ventilated areas, cleaning firearms, or handling ammunition may result in exposure to lead and other substances known to cause birth defects, reproductive harm, and other serious physical injury. Have adequate ventilation at all times. Wash hands thoroughly after exposure.

**CAUTION:** It is YOUR responsibility to know and abide by Federal, State and Local laws governing the sale, transportation and use of firearms in your area.

**WARNING:** This firearm has the capability of taking your life or the life of someone else! Always be extremely careful with your firearm. An accident is almost always the result of not following basic firearm safety rules.

**Especially for U.S. consumers:**

For information about Firearm Safety Courses in your area, please visit the National Rifle Association's web site at [www.nra.org](http://www.nra.org).



# NOMENCLATURE

- A** Receiver
- A1** Trigger
- A2** Safety button
- A3** Trigger guard
- A4** Trigger guard retaining pin
- A5** Breech bolt release button
- A6** Carrier
- A7** Carrier stop push button
- A8** Loading gate
- A9** Ejection port/cartridge chamber
- A10** Grooves for base
- B** Breech bolt assembly
- B1** Cocking handle
- B2** Extractor
- B3** Breech bolt carrier
- B4** Connecting rod
- B5** Operating rod with sleeve
- C** Barrel
- C1** Barrel tang
- C2** Gas cylinder
- C3** Piston
- C4** Exhaust valve assembly
- C5** Mobilchoke® tube
- C6** Choke tube spanner
- C7** Front sight
- C8** Muzzle
- C9** Top rib
- D** Stock
- D1** Recoil pad
- D2** Sling swivel
- E** Fore-end
- E1** Fore-end cap
- E2** Sling swivel
- F** Magazine tube
- F1** Magazine tube cap with shaft

# CONTENTS

BASIC SAFETY RULES	4
NOMENCLATURE	8
DESCRIPTION	10
DATA AND TECHNICAL CHARACTERISTICS	15
OBSTRUCTION / CHOKE TUBES CONDITION CHECK	16
ASSEMBLY OF PACKAGED FIREARM	16
LOAD CHECK	17
AMMUNITION	18
HOW TO LOAD AND FIRE	19
HOW TO UNLOAD THE SHOTGUN	21
DISASSEMBLY	22
BERETTA MOBILCHOKE® TUBES	23
ROUTINE MAINTENANCE	26
SPECIAL MAINTENANCE	28
REASSEMBLY	28
STOCK DROP AND CAST MODIFICATION	30
STORAGE	32



## DESCRIPTION

The key to superior performance in semiautomatic shotguns is **simplicity**.

In keeping with the Beretta tradition, the new A300 Outlander is a soft-shooting gas-operated system semi-auto which combines the reliable Beretta bolt with falling block (locked breech) with an improved gas valve with a self-cleaning cylinder and piston, so that excess pressure caused by the most powerful cartridges can be decreased automatically.

### TOTAL DESIGN

The rugged A300 outlander it is elegant, yet efficient. Sleek yet strong. With slim, graceful lines that leave an indelible impression at first sight.

**The receiver.** Completely and precisely machined from a solid block of special light alloy aluminium, it has moveable parts in steel, and high quality light alloys, assembled with particular care, checked and polished to ensure exceptional operation. All metal parts are protected by special finishes against wear, and tear and rusting. The ergonomically rounded back of the light alloy receiver fits smoothly into the stock, enabling rapid and instinctive target acquisition. The top of the receiver is designed to accept (with an optional base) optics and other aiming system. Constructed using a special aluminium alloy, the A300 Outlander receiver has undergone an anodic oxidation process that protects the firearm from rusting and scratching.

**The trigger guard** is made of heavy duty polymer. Its new semi-square shape makes finger positioning easier. The rounded shape and absence of sharp corners have been designed for more rapid, more secure trigger grip. The use of a technopolymer ensures that the colour will remain in the parts traditionally subject to rubbing while at the same time enhancing sensitivity of touch in cold climates. The opening of the trigger guard is bigger so the trigger is accessible even to a gloved hand.

**The carrier and bolt** withstand rust and wear and offer more sturdiness in the execution of their vital function.

**The safety button**, also newly designed, now offers a wider surface for easier operation. For accidental engaging or disengaging, the safety is protected and topped by a protruding edge that also enhances its appearance.

The safety button can be reversed for left-handed shooters.

**The trigger** is chrome-plated for ultimate rust protection. Its silver colour sets it apart from the other parts of the shotgun.

**The fore-end** has long, slender contours that add to the harmony of the A300

Outlander overall design. The cap has a new polymer structure that makes it very lightweight, weather and rust-resistant.

In front of the fore-end cap is applied a practical swivel stud.

The **stock** provides superior comfort and a secure grip to ensure the highest performance during firing. Made of fine walnut carefully selected for its design and resistant finish, its grip contour is designed to optimally accommodate the hand of the user with a top ambidextrous finger rest.

## REDUCED NUMBER OF COMPONENTS

The Beretta semi-automatic A300 Outlander is characterised by a particularly small number of assemblies. The shotgun is composed of five main assembly groups which can be field stripped by the user, for quick and easy disassembly. A firearm that can be easily taken apart is also easier to clean. Easy cleaning encourages to perform more careful maintenance on the firearm ensuring long-term reliability.

## GAS-OPERATED SYSTEM WITH EXHAUST VALVE

The exclusive gas-operated system, patented by Beretta, with a self-cleaning cylinder and piston, has a self-cleaning exhaust valve, so that excess pressure caused by the most powerful cartridges can be decreased automatically: as a result, the shotgun without any adjustment or intervention can shoot cartridges from 70 mm (2 3/4 in) /24 g (7/8 oz), to 76 mm (3 in) /57 g (2 oz).

The semi-automatic gas-operated A300 Outlander has also been optimised to ensure lower gas dispersal. As a result, the system has a self-cleaning feature that further minimises maintenance and significantly reduces the stress to which the operating parts are subjected to at higher charges, thereby ensuring the greatest possible service life of the firearm.

The new piston has been designed to constantly clean out gunpowder residue in the cylinder, increasing the efficiency of the firearm and reducing the need for maintenance. The elastic piston seal has a rough finish to optimise cleaning.

**SHOTGUN ASSEMBLY WARNING:** In order to prevent damage to the elastic piston seal, first insert the piston into the chamber cylinder and then insert the magazine tube cap shaft through the piston hole.

The valve unit is connected to the barrel, making assembly and disassembly of the barrel itself easier.



## MOBILCHOKE® BARREL/MOBILCHOKE® TUBES

In alloy steel, made with the exclusive cold hammering process to ensure perfect concentricity, the barrel of the new Beretta semi-automatic A300 Outlander is exceptionally robust and lightweight at the same time. Designed for use with steel shot cartridges, it has a Mobilchoke® internal profile. The bore is chrome plated to ensure the longest life and resistance to rust, wear and tear and to increase the shot velocity, while it is deep blued on the exterior.

The Beretta Mobilchoke® internal choke tubes are designed to reduce shot deformation and to enhance shot pattern distribution and concentration. Made in high performance nickel plated steel, the Beretta Mobilchoke® choke tubes ensure the highest protection against rust and resistance to use of steel shot.

## DROP AND CAST SPACERS

Between the stock and the receiver is a technopolymer spacer and inside the stock is a stainless steel plate that can be used to change the drop and cast of the stock by simply modifying the assembly configuration. A set of additional spacers is also provided to further change the drop by replacing the spacer pair.

## MAGAZINE CAPACITY

The magazine has a two-shot capacity\*, in line with current hunting regulations in many countries, made possible by the insertion of a reducer. This reducer restricts firearm use to no more than three shots (two in the magazine, and one in the cartridge chamber). This device is fitted by Beretta during manufacture and assembly of the A300 Outlander. In certain specific areas, hunting is only authorised with firearms of not more than two rounds. To use the A300 Outlander in these regions, the magazine capacity must be limited to a single shot with a reducer plug (operation to be performed by a competent gunsmith).

\* see "Ammunition".

**WARNING:** There are many special Beretta parts and accessories to personalize your firearm. To request this extensive line of parts and accessories, please contact your local Beretta dealer.

# DATA AND TECHNICAL CHARACTERISTICS

Gauge	12
Cartridge chamber	70mm (23/4", 3") and 76mm (23/4", 3")
Operation	Semi-automatic, gas operation with exhaust valve
Locking system	Elevated locking block
Receiver	Light alloy
Barrel	Alloy steel, fully chromed bore
Front sight	Metal bead
Safety	Button-operated, on trigger guard. Reversible for left-handed shooters.
Magazine	Limited to two shots
Stock	Walnut or synthetic, with ambidextrous finger rest. Rubber recoil pad.

**EN**



## OBSTRUCTION / CHOKE TUBES CONDITION CHECK

Check the barrel to ensure there are no obstructions in the chamber and bore. This is extremely important because serious injury can result to the user or to nearby persons if a cartridge is fired in an obstructed barrel or chamber.

Check the inside of the barrel prior to completely assembling the firearm and before use; if the firearm is already assembled the following procedure should be followed:

- Follow the instructions in the “Disassembly” section and remove the barrel from the shotgun.
- After removing the barrel, look right through the barrel from the rear and make sure there are no obstructions, even minor ones.
- If an obstruction in the barrel is detected, a competent gunsmith must remove the obstruction. Inspect again the shotgun before it can be fired.
- Remount the barrel, following the instructions set out in the “Reassembly” section.

### CHECKING THE CONDITION OF THE CHOKE TUBES

- Always check the appearance and cleaning of the choke tubes before using the shotgun.
- Check correct tightness in the barrel with the spanner provided.
- Never use choke tubes that show signs of defects, warping or incrustation.
- Make sure that the choke tube inserted is appropriate for the intended use and shot type to be used (steel or lead). See “Ammunition” chapter.

## ASSEMBLY OF PACKAGED FIREARM

**CAUTION:** THIS FIREARM HAS THE CAPABILITY OF TAKING YOUR LIFE OR THE LIFE OF SOMEONE ELSE! ALWAYS BE VERY CAREFUL WHEN HANDLING YOUR FIREARM. AN ACCIDENT IS NEARLY ALWAYS THE RESULT OF FAILURE TO COMPLY WITH SAFETY rules, OR INCORRECT USE.

**WARNING:** Beretta assumes no liability for any injury or damage to property resulting from improper or careless handling, or intentional or accidental firing of the shotgun.

**WARNING:** All assembly, disassembly and maintenance procedures should be carried out with the firearm unloaded (cartridge chamber, receiver and magazine empty). Inspect the firearm by looking through the ejection port, the loading gate and the chamber.



**WARNING:** During assembly, disassembly and maintenance procedures, never point a firearm at someone or at hard or flat surfaces. Always treat the firearm as if it were loaded (See points 1, 2 and 4 of the BASIC SAFETY RULES).

The Beretta semi-automatic A300 Outlander comes with barrel and stock-receiver-fore-end assembly packaged separately.

Mount the barrel onto the stock-receiver-fore-end assembly as described below.

**NOTICE:** It is advisable to carry out the assembly operations over a table to catch components should they drop.

**CAUTION:** In the unlikely event that the breech bolt assembly is in the unlocked (OPEN) position, do not press the release button and keep your finger away from the ejection port.

When the release button is pressed, the breech bolt is pushed forward by the recoil spring, until it is stopped at the ejection port by the cocking handle, with the likelihood of damage to both parts.

- Check the barrel. The barrel and cartridge chamber must be clean and free from obstructions (see “Checking for obstructions”).
- Check that the choke tube is inserted in the barrel and tightened correctly, clean and in good condition (see “Checking the condition of the choke tubes”).
- Unscrew the front cap of the fore-end in an anticlockwise direction and completely remove it (**Fig. 1**).
- Pull the fore-end right out (**Fig. 2**).
- Check that the piston is positioned inside the gas cylinder of the barrel (**Fig. 3**). If the piston is mounted on the magazine tube shaft, remove it (**Fig. 4**) and insert it into the cylinder of the barrel, making sure to tighten the elastic seal with the fingers to facilitate insertion of the piston into the cylinder (**Fig. 5**).

**CAUTION:** In order to prevent damage to the elastic piston seal, first insert the piston into the chamber cylinder and then insert the magazine tube shaft through the piston hole.

- Check that the carrier stop push button is pressed all the way down. Otherwise, push it down (**Fig. 6**).
- Use the cocking handle to retract the breech bolt until it snaps into the unlocked position (**Fig. 7**).

**CAUTION:** When the release button is pressed, the breech bolt is pushed forward by the recoil spring, until it is stopped at the ejection port by the cocking handle, with the likelihood of damage to both parts.

- Insert the barrel into the receiver, ensuring that the magazine tube shaft enters the piston hole as well as the gas cylinder hole with the valve assembly (**Fig. 8, 9, 10**).



- Push it all the way into the receiver until it stops.
- Slide the fore-end into place over the gas cylinder / the valve assembly and magazine tube (**Fig. 11**). checking for the correct centering on the receiver face. The fore-end is in the correct position when it is fully against the receiver.
- Tighten the front cap of the fore-end all the way (**Fig. 12**).
- Keep your fingers away from the ejection port, press the breech bolt release button and gently guide the breech bolt to lock (**Fig. 13**).
- Keeping the breech bolt retracted 2 cm, pull the trigger to decock the hammer.

**WARNING:** The safety can only be engaged with the hammer cocked. The hammer is cocked by pulling back the breech bolt. When the safety button shows the red ring, the SAFETY IS DISENGAGED (**Fig. 14**), so the firearm is ready for use. When the red ring is not visible on the safety button, the SAFETY IS ENGAGED (**Fig. 15**).

**WARNING:** Store your firearm so that children or other persons not familiar with firearms cannot gain access to it. To reduce the risk of accidents involving children, unload your firearm and lock it away. Store the ammunition in a separate locked location. (See point 3 of the BASIC SAFETY RULES.)

## LOAD CHECK

At various points in this manual, you will be requested to inspect the ejection port, the loading gate, and the cartridge chamber of your Beretta semi-automatic A300 Outlander to ensure that it is unloaded. This should become second nature to you, as should the following precautions:

- Never assume that the gun is unloaded.
- Never point or push the gun toward yourself or another person.
- Always inspect the ejection port, the loading gate and the cartridge chamber to make sure they are empty. The cartridge chamber is the portion of the barrel into which the cartridge is inserted (**Fig. 16**).
- Pull back the breech bolt to lock it into the open position and engage the safety before handing the shotgun to another person.
- Never take from or give the shotgun to another person unless the breech bolt has been opened and the ejection port, loading gate and cartridge chamber have been inspected to ensure they are completely empty.

Inspect the ejection port, the loading gate and cartridge chamber as indicated below:

**CAUTION:** Keep your finger off the trigger and keep the barrel pointed in a safe direction.

- Check that the carrier stop push button is pressed all the way down. Otherwise, push it down (**Fig. 6**).
- Use the cocking handle to retract the breech bolt until it snaps into the open position (**Fig. 7**).
- Engage the manual safety by pressing the safety button to hide the red ring (**Fig. 15**).
- Inspect the firearm by looking through the ejection port, the feeding gate and the cartridge chamber. They must be empty. Check that there are no cartridges in the magazine tube. If there are, unload the firearm as indicated in “How to unload the firearm”.
- Press the breech bolt release button and gently guide it to the locked position (**Fig. 13**).
- Disengage the safety (**Fig. 14**) (red ring visible) and hold the breech bolt back 2 cm, pull the trigger, to decock the hammer.

**CAUTION:** When the safety button shows the red ring, the SAFETY IS DISENGAGED (**Fig. 14**), so the firearm is ready for use. When the red ring is not visible on the safety button, the SAFETY IS ENGAGED (**Fig. 15**).



## AMMUNITION

**WARNING:** Beretta assumes no liability for physical injury or property damage resulting from the use of defective, improper, hand-loaded, reloaded or remanufactured ammunition. Serious damage or injury, even death, may be caused from the use of ammunition that is not suitable, loaded with force, or loaded with obstructions in the barrel.

**The Beretta A300 Outlander semi-automatic shotgun has different cartridge chambers, depending on the version. The shotgun does not require adjustments or interventions to shoot from 70 mm (2 3/4 in) /24 g (7/8 oz), to 76 mm (3 in) /57 g (2 oz) cartridges.**

**CAUTION:** The Beretta semi-automatic A300 Outlander has a Mobilchoke® barrel and Mobilchoke® choke tubes that make it possible to fire steel shot ammunition. Follow the instructions for use of choke tubes appropriate for the use of steel shot, as set out in the “Steel shot” section.

You will find the markings for the gauge and chamber length for your shotgun on the side of the barrel. Every A300 Outlander has been tested with special proof test ammunition at 1320 bar with steel shot. These tests guarantee the ability to shoot either ordinary or steel shot ammunition.

**CAUTION:** Do not use High Performance (HP) cartridges. HP Cartridges usually contain pellets higher than 3.5 mm of diameter which cause higher pressure in the barrel.

**CAUTION:** Never use cartridges that do not correspond to the indications on the barrel.

**CAUTION:** Only use cartridges with a length equal to or less than the chamber length indicated on the barrel.

**CAUTION:** To avoid using improper ammunition, always check the characteristics stamped on the cartridge box and on the cartridge. Be sure to use the right cartridge gauge and length for your firearm.

## STEEL SHOT

All Beretta barrels, as well as the “SP” (Steel Proof) Beretta choke tubes, are designed for use with factory steel shot cartridges loaded to international standard specifications. When steel shot cartridges are fired, the best results are obtained by using open chokes (C0000/CL, 0000/IC, 000/M). Full choke constrictions (0/F, 00/M) when using steel shot, do not increase pattern density and will distort normal pattern density, accelerating wear and tear. The use of reloaded or remanufactured ammunition can increase the likelihood of excessive pressure, case rupture or other defects in the ammunition.

## MAGAZINE CAPACITY

The magazine of the A300 Outlander has a capacity limited to 2 shots, in line with the current hunting regulations in many countries, due to the insertion of a reducer.

This reducer restricts firearm use to no more than three shots (two in the magazine, and one in the cartridge chamber).

**WARNING:** Wholesalers, dealers or gunsmiths are not authorised to carry out any Warranty repair or adjustment on behalf of the Manufacturer (unless they are a Repair Point authorised by the Manufacturer and/or by its Local Official Distributors).

## HOW TO LOAD AND FIRE

**WARNING:** Before loading the firearm, it is a good idea to practice the following handling procedures without the use of ammunition. Never handle a loaded firearm until you are fully familiar with the loading procedures. Always inspect the ejection port, the loading gate and the cartridge chamber to make sure they are empty. Check that there are no cartridges in the magazine tube. Before loading the firearm, ensure that the safety is engaged. Always keep the firearm pointed in a safe direction. (See points 1, 2 and 4 of the BASIC SAFETY RULES.)

**WARNING:** Always check the barrel before loading the firearm to make sure that it is clean and free of possible obstructions (see: "Checking for obstructions").

**WARNING:** Check the conditions and correct tightness of the choke tube in the barrel. Never use the shotgun without the choke tube inserted (see: "Checking the condition of the choke tubes").

**WARNING:** The shooter and all bystanders must always wear protective eye-wear and ear protection during shooting. Residue from gunpowder, lubricant or metal fragments may be projected backwards and cause injury. Noise-reducing earplugs or earmuffs will reduce the risk of damage to hearing caused by prolonged shooting activity.

**CAUTION:** Always keep your finger off the trigger and avoid contact of other objects with the trigger if you don't intend to fire.

- Check that the carrier stop push button is pressed all the way down. Otherwise, push it down (**Fig. 6**).
- Use the cocking handle to retract the breech bolt until it snaps into the open position (**Fig. 7**).
- Engage the manual safety by pressing the safety button to hide the red ring (**Fig. 15**).



**CAUTION:** The safety can only be engaged with the hammer in the cocked position. The hammer is cocked by pulling back the breech bolt. When the safety button shows the red ring, the SAFETY IS DISENGAGED (**Fig. 14**), so the firearm is ready for use. When the red ring is not visible on the safety button, the SAFETY IS ENGAGED (**Fig. 15**).

**WARNING:** The manual safety is merely a mechanical device and is in no way a substitute for the Basic Safety Rules of firearm handling.

- Introduce the first cartridge into the cartridge chamber through the ejection port (**Fig. 17**).
- Keeping your hands away from the ejection port, press the release button and guide the breech bolt to lock (**Fig. 18**).

**WARNING:** The firearm is now loaded and ready to fire after the manual safety is disengaged. Always keep your finger off the trigger and avoid contact with the trigger by other objects if you don't intend to fire. Never point a firearm at something that is not safe to shoot. (See points 1, 2 and 4 of the BASIC SAFETY RULES).

**WARNING:** Beretta assumes no liability for any injury or property damage resulting from improper or careless handling or intentional or accidental firing of the shotgun.

- Move the carrier to insert the cartridges into the magazine through the loading gate to hook onto the cartridge retaining tooth (**Fig. 19**).
- To fire, disengage the safety (**Fig. 14**) (red ring visible) and pull the trigger.
- After firing the first shot, release the trigger to set up the shotgun for the next round.
- The shotgun will fire the cartridge in the chamber first, and then it will automatically introduce the cartridge from the magazine tube into the chamber

**WARNING:** After pulling the trigger, if the shotgun doesn't fire, engage the safety, wait at least one minute and unload the shotgun as described in the corresponding section.

Never attempt to reuse or fire ammunition that did not fire the first time. Dispose of unfired or damaged ammunition properly, in accordance with the ammunition manufacturer's recommendations.

**WARNING:** If another cartridge is fired into an obstructed barrel, damage and very serious injury may occur.

If you do not plan to fire a second shot, engage the safety (red ring not visible) keeping the firearm pointed in a safe direction and the fingers away from the trigger. If you have finished firing, unload the shotgun as indicated in: "How to unload the shotgun".

- When the last cartridge has been fired, the breech bolt remains open, showing that the magazine is empty (**Fig. 20**).
- Engage the safety (**Fig. 15**) (red ring not visible) and if necessary, reload the shotgun according to the instructions given previously.

**WARNING:** Always unload the firearm immediately after firing is completed. Never store a loaded firearm. To store the shotgun, see: "Storage".

## HOW TO UNLOAD THE SHOTGUN

**WARNING:** The firearm is loaded and ready to fire. Always keep your finger off the trigger and avoid contact with the trigger by other objects if you don't intend to fire. Never point the firearm at someone or at hard, flat surfaces. (See points 1, 2 and 4 of the BASIC SAFETY RULES.)

- Keeping the firearm pointed in a safe direction, check that the safety is engaged (**Fig. 15**) (red ring not visible).
- Pull back the breech bolt to extract and expel the live cartridge from the chamber (**Fig. 21**).
- Keeping the fingers away from the ejection port, gently take the breech bolt so that it locks.
- Raise the carrier, push the cartridge lightly into the magazine tube and at the same time press down the release button, guiding the cartridges out of the magazine tube.
- After checking the magazine tube and the receiver are empty, keeping the shotgun pointed in a safe direction, disengage the safety (**Fig. 14**) (red ring visible).
- Keeping the breech bolt pulled back 2 cm, pull the trigger, thereby decocking the hammer



## DISASSEMBLY

**WARNING:** Always check that the shotgun is unloaded (empty cartridge chamber, empty receiver, empty magazine). Inspect the firearm by looking through the ejection port, the loading gate and the chamber. If it is not empty, unload it as instructed in the relevant section. Check that the hammer is decocked.

**WARNING:** Never point the firearm at someone or at hard, flat surfaces. Always treat the shotgun as if it were loaded. (See points 1, 2 and 4 of the BASIC SAFETY RULES.)

**NOTICE:** It is advisable to carry out the disassembly operations over a table to catch components should they drop.

### BARREL

- Check that the carrier stop push button is pressed all the way down. If it is not, push it all the way down (**Fig. 6**).
- Pull the breech bolt all the way back so that it remains open (**Fig. 22**).
- Unscrew the front cap of fore-end in an anticlockwise direction (**Fig. 23**).
- Holding the shotgun by the barrel, pull the fore-end straight out toward the muzzle (**Fig. 24**).
- Pull the barrel out of the stock-receiver assembly while holding the piston inside the gas cylinder (**Fig. 25**).

**NOTICE:** NEVER STRIP the spring of the valve or the valve retaining nut. The valve device is self-cleaning and requires no maintenance. If necessary, contact a competent gunsmith.

### BREECH BOLT ASSEMBLY

(Breech bolt, connecting rod with sleeve)

**WARNING:** The breech bolt assembly need only to be disassembled in order to clean its components.

- Keeping the index or middle finger of the left hand on the cocking handle, press the release button and allow the breech bolt to move forward slowly until it stops (**Fig. 26**).
- Extract the cocking handle from the breech bolt, pulling forcefully (**Fig. 27**).
- Over a flat surface, with the ejection port pointed upwards, slide the connecting rod with sleeve forward off the magazine tube shaft to extract the breech bolt assembly from the receiver (**Fig. 28**).
- The breech bolt assembly, no longer held by the connecting rod with sleeve, will divide into (**Fig. 29**):



- Breech bolt with firing pin, locking block, extractor, springs and pins
- Sleeve with connecting rod

## TRIGGER PLATE

**NOTICE:** The trigger plate only needs to be disassembled in order to clean the trigger mechanism.

- Engage the safety (the hammer is cocked) (**Fig. 15**).
- Press the carrier stop push button, if it has not already been pressed (**Fig. 6**).
- Remove the trigger guard retaining pin by pressing with a pin punch or an awl (**Fig. 30**).
- Keeping the release button pushed all the way down, remove the trigger plate from the receiver using the trigger guard as a lever, first in the direction of the barrel and then outward (**Fig. 31**).

## BERETTA MOBILCHOKE® TUBES

Beretta Mobilchoke® tubes are built in high resistance steel to ensure a long life and rust protection and are designed to withstand the use of steel shot.

**NOTICE:** The barrel of the A300 Outlander can only mount Mobilchoke® type tubes. Other types of interchangeable Beretta choke tubes are not appropriate for use with A300 Outlander barrel and these will alter the shot pattern distribution.

### Beretta Mobilchoke® tubes

Beretta markings	American Designation	Compatibility of choke tubes with steel shot	Notches on the rim
0 (*)	F (Full)	SP (Steel Proof) <sup>(1)</sup>	I
00 (**)	IM (Improved Modified)	SP (Steel Proof) <sup>(1)</sup>	II
000 (***)	M (Modified)	SP (Steel Proof)	III
0000 (****)	IC (Improved Cylinder)	SP (Steel Proof)	IIII
C0000 (C****)	CL (Cylinder)	SP (Steel Proof)	IIIII

<sup>(1)</sup> Not recommended for steel shot.

Mobilchoke® is a registered trademark of Fabbrica d'Armi Pietro Beretta S.p.A.



## CHECKING THE CONDITION OF THE CHOKE TUBES

- Always check the appearance and cleaning of the choke tubes before using the shotgun.
- Check correct tightness in the barrel with the spanner provided.
- Never use choke tubes that show signs of defects, warping or incrustation.
- Make sure that the choke tube inserted is appropriate for the intended use and shot type to be used (steel or lead). See “Ammunition” chapter.

## REMOVAL OF CHOKE TUBE

**WARNING:** Always check that the shotgun is unloaded (empty cartridge chamber, empty receiver, empty magazine). Inspect the firearm by looking through the ejection port, the loading gate and the chamber. If it is not empty, unload it as instructed in the relevant section.

**WARNING:** Never look directly through the barrel from the muzzle and do not replace the choke with the shotgun loaded even with the safety engaged.

**CAUTION:** The safety can only be inserted with the hammer cocked. The hammer is cocked by pulling back the breech bolt. When the safety button shows the red ring, the SAFETY IS DISENGAGED, so the firearm is ready for use. When the red ring is not visible on the safety button, the SAFETY IS ENGAGED.

- Unscrew the choke tube, in an anticlockwise direction, with the spanner provided (**Fig. 32**).
- Remove the choke tube from the muzzle of the barrel (**Fig. 33**).

## CLEANING OF CHOKE TUBE AND ITS HOUSING

**WARNING:** Always check that the shotgun is unloaded (empty cartridge chamber, empty receiver, empty magazine). Inspect the firearm by looking through the ejection port, the loading gate and the chamber. If it is not empty, unload it as instructed in the relevant section. Check that the hammer is decocked.

**WARNING:** Never look directly through the barrel from the muzzle and do not replace the choke with the shotgun loaded even with the safety engaged.

- Clean the choke housing thoroughly using, if necessary, a brush swab soaked with Beretta Gun Oil. Dry with a soft cloth.
- Check that the choke is perfectly clean inside and outside.
- Apply a thin film of Beretta Gun Oil on the barrel thread and choke tube.

## INSERTION OF CHOKE TUBE

**CAUTION:** Always check that the shotgun is unloaded (empty cartridge chamber,

empty receiver, empty magazine). Inspect the firearm by looking through the ejection port, the loading gate and the chamber. If it is not empty, unload it as instructed in the relevant section. Check that the hammer is decocked.

**CAUTION:** Never look directly through the barrel from the muzzle and do not replace the choke with the shotgun loaded even with the safety engaged.

**CAUTION:** Check that the choke tube is in pristine condition (not damaged) prior to installing it.

- Make sure that the barrel thread and choke tube are perfectly clean and lightly oiled.
- Install the desired choke tube.
- Manually screw the choke tube clockwise into the barrel. Use the Beretta spanner provided to tighten the choke tube until it is fully lowered into its seat in the barrel. Forcefully tighten it manually.
- Remove the spanner from the barrel.

**CAUTION:** Periodically check that the choke tube is tightened correctly, ensuring that the shotgun is unloaded (empty cartridge chamber, empty receiver and empty magazine) and breech bolt in the open position. If necessary, firmly tighten the choke tube with the Beretta spanner. Correct tightening of the choke tube will avoid the occurrence of shotgun damage or injury.

**CAUTION:** The choke must be kept correctly tightened in the barrel at all times, even during storage and cleaning. Cleaning the barrel without the choke tube installed may lead to dirt becoming lodged in the barrel thread and preventing the choke tube from screwing in properly, or to the formation of rust or obstruction in the barrel.

**WARNING:** Never shoot the choke barrel without inserting a choke tube. Shooting without a choke tube in the barrel is very dangerous, as residues of lead or debris may become lodged in the thread creating an obstruction within the barrel. Also, not using a choke tube will damage the threading of the barrel irreparably and result in irregular shot spread.

Do not alter or modify an existing fixed choke Beretta barrel for the use of interchangeable choke tubes. The barrel wall thickness would be too thin to safely contain the pressure levels generated by shooting.



## ROUTINE MAINTENANCE

Clean and lubricate your shotgun any time combustion residue, grease or dirt is deposited in any of the mechanisms. Cleaning and lubrication of the firearm after each use is the best way of ensuring that the components are protected against combustion corrosion or rusting from use in humid or salty environments.

At the end of a shooting day, carry out the Routine Maintenance as indicated below.

**WARNING:** Always check that the shotgun is unloaded (empty cartridge chamber, empty receiver, empty magazine). Inspect the firearm by looking through the ejection port, the loading gate and the chamber. If it is not empty, unload it as instructed in the relevant section. Check that the hammer is decocked.

**WARNING:** Never point the firearm at someone or at hard, flat surfaces. Always treat the shotgun as if it were loaded. (See points 1, 2 and 4 of the BASIC SAFETY RULES).

**NOTICE:** For Routine Maintenance, simply disassemble it following the procedures described in the relevant section.

### BARREL

- Carefully clean the inside of the barrel with a soft cloth (flannel) to remove any combustion residue. If necessary, use a bronze brush or a cloth soaked with Beretta Gun Oil.
- Thoroughly clean the barrel tang
- Pull a soft, clean, dry cloth through the barrel.
- Lightly lubricate the barrel with a soft clean cloth soaked with Beretta Gun Oil.
- Check the barrel. The barrel and cartridge chamber must be clean and free from obstructions.

**CAUTION:** Excess oil or grease obstructing the barrel, even partially, is very dangerous when firing and may cause damage to the shotgun and serious injury to the shooter and to bystanders. Never spray or apply oil to the cartridges. Use lubricants properly. You are responsible for the proper care and maintenance of your firearm.

### GAS CYLINDER, PISTON, MAGAZINE TUBE

**CAUTION:** Use of Magnum and Super Magnum cartridges results in high combustion gas emissions.

The particular composition of the powders of some Super Magnum ammunition can leave consistent deposits of combustion residue. The parts of the shotgun where this problem is most likely to arise are the gas cylinder, the piston and

elastic piston seal and the magazine tube.

- Spray the piston, elastic piston seal and magazine tube shaft and clean with Beretta Gun Oil.
- Ensure that the piston glides freely on the magazine tube shaft
- To clean the walls of the gas cylinder, spray the walls with Beretta Gun Oil and clean thoroughly with a bronze brush.
- After removing any combustion residue, clean the inside of the gas cylinder with a clean cloth.

**NOTICE:** The components specified above must not be lubricated.

## EXHAUST VALVE ASSEMBLY

**NOTICE:** NEVER DISASSEMBLE the exhaust valve assembly. If necessary, contact a competent gunsmith.



## SPECIAL MAINTENANCE

Depending on the conditions of use of the firearm, and at the end of the hunting season, Beretta recommends you carry out the following extraordinary maintenance operations in order to keep the shotgun in perfect working order.

### BREECH BOLT ASSEMBLY

(Breech bolt, connecting rod with sleeve).

- Spray the parts and clean with Beretta Gun Oil.
- Thoroughly dry with a soft cloth and lightly lubricate.

### TRIGGER PLATE

- Thoroughly clean the parts with a soft cloth.
- Lightly lubricate all the metal components and the trigger plate retaining pin.

### RECEIVER

- Proceed as indicated for the breech bolt. Clean thoroughly with a soft cloth and lubricate the internal breech bolt guides.

**CAUTION:** Do not attempt to carry out repairs to any firearm without proper knowledge or training. Do not alter parts or use substitute parts not manufactured by Beretta. Any alterations or adjustments that may be necessary to the operating mechanism should be performed by the Manufacturer or by its Local Authorised Distributor.

## REASSEMBLY

**WARNING:** Always check that the shotgun is unloaded (empty cartridge chamber, empty receiver, empty magazine). Inspect the firearm by looking through the ejection port, the loading gate and the chamber. If it is not empty, unload it as instructed in the relevant section.

**WARNING:** Never point the firearm at someone or at hard, flat surfaces. Always treat the shotgun as if it were loaded. (See points 1, 2 and 4 of the BASIC SAFETY RULES).

### TRIGGER PLATE

- Work in reverse order to assembly, taking care to ensure that the hammer

is cocked, the safety is engaged and the carrier stop push button is pressed down.

- Keeping the release button pressed well down, make the rear part of the trigger plate adhere precisely to the receiver and push firmly towards the stock, as far as it will go.
- Rotate the trigger plate until it is inserted in its housing in the receiver.
- Insert the trigger guard retaining pin only when the hole of the trigger guard is centred on the receiver.

## BREECH BOLT ASSEMBLY

(Breech bolt, connecting rod with sleeve).

Remount the connecting rod with sleeve on the breech bolt.

- Working on a flat surface with the ejection port turned up, mount the breech bolt assembly and the operating rod with sleeve on the magazine tube shaft.
- Push the breech bolt operating rod all the way in to insert the breech bolt into the receiver.
- Slide the breech bolt operating rod downward, compressing the internal recoil spring until the breech locks into the open position.
- Insert the cocking handle on the breech bolt. Fasten it into position by hitting it firmly.

## BARREL

- Check the barrel. The barrel and cartridge chamber must be clean and free from obstructions.
- Insert the piston into the gas cylinder of the barrel, tightening the elastic seal with the fingers to make it easier to install the piston in the cylinder (**Fig. 5**).
- Check that the carrier stop push button is pressed all the way down. If it is not, push it all the way down (**Fig. 6**).
- Pull the breech bolt all the way back so that it remains open (**Fig. 7**).

**CAUTION:** When the release button is pressed, the breech bolt is pushed forward by the recoil spring, until it is stopped at the ejection port by the cocking handle, with the likelihood of damage to both parts.

- Insert the barrel into the receiver, ensuring that the magazine tube shaft enters the piston hole as well as that of the gas cylinder and the valve assembly (**Fig. 8, 9, 10**).
- Push it all the way into the receiver until it stops.



- Slide the fore-end into place over the gas cylinder / the valve assembly and magazine tube (**Fig. 11**). checking for the correct centering on the receiver face. The fore-end is in the correct position when it is fully against the receiver.
- Screw the fore-end cap on tightly (**Fig. 12**).
- Keep your fingers away from the ejection port, press the breech bolt release button and gently guide the breech bolt to lock (**Fig. 13**).
- Keeping the breech bolt pulled back 2 cm, pull the trigger, thereby decocking the hammer.

**WARNING:** Store your firearm so that children or other persons not familiar with firearms cannot gain access to it. To reduce the risk of accidents involving children, unload your firearm and lock it away. Store the ammunition in a separate locked location. (See point 3 of the BASIC SAFETY RULES).

**NOTICE:** If the firearm will not be used for a long time, keep it lubricated and disassembled (see the chapters “Maintenance” and “Storage”).

## STOCK DROP AND CAST MODIFICATION

**WARNING:** Always check that the shotgun is unloaded (empty cartridge chamber, empty receiver, empty magazine). Inspect the firearm by looking through the ejection port, the loading gate and the chamber. If it is not empty, unload it as instructed in the relevant section.

**WARNING:** Never point the firearm at someone or at hard, flat surfaces. Always treat the shotgun as if it were loaded. (See points 1, 2 and 4 of the BASIC SAFETY RULES).

were loaded. (See points 1, 2 and 4 of the BASIC SAFETY RULES).

The Beretta semi-automatic A300 Outlandr has a pre-set factory stock cast-off setting (for right-handed shooters) with 55 or 60 mm drop.

The components which govern the drop and the cast are (see **Fig. 34**):

- ❶ the drop-cast front spacer, made of reinforced technopolymer fibreglass
- ❷ the stock steel plate.

Both the front spacer ❶ and the plate ❷ are designed to secure two different drops, each with a cast-off or a cast-on (for left-handed shooters) depending on how they are assembled. A set of additional spacers is also provided to further change the drop by replacing the spacer pair.

## REPLACING THE STOCK DROP AND CAST SPACERS

**NOTICE:** The right-hand cast is designated by the initials DX. The left-hand cast



is designated by the initials SX. The drop and cast of the front spacer and plate must always be synchronised.

**WARNING:** Stock drop and cast modification must be carried out by a competent gunsmith. Failure to comply with these instructions can lead to damage to property or injury to persons.

## REQUIRED TOOLS

- N° 1 Philips and 1 flat-head screwdriver.
- N° 1 Torque wrench T15.
- N° 1 Hexagonal spanner, 6 mm.
- N° 1 Tube spanner, 13 mm.
- N° 1 Torque wrench (previously mentioned) with a 13-mm pipe extension.

## FIELD STRIPPING

- Use the Phillips screwdriver to remove the two screws sunk into the stock.
- Remove the Beretta recoil pad from the stock
- Use the 13-mm tube spanner to completely unscrew the retaining nut of the stock and remove the nut, spring washer and plate ❷.
- Separate the stock from the receiver and remove the plate ❶.

## REASSEMBLY

- Centre the front spacer ❶ on the stock bolt tube. Make sure that the indicator showing the desired drop and cast ("C-60-DX" in the diagram) is visible on the spacer.
- Reposition the stock. Place the rear plate ❷ inside the stock. Make sure that the same marking is visible on the plates.
- Use the 13-mm tube spanner to insert the retaining nut of the stock and spring washer and tighten down with tightening torque 1.6 - 1.8 Kgm (Kilogram-meters). The use of a proper dynamometric spanner is recommended.
- Screw on the recoil pad.



## STORAGE

**WARNING:** To reduce the risk of accidents involving children or unauthorised persons, keep your firearm locked away and store the ammunition in a separate locked location!

**NOTICE:** Store the firearm disassembled (barrel/fore-end and receiver/stock) in the supplied case. Before storage, always check the condition of the shotgun and its case. Ensure that they are perfectly dry. Moisture and water drops can damage the shotgun.

**NOTICE:** Do not store the shotgun in a leather or fabric case. These materials attract moisture, even though they may appear to be perfectly dry.

# NOTES

---

---

---

---

---

---

---

---

---

---

---

---

---

---

---

---

---

---

---

---

---

---

---

---



NOTES

---

---

---

---

---

---

---

---

---

---

---

---

---

---

---

---

---

---

---

---

---

---

---

---