

USER'S MANUAL

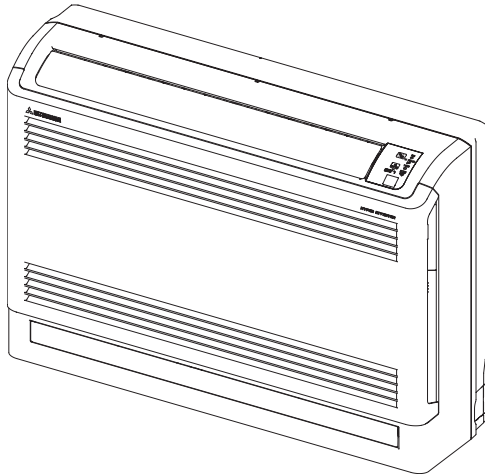

AIR-CONDITIONER

ENGLISH



SRF25ZJX-S
SRF35ZJX-S
SRF50ZJX-S

MANUEL DE L'UTILISATEUR

FRANÇAIS

CLIMATISEUR

ANWENDERHANDBUCH

DEUTSCH

KLIMAGERÄT

ISTRUZIONI PER L'USO

ITALIANO

CONDIZIONATORE D'ARIA

MANUAL DEL PROPIETARIO

ESPAÑOL

ACONDICIONADOR DE AIRE

GEBRUIKERSHANDLEIDING

NEDERLANDS

AIRCONDITIONING

MANUAL DO UTILIZADOR

PORTUGUÊS

APARELHO DE AR CONDICIONADO

ΟΔΗΓΙΕΣ ΧΡΗΣΗΣ

ΕΛΛΗΝΙΚΑ

ΚΛΙΜΑΤΙΣΤΙΚΟ

РУКОВОДСТВО ПО ЭКСПЛУАТАЦИИ

РУССКИЙ

ΚΟΝΔΙΤΙΟΝΕΡ ΒΟΖΔΥΧΑ

KULLANIM KILAVUZU

TÜRKÇE

SPLIT KLİMA



This air conditioner complies with **EMC** Directive 2004/108/EC, LV Directive 2006/95/EC.

Este acondicionador de aire cumple con la directiva **EMC**: 2004/108/EC, LV Directiva 2006/95/EC.

Ce climatiseur est conforme à la Directive **EMC**: 2004/108/EC, LV Directive 2006/95/EC.

Deze airconditioner voldoet aan **EMC** Directive 2004/108/EC, LV Directive 2006/95/EC.

Dieses Klimagerät erfüllt die **EMC** Direktiven 2004/108/EC, LV Direktiven 2006/95/EC.

Este aparelho de ar condicionado está em conformidade com a Directiva **EMC** 2004/108/EC e a Directiva LV 2006/95/EC.

Questo condizionatore d'aria è conforme alla Direttiva **EMC**: 2004/108/EC, LV Direttiva 2006/95/EC.

Αυτό το κλιματιστικό είναι σύμφωνο με τις προδιαγραφές της Οδηγίας **EMC** 2004/108/EK και της Οδηγίας LV 2006/95/EK.

RFB012A003

Thank you for purchasing a MITSUBISHI HEAVY INDUSTRIES, LTD. Air-Conditioner. To get the best long-lasting performance, please read and follow this User's Manual carefully before using your air-conditioner. After reading, please store the Manual in a safe place and refer to it for operational questions or in the event of any irregularities.

This air-conditioner is intended for domestic use.

Do not vent R410A into the atmosphere: R410A is a fluorinated greenhouse gas, covered by the Kyoto Protocol with a Global Warming Potential (GWP) = 1975.

ENGLISH

 Your Air Conditioning product may be marked with this symbol. It means that waste electrical and electronic equipment (WEEE as in directive 2002/96/EC) should not be mixed with general household waste. Air conditioners should be treated at an authorized treatment facility for re-use, recycling and recovery and not be disposed of in the municipal waste stream. Please contact the installer or local authority for more information.

 This symbol printed in the batteries attached to your Air Conditioning product is information for end-users according to the EU directive 2006/66/EC article 20 annex II. Batteries, at their end-of-life, should be disposed of separately from general household waste. If a chemical symbol is printed beneath the symbol shown above, this chemical symbol means that the batteries contain a heavy metal at a certain concentration. This will be indicated as follows: Hg:mercury(0.0005%) , Cd:cadmium(0.002%) , Pb:lead(0.004%) Please, dispose of batteries correctly at your local community waste collection or the recycling center.

contents

Safety precautions.....	2	OFF-TIMER operation	12
Name of each part and its function	4	ON-TIMER operation.....	13
Remote control handling	6	SLEEP TIMER + ON-TIMER operation	14
Operation failure with the remote control	6	PROGRAM TIMER operation	14
Temporary run operation	6	HIGH POWER/ECONOMY operation	15
Operation and display section for remote control	7	SELF CLEAN operation	16
Current time setting	7	Auto restart function	16
AUTO mode operation	8	Tips for effective operation	16
Temperature adjustment during AUTO	8	Airoutlet selection.....	17
FAN SPEED	8	Maintenance.....	18
COOL/HEAT/DRY/FAN mode operation	9	Proper installation	20
Air-conditioner operable temperature setting... ..	9	Troubleshooting	20
Characteristics of HEAT mode operation	9	Notice	21
Airflow direction adjustment	10	Contact your dealer.....	22
SLEEP TIMER operation	11	About the Multiple Air-conditioner	22
		Self diagnosis function	23







Safety precautions

- Before starting to use the system, please read these “Safety precautions” carefully to ensure proper operation of the system.
- The safety precautions are classified as “⚠ DANGER” and “⚠ CAUTION”. Precautions as shown in the column “⚠ DANGER” indicate that improper handling could lead to drastic result like death, serious injury, etc. Even precautions as shown in the column “⚠ CAUTION” might pose a serious problem, depending on the circumstances. Please observe these precautions with great care, since they are essential to your safety.
- Symbols which appear frequently in the text have the following meaning:













	Strictly prohibited		Observe instructions with great care		Provide proper earthing
---	----------------------------	---	---	---	--------------------------------

- When you have read this instruction manual, please keep it without missing. If someone else takes over as operator, make certain that the manual is also passed on to the new operator.

■ INSTALLATION PRECAUTIONS

⚠ DANGER	⚠ CAUTION	
<p>The system is for domestic, residential etc. use.</p> <p> If used in severer environments, such as an engineering workplace, the equipment may function poorly.</p>	<p>Do not install it where flammable gas may leak.</p> <p> Gas leaks may cause fire.</p>	<p>Depending on the place of installation, an earth leakage breaker may be necessary.</p> <p> If you do not install an earth leakage breaker, you may get an electric shock.</p>
<p>The system must be installed by your dealer or a qualified professional.</p> <p> It is not advisable to install the system by yourself, as faulty handling may cause leakage of water, electric shock or fire.</p>	<p>Make sure to install the drain hose properly so that all the water is drained out.</p> <p> Improper installation may lead to water drop in the room resulting in wet furniture.</p>	<p>Make sure that the system has been properly earthed.</p> <p> Earth cables should never be connected to a gas pipe, water pipe, lightning conductor or telephone earth cable. Incorrect installation of the earth cable may produce an electric shock.</p>

■ OPERATION PRECAUTIONS

⚠ DANGER		
<p>Do not expose yourself to the cooling air for a long period.</p> <p> This could affect your physical condition and cause health problems.</p>	<p>Do not insert anything into the air inlet.</p> <p> This may cause injury, as the internal fan rotates at high speed.</p>	<p>Store the remote control out of reach of infants.</p> <p> Failure to observe this may result in the batteries being swallowed or other accidents.</p>
⚠ CAUTION		
<p>Only use approved fuses.</p> <p> Use of steel or copper wire instead of an approved fuse is strictly prohibited, as it may cause a breakdown or fire.</p>	<p>Do not handle the switches with wet hands.</p> <p> This may cause an electric shock.</p>	<p>Do not swing from the indoor unit.</p> <p> If the indoor unit falls down, you may get injured.</p>
<p>Do not place a flammable insecticide or paint spray near the blower, nor spray it directly on the system.</p> <p> This may result in a fire.</p>	<p>You should not expose any combustion appliance directly to the air stream of the air-conditioner.</p> <p> The appliance may then work inadequately.</p>	<p>Do not wash the air-conditioner with water.</p> <p> This could cause an electric shock.</p>
<p>The system should only be used for its original purpose and not for anything else like, for instance, preservation of food, plants or animals, precision devices or works of art.</p> <p> The system is only intended for use in ordinary domestic rooms. Any other use of the system may damage the quality of food, etc.</p>	<p>Do not place anything containing water, like vases, on top of the unit.</p> <p> Water entering the unit could damage the insulation and therefore cause an electric shock.</p>	<p>Do not install the system where the air-flow direction is aimed directly at plants or animals.</p> <p> This will damage their health.</p>

■ Safety precautions

⚠ CAUTION

Do not sit on the outdoor unit nor put anything on it.



If the unit falls down or things drop off it, people could get hurt.

After a long period of use, check the unit's support structure from time to time.



If you do not repair any damage right away, the unit may fall down and cause personal injury.

Do not touch the aluminum fins on the air heat exchanger.



It may result in injury.

Do not place household electrical appliances or household items under neath the indoor or outdoor units.



Condensation falling from the unit may stain objects and cause accidents or electrical shock.

Do not operate the system without the air filter.



It can cause malfunction of the system due to clogging of the heat exchanger.

Do not shut off the power supply immediately after stopping the operation.



Wait at least 5 minutes, otherwise there is a risk of water leakage or breakdown.

Do not control the system with main power switch.



It can cause fire or water leakage. In addition, the fan can start unexpectedly, which can cause personal injury.

Do not pour liquid into this unit and do not put water container on this unit.



Water entering the unit could damage the insulation and therefore cause an electric shock.

If you operate the system together with a combustion appliance, you must regularly ventilate the indoor air.



Insufficient ventilation may cause accidents due to oxygen deficiency.

When you clean the system, stop the unit and turn off the power supply.



Never open the panel while the internal fan is rotating.

Do not place objects near the outdoor unit or allow leaves to gather around the unit.



If there are objects or leaves around the outdoor unit, small animals may enter unit and contact electrical parts and may cause a breakdown, smoke or fire.

Contact your dealer to clean inside the indoor unit, do not attempt to do by yourself.



The use of a non-approved detergent or improper washing method may damage the unit's plastic components and cause leaks. Damage, smoke, or fire may also happen if the detergent comes in contact with electrical parts or the unit's motor.

Stop the unit and turn off the power if you hear thunder or there is a danger of lightning.



It may damage the unit.

Do not let the foreign matters enter the indoor unit through the air outlets.



This may cause the dumper inoperable.

■ PRECAUTIONS FOR RELOCATION OR REPAIRS

⚠ DANGER

Do not perform any repairs or modifications by yourself. Consult the dealer if the unit requires repair.



If you repair or modify the unit, it can cause water leaks, electric shocks or fire.

Consult your dealer for repairs.



Wrong repairs could cause an electric shock, fire, etc.

In case the air-conditioner is relocated elsewhere, contact your dealer or a professional fitter.



Faulty installation may cause water leakage, electric shock, fire, etc.

If you notice anything abnormal (smell of burning, etc.), stop the system, turn off the power supply and consult your dealer.



Continued use of the system in abnormal circumstances may result in malfunctioning, electric shock, fire, etc.

If the air-conditioner fails to cool or warm the room, it may have a refrigerant leakage. Contact your dealer. If refrigerant needs to be added, check with your dealer for proper instructions.



The refrigerant used in your air-conditioner is safe. However, if refrigerant unexpectedly leaks from the unit onto a fan heater, stove, hotplate or other heat source, harmful gases could be generated.

Name of each part and its function

INDOOR UNIT

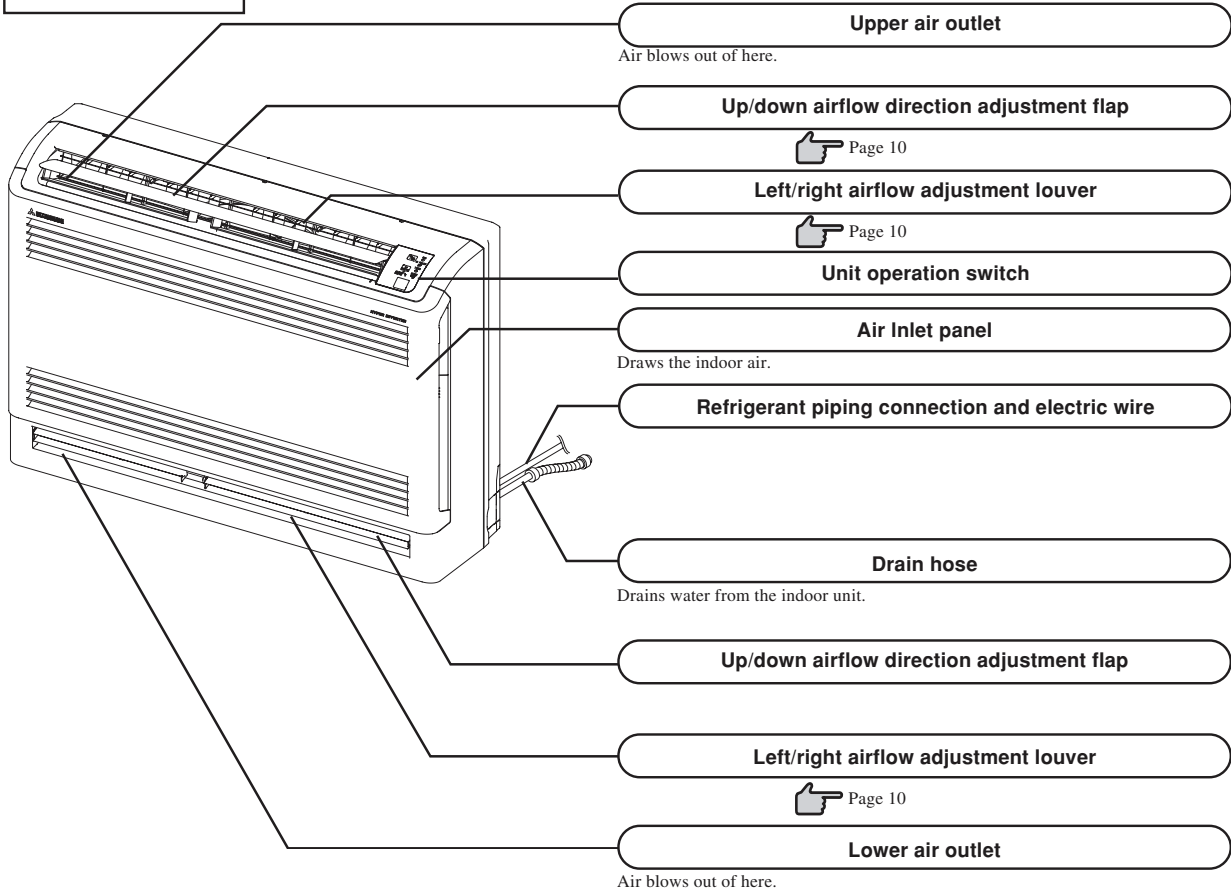

- Air inlet panel removed.

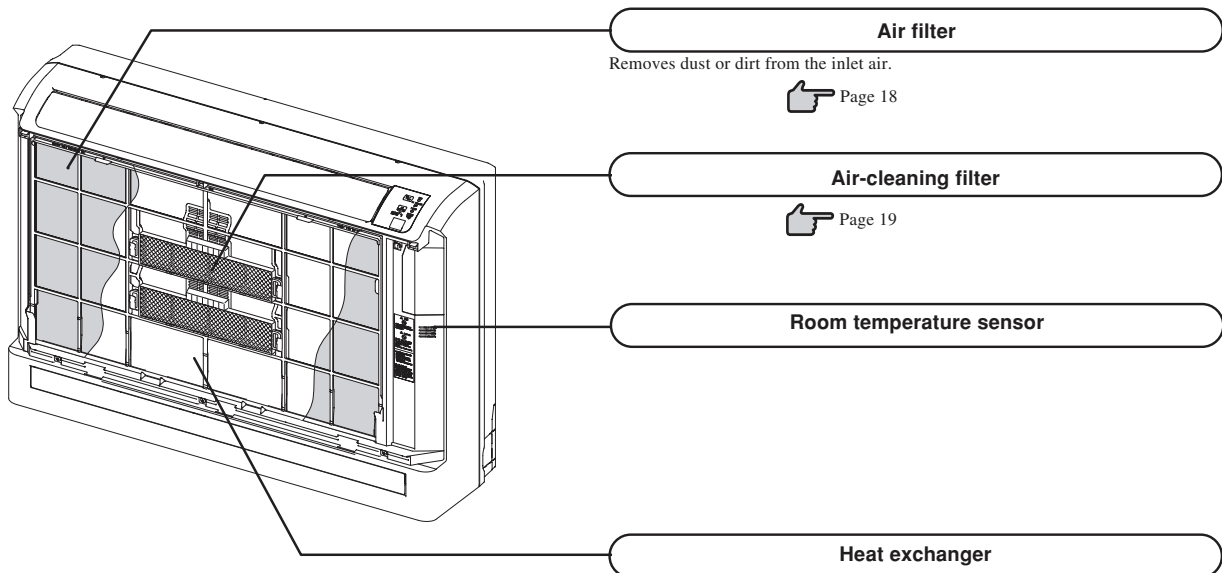

Name of each part and its function

Unit display section

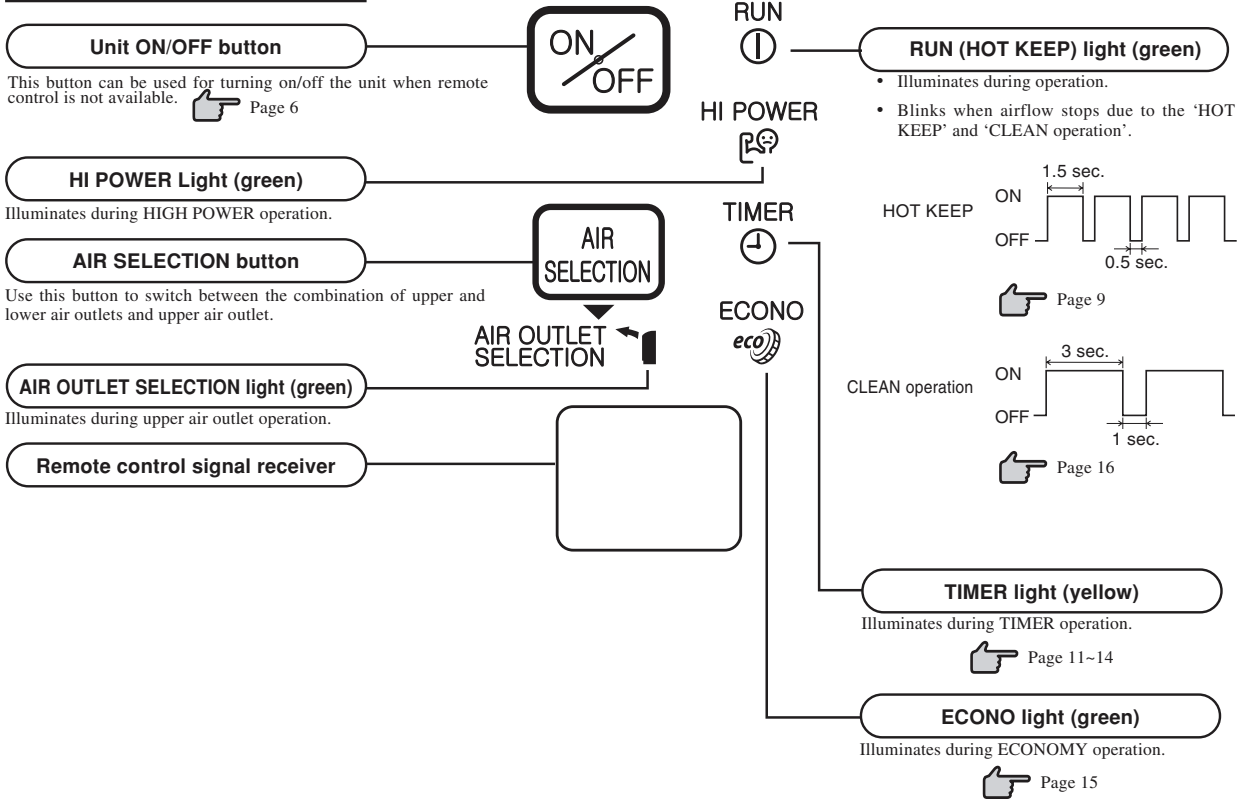

Accessories

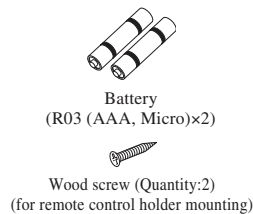
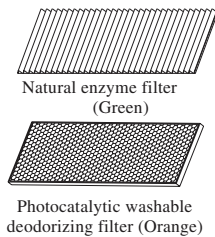
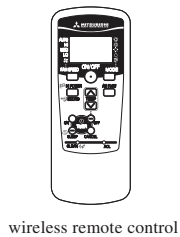

NOTE

- **Buzzer sound for remote control**
When preset temperature 24°C, automatic operation and automatic airflow are selected, the buzzer sound (PiPi) is produced. When turning off the air conditioner by pressing ON/OFF button (except CLEAN mode), the buzzer sound (Pi) is produced. This function is useful for operating the air conditioner in the darkness.

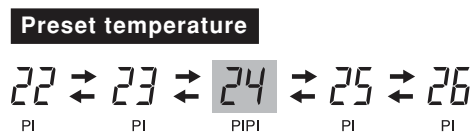
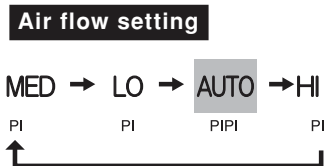

Remote control handling

Replacing the batteries

1 Pull out the cover and take out old batteries.

2 Insert new batteries.
R03 (AAA, Micro) x2

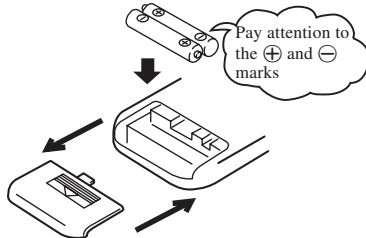

3 Close the cover.

4 Press the ACL switch with the tip of a ballpoint pen.

The timer setting mode is displayed.

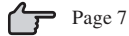

The following cases signify exhausted batteries. Replace old batteries with new ones.

- Receiving beep is not emitted when a signal is transmitted.
- Display fades away.

NOTE

- Do not use old and new batteries together.
- Remove the batteries when the remote control is not used for a long period.
- The recommended effective period of a battery conforming to JIS or IEC should be 6 to 12 months with normal use. If used longer, or when an unspecified battery is used, liquid may leak from the battery, causing the remote control to malfunction.
- The recommendable effective period is printed on the battery. This may be shorter due to manufacturing time to the unit. However, the battery may still be in working order after expiry of its nominal life.

- When the display shows any abnormal condition, Press the ACL switch with the tip of a ballpoint pen.

Using the remote control holder

The remote control can be attached to a wall or pillar by using a remote control holder. Before installing the remote control, check that the air-conditioner receives the signals properly.

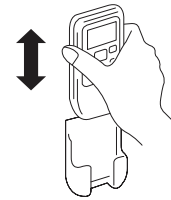

For installing or removing the remote control, move it up or down in the holder.

Warning note for remote control handling

⊘ Strictly prohibited

- | | | |
|---|--|--|
| <ul style="list-style-type: none"> • Do not go near high temperature places, such as an electric carpet or stove. | <ul style="list-style-type: none"> • Do not leave the remote control exposed to direct sunlight or other strong lighting. | <ul style="list-style-type: none"> • Do not drop the remote control. Handle with care. |
| <ul style="list-style-type: none"> • Do not put any obstructing obstacles between the remote control and the unit. | <ul style="list-style-type: none"> • Do not spill any liquid on the remote control. | <ul style="list-style-type: none"> • Do not place heavy objects on the remote control, or step on it. |

Operation failure with the remote control

- Are the batteries running down?



“Replacing the batteries” above.

Replace the batteries with new ones and retry the operation.

- If the operation fails, operate the unit with temporary operation function. Contact your dealer to have the remote control checked.



Below

Temporary run operation

- The unit ON/OFF button on the unit operates ON/OFF temporarily when the remote control is not used.

Operation program

- OPERATION MODE : AUTO
- FAN SPEED : AUTO
- AIR FLOW : AUTO

- Operation starts by pressing the unit ON/OFF button; it stops if you press the button again.

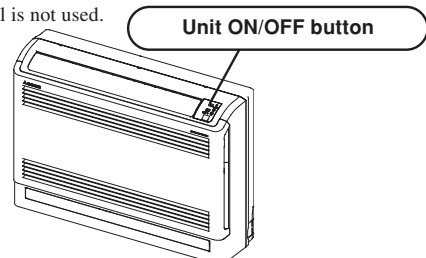

NOTE

- Do not hold the Unit ON/OFF button down for more than 5 seconds. (Holding it down longer than 5 seconds sets the automatic cooling used during servicing or when relocating the air-conditioner.)

Operation and display section for remote control

Operation section

FAN SPEED button

Each time the button is pressed, the ■ display is switched over in turn.

👉 Page 8

HI POWER/ECONO button

This button changes the HIGH POWER/ECONOMY mode.

👉 Page 15

TEMPERATURE button

These buttons set the room temperature. (These buttons are used for setting the current time and timer function as well.)

ON TIMER button

This button selects ON TIMER operation.

👉 Page 13

SLEEP button

This button selects SLEEP operation.

👉 Page 11

CLEAN switch

This switch selects the CLEAN mode.

👉 Page 16

CANCEL button

This button cancels the ON timer, OFF timer, and SLEEP operation.

• The above illustration shows all controls, but in practice only the relevant parts are shown.

OPERATION MODE select button

Each time the button pressed, the ■ display is switched over in turn.

👉 Page 8, 9

ON/OFF (luminous) button

Press to start operation, press again to stop.

AIR FLOW (UP/DOWN) button

This button changes the air flow (up/down) direction.

👉 Page 10

OFF TIMER button

This button selects OFF TIMER operation.

👉 Page 12

ACL switch

This switch is for resetting microcomputer and setting time.

👉 Page 6

Transmission procedure

When each button on the remote control is pressed – with the remote control pointing towards the air-conditioner unit a signal is transmitted. When the air-conditioner receives the signal correctly, it will beep.

Current time setting

- When inserting the batteries, the current time is automatically set to time setting mode. 13:00 is displayed as the current time. Set the clock to the right time.

Example: Set to 10:30.

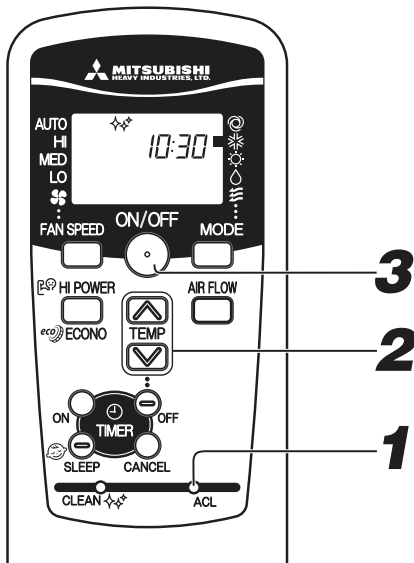

1

Press the ACL switch.

Press with the tip of a ballpoint pen, etc. The time display blinks and can be set to the current time.

2

Press the “▲ or ▼” button.

(Set to 10:30)

3

Press the ON/OFF button.

The display changes from blinking to steady lighting and the setting is complete. Make sure to press the button within 60 seconds from the last operation in step 2, otherwise the time is not set.

NOTE

- The timer operation works based on the time clock, so please set it correctly.
- The remote control data is reset when the present time is set.

AUTO mode operation

- Automatically selects the operation mode (COOL, HEAT, DRY) depending on the room temperature when switched on.

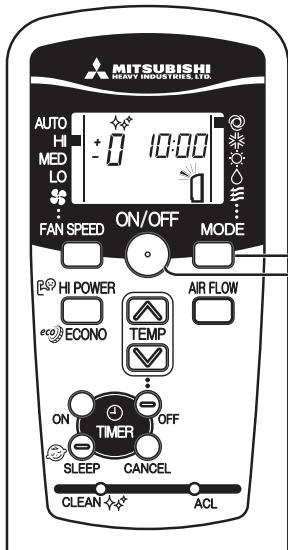

When the unit is not in AUTO mode:

1 Press MODE button.
Move the [■] mark to the ☉ (Auto) position.

Point the remote control toward the air-conditioner, and

2 Press the ON/OFF button.

To stop: Press the ON/OFF button.

NOTE

- In case air is not blowing out during the operation. Page 21
- When the included clean filter is installed the air conditioner will clean the air during automatic operation.

AUTO mode can be operated by simply pressing the ON/OFF button.

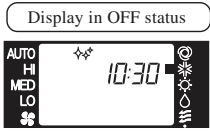

- The current time and preset OPERATION MODE are displayed while the air conditioner is turned off.

- If you do not want the AUTO mode program, change to COOL, HEAT, DRY or FAN instead of AUTO.

Page 9

- Airflow direction adjustment procedure.

Page 10

Temperature adjustment during AUTO

- Air temperature adjustment is possible even during automatic operation. There are 6 levels of adjustment possible with the ☉ button or the ☽ button.

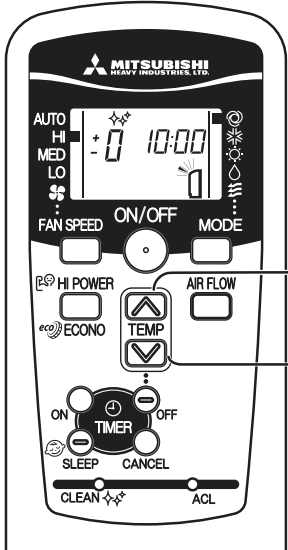

When a change in temperature is required.

1 Press the ☉ or ☽ button.

When it is a little cold
Press the ☉ button.

- Each time the ☉ button is pressed, the switch over occurs in the following order -6 → -5 → -1 → ±0 → +1 +6.
When +6 is indicated, even if the ☉ button is pressed, the indicator does not change.

When it is a little hot
Press the ☽ button.

- Each time the ☽ button is pressed, the switch over occurs in the following order +6 → +5 → +1 → ±0 → -1 -6.
When -6 is indicated, even if the ☽ button is pressed, the indicator does not change.

	Remote Control display												
Setting	-6	-5	-4	-3	-2	-1	±0	+1	+2	+3	+4	+5	+6
temp.(°C)	20	21	22	23	24	25	26	27	28	29	30	31	32

FAN SPEED

- You can choose the capacity of your air-conditioner when heating mode, cooling mode or fan mode.

Operation capacity by your choice	FAN SPEED
Set automatically by microcomputer	AUTO
Powerful operation with high capacity	HI
Standard operation	MED
Energy-saving operation	LO

Press the FAN SPEED button.

Move the [■] mark to the preferred fan speed position.

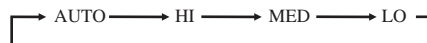

NOTE

- When changing FAN SPEED from HI to LO, the sound of refrigerant flowing may be heard.

COOL/HEAT/DRY/FAN mode operation

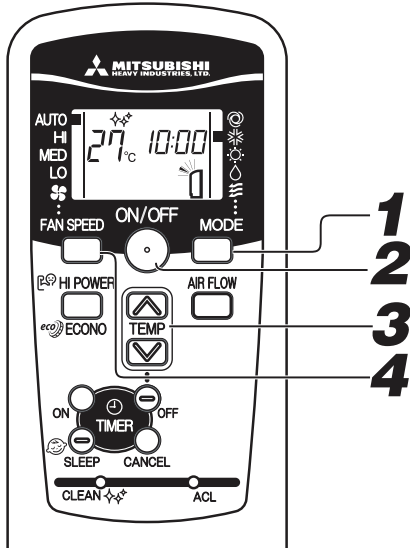

Point the remote control toward the air-conditioner, and

1

Press the MODE select button.

Move the [■] mark to the required operation position.

※ (Cool), ☀ (Heat), △ (Dry), ㊦ (Fan)

2

Press the ON/OFF button.

3

Press the TEMP button.

Press ▲ or ▼ button for the preferred temperature.

Standard

COOL	26°C~28°C	HEAT	22°C~24°C	DRY	24°C~26°C	FAN	--
------	-----------	------	-----------	-----	-----------	-----	----

4

Press the FAN SPEED button

Set the fan speed as preferred.

Airflow direction adjustment procedure. Page 10

NOTE

- In case air is not blown out, when starting the heating operation. Page 21
- The operation program can also be set or changed when the air-conditioner is not in operation.

To stop:

Press the ON/OFF button.

Air-conditioner operable temperature setting

- Use within the following operational range. Operating outside of this range may result in the protection devices being activated, preventing the unit from working.

	Cooling operation	Heating operation
Outside temperature	Approximately -15 to 46 °C	Approximately -15 to 21 °C
Inside temperature	Approximately 18 to 32 °C	Approximately 15 to 30 °C
Inside humidity	Below approximately 80% The long-term use of the unit with a humidity level exceeding 80% may result in condensation forming on the surface of the indoor unit, leading to water drips.	—

Characteristics of HEAT mode operation

Mechanism and capacity of HEAT mode operation

■ Mechanism

- The unit draws heat from the cold outside air, transfers it to indoors and heats the room. As a characteristic of heat pump system, the heating capacity reduces when the outside air temperature gets colder.
- It may take some time to supply hot air after turning on the air-conditioner.
- If the outside temperature becomes extremely low, it would be better to use an additional source of heating.

Defrosting

If the outside temperature becomes low and humidity is high, the heat exchanger in the outdoor unit may frost over, which prevents efficient heating. **If this happens, the automatic defrost function is activated and during defrosting the heating operation stops for 5 to 15 minutes during defrosting.**

- Both indoor and outdoor fans stop and the RUN light blinks slowly (1.5 sec. ON, 0.5 sec. OFF) during defrosting.
- The outdoor unit may give off some steam during defrosting. This is to help the defrosting process and is not a defect.
- The HEAT operation resumes as soon as defrosting has been completed.
- Although the upper and lower air outlets are selected, the lower flap closes during defrost.

Airflow direction adjustment

Adjusting airflow direction

- Up/down direction can be adjusted with the AIRFLOW button on the remote control. Every time you press this button the mode changes as follows:
Change on AIRFLOW (UP/DOWN) mode.

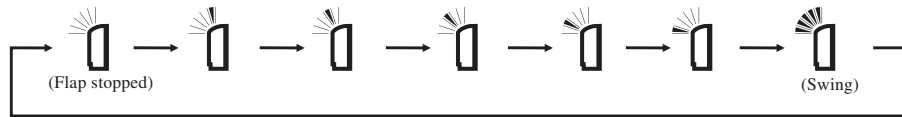

NOTE FOR HEATING OPERATION

- When operation starts, the flap direction is fixed at the vertical position in order to avoid cold draft, and return to the set position that was set after the warm air supply is starting.
- The flap direction will be controlled to the vertical position when the room temperature reaches the set temperature and compressor stops or when defrosting is in operation.
- The airflow direction cannot be set during the period mentioned above. Change the airflow direction settings after the warm air is supplied and the flap goes to the set position.

MEMORY FLAP (FLAP STOPPED)

When you press the AIRFLOW button once while the flap is operating, it stops swinging at the position. Since this angle is memorized in the microcomputer, the flap will automatically be set at this angle when the next operation is started.

- ⚠ DANGER**
- Do not expose directly to airflow from the air-conditioner for a long time.

- ⚠ CAUTION**
- When in COOL or DRY operation, do not operate for a long period with the airflow blowing straight down. Otherwise, condensation may appear on the outlet grill and drip down.
 - Do not try to adjust the flaps by hand, as the control angle may change or the flap may not be closed completely.

- Recommended angle of the flap when stopping

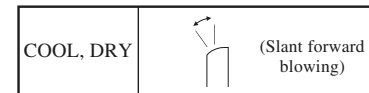
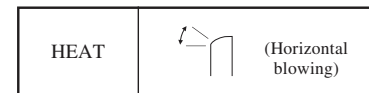

Adjusting left/right air flow direction

Adjust the direction by moving the left/right air flow fin by hand.

- ⚠ CAUTION**
- When adjusting the air flow direction, be careful with the fans rotating in the air conditioner. Otherwise you may injure your fingers.
 - The lower flap is not adjustable while the air conditioner is OFF.

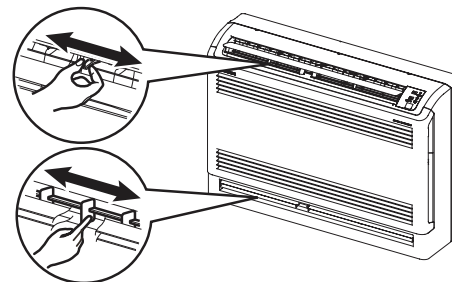

SLEEP TIMER operation

- The unit stops automatically after the set time lapses.
The set temperature is automatically adjusted according to the elapsed time in order to avoid too much cooling or heating.

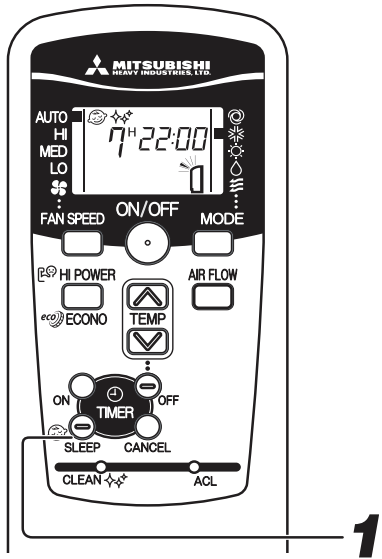

1 Press the SLEEP button.

- **If it is pressed while the unit is off**
SLEEP TIMER operation starts with the previous operation settings, and the air conditioning is turned off after the set time elapses.
- **If it is pressed while the unit is running**
The air conditioner is turned off after the set time elapses.
Every time the button is pressed, the display changes as follows:

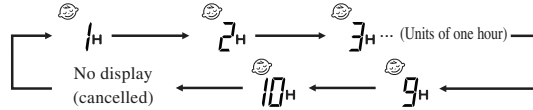

Example: You prefer it to stop after 7 hours.

Set to 7H

The timer light (yellow) is on.

- The unit stops after the set time lapses.

Changing of set time
Set a new time by pressing SLEEP button.

How to cancel
Press the CANCEL button to turn off the SLEEP indicator.

NOTE

- Cannot be set at the same time with OFF-TIMER.

SLEEP TIMER

When SLEEP TIMER is selected, the set temperature is automatically adjusted after a while, ensuring that the room is not too cold during cooling or too warm during heating.

- During cooling : the preset temperature is lowered by 1°C at the start of SLEEP operation (when the timer is set). After that, the temperature goes up by 1°C every an hour to become 1°C higher than the present temperature.
- During heating: Preset temperature is lowered by 1°C at the start of SLEEP operation (when the timer is set). After that the temperature to becomes 3°C lower in an hour and 6°C lower in two hours than the present temperature.

Unit display section

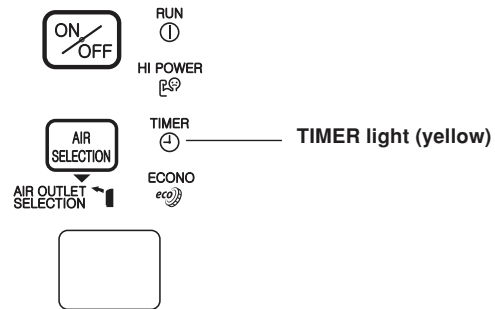

OFF-TIMER operation

- The unit stops automatically when the set time comes.

With the air conditioner turned off, start the operation from Step 1. With the air conditioner running, start from Step 2.

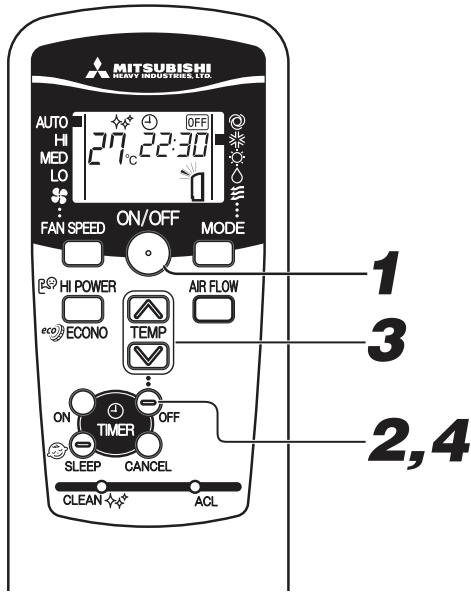

Example: You prefer it to stop 22:30.

- 1** Press the ON/OFF button.
- 2** Press the OFF TIMER button.
OFF TIMER display **OFF** is blinking.
- 3** Press the “⊗ or ⊙” button.
Every time the ⊗ button is pressed, the display is switched in the order of:
 →0:00→0:10→0:20→...→1:00→1:10→(Units of ten minutes)
 Every time the ⊙ button is pressed, the display is switched in the order of:
 →0:00→23:50→23:40→...→23:00→22:50→(Units of ten minutes)
 Set at 22:30.
- 4** Press the OFF TIMER button.
The display changes from blinking to steady lighting and the setting is complete.
The timer light (yellow) is on.

Changing of set time

Set a new time by using the OFF TIMER button.

How to cancel

Press the CANCEL button to turn off the timer display.

NOTE

- The unit stops at the end of the set period of time.
- Make sure to press the button within 60 seconds from the last operation in step 3, otherwise the setting is not completed.
- The current time is not displayed during OFF-TIMER operation.
- Different from SLEEP TIMER operation, automatic set temperature adjustment is not done during OFF-TIMER operation.

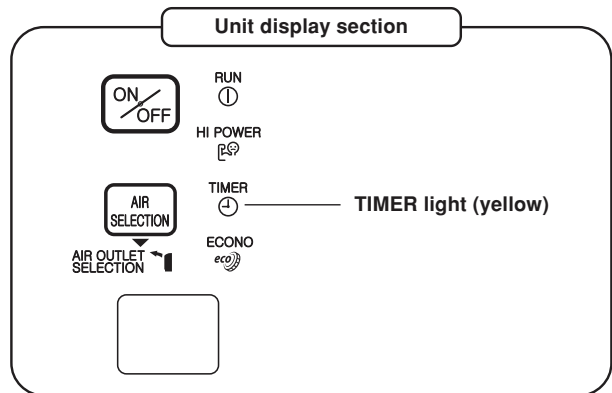

ON-TIMER operation

- Operation starts 5 to 60 minutes before the set time so that the room temperature reaches the optimum temperature at the set time. ON-TIMER operation can be set regardless of whether the air-conditioner is running or not.

Example: In the case the preferred room temperature is required at 8:00.

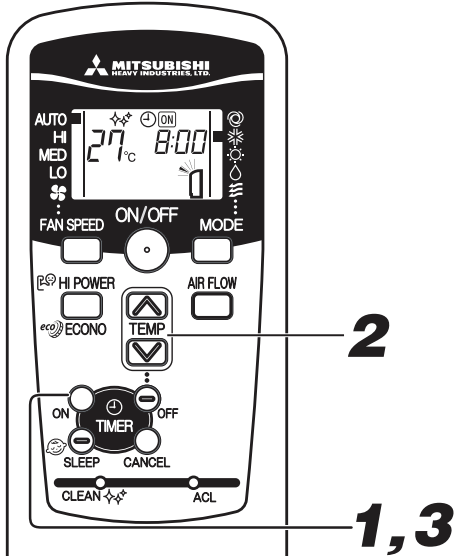

1 Press the ON-TIMER button.

ON TIMER indicator is blinking.

2 Press the “ or ” button.

Every time the button is pressed, the display is switched in the order of:

0:00 → 0:10 → 0:20 → ... → 1:00 → 1:10 → (Units of ten minutes)

Every time the button is pressed, the display is switched in the order of:

0:00 → 23:50 → 23:40 → ... → 23:00 → 22:50 → (Units of ten minutes)

Set at 8:00.

3 Press the ON-TIMER button.

The display changes from blinking to steady lighting and the setting is complete. The timer light (yellow) is on. The operation stops if it is set during operation.

Changing of set time

Set a new time by using the ON-TIMER button.

How to cancel

Press the CANCEL button to turn off the timer indicator.

NOTE

- Operation starts 5 to 60 minutes before the set time.
- The timer light (yellow) goes out at the set time.
- Make sure to press the button within 60 seconds from the last operation in step 2, otherwise the setting is not completed.
- The current time is not displayed during ON-TIMER operation.

Comfort Start-up

In ON-TIMER operation, the unit starts the operation a little earlier, so that the room can approach optimum temperature at ON time. This is so called “Comfort start-up”.

• Mechanism

The room temperature is checked 60 minutes before the ON time. Depending on the temperature at that time, the operation starts 5 to 60 minutes before the timer is at ON.

- The function is available for both COOL and HEAT operation mode (including AUTO). It does not work for DRY mode.

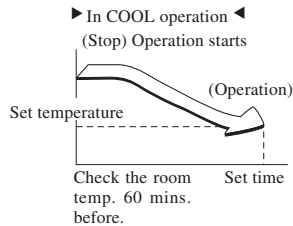

Unit display section

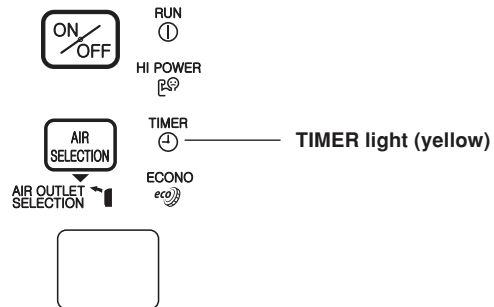

SLEEP TIMER + ON-TIMER operation

- Combined timer operation of SLEEP TIMER and ON TIMER.

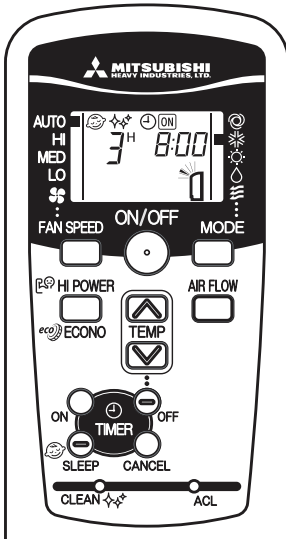

Example: When it is required to stop after 3 hours and then start operation at 8:00, near the set temperature.

■ SLEEP TIMER setting

Set by the procedures on page 11.

Set to 3H

■ ON TIMER operation setting

Set by the procedure on page 13.

Set to 8:00

The setting of the lighting of the timer light (yellow) of this unit is complete.



- After the SLEEP TIMER set time has elapsed, the operation stops, and it starts from 5 to 60 minutes before the ON TIMER's set time.
- The timer light is turned off when ON TIMER set time comes.

Changing of set time

Set a new time by using the SLEEP or ON TIMER button.

How to cancel

Press the CANCEL button to turn off the timer display.

PROGRAM TIMER operation

- The timer operations of the combination of ON and OFF TIMER. Once this has been set the timer operations will be repeated at the same time every day unless the ON/OFF button is pressed.

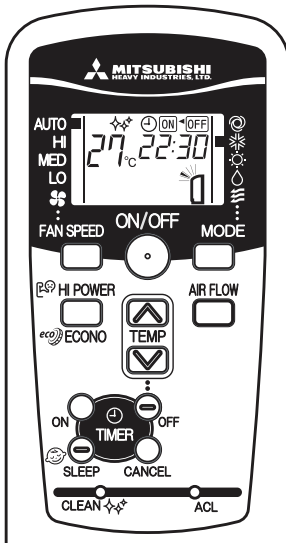

Example: When it is preferred to stop at 22:30, and then start operation at 8:00, near the set temperature.

■ OFF TIMER operation setting

Set by the procedures on page 12. Set to 22:30

■ ON TIMER operation setting

Set by the procedures on page 13. Set to 8:00

Timer light (yellow) on the unit will light when the setting is completed.

The set time will be displayed on the remote control unit. The display will change depending on the operational status.

With ON TIMER, the air conditioner starts running. Then, with OFF TIMER, the air conditioner stops running.

With OFF TIMER, the air conditioner stops running. Then, with ON TIMER, the air conditioner starts running.

Changing of set time

Set a new time by using the OFF TIMER or ON TIMER button.

How to cancel

Press the CANCEL button to turn off the timer display.

HIGH POWER/ECONOMY operation

If the air-conditioner is not operating, point the remote control toward the air conditioner, and

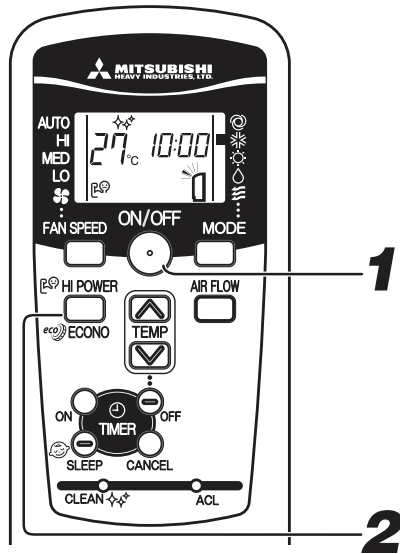

1

Press the ON/OFF button.

2

Press the HI POWER/ECONO button.

- When the operating mode is AUTO, COOL or HEAT
Every time the HI POWER/ECONO button is pressed, the display is switched in the order of:



- When the operating mode is DRY or PROGRAM TIMER
Every time the HI POWER/ECONO button is pressed, the display is switched in the order of:

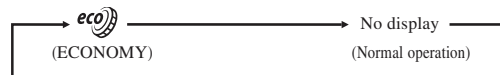

Concerning HIGH POWER operation

Pressing the HI POWER/ECONO button intensifies the operating power and initiates powerful cooling or heating operation for 15 minutes continuously. The remote control displays and the FAN SPEED display disappears.

NOTE

- During the HIGH POWER operation, the room temperature is not controlled. When it causes an excessive cooling or heating, press the HI POWER/ECONO button again to cancel the HIGH POWER operation.
- HIGH POWER operation is not available during the DRY, the program timer operations.
- When HIGH POWER operation is set after ON TIMER operation, HIGH POWER operation will start from the set time.
- When the following operations are set, HIGH POWER operation will be canceled.
 - When the HI POWER/ECONO button is pressed again.
 - When the operation mode is changed.
 - When it has been 15 min. since HIGH POWER operation has started.
- Not operable while the air conditioner is OFF.

Concerning ECONOMY operation

Pressing the HI POWER/ECONO button initiates a soft operation with the power suppressed in order to avoid an excessive cooling or heating. The unit operates 1.5°C higher than the setting temperature during cooling or 2.5°C lower than that during heating. The remote control displays and the FAN SPEED display disappears.

NOTE

- It will go into ECONOMY operation at the next time the air-conditioner runs in the following case.
 - When the air-conditioner is stopped by ON/OFF button during ECONOMY operation.
 - When the air-conditioner is stopped in SLEEP or OFF TIMER operation during ECONOMY operation.
- When the following operations are set, ECONOMY operation will be canceled.
 - When the HI POWER/ECONO button is pressed again.
 - When the operation mode is changed DRY to FAN.
- Not operable while the air conditioner is OFF.

SELF CLEAN operation

- CLEAN operation should be run after AUTO, COOL and DRY operation to remove the moisture from inside the indoor unit and control the growth of mold and bacteria.

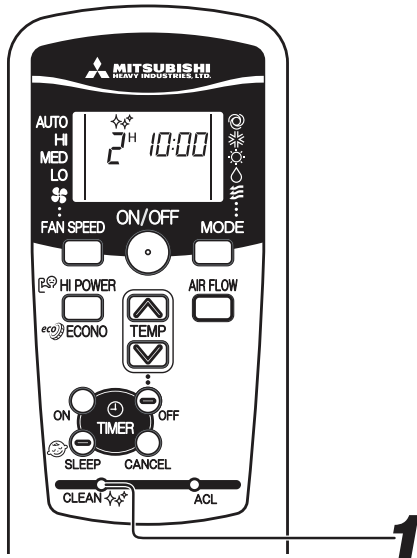

1 In order to active CLEAN operation, press the CLEAN switch with the tip of a ballpoint pen.

Every time the CLEAN switch is pressed, the display is switched in the order of:

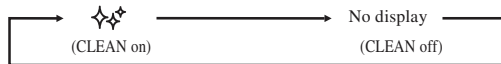

NOTE

- Two hours later, the air conditioner stops running automatically. To stop the air conditioner immediately, press the ON/OFF button.
- CLEAN operation is not operated after HEAT and FAN, OFF-TIMER, SLEEP operations have finished.
- The indoor unit fan runs for about two hours in CLEAN operation.
- The RUN light illuminates during CLEAN operation.

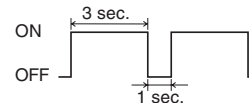

- Pressing the SLEEP button during CLEAN operation cancels the CLEAN operation and then the unit is set to SLEEP operation.
- This is not a function for removing mold, germs or grime that have already adhered to the unit.

Auto restart function

■ What is auto restart function?

- Auto restart function records the operational status of the air-conditioner immediately prior to be switched off by a power cut, and then automatically resumes operations after the power has been restored.
- The following settings will be cancelled:
 - ① Timer settings
 - ② HIGH POWER operations

NOTE

- Auto restart function is set at on when the air-conditioner is shipped from the factory. Consult with your dealer if this function needs to be switched off.
- When power failure occurs, the timer setting is cancelled. Once power is resumed, set the timer again.

Tips for effective operation

- Please observe the following for the most economic and comfortable use of your unit.

<p>Set a suitable room temperature.</p> <p>Excessively high or low temperatures are not good for your health and waste of electricity.</p>	<p>Clean the filters frequently.</p> <p>Clogged filters may block the airflow and cause less efficient operation.</p>	<p>Avoid direct sunlight and draught.</p> <p>Cut out direct sunlight by drawing the curtains or blinds when cooling. Keep windows and doors shut, except when ventilating.</p>
<p>Adjust the airflow direction properly.</p> <p>Adjust the up/down and left/right airflow to ensure a steady room temperature.</p>	<p>Operate the unit only when needed.</p> <p>Use the timer properly to operate the unit only when needed.</p>	<p>Keep heat source away when cooling.</p> <p>Keep heat sources out of the room as much as possible.</p>

Airoutlet selection

- AIR SELECTION button can switch between the combination of upper and lower air outlets and upper air outlet. Not operable while the air conditioner is OFF.

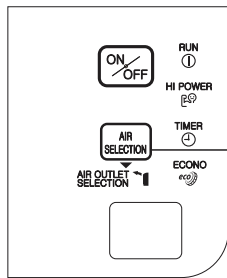
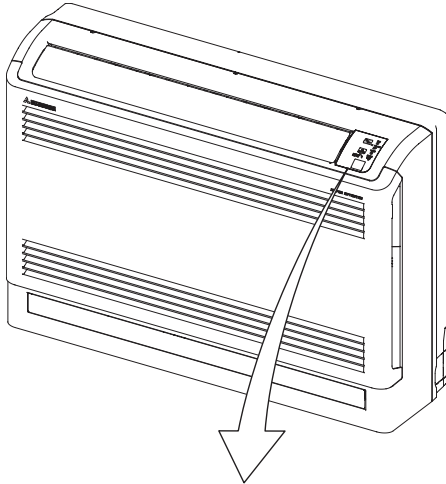

2

1

Press the ON/OFF button on the remote control.

2

Press the AIR SELECTION button on the unit display section.

Each time the AIR SELECTION button is pressed. The combination of the upper and lower air outlets and the upper air outlet can be switched. When the upper air outlet is selected, AIR OUTLET SELECTION light on the unit display area will light green.



Auto airoutlet selection

COOL, DRY operation

In case lower and upper outlets operation is selected in Cooling or Dry operation, both outlets will be kept for sixty minutes after the start or until room temperature is below the setting point. And then the air outlet will change to the upper outlet. That state will be maintained until switch is turned off.

In case both outlets operation with Auto fan speed mode is selected, the upper outlet will be kept for ten minutes after the start or until room temperature is close to reaching the setting point. And then the air outlet will change to both outlets in order to spread comfort air to every corner.

HEAT operation

In case both lower and upper outlets operation with Auto fan speed mode is selected, the lower outlet will be kept for twenty minutes after the start or until room temperature is close to reaching the setting point. And then the air outlet will change to both outlets. That state will be maintained until the switch is turned off.

Automatic adjustment of lower air outlet direction prevents stirring up of warm air and keeps optimum comfort at floor level.

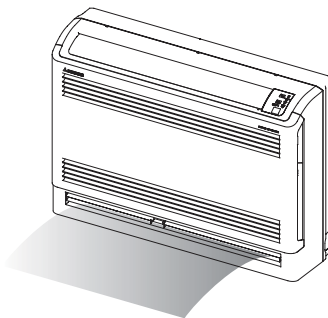
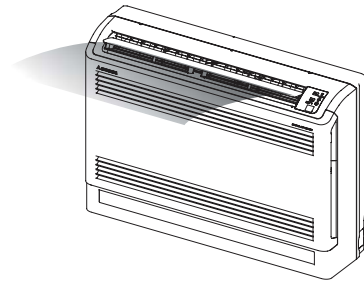

Maintenance

How to open, close the air inlet panel

Open

Place fingers at the recesses on both sides of the panel and pull down the panel forward so that it will be open by about 15 degrees.

Close

Push both ends evenly and press further lightly at the center.

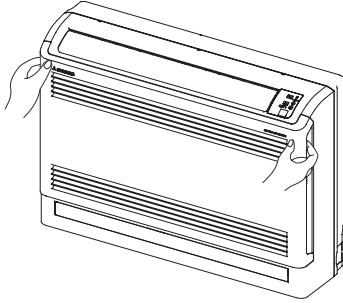

Removal, installation of air inlet panel

Removal

When removing the air inlet panel for internal cleaning or others, open the panel, remove the string and then pull it forward.

Installation

Secure the upper edge of the air inlet panel by lightly pushing it in, place the string as illustrated and then close the panel.

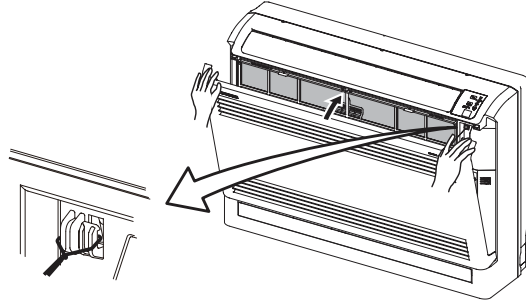

CAUTION

- Make sure not to drop the air inlet pane.

Before maintenance

Turn off the power supply.



• Do not spill any liquid.

There's a danger of electric shock.

Wipe the unit with a soft, dry cloth.



- Do not touch the aluminum fins on the heat exchanger.
- Stand firmly on a stepladder or other stable object when removing the inlet panel and filter.

Do not use the following articles:

- Hot water (40°C or more)
It may deform or discolour the unit.
- Petrol, paint thinner, benzine or cleanser, etc.
They may deform or scratch the unit.

During the operational season

Cleaning the air filter

Standard interval is once every two week

1 Remove the air filter

- Pull up the air inlet panel forward.
- Lightly hold the knobs at both sides and lift a little to remove the panel forward.

CAUTION

- Make sure not to drop the air inlet pane.

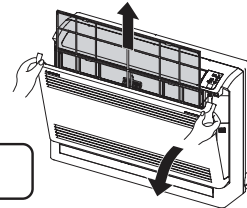

2 Cleaning

If the filter is very dirty, clean it with warm water (approx. 30°C), and dry it thoroughly.

CAUTION

- Do not clean the filters with boiling water.
- Do not dry them over an open flame.
- Pull them out gently.

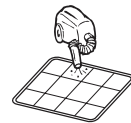

3 Reinstall the air filter

- Hold firmly the filter at both sides as shown at right and insert securely.
- Close the air inlet panel.

CAUTION

- Operating without putting back the air filters will make the unit dusty, and may cause damage.

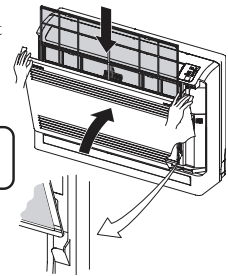

Cleaning the unit

- Wipe the unit with a soft, dry cloth, or use a vacuum cleaner.
- If the unit is very dirty, wipe it with a cloth soaked in warm water.

Cleaning the air inlet panel

- Removal, installation of air inlet panel.
- Wipe the panel with a soft,

CAUTION

- Do not wash the panel with water.

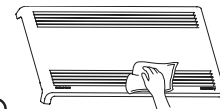



Cooling/heating is affected by an air filter clogged up with dust etc., and the operation noise becomes louder. It may also use extra electricity. Please clean the air filter at appropriate intervals.

At the end of the season

- 1** Perform the fan operation for a half day.
Dry the inside of the unit.
- 2** Stop the unit and turn off the power supply.
The unit consumes appr. 2W even when the unit is not operating. Turning off the power supply will help saving energy consumption and cost.
- 3** Clean and reinstall the air filters.
- 4** Clean both the indoor and outdoor units.
- 5** Remove batteries from the remote control.

At the beginning of the season

- 1** Make sure that there are no obstacles blocking the airflow around the air intake and outlet openings of the indoor and outdoor units.
- 2** Check if there is no corrosion or rust on the base frame of the outdoor unit.
- 3** Ensure that the earth wiring is not snapped nor disconnected.
- 4** Ensure that the air filters are clean.
- 5** Turn on the power supply.
- 6** Insert batteries in the remote control.

Installing, inspecting, and replacing the air-cleaning filter

1. Open the air inlet panel and remove the air filters. Page 18
2. Remove the filter holders, with the air-cleaning filter installed in the folders, from the air-conditioner.
3. Remove the photocatalytic washable deodorizing filter (orange) from the filter holder and inspect the filter. Periodically, remove any dust or dirt from the photocatalytic washable deodorizing filter. If the photocatalytic washable deodorizing filter is particularly dirt, it may be washed with water. However, the filter is fragile so be sure to wash it installed in the filter holder to avoid damaging it. After washing the filter, place it in sunlight to dry. Placing the filter in sunlight revitalizes the deodorizing effect.

Remove the natural enzyme filter (green) from the filter holder and inspect the filter. Use a vacuum cleaner to remove any dust or dirt from the natural enzyme filter. Replace the natural enzyme filter if it cannot be cleaned or if it has been used for about 1 year. (The natural enzyme filter should be replaced after about 1 year of use. However, the actual replacement period may vary depending on the conditions in which the filter is used.)

(Do not dispose of the filter holders. They are reused.)
4. Install the air-cleaning filter in the filter holders, and then install the filter holders in the air-conditioner.

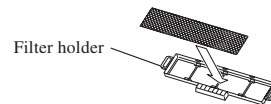
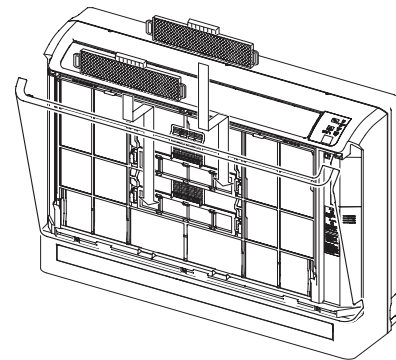

- NOTE**

 - The natural enzyme filter and the photocatalytic washable deodorizing filter may be installed on either the upper or lower side of the air-conditioner.
 - Place the natural enzyme filter with the green side front.

5. Install the air filters and closed the air inlet panel. Page 18
- CAUTION**

 - Do not expose natural enzyme filters to direct sunlight for an extended period. The bacteriolytic effect will be lost.
 - When installing an air-cleaning filter in the indoor unit, be careful not to injure your hand with the heat exchanger.

For replacement the air-cleaning filter, contact your dealer.

Item	Feature	Color
Photocatalytic washable deodorizing filter	Sources of odors on the filter are broken up, resulting in a deodorizing effect.	Orange
Natural enzyme filter	By using the work of enzyme, mold and bacteria on the filter are destroyed and the room air is kept clean.	Green

Proper installation

Suitable installation position

- Do not put any obstruction in front of the indoor unit, preventing proper ventilation and functioning.
- Do not install the unit in any of the following places:
 - Where there is a danger of leaking flammable gases.
 - Where there is substantial splashing of oil.
- Malfunctioning due to corrosion may occur if the unit is installed in a spa where sulfide gases are generated, or in a seaside resort exposed to sea breezes. Contact your dealer.
- The air-conditioner and remote control must be at least 1 metre away from a TV set or radio.
- Drain the dehumidified liquid from the indoor unit into a spot that drains well.

Pay attention to operating noises!

- When you install the unit, take care to choose a place that can comfortably stand the weight of the unit and does not increase the operating noise or vibration. If vibration is transmitted through the house, fix the unit with the aid of vibration-proof pads between the unit and the fittings.
- Select a place where cold or hot air, operation noises from the indoor and outdoor units do not cause any inconvenience to your neighbours.
- Do not leave any obstacles near the outlet and inlet of the outdoor unit. This may cause malfunctioning and increased operating noise.
- If you hear an irregular noise during operation, contact your dealer.



Inspection and maintenance

Depending on operating environment, the inside of the air-conditioner may become dirty after a few year operations. This will reduce performance. In addition to normal cleaning, we would recommend inspection and maintenance. (This may lead the air-conditioner to having a longer life without any trouble.)

- Contact your dealer, or any distributor, for inspection and maintenance. (There will be a charge for this service).
- We would recommend inspection and maintenance to be carried out during the off-season.
- If the supply cord of this appliance is damaged, it must only be replaced by a repair shop appointed by the manufacturer, because special purpose tools are required.



Troubleshooting

Please carry out the following checks before making a service call.

The air-conditioner does not work at all.		
Has the power switch been turned off? 	Has the timer been set in the "ON" position? 	Is there a power failure or a blown fuse? 

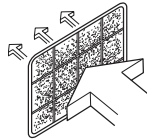
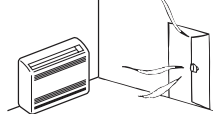

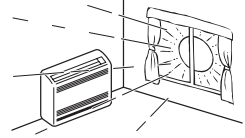
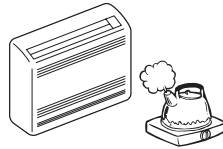
If the air-conditioner does not operate properly after you have checked the left points, or if any doubt still exists after you have consulted page 21, or if things happen as shown on page 22, switch off the power and contact your dealer.

Poor cooling or heating		
Have you set the thermostat at a suitable temperature? suitable temperature 	Is the air filter clean? (Not clogged?) 	Did you leave any doors or windows open? 

Poor cooling		
Is there any direct sunlight entering the room? 	Is there a heat source in the room? 	Are there too many people in the room? 

An alternative refrigerant (R410A) is used in this air-conditioner. When asking your dealer for service or inspection and maintenance, explain the dealer about it.

Notice

<p>The unit does not restart immediately after you have stopped it.</p> <p>(RUN light is on)</p> <p>Not operating?</p> 	<p>Restart is blocked for 3 minutes after you have stopped the operation to protect the unit.</p> <p>Please wait for three minutes.</p>  <p>The three-minute protection timer in the microcomputer automatically starts it up again.</p>
<p>Airflow is not blown out when starting the HEATING operation.</p> <p>RUN light blinks slowly (1.5 sec ON, 0.5 sec OFF)</p>	<p>Airflow has stopped to prevent blowing out of cold air until the indoor heat exchanger has warmed up. (2 to 5 min.) (HOT KEEP program)</p>
<p>Airflow is not blown out for 5 to 10 min. or blown out not warm wind for a moment at HEATING operation.</p> <p>RUN light blinks slowly (1.5 sec ON, 0.5 sec OFF)</p>	<p>When outdoor temperature is low and humidity is high, the unit sometimes performs defrosting automatically. Please wait. During defrosting, water or steam may escape from the outdoor unit.</p>
<p>Airflow is not blown out when starting the DRY operation.</p> <p>(RUN light is on)</p>	<p>The indoor fan may stop to prevent re-evaporation of dehumidified moisture and to save energy.</p>
<p>Some steam escapes during COOL operation.</p>	<p>This may occur if the room's temperature and humidity are very high. It disappears as soon as the temperature and humidity decrease.</p>
<p>There is a slight smell.</p>	<p>Air blown out during operation may smell. This is caused by tobacco or cosmetics adhering to the unit.</p>
<p>You hear a slight gurgling sound.</p> 	<p>This is caused by refrigerating liquid moving within the unit.</p>
<p>You hear a slight cracking sound.</p>	<p>This is caused by heat expansion or contraction.</p>
<p>You hear a hissing or clicking sound.</p>	<p>This is caused by the operation of the refrigerant control valves or electric components.</p>
<p>After a power cut, the unit does not restart even if power has been restored.</p>	<p>If the auto restart function is not set, the unit will not restart automatically. Use the remote control to start the operation again.</p>
<p>Remote control signals are not received.</p>	<p>Remote control signals may not be received if the signal receiver on the air-conditioner is exposed to direct sunlight or other bright light. If so, cut out the sunlight or reduce the other light.</p>
<p>Moisture may form on the air outlet grills.</p>	<p>If the unit is operated for a long time in high humidity, moisture may form on the air outlet grills and start dripping.</p>
<p>Whistling noise is heard from the outdoor unit.</p>	<p>The noise means that the revolution speed of the compressor is increasing or decreasing.</p>
<p>Fan won't stop immediately after unit operation was stopped.</p>	<p>Indoor fan : Fan will not stop after 2 hours if set to CLEAN operation. Outdoor fan : Fan will not stop about a 1 minute period in order to protect the unit.</p>
<p>RUN light stays on even though operation was stopped.</p>	<p>The RUN light illuminates during CLEAN operation. Run light turns off when CLEAN operation ends.</p>
<p>Sometimes a "Shooooo" sound might come for a short time from the unit that is turned off.</p>	<p>This is the sound when operation of another indoor unit is stopped.</p>

Contact your dealer

■ Turn off the power switch immediately and inform your dealer in any of the following situations:

The fuse or switch blows continuously.



The cable becomes extremely hot.
The covering of the cable is cracked.

⚠ CAUTION

If the power cord becomes damaged, ask your dealer or a qualified engineer to install the replacement to avoid accidents.

The TV, radio or other equipment starts to malfunction.

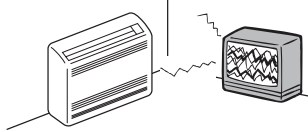

A switch does not activate properly.

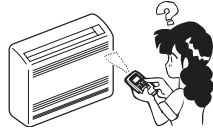

You hear a strange noise during operation.

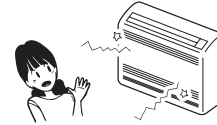

When the foreign matters enter the indoor unit through the air outlets and the dumper becomes inoperable, call your dealer.

The RUN and TIMER lights on the unit display section blink quickly (0.5 sec. ON; 0.5 sec. OFF) and do not work.

When abnormalities occur, turn off the power supply immediately and turn it on after 3 minutes.
Restart the operation with ON/OFF button of the remote control and the abnormalities still continue.

About the Multiple Air-conditioner

Simultaneous Operation

- The air-conditioners cannot be in different operating modes at the same time, such as one unit being in the "Cool" mode and one unit being in the "Heat" mode.
- When conducting different operations, the air-conditioner that was operated first will be given priority, so the air-conditioner that is operated after that will conduct air blowing operation.
- When you want to give priority to the air-conditioner that was started later, either stop the air-conditioner that has priority or cause the operation type of the unit operated first to match that of the unit operated second.

Automatic Operation

- When the remote control operation switch is in the "Auto" mode the air-conditioner automatically selects either "Cool," "Dry," or "Heat" when operation is started depending on the room temperature.
- During simultaneous operation of air-conditioner units, operation modes may be automatically changed in response to the temperatures of the individual rooms; this will result in the operation of the outdoor unit being stopped. In such a case, COOL or HEAT mode should be used instead of AUTO. (This is only relevant when more than one air-conditioner unit is being used.)

Refrigerant (oil) recovery operation

- If the all of the indoor units are not operated at the same time for an extended period, the cooling or heating performance may temporarily decrease. This is in order to control the recovery of the refrigerant (oil) in the stopped indoor unit(s). At this time, the sound of refrigerant flowing may be heard from the stopped indoor unit(s).

Self diagnosis function

■ We are constantly trying to do better service to our customers by installing such judges that show abnormality of each function as follows:

