

SHARE OUR PASSION.™

2007

Snowmobile Operator's Manual



ARCTIC CAT®

p/n 2257-617

LIMITED WARRANTY

Arctic Cat Inc. (hereinafter referred to as Arctic Cat) extends a limited warranty on each new Arctic Cat Snowmobile it manufactures and on each part and accessory manufactured or sold by Arctic Cat. The warranty is extended to the original retail purchaser only on parts and accessories sold through an authorized Arctic Cat Snowmobile dealer. Warranty on snowmobiles is extended to the original retail purchaser; however, the balance of the unused warranty may be transferred to a second party.

Arctic Cat warrants only the products it manufactures and/or sells and does not warrant that other products will function properly when used with an Arctic Cat Snowmobile or will not damage the Arctic Cat Snowmobile. Arctic Cat does not assume any liability for incidental or consequential damages.

Arctic Cat will repair or replace, at its option, free of charge (including any related labor charges), any parts that are found to be warrantable in material or workmanship. This repair work MUST be done by an authorized Arctic Cat Snowmobile dealer. No transportation charges, rental charges, or inconvenience costs will be paid by Arctic Cat. The warranty is validated upon examination of said parts by Arctic Cat or an authorized Arctic Cat Snowmobile dealer. Arctic Cat reserves the right to inspect such parts at its factory for final determination if warranty should apply.

The warranty periods are as follows:

1. For snowmobiles used for recreational purposes:
 - If purchased between May 1 and November 30, warranty expires ONE (1) YEAR from December 1 of the current year.
 - If purchased between December 1 and April 30, ONE (1) YEAR from the date of sale.
2. For snowmobiles used for commercial purposes (including rental operations), ONE (1) YEAR from the date of sale.
3. SIX (6) MONTHS from date of sale for batteries on a full exchange basis and 50% exchange for the remaining SIX (6) MONTHS of the first year.
4. THIRTY (30) DAYS from date of sale for all dealer installed service parts and accessories.
5. UNTIL EXPIRATION OF THE NEW PRODUCT WARRANTY for all eligible replacement parts.

Exclusions to this warranty include normal wear, abuse (i.e. a track run on marginal snow conditions without proper lubrication or additional idler wheels), and the following parts:

Fuel Filter	Light Bulbs	Windshield	Drive Clutch/Driven Pulley Wear Parts
Drive Belt	Wear Bars	Water Pump Belt	Brake Pads
Wear Strips	Fan Belt	Spark Plugs	Torn or Punctured Upholstery

The following will VOID Arctic Cat's warranty:

1. Failure to perform the proper break-in procedure and all operator related maintenance, storage procedures, and service as recommended in the Operator's Manual.
2. Repairs and/or adjustments by anyone other than an authorized Arctic Cat Snowmobile dealer.
3. Use of an improper fuel mixture ratio.
4. Use of improper carburetor main jets.
5. Use of improper gasoline, lubricating oils, or spark plugs.
6. An accident or subjecting the snowmobile to misuse, abuse, or negligent operation.
7. Any modification or removal of parts (i.e. air-intake silencer, muffler, etc.) unless instructed to do so by Arctic Cat.
8. Use of the snowmobile in any way for racing purposes.
9. Removal of the engine for use in another vehicle.
10. Removal or mutilation of the Vehicle Identification Number or Engine Serial Number.
11. Use of parts not sold or approved by Arctic Cat.
12. Track and tunnel damage resulting from either ice stud or hooker plate installation.
13. Damage due to improper transportation.

In consideration of the foregoing, any implied warranty is limited in duration to the various warranty periods set forth. This warranty gives you specific legal rights, and you may also have other rights which vary from state to state and country to country. Some states do not allow limitations on how long an implied warranty lasts, so the above limitations may not apply to you.

Table of Contents

Limited Warranty.....	Inside Front Cover	Removable/Adjustable Seat (F-Series/Jaguar Z1).....	27
Foreword.....	1	Arctic Power Valve (APV) System.....	28
Declaration of Conformity.....	2	Exhaust Controlled Timing (ECT) System (600/800/1000 cc).....	29
Snowmobile Safety Rules.....	3	Operating Instructions.....	31-39
General Information.....	4-30	Starting and Stopping Engine.....	31
Snowmobile Identification.....	4	High RPM Operation (660 cc Models).....	35
Control Locations.....	4	Braking (Hydraulic Brake Models).....	35
Tipped Snowmobile.....	7	Emergency Stopping.....	36
Gasoline-Oil.....	8	Throttle/Ignition Monitor Switch (2-Stroke/Jaguar Z1 Models).....	37
Engine Break-In (2-Stroke Models).....	10	Varying Altitude Operation.....	39
Engine Break-In (660 cc/1100 cc Z1 Models).....	10	Lubrication.....	40-45
Indicator Lights (Carbureted Models/ Bearcat W/T Non-Turbo/ Panther 660).....	11	Standard Chain Case.....	40
Low Oil Warning Light (Standard 2-Stroke Models).....	11	ACT Drive Gear Case.....	41
Low Oil Pressure Warning Light (Bearcat W/T Non-Turbo/ Panther 660 Models).....	11	Front Suspension.....	43
Coolant Temperature Warning Light (Carbureted Models/ Bearcat W/T Non-Turbo/ Panther 660).....	12	Speedometer Drive Adapter.....	44
Charging System Warning Light (660 cc Models).....	12	Rear Suspension.....	45
Check Engine Light (Bearcat W/T Non-Turbo/Panther 660 Models).....	12	Maintenance.....	46-93
Speedometer/Tachometer Indicator Lights (Crossfire/F-Series/Jaguar Z1/ M-Series/660 cc Turbo Models).....	12	Periodic Maintenance Checklist.....	46
Diagnostic Codes/Check Engine (2-Stroke Models).....	15	Fuel System.....	47
Diagnostic Codes/Check Engine (Jaguar Z1).....	16	Checking Engine Oil Level (660 cc Models).....	48
Handlebar Tilt.....	17	Checking Engine Oil Level (Jaguar Z1).....	49
Handlebar Tilt (F-Series - STD).....	17	Changing Engine Oil (660 cc Models).....	49
Handlebar Tilt (F-Series LXR/Sno Pro/ Jaguar Z1).....	18	Changing Engine Oil/Filter (Jaguar Z1).....	50
Exhaust System.....	19	Adjusting Carburetor (Single).....	52
Air-Intake Silencer.....	19	Adjusting Carburetors (Twin).....	54
Battery (Electric Start Models).....	19	Selecting Carburetor Main Jet(s).....	58
Cooling System (Liquid).....	20	Spark Plugs (1100 cc Z1).....	59
Drive Clutch and Driven Pulley.....	20	Spark Plugs.....	59
Drive Clutch/Driven Pulley Alignment.....	21	Checking/Adjusting Valve Clearance (660 cc/1100 cc Z1).....	62
Drive Chain Tension.....	21	Charging Battery (Electric Start Models).....	62
Fuel Pump.....	22	Fuses (660 cc Models).....	64
Gas Tank Shut-Off Valve.....	22	Fuses (1100 cc Z1).....	65
Shock Absorbers (Standard Gas).....	22	Engine Heater (660 cc Models).....	66
Shock Absorbers (Rebuildable Gas).....	22	Mechanical Brake System.....	66
Deep-Lug Track.....	23	Hydraulic Brake System.....	68
Hacksaw Track.....	23	Drive Belt.....	72
Track Studs.....	23	Track Tension.....	76
Reverse Transmission.....	24	Track Alignment.....	78
Reverse Transmission (Crossfire/ F-Series/Jaguar Z1/ M-Series Models).....	25	Suspension.....	79
Towing.....	26	Lights.....	83
Adjustable Backrest.....	26	Ski Wear Bars.....	89
Removable Rear Seat.....	26	Adjusting Ski Stance(M-Series/ Bearcat 570 Models).....	90
Removable Seat (Crossfire/M-Series Models).....	27	Rail Wear Strips.....	91
		Axial Fan Belt (370 cc Models).....	91
		Accessory Belt (660 cc Models).....	92
		Performance Tips.....	94
		Preparation For Storage.....	95-97
		Preparation After Storage.....	98-99
		U.S. EPA Emission Control Statement/Warranty Coverage.....	100
		Change of Address, Ownership, or Warranty Transfer.....	101
		Warranty Procedure/ Owner Responsibility.....	Inside Back Cover

REFERENCE INFORMATION

Write the appropriate information for your Arctic Cat Snowmobile in the spaces below.

Always use these numbers when referring to your snowmobile.

Model: _____

Date of Purchase: _____

Vehicle Identification Number: _____

Engine Serial Number: _____

Your Arctic Cat Dealer: _____

Address: _____

Phone: _____

WARNING

A snowmobile is a very high performance vehicle. Because it does accelerate rapidly and is capable of very high speeds, it should not be operated by a novice or an inexperienced operator. Never accelerate rapidly or drive at high speed beyond the limits of visibility or without being totally familiar with the terrain and what lies in front of you. Obey speed limits and never operate at speeds that do not allow adequate maneuvering and stopping distances. Read and study the entire Operator's Manual and Safety Handbook.

Failure to follow this warning could result in personal injury to yourself or others.

PERSONAL INJURY



- To avoid injury to yourself and others, NEVER operate the snowmobile without first reading and understanding this manual and the Snowmobile Safety Handbook; then follow the instructions and heed the warnings given.
- USE COMMON SENSE.
- DON'T DRINK and DRIVE.
- STAY IN CONTROL at ALL TIMES.
- TELL YOUR FRIENDS. If you see a friend operating a snowmobile recklessly, at excessive speeds, while intoxicated, or in other unsafe ways, don't wait until it is too late to warn of the consequences of snowmobile misuse. Such conduct endangers everyone. TAKE AN ACTIVE ROLE IN THE SAFETY OF YOURSELF AND OTHERS.

PARTS AND ACCESSORIES

When in need of replacement parts, oil, or accessories for your Arctic Cat Snowmobile, be sure to only use GENUINE ARCTIC CAT PARTS, OIL, AND ACCESSORIES. Only genuine Arctic Cat parts, oil, and accessories are engineered to meet the standards and requirements of your Arctic Cat Snowmobile. For a complete list of accessories, refer to the current Arctic Cat Accessory Catalog. An Illustrated Parts Manual is available through your local Arctic Cat Snowmobile dealer.

FOREWORD

Congratulations! You have chosen a quality Arctic Cat Snowmobile designed and manufactured to give dependable service. Be sure, as the owner/operator of an Arctic Cat Snowmobile, to become thoroughly familiar with its basic operation, maintenance, and off-season storage procedures. Read this manual and the accompanying Snowmobile Safety Handbook before operating the snowmobile to learn safe and proper use of your new Arctic Cat Snowmobile. Always operate the snowmobile within your level of skill and current terrain conditions.

The Operator's Manual, Snowmobile Safety Handbook, and Snowmobile Decals display the words Warning, Caution, and Note to emphasize important information. The symbol  **WARNING** identifies personal safety-related information. Be sure to follow the directive because it deals with the possibility of severe personal injury or even death. The symbol  **CAUTION** identifies unsafe practices which may result in snowmobile-related damage. Follow the directive because it deals with the possibility of damaging part or parts of the snowmobile. The symbol  **NOTE:** identifies supplementary information worthy of particular attention.

This manual covers operator-related maintenance, operating instructions, and off-season storage instructions. If major repair or service is ever required, contact an authorized Arctic Cat Snowmobile dealer for professional service.

At the time of publication, all information and illustrations were technically correct. Some illustrations used in this manual are used for clarity purposes only and are not designed to depict actual conditions. Because Arctic Cat Inc. constantly refines and improves its products, no retroactive obligation is incurred.

This Operator's Manual should be considered a permanent part of the snowmobile and must remain with the snowmobile at the time of resale. If the snowmobile changes ownership more than once, contact Arctic Cat Inc., Service Department, P.O. Box 810, Thief River Falls, MN 56701, for proper registration information. This manual was prepared by the Product Service and Warranty Department of Arctic Cat Inc.

Every Arctic Cat Snowmobile meets or exceeds the standards of the Snowmobile Safety and Certification Committee and displays the SSCC decal. Arctic Cat Inc. endorses and encourages the safe use of all snowmobiles. Always wear a helmet and eye protection. Drive with caution, observe all state and local regulations, and respect the rights of others. ISMA members like Arctic Cat do their part to improve trails, sponsor events, and generally support the sport of snowmobiling. As a member of the National Snowmobile Foundation, Arctic Cat Inc. promotes snowmobiling through education, charity, and research programs.

© 2006 Arctic Cat Inc.

Printed in U.S.A.

DECLARATION OF CONFORMITY

Application of council directives:

EMC Directive 89/336/EEC

EC Machinery Directive 98/37/EC

Issued by European Commission.

Type of Equipment: Snowmobile

Brand Name: Arctic Cat

Model Numbers:

S2007ACAAAUSG	S2007CFH36USO	S2007M1LEKUSO	S2007F8HTSUSO
S2007ACAAAUSO	S2007CFHSPUSO	S2007M1LSPUSO	S2007F1LEFUSB
S2007ZAAFCUSO	S2007CFL36USB	S2007M1LPRUSO	S2007F1LEFUSG
S2007ZAALXUSO	S2007CFL36USG	S2007F5CEFUSB	S2007F1LEFUSO
S2007ZADFCUSO	S2007CFL36USO	S2007F5CEFUSG	S2007F1LLXUSB
S2007ZADLXUSO	S2007CFLSPUSO	S2007F5CEFUSO	S2007F1LLXUSG
S2007BCDLTUSL	S2007M6D1EUSB	S2007F5CLXUSB	S2007F1LLXUSO
S2007BCFWTUSL	S2007M6D1EUSG	S2007F5CLXUSG	S2007F1LEPUSB
S2007BCFTWUSL	S2007M6D1EUSO	S2007F5CLXUSO	S2007F1LEPUSG
S2007BCFAWUSL	S2007M6D3EUSB	S2007F6DEFUSB	S2007F1LEPUSO
S2007PAAFCUSB	S2007M6D3EUSG	S2007F6DEFUSG	S2007BCDLTOSL
S2007PADFCUSB	S2007M6D3EUSO	S2007F6DEFUSO	S2007BCFWTOSL
S2007PAFTOUSB	S2007M8H1EUSB	S2007F6DLXUSB	S20077BCFTWOSL
S2007PAFLCUSB	S2007M8H1EUSG	S2007F6DLXUSG	S2007PAAFCOSB
S2007ACFTTUSB	S2007M8H1EUSO	S2007F6DLXUSO	S2007PADFCOSB
S2007ACFTLUSG	S2007MBH3EUSB	S2007F6DEPUSB	S2007PAFTOOSB
S2007ACFTBUSG	S2007M8H3EUSG	S2007F6DEPUSG	S2007ACFTLOSG
S2007ACFTRUSG	S2007M8H3EUSO	S2007F6DEPUSO	S2007CFC36OSB
S2007Z1NJGUSB	S2007M8HEKUSB	S2007F8HEFUSB	S2007CFHSPOSO
S2007Z1NJGUSG	S2007M8HEKUSG	S2007F8HEFUSG	S2007CFLSPOSO
S2007Z1NJGUSR	S2007M8HEKUSO	S2007F8HEFUSO	S2007F5CLXOSG
S2007CFC36USB	S2007M8HSPUSO	S2007F8HLXUSB	S2007F6DEPOSG
S2007CFD36USB	S2007M1L3EUSB	S2007F8HLXUSG	S2007F8HEPOSO
S2007CFD36USG	S2007M1L3EUSG	S2007F8HLXUSO	S2007F1LEPOSB
S2007CFD36USO	S2007M1L3EUSO	S2007F8HEPUSB	S2007Z1NJGOSR
S2007CFH36USB	S2007M1LEKUSB	S2007F8HEPUSG	
S2007CFH36USG	S2007M1LEKUSG	S2007F8HEPUSO	

Standards to which conformity is declared:

EMC: EN 50082-1/ 1992, EN 50081-1

MACHINERY: EN 292-1, EN 292-2, EN 953, EN 1050, EN 954-1

Manufacturer (if not issuing agent):

Arctic Cat Inc.

601 Brooks Ave. S.

Thief River Falls, MN

56701 USA

I, the undersigned, hereby declare that the equipment specified above conforms to the directive(s) and standard(s) as specified.

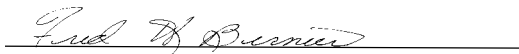

Fred Bernier

Manager, Product Testing & Certification

GENERAL INFORMATION

SNOWMOBILE IDENTIFICATION

The Arctic Cat Snowmobile has two important identification numbers. The Vehicle Identification Number (VIN) is stamped into the tunnel near the right-side footrest. The Engine Serial Number (ESN) is stamped into the crankcase of the engine.

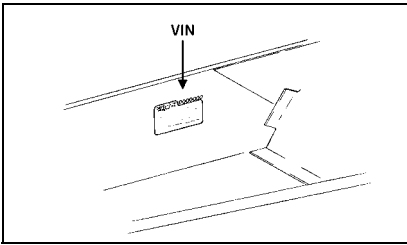

0726-383

These numbers are required by the dealer to complete warranty claims properly. No warranty will be allowed by Arctic Cat Inc. if the engine serial number or VIN is removed or mutilated in any way.

Always provide the snowmobile name, VIN, and ESN when contacting an authorized Arctic Cat Snowmobile dealer for parts, service, accessories, or warranty. If the complete engine must be replaced, ask the dealer to notify Arctic Cat for correct registration information.

CONTROL LOCATIONS

Shown are the typical control locations for Arctic Cat snowmobiles. Location of a specific control will vary according to model.

Panther 370 Model

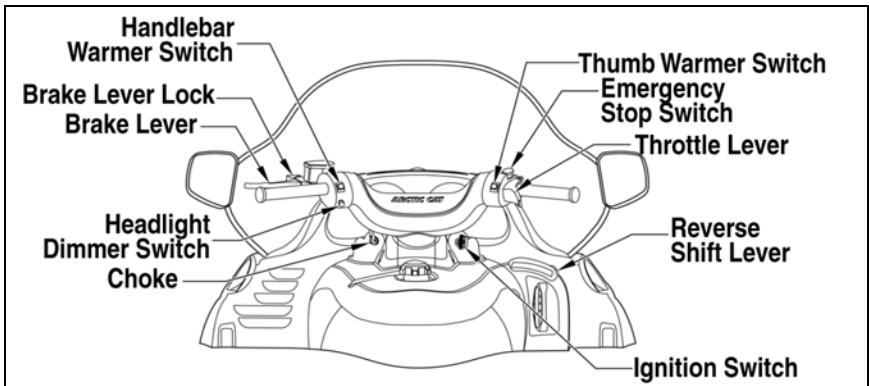

739-592D

Z Models

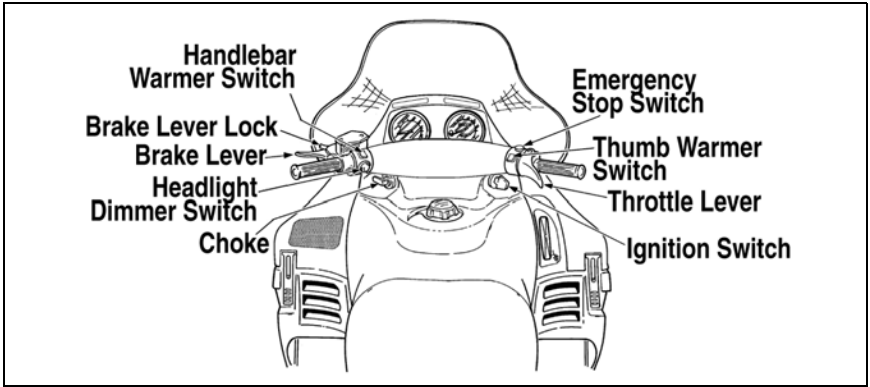

734-268A

F-Series/Jaguar Z1 Models

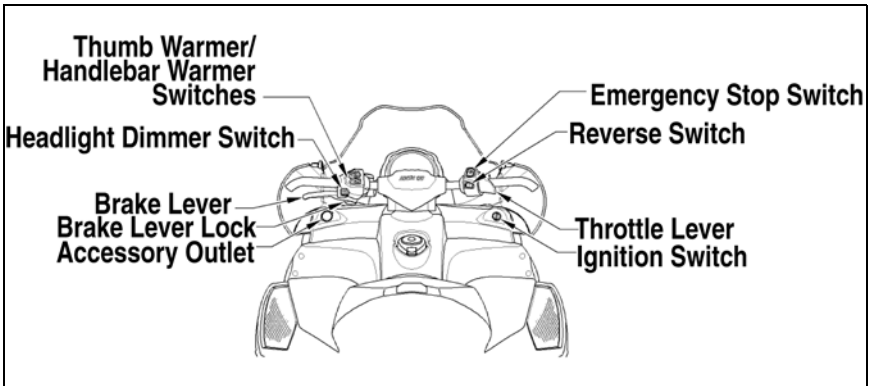

741-375B

Crossfire/M-Series Models

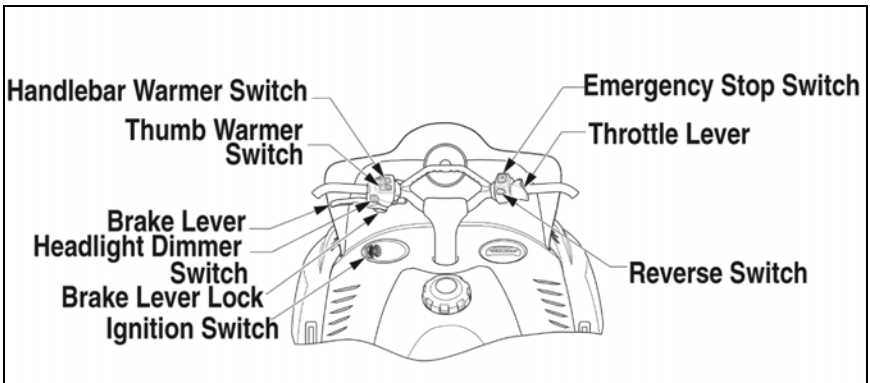

741-633A

T660/Bearcat Wide Track Models

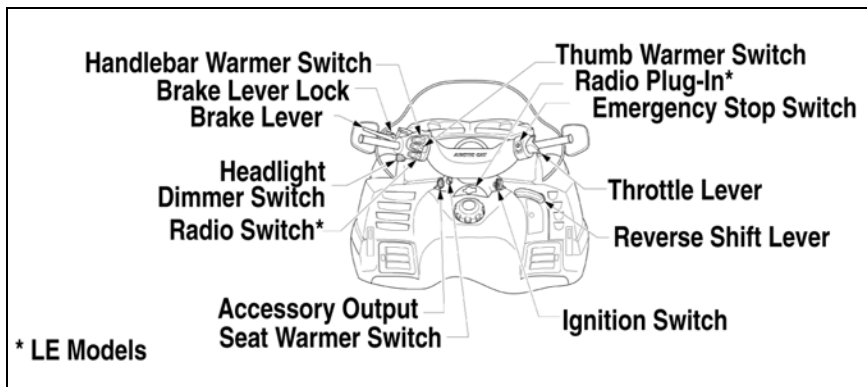

741-632A

Bearcat 570 Model

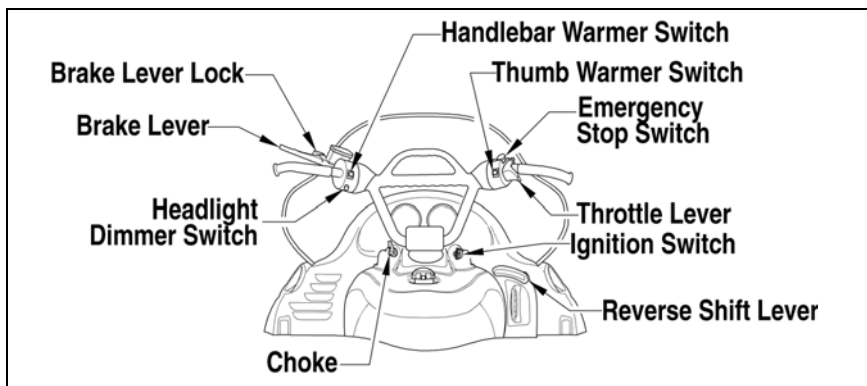

740-586A

Panther 570/660 Models

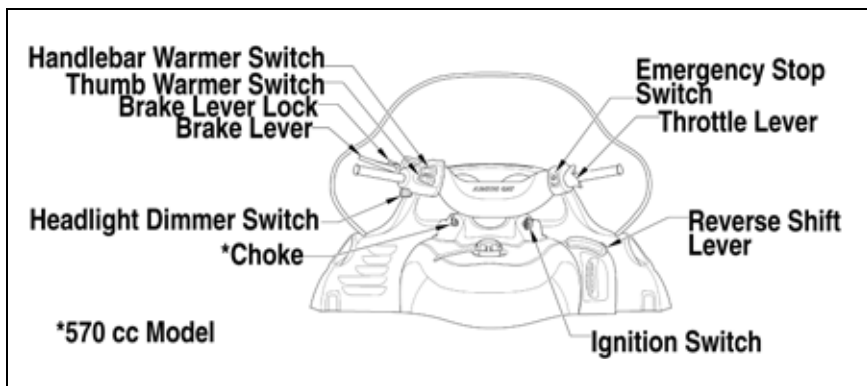

741-634A

TIPPED SNOWMOBILE

Tipping a snowmobile on its side is sometimes desirable for maintenance purposes; however, on a 660 cc model, Arctic Cat recommends **NOT TIPPING IT ON ITS SIDE IN EXCESS OF A 70° ANGLE**.

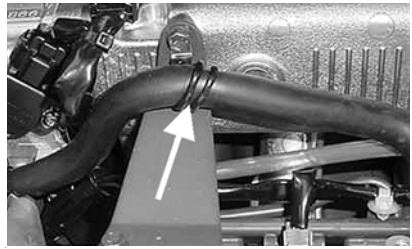

AO224B

CAUTION

The 660 cc models should not be tipped on their sides in excess of a 70° angle for any reason, as engine oil may seep into the upper engine through the air-intake system. Severe engine damage could result if the engine is run with oil in the upper engine.

If a 660 cc model is tipped on its side in excess of a 70° angle or if it has been upside down at all, return the snowmobile to the upright position and use the following procedure:

1. With the ignition switch in the OFF position, remove the engine to air-intake silencer hose at the engine. If oil is present, proceed to step 2. If no oil is present, install the hose and start the engine.

CAUTION

Care must be taken when installing the hose that it does not sag below the entrance/exit ends. If there is a “valley” in the hose, freezing may occur.

2. Remove the air-intake silencer from the engine. If oil is present in the air-intake silencer, proceed to step 3. If no oil is present, install the air-intake silencer and the engine to air-intake silencer hose; then start the engine.

■ **NOTE:** Prior to doing step 3, clean the air silencer thoroughly.

3. Remove the spark plugs from the engine and cover the spark plug holes with a rag (see Spark Plugs in this manual). With the emergency stop button in the down (OFF) position, turn the ignition switch to the START position.
4. Allow the engine to turn over for approximately 10 seconds. If oil was noted coming from the spark plug holes during this procedure, repeat the process until all oil has been discharged from the cylinders.
5. Install the spark plugs, spark plug wires, air-intake silencer, and the engine to air-intake silencer hose.

■ **NOTE:** The engine should now be safe to operate.

GASOLINE-OIL

Recommended Gasoline (Carbureted Models)

The recommended gasoline to use in these snowmobiles is 87 minimum octane regular unleaded. In many areas, oxygenates (either ethanol or MTBE) are added to the gasoline. Oxygenated gasolines containing up to 10% ethanol or up to 15% MTBE are acceptable gasolines; however, whenever using oxygenated gasolines, the carburetor main jet must be one size larger than the main jet required for regular unleaded gasoline. For example, if a 400 main jet is recommended for regular unleaded gasoline, a 410 main jet must be installed if using an oxygenated gasoline.

When using ethanol blended gasoline, it is not necessary to add a gasoline antifreeze since ethanol will prevent the accumulation of moisture in the fuel system.

CAUTION

Do not use white gas or gasolines containing methanol. Only Arctic Cat approved gasoline additives should be used.

Recommended Gasoline (EFI Models)

The recommended gasoline to use in these snowmobiles is 87 minimum octane regular unleaded. In many areas, oxygenates (either ethanol or MTBE) are added to the gasoline.

Oxygenated gasolines containing up to 10% ethanol or up to 15% MTBE are acceptable gasoline. Do not use gasolines containing methanol.

CAUTION

Do not use white gas or gasoline containing methanol. Only Arctic Cat approved gasoline additives should be used.

Recommended Injection Oil

The recommended oil to use in the oil-injection system is Arctic Cat 50:1 Injection Oil (for standard models) or Arctic Cat Synthetic APV 2-Cycle Oil (for APV models). These oils are specially formulated to be used either as an injection oil or as a pre-mix oil (for break-in) and meets all of the lubrication requirements of the Arctic Cat snowmobile engine.

CAUTION

Any oil used in place of the recommended oil could cause serious engine damage.

Recommended Engine Oil (660 cc STD)

■ **NOTE:** See the accompanying Specifications sheet for specific details on recommended engine oil.

The recommended oil to use is a multi-grade oil calibrated to the ambient temperature at which the engine is run. See the viscosity chart for details.

CAUTION

Any oil used in place of the recommended oil may cause serious damage.

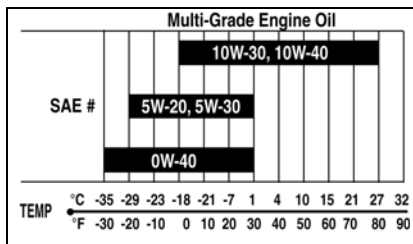

OILCHARTD

After the engine break-in period, the engine oil should be changed every 2500-3000 miles on standard 660 cc models.

Recommended Engine Oil (660 cc Turbo/ 1100 cc Z1)

The recommended oil to use is Synthetic Turbo 0W-40 Oil (p/n 3639-510).

After the engine break-in period, the engine oil should be changed every 2500-3000 miles on the 1100 cc Z1 model and every 2000 miles on 660 cc Turbo models and before prolonged storage.

Filling Gas Tank

Since gasoline expands as its temperature increases, the gas tank must be filled to its rated capacity only. Expansion room must be maintained in the tank particularly if the tank is filled with cold gasoline and then moved to a warm area.

Also, if the snowmobile is to remain on a trailer after filling the gas tank, the bed of the trailer must be maintained level to prevent gasoline from draining out through the gas tank vent hose.

WARNING

Always fill the gas tank in a well-ventilated area. Never add gasoline to the snowmobile gas tank near any open flames or with the engine running. **DO NOT SMOKE** while filling the gas tank. Do not sit on the snowmobile without first installing the gas tank cap.

Break-In Gas/Oil Mixing Instructions (2-Stroke Models)

Before mixing gasoline and oil, make sure the oil is at room temperature (20° C/68° F). Use a U.L. approved 22.7 l (6 U.S. gal.) gasoline container for mixing the gasoline and oil. To properly mix the fuel at a 100:1 ratio, use the following procedure:

CAUTION

Never mix oil and gasoline in the snowmobile gas tank.

1. Pour gasoline into the gasoline container until approximately half full.
2. Pour 236 ml (8 fl oz) of the recommended 2-cycle oil into the gasoline container.
3. Install cap on gasoline container and shake the mixture vigorously.

4. Fill the gasoline container with gasoline; then cap the gasoline container and shake the mixture vigorously.
5. Using a fine-mesh screened funnel, pour the fuel mixture from the gasoline container into the snowmobile gas tank.

⚠ WARNING

Always fill the gas tank in a well-ventilated area. Never add gasoline to the snowmobile gas tank near any open flames or with the engine running. DO NOT SMOKE while mixing fuel or filling the gas tank.

**ENGINE BREAK-IN
(2-Stroke Models)**

The Arctic Cat engine (when new or rebuilt) requires a short break-in period before the engine is subjected to heavy load conditions. Arctic Cat requires that the first tankful of fuel be premixed at a 100:1 ratio in all oil-injection models.

During the break-in period, a maximum of 1/2 throttle is recommended; however, brief full-throttle accelerations and variations in driving speeds contribute to good engine break-in. After one (1) tankful break-in period, the snowmobile may be taken to an authorized Arctic Cat Snowmobile dealer for a checkup. This checkup is at the discretion and the expense of the snowmobile owner.

⚠ CAUTION

DO NOT exceed the one (1) tankful limitation of a 100:1 gas/oil break-in mixture. Continuous use of a gas/oil mixture, unless consistently operating in extremely cold conditions (-26°C/-15°F or colder), could cause spark plug fouling and excessive carbon buildup. A 100:1 gas/oil mixture must be used in conjunction with the oil-injection system to ensure adequate engine lubrication in extremely cold conditions.

**ENGINE BREAK-IN
(660 cc/1100 cc Z1 Models)**

The Arctic Cat engine (when new or rebuilt) requires a short break-in period before the engine is subjected to heavy load conditions.

This engine does not require any pre-mixed fuel during the break-in period.

⚠ CAUTION

DO NOT use premixed fuel in the snowmobile gas tank. Engine damage will occur.

To ensure trouble-free operation, careful adherence to the following break-in guidelines will be beneficial.

0-200 miles	1/2 Throttle (45 MPH-max)
200-400 miles	1/2-3/4 Throttle
400-600 miles	1/2-3/4 Throttle *

* With occasional full-throttle operation.

To ensure proper engine break-in on the 1100 cc Z1 and 660 cc models, Arctic Cat recommends that the engine oil and filter be changed after 200-500 miles. This service is at the expense of the snowmobile owner.

INDICATOR LIGHTS (Carbureted Models/ Bearcat W/T Non- Turbo/Panther 660)

Indicator lights are incorporated within the speedometer.

LOW OIL WARNING LIGHT (Standard 2- Stroke Models)

The Low Oil Warning Light is designed to alert the snowmobile operator when the oil in the oil injection reservoir gets below a prescribed level; however, it is highly recommended that a visual verification of the oil level in the reservoir be done prior to operating the snowmobile. Once the Low Oil Warning Light illuminates during operation of the snowmobile, the operator must periodically monitor the level of oil in the reservoir and must fill the reservoir the next time gasoline is added to the gas tank. The “alert level” of the Low Oil Warning Light is approximately equal to 1 tankful of gasoline under normal operating conditions.

LOW OIL PRESSURE WARNING LIGHT (Bearcat W/T Non- Turbo/Panther 660 Models)

The Low Oil Pressure Warning Light indicates engine oil pressure, not the oil level; however, if the oil level is low, it may affect oil pressure. The light should illuminate each time the ignition switch is turned to RUN or START, and it should go out when the engine starts. If the light illuminates while the engine is running, oil pressure has been lost and the engine will automatically shut off.

If oil pressure is lost, use the following procedure:

1. Check the oil level.

■ **NOTE: To ensure an accurate reading, the snowmobile should be on level ground.**

2. If the oil level is below the lower mark on the oil level stick, add only enough recommended oil to raise the level between the upper and lower marks. **DO NOT** overfill the crankcase with oil.
3. After adding oil if the engine starts, oil pressure should be normal.

If the engine does not start, take the snowmobile to an authorized Arctic Cat Snowmobile dealer.

COOLANT TEMPERATURE WARNING LIGHT (Carbureted Models/ Bearcat W/T Non- Turbo/Panther 660)

If the coolant temperature is at the maximum running temperature, the coolant temperature warning light will flash a warning (alert). If the coolant temperature is above the maximum running temperature, the coolant temperature warning light will cease flashing and will remain constantly illuminated.

CAUTION

At this point, take precautionary measures such as changing to loose snow terrain, shutting the engine off (allowing the engine to cool down), and checking coolant level. If unable to either determine or remedy the problem, take the snowmobile to an authorized Arctic Cat Snowmobile dealer for service.

CHARGING SYSTEM WARNING LIGHT (660 cc Models)

The Charging System Warning Light is designed to warn the operator if the battery charging system is not functioning. The light should illuminate each time the key is turned to RUN or START, and it should go out when the engine starts. If the light stays illuminated or it illuminates while the engine is running, the battery is not being charged, and the snowmobile is running on battery reserve power only.

If the Charging System Warning Light illuminates, you should, as soon as possible, take the snowmobile to an authorized Arctic Cat Snowmobile dealer for service. If not under warranty, this service is at the discretion and expense of the snowmobile owner. The engine **WILL NOT RUN** without battery power.

CHECK ENGINE LIGHT (Bearcat W/T Non- Turbo/Panther 660 Models)

The Check Engine Light is controlled by the ECU and may illuminate for a number of reasons. The light should illuminate each time the key is turned to RUN or START, and it should go out when the engine starts. If the light stays illuminated or it illuminates while the engine is running, the ECU is receiving input that is outside of its established parameters. If the Check Engine Light illuminates, take the snowmobile to an authorized Arctic Cat Snowmobile dealer for service. If not under warranty, this service is at the discretion and expense of the snowmobile owner.

SPEEDOMETER/ TACHOMETER INDICATOR LIGHTS (Crossfire/F-Series/ Jaguar Z1/M-Series/ 660 cc Turbo Models)

This snowmobile is equipped with a combination speedometer/tachometer. Indicator lights are incorporated within the speedometer/tachometer. Also incorporated into the speedometer/tachometer is a digital readout screen.



ZJ001A

- A. Chassis Control Unit
- B. Oil Pressure/Low Oil
- C. High Beam
- D. Check Engine
- E. Coolant Temperature

Top Button

By pushing the top button once (lower right-hand side of the speedometer/tachometer), the RPM and MPH will be displayed (one on the readout screen and one with the needle). By pushing the button once again, the functions will be reversed.

By pushing the top button (with speed being displayed) for more than two seconds, the display will show between standard mph or metric kph. Release the button when desired display appears.

By pushing and holding the top button, maximum RPM will be displayed on the readout screen. The maximum RPM readout will reset when the engine is shut off.

Bottom Button

By pushing the bottom button once, the readout screen will display hour-meter or trip-meter/odometer; by pushing the button once again, the two functions will be reversed. To reset the trip meter with the trip meter displayed, push and hold the bottom button until the display is cleared. The hour-meter readout will not reset.

Chassis Control Unit

On electric start models, the icon should illuminate each time the key is turned to RUN or START, and it should go out when the engine starts. If the light stays illuminated (on electric start models) or it illuminates while the engine is running, the CCU is receiving input that is outside of its established parameters. If the CCU icon illuminates indicating an error, take the snowmobile to an authorized Arctic Cat Snowmobile dealer for service. If not under warranty, this service is at the discretion and expense of the snowmobile owner.

Coolant Temperature Warning Light

If the coolant temperature is at the maximum running temperature, the coolant temperature warning light will flash a warning (alert). If the coolant temperature is above the maximum running temperature, the coolant temperature warning light will cease flashing and will remain constantly illuminated.

CAUTION

At this point, take precautionary measures such as changing to loose snow terrain, shutting the engine off (allowing the engine to cool down), and checking coolant level. If unable to either determine or remedy the problem, take the snowmobile to an authorized Arctic Cat Snowmobile dealer for service.

Low Oil Warning Light (Crossfire/F-Series/M-Series Models)

The Low Oil Warning Light is designed to alert the snowmobile operator when the oil in the oil injection reservoir gets below a prescribed level; however, it is highly recommended that a visual verification of the oil level in the reservoir be done prior to operating the snowmobile. Once the Low Oil Warning Light illuminates during operation of the snowmobile, the operator must periodically monitor the level of oil in the reservoir and must fill the reservoir the next time gasoline is added to the gas tank. The “alert level” of the Low Oil Warning Light is approximately equal to 1 tankful of gasoline under normal operating conditions.

Oil Pressure Warning Light (Jaguar Z1/660 cc Turbo Models)

The Oil Pressure Warning Light indicates engine oil pressure, not the oil level; however, if the oil level is low, it may affect oil pressure.

The light should illuminate each time the ignition switch is turned to RUN or START, and it should go out when the engine starts. If the light illuminates while the engine is running, oil pressure has been lost and the engine will automatically shut off.

If oil pressure is lost, use the following procedure to check the oil level:

■ **NOTE: On the 660 cc Turbo models, to ensure an accurate reading, the snowmobile should be on level ground.**

1. On the 660 cc Turbo models, check the oil level. If the oil level is below the lower mark on the oil level stick, add only enough recommended oil to raise the level between the upper and lower marks. DO NOT overfill the crankcase with oil.
2. On the Jaguar Z1 with the engine off, remove the engine oil level stick and wipe it clean. Without screwing it in, set the stick back in the oil tank. Remove it and observe the oil level on the stick. If the oil level is at or below the ADD mark on the oil level stick, add only enough recommended oil to raise the level to the NORMAL range. DO NOT overfill the reservoir with oil.
3. On the Jaguar Z1, open the air bleed bolt located on the oil pump (beneath the coolant tank) to purge air from the oil hose.

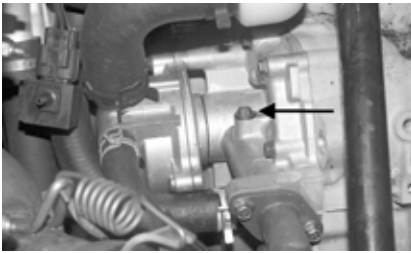

ZJ004A

■ **NOTE:** When air can no longer be heard, purging from oil pump bleed, tighten the bleed bolt to 1.05 kg-m (7.5 ft-lb).

4. Start the engine. The warning light should go out within five seconds.

If the engine does not start, take the snowmobile to an authorized Arctic Cat Snowmobile dealer.

Check Engine Light

The Check Engine Light is controlled by the ECU and may illuminate for a number of reasons.

■ **NOTE:** The light should illuminate each time the key is turned to RUN or START, and it should go out when the engine starts.

If the light stays illuminated or it illuminates while the engine is running, the ECU is receiving input that is outside of its established parameters. If the Check Engine Light illuminates, take the snowmobile to an authorized Arctic Cat Snowmobile dealer for service. If not under warranty, this service is at the discretion and expense of the snowmobile owner.

DIAGNOSTIC CODES/ CHECK ENGINE (2-Stroke Models)

If the coolant temperature is at or above 80° C (176° F), the coolant temperature light will flash a warning (alert). If the coolant temperature is at or above 93° C (200° F), the check engine light will cease flashing and will remain constantly illuminated.

■ **NOTE:** At this point, the operator should take precautionary measures such as changing to loose snow terrain and/or checking coolant level.

 CAUTION
If unable to either determine or remedy the problem, take the snowmobile to an authorized Arctic Cat Snowmobile dealer for service.

Additional codes are flashed by the check engine light. Refer to the following chart for diagnostic code sequences.

■ **NOTE:** On single-digit codes (2, 4, etc.), the number indicated will flash in an uninterrupted sequence. On double-digit codes (1-2, 2-1, etc.), the first number indicated will flash in an uninterrupted sequence, there will be a short pause, and the second number indicated will flash in an uninterrupted sequence.

Number of Flashes	Trouble
1-2 (Check Engine Light)	Failure in ignition coil.
1-6 (Check Engine Light)	Incorrect adjustment/ failure in APV cable.
1-7 (Check Engine Light)	Failure in exhaust temperature sensor.
1-8 (Check Engine Light)	Failure in servomotor.
2 (Check Engine Light)	Failure in injector(s).
2-1 (Check Engine Light)	Failure in knock sensor.
2-3 (Check Engine Light)	Failure in knock control system.
4 (Check Engine Light)	Open or short circuit in barometric pressure sensor.
5 (Check Engine Light)	Open or short circuit in intake air temperature sensor.
6 (Check Engine Light)	Open or short circuit in water temperature sensor.
7 (Check Engine Light)	Open or short circuit in throttle position sensor.
Steady Flash (Coolant Temperature Light)	Coolant Temperature Above 80° C (176° F).
Constant On (Coolant Temperature Light)	Coolant Temperature Above 93° C (200° F).

DIAGNOSTIC CODES/ CHECK ENGINE (JAGUAR Z1)

These diagnostic codes are flashed by the check engine light. Refer to the following chart for diagnostic code sequences.

■ **NOTE:** On single-digit codes (2, 3, etc.), the number indicated will flash in an uninterrupted sequence. On double-digit codes (1-1, 1-2, etc.), the first number indicated will flash in an uninterrupted sequence, there will be a short pause, and the second number indicated will flash in an uninterrupted sequence.

Number of Flashes	Trouble
1 (Check Engine Light)	Failure in the fuel system.
1-1 (Check Engine Light)	Failure in speed sensor.
1-2 (Check Engine Light)	Failure in coil (#1).
1-3 (Check Engine Light)	Failure in coil (#2).
1-4 (Check Engine Light)	Failure in ISC valve.
1-5 (Check Engine Light)	Failure in oxygen sensor.
1-9 (Check Engine Light)	Failure in camshaft position sensor.
2 (Check Engine Light)	Failure in injector (#2).

Number of Flashes	Trouble
3 (Check Engine Light)	Failure in injector (#1).
4 (Check Engine Light)	Failure in barometric pressure sensor.
5 (Check Engine Light)	Open or short circuit in intake manifold air temperature sensor.
6 (Check Engine Light)	Open or short circuit in water temperature sensor.
7 (Check Engine Light)	Open or short circuit in throttle position sensor.
8 (Check Engine Light)	Open or short circuit in manifold air pressure sensor.
9 (Check Engine Light)	Failure in crankshaft position sensor.

HANDLEBAR TILT

The handlebar can be adjusted to the position providing the operator with the most comfort. To adjust the handlebar, use the following procedure:

■ **NOTE:** It may be necessary to remove the handlebar cover for this procedure.

1. Loosen the four lock nuts securing the handlebar caps and block to the steering post.

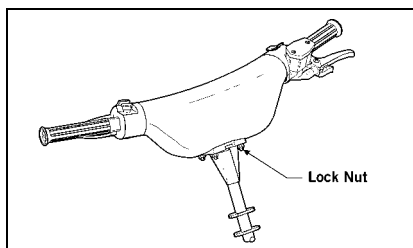

0734-406

2. Adjust the handlebar up or down to operator's desired tilt; then tighten the lock nuts evenly and securely. Check steering for maximum right/left turning capabilities.
3. Recheck lock nuts; tighten securely.

■ **NOTE:** Recommended torque value of lock nuts is 2.5 kg-m (18 ft-lb).

■ **NOTE:** Do not adjust the handlebar to a position that allows the brake fluid to be below the low mark on either side of the master cylinder.

WARNING

Tighten lock nuts according to specifications to prevent unexpected "movement" of the handlebar during operation over rough terrain and **DO NOT** position handlebar so steering (maximum right/left turning capabilities) or throttle and brake controls are affected.

HANDLEBAR TILT (F-Series - STD)

The handlebar can be adjusted to the operator's preference. To adjust the handlebar, use the following procedure:

1. Loosen the eight cap screws securing the handlebar caps to the riser and the riser to the steering post.

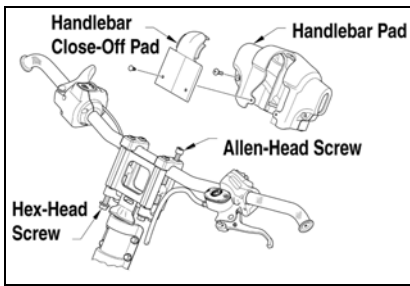

735-501B

2. Adjust the handlebar up or down to operator's desired tilt, tighten the cap screws evenly to 3.5 kg-m (25 ft-lb), and check steering for maximum right/left turning capabilities.

■ **NOTE:** Do not adjust the handlebar to a position that allows the brake fluid to be below the low mark on either side of the master cylinder.

WARNING

Tighten cap screws according to specifications to prevent unexpected "movement" of the handlebar during operation over rough terrain. **DO NOT** offset the handlebar so steering (maximum right/left turning capabilities) are altered or throttle and brake controls will be affected.

HANDLEBAR TILT (F-Series LXR/Sno Pro/ Jaguar Z1)

The handlebar can be adjusted to the operator's preference. To adjust the handlebar, use the following procedure:

1. Press inward on the lock pin to release the cam lever and "flip" the cam lever up.

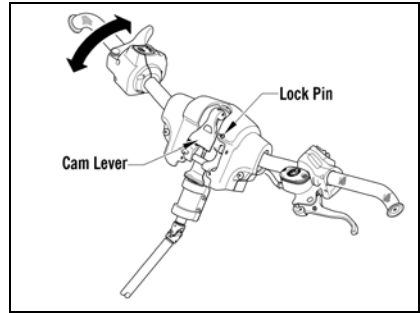

0741-427

2. Adjust the handlebar up or down and/or rotate the handlebar to operator's desired position; then press down on the cam lever until the lock pin is properly positioned and locked. Check steering for maximum right/left turning capabilities.

■ **NOTE:** At this point, gently lift the cam lever without pressing in on the lock pin. If the cam lever cannot be lifted, the lock pin is secure.

■ **NOTE:** Do not rotate the handlebar to a position that allows air to enter the brake system.

3. Test the handlebar to ensure that it does not rotate within the riser block. If it does not rotate, proceed to step 4. If it does rotate, release the cam lever and rotate the cam lever clockwise; then press down on the cam lever until the lock pin is properly positioned and locked. Repeat this procedure until the handlebar is properly secured.

4. After the handlebar is “locked” in position, release the cam lever and rotate it one turn clockwise; then press down on the cam lever until it “locks” in place.

■ **NOTE: At this point, gently lift the cam lever without pressing in on the lock pin. If the cam lever cannot be lifted, the lock pin is secure.**

 **CAUTION**

If at any time the lock pin will not engage into the locked position, do NOT operate the snowmobile. Take the snowmobile to an authorized Arctic Cat dealer for service.

 **WARNING**

Care must be taken to securely lock the handlebar cam lever to prevent unexpected “movement” of the handlebar during operation over rough terrain. DO NOT offset the handlebar so steering (maximum right/left turning capabilities) are altered or throttle and brake controls will be affected.

EXHAUST SYSTEM

The exhaust system is designed to reduce noise and to improve the total performance of the engine. If any exhaust system component is removed from the engine and the engine is run, severe engine damage will result.

AIR-INTAKE SILENCER

Used in conjunction with the fuel intake system is a specially designed air-intake silencer. The purpose of the silencer is to quiet the intake of fresh air. Since the fuel intake system is calibrated with the air-intake silencer in place, the engine must never be run with the silencer removed. Performance will not be improved if the air-intake silencer is removed. In contrast, severe engine damage will occur.

 **CAUTION**

These snowmobiles are not designed to be operated in dusty conditions. Operating the snowmobile in dusty conditions will result in severe engine damage.

BATTERY (Electric Start Models)

It is extremely important that the battery be maintained at full charge at all times and that the battery connections be clean and tight. If charging the battery becomes necessary, refer to Charging Battery section of this manual.

COOLING SYSTEM (Liquid)

Some snowmobiles are equipped with a closed liquid cooling system for engine cooling. The cooling system should be inspected daily for leakage and damage. Also, the coolant level should be checked daily. If leakage or damage is detected, take the snowmobile to an authorized Arctic Cat Snowmobile dealer for service. If not under warranty, this service is at the discretion and expense of the snowmobile owner.

When filling the cooling system, use an ethylene glycol-based coolant/water mixture which will satisfy the coldest anticipated weather conditions of your area in accordance with the coolant manufacturer's recommendations. While the cooling system is being filled, air pockets may develop; therefore, run the engine for five to ten minutes after the initial fill, shut the engine off, and then fill the cooling system to approximately 51 mm (2 in.) below the filler neck on 2-stroke models or to just below the FULL mark on 660 cc/1100 cc Z1 models.

■ **NOTE:** The 660 cc models are equipped with a coolant "bleed screw" on the purge tank (located on the front-top of the engine). After starting the engine (and with the tank cap on and tight), open the bleed screw slightly to allow trapped air to escape. Continue until no air is apparent; then tighten the screw.

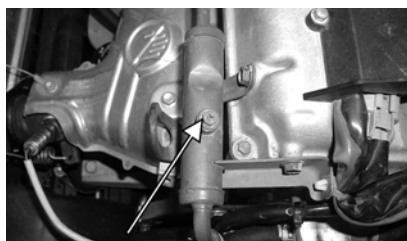

AO353A

■ **NOTE:** Use a good quality, ethylene glycol-based, automotive-type antifreeze.



CAUTION

After operating the snowmobile for the initial 5-10 minutes, stop the engine, allow the engine to cool down, and check the coolant level. Add coolant as necessary.

DRIVE CLUTCH AND DRIVEN PULLEY

The drive clutch and driven pulley do not require lubrication; therefore, no special maintenance is required by the snowmobile owner.

However, the drive clutch and driven pulley should be disassembled, cleaned, and inspected by an authorized Arctic Cat Snowmobile dealer after every 800 miles of operation or at the end of the snowmobiling season whichever occurs first. This service is at the discretion and expense of the snowmobile owner.

When operating the snowmobile at high altitudes, it may be necessary to change certain component parts of the drive clutch. See an authorized Arctic Cat Snowmobile dealer for further information.

⚠ CAUTION

DO NOT attempt to service the drive clutch and driven pulley. The drive clutch and driven pulley must be serviced by an authorized Arctic Cat Snowmobile dealer only.

DRIVE CLUTCH/ DRIVEN PULLEY ALIGNMENT

The parallelism and the offset between the drive clutch and driven pulley are set at the factory. Normally, no adjustment is necessary as long as neither the drive clutch nor the driven pulley is removed or disassembled. However, if premature drive belt wear is experienced or if the drive belt turns over, the drive clutch/driven pulley alignment must be checked. Take the snowmobile to an authorized Arctic Cat Snowmobile dealer for this service. If not under warranty, this service is at the discretion and expense of the snowmobile owner.

DRIVE CHAIN TENSION

The drive chain must be properly tensioned for proper operation to prevent “ratcheting” and unnecessary chain/sprocket wear. On these snowmobiles, there are two different chain tensioners in the chain case. One chain tensioner is automatic and one is manual. The automatic chain tensioner will take up the slack in the chain under most operating conditions; however, every 500 miles or whenever repeated hard accelerations will occur, the manual chain tensioner should be adjusted. Arctic Cat recommends that the chain, sprockets, and chain tensioner be checked for wear and proper alignment and adjustment every year, 1000 miles, or whenever a drive chain related problem is suspected. Take the snowmobile to an authorized Arctic Cat Snowmobile dealer for this service. If not under warranty, this service is at the discretion and expense of the snowmobile owner. To adjust the manual drive chain tensioner, use the following procedure:

1. Loosen the jam nut on the chain tensioner adjustment bolt.
2. Tighten the adjustment bolt finger-tight.

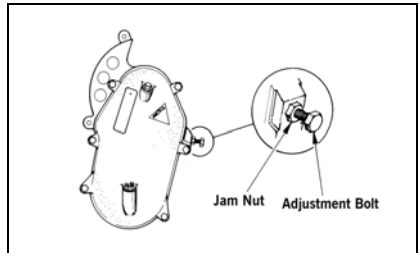

0730-323

■ **NOTE:** If the adjustment bolt will not turn using the fingers (because of dirty threads), use a wrench to loosen the bolt; then using the fingers, adjust the bolt until it is finger-tight. Once the adjustment bolt becomes difficult to turn by hand, the drive chain is properly tensioned.

3. Lock the adjustment by bottoming the jam nut against the chain case.

■ **NOTE:** When the head of the adjustment bolt bottoms on the jam nut, the drive chain is in need of being replaced. See an authorized Arctic Cat Snowmobile dealer for this service.

FUEL PUMP

The fuel pump is designed to provide adequate amount of gas to the carburetors (on carbureted models) or to the injectors (on EFI models) at all throttle settings. If a fuel delivery problem is suspected, take the snowmobile to an authorized Arctic Cat Snowmobile dealer. If not under warranty, this service is at the discretion and expense of the snowmobile owner.

GAS TANK SHUT-OFF VALVE

On certain models, a shut-off valve is incorporated into the gas hose coming from the gas tank. The valve should be turned to the CLOSED position when trailering or storing the snowmobile. Turn the valve to the OPEN position before attempting to start the engine.

■ **NOTE:** On all remaining models, there is an automatic shut-off valve incorporated into the fuel pump which prevents gasoline flow when the engine is off.

SHOCK ABSORBERS (Standard Gas)

Each shock absorber should be visibly checked weekly for fluid leakage, cracks or breaks in the lower case, or a bent plunger. If any one of these conditions is detected, replacement is necessary. Take the snowmobile to an authorized Arctic Cat Snowmobile dealer for this service. If not under warranty, this service is at the discretion and expense of the snowmobile owner.

■ **NOTE:** When the snowmobile is operated in extremely cold weather (-23° C/-10° F or colder), a small amount of leakage may be present. Unless the leakage is excessive, replacement is not necessary.

SHOCK ABSORBERS (Rebuildable Gas)

■ **NOTE:** The presence of an ACT identifier (decal or embossed) on a shock absorber body indicates a “rebuildable” shock absorber.

■ **NOTE:** The frequency of servicing rebuildable shock absorbers will vary according to the types of conditions and terrain the snowmobile has been subjected to. If riding quality deteriorates (or seems to be deteriorating), take the snowmobile to an authorized Arctic Cat Snowmobile dealer for shock absorber evaluation and/or servicing. This service is at the discretion and expense of the snowmobile owner.

Servicing rebuildable shock absorbers is considered normal maintenance and is the responsibility of the owner. Take the snowmobile to an authorized Arctic Cat Snowmobile dealer for this service. This service is at the discretion and expense of the snowmobile owner. Kits are available to either stiffen or soften gas shock valving. If changes in shock valving are desired, see an authorized Arctic Cat Snowmobile dealer. This service is at the discretion and expense of the snowmobile owner.

Each shock absorber should be visibly checked weekly for fluid leakage, cracks or breaks in the lower case, or a bent plunger. If any one of these conditions is detected, replacement is necessary. Take the snowmobile to an authorized Arctic Cat Snowmobile dealer for this service. If not under warranty, this service is at the discretion and expense of the snowmobile owner.

■ **NOTE:** When the snowmobile is operated in extremely cold weather (-23° C/-10° F or colder), a small amount of leakage may be present. Unless the leakage is excessive, replacement is not necessary.

DEEP-LUG TRACK

Some models are equipped with a deep-lug track which is specially designed for use in powder snow riding conditions. When the deep-lug track is operated in hard-packed snow conditions, it will run slightly slower than a standard-lug track and it will accelerate wear strip wear. To decrease the amount of wear strip wear, slower speeds must be maintained when operating on hard-packed trails. Accelerated wear strip wear caused by operating a deep-lug track on hard-packed snow conditions is NOT covered under Arctic Cat Inc. warranty policy.

HACKSAW TRACK

Accelerated wear strip wear caused by operating a Hacksaw Track on hard-packed snow conditions is NOT covered under Arctic Cat Inc. warranty policy.

TRACK STUDS

■ **NOTE:** Stud or hooker plate installation will void track and tunnel warranty.

■ **NOTE:** Stud installation can be performed by the snowmobile owner if qualified to do so. If the owner does not feel qualified, take the snowmobile to an authorized Arctic Cat Snowmobile dealer for this service. This service is at the discretion and expense of the snowmobile owner.

For proper installation, use the following procedure:

1. Using Stud Template (p/n 2639-903), mark the desired stud pattern to be used.
2. Using the proper-sized stud hole drill bit, drill out the stud holes.
3. Push the stud through the hole from inside the track; then place the domed support plate and lock nut on the exposed stud.
4. Using a wrench to secure the stud, tighten the lock nut on the exposed stud.

It is also recommended that whenever studs are installed on a track, carbide wear bars should be installed on the skis. Carbide wear bars complement the track studs to balance steering control under these conditions. The length of the carbide on the wear bars should be proportionate to the number of track studs (i.e. small number of track studs — short length of carbide...many track studs — long length of carbide). The proper proportion between the number of studs and carbide length on the wear bar will maintain steering balance.

WARNING

Always balance the snowmobile with the proper proportion between the number of studs and carbide length on the wear bars. Do not “over drive” conditions; use common sense in all operating conditions.

CAUTION

Do not use studs that are more than 9.525 mm (0.375 in.) longer than the track lug height.

WARNING

Do not operate a snowmobile with loose studs as they may be thrown from the track. Always use a shielded safety stand whenever performing any maintenance or adjustments.

WARNING

DO NOT stand behind the snowmobile or near the rotating track. **NEVER** run the track at high speed when the track is suspended.

REVERSE TRANSMISSION

The reverse transmission offers the operator the convenience of being able to back up the snowmobile rather than having to turn the snowmobile around by hand. This feature, under most situations, should not be used to free a stuck snowmobile as it will tend to dig the skis deeper into the snow. Before starting the snowmobile, be sure the shift lever is in the desired position for either forward or reverse operation.

Always use minimal speed when operating in reverse and come to a complete stop before shifting from either forward to reverse or reverse to forward. Once you have shifted to a new gear, apply slight throttle until positive engagement of the shift has been observed. To shift the reverse transmission, use the following procedure:

1. Come to a complete stop.
2. Either push or pull the shift lever to the desired position; then apply slight throttle until positive engagement of the shift has been observed.

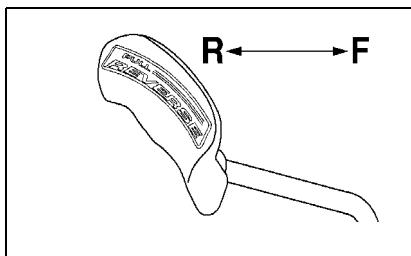

737-831A

⚠ WARNING

Use caution and minimal speed when operating the snowmobile in reverse. Be sure the shift lever is in the desired lever position.

No special maintenance is required for the reverse transmission; however, if chattering is experienced when the transmission is shifted into reverse, the linkage may have to be adjusted. Arctic Cat recommends taking the snowmobile to an authorized Arctic Cat Snowmobile dealer for this service. If not under warranty, this service is at the discretion and expense of the snowmobile owner.

■ NOTE: A warning buzzer will sound when the transmission is in the reverse position; however, always check the position of the shift lever before accelerating.

REVERSE TRANSMISSION (Crossfire/F-Series/Jaguar Z1/M-Series Models)

The reverse transmission offers the operator the convenience of being able to back up the snowmobile rather than having to turn the snowmobile around by hand. This feature, under most situations, should not be used to free a stuck snowmobile as it will tend to dig the skis deeper into the snow. Always use minimal speed when operating in reverse and come to a complete stop before shifting from either forward to reverse or reverse to forward. To shift the reverse transmission, use the following procedure:

1. Come to a complete stop.

■ NOTE: The snowmobile must be at a complete stop and the engine at idle before the system will allow shifting.

2. With the engine at idle, press the reverse switch button; then release the button. The reverse selection will be complete.

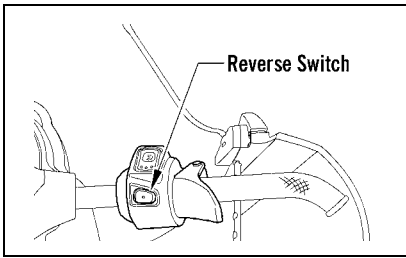

0741-438

■ **NOTE:** The system will not shift until the button is released.

3. To shift into forward, stop the snowmobile and allow the engine to idle; then press the button and release. The forward selection will be complete.

WARNING

Use caution and minimal speed when operating the snowmobile in reverse. Be sure the button is in the desired position.

■ **NOTE:** A warning buzzer will sound when the transmission is in the reverse position.

TOWING

If the snowmobile is to be towed by another snowmobile, do not tow using the loops in the skis. The tow rope should be attached to the spindles.

ADJUSTABLE BACKREST

The adjustable backrest is designed for maximum comfort and safety. When riding double, the backrest must be adjusted to the most rearward position.

When riding single, the backrest should be moved forward to a position comfortable to the operator. Be sure to maintain the backrest pad in a vertical position in all locations. Also, be sure to tighten all retaining knobs securely after adjusting the backrest.

WARNING

Moving the backrest forward limits the seating capacity to one person only.

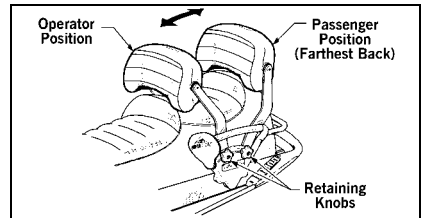

0734-425

REMOVABLE REAR SEAT

Some snowmobiles are equipped with a removable rear seat to allow for additional cargo space when no passenger is being carried. To remove the rear seat, use the following procedure:

1. Move and lock the adjustable backrest in the forward position.
2. Pull back on the seat latch handle located at the bottom rear of the seat.
3. Lift on the back of the seat and move it rearward to remove it from the tunnel.

CAUTION

On models equipped with a seat warmer, disconnect the warmer wiring harness prior to fully removing the seat.

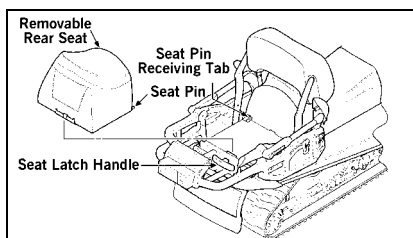

0735-854

To install the rear seat, use the following procedure:

1. Place the seat into position on the tunnel making sure the two pins on the front of the rear seat are properly engaged with the receiving tabs on the rear of the front seat.
2. Pull back on the seat latch handle; then with the seat latch handle pulled back, push the rear seat forward and down and release the seat latch handle.

WARNING

Make sure the rear seat is securely locked in place before carrying a passenger or personal injury may result.

REMOVABLE SEAT (Crossfire/M-Series Models)

These snowmobiles are equipped with a removable seat. To remove the seat, use the following procedure:

1. Inside the rear storage compartment on the bottom of the seat-base, pull the retaining clips away from locking pins.
2. Lift on the back of the seat and move it rearward to remove it from the tunnel.

To install the seat, use the following procedure:

1. Slide the front of the seat into position on the tunnel; then lower the rear of the seat onto the locking pins.
2. Press down on the rear of the seat until the retaining clips snap into place on the locking pins.

WARNING

Make sure the seat is securely locked in place or personal injury may result.

REMOVABLE/ ADJUSTABLE SEAT (F-Series/Jaguar Z1)

This snowmobile is equipped with a removable/adjustable seat. To adjust the seat, use the following procedure:

1. Press in on the left-end of the seat adjuster lever at the rear storage compartment; then pull out on the seat adjuster lever at the rear storage compartment.

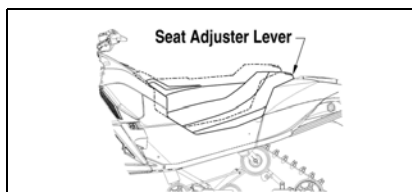

741-434A

2. Lift up on the back of the seat; then move the front of the seat up or down into one of the seven available positions.

⚠ CAUTION

Do not use the adjuster lever to lift the seat.

3. Press down on the rear of the seat; then secure the seat by releasing the seat adjuster lever.

⚠ WARNING

Make sure the seat is securely locked in place or personal injury may result.

To remove the seat, use the following procedure:

1. Adjust the seat to the lowest position; then while lifting on the top forward part of the seat, remove the self-tapping screw from the right side of the seat support assembly.

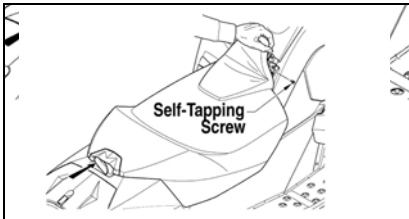

741-718A

2. Press in on the left-end of the seat adjuster lever at the rear storage compartment; then pull out on the seat adjuster lever.
3. Lift on the back of the seat and move it forward and upward to remove it from the chassis.

⚠ CAUTION

Do not use the adjuster lever to lift the seat.

To install the seat, use the following procedure:

1. With the seat adjuster lever pulled out, slide the front of the seat into position on the chassis; then with seat position selected, lower the rear of the seat onto the rear storage compartment.
2. Press down on the rear of the seat; then secure the seat by releasing the seat adjuster lever.
3. With the seat adjusted to the lowest position, install the self-tapping screw into the right side of the seat support assembly.

⚠ WARNING

Make sure the self-tapping screw is securely tightened and the seat is securely locked in place or personal injury may result.

ARCTIC POWER VALVE (APV) SYSTEM

⚠ CAUTION

The correct engine oil to use is Arctic Cat Synthetic APV 2-Cycle Oil (p/n 2639-512). Any substitute may cause an APV malfunction.

This RPM controlled servomotor (servo) actuated system adjusts the size of the exhaust ports to provide peak performance throughout the RPM range.

The system consists of an exhaust valve assembly mounted to the exhaust side of each cylinder and connected by adjustable cables to an electronic servo mounted beneath the hood.

■ **NOTE:** The mounting location of the servo will vary from model to model.

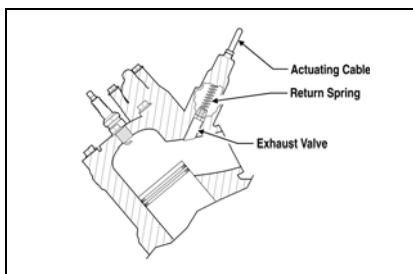

739-152F

At low RPM, the exhaust valves are held in the DOWN position by return springs. This gives the engine a “low port” exhaust design calibrated to provide maximum low RPM power and improve fuel economy at trail speeds.

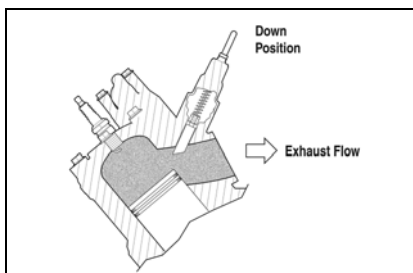

739-152G

At high RPM, the exhaust valves are raised. This creates a “high port” exhaust design calibrated to provide maximum performance at high RPM.

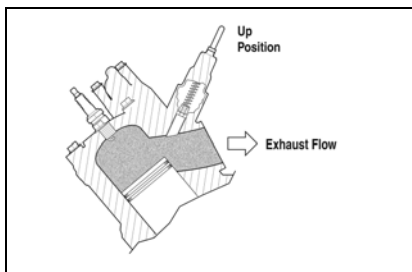

739-152H

■ **NOTE:** The RPM ranges will vary from model to model.

■ **NOTE:** If the servomotor cycles three times and then shuts down, the exhaust valve cables are not adjusted correctly. The exhaust valves may also be sticking.

■ **NOTE:** APV cleaning may be done by the snowmobile owner if qualified to do so. If the owner does not feel qualified, take the snowmobile to an authorized Arctic Cat Snowmobile dealer for this service. This service is at the discretion and expense of the snowmobile owner.

EXHAUST CONTROLLED TIMING (ECT) SYSTEM (600/800/1000 cc)

This system automatically adjusts the ignition timing to provide maximum performance through a variety of operating conditions. The ECU receives input on engine RPM (demand) and exhaust pipe temperature (engine condition) and adjusts the ignition timing accordingly. This system is not adjustable and is maintenance free.

If a system fault is suspected, use an ohmmeter to check continuity of the exhaust pipe temperature sensor located in the expansion chamber. A reading of either 0 ohm or infinity indicates a failed sensor.

■ NOTE: A disabled ECT system WILL NOT cause engine damage; however, a failed ECT system will have slower throttle response and may produce slightly less top-end performance.

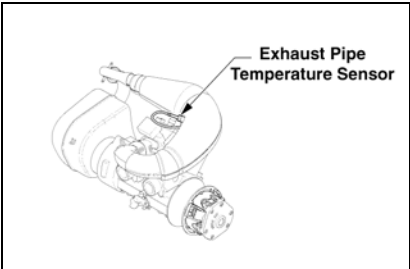

0737-314

OPERATING INSTRUCTIONS

STARTING AND STOPPING ENGINE

It is imperative that the brake system be checked for wear and proper operation and that all safety checks found in the accompanying Snowmobile Safety Handbook be performed before attempting to start the engine. **Also, on carbureted models, be sure the correct carburetor main jet(s) for the operating temperature, altitude, and gasoline are being used.** After the engine has been started, check the headlights (high and low beam), taillight, and brakelight to be sure they are working properly and adjusted correctly. Make sure all lights are clean to provide maximum illumination. The headlight and taillight must be clean and must be illuminated whenever the engine is running.

■ **NOTE:** If equipped with reverse shift lever, make sure the lever is in the forward position before starting the engine.

1. Test the operation of the brake system by compressing the brake lever. The brake lever must feel firm when compressed; then while holding the brake lever in the compressed position, measure the distance between the brake lever and the handlebar (on hydraulic brake models) or between the brake lever and lever stop (on mechanical brake models). The distance must be greater than 2.54 cm (1 in.) on hydraulic brake models or within a range of 6-13 mm (1/4-1/2 in.) on mechanical brake models.

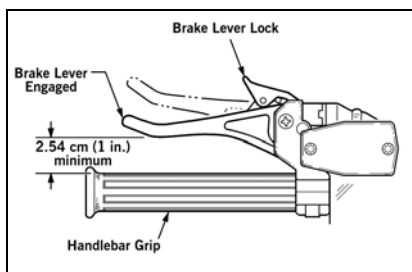

734-505A

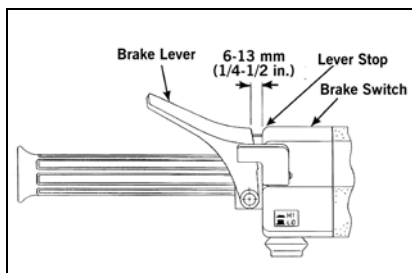

727-451A

2. On hydraulic brake models, check the fluid level in the reservoir. The brake fluid level must be just below the high mark in the brake fluid reservoir or visible in the sight glass. Add Arctic Cat approved brake fluid as necessary.

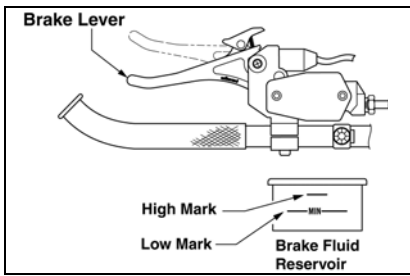

740-159A

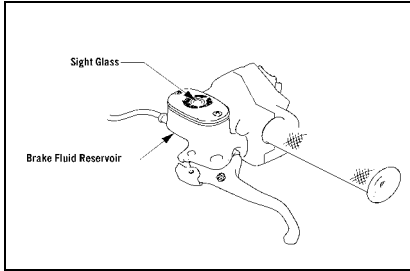

0740-588

■ **NOTE:** On models with a sight glass if the sight glass appears dark, there is a sufficient amount of fluid in the reservoir.

WARNING

Do not start the engine if the brake system is not functioning properly. Service the brake system or have it properly repaired prior to operating the snowmobile. Serious personal injury or even death may occur if the brake system is not operating properly.

3. Test the throttle control lever by completely compressing and releasing it several times. The lever **MUST** return to the idle position quickly and completely.



CAUTION

On liquid cooled models, always check the coolant level before starting the engine.

4. Move the emergency stop switch to the UP or RUN position.
5. Insert key into ignition switch; then rotate key to the RUN position.
6. On carbureted models for a cold engine, move the choke lever to the full-choke position. If the engine is warm, choking is normally not necessary.

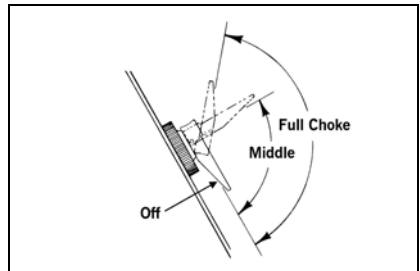

0725-001

■ **NOTE:** On carbureted models when the engine is being started with aid of the choke, **DO NOT COMPRESS THE THROTTLE CONTROL LEVER.** If the throttle control lever is compressed, the engine will not start because the gas/air mixture will be too lean. To start a warm engine, however, the throttle control lever may have to be compressed slightly.

■ **NOTE:** On EFI models when the engine is being started, **DO NOT COMPRESS THE THROTTLE CONTROL LEVER.** If the throttle control lever is compressed, the engine will not start because the fuel/air mixture will be too lean.

7. On manual start models, pull the recoil handle slowly until resistance is felt; then give a short quick pull. Repeat until the engine starts.

■ **NOTE:** On large-displacement engines in extremely cold weather, pull the recoil handle slowly two to three times to begin the starting procedure.

 **CAUTION**

To avoid damaging the recoil starter, **DO NOT** pull the recoil rope to its limit or release the recoil handle from an extended position. Allow the rope to rewind slowly.

■ **NOTE:** On electric start models, rotate the key to the **START** position; then when the engine starts, release the key.

 **CAUTION**

Do not continuously run the starter for more than 5 seconds at a time.

8. On carbureted models when the engine starts, allow it to warm up for approximately 30 seconds with the choke lever in the full-choke position. After the 30-second warm-up, move the choke lever to the middle position. The choke lever should be moved to the OFF position when engine is warm. Slight throttle control lever compression may be necessary after the engine starts and during warm-up. Idle the engine several minutes until the engine has reached normal operating temperature.
9. On EFI models when the engine starts, allow it to warm up properly. Idle the engine several minutes until the engine has reached normal operating temperature. Do not idle the engine for excessively long periods of time.

 **CAUTION**

It is extremely important that the engine is properly warmed up before subjecting the engine to high speed operation or heavy loads. The engine should be allowed to idle at least 3-4 minutes before it is operated at more than 1/2 throttle. In extremely cold conditions, the warm-up time will be longer. Cold seizure and piston scuffing caused by insufficient warm-up will not be covered by warranty. Also, do not idle the engine for excessively long periods of time.

10. Flooding — On carbureted models if the engine does not start when the choke is being used but seems ready to start, move the choke lever to the OFF position. Engage the brake lever lock; then compress the throttle control lever fully and try to start the engine. When the engine starts, release the throttle control lever immediately. After the warm-up, release the brake lever lock.

NOTE: Continued choking will cause the engine to flood more.

11. Flooding — On EFI models if the engine does not start but seems ready to start, engage the brake lever lock; then compress the throttle control lever fully and try to start the engine. When the engine starts, release the throttle control lever immediately. After the warm-up, release the brake lever lock.

NOTE: On EFI models except the 1100 cc Z1 if the engine fails to start during the attempt with the throttle control lever compressed, remove the spark plugs and clean and dry them thoroughly or install a new set of properly gapped, recommended spark plugs.

NOTE: On the Crossfire/F-Series/M-Series if spark plugs must be cleaned or replaced, see Spark Plugs in the Maintenance sub-section of this manual.

NOTE: On the 1100 cc Z1 if spark plugs must be replaced, take the snowmobile to an authorized Arctic Cat Snowmobile dealer for inspection and service. If not under warranty, this service is at the discretion and expense of the snowmobile owner.

12. To shut off the engine, turn the ignition key to the OFF position or push the emergency stop switch to the DOWN position.

NOTE: On 660 cc models, ensure that the ignition switch key is in the OFF position when the engine is not running. Leaving the ignition switch in the ON position allows the lights to be on and will drain power from the battery. The engine WILL NOT START without battery power.

HIGH RPM OPERATION (660 cc Models)

On a 660 cc model when the engine speed returns to idle after a sustained period of high RPM operation, the idle RPM may be slightly higher than usual for a brief period of time. This higher RPM is a normal oil-cooling function and should not be of concern.

BRAKING (Hydraulic Brake Models)

Operating a snowmobile with hydraulic brakes is different from operating a snowmobile with mechanical brakes. The following items are items that the operator must be familiar with when operating this snowmobile and its hydraulic brake system. Important additional information on the proper maintenance of the brake system is found in the maintenance section of this manual.

1. Use the brakes wisely. Each time the brakes are applied in all hydraulic brake systems (including automotive applications), heat is transferred to the brake fluid. The amount of heat transferred during high speed stops and/or repetitive use may be high enough to boil the brake fluid and cause the brakes to either fade or may cause an unexpected loss of brakes.

If this occurs, the brake fluid requires a cool-down period before the brakes will again function properly. This cool-down period will vary depending upon the ambient air temperature and the temperature of the brake fluid. If loss of brakes has occurred because of high fluid temperatures, do not operate the snowmobile until the cool-down period has expired and brake lever firmness has returned

WARNING

Excessive repetitive use of the hydraulic brake for high speed stops will cause overheating of the brake fluid and premature brake pad wear which will result in an unexpected loss of brakes.

2. Be sure to maintain the brake fluid at the proper level and take care not to get any moisture in the system as moisture in the brake fluid lowers the boiling point. If the brake fluid is ever boiled (by high speed stops or repetitive use) or if moisture is allowed to enter the system, it must be changed. Never substitute or mix different types or grades of brake fluid.

WARNING

Use only Arctic Cat approved brake fluid. Never substitute or mix different types or grades of brake fluid. Brake loss can result. Check brake fluid level and pad wear before each use. Brake loss can result in severe injury or even death.

3. Never ride the brake. Even maintaining minimal pressure on the brake lever will cause the brake pads to drag on the disc and may overheat the brake fluid.
4. The brake lever lock is not a parking brake and should not be applied for periods exceeding 5 minutes. **NEVER OPERATE THE SNOWMOBILE WITH THE BRAKE LEVER LOCK ENGAGED.**



WARNING

The brake lever lock is not a parking brake and should not be applied for periods exceeding 5 minutes. The brake lever lock maintains the brake lever in the compressed position and maintains pressure against the brake disc; however, after a period of time, the pressure applied to the brake disc may relax below the amount required to hold the snowmobile stationary.

5. Pumping the brake lever is permissible; however, if pumping the brake lever more than twice is necessary to obtain the necessary stopping power, immediately take the snowmobile to an authorized Arctic Cat Snowmobile dealer for service. If not under warranty, this service is at the discretion and expense of the snowmobile owner.

6. When new brake pads are installed, a “burnishing” process is required. Drive the snowmobile slowly and compress the brake lever several times until the pads just start to heat up; then allow them to thoroughly cool down. This process stabilizes the pad material and extends the life of the pads.

EMERGENCY STOPPING

There are several methods of stopping or slowing the snowmobile under a variety of situations. Identified in the following chart are the ways a snowmobile may be brought to a stop and the effectiveness under normal conditions.

ITEM	FUNCTION	CONDITION
Emergency Stop Switch	interrupts ignition circuit	ALL
Throttle/Ignition Monitor Switch	interrupts ignition circuit	ALL
Ignition Switch	interrupts ignition circuit	ALL
Brake	slows the driven shaft/ACT drive	ALL
Choke (carbureted models)	floods the engine	1/2 throttle or less

■ **NOTE:** On 660 cc models, ensure that the ignition switch key is in the OFF position when the engine is not running. Leaving the ignition switch in the ON position allows the lights to be on and will drain power from the battery. The engine **WILL NOT START** without battery power.

THROTTLE/IGNITION MONITOR SWITCH (2-Stroke/Jaguar Z1 Models)

The throttle control is equipped with a monitor switch for safety purposes which will stop the engine when a loss of return spring force occurs. If ice forms in the throttle system or if there is some other malfunction of the throttle system resulting in a loss of return spring force, the monitor switch will stop the engine when the throttle control lever is released.

WARNING

If any malfunction of the throttle system occurs (such as freezing in fluffy snow) and the monitor switch does not shut off the engine, press down on the emergency stop switch **IMMEDIATELY** to stop the engine. **DO NOT** start the engine until the malfunction in the throttle system has been located and corrected.

If the snowmobile engine stops abruptly when the throttle control lever is released and the activation of the monitor switch is suspected, use the following procedure:

1. Rotate the ignition key to the OFF position.
2. Remove ice and snow from the throttle system and wait 5-10 minutes for the engine heat to thaw ice from the throttle system.
3. Test the throttle control lever by compressing and releasing it several times. The lever **MUST** return to the idle position quickly and completely.

■ **NOTE:** If the throttle control lever operates properly and the engine does not start, compress the throttle lever slightly (approximately 1/8 throttle) and try starting the engine. If the engine now starts and stops when the throttle lever is released, take the snowmobile to an authorized Arctic Cat Snowmobile dealer for service. If not under warranty, this service is at the discretion and expense of the snowmobile owner.

WARNING

If the throttle control lever does not work properly, **DO NOT ATTEMPT TO START THE ENGINE.**

4. If the throttle control lever operates properly, rotate the ignition key to the RUN position and go through normal starting procedures.

■ **NOTE:** On fan-cooled models if the throttle control lever operates properly and the engine does not start, either a malfunctioning monitor switch or a misadjusted magnetic carburetor switch (on twin carburetor models) may be the problem. Take the snowmobile to an authorized Arctic Cat Snowmobile dealer for service. If not under warranty, this service is at the discretion and expense of the snowmobile owner. However, if a dire emergency exists wherein the engine must be started, disconnect the throttle control wiring harness located below the handlebar pad and next to the steering post. If disconnection of the throttle control wiring harness is needed to start the engine, take the snowmobile to an authorized Arctic Cat Snowmobile dealer for service as soon as possible. If not under warranty, this service is at the discretion and expense of the snowmobile owner.

■ **NOTE:** On F-Series/Jaguar Z1 models if the throttle control lever operates properly and the engine does not start, a malfunctioning monitor switch may be the problem. Take the snowmobile to an authorized Arctic Cat Snowmobile dealer for service. If not under warranty, this service is at the discretion and expense of the snowmobile owner. However, if a dire emergency exists wherein the engine must be started, disconnect the throttle monitor switch located in the right-side handlebar control.

■ **NOTE:** On F-Series/Jaguar Z1 models if disconnection of the throttle monitor switch is needed to start the engine, take the snowmobile to an authorized Arctic Cat Snowmobile dealer for service as soon as possible. If not under warranty, this service is at the discretion and expense of the snowmobile owner.

WARNING

Under no circumstances should disconnection of the throttle control wiring harness be used as a substitute for the monitor switch during normal operation of the snowmobile. Personal injury and damage could occur if the throttle system malfunctions or if the operator is unable to stop the engine in an emergency. If the snowmobile must be operated with a disconnected throttle control wiring harness, **EXTREME CAUTION MUST BE TAKEN. NEVER EXCEED 10 MPH WITH THE THROTTLE CONTROL WIRING HARNESS DISCONNECTED.**

■ **NOTE:** The monitor switch is now bypassed. With exception of the monitor switch and the emergency stop switch, all other ignition/ electrical features (ignition switch, headlight, taillight, and brakelight) will operate properly.

VARYING ALTITUDE OPERATION

Operating a snowmobile at varying altitudes requires changes in performance components. These changes affect drive train components (on all models) and carburetion components (on carbureted models).

The altitude information decal is located beneath the hood of the snowmobile. On carbureted models, the information is incorporated into the Main Jet Chart decal.

■ **NOTE:** Just as important as calibrating the snowmobile for higher altitudes is recalibrating the snowmobile when going to lower altitudes. Always consult the altitude decal beneath the hood of the snowmobile.

CAUTION

On carbureted models, carefully follow the Main Jet Chart recommendations for proper main jet selection for altitude, temperature, and gasoline being used.

M-Series models are initially set up at the factory for operation between 6000-9000 feet.

■ **NOTE:** Carburetion and drive train changes can be made by the snowmobile owner if qualified to do so. If the owner does not feel qualified, take the snowmobile to an authorized Arctic Cat Snowmobile dealer for this service. This service is at the discretion and expense of the snowmobile owner.

LUBRICATION

STANDARD CHAIN CASE (Every 40 Operating Hours)

The recommended amount of transmission lube in the chain case is 236 ml (8 fl oz) for models without reverse and 354 ml (12 fl oz) for models with reverse. Adding more transmission lube to the chain case (above the recommended amount) may result in leakage. To check the transmission lube level, use the following procedure:

1. With the snowmobile level, shut engine off and wait for all moving parts to stop; then open the hood.
2. Remove the oil level stick from the chain case cover. Wipe the oil level stick clean; then thread the oil level stick completely back into the chain case (without reverse) or install the oil level stick completely back into the chain case (with reverse). Remove the oil level stick again and check the lubricant level.

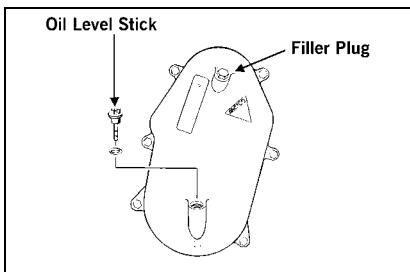

728-948A

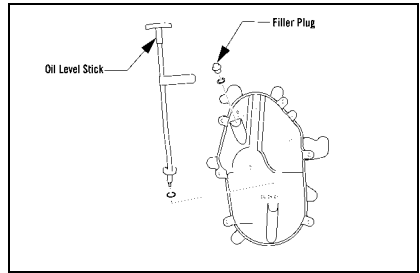

0737-715

3. If the lubricant level is above the ADD mark (without reverse) or above the LOW mark (with reverse), the lubricant level is satisfactory. If the lubricant level is at or below the mark, proceed to step 4.
4. If oil is low, remove the filler plug and add transmission lube through the filler plug hole. When the oil level is correct, install both the filler plug and the oil level stick.

■ **NOTE:** If excessive oil deposits are noticed, take the snowmobile to an authorized Arctic Cat Snowmobile dealer for service. If not under warranty, this service is at the discretion and expense of the snowmobile owner.

 CAUTION	
The correct lubricant to use in the chain case is Arctic Cat Transmission Lube (p/n 0636-817). Any substitute may cause premature chain failure or serious damage to the chain drive system.	

ACT DRIVE GEAR CASE (Each Season Prior to Storage)

■ **NOTE:** Flushing the gear case and replacing the lubricant can be done by the snowmobile owner if qualified to do so. If the owner does not feel qualified, take the snowmobile to an authorized Arctic Cat dealer for this service. If not under warranty, this service is at the discretion and expense of the snowmobile owner.

It is very important that the gear case be flushed and the lubricant be replaced after each season of use. Arctic Cat recommends that the flushing and replacing be done prior to off-season storage.

To flush the gear case and replace the lubricant, use the following procedure:

1. Open the left-side access panel; then remove the panel.

■ **NOTE:** On the Crossfire/M-Series, remove the belt guard.

2. Remove the drive belt (see Drive Belt sub-section); then remove the driven pulley.

■ **NOTE:** If excessive oil deposits are noticed, take the snowmobile to an authorized Arctic Cat Snowmobile dealer for service. If not under warranty, this service is at the discretion and expense of the snowmobile owner.

F-Series/Jaguar Z1

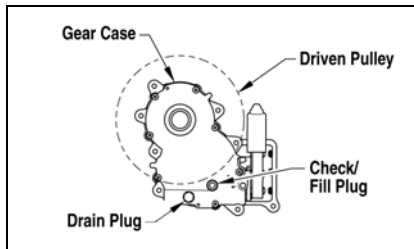

0741-334

Crossfire/M-Series

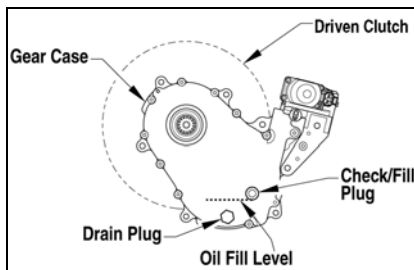

741-636A

3. Tip the snowmobile onto its right side and place a piece of cardboard underneath to protect the finish on the hood and belly pan.

■ **NOTE:** It is recommended that the gas tank be nearly empty (less than 1/4 full) when tipping the snowmobile.

4. Remove the drain plug from the gear case; then install a drain adapter fitting with hose into the drain plug hole.

■ **NOTE:** To aid in draining the lubricant, it is advisable to fashion a drain adapter by acquiring a fitting and a length of 3/8-in. hose.

5. Tip the snowmobile back to the upright position; then place a drain pan on the floor next to the drain hose and tip the snowmobile toward its left side far enough to allow the lubricant to drain from the gear case into the drain pan.

■ **NOTE: It is critical that the snowmobile is on a level surface to ensure the lubricant drains properly and completely.**

6. Secure the snowmobile in this position until the lubricant is completely drained.

 **CAUTION**

It is critical that all of the old lubricant be drained from the gear case prior to flushing the gear case.

7. When the lubricant has completely drained from the gear case, tip the snowmobile back to the upright position, remove the drain adapter, and install and securely tighten the drain plug; then remove the check/fill plug.
8. Pour the recommended amount of Arctic Cat ACT Gear Case Flush (p/n 4639-333) into the check/fill hole; then install the plug. Tighten securely.

 **CAUTION**

Do Not add more or less than the recommended amount of flush fluid to the gear case.

9. Install the driven pulley; then install the drive belt (see Drive Belt sub-section).

■ **NOTE: On the Crossfire/M-Series, install the belt guard.**

10. Install the left-side access panel; then close the access panel.
11. Position the tips of the skis against a wall; then using a shielded safety stand, raise the rear of the snowmobile off the floor making sure the track is free to rotate.

 **WARNING**

The tips of the skis must be positioned against a wall or similar object.

 **WARNING**

DO NOT stand behind the snowmobile or near the rotating track. NEVER run the track at high speed when the track is suspended.

12. Start the engine and accelerate slightly. Use only enough throttle to turn the track several revolutions. SHUT ENGINE OFF.
13. Open the left-side access panel; then remove the panel.

■ **NOTE: On the Crossfire/M-Series, remove the belt guard.**

14. Remove the drive belt (see Drive Belt sub-section); then remove the driven pulley.

15. Tip the snowmobile onto its right side and place a piece of cardboard underneath.
16. Remove the drain plug from the gear case; then install the drain adapter fitting with hose into the drain plug hole.
17. Tip the snowmobile back to the upright position; then place a drain pan on the floor next to the drain hose and tip the snowmobile toward its left side far enough to allow the flush fluid to drain from the gear case into the drain pan.
18. Secure the snowmobile in this position until the flush fluid is completely drained.
20. Pour the exact amount (see specification sheet) of Arctic Cat ACT Drive Fluid lubricant into the check/fill hole; then install the plug. Tighten securely.
21. Install the driven pulley; then install the drive belt (see Drive Belt sub-section).
22. Install the left-side access panel; then close the access panel.

 **CAUTION**

It is critical that all of the flush fluid be drained from the gear case prior to filling with new lubricant.

19. When the fluid has completely drained from the gear case, tip the snowmobile back to the upright position, remove the drain adapter, and install and securely tighten the drain plug; then remove the check/fill plug.

 **CAUTION**

The correct lubricant to use in the gear case is Arctic Cat ACT Drive Fluid (p/n 4639-362) for models with reverse or (p/n 4639-361) for models without reverse. Any substitute may cause serious damage to the drive system.

 **CAUTION**

Do Not add more or less than the recommended amount of lubricant to the gear case or damage to the gear case will occur.

■ **NOTE: On the Crossfire/M-Series, install the belt guard.**

FRONT SUSPENSION

■ **NOTE: Arctic Cat recommends that Arctic Cat Low-Temp Grease (p/n 0636-593) be used for this procedure.**

It is very important that the front suspension is greased on a monthly basis using low-temperature grease. The front suspension should also be greased after trailering the snowmobile on an open trailer. Pump grease into the spindle grease fitting (both sides) until grease is noted coming out of the top and bottom of the spindle. Wipe excess grease from the spindle.

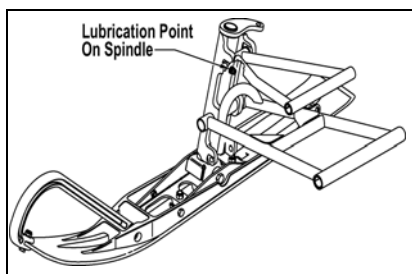

0739-724

F-Series/Jaguar Z1

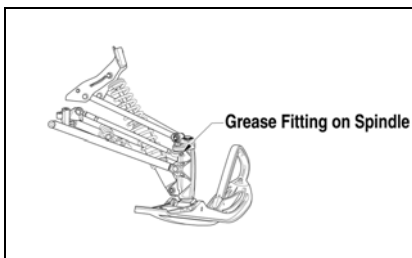

741-335A

On the Crossfire/F-Series/M-Series/Jaguar Z1 models, pump grease into the upper steering shaft grease fitting (located on the right-side of the snowmobile directly above the forward part of the upper A-arm) until grease is noted coming out of the bottom of the shaft. Wipe excess grease from the shaft.

Crossfire/M-Series

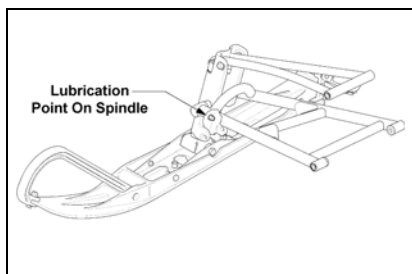

0737-294

F-Series/Jaguar Z1

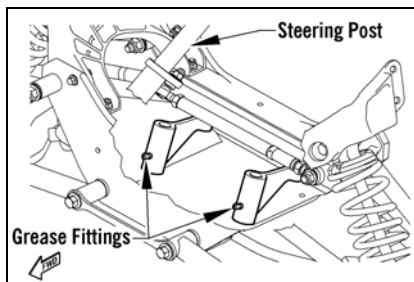

0741-440

SPEEDOMETER DRIVE ADAPTER - Bearcat W/T Non-Turbo/ Bearcat 570/Panther/ Z Models (Semi-Annually)

■ **NOTE:** Arctic Cat recommends that Arctic Cat Low-Temp Grease (p/n 0636-593) be used for this procedure.

1. Shut the engine off and wait for all moving parts to stop; then open the hood.
2. Using low-temperature grease, lubricate the fitting on the speedometer drive adapter until grease is noted coming out along the edge of the drive adapter.

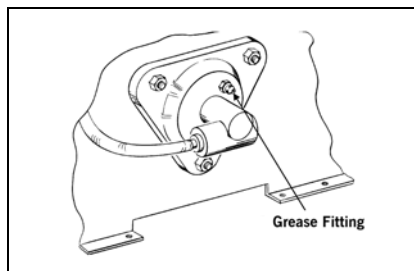

0727-472

REAR SUSPENSION (Every 40 Operating Hours)

■ **NOTE:** Arctic Cat recommends that Arctic Cat Low-Temp Grease (p/n 0636-593) be used for this procedure.

■ **NOTE:** Determine which style rear suspension is being lubricated and locate the grease fittings accordingly.

1. Shut engine off and wait for all moving parts to stop.
2. With the gas tank nearly empty (less than 1/4 full), lay the snowmobile on its left side. A piece of cardboard should be used to protect the finish on the hood and belly pan.

 CAUTION	
<p>The 660 cc models should not be tipped on their sides for any reason, as engine oil may seep into the upper engine through the air-intake system. Severe engine damage could result if the engine is run with oil in the upper engine.</p>	

3. Remove ice and snow buildup from the skid frame to expose the grease fittings.

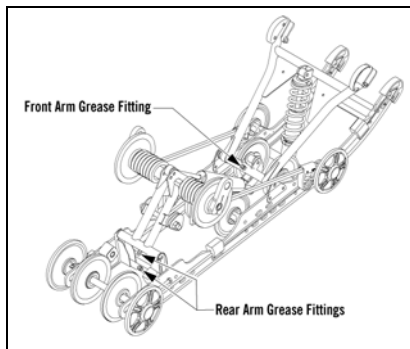

0741-376

4. Lubricate the grease fittings with low-temperature grease.

MAINTENANCE

PERIODIC MAINTENANCE CHECKLIST

ITEM	INTERVAL	PAGE	REMARKS
Air Filter (660 cc Turbo)	2000 miles/ Seasonal	—	Replace
Brake System (Hydraulic)	Daily	68	Check for binding, leakage, and proper operation; lever firmness, travel, caliper, disc, and pads
Brake System (Mechanical)	Daily	66	Check for binding, sticking, and proper operation; lever travel, cable, spring, caliper, and disc
Cooling System - Liquid	Daily	20	Check for leakage, damage, obstructions, coolant level
Cooling System - Fan Belt	Monthly	91	Check tightness and for wear, damage, and obstructions
Charging System - Accessory Belt (660 cc)	Monthly	92	Check tightness and for wear, damage, and obstructions
Oil System	Daily	48-49	Check for leakage, damage, and injection/engine oil level
Engine Oil (660 cc Standard)	2500-3000 miles/ Seasonal	49	Change oil and filter
Engine Oil (660 cc Turbo)	2000 miles/ Seasonal	49	Change oil and filter
Engine Oil (Jaguar Z1)	2500 miles/ Seasonal	50	Change oil and filter
Battery	Daily	19 62	Check for proper charge and tight connections
Stop Switch	Daily	—	Check for proper operation
Hoses	Daily	—	Check for damage, leakage, and routing
Headlight & Taillight/Brakelight	Daily	83	Check for proper operation and cleanliness
Steering System	Daily	—	Check for proper operation, tightness of bolts, and binding
Throttle Control System	Daily	37	Check for binding, sticking, proper operation, throttle cable tension, and routing
Drive Belt	Daily Monthly	72	Check for wear, cracks, and fraying Check length and width dimensions
Ski Wear Bars	Daily	89	Check for wear and damage
Carburetors - Main Jets - Adjustment Screws	Daily Weekly	58 52-58	Install proper main jets Adjust according to specifications
Electrical Wiring	Weekly	—	Check for wear, damage, tight connections, and routing
Exhaust System	Weekly	19	Check for damage, leakage, and obstructions
Nuts, Bolts, Fasteners	Weekly	—	Check tightness
Recoil Starter	Weekly	—	Check rope for wear, fraying, and proper operation
Shock Absorbers	Weekly	22	Check for fluid leakage and damage
Spark Plugs (2-Stroke)	Weekly	59	Check center electrode insulator color, carbon, and gap
Valve Clearance (660 cc)	3500 miles/ Seasonal	62	Check/adjust
Valve Clearance (1100 cc Z1)	5000 miles/ Seasonal	62	Check/adjust
Suspension	Weekly	79	Check for damage, loose components, and proper adjustment
Track Tension/Alignment	Weekly	76 78	Check/adjust as necessary
Wear Strips	Weekly	91	Check for wear and damage
Wires & Cables	Weekly	—	Check for wear, damage, and routing
Fuel System - Tank, Pump, In-Line Filter, & Vent Hose	Weekly	—	Check for damage, wear, obstructions, and leakage
Fuel Filter (660 cc/1100 cc Z1)	5000 miles/ 2 years	—	Replace
APV System	Monthly	28	Check/adjust as necessary
Standard Chain Case	Monthly	40	Check lube level and for leakage
ACT Drive Gear Case	Seasonal	41	Change drive fluid prior to storage
Heat Exchangers	Monthly	—	Check for wear, leakage, and damage
Drive Clutch/Driven Pulley	Monthly	20-21	Check for damage, abnormal noise, vibration, binding, and sticking and clean off drive belt deposits
Front & Rear Suspension	Monthly	43 45	Grease

The longevity and safety of the snowmobile can be increased by making periodic checks of the items in the preceding checklist.

If, at any time, abnormal noises, vibrations, or improper working conditions of any component of this snowmobile are detected, **DO NOT OPERATE THE SNOWMOBILE.** Take the snowmobile to an authorized Arctic Cat Snowmobile dealer for inspection and adjustment or repair.

The snowmobile should be taken to an authorized Arctic Cat Snowmobile dealer at the end of each snowmobiling season for general inspection and for off-season storage servicing. This inspection and servicing is at the expense of the snowmobile owner.

FUEL SYSTEM

WARNING

Whenever any maintenance or inspection is made on the fuel system in which there may be fuel leakage, there should be no welding, smoking, open flames, etc., in the area.

In-Line Fuel Filter (Carbureted Models)

Arctic Cat recommends that the in-line fuel filter be checked weekly. The in-line fuel filter is located just in front of the fuel pump inlet fitting. The filter must be clean to allow the fuel hose to transmit the amount of gasoline required.

If the in-line fuel filter is obstructed, gasoline flow will be restricted; therefore, the filter must be replaced. To remove and install the in-line fuel filter, use the following procedure:

■ **NOTE: Determine which style in-line fuel filter is being replaced and remove and install accordingly.**

1. On models with a gas tank shut-off valve, turn the gas tank shut-off valve to the CLOSED position.
2. Using a screwdriver, pry the fuel hoses off the in-line fuel filter and remove the filter.

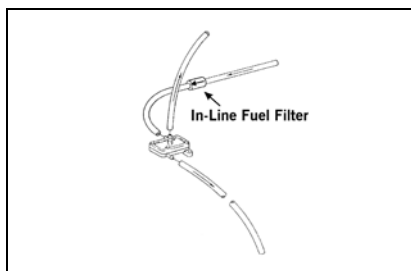

728-065A

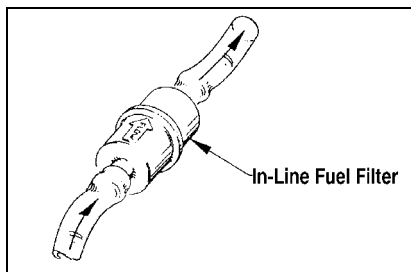

728-272B

■ **NOTE: The in-line fuel filter must be replaced if obstructed. Filters are available from an authorized Arctic Cat Snowmobile dealer.**

3. Install the in-line fuel filter in the fuel hose so the arrow on the filter points toward the fuel pump. Make sure the fuel hoses fit tightly on the filter. If a fuel hose does not fit tightly, cut 6 mm (1/4 in.) from the end of the fuel hose; then install on the filter.

WARNING

The fuel hoses must fit tightly on the fuel filter. If the fuel hose length doesn't permit this procedure, replace the fuel hose. Also, after installing the fuel hoses on the filter, check to be sure that the fuel hoses do not contact any hot or rotating components.

4. If applicable, turn the gas tank shut-off valve to the OPEN position.

Gasoline Additives

Fuel de-icer can be used for all models. Also, periodic use of an injector cleaner for EFI models is recommended especially in the last tank of gasoline before storage. Arctic Cat Fuel Stabilizer (p/n 0638-165) should also be added to the last tank of gasoline before storage.

Fuel Pickup Valves

All 2-Stroke EFI models are equipped with fuel pickup valves in the gas tank. If ever there is a restricted fuel flow and a pickup valve is suspected, take the snowmobile to an authorized Arctic Cat Snowmobile dealer for this service. If not under warranty, this service is at the discretion and expense of the snowmobile owner.

CHECKING ENGINE OIL LEVEL (660 cc Models)

■ **NOTE:** The snowmobile must be on a level surface for this procedure.

1. Open the hood and pull up on the oil level stick until the top mark on the stick is even with the top of the oil level stick tube. Wait 30 seconds before proceeding.

■ **NOTE:** Failure to perform step 1 as stated will result in an inaccurate reading.

2. After 30 seconds, remove the oil level stick and wipe it with a clean cloth. Insert the oil level stick fully into the engine and remove. Read the oil level shown on the oil level stick. The oil level must be between the two marks on the bottom end of the stick.

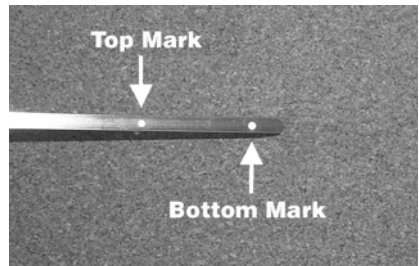

AA054B

3. If the oil level is at or below the bottom mark on the oil level stick, add recommended oil until the oil level is slightly below the top mark on the bottom end of the stick.

■ **NOTE:** It takes 800 ml (27 fl oz) to raise the oil level from the lower mark to the upper mark on the bottom end of the stick.

CHECKING ENGINE OIL LEVEL (Jaguar Z1)

1. Park the snowmobile on a level surface; then start the engine and allow it to warm up for 10-15 minutes, or if the snowmobile was operated, allow the engine to idle for approximately 30 seconds.

■ **NOTE:** The snowmobile must be on a level surface for this procedure.

2. Shut the engine off; then remove the oil level stick from the oil reservoir. Wipe the stick clean.

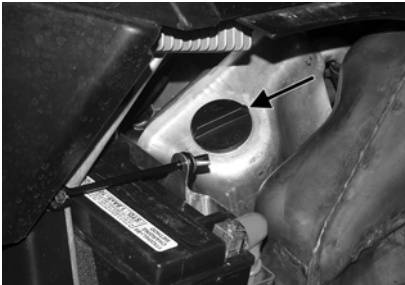

ZJ002A

3. Insert the oil level stick into the oil reservoir without threading it in and remove. Read the oil level shown on the stick. The oil level should be near the middle of or on the high end of the NORMAL range on the stick.

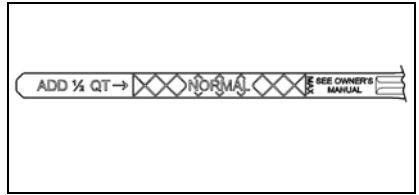

0741-490

■ **NOTE:** To attain an accurate oil level reading, do not thread the stick into the reservoir.

4. If step 1 was followed and the oil level is at or below the ADD mark, add up to 1/2 qt of recommended engine oil.

■ **NOTE:** Care must be taken not to over-fill the reservoir with oil.

5. Repeat steps 3-4 until the oil level is within the recommended range on the oil level stick.

CHANGING ENGINE OIL (660 cc Models)

■ **NOTE:** The oil should be changed when the engine is warm to allow all oil to drain from the crankcase.

WARNING

Care must be taken if a hot drain plug is removed by hand. Burning could occur.

■ **NOTE:** Recycle or properly dispose of the used engine oil.

1. Using a putty knife, remove the belly pan plug.

- Place a drain pan beneath the belly pan plug hole; then remove the oil drain plug and washer from the underside of the crankcase.
- Remove the oil fill cap from the top of the engine.
- After the oil has drained completely, install the oil drain plug and washer and tighten to 2.3 kg-m (16.5 ft-lb).
- Install a new belly pan plug.
- Remove the oil filter using Oil Filter Wrench (p/n 0644-389).
- Apply a light coat of fresh engine oil to the gasket of the new oil filter.
- Install the new oil filter by turning the oil filter by hand until the gasket has contacted the oil filter mounting surface; then tighten the oil filter 3/4 turn by hand.
- Pour 2.9 l (3 U.S. qt) of the recommended engine oil into the oil fill tube; then check the oil level.

CHANGING ENGINE OIL/FILTER (Jaguar Z1)

WARNING

Care must be taken if a hot drain plug is removed by hand. Burning could occur.

■ **NOTE:** Recycle or properly dispose of the used engine oil.

- Using a putty knife, remove the belly pan plug.

- Park the snowmobile on a level surface; then start the engine and allow it to warm up for 10-15 minutes, or if the snowmobile was operated, allow the engine to idle for approximately 30 seconds.
- Shut the engine off; then place drain pans beneath both engine oil drain plugs (crankcase and oil reservoir).

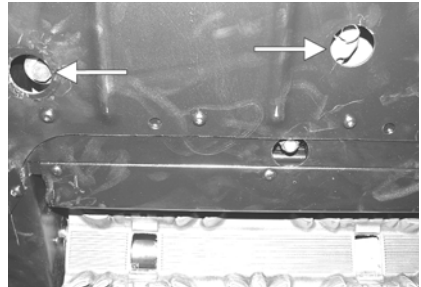

ZJ003A

- Remove the drain plugs and allow the oil to drain completely.

■ **NOTE:** At this point, remove the strainer from the oil reservoir to allow the oil to drain completely.

- After the oil has drained completely, install the oil strainer, drain plugs, and washers and tighten to 2.1 kg-m (15 ft-lb).

■ **NOTE:** Always install a new crankcase drain plug Washer (p/n 3007-101) and a new reservoir Washer (p/n 1670-845) when changing the oil.

- Install a new belly pan plug.

7. Using Oil Filter Wrench (p/n 0644-389), loosen (but do not remove) the oil filter and allow the oil to drain from the filter; then remove the filter.
8. Apply a light coat of fresh engine oil to the seal of the new oil filter.
9. Install the new oil filter by turning the oil filter by hand until the seal has contacted the oil filter mounting surface; then tighten the oil filter to 2.1 kg-m (15 ft-lb).
10. Pour 2.9 l (3 U.S. qt) of the recommended engine oil into the oil reservoir.
11. Open the air bleed bolt located on the oil pump (beneath the coolant tank) to purge air from the oil hose.

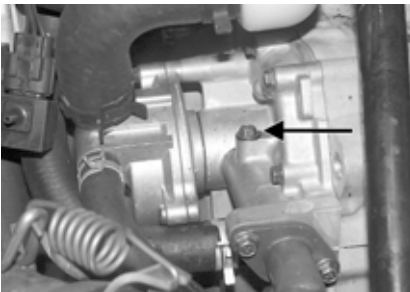

ZJ004A

■ **NOTE:** When air can no longer be heard purging from oil pump bleed, tighten the bleed bolt to 1.05 kg-m (7.5 ft-lb).

12. Without starting the engine, place the handlebar emergency stop switch to the RUN position and the ignition switch to the ON position. The Oil Pressure Warning Light should illuminate.

■ **NOTE:** If the warning light does not illuminate, take the snowmobile to an authorized Arctic Cat Snowmobile dealer for service.

13. If the warning light illuminates (from step 12), start the engine. The warning light should go out within five seconds. If it does, proceed to step 14.

■ **NOTE:** If the warning light does not go out, shut the engine off immediately and repeat step 11; then place the ignition switch to the ON position and repeat step 13. If the warning light does not go out, take the snowmobile to an authorized Arctic Cat Snowmobile dealer for service.

14. Shut the engine off and pour the remaining amount (0.9 l or 1 U.S. qt) of recommended oil into the oil reservoir; then proceed to Checking Engine Oil Level subsection to verify and finalize the procedure.

ADJUSTING CARBURETOR (Single)

The carburetor has been calibrated at the factory for average riding conditions; however, altitude, temperature, and general wear may necessitate certain carburetor adjustments. **Be sure the correct carburetor main jet for the operating temperature, altitude, and type of gasoline is being used (see Selecting Carburetor Main Jet(s) section).** Since carburetor adjustments critically affect engine performance, Arctic Cat recommends that all changes in internal carburetor calibration be made by an authorized Arctic Cat Snowmobile dealer; however, four external adjustments can be made on the carburetor. These are the choke cable travel, piston valve, pilot air screw, and idle speed screw. Due to cable "stretch," it is recommended to check throttle cable tension periodically and adjust the swivel adapter as necessary.

■ **NOTE:** Carburetor adjustments and changing the main jet may be done by the snowmobile owner if qualified to do so. If the owner does not feel qualified, take the snowmobile to an authorized Arctic Cat Snowmobile dealer for this service. This service is at the discretion and expense of the snowmobile owner.

Adjusting Choke Cable

1. Be sure the ignition switch key is in the OFF position and the parking brake is set.

2. Loosen the jam nut securing the choke cable adjuster. Rotate the choke cable adjuster clockwise until it bottoms against the brass plunger cap.
3. Slowly rotate the choke cable adjuster counterclockwise while checking the choke lever for free-play. As soon as all free-play has been removed from the end of the lever, stop rotating the adjuster.
4. With free-play removed from the lever, slowly rotate the choke cable adjuster once again clockwise while checking the choke cable lever for free-play. Adjust until 3 mm (1/8 in.) free-play between front bottom edge of lever and housing is attained. Securely tighten the adjuster jam nut.

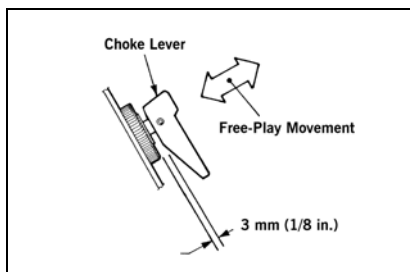

732-848B

Adjusting Piston Valve

1. Remove the air-intake silencer boot; then rotate the idle speed screw counterclockwise until all spring tension is removed.

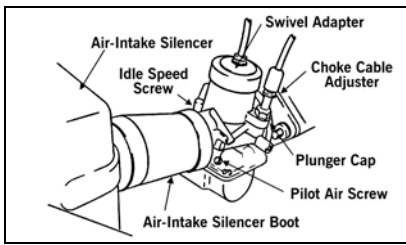

0727-156

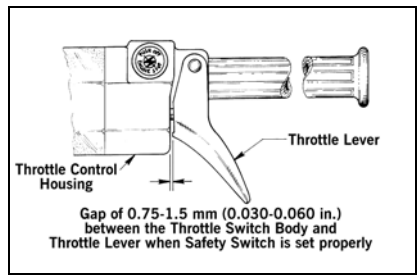

733-081C

2. Loosen the jam nut securing the throttle cable swivel adapter; then rotate the swivel adapter clockwise until the piston valve bottoms in the piston valve bore.
3. Place a finger lightly against the side of the valve; then rotate the carburetor swivel adapter counterclockwise until slight upward movement of the valve is noted.
4. Place a finger against the valve. Rotate the idle speed screw clockwise until it contacts the valve.
5. Compress the throttle lever to the full-open position; then rotate the idle speed screw clockwise 2 complete turns. Release the throttle lever.

■ **NOTE:** There must be free-play between the throttle lever and the control housing.

6. At this point, there must be cable free-play gap in the throttle lever.

■ **NOTE:** If no cable free-play gap is detected, rotate the swivel adapter until free-play is achieved. The piston valve must be resting against the tip of its idle speed screw.

Adjusting Pilot Air Screw

1. While counting the rotations, carefully rotate the pilot air screw clockwise until lightly seated.

⚠ CAUTION

Do not force a pilot air screw when rotating it clockwise; damage to the pilot air screw needle tip will result.

2. Rotate the pilot air screw counterclockwise the exact number of rotations $\pm 1/4$ turn from the seated position for an initial setting.
3. Install the air-intake silencer boot taking care that the boot is properly positioned and that the boot is not “folded” in the air-intake silencer causing a restriction of air flow.

Adjusting Engine Idle Speed

1. With the snowmobile on a shielded safety stand, start the engine, release the parking brake, and thoroughly warm up. “Fine-tune” the idle speed screw and the pilot air screw until the engine idles smoothly at the desired RPM (1500 RPM is recommended).

WARNING

DO NOT stand behind the snowmobile or near the rotating track. NEVER run the track at high speed when the track is suspended.

WARNING

If a tachometer is not available, care must be taken not to adjust engine idle speed too high.

■ **NOTE:** Make engine idle adjustment only after the engine has reached running temperature.

■ **NOTE:** If the engine does not start after the carburetor has been adjusted, repeat steps 2-6 of Adjusting Piston Valve subsection. If all cable slack is “taken up,” the throttle/ignition monitor switch will prevent the ignition system from firing the spark plugs.

WARNING

DO NOT operate the snowmobile when any component in the throttle system is damaged, frayed, kinked, worn, or improperly adjusted. If the snowmobile is operated when the throttle system is not functioning properly, personal injury could result.

ADJUSTING CARBURETORS (Twin)

The carburetors have been calibrated at the factory for average riding conditions; however, altitude, temperature, and general wear may necessitate certain carburetor adjustments. **Be sure the correct carburetor main jets for the operating temperature, altitude, and type of gasoline are being used (see Selecting Carburetor Main Jet(s) section).** Since carburetor adjustments critically affect engine performance, Arctic Cat recommends that all changes in internal carburetor calibration and piston valve synchronization be made by an authorized Arctic Cat Snowmobile dealer; however, four external adjustments can be made on each carburetor.

These are the choke cable travel, piston valves, pilot air screws, and idle speed screws.

■ **NOTE:** Carburetor adjustments and changing main jets may be done by the snowmobile owner if qualified to do so. If the owner does not feel qualified, take the snowmobile to an authorized Arctic Cat Snowmobile dealer for this service. This expense is at the discretion and expense of the snowmobile owner.

⚠ CAUTION

Make sure to perform these adjustment/synchronization procedures on all carburetors.

Adjusting Choke Cable

1. Be sure the ignition switch key is in the OFF position and the brake lever lock is set.
2. Loosen the jam nut securing each choke cable adjuster. Rotate each choke cable adjuster clockwise until it bottoms against the brass plunger cap.

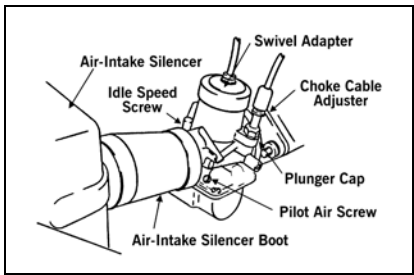

0727-156

3. Slowly rotate one choke cable adjuster counterclockwise while checking the choke lever for free-play. As soon as all free-play has been removed from the end of the lever, stop rotating the adjuster.
4. With free-play removed from the lever, slowly rotate each choke cable adjuster once again clockwise while checking the choke cable lever for free-play. Adjust until 3 mm (1/8 in.) free-play between front bottom edge of lever and housing is attained. Securely tighten the adjuster jam nut.

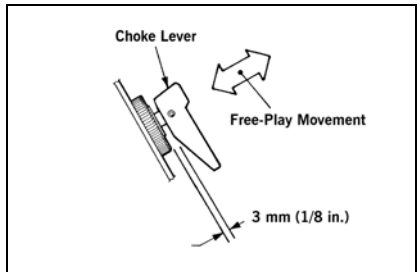

732-848B

■ **NOTE:** If a carburetor choke cable is adjusted too tight, the engine will only operate on one cylinder at idle.

Synchronizing Piston Valves

■ **NOTE:** On some models, the air-intake silencer is a one-piece unit, and the silencer boots can be removed to access the intake bores. Remove the boots; then proceed to step 4.

■ **NOTE:** On some models, the air-intake silencer includes a cover/tool tray assembly and a baffle/resonator, and the silencer boot cannot be removed to access the intake bores. Proceed to step 1.

1. Open the air-intake silencer cover; then remove the screws securing the cover/tool tray assembly to the silencer.
2. Close the cover; then tip the cover/tool tray assembly forward and out of its slots and remove the assembly.
3. Using a large flat-blade screwdriver, remove the baffle/resonator tabs from the air-intake silencer slots and remove the baffle/resonator to access the intake bores.

■ **NOTE:** The baffle/resonator can be removed more easily by removing the back tabs first.

4. Rotate the idle speed screws counterclockwise until all spring tension is removed.

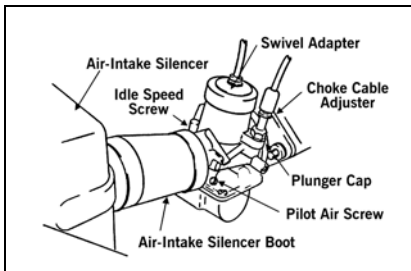

0727-156

5. Loosen the jam nut securing each throttle cable swivel adapter; then rotate each swivel adapter clockwise until each piston valve bottoms in the piston valve bore.
6. In turn on each carburetor, place a finger lightly against the side of the piston valve; then rotate the carburetor swivel adapter counterclockwise until slight upward movement of the valve is noted.
7. Check to make sure the valves start to open at the exact same moment by placing a thumb and finger against the valves; then lightly compress the throttle lever.

■ **NOTE:** If an individual piston valve starts to open before another, rotate the swivel adapter on the valve which is lifting first clockwise, just enough to synchronize the valves. Recheck by repeating steps 4-7.

8. With the piston valves synchronized, tighten the swivel adapter jam nuts securely. Slide the rubber throttle cable caps down over the swivel adapters.

■ **NOTE:** There must be free-play in the throttle lever on all models.

WARNING

Be sure to tighten the swivel adapter jam nuts securely. If a swivel adapter jam nut is not tightened, the adjuster can rotate out of the carburetor cap causing the piston valve not to return to the full-closed position.

9. In turn on each carburetor, place a finger against the piston valve. Rotate the idle speed screw clockwise until it contacts the valve.
10. Compress the throttle lever to the full-open position; then rotate each idle speed screw clockwise 2 complete turns. Release the throttle lever.

■ **NOTE:** There must be 0.75-1.5 mm (0.030-0.060 in.) free-play between the throttle lever and the control housing.

11. At this point, there must be 0.75-1.5 mm (0.030-0.060 in.) of cable free-play gap in the throttle lever. If there is no cable free-play in the throttle lever, the throttle safety switches will not function properly, and the engine will cut out in the idle position.

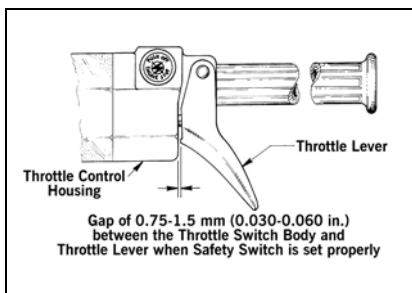

733-081C

■ **NOTE:** If cable free-play gap is not correct, rotate each swivel adapter an equal amount until recommended free-play is achieved. Each piston valve must be resting against the tip of its idle speed screw.

■ **NOTE:** If throttle cable free-play is incorrect, the carburetor safety switches will be activated prematurely and the engine will not start.

Fine-Tuning Pilot Air Screws and Idle Speed Screws

1. While counting the rotations, carefully rotate the pilot air screws clockwise until lightly seated.

CAUTION

Do not force a pilot air screw when rotating it clockwise; damage to the pilot air screw needle tip will result.

2. Rotate the pilot air screws counterclockwise the exact number of rotations $\pm 1/4$ turn from the seated position as an initial setting.
3. On some models, install the air-intake silencer boots taking care that the boots are properly positioned and that the boots are not "folded" in the air-intake silencer causing a restriction of air flow.
4. On some models, install the baffle/resonator and the cover/tool tray assembly.

5. With the snowmobile on a shielded safety stand, start the engine, release the brake lever lock, and thoroughly warm up.

 **WARNING**

DO NOT stand behind the snowmobile or near the rotating track. NEVER run the track at high speed when the track is suspended.

■ **NOTE:** Make engine idle adjustment only after the engine has reached running temperature. Since the idle speed screws have not been fine-tuned, slight throttle pressure may be necessary to keep the engine running. Allow engine to warm up for 2-3 minutes.

6. After the engine has been thoroughly warmed up, fine-tune the pilot air screws (equally) and the idle speed screws (equally) until the engine runs smoothly.

■ **NOTE:** If a tachometer is being used, engine idle RPM should be approximately 1500.

 **WARNING**

If a tachometer is not available, care must be taken not to adjust engine idle speed too high.

 **CAUTION**

It is important that the pilot air screws are adjusted equally and that the idle speed screws are adjusted equally.

7. Test the throttle control lever by compressing and releasing it several times. The lever must return to the idle position quickly and completely.

 **WARNING**

DO NOT operate the snowmobile when any component in the throttle system is damaged, frayed, kinked, worn, or improperly adjusted. If the snowmobile is operated when the throttle system is not functioning properly, personal injury could result.

SELECTING CARBURETOR MAIN JET(S)

Altitude, temperature, and the use of oxygenated gasoline affect the carburetion needed for optimum engine performance. The carburetor main jet(s) must be changed in conjunction with changes in operating altitude, oxygenated gasoline usage, and temperature. As the ambient temperature rises or as the snowmobile is operated at a higher altitude, the main jet(s) must be replaced with leaner main jet(s). The original equipment (production) main jet(s) may need to be changed (depending on the type of gasoline you are using, your operating altitude, and temperature). A Main Jet Chart decal is located beneath the hood of the snowmobile. It should be noted that when selecting the proper main jet(s), it is better to be too rich rather than too lean. To change carburetor main jet(s), use the following procedure:

CAUTION

Use only **GENUINE Mikuni brass main jets**. Also, if using an oxygenated gasoline (up to 10% ethanol or up to 15% MTBE), the carburetor main jet must be one size larger than the main jet required for regular unleaded gasoline.

■ **NOTE:** Carburetor main jet(s) may be changed by the snowmobile owner if qualified to do so. If the owner does not feel qualified, take the snowmobile to an authorized Arctic Cat Snowmobile dealer for this service. This service is at the discretion and expense of the snowmobile owner.

CAUTION

A main jet which is too small will cause severe engine damage. Engine damage caused by lean jetting **WILL NOT BE** covered by our warranty policy.

WARNING

Whenever any maintenance is performed on the fuel system, there should be no welding, smoking, open flames, etc., in the area.

1. Loosen each carburetor flange clamp and remove each carburetor from the intake flange and boot.
2. Remove each drain plug and O-ring from the carburetor float chamber and drain the gas into a small container or shop towels.

3. Using the main jet wrench (from the tool kit), thread the main jet out of each carburetor. Account for the baffle ring/washer. Install the new main jet and the existing baffle ring/washer. Tighten the main jet securely.

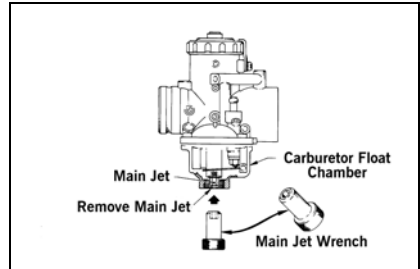

0728-054

4. Install each drain plug and O-ring; then tighten securely.
5. Install and secure the carburetors.

SPARK PLUGS (1100 cc Z1)

■ **NOTE:** If spark plugs must be replaced, take the snowmobile to an authorized Arctic Cat Snowmobile dealer for inspection and service. If not under warranty, this service is at the discretion and expense of the snowmobile owner.

SPARK PLUGS

■ **NOTE:** Always use the recommended spark plugs in the engine. See the appropriate specifications chart for correct spark plug gap.

Varying terrain conditions and operating usage may require spark plugs of a different heat range. For example, sustained cross-country riding will usually require colder heat-range spark plugs while trail riding or other continual slow speed operation will usually require hotter heat-range spark plugs.

Removing/Installing Spark Plugs (Crossfire/M-Series)

1. Remove the springs securing the expansion chamber to the exhaust manifold and resonator; then move the expansion chamber out of the way to access the spark plugs.
2. Remove the spark plug caps from the plugs.
3. Using a spark plug wrench, remove the plugs.
4. Install the plugs and finger-tighten.
5. Tighten the spark plugs to 2.5-2.8 kg-m (18-20 ft-lb); then install the spark plug caps.
6. Place the expansion chamber into position and secure to the exhaust manifold and resonator with the springs.

Removing/Installing Spark Plugs (F-Series)

1. Remove the two torx-head screws securing the console to the headlight support bracket.

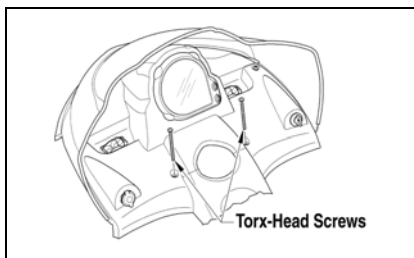

741-722A

2. Lift the rearward end of the console and disconnect the main/hood harness connector; then remove the console.
3. Remove the spark plug caps from the plugs.
4. Using a spark plug wrench, remove the plugs.
5. Install the plugs and finger-tighten.
6. Tighten the spark plugs to 2.5-2.8 kg-m (18-20 ft-lb); then install the spark plug caps.
7. Place the console into position on the headlight support bracket keeping the rearward end slightly elevated; then connect the main/hood harness connector.
8. Lower the rearward end of the console into position; then install the two torx-head screws. Tighten securely.

Removing/Installing Spark Plugs (Fan-Cooled Models)

1. Remove the spark plug caps from the plugs.
2. Using a spark plug wrench, remove the plugs.

3. Install the plugs and finger-tighten.
4. Tighten the spark plugs to 2.5-2.8 kg-m (18-20 ft-lb); then install the spark plug caps.

Removing/Installing Spark Plugs (660 cc Models)

1. Remove the spark plug/coil cover.
2. Remove the cap screws securing the spark plug coils to the engine; then remove the coils.
3. Using a spark plug wrench, remove the plugs.
4. Install the plugs and finger-tighten.
5. Tighten the spark plugs to 2.1 kg-m (15 ft-lb); then install the spark plug coils and secure them with cap screws.
6. Install the spark plug/coil cover.

Checking Spark Plugs (2-Stroke Models)

To see if the spark plugs being used are of the proper heat range (after the snowmobile has been operated under normal driving conditions), remove the spark plugs and examine the condition of the center electrode insulator of each spark plug.

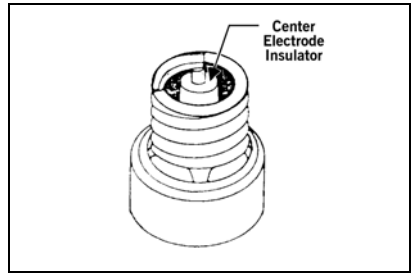

AO352A

- A. TAN or LIGHT BROWN insulator indicates correct spark plugs (heat range).
- B. LIGHT GRAY or WHITE insulator indicates over-heating of the engine. This condition is caused by a too lean condition or incorrect spark plugs (heat range too hot).
- C. BLACK insulator indicates fuel in the combustion chamber is not burning completely. This condition is caused by a too rich condition, too much oil, or incorrect spark plugs (heat range too cold).

■ **NOTE:** If the center electrode insulators are light gray, white, or black and if the carburetor adjustments (on carbureted models), oil-injection pump synchronization, and ignition timing are correct, different heat-range spark plugs may be necessary. Authorized Arctic Cat Snowmobile dealers have detailed spark plug information. Consult a dealer before changing spark plugs, as incorrect heat-range spark plugs could cause poor engine performance or engine damage.

 **CAUTION**

If a spark plug is light gray, white, or black and another is tan or light brown, take the snowmobile to an authorized Arctic Cat Snowmobile dealer for inspection and service. If not under warranty, this service is at the discretion and expense of the snowmobile owner.

**CHECKING/
ADJUSTING VALVE
CLEARANCE (660 cc/
1100 cc Z1)**

After 3500 miles (660 cc)/5000 miles (1100 cc Z1) or prior to seasonal storage, valve clearance should be checked and adjusted as necessary.

■ **NOTE:** Take the snowmobile to an authorized Arctic Cat Snowmobile dealer for inspection and service. If not under warranty, this service is at the discretion and expense of the snowmobile owner.

 **CAUTION**

It is critical that the checking/adjusting valve clearance be done at the recommended intervals or severe engine damage may occur.

**CHARGING BATTERY
(Electric Start
Models)**

**Standard with
Removable Caps**

■ **NOTE:** The level of the battery fluid must be kept between the MAX and MIN level lines at all times. If the level drops below the MIN level line, add only distilled water until it reaches MAX level line.

 **WARNING**

Battery acid is harmful if it contacts eyes, skin, or clothing. Care must be taken whenever handling a battery.

To remove and charge the battery, use the following procedure:

 **WARNING**

Any time service is performed on a battery, the following must be observed: Keep sparks, open flame, cigarettes, or any other flame away. Always wear safety glasses. Protect skin and clothing when handling batteries. When servicing battery in enclosed space, keep the area well-ventilated. Make sure battery venting is not obstructed.

 **WARNING**

Battery posts, terminals, and related accessories contain lead and lead compounds, chemicals known to the state of California to cause cancer and reproductive harm. Wash hands after handling.

1. Remove the negative battery cable; then remove the positive cable and the battery vent tube. Remove the battery from the snowmobile. Care should be taken not to damage the vent tube.

 **WARNING**

Avoid spillage and contact with skin, eyes, and clothing.

 **CAUTION**

Do not charge the battery while it is in the snowmobile with the battery terminals connected.

2. Remove the vent plugs; then (if necessary) fill the battery with **distilled water** to the MAX level indicated on the battery.
3. Trickle charge the battery at 1.4 amps for 10 hours.

 **CAUTION**

Never exceed the standard charging rate.

4. After charging, check fluid level and fill with distilled water as necessary; then install vent plugs.

 **CAUTION**

Before installing the battery, make sure the ignition switch is in the OFF position.

5. Place the battery into position in the snowmobile and secure.
6. Attach the vent tube and check the vent tube to make sure it is not crimped or obstructed in any way and that it is properly routed.
7. Clean the battery posts and cable ends by using a battery post cleaning tool and/or a wire brush to remove dirt, grease, and corrosion.
8. Connect cables to the proper terminals: positive cable to the positive terminal (+) and negative cable to the negative terminal (-). Connect the negative cable last.

 **CAUTION**

Connecting cables in reverse (positive to negative and negative to positive) can cause serious damage to the electrical system.

Sealed with Cap Strip

CAUTION

This maintenance-free battery requires periodic charging to prevent sulfiding. If the snowmobile will be idle for extended periods of time, trickle charge from time to time. If the battery completely discharges, permanent damage will occur requiring replacement.

WARNING

Always wear safety glasses when connecting or disconnecting a battery charger. Do not smoke or allow open flames near a charging battery.

CAUTION

Improper activation or excessive overcharging (possibly by equipment failure) could cause damage to the battery or snowmobile by forcing acid out of the safety valve.

1. Remove the battery from the snowmobile.

■ **NOTE:** This battery is permanently sealed. There is no need to remove the caps or to add electrolyte for the life of the battery.

■ **NOTE:** Do not charge the battery while it is in the snowmobile with the battery cables connected as damage to the electrical system may occur.

2. Using Arctic Cat Battery Charger (p/n 0436-634), charge the battery until the indicator light on the charger illuminates.

■ **NOTE:** Once charged, the battery can be left connected to the charger indefinitely.

3. Place the battery into position in the snowmobile and secure.
4. Connect cables to the proper terminals: positive cable to the positive terminal (+) and negative to the negative terminal (-). Connect the negative cable last.

CAUTION

Connecting cables in reverse (i.e. positive to negative and negative to positive) can cause serious damage to the electrical system.

FUSES (660 cc Models)

Fuses protect the snowmobile electrical system from overloading. If electrical parts in the snowmobile are not working, the system may have been overloaded and caused a blown fuse. Before repairing or replacing any electrical part, check the appropriate fuses. The following illustration shows which fuse protects each electrical part on the snowmobile. If a fuse blows (opens a circuit), all the parts of the snowmobile that use that circuit will not work.

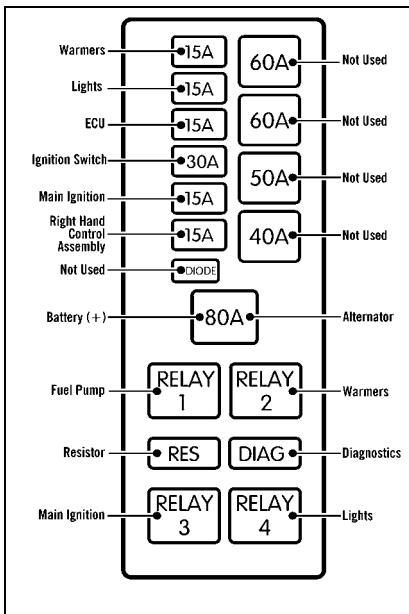

736-448A

Once which fuse to check has been determined, perform the following steps:

1. Open the hood and remove the fuse panel cover. The fuse panel is located on the right side of the engine compartment near the battery (for standard models) or behind the intake manifold (for Turbo models).

■ **NOTE:** There is a fuse pulling tool along with spare fuses inside the fuse panel.

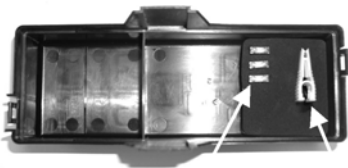

AO352A

2. Remove the suspected fuse.
3. Look through the clear side of the fuse to see if the metal wire inside is separated. If it is, the fuse is blown and should be replaced with a fuse of the correct amperage rating.

⚠ WARNING

Always replace a fuse with one having the same specified amperage rating. Using a fuse with a higher rating can cause severe wire damage and could start a fire.

4. Install the fuse panel cover.

Even after replacing a fuse, it may continue to blow if the cause of the overload is not determined. If the fuse continues to blow, take the snowmobile to an authorized Arctic Cat Snowmobile dealer for service. If not under warranty, this service is at the discretion and expense of the snowmobile owner.

FUSES (1100 cc Z1)

Fuses protect the snowmobile electrical system from overloading. If electrical parts in the snowmobile are not working, the system may have been overloaded and caused a blown fuse. Before repairing or replacing any electrical part, check the appropriate fuses. If a fuse blows (opens a circuit), all the parts of the snowmobile that use that circuit will not work.

Once which fuse to check has been determined, perform the following steps:

1. Open the right-side access panel; then remove the fuse panel cover. The fuse panel is located behind the battery.

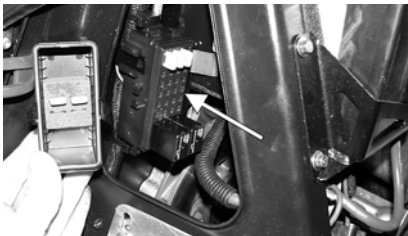

ZJ005A

■ **NOTE:** There are spare fuses inside the fuse panel.

2. Remove the suspected fuse.
3. Look through the clear side of the fuse to see if the metal wire inside is separated. If it is, the fuse is blown and should be replaced with a fuse of the correct amperage rating.

WARNING

Always replace a fuse with one having the same specified amperage rating. Using a fuse with a higher rating can cause severe wire damage and could start a fire.

4. Install the fuse panel cover.

Even after replacing a fuse, it may continue to blow if the cause of the overload is not determined. If the fuse continues to blow, take the snowmobile to an authorized Arctic Cat Snowmobile dealer for service. If not under warranty, this service is at the discretion and expense of the snowmobile owner.

ENGINE HEATER (660 cc Models)

The engine heater will help provide easier starting in cold weather. Arctic Cat recommends that the heater be plugged in any time the temperature is expected to get below -15°F . The heater cord is stored on the left rear of the engine compartment just above the air-intake vent.

MECHANICAL BRAKE SYSTEM

Arctic Cat recommends that the brake system (brake lever, brake lever travel, cable, caliper, spring, and disc) be checked daily for wear or damage, smooth operation, and proper adjustment.

WARNING

DO NOT operate the snowmobile when the parking brake is engaged or when any component in the brake system is damaged, worn, or adjusted improperly. If the snowmobile is operated and the brake system is not functioning properly, severe personal injury could result.

Checking Brake Lever Travel

1. Rotate the brake disc alternately forward and backward while slowly compressing the brake lever.

- At the point where the disc is locked, check the distance between the brake lever and the lever stop. The distance must be within a range of 6-13 mm (1/4-1/2 in.).

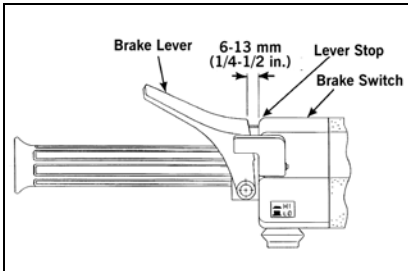

727-451A

- If distance is not within specifications, adjust the brake lever travel.

Adjusting Brake Lever Travel

⚠ WARNING

Before making any adjustment, make certain the brake adjustment knob isn't hot. If the snowmobile has just been used, you must allow some time for the brake adjustment knob to cool or burns may occur.

- To decrease brake lever travel (set up brakes), pull out on the brake adjustment knob and rotate the knob clockwise. As you rotate the knob, periodically check the brake lever travel distance until the correct travel distance is attained. Once the correct brake lever travel has been obtained, release the adjustment knob into a secured position.

NOTE: If the brake adjustment knob has reached its maximum adjustment (cannot be rotated any further clockwise), both brake pads must be replaced.

⚠ WARNING

DO NOT attempt to adjust the brake with the flange nuts on the brake cable bracket. Incorrect brake adjustment may occur causing possible brake failure.

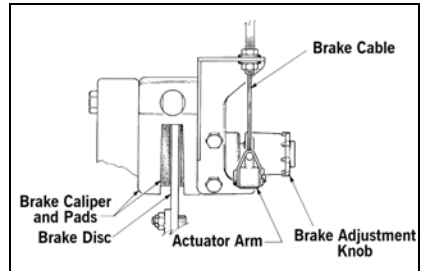

730-151A

- To increase brake lever travel (loosen the brake), pull out on the brake adjustment knob and rotate the knob counterclockwise while checking the brake lever travel. Once the desired brake lever travel is obtained, release the adjustment knob into a secured position.

⚠ WARNING

When the brake adjustment knob has reached its maximum adjustment, both brake pads **MUST BE REPLACED**. Take the snowmobile to an authorized Arctic Cat Snowmobile dealer for this service. This service is at the discretion and expense of the snowmobile owner.

■ **NOTE:** When adjusting the brake, do not accidentally close the gas tank shut-off valve.

■ **NOTE:** When new brake pads are installed, a “burnishing” process is required. Drive the snowmobile slowly and compress the brake lever several times until the pads just start to warm up; then allow them to cool down. This procedure stabilizes the pad material and extends the life of the pads.

HYDRAULIC BRAKE SYSTEM

Arctic Cat recommends that the brake system (brake lever, fluid reservoir, hose, caliper, pads, and brake disc) be checked daily for fluid leakage, wear, or damage and for proper operation. Also, the brake fluid level must be checked every time before starting the engine. The brake fluid must be maintained at a level just below the high mark on the fluid reservoir.

⚠ WARNING

DO NOT operate the snowmobile when the brake lever lock is engaged or when any component in the brake system is damaged, worn, or adjusted improperly. If the snowmobile is operated and the brake system is not functioning properly, severe personal injury could result.

Checking/Adding Brake Fluid

1. With the fluid reservoir/sight glass reservoir in a level position, check the fluid level. The brake fluid level must be just below the high mark in the brake fluid reservoir or visible in the sight glass.

■ **NOTE:** If the sight glass appears dark, there is a sufficient amount of fluid in the reservoir.

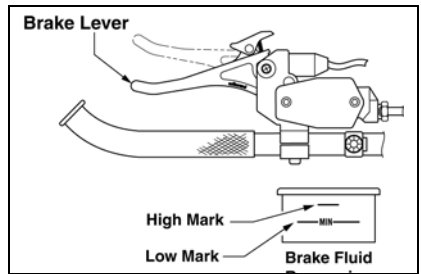

740-159A

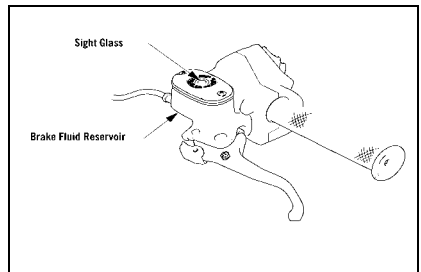

0740-588

2. If the brake fluid level is below the low mark or not visible in the sight glass, remove the reservoir cover and add Arctic Cat approved brake fluid until the fluid is at the recommended level. Install and secure the reservoir cover. Do not allow moisture to contaminate the brake system.

CAUTION

Brake fluid is highly corrosive. Do not spill brake fluid on any surface of the snowmobile.

WARNING

Do not overfill the brake fluid reservoir. Overfilling the reservoir may cause the brake system to hydraulically lock. Use only Arctic Cat approved brake fluid. Never substitute or mix different types or grades of brake fluid. Brake loss can result. Brake loss can result in severe injury or even death.

Changing Brake Fluid

The brake fluid must be changed on a regular basis and whenever the brake fluid has been overheated or contaminated. The brake fluid should be changed every 1000 miles or at the end of the snowmobiling season, whichever occurs first. Take the snowmobile to an authorized Arctic Cat Snowmobile dealer for this service. This service is at the discretion and expense of the snowmobile owner.

Checking Brake Lever Travel

Before each use, check the brake lever travel using the following procedure:

1. Compress the brake lever fully.

■ **NOTE:** Do not pump the brake lever as it will produce an inaccurate reading.

2. Measure the distance between the brake lever and the handlebar. The distance must be greater than 2.54 cm (1 in.).

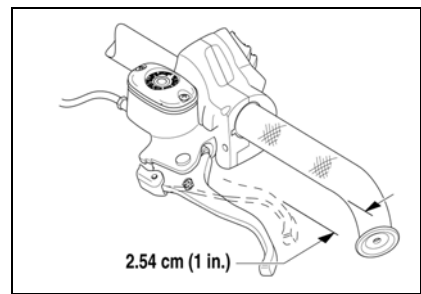
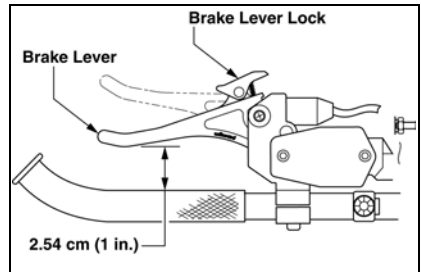

3. If the resultant distance is less than specified, take the snowmobile to an authorized Arctic Cat Snowmobile dealer for service. This service is at the discretion and expense of the snowmobile owner.

WARNING

Do not operate the snowmobile if the compressed distance between the brake lever and the handlebar is less than 2.54 cm (1 in.). Brake loss may occur. Brake loss can result in severe personal injury.

Bleeding Brake System

If the brake lever feels spongy when applied, the brake system may need to be bled. To bleed the brake, use the following procedure:

■ **NOTE:** The brake system may be bled by the snowmobile owner if qualified to do so. If the owner does not feel qualified, take the snowmobile to an authorized Arctic Cat Snowmobile dealer for this service. This service is at the discretion and expense of the snowmobile owner.

1. Remove the reservoir cover and fill the reservoir to the high mark with Arctic Cat approved brake fluid.

CAUTION

Brake fluid is highly corrosive. Do not spill brake fluid on any surface of the snowmobile.

WARNING

Use only Arctic Cat approved brake fluid. Any substitute may result in a loss of brakes.

2. Slide a piece of flexible tubing over the ball of the bleeder valve and direct the other end into a container.

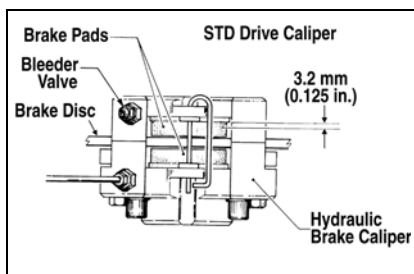

730-434F

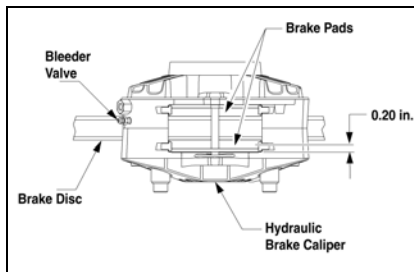

0739-269

3. Slowly compress the brake lever and hold. Open the bleeder valve to release the fluid and air. When the fluid stops, close the bleeder valve; then release the brake lever.
4. Repeat step 3 until the brake fluid flows free of air bubbles.

■ **NOTE:** It may be necessary to refill the reservoir during the bleeding process.

5. When the brake fluid is free of all air and the brake lever feels firm when compressed, fill the reservoir to a level just below the high mark; then install and secure the cover. Remove the tube from the bleeder valve.

Checking/Changing Brake Pads

The condition of the brake pads must be checked daily and changed if worn or damaged. To check and change the brake pads, use the following procedure:

■ **NOTE:** The brake pads may be changed by the snowmobile owner if qualified to do so. If the owner does not feel qualified, take the snowmobile to an authorized Arctic Cat Snowmobile dealer for this service. This service is at the discretion and expense of the snowmobile owner.

■ **NOTE:** When installing new brake pads, always install them as a set. Never install just one pad or use brake pads which have been used in another snowmobile.

1. Measure the thickness of both brake pads. The brake pad thickness must be greater than 3.2 mm (0.125 in.) on the standard caliper or greater than 5.0 mm (0.20 in.) on the ACT drive caliper. If the brake pad thickness is less than specified, replacement of both pads is necessary.

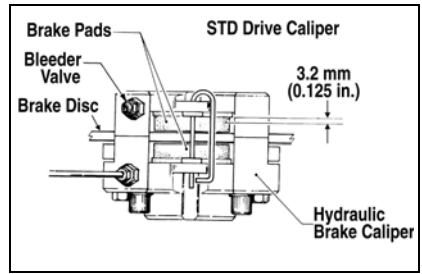

730-434F

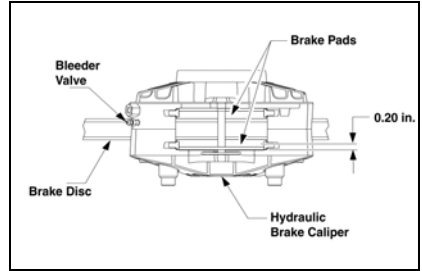

0739-269

2. Remove the pin/hairpin clip securing the brake pads to the caliper assembly.
3. Remove the brake fluid reservoir cover; then remove most of the brake fluid from the reservoir. Replace the cover.

■ **NOTE:** The above procedure will allow room for the fluid from the caliper when the pistons are pushed into the caliper for installing new brake pads. Replacing the cover will prevent fluid spillage.

4. Using a pair of pliers, pull one brake pad out of the caliper assembly.

■ **NOTE:** Changing one pad at a time will prevent one piston from pushing out the other piston from the caliper.

5. Using a flat-blade tool, slowly and carefully push the piston into the caliper.
6. Position the new brake pads into the caliper.
7. Repeat steps 4-6 for the other pad; then secure the pads with the pin/hairpin clip.
8. Remove the reservoir cover and remove the remaining fluid; then fill the reservoir with fresh fluid.
9. Pump the brake lever to ensure correct positioning of the brake pads; then release.
10. Fill the reservoir to the proper level with fresh brake fluid.

■ **NOTE:** When new brake pads are installed, a “burnishing” process is required. Drive the snowmobile slowly and compress the brake lever several times until the pads just start to warm up; then allow them to cool down. This procedure stabilizes the pad material and extends the life of the pads.

DRIVE BELT

The drive belt transfers power from the drive clutch to the driven pulley. If the belt is worn, cracked, or stretched, maximum power will not be transmitted and the belt could also fail and therefore must be replaced. Periodic checks (at least once a month under normal usage) of two drive belt specifications are essential.

1. Measure the outside circumference of the drive belt. The belt should be within the recommended range in circumference.
2. Measure the outside width of the drive belt. The belt should be within the recommended range in width.
3. Check the belt for cracking, fraying, etc.

If any of the specifications or conditions are unsatisfactory, replace the drive belt.

■ **NOTE:** Drive belts should be purchased from an authorized Arctic Cat Snowmobile dealer, as Arctic Cat drive belts are made to exact specifications and of quality material. Belts made by other manufacturers may not be of the same specifications or quality and, therefore, usage could result in poor performance and premature belt failure.

 CAUTION
Never run the engine with the drive belt removed. Excessive revving of the engine could result in serious engine damage and drive clutch failure.

Before starting the snowmobile in extremely cold temperatures, the drive belt should be removed and warmed up to room temperature. Once the drive belt is at room temperature, install the drive belt.

Also, drive belts have a break-in period of approximately 20 miles. After installing a new drive belt, drive the snowmobile for 20 miles at 1/2 throttle or less. This will allow the drive belt to gain its optimum flexibility and will extend drive belt life.

■ **NOTE:** On the ACT roller driven pulley, adding shim washers will decrease belt deflection and removing shim washers will increase belt deflection. Available shim washers from Arctic Cat are p/n 0648-714 (0.090 in.), p/n 0648-715 (0.030 in.), and p/n 0648-716 (0.060 in.). See an authorized Arctic Cat Snowmobile dealer for this service.

Removing Drive Belt (Standard Driven Pulley)

1. Turn ignition key to the OFF position and wait for all moving parts to stop.
2. Set the brake lever lock.
3. Open the hood; then open the belt guard.

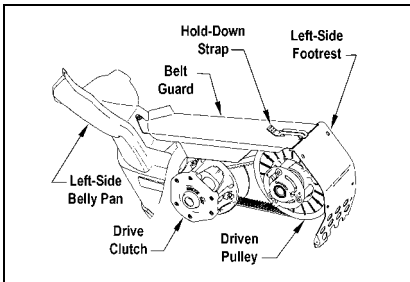

737-316A

4. Grasp the driven pulley roller plate and push against it while rotating it clockwise.
5. When the sheaves are fully apart, hold the roller plate, pull up on drive belt, and roll the belt over the stationary sheave until it is free of the driven pulley. Slowly release the roller plate.

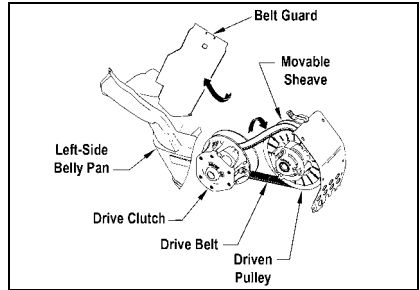

737-317A

6. When the belt is free of driven pulley, remove the belt from the drive clutch.

Installing Drive Belt (Standard Driven Pulley)

1. Place the belt (so the part number can be read) between the sheaves of the drive clutch.
2. Grasp the driven pulley roller plate and push against it while rotating it clockwise.
3. When the sheaves are fully apart, hold the roller plate, roll the belt over the stationary sheave, and slowly release the roller plate.

4. After the belt is installed properly, close and secure the belt guard and the hood.

WARNING

Never operate the snowmobile without the belt guard secured in place.

5. Release the brake lever lock.

Removing Drive Belt (ACT Roller Driven Pulley)

■ **NOTE:** Changing a drive belt can be done by the snowmobile owner if qualified to do so. If the owner does not feel qualified, take the snowmobile to an authorized Arctic Cat Snowmobile dealer for this service. This service is at the discretion and expense of the snowmobile owner.

1. Turn ignition key to the OFF position and wait for all moving parts to stop.
2. Set the brake lever lock.
3. Open the hood; then open the belt guard (if applicable).
4. Open the left-side access panel; then remove the panel.

■ **NOTE:** On the Crossfire/M-Series, remove the belt guard.

5. On Style A using the spark plug wrench, screwdriver, and Belt Deflection Tool (p/n 0644-435) from the tool kit, remove the sheave adjuster from the end of the driven pulley. Account for and remove the O-ring and shim washers. Note the orientation of the components for installing purposes.

■ **NOTE:** The sheave adjuster has left-hand threads.

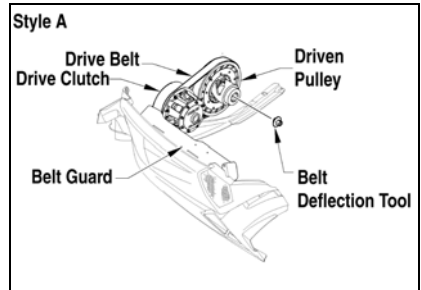

741-445B

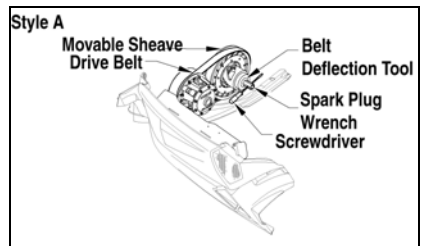

741-446B

6. On Style B, remove the cap screw and sheave adjuster from the end of the driven pulley. Account for and remove the O-ring and shim washers. Note the orientation of the components for installing purposes.

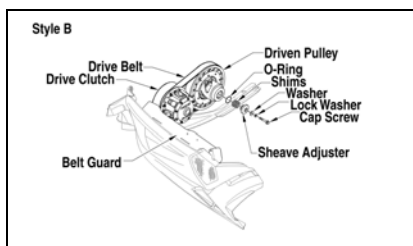

741-721B

7. On Style A with the O-ring and shim washers removed, carefully thread the sheave adjuster back into the driven pulley; then tighten the adjuster with the deflection tool/screwdriver/spark plug wrench assembly until it bottoms against the driven shaft.

■ **NOTE:** By bottoming the sheave adjuster against the driven shaft, the sheaves of the driven pulley will spread far enough to allow the removal of the drive belt.

8. On Style B with the O-ring and shim washers removed, install the sheave adjuster and cap screw back into the driven pulley; then tighten the cap screw until the sheave adjuster bottoms against the output shaft.

■ **NOTE:** By bottoming the sheave adjuster against the output shaft, the sheaves of the driven pulley will spread far enough to allow the removal of the drive belt.

9. Remove the drive belt from the drive clutch and driven pulley.

Installing Drive Belt (ACT Roller Driven Pulley)

1. Place the drive belt (so the part number can be read) between the sheaves of the drive clutch first; then between the sheaves of the driven pulley.
2. On Style A using the deflection tool/screwdriver/spark plug wrench assembly, remove the sheave adjuster from the end of the driven pulley. Place the shim washers and O-ring (as noted in removing) onto the sheave adjuster; then carefully thread the sheave adjuster back into the driven pulley. Tighten the adjuster securely using the deflection tool/screwdriver/spark plug wrench assembly.

■ **NOTE:** Do not over-tighten the sheave adjuster. A torque value of 2.1 kg-m (15 ft-lb) is recommended.

3. On Style B, place the shim washers and O-ring (as noted in removing) onto the sheave adjuster; then install the cap screw and sheave adjuster back into the driven pulley. Tighten the cap screw to 4.4 kg-m (32 ft-lb).
4. Close the belt guard (if applicable); then install the left-side access panel.

■ **NOTE:** On the Crossfire/M-Series, install the belt guard.

⚠ WARNING

Never operate the snowmobile without the belt guard/access panel secured in place.

5. Release the brake lever lock.

TRACK TENSION

Track tension is directly related to the overall performance of the snowmobile. If the track is too loose, it may slap against the tunnel causing wear or it may “ratchet” on the track drive sprockets. If extremely loose, the idler wheels may climb over the track lugs forcing the track against the tunnel causing the track to “lock.” Arctic Cat recommends that the track tension be checked daily during the first 300 miles of operation and once a week thereafter and adjusted according to need. The track will stretch and take a “set” during break-in. Track deflection must be maintained within the recommended range.

⚠ WARNING

Track tension must be properly maintained. Personal injury could result if a track is allowed to become excessively loose.

Checking Track Tension

⚠ WARNING

DO NOT attempt to check or adjust track tension with engine running. Turn ignition key to the OFF position. Personal injury could result from contact with a rotating track.

1. Remove excess ice and snow buildup from the track, track drive sprockets, and the inside of the skid frame.
2. Place the snowmobile up on a shielded safety stand. Check to make sure the track is 5-8 cm (2-3 in.) off the floor.
3. At mid-point of the track (on the bottom side), hook a spring scale around a track clip; then pull down on the scale to the recommended pressure. Measure the deflection (distance) between the bottom of the wear strip and the inside surface of the track clip. Compare the measurement with the chart.

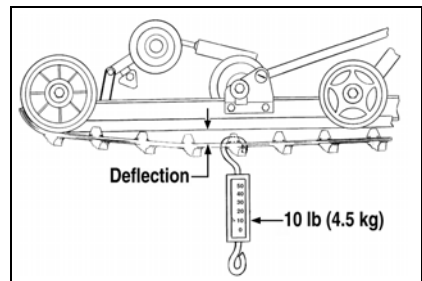

729-429E

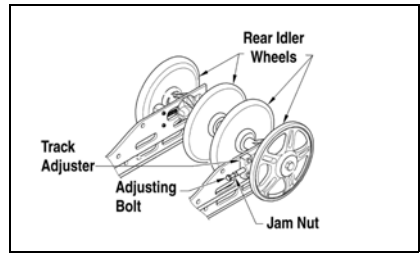
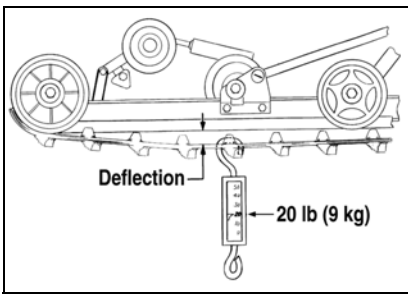

739-636B

729-429A

Model	Setup Tension	After Break-In Tension
Z Models @ 20 lb	38-44 mm (1 1/2-1 3/4 in.)	44-51 mm (1 3/4-2 in.)
Panther Models @ 20 lb	44-51 mm (1 3/4-2 in.)	51-57 mm (2-2 1/4 in.)
T660 Touring/ Turbo Touring @ 20 lb	44-51 mm (1 3/4-2 in.)	51-57 mm (2-2 1/4 in.)
Turbo Trail @ 20 lb	38-44 mm (1 1/2-1 3/4 in.)	44-51 mm (1 3/4-2 in.)
Bearcat Models @ 20 lb	44-51 mm (1 3/4-2 in.)	51-57 mm (2-2 1/4 in.)
F-Series Models @ 20 lb	44-51 mm (1 3/4-2 in.)	51-57 mm (2-2 1/4 in.)
Jaguar Z1 @ 20 lb	44-51 mm (1 3/4-2 in.)	51-57 mm (2-2 1/4 in.)
Crossfire Models @ 20 lb	44-51 mm (1 3/4-2 in.)	51-57 mm (2-2 1/4 in.)
M-Series Models @ 10 lb	51-64 mm (2-2 1/2 in.)	51-64 mm (2-2 1/2 in.)

■ **NOTE:** On the M-Series, measurement is from the bottom of the wear strip at the point of the shock pad on the slide rail.

Adjusting Track Tension

1. Loosen the rear idler wheel adjusting bolt jam nuts.

■ **NOTE:** To ensure proper track tension adjustment, perform all adjustments on both sides of the snowmobile.

2. If the deflection (distance between the bottom of the wear strip and the inside of the track) exceeds specifications, tighten the adjusting bolts to take up excessive slack in the track.
3. If the distance between the bottom of the wear strip and the inside surface of the track is less than specified, loosen the adjusting bolts to increase the slack in the track.
4. Check track alignment (see Track Alignment section).
5. When proper track tension is obtained, tighten the adjusting bolt jam nuts against the axle housings.

■ **NOTE:** Since track tension and track alignment are interrelated, always check both even if only one adjustment seems necessary.

WARNING

If jam nuts are not tightened properly, the adjusting bolts could loosen causing the track to become extremely loose and, under some operating conditions, allow the idler wheels to climb over the track lugs forcing the track against the tunnel causing the track to “lock.” If a track “locks” during operation, severe personal injury could result.

TRACK ALIGNMENT

Proper track alignment is obtained when the rear idler wheels are equal distance from the inner track drive lugs. Excessive wear to the idler wheels, drive lugs, and track will occur if the track is improperly aligned. Arctic Cat recommends that the track alignment be checked once a week or whenever the track tension is adjusted.

Checking Track Alignment

WARNING

Make sure the ignition key is in the OFF position and the track is not rotating before checking or adjusting track alignment. Personal injury could result if contact is made with a rotating track.

1. Remove excess ice and snow buildup from the track, track drive sprockets, and the inside of the skid frame.

2. Position the tips of the skis against a wall; then using a shielded safety stand, raise the rear of the snowmobile off the floor making sure the track is free to rotate.

WARNING

The tips of the skis must be positioned against a wall or similar object.

WARNING

DO NOT stand behind the snowmobile or near the rotating track. NEVER run the track at high speed when the track is suspended.

3. Start the engine and accelerate slightly. Use only enough throttle to turn the track several revolutions. SHUT ENGINE OFF.

■ **NOTE: Allow the track to coast to a stop. DO NOT apply the brake because it could produce an inaccurate alignment condition.**

4. When the track stops rotating, check the relationship of the rear idler wheels and the inner track drive lugs. If the rear idler wheels are centered between the inner track drive lugs, no adjustment is necessary.

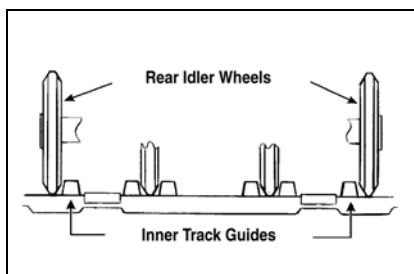

0727-729

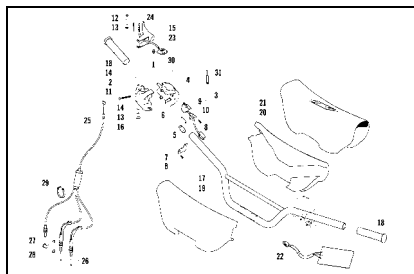

0739-637

5. If the idler wheels are not centered between the inner track drive lugs, an adjustment is necessary.

Adjusting Track Alignment

1. On the side of the track which has the inner track drive lugs closer to the rear idler wheel, loosen the adjusting bolt jam nut; then rotate the adjusting bolt clockwise 1 to 1 1/2 turns.

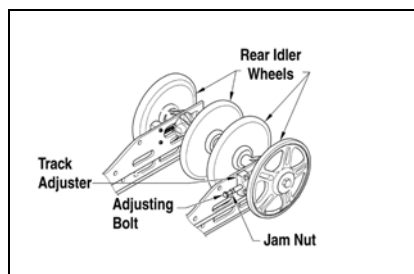

739-636B

2. Check track alignment and continue adjustment until proper alignment is obtained.

■ **NOTE: Make sure correct track tension is maintained after adjusting track alignment (see Track Tension section).**

3. After proper track alignment is obtained, tighten the adjusting bolt jam nut against the axle housing.

⚠ WARNING

If a jam nut is not tightened properly, the adjusting bolt could loosen causing the track to become dangerously loose.

4. Field test the track under actual conditions.
5. After the field test, check the alignment of the track. If additional adjustment is necessary, repeat Adjusting Track Alignment procedure.

SUSPENSION

The suspension should be adjusted for the operational needs and riding preference of the operator.

The front shock springs determine the amount of ski pressure and the reaction of the front suspension to rough terrain. The amount of ski pressure can also be changed by adjusting the length of the skid frame front arm limiter straps.

The rear springs influence the load carrying capability of the snowmobile and should be adjusted for the weight and riding preference of the operator.

Adjusting Front Shock Springs (STD)

■ **NOTE:** On some models, the front shock springs are not adjustable.

The front shock springs are individually adjustable for the terrain conditions and driving style of the operator. The spring adjuster has been set at the factory so the correct amount of threads are exposed between the spring adjuster and the shock housing as an initial setting. Additional ski pressure can be obtained by tightening the spring tension; ski pressure can be decreased by relaxing spring tension.

■ **NOTE:** Equal adjustments should be maintained on both sides of the snowmobile.

To adjust spring tension, rotate the entire spring in whichever direction is desired. If after adjusting spring tension you note the snowmobile front end wants to pitch, relax the spring tension on the side that is pitching. If both sides are pitching, relax the spring tension on both sides.

■ **NOTE:** The spring adjuster will normally rotate with the spring.

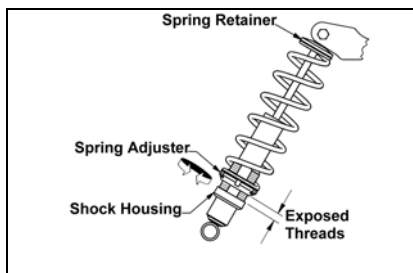

734-501B

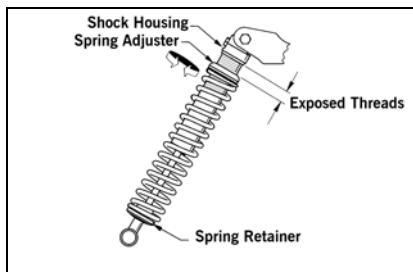

734-500B

Adjusting Front Shocks (Fox Air Shocks)

■ **NOTE:** It is recommended to monitor the air pressure in the air shocks once every month.

■ **NOTE:** Adjusting air shocks may be done by the snowmobile owner if qualified to do so. If the owner does not feel qualified, take the snowmobile to an authorized Arctic Cat Snowmobile dealer for this service. This service is at the discretion and expense of the snowmobile owner.

The air shocks are individually adjustable for the terrain conditions and driving style of the operator. The shocks are preset at 4.6 kg/cm² (65 psi) as an initial setting on the Cross-fire/F-Series Sno Pro models or at 4.2 kg/cm² (60 psi) on the M-Series models; however, it is possible to “fine tune” the shocks to match the operator’s weight, riding style, and terrain conditions.

■ **NOTE:** Care should be taken to have equal pressure in the shocks before operating the snowmobile.

To increase or decrease air pressure, use the following procedure.

■ **NOTE:** When adjusting air pressure, all weight must be removed from the front suspension, and the shock absorbers must be fully extended.

■ **NOTE:** Adding air pressure will increase the air spring force; reducing air pressure will decrease air spring force.

 **WARNING**

Do not exceed 105 kg/cm² (150 psi) in the shock.

1. Remove the air valve cap from the shock.
2. Thread the valve of Air Shock Pump (p/n 2603-324) onto the shock air valve approximately six rotations.

■ **NOTE:** As the pump is being attached to the shock, the hose will fill with air. This will result in a lower gauge pressure 0.14-3.52 kg/cm² (2-5 psi).

3. To decrease air pressure in the shock, press the black bleed valve button half way down and hold until desired pressure is attained.

■ **NOTE:** Pressing the button fully down and releasing it will allow only a small amount of air to escape (micro-adjust).

4. To increase air pressure in the shock, pump until desired pressure is attained.

5. Remove the pump valve from the shock air valve.

■ **NOTE:** As the pump valve is being removed from the shock, the sound of air loss is from the pump hose, not from the shock.

6. Install the air valve cap onto the shock.

Skid Frame Front Arm

■ **NOTE:** On some models, the front arm limiter straps are not adjustable.

The skid frame front arm shock spring and limiter straps are adjustable. However, Arctic Cat recommends that the shock spring be maintained as loose as possible. Tightening the skid frame front arm shock spring may cause improper balance and may ruin the handling features of the snowmobile.

The length adjustment of the front arm limiter straps determines the weight distribution between the front of the skid frame and the skis. Tightening the limiter strap (shortening the strap) will pull up on the front of the skid frame and will increase ski pressure. Loosening the limiter strap (lengthening the strap) lowers the front of the skid frame and decreases ski pressure.

When customizing the amount of ski pressure, be sure to adjust both straps equally and do not over-adjust the limiter straps to adversely affect steering and operator control of the snowmobile. Some experimentation may be required until the proper adjustment for the operator's individual style is obtained.

WARNING

Do not adjust the front arm limiter straps to a point at which steering and operator control of the snowmobile are adversely affected.

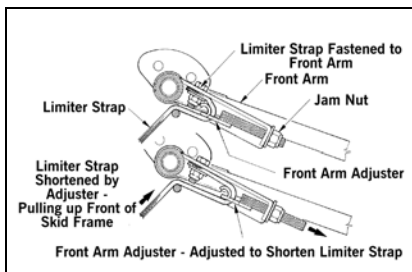

0730-537

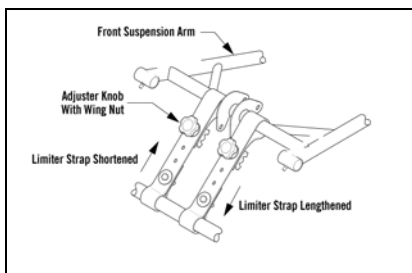

0739-714

Adjusting Rear Spring Pre-Load

Proper adjustment of rear spring pre-load is necessary to get the most comfortable ride. The chart is designed to help in setting up rear spring pre-load; however, riding style is the single greatest factor in determining rear spring requirements.

Rider Weight (lb)	Cam Position
Up to 180	1
180-240	2
Over 240	3

■ **NOTE:** These cam position settings are suggestions only. Personal riding style will greatly influence cam position settings. Spend time to determine setting preferences.

Rear spring pre-load adjustment is accomplished by rotating the adjusting cams. Position 3 provides the stiffest ride, and position 1 is for the light driver or slow-speed trail riding. Position 2 is for the average operator under normal conditions. Always rotate the cam from the lighter position to the heavier position.

CAUTION

Never force the adjustment cams from the low position to the high position. Cam damage may occur.

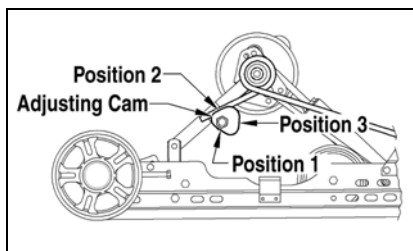

741-450A

To rotate an adjusting cam, use the spark plug wrench from the tool kit. Rotate the wrench until the cam is in the desired position. To stiffen the ride, rotate the cam so as to raise the spring end. Make the appropriate adjustment on the other cam.

Articulating Skid Frame (Bearcat Wide Track Models)

The rear articulating portion of the skid frame has two adjusters which control the amount of travel in the rear suspension.

These two adjusters have been pre-set at the factory and should require no further adjustment.

If adjustment is ever required, rotate the two adjusters equally to permit 12.5-25 mm (1/2-1 in.) travel of the articulating portion of the suspension.

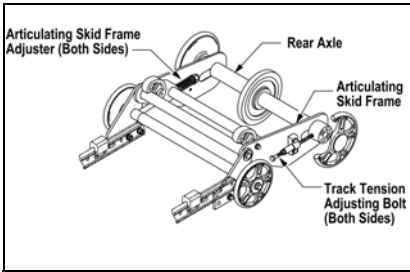

0739-642

Overload Springs

Some models have overload springs built into the rear suspension. When either carrying a heavy load or riding 2-up, the overload springs should be engaged by rotating the spring tension blocks to the UP position. The spring tension blocks lock in an over-center position when engaged. To either engage or disengage the spring tension blocks, use the Spring Block Tool, a spark plug socket, and a screwdriver to adjust the spring block to the desired position. Make sure both spring blocks are in the same position (either engaged or disengaged).

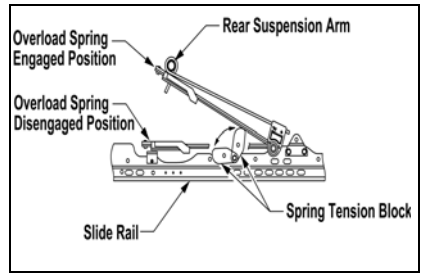

0739-625

LIGHTS

For the correct headlight bulb and/or taillight/brakelight bulb, see the appropriate specifications sheet.

Removing and Installing Taillight/ Brakelight Bulb

1. Remove the screws securing the taillight/brakelight lens; then remove the lens.

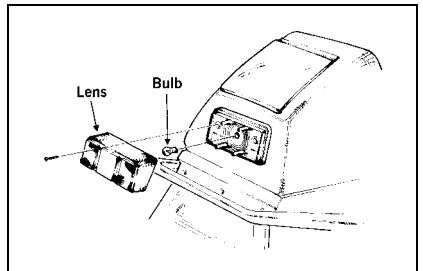

0728-239

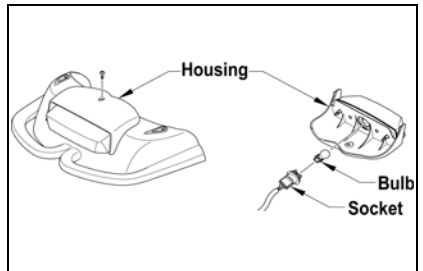

0739-712

2. Push in on the bulb and rotate it counterclockwise to remove it from the socket.
3. Install the new bulb in the socket by pushing it in and rotating it clockwise.
4. Install the lens and secure with the screws.

Removing and Installing Taillight/Brakelight Bulb (F-Series/Jaguar Z1)

1. Remove the two screws securing the taillight cover.
2. From inside the rear storage compartment, remove the self-tapping screws and washers securing the taillight/brakelight housing; then remove the housing.

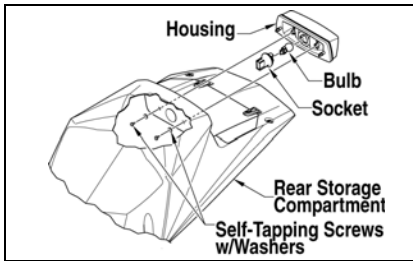

741-680A

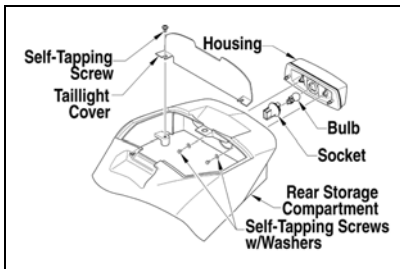

741-331A

3. Push in on the socket and rotate it counterclockwise to remove it from the housing.
4. Remove the old bulb by pulling it straight out of the socket.
5. Install the new bulb in the socket by pushing it straight in.
6. Push the socket into the housing and rotate it clockwise to lock into place.
7. Install the housing and secure with the self-tapping screws and washers.
8. Place the taillight cover into position and secure with the two screws.

Removing Headlight Bulb (3-Bulb Style)

■ **NOTE:** The bulb portion of the headlight is fragile. **HANDLE WITH CARE.** When replacing the headlight bulb, the bulb assembly must first be removed from the housing.

1. Pull the wiring harness retaining clip away from the headlight bulb base and disconnect the wiring harness from the bulb.

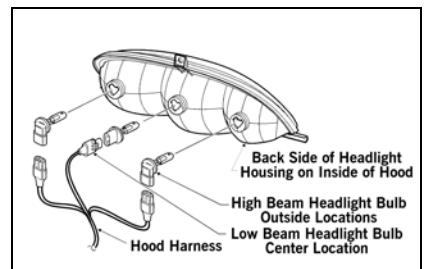

0733-178

2. Rotate the headlight bulb base counterclockwise and remove the bulb from the headlight housing.

Installing Headlight Bulb (3-Bulb Style)

⚠ CAUTION

Do not touch the glass portion of the bulb. If the glass portion is touched, it must be cleaned with a dry cloth before installing.

1. While holding the bulb by its base, insert the bulb into the headlight housing and rotate it clockwise until it locks into the housing.
2. Plug the wiring harness into the headlight bulb base making sure the retaining clip locks onto the base.
3. Check headlight aim (see Adjusting Headlight Aim in this subsection).

⚠ WARNING

Do not operate the snowmobile unless headlight beam is adjusted properly. An incorrectly adjusted beam will not provide the operator the optimum amount of light.

Removing Headlight Bulb (Bearcat W/T Turbo/T660 Models)

■ NOTE: The bulb portion of the headlight is fragile. HANDLE WITH CARE. When replacing the headlight bulb, the bulb assembly must first be removed from the housing.

1. Remove the bulb from the headlight housing and disconnect the wiring harness from the bulb.

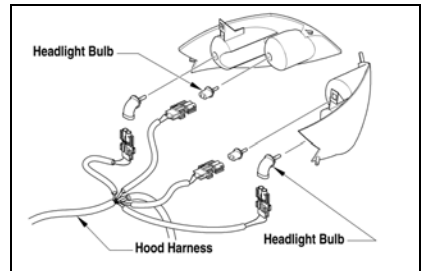

0740-462

Installing Headlight Bulb (Bearcat W/T Turbo/T660 Models)

⚠ CAUTION

Do not touch the glass portion of the bulb. If the glass portion is touched, it must be cleaned with a dry cloth before installing.

1. Plug the wiring harness into the headlight bulb.
2. Insert the bulb into the headlight housing.
3. Check headlight aim (see Adjusting Headlight Aim in this subsection).

⚠ WARNING

Do not operate the snowmobile unless headlight beam is adjusted properly. An incorrectly adjusted beam will not provide the operator the optimum amount of light.

Removing Headlight Bulb (Crossfire/M-Series Models)

■ **NOTE:** The bulb portion of headlight is fragile. **HANDLE WITH CARE.** When replacing the headlight bulb, the bulb assembly must first be removed from the housing. Do not touch the glass portion of the bulb. If the glass is touched, it must be cleaned with a dry cloth before installing.

To access the headlight bulbs, use the following procedure:

1. With the hood closed, loosen the headlight adjustment knobs.
2. Carefully push the headlight lenses rearward far enough to remove the torx-head screws securing the air silencer plenum to the hood.
3. Open the hood; then remove the O-rings securing the air silencer plenum to the hood and remove the air silencer plenum to access the bulbs.
4. Remove the bulb from the headlight housing and disconnect the wiring harness from the bulb.

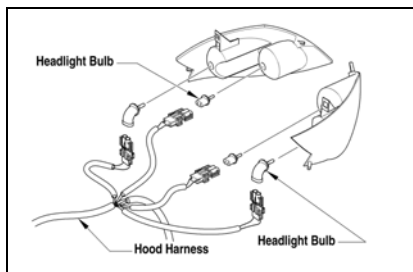

0740-462

Installing Headlight Bulb (Crossfire/M-Series Models)

⚠ CAUTION

Do not touch the glass portion of the bulb. If the glass portion is touched, it must be cleaned with a dry cloth before installing.

1. Plug the wiring harness into the headlight bulb.
2. Insert the bulb into the headlight housing.
3. Press the air silencer plenum into place on the hood and secure with the O-rings; then close the hood.
4. Carefully push the headlight lenses rearward far enough to install the torx-head screws. Tighten the screws securely.
5. Tighten the headlight adjustment knobs.
6. Check headlight aim (see Adjusting Headlight Aim in this subsection).

WARNING

Do not operate the snowmobile unless headlight beam is adjusted properly. An incorrectly adjusted beam will not provide the operator the optimum amount of light.

Removing Headlight Bulb (F-Series/Jaguar Z1)

■ **NOTE:** The bulb portion of headlight is fragile. **HANDLE WITH CARE.** When replacing the headlight bulb, the bulb assembly must first be removed from the housing. Do not touch the glass portion of the bulb. If the glass is touched, it must be cleaned with a dry cloth before installing.

To access the headlight bulbs, use the following procedure:

1. On the F-Series LXR and Jaguar Z1 models, release the latches securing the windshield to the windshield base; then remove the windshield.
2. Remove the two torx-head cap screws located to the outside of the headlight adjustment knobs; then remove the single torx-head cap screw from beneath the console (located between the headlights).

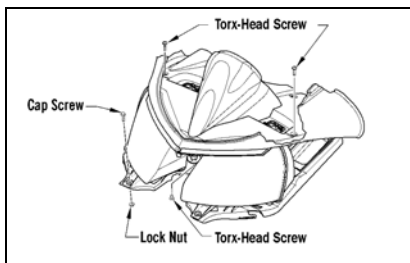

741-505A

3. Remove the cap screw and lock nut securing the front of the headlight assembly to the air-intake silencer.
4. Lift the front of the console enough to allow the headlight housing to be removed; then remove the housing.
5. Remove the bulb from the headlight housing and disconnect the wiring harness from the bulb.

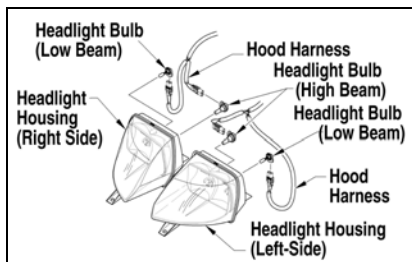

741-329A

Installing Headlight Bulb (F-Series/Jaguar Z1)

⚠ CAUTION

Do not touch the glass portion of the bulb. If the glass portion is touched, it must be cleaned with a dry cloth before installing.

1. Plug the wiring harness into the headlight bulb.
2. Insert the bulb into the headlight housing.
3. Lift the front of the console enough to allow the headlight housing to be installed; then install the housing making sure the forks of the housing go into the grommets on top of the air-intake silencer. Secure with the cap screw and lock nut.

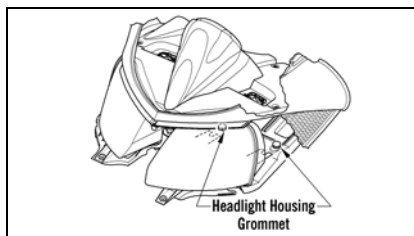

0741-506

4. Position the console onto the air-intake silencer; then secure with the single torx-head cap screw beneath the console (located between the headlights).
5. Install the two torx-head cap screws located to the outside of the headlight adjustment knobs; then tighten securely.

6. On the F-Series LXR and Jaguar Z1 models, place the windshield into position on the windshield base; then secure with the latches.
7. Check headlight aim (see Adjusting Headlight Aim in this subsection).

⚠ WARNING

Do not operate the snowmobile unless headlight beam is adjusted properly. An incorrectly adjusted beam will not provide the operator the optimum amount of light.

Adjusting Headlight Aim

The headlight can be adjusted for vertical aim of the HIGH/LOW beam. The geometric center of HIGH beam zone is to be used for vertical aiming.

1. Position the snowmobile on a level floor so the headlight is approximately 8 m (25 ft) from an aiming surface (wall or similar surface).

■ **NOTE:** There should be an “average” operating load on the snowmobile when adjusting headlight aim.

2. Measure the distance from the floor to midpoint of the headlight.
3. Using the measurement obtained in step 2, make a horizontal mark on the aiming surface.

4. Make a vertical mark which intersects the horizontal mark on the aiming surface directly in front of the headlight.
5. Engage the brake lever lock and start the engine. Move the headlight dimmer switch to the HIGH beam position. DO NOT USE LOW BEAM.
6. Observe the headlight beam aim. Proper aim is when the most intense beam is centered on the vertical mark 5 cm (2 in.) below the horizontal mark on the aiming surface.

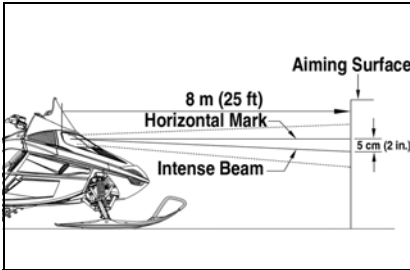

0741-448

7. On 3-bulb models, adjust the headlight housing mounting screws until correct aim is obtained. Shut the engine off; then disengage the brake lever lock.
8. On the Bearcat W/T Turbo/F-Series/Jaguar Z1/T660 models, adjust the headlight using the adjustment knobs until correct aim is obtained. Shut the engine off; then disengage the brake lever lock.

SKI WEAR BARS

The ski wear bar is a replaceable bar attached to the underside of the ski. The purpose of the wear bar is to assist in turning the snowmobile, to minimize ski wear, and to maintain good steering control. If the snowmobile is operated primarily in deep snow, ski wear bar wear will be minimal; however, if the snowmobile is operated on terrain where the snow cover is minimal, the ski wear bar will wear faster. To maintain positive steering characteristics, Arctic Cat recommends that the ski wear bars be checked before each use and replaced if worn beyond 1/2 of the original diameter. Ski wear bars are available from an authorized Arctic Cat Snowmobile dealer.



WARNING

Operating the snowmobile with excessively worn ski wear bars may result in a loss of steering control.

Removing Ski Wear Bars

■ **NOTE:** Determine which type of wear bar is being replaced and remove and install accordingly.

1. Remove ice and snow buildup from the ski.
2. With the gas tank nearly empty (less than 1/4 full), lay the snowmobile on its left side. A piece of cardboard should be used to protect the finish on the hood and belly pan.

CAUTION

The 660 cc models should not be tipped on their sides in excess of a 70° angle for any reason, as the engine oil may seep into the upper engine through the air-intake system. Severe engine damage could result if the engine is run with oil in the upper engine.

3. Remove the lock nuts and washers (if applicable) securing the wear bar to the ski.

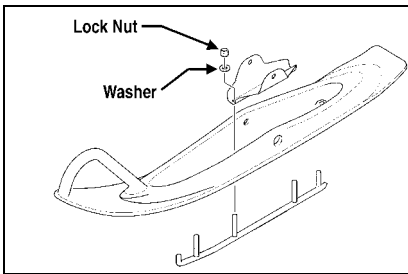

737-454A

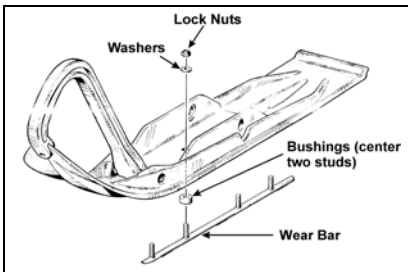

731-037D

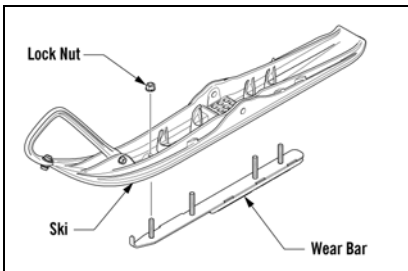

0739-596

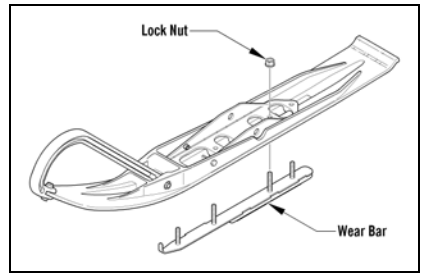

0739-016

4. Remove the wear bar from the ski and account for the location of the bushings (if applicable).

Installing Ski Wear Bars

1. If applicable, place the bushings onto the studs; then move the wear bar into position on the bottom of the ski.

■ **NOTE:** If installing a double-offset wear bar, the carbide edge must be directed to the outside of the ski; however, on the T660 Touring models, the carbide edge must be directed to the inside of the ski.

2. Align the wear bar studs with the holes in the ski; then install the washers (if applicable) and lock nuts. Tighten to 1.5-2.1 kg-m (11-15 ft-lb).

ADJUSTING SKI STANCE (M-Series/Bearcat 570 Models)

1. Place the front of the snowmobile on a support stand.

2. Remove the cotter pin; then remove the slotted nut and cap screw securing the ski assembly to the spindle. Remove the ski. Account for the rubber damper, inserts, and washers.
3. To increase ski stance 2.5 cm (1 in.), place both ski stance spacers to the outside of the spindle.
4. To decrease ski stance 2.5 cm (1 in.), place both ski stance spacers to the inside of the spindle.
5. Position the ski over the saddle.
6. Apply a low-temperature grease to the non-threaded portion of the cap screw; then slide the cap screw through the ski and saddle accounting for the rubber damper, inserts, and washers.

■ **NOTE:** Install the cap screw so the slotted nut will be located to the inside of the ski.

7. Apply red Loctite #271 to the threads of the cap screw; then tighten the nut to 6.2 kg-m (45 ft-lb).
8. Place the cotter pin into the ski cap screw and spread the pin.
9. Repeat procedure for the other ski.

RAIL WEAR STRIPS

Arctic Cat recommends that the wear strips be checked weekly and replaced as necessary. Measure the wear strips at 25.4 cm (10 in.) intervals. Wear strips must be 10.7 mm (0.42 in.) thick or thicker.

If wear strip measurements are less than specified, replacement of both wear strips is necessary to prevent premature track clip wear and possible track damage. Take the snowmobile to an authorized Arctic Cat Snowmobile dealer for this service. This service is at the discretion and expense of the snowmobile owner.

Each time a new set of wear strips are installed, they should be tempered. Temper the wear strips by driving the snowmobile for approximately a mile on a hard pack trail; then immediately drive into deep snow and allow the wear strips to cool. Repeat the procedure (warming up the wear strips; then cooling them down) two or three times.

■ **NOTE:** The rail wear strips will wear rapidly if the snowmobile is operated on terrain on which the snow cover is minimal. Loose snow is required to cool and lubricate the wear strips and prevent accelerated wear.

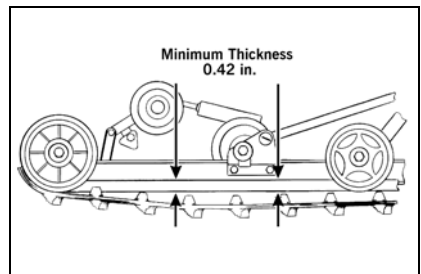

0727-726

AXIAL FAN BELT (370 cc Models)

Arctic Cat recommends that the condition of the axial fan belt be inspected monthly.

1. Be sure ignition key is in the OFF position.

⚠ WARNING

DO NOT inspect the axial fan belt while the engine is running. Contact with the axial fan belt, fan blades, or other moving parts may cause personal injury.

2. Lift the hood and remove the screws securing the fan cover; then remove the fan cover.
3. Inspect axial fan belt for cracks, wear, and proper tension.

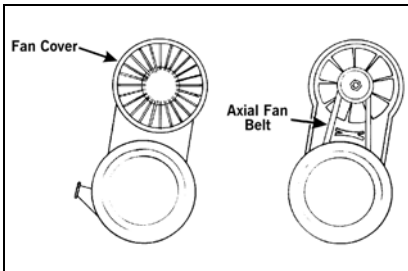

726-155A

4. Using the thumb and forefinger, check the tension (tightness) of the fan belt by squeezing the belt together near mid-span. The maximum belt deflection must not exceed 6 mm (1/4 in.).

■ NOTE: If the axial fan belt is damaged or if the belt deflection exceeds the specification, take the snowmobile to an authorized Arctic Cat Snowmobile dealer for repair or adjustment. This service is at the discretion and expense of the snowmobile owner.

5. Install the fan cover.

ACCESSORY BELT (660 cc Models)

Arctic Cat recommends that the condition of the accessory belt be inspected monthly.

Checking Belt Tension

1. Be sure ignition key is in the OFF position.

⚠ WARNING

DO NOT inspect the belt while the engine is running. Contact with the belt, pulleys, or other moving parts may cause personal injury.

2. On the standard models, remove the air cleaner assembly; on the turbo models, remove the inter-cooler assembly.
3. Remove the bolts securing the belt guard to the engine; then remove the belt guard from the engine compartment.
4. Inspect the belt for cracks, wear, and proper tension.
5. Using the thumb, check the tension (tightness) of the belt by pressing down on the belt near mid-span. The maximum belt deflection must not exceed 9 mm (0.35 in.).

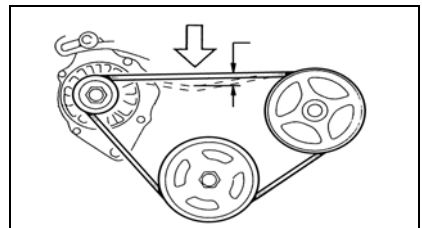

0736-564

Adjusting Belt Tension

1. Remove the bolts securing the belt guard to the engine; then remove the belt guard from the engine compartment.
2. On the alternator, loosen, but do not remove, the tension bolt (A) and the pivot bolt (B).

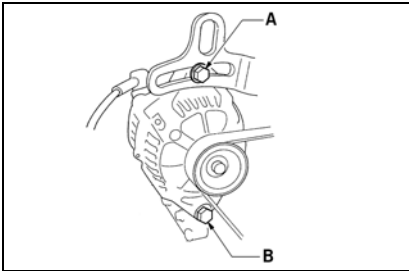

0736-553

3. Insert a wooden pry bar (such as a hammer handle) between the engine and the alternator, pry the alternator away from the engine, and tighten the accessory belt.
4. When the accessory belt is tensioned properly (see Accessory Belt in this sub-section), tighten the tension bolt (A) to 2.4 kg-m (17 ft-lb).
5. Tighten the pivot bolt (B) to 5.1 kg-m (37 ft-lb).
6. Place the belt guard into position and secure with the bolts.
7. On the standard models, install the air cleaner assembly; on the turbo models, install the inter-cooler assembly.

PERFORMANCE TIPS

Operating a high performance snowmobile requires a special attention that is not required by a low performance snowmobile. Often, a minor adjustment will result in a large increase in performance. This section is intended to highlight minor conditions that adversely affect performance and the adjustments needed to correct them. Be sure, however, to thoroughly read and understand this entire manual especially the section on spark plugs, track tension and alignment, and suspension.

DRIVE BELT — This link between the engine and drive train is often the most neglected component. The drive belt must have the proper fit in the drive clutch and driven pulley. Proper fit is when the top surface of the drive belt is flush with the top or up to 1/16 in. higher than the driven pulley sheaves (with the sheaves fully closed). If the belt sits below this level, the snowmobile will bog at slow speeds and will have a slower maximum speed. To correct this condition, first determine if the drive belt is within specifications (see Drive Belt section) and replace if worn or too long. Secondly, it may be necessary to remove a shim washer from between the driven pulley sheaves to allow the driven pulley to close tighter. On the ACT roller driven pulley, adding shim washers will decrease belt deflection and removing shim washers will increase belt deflection. Available shim washers from Arctic Cat are p/n 0648-714 (0.090 in.), p/n 0648-715 (0.030 in.), and p/n 0648-716 (0.060 in.). See an authorized Arctic Cat Snowmobile dealer for this service. Finally, always run the drive belt in the same direction. Installing the drive belt so the part number can be read will ensure that the drive belt is always run the same direction.

DRIVE CLUTCH AND DRIVEN PULLEY — Keeping the drive clutch and driven pulley clean should be the primary consideration of the operator. The clutch sheaves can be cleaned of any drive belt accumulation using a clean cloth and parts-cleaning solvent. All pivot points can be maintained clean using compressed air.

CARBURETOR MAIN JET(S) (Carbureted Models) — Proper carburetion is absolutely necessary to obtain peak performance. Since ambient temperature and operating altitude both affect the main jet size needed for optimum engine performance, the main jet(s) **MUST** be changed whenever the temperature changes 20° F or whenever operating altitude varies by more than 1000 feet. The Main Jet Chart beneath the hood of the snowmobile identifies the proper main jet(s) to use under all operating temperatures and altitudes. Follow the Main Jet Chart carefully to obtain peak engine performance and avoid engine damage.

PREPARATION FOR STORAGE

Prior to storing the snowmobile, it must be properly serviced to prevent corrosion and component deterioration. An authorized Arctic Cat Snowmobile dealer should perform this service; however, the owner/ operator can perform this service if desired. This service is at the discretion and expense of the snowmobile owner. To prepare the snowmobile for storage, Arctic Cat recommends the following procedure:

1. Clean the seat cushion with a damp cloth and Arctic Cat Vinyl Protectant (p/n 0638-313).
2. Clean the snowmobile thoroughly by hosing dirt, oil, grass, and other foreign matter from the skid frame, tunnel, hood, and belly pan. Allow the snowmobile to dry thoroughly. DO NOT get water into any part of the engine.

■ NOTE: On 4-stroke models, change the engine oil and clean the air filter; then proceed to step 9.

3. Place the rear of the snowmobile up on a shielded safety stand.
4. On the “Laydown” engine models, start the engine and allow to idle. With the engine idling, pry the intake boot forward; then spray Arctic Cat Engine Storage Preserver (p/n 0636-177) into the intakes until the engine exhaust starts to smoke heavily or until the engine starts to drop in RPM. Turn engine off.

■ NOTE: On the “Laydown” engine models after step 4, proceed to step 9.

■ NOTE: On some standard models, the air-intake silencer is a one-piece unit, and the silencer boot(s) can be removed to access the intake bore(s). Remove the boots; then proceed to step 8.

■ NOTE: On some standard models, the air-intake silencer includes a cover/tool tray assembly and a baffle/resonator, and the silencer boot cannot be removed to access the intake bores. Proceed to step 5.

5. Open the air-intake silencer cover; then remove the Phillips-head screws securing the cover/tool tray assembly to the silencer.
6. Close the cover; then tip the cover/tool tray assembly forward and out of its slots and remove the assembly.
7. Using a large flat-blade screwdriver, remove the baffle/resonator tabs from the air-intake silencer slots and remove the baffle/resonator to access the intake bores.

■ NOTE: The baffle/resonator can be removed more easily by removing the back tabs first.

8. Start the engine and allow to idle. With the engine idling, spray Arctic Cat Engine Storage Preserver (p/n 0636-177) into the intake(s) until the engine exhaust starts to smoke heavily or until the engine starts to drop in RPM. Turn engine off.

■ NOTE: On some models, install the air-intake silencer boot(s); on some models, install the baffle/ resonator and the cover/tool tray assembly.

9. Plug the exhaust system outlet with a clean cloth.

 **CAUTION**

Do not do step 10 on the 4-stroke models; severe engine damage could result.

10. With the ignition switch in the OFF position:
 - A. Disconnect the high tension leads from the spark plugs; then remove the plugs, connect them to the leads, and ground them on the cylinder heads.

 **CAUTION**

Never crank the engine over without grounding the spark plugs. Damage to coils and/or CDI unit may result.

- B. Pour 29.5 ml (1 fl oz) of SAE #30 petroleum-based oil into each spark plug hole and pull the recoil starter handle slowly about 10 times.

- C. Install the spark plugs and connect the high tension leads.

11. On carbureted models, drain the gas from each carburetor float chamber.
12. Fill the gas tank to its rated capacity; then add Arctic Cat Fuel Stabilizer (p/n 0638-165) to the gas tank following directions on the container for the stabilizer/gasoline ratio. Tighten the gas tank cap securely.
13. On standard chain case models, drain the chain-case lubricant by removing the chain-case drain plug located on the backside of the chain-case assembly. Remove the chain-case cover and inspect chain, sprockets, chain tensioner, and rollers for wear and the chain for proper tension. Install the drain plug, chain-case cover, and seal; then pour the recommended amount of Arctic Cat Transmission Lube (p/n 0636-817) into the filler hole (see Lubrication section).
14. On ACT drive gear case models, flush the gear case and replace the lubricant (see Lubrication section).
15. Remove the drive belt from the drive clutch/driven pulley. Lay the belt on a flat surface or slide it into a cardboard sleeve to prevent warping or distortion during storage.
16. Clean and inspect the drive clutch and driven pulley.

17. Apply light oil to the upper steering post bushing, ski spindles and bolts, front and rear pivot bushings of the skid frame, and plungers of the shock absorbers.
18. Lubricate the rear suspension, spindles, speedometer drive adapter, and driven shaft support bearing with a low-temperature grease.
19. Tighten all nuts, bolts, and cap screws making sure all calibrated nuts, bolts, and cap screws are tightened to specifications. Make sure all rivets holding the components together are tight. Replace all loose rivets.
20. Clean and polish the hood, console, and chassis with Arctic Cat Hood and Windshield Cleaner/Polish (p/n 0636-174). **DO NOT USE SOLVENTS OR SPRAY CLEANERS. THE PROPELLANT WILL DAMAGE THE FINISH.**
21. On electric start models, disconnect the battery cables making sure to disconnect the negative cable first; then clean the battery posts and cables. On models with a sealed battery, use Arctic Cat Battery Charger (p/n 0436-634) when charging the battery.



CAUTION

Sealed batteries require charging if left for extended non-start periods. Arctic Cat recommends not servicing the battery until the snowmobile is to be used or trickle charging once a month. Follow the manufacturer's instructions and cautions.

22. If possible, store the snowmobile indoors. Raise the track off the floor by blocking up the back end making sure the snowmobile is secure. Loosen the track adjusting bolts to reduce track tension. Cover the snowmobile with a machine cover or a heavy tarpaulin to protect it from dirt and dust.
23. If the snowmobile must be stored outdoors, position the snowmobile out of direct sunlight; then block the entire snowmobile off the ground making sure the snowmobile is secure. Loosen the track adjusting bolts to reduce track tension. Cover with a machine cover or a heavy tarpaulin to protect it from dirt, dust, and rain.



CAUTION

Avoid storing in direct sunlight and using a plastic cover as moisture may collect on the snowmobile causing corrosion.

PREPARATION AFTER STORAGE

Taking the snowmobile out of storage and correctly preparing it for another season will assure many miles and hours of trouble-free snowmobiling. Arctic Cat recommends the following procedure:

CAUTION

On carbureted models if the gas in each carburetor float chamber was not drained prior to storage, the carburetor(s) must be cleaned before starting the engine.

1. Clean the snowmobile thoroughly. Polish the exterior of the snowmobile.
2. Clean the engine. Remove the cloth from the exhaust system. Check exhaust system and air-intake silencer/air filter for obstructions.
3. Inspect all control wires and cables for signs of wear or fraying. Replace if necessary. Use cable ties or tape to route wires and cables away from hot or rotating parts.
4. Inspect the drive belt for cracks and tears. Check belt specifications. Replace if damaged or worn. Install the drive belt.

■ NOTE: If the old belt is worn but in reasonable condition, retain it with the snowmobile as a spare in case of emergency.

5. On carbureted models, inspect the in-line fuel filter and replace if necessary.
6. Inspect all fuel hoses and oil hoses for deterioration or cracks; replace if necessary. Make sure all connections are tight; then on 2-stroke models, fill the oil-injection reservoir with the recommended 2-cycle oil (see Gasoline-Oil sub-section).

■ NOTE: After prolonged storage of 2-stroke models, Arctic Cat recommends one tankful of 100:1 gas/oil mixture be used in conjunction with the oil-injection system to ensure proper lubrication.

7. On 2-stroke and 660 cc models, inspect the spark plugs. Replace, gap, or clean as necessary.
8. Adjust the carburetor(s) and choke cable on carbureted models and throttle cable on all models.

WARNING

Be sure to tighten the swivel adapter jam nuts securely. If a jam nut isn't tightened, the adjuster can rotate out of the carburetor cap causing the throttle slide not to return to the full-closed position.

9. Tighten all nuts, bolts, and cap screws making sure all calibrated nuts, bolts, and cap screws are tightened to specifications.

10. Lubricate the rear suspension, spindles, speedometer drive adapter, and driven shaft support bearing with a low-temperature grease.
11. On liquid cooled models, check the coolant level and all coolant hoses and connections for deterioration or cracks. Add properly mixed coolant as necessary.
12. On fan cooled models, clean the engine cooling fins and vents.
13. On 2-stroke models, place the rear of the snowmobile on a shielded safety stand; then start the engine. Allow the engine to idle; then using a long stiff wire with a hooked end, raise the oil-injection pump control arm to the wide-open position until the engine starts to smoke heavily. Release the control arm and turn off the engine.
14. On electric start models, charge the battery until fully charged; then connect the battery cables making sure to connect the positive cable first. Test the electric start system.
15. Inspect the entire brake system, all controls, headlight, taillight, brakelight, ski wear bars, and headlight aim; adjust or replace as necessary.
16. Adjust the track to the proper tension and alignment. Lock the jam nuts.

U.S. EPA EMISSION CONTROL STATEMENT/ WARRANTY COVERAGE (U.S. Only)

STATEMENT/WARRANTY

Arctic Cat warrants to the original retail purchaser, and each subsequent purchaser, that all U.S. EPA-certified Arctic Cat snowmobiles are designed, built, and equipped to conform to all U.S. EPA Emission Control Regulations. Please read the following information completely.

Your authorized Arctic Cat snowmobile dealer will repair or replace any defective emission-related component at no cost to you during the warranty period. You may have non-warranty service performed by any repair establishment that uses equivalent components. The regulations provide significant civil penalties for tampering that causes your snowmobile to no longer meet U.S. EPA emission standards.

Arctic Cat further warrants that the engine and its emission-related components are free from defects in materials or workmanship that could cause the engine to fail to comply with applicable regulations during the warranty period.

If you have any questions about this information, or the emission warranty coverage statement, contact your local authorized Arctic Cat snowmobile dealer.

WARRANTY PERIOD

The emission warranty period for this snowmobile begins on the same date as the standard warranty coverage and continues for 30 months or 2500 miles, whichever comes first.

COMPONENTS COVERED

The emissions warranty covers major emissions control components and emission-related components listed as follows:

Engine Management and Sensors

Barometric Pressure Sensor
Camshaft Position Sensor
Engine Control Unit (ECU)
Engine Coolant Temperature Sensor
Intake Air Temperature Sensor
Manifold Absolute Pressure Sensor
Oxygen Sensor
Throttle Position Sensor

Ignition System

Ignition Coil
Knock Sensor System
Spark Plugs
Capacitive Discharge Ignition (CDI) Module
Magneto Pick-Up

Fuel/Air System

Fuel Injectors
Fuel Pressure Regulator
Carburetor(s)
Turbocharger Assembly
Air Bypass Valve
Turbo Waste Gate Control Valve
Crankcase Ventilation System

Miscellaneous Items Used in Aforementioned Systems

Connectors
Switches
Grommets
Clamps
Hoses
Ties
Gaskets
Wiring

OWNER'S RESPONSIBILITIES

The owner of any snowmobile warranted under this Arctic Cat Emission Control Statement is responsible for the proper maintenance and use of the snowmobile as stated in the Operator's Manual. Proper maintenance generally includes replacement and service, at the owner's choosing, such items as air filter, oil and oil filter, or any other part, item, or device related to emissions control as specified in the Operator's Manual. It is the owner's responsibility to ensure that the snowmobile is used in a manner for which it was designed.

**CHANGE OF ADDRESS, OWNERSHIP,
OR WARRANTY TRANSFER**

Arctic Cat Inc. keeps on file the current name and address of the owner of this snowmobile. This will allow Arctic Cat to reach the current owner with any important safety information which may be necessary to protect customers from personal injury or property damage. Please make sure a copy of this form is completed and returned to Arctic Cat Inc. if you move or if the snowmobile is sold to another party.

This form may also be used to transfer the unused portion of the original warranty to a second party. In order to transfer warranty, fill out this form completely; then return a copy of this form to Arctic Cat Inc. Arctic Cat will then process the application and issue warranty for the balance of the time remaining of the original warranty.

- Address Change
- Ownership Change
- Warranty Transfer

**CHANGE OF ADDRESS/OWNERSHIP/
WARRANTY TRANSFER TO:**

Name _____

Address _____

City/State (Province)/Zip Code (Postal Code) _____

Phone # () _____

Year and Model Snowmobile _____

Vehicle Identification Number (VIN) _____

Fold Back Once



CHANGE OF ADDRESS/OWNERSHIP



Place
Stamp
Here

**ARCTIC CAT INC.
PRODUCT SERVICE AND
WARRANTY DEPT.
P.O. BOX 810
THIEF RIVER FALLS, MN 56701**

WARRANTY PROCEDURE/OWNER RESPONSIBILITY

At the time of sale, an Owner Registration form (included with each new snowmobile) is to be completed by the selling dealer and consumer. The receipt of the registration form by Arctic Cat is a condition precedent to warranty coverage. It is the selling dealer's responsibility to retain and/or submit the appropriate copies of the form to the appropriate place(s) to initiate warranty coverage.

The dealer will furnish to the consumer a signed copy of the form which must be presented to the dealer when requesting warranty service. **The registration form is the consumer's proof of ownership and warranty eligibility. The form is used by the dealer to validate the warranty claim.** Retain your copy of the form and keep it in a safe place.

When warranty repair is suspected, the snowmobile should be taken to the selling dealer, who has the primary responsibility to perform warranty repairs. In the event the selling dealer has ceased to do business, you have moved, or you are in a location away from your selling dealer, warranty may be performed by any authorized Arctic Cat Snowmobile dealer.

The authorized Arctic Cat Snowmobile dealer will examine the snowmobile or part to determine if, in his opinion, a warrantable condition exists. If a warrantable condition appears to exist, the dealer will repair or replace, at Arctic Cat's option, free of charge, including any related labor costs, all parts that are found to be warrantable and any other parts which the warrantable part caused to be damaged. You, the consumer, will then be asked to sign a warranty form to ensure Arctic Cat that the warranty work was actually performed.

It is the consumer's responsibility to maintain and service the snowmobile in accordance with Arctic Cat's recommendations in the Operator's Manual. To protect yourself and your snowmobile, follow all safety and service tips. **Arctic Cat will NOT warrant repairs required as a result of not performing standard operator maintenance, storage procedures, and service as outlined in the Operator's Manual.**

Should you have any questions concerning the warranty, contact an authorized Arctic Cat Snowmobile dealer.

