



Installation Manual

MINISPLIT HIGH WALL AIR CONDITIONER

MODELS

MHC-MHH/BOC-BOH 07

MHC-MHH/BOC-BOH 09

MHC-MHH/BOC-BOH 12

MHC-MHH/BOC-BOH 18

MHC-MHH/BOC-BOH 25

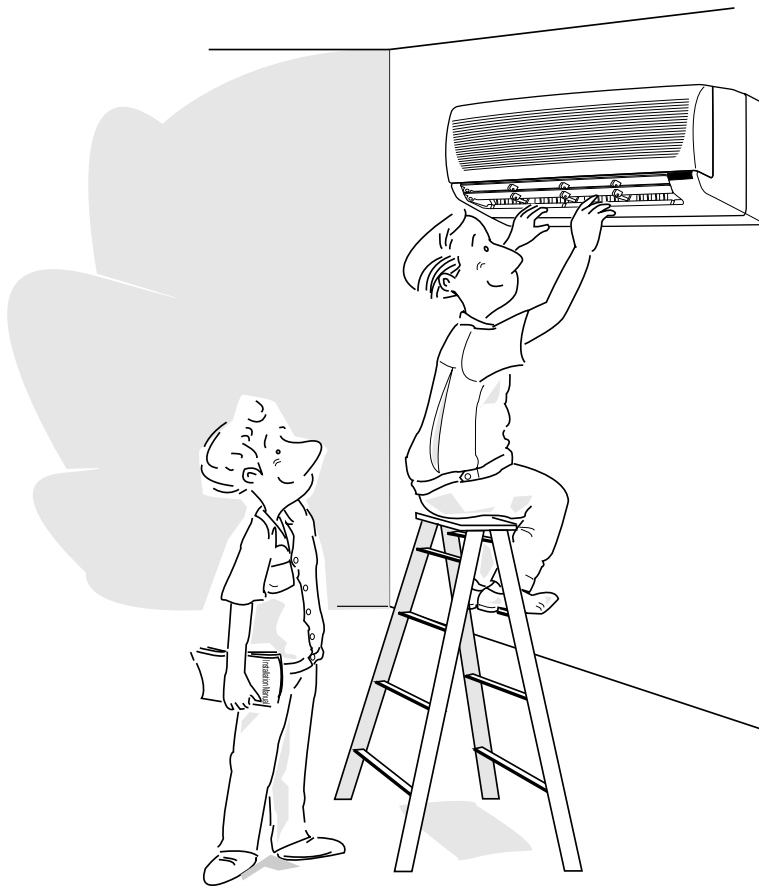

035T80000-000

CONTENTS



Please read this installation manual carefully before starting the installation. It will tell you necessary information.

Quality POLICY

We will continuously strive to satisfy our customers with consistent reliability in product, service and support.

Safety Precautions	4
Part List	5
Preparation Before Installation	6
Installation Diagram	8
Installation Procedure	9
Test Operation	13
Trouble Shooting Guide	14
Technical Specification	15

REQUIRED TOOLS

1. Screw driver
2. Hexagonal wrench
3. Torque wrench
4. Spanner
5. Reamer
6. Hole core drill
7. Tape measure
8. Thermometer
9. Manifold Guage
10. Gas leak detector
11. Vaccum pump
12. Pipe clamp
13. Pipe Cutter
14. Flare Tool Set
15. Electrical Circuit tester

EXTENDED PARTS

1. Refrigerant Pipe

Models	MHC-MHH/BOC-BOH		
	07-09	12	18-25
Liquid size	1/4 inch	1/4 inch	3/8 inch
Gas size	3/8 inch	1/2 inch	5/8 inch

2. Pipe Insulation Material (Polyethylene foam 9 mm thick)
3. Vinyl tape
4. Putty

SAFETY PRECAUTIONS

- Please read this installation manual carefully before starting installation of the unit.
- This air conditioning system contains refrigerant under pressure, rotating parts and electrical connection which may be dangerous and can cause injury. Installation and maintenance of this air conditioning system should only be carried out by trained and qualified personnel.
- After unpacking, please check the unit carefully for possible damage.
- Before undertaking any work on the unit, make sure that the power supply has been disconnected.

CAUTIONS FOR INSTALLATION

Do not store or unpack the unit in a wet area or expose to rain or water.

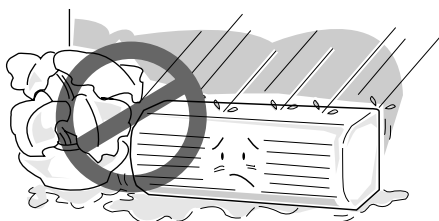

It may cause the unit to short circuit and may result electric shocks or fire.

Do not conduct installation in wet area or in the rain.

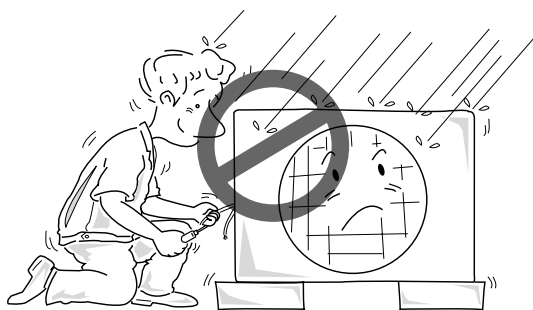

It is a high risk to cause the electrical shocks.

Do not install in a place where flammable gas may leak.





It may cause fire.

This system is designed for domestic or residential use only.

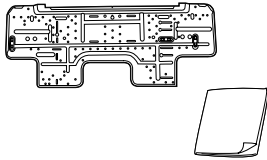
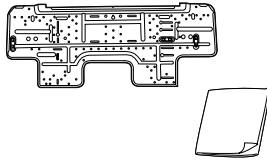
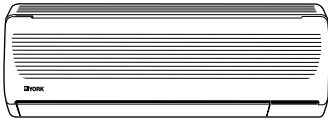
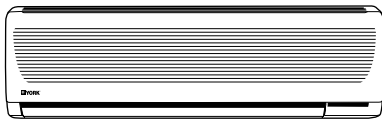
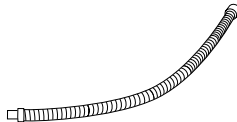
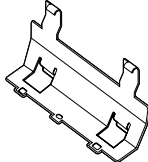
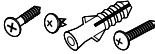
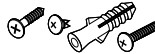

If used in certain environments, such as a manufacturing workplace, the equipment may not function efficiently.

PART LIST

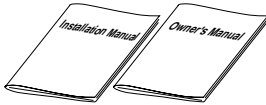
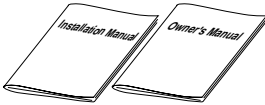
Part No.	Name of part		Quantity
	MHC-MHH/BOC-BOH 07, 09, 12	MHC-MHH/BOC-BOH 18, 25	
①	Mounting Plate and Mounting Template		x1
			
②	Indoor Unit		x1
			
③	Drain Hose		x1
	*Included with indoor unit		
④	Central mounting bracket		x1
	*Not supplied		
⑤	Screws and Anchor Set		x4
			
⑥	Remote Control and Batteries Set		x1
			
⑦	Installation and Owner's manual		x1
			

PREPARATION BEFORE INSTALLATION

- Before doing any work, check the interior power supply cord and the main breaker capacity are sufficient and the installation area is sufficient and complies with the requirements.
- Check that the power supply available agrees with nameplate voltage.
- Electrical work, wiring and cables must be performed in compliance with national and local wiring codes and standard.
- Do not use the extension cables. In the case extended cables are needed, use the terminal block.

SELECTION OF THE LOCATION

- Select a place which provides the space around the units as shown in the diagram below.

Indoor

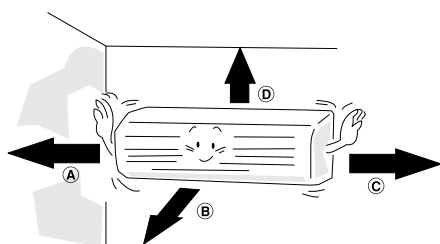

Outdoor

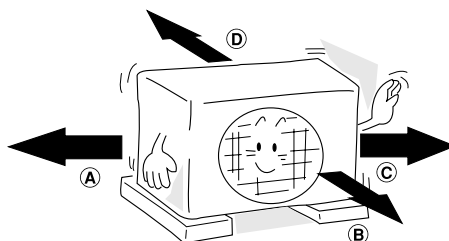

Models	MHC-MHH/BOC-BOH				
	07	09	12	18	25
A	60cm	60cm	60cm	60cm	60cm
B	70cm	70cm	70cm	70cm	70cm
C	60cm	60cm	60cm	60cm	60cm
D	10cm	10cm	10cm	10cm	10cm

Models	MHC-MHH/BOC-BOH				
	07	09	12	18	25
A	20cm	20cm	20cm	20cm	20cm
B	60cm	60cm	60cm	60cm	60cm
C	40cm	40cm	40cm	40cm	40cm
D	20cm	20cm	20cm	20cm	20cm

Cautions

- Do not install in a place that cannot bear the weight of the unit.

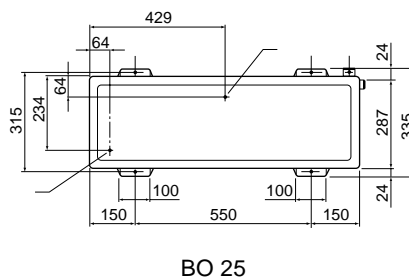
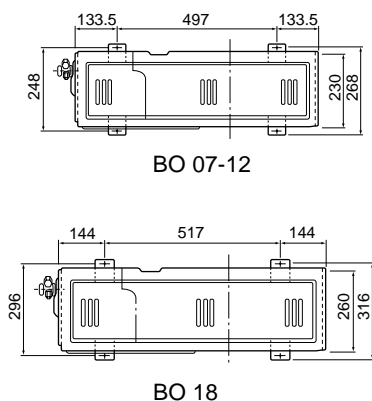

INSTALLATION IN THE FOLLOWING PLACES MAY RESULT IN TROUBLE

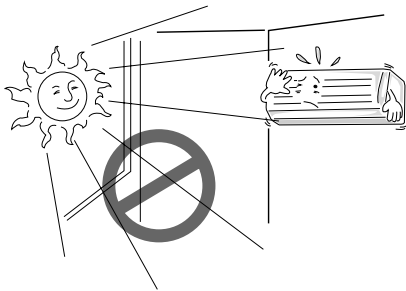

Installation of the indoor unit in direct sun light.

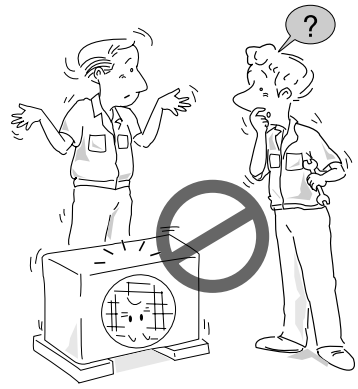

Installation in the unit in wrong direction.

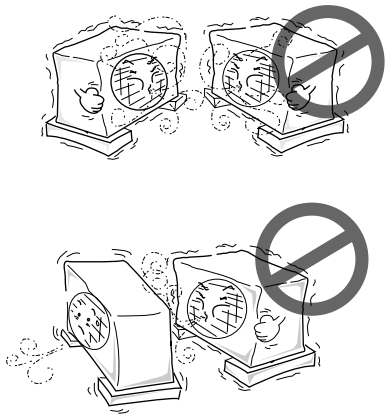

Installation of outdoor units too close or, blowing discharged air into each other.

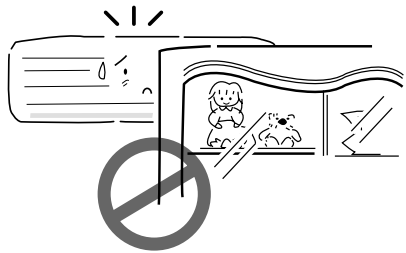

Installation of the indoor unit in a place where there is an obstacle near the air inlet or outlet.

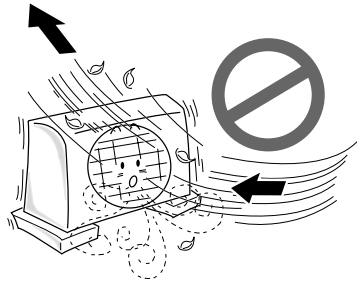

Installation of the outdoor unit in a place exposed regularly to a strong wind.

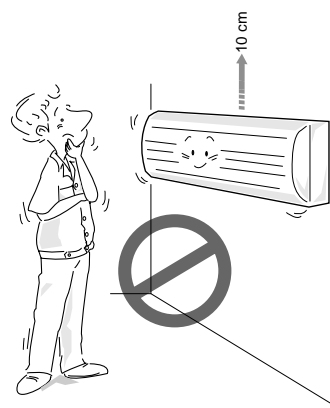

Installation of the indoor unit at too low a position

INSTALLATION DIAGRAM

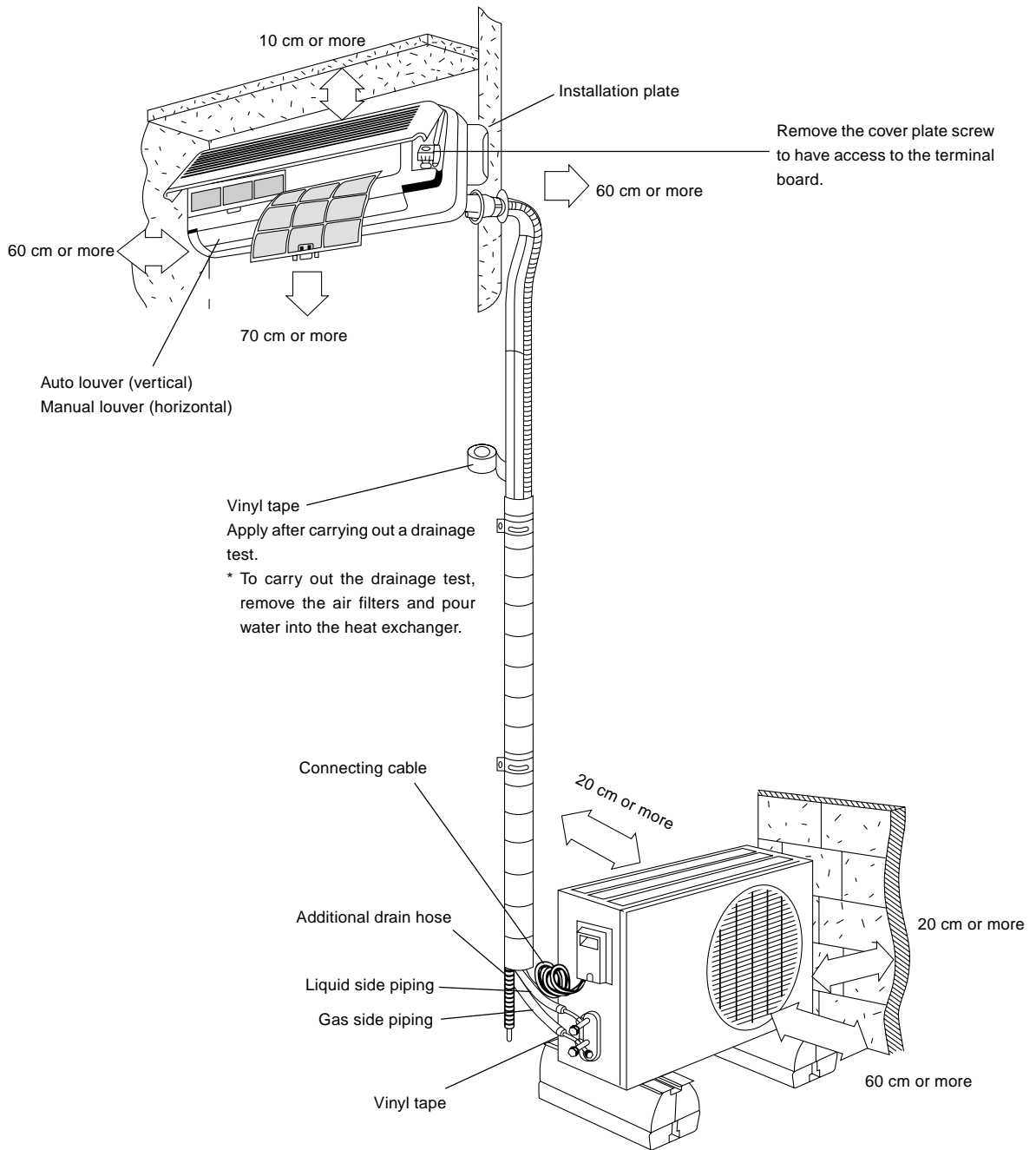

INSTALLATION PROCEDURE

INDOOR UNIT

■ Fixing

- Place the installation guide pattern on the designated installation place and mark the hole position.
- Drill a hole and mount installation plate.

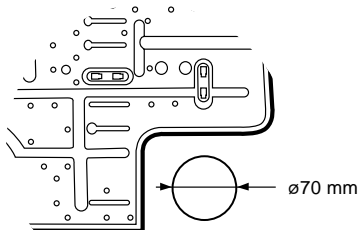

- After determining the pipe hole position. Drill the hole at a slight downward slant towards the outdoor side.

Note : When installing the refrigerant pipes from others side. A hole must be place to allow fall towards the outdoor unit.

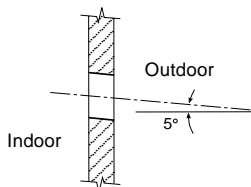

- Make $\phi 5\text{mm}$. 4-6 holes, in the wall at the four corners of mounting plate (bracket) then insert appropriate mouting devices.
- Install the mounting plate using 4-6 pieces of mounting screw securely at four corners and tighten the screw completely. Do not over tighten the screws and deform the back plate.

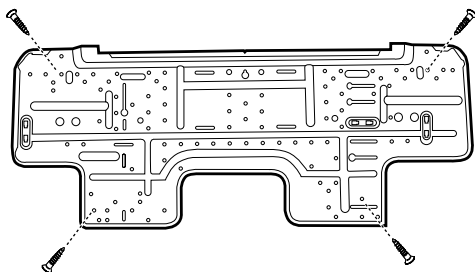

Caution

- Be careful when handling the sharp edge of the mounting plate.

■ Wiring

- This indoor unit is ready for connection to the outdoor unit.

Cautions

- Never modify the unit by removing any of the safety guards or by bypassing any of the safety interlock switches.
- Connect the interconnecting cable correctly and connect the connecting cable to terminal as identified with their respective marking.
- Do not damage the conductor core or inner insulation of power supply cables and do not deform or crush the cables.

■ Piping

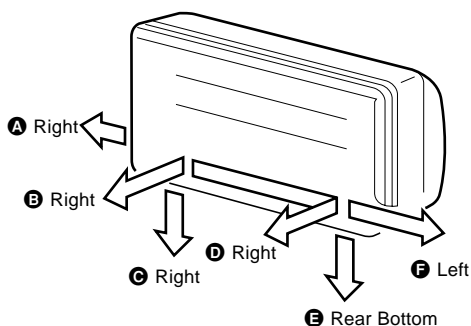

The auxiliary piping can be connected in the diections shown the above diagram. To connect in the D, E and F direction, pipes will need to be extended.

Cautions

- Bend pipes carefully to avoid flattening or obstructing them if the pipes are bent incorrectly, the indoor unit may be unstable on the wall.
- Carefully arrange pipes so that pipes do not stick out of the rear plate of the indoor unit.

■ Drain hose

- Drain hose is flexible and can be routed to suit various piping arrangements. The drain line must include elbow trap (U bend). Connect a plastic condensate pipe with an internal diameter of 12 mm.

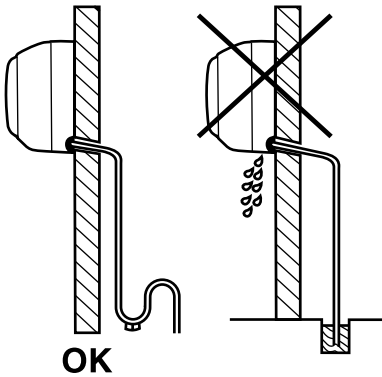

Note: Do not put the drain hose end into water.

- The drain hose can be connected to the left or the right side.

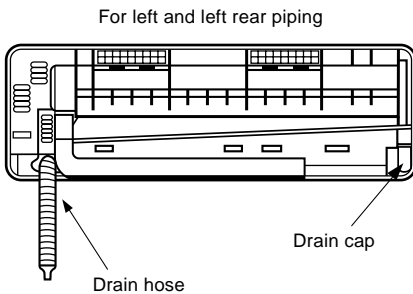
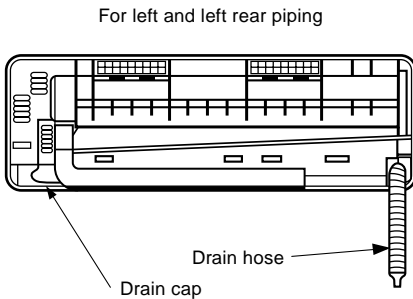

- Verification of condensate water drainage:**
Fill the drain pan with water and observe evacuation.

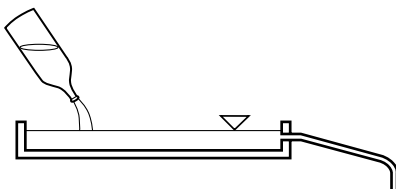

■ Indoor Unit Fixing

- Thread the indoor unit piping and cable through the hole.
- Hang the top of the unit onto the upper ridge of them in mounting plate.
- Make sure that the unit is correctly hung in place by sliding it to the left, then to the right.
- Press the bottom left and bottom right hand corners of the unit against the mounting plate until the fixing prongs click into place in the retainers provided to that effect.

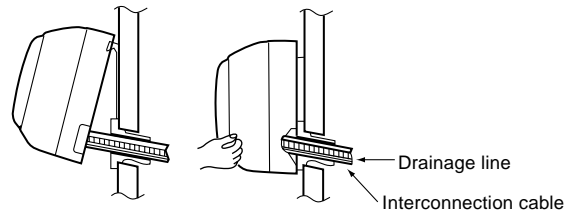

(MHC-MHH/BOC-BOH 07-25)

- For the model MHC-MHH/BOC-BOH 18 and 25 and install the central mounting bracket as shown in the below diagram.

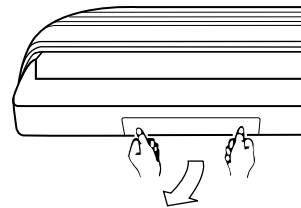

(MHC-MHH/BOC-BOH 18 and 25)

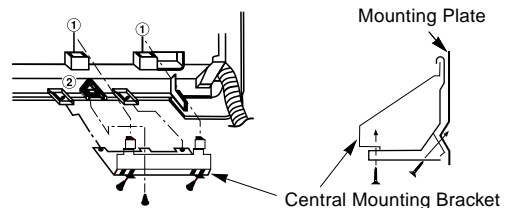

(MHC-MHH/BOC-BOH 18 and 25)

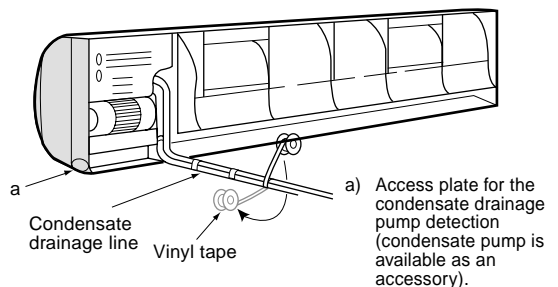

Note: The condensate evacuation line should be taped to the refrigerant lines with vinyl tape.

OUTDOOR UNIT

■ Fixing and Piping

- Piping must be performed by qualified personnel according to good refrigeration systems practices.
- Piping materials and insulation materials must be of refrigerant quality.
- Select the pipe diameters according to the size of unit and cut the pipe to design length by using pipe cutter.
- Install the flare nuts and flare the end of the pipes.
- Check that no foreign bodies are inside the piping.
- Align the central of the connecting pipes and tighten the flare nut.
- Fix piping with pipe clamps and check that any pipe vibrations cannot be transmitted to the building structure.

Notes

- Connect the pipe correctly.
- Do not apply the excessive torque.
- Use an appropriate bending tool to form curves and avoid over-tightening the refrigerant tubes.
- To prevent heat loss, the two lines must be insulated separately.

■ Maximum piping lengths

Unit size	7	9	12	18	25
D (m)	10	12	15	15	22
L (m)	12	15	18	18	25
H (m)	7	10	12	12	20

Note : Where the difference in elevation between the indoor unit and the outdoor unit is greater than 5 meters, install an oil trap every 5 meters.

The suction line must have a 2% gradient up to the compressor on horizontal sections.

Where piping lengths are unusually long and include a large number of oil traps, it may be necessary to adjust to compressor charge.

Refrigerant charge to be added per extra metre of piping length when more than 7.5 meters.

Unit size	MHC-MHH/BOC-BOH				
	7	9	12	18	25
g/m	15	15	15	40	40

■ Refrigerant piping connections (FLARE connections)

To avoid alteration of unit capacities, check that piping lengths and changes in elevation are kept to a strict minimum.

Before connecting the refrigerant lines, follow the procedures below (if pre-charged connection lines are not supplied):

- Select copper pipe diameters according to the size of unit to be installed.
- Install the refrigeration lines, checking that no foreign bodies get inside the piping.
- Install the flare connectors and flare the ends of the pipes.

- Evacuate the piping. This operation, which should last at least 15 minutes if there are large piping lengths and changes in elevation, should be followed by a leak test. To this effect, when the piping has been evacuated, close the pressure gauge tap, note the value on the gauge, then wait for 15 minutes. If the needle moves, there is a leak in the system. Make the necessary adjustments or repairs and repeat this procedure until the needle no longer moves.
- Open the service valves and top up the refrigerant charge if necessary.

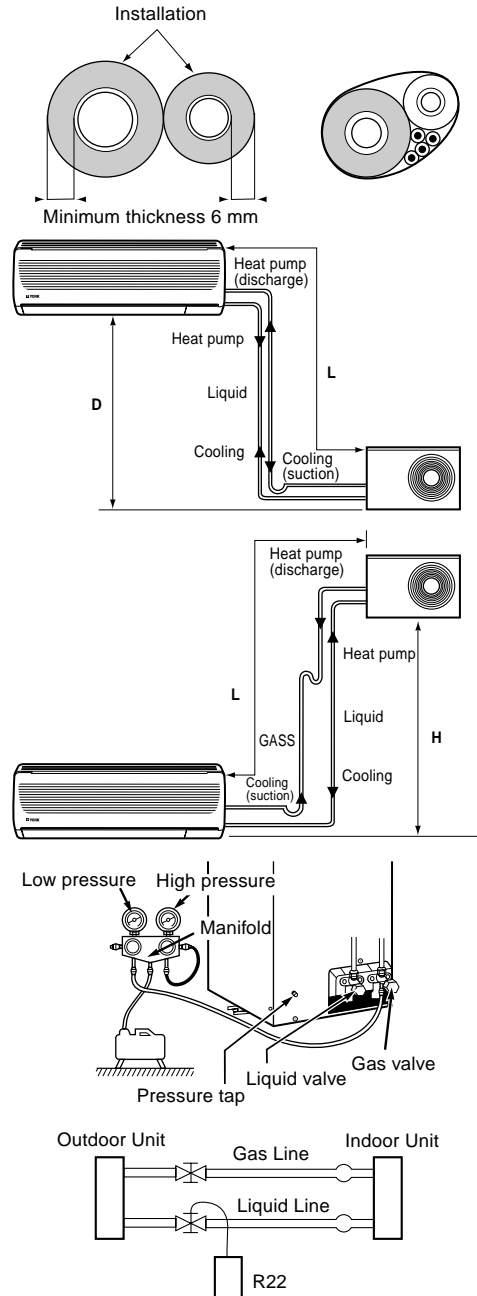

This unit is shipped complete with a charge of R22 refrigerant that will be sufficient for an interconnecting piping length of 5 meters.

■ Vertical Discharge Condensing Unit (H*DA, H*DB, H*RA)

The indoor unit and interconnecting wiring voltage is 220 volts. Where the outdoor unit requires a different operating voltage such as 24 volts one of the following solutions can be applied.

1. The coil of the relay switching the compressor and reversing valves should be changed to a 220V coil.
2. A transformer should be installed to supply 24 volts and a relay installed with a 220 volt coil to switch the 24 volts required by the outdoor units. The transformer should be energised at all times and not switched by the start signal from the indoor unit. Switching the transformer directly will cause electronic noise which may cause malfunction of the electronics.

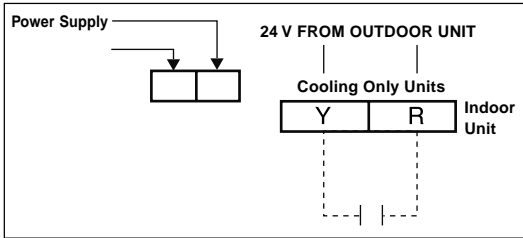

■ Wiring

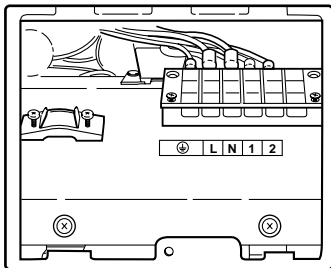
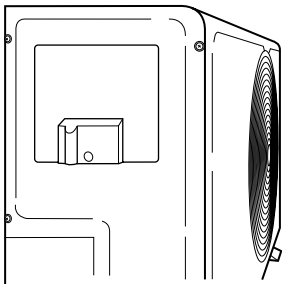

For further detail on wiring of these units, see the diagrams pasted inside each unit.

Cautions

- Never modify the unit by removing any of the safety guards or by bypassing any of the safety interlock switches.
- Connect the connecting cable correctly and connect the connecting cable to terminal as identified with their respective marks.
- Do not scratch the conductive core & inner insulator of power supply cables and do not deform or smash on the surface of cables.

■ Electrical Connections

All electrical wiring and connections must comply with local codes and standards. Power supply cord and interconnection cord used must not be lighter than Polychloroprene sheathed cord (245 IEC 57 or H05RN-F). Disconnecting device must have a contact separation of at least 3 mm.

MHC 07-25 -Cooling Only

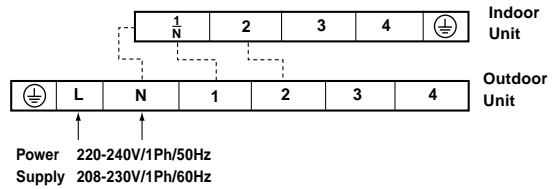

MHC 07-25 -Heat Pump

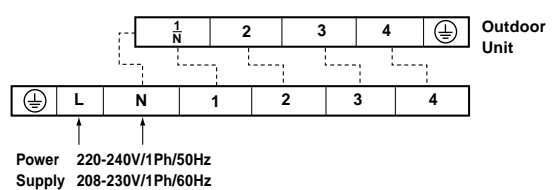

For correct installation, a proper ground connection must be made for unit.

Wiring sizes

Unit size		7	9	12	18	25
Power supply	mm ²	3x2.5			3x4	
Interconnection (Indoor/Outdoor)	Cooling mm ²	3x2.5 + Ground				
	Heating mm ²	4x2.5 + Ground				
Fuse (slow-Blow)	A	10		16	20	

Or as required to meet national and local codes.

Notes

- Terminals N and 1 (see diagrams above) correspond to power supply to the indoor unit coming from the outdoor unit.
- Compressor power supply is established by terminal 2.
- Power supply to the 4-way valve is established by terminal 3.
- For further details on wiring of these units, see the diagrams pasted inside each unit.

TEST OPERATION

CHECK THIS ITEM BEFORE START OPERATION

Outdoor

- Check the flare nut connections, valve stem cap connections and service cap connections for gas leak with a leak detector or soap water.

Indoor

- Check the unit is firmly fixed.
- Check the connecting pipes are tighten securely.
- Check the pipe insulation.
- Check the drainage.
- Check the connection of the grounding wire.

PROTECTION MODES

Your air conditioner includes several automatic protection modes, which enables you to use it virtually at any time and in any season, regardless of the outdoor temperature. Some of the protection modes are listed below:

Mode	Operation conditions	Protection from	Controlled remedy
Cooling and Dry	Low outdoor temperature	Indoor coil freezing up	Stop outdoor fan and Compressor when approaching freezing conditions. Resumes operation automatically.
	High outdoor temperature	Outdoor coil overheating	Stops compressor when approaching over heating conditions. Resumes operation automatically. Operating indicator blinks.
Heating	Low outdoor temperature	Outdoor coil ice build up	Reverses operation from heating to cooling for short periods to de-ice outdoor coil. Operating indicator blinks.
	High indoor or outdoor temperature	Indoor coil overheating	Stops outdoor fan and compressor when approaching high indoor coil temperature. Resumes operation automatically.

TROUBLE SHOOTING GUIDE

Problem	Probable cause	Remedy
A. The air conditioner does not run.	<ol style="list-style-type: none"> 1. Power Failure. 2. Fuse blown or circuit breaker open. 3. Voltage is too low. 4. Faulty contactor or relay. 5. Electrical connections loose. 6. Thermostat adjustment too low (in heating mode) or too high (in cooling mode) 7. Faulty Capacitor 8. Incorrect wiring, terminal loose 9. Pressure switch tripped 	<ol style="list-style-type: none"> 1. Wait for Power resume. 2. Replace the fuse or reset the breaker. 3. Find the cause and fix it. 4. Replace the faulty component. 5. Retighten the connection. 6. Check Thermostat setting. 7. Find the cause then replace Capacitor. 8. Check and retighten. 9. Find the cause before reset.
B. The outdoor fan runs but the compressor will not start.	<ol style="list-style-type: none"> 1. Motor winding cut or grounded. 2. Faulty Capacitor. 	<ol style="list-style-type: none"> 1. Check the wiring and the compressor winding resistance. 2. Find the cause then replace Capacitor.
C. There is insufficient heating or cooling.	<ol style="list-style-type: none"> 1. There is a gas leak. 2. Liquid and gas line insulated together. 3. The room was probably very hot (cool) when you started the system. 	<ol style="list-style-type: none"> 1. Remove charge, repair, evacuate and recharge. 2. Insulate them separately. 3. Wait while unit has enough time to cool the room.
D. The compressor run continuously.	<ol style="list-style-type: none"> 1. Thermostat adjustment too low (in heating mode) or too high (in cooling mode) 2. Faulty fan. 3. Refrigerant charge too low, leak. 4. Air or incondensables in refrigerant circuit. 	<ol style="list-style-type: none"> 1. Check Thermostat setting. 2. Check condenser air circulation. 3. Find leak, repair and recharge. 4. Remove charge, evacuate and recharge.
E. The compressor starts but shuts down quickly.	<ol style="list-style-type: none"> 1. Too much or too little refrigerant. 2. Faulty compressor. 3. Air or incondensables in refrigerant circuit. 4. Changeover valve damaged or blocked open (heat pump unit) 	<ol style="list-style-type: none"> 1. Remove charge, evacuate and recharge. 2. Determine the cause and replace compressor. 3. Remove charge, evacuate and recharge. 4. Replace it.
F. Clicking sound is heard from the air conditioner.	In heating or cooling operation any plastic parts may expand or shrink due to a sudden temperature change in this event, a clicking sound may occur.	In heating or cooling operation any plastic parts may expand or shrink due to a sudden temperature change in this event, a clicking sound may occur.

TECHNICAL SPECIFICATION

INDOOR UNIT

Models	Indoor Unit		MHC-MHH				
			07	09	12	18	25
	Outdoor Unit		BOC-BOH				
		07	09	12	18	25	
Power Supply		V/Ph/Hz	220-240/1/50				
		Ph	1	1	1	1	1
Maximum Power Consumption		kW	0.7	0.85	1.2	2	2.8
Running Current		A	3.5	4.5	5.6	9.1	11.5
Fuse Size		A	10	10	10	16	20
System Operation Control			Wireless Remote Control with LCD Display				
Compressor		Type	Rotary				
Piping	Diameter	Suction	3/8"	3/8"	1/2"	5/8"	5/8"
		Liquid	1/4"	1/4"	1/4"	3/8"	3/8"
Dimensions	Indoor	H(mm)	290	290	290	315	356
		W(mm)	799	799	799	1,019	1,019
		D(mm)	181	181	181	180	180
	Outdoor	H(mm)	492	492	492	590	696
		W(mm)	764	764	764	820	850
		D(mm)	230	230	230	280	287
Weights	Indoor	kg	11	11	11	18	18
	Outdoor	kg	34	36	38	59	65

CONDENSING UNIT

■ BOC-BOH

Models	Outdoor Unit	BOC-BOH					
		07	09	12	18	25	
Power Supply		V/Ph/Hz	220/240/1/50				
		Ph	1	1	1	1	1
Power Consumption	kW	0.77	0.91	1.21	1.73	2.62	
Running Current	A	3.77	4.42	5.52	8.42	12.82	
Compressor		Rotary					
Refrigerant Type		R-22					
Air Flow	m ³ /h	1,220	1,220	1,220	3,310	3,310	
noise Level	dBa	50	50	51	57	57	

■ R407C

Models	Outdoor Unit	MOL-MOM				
		07	09	12	18	25
Power Supply	V/Ph/Hz	220/240/1/50				
	Ph	1	1	1	1	1
Power Consumption	kW	0.77	0.93	1.34	1.77	2.65
Running Current	A	3.52	4.32	6.12	8.12	12.42
Compressor	Rotary					
Refrigerant Type	R-407C					
Air Flow	m ³ /h	1,220	1,220	1,220	3,310	3,832
noise Level	dBa	50	50	51	57	57

■ H*DA

Models	Outdoor Unit	H*DA							
		012	018	024	030	036	048	060	076
Power Supply	V/Ph/Hz	220-240/1/50				380/3/50			
	Ph	1	1	1	1	3	3	3	3
Compressor	Reciprocating								
Refrigerant Type	R-22								

■ H*DB

Models	Outdoor Unit	H*DB								
		012	018	024	030	036	042	048	060	076
Power Supply	V/Ph/Hz	208/230-1-60								-
		-				460-3-60	-	460-3-60		
	Ph	1	1	1	1	1/3	1	1/3	1/3	3
Compressor	Reciprocating						Scroll		Recip	
Refrigerant Type	R-22									

■ H*RA

Models	Outdoor Unit	H*RA					
		018	024	030	036	048	060
Power Supply	V/Ph/Hz	220-240/1/50			380/3/50		
	Ph	1	1	1	1	3	3
Compressor	Reciprocating						
Refrigerant Type	R-22						
Power Supply	V/Ph/Hz	208/230-1-60					
	Ph	1	1	1	1	1	1
Compressor	Reciprocating					Scroll	
Refrigerant Type	R-22						

■ MMC-MMH

Models	Outdoor	MMC-MMH				
	Unit	018	021	025	036	050
Power Supply	V/Ph/Hz	220-240/1/50 or 380-415/3/50				
	Ph	1	1	1	1	1
Power Consumption	kW	2x0.85	0.85x1.20	2x1.20	2x1.73	2x2.26
Running Current	A	2x4.5	4.5x5.7	2x5.7	16.9	26.5
Compressor		Rotary				Recip
Refrigerant Type		R-22				
Power Supply	V/Ph/Hz	208-230/1/60				
	Ph	1	1	1	1	1
Power Consumption	kW	2x0.85	0.85x1.20	2x1.20	2x1.73	2x2.26
Running Current	A	2x4.5	4.5x5.7	2x5.7	16.9	26.5
Compressor		Rotary				Recip
Refrigerant Type		R-22				

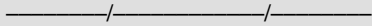

A large white rectangular area with rounded corners, containing 25 horizontal lines for writing. The lines are evenly spaced and extend across the width of the area.

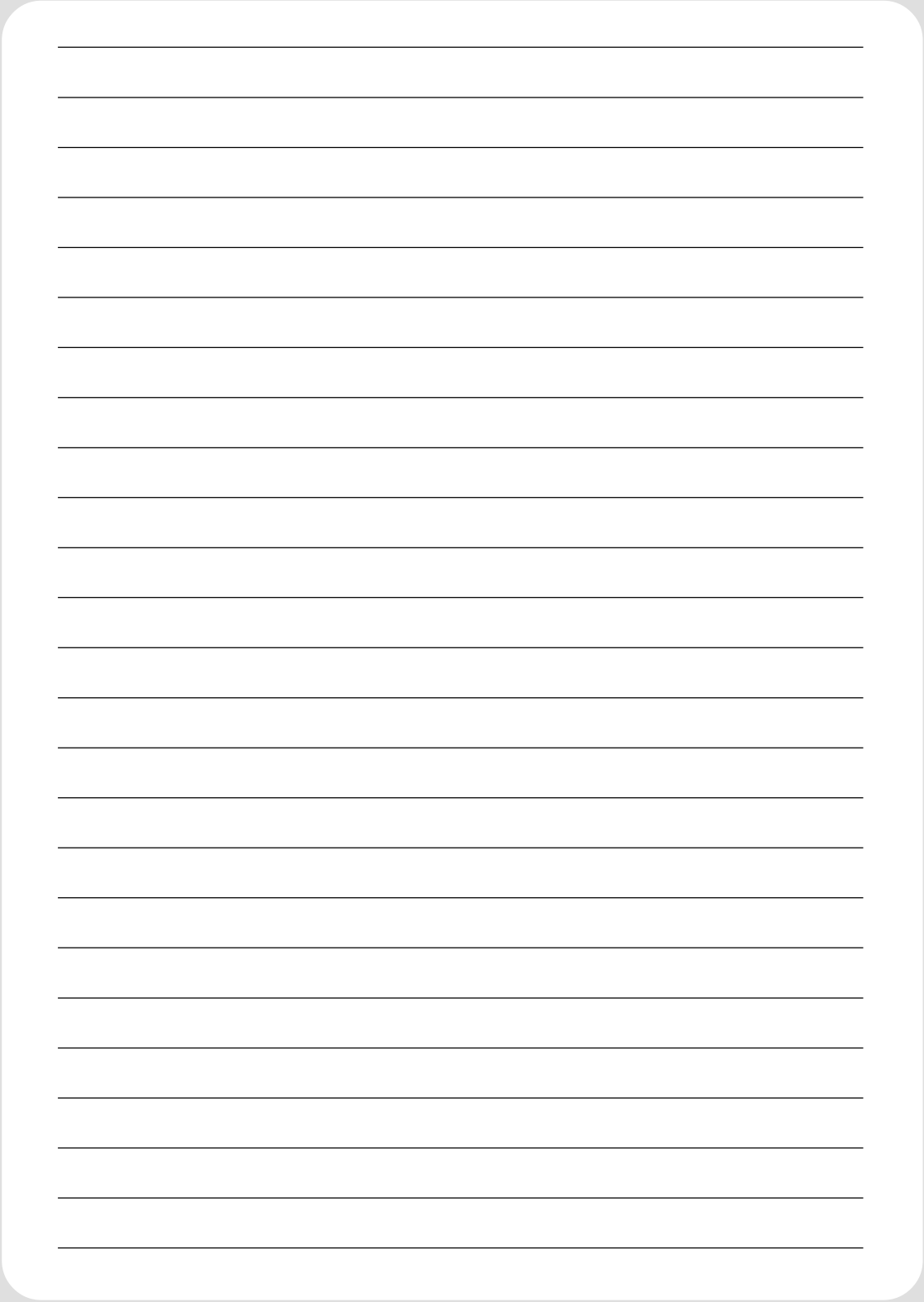

DE - COMMISSIONING DISMANTLING & DISPOSAL

This product contains refrigerant under pressure, rotating parts, and electrical connections which may be a danger and cause injury!

All work must only be carried out by competent persons using suitable protective clothing and safety precautions.



Read the Manual



Risk of electric shock



Unit is remotely controlled and may start without warning

1. Isolate all sources of electrical supply to the unit including any control system supplies switched by the unit. Ensure that all points of electrical and gas isolation are secured in the OFF position. The supply cables and gas pipework may then be disconnected and removed. For points of connection refer to unit installation instructions.
2. Remove all refrigerant from each system of the unit into a suitable container using a refrigerant reclaim or recovery unit. This refrigerant may then be re-used, if appropriate, or returned to the manufacturer for disposal. **Under No circumstances should refrigerant be vented to atmosphere.** Where appropriate, drain the refrigerant oil from each system into a suitable container and dispose of according to local laws and regulations governing disposal of oily wastes.
3. Packaged unit can generally be removed in one piece after disconnection as above. Any fixing down bolts should be removed and then unit lifted from position using the points provided and equipment of adequate lifting capacity. Reference **MUST** be made to the unit installation instructions for unit weight and correct methods of lifting. Note that any residual or spilt refrigerant oil should be mopped up and disposed of as described above.
4. After removal from position the unit parts may be disposed of according to local laws and regulations.



YORK® International Corporation

