



EXTERNAL

IEEE1394
FireWire

CD-R/RW DRIVE ***CRW2200IX SERIES***

OWNER'S MANUAL
BEDIENUNGSANLEITUNG
MODE D'EMPLOI
MANUAL DE INSTRUCCIONES

English

Deutsch

Français

Español

20x 10x 40x
CD-R CD-RW CD-ROM



FCC INFORMATION

COMPLIANCE INFORMATION STATEMENT

(DECLARATION OF CONFORMITY PROCEDURE)

Responsible Party: Yamaha Electronics Corporation, USA.
Address: 6660 Orangethorpe Avenue
Buena Park, CA 90620
Telephone: 714-522-9105
Fax: 714-670-0108
Type of Equipment: CD Recordable/Rewritable Drive
Model Name: CRW2200IX

This device complies with Part 15 of the FCC Rules.

Operation is subject to the following conditions:

- 1) this device may not cause harmful interference, and
- 2) this device must accept any interference received including interference that may cause undesired operation.

See user manual instructions if interference to radio reception is suspected.

FCC INFORMATION (U.S.A.)

1. IMPORTANT NOTICE: DO NOT MODIFY THIS UNIT!

This product, when installed as indicated in the instructions contained in this manual, meets FCC requirements. Modifications not expressly approved by Yamaha may void your authority, granted by the FCC, to use the product.

- 2. IMPORTANT:** When connecting this product to accessories and/or another product use only high quality shielded cables. Cable/s supplied with this product MUST be used. Follow all installation instructions. Failure to follow instructions could void your FCC authorization to use this product in the USA.

- 3. NOTE:** This product has been tested and found to comply with the requirements listed in FCC Regulations, Part 15 for Class "B" digital devices. Compliance with these requirements provides a reasonable level of assurance that your use of this product in a residential environment will not result in harmful interference with other electronic devices. This equipment generates/uses radio frequencies and, if not installed and used according to the instructions found in the users manual, may cause interference harmful to the operation of other electronic devices. Compliance with FCC regulations does not guarantee that interference will not occur in all installations. If this product is found to be the source of interference, which can be determined by turning the product "OFF" and "ON", please try to eliminate the problem by using one of the following measures:

Relocate either this product or the device that is being affected by the interference.

Utilize power outlets that are on different branch (circuit breaker or fuse) circuits or install AC line filter/s.

In the case of radio or TV interference, relocate/reorient the antenna. If the antenna lead-in is 300 ohm ribbon lead, change the lead-in to coaxial type cable.

If these corrective measures do not produce satisfactory results, please contact the local retailer authorized to distribute this type of product. If you can not locate the appropriate retailer, please contact Yamaha Electronics Corporation, USA, 6660 Orangethorpe Avenue, Buena Park, CA 90620 U.S.A.



EXTERNAL **IEEE1394**
FireWire

CD-R/RW DRIVE

CRW2200IX SERIES

20x 10x 40x
CD-R CD-RW CD-ROM



OWNER'S MANUAL

SAFETY PRECAUTIONS

PLEASE READ THE FOLLOWING WARNING AND CAUTION CAREFULLY TO PROTECT YOUR PERSONAL SAFETY AND PREVENT DAMAGE TO THE DEVICE.

These precautions explain how to use the device correctly and safely, thereby preventing injury to yourself or to others. This section has been sub-divided into a WARNING section and a CAUTION section, according to the likelihood and nature of any potential injuries or damage inflicted. They relate to your personal safety, and also help you minimize the risk of damaging the device. Please read these sections carefully before proceeding.



WARNING

Always follow these basic precautions to prevent short-circuit, damage, fire, or other hazards, and to prevent serious injury or death from electrical shock.

- To avoid risk of electrical shock or fire, do not attempt to open or disassemble the device.
- To avoid risk of eye damage or blindness, do not look inside the device.
- To avoid the risk of personal injury or electrical shock, do not insert your fingers, or foreign objects into the device. Please take particular care if small children are present.
- To avoid the risk of electrical shock, fire, or personal injury, do not expose the device to rain, use it near water, or in damp or wet conditions, or place containers that contain liquids (they may spill into the unit) on the device.
- To avoid risk of personal injury, electrical shock, fire, or damage to the unit, follow the Owner's Manual carefully and set up the unit correctly.
- If unusual smells, sounds or smoke come from the device, turn off the computer immediately to avoid the risk of electrical shock, fire or damage to the device, and return the device to the place of purchase, or alternatively, to your nearest Yamaha dealer (listed at the back of this manual).
- Make sure the computer is electrically grounded to avoid the risk of electrical shock.
- When opening up the computer, unplug it from the electrical outlet (do not touch the plug with wet hands) as there is an increased risk of electrical shock.
- The drive should not be exposed to temperatures outside the range 5 – 35 °C (41 – 95 °F) to avoid risk of malfunction, fire or personal injury.
- To avoid the risk of electrical shock or fire, be sure to use the correct voltage rating or the device may not operate properly.
- Clean the AC power plug regularly, especially the blades, to avoid the risk of insulation failure or fire due to humidity.
- Do not pull on the cord itself when disconnecting from the electrical outlet, or let objects rest or roll over the cord, as the cord can be damaged and cause electrical shock or fire.

- Insert the AC plug firmly, as a poor connection can result in electrical shock or fire.
- Only use the included AC adapter, as malfunction or fire may result.
- Do not connect too many devices to a single electrical outlet, or use voltages exceeding the rated voltage as this may cause overheating and fire.



CAUTION

Always follow these basic precautions to prevent physical injury to yourself or others, or damage to the instrument or other property.

- To avoid the risk of electrical shock or fire, always unplug the computer from the electrical outlet if it will not be used for a prolonged period of time, or if there is a risk of lightning.
- Do not expose the device to excessive vibration, heat, cold or dust, as doing so may result in damage to the unit's front panel or its internal components.
- Do not use the device near other products such as televisions, radios, or speakers as this may cause interference, which can affect the proper operation of the device or other devices.
- To avoid damage to the device or personal injury, always place the device in a stable position.
- Always place the device horizontally (see Owner's Manual) to avoid the risk of lost written data.
- Always remove any disc from the disc tray before transporting the device as written data may be lost.
- Use a soft, dry cloth to wipe the device. Do not use benzene, paint thinners, detergents, or chemically treated wiping cloths as these may damage the unit.
Do not place vinyl, plastic, or rubber objects on the device as chemical reactions can cause damage to the device.
- Do not rest your weight on or place heavy objects on the device, or use excessive force on the buttons, switches or connectors, as damage to the unit or personal injury may occur.
- Do not listen to audio with headphones at high volume for prolonged periods of time as your hearing may be damaged as a result.
- Before using the device, always turn down the volume as sudden bursts of sound can result in hearing damage.
- Do not place the device anywhere near sources of magnetic interference as operational stability may be adversely affected.
- Have the device serviced regularly to avoid internal dust buildup that can cause malfunction, damage or fire. For service information, and about service charges, contact the store of purchase, or your nearest Yamaha dealer (listed in the back of this manual).
- Do not allow the plug of the AC adapter to come into contact with metal as a short circuit can result and cause a malfunction or damage to the device.
- Do not wrap the power cord around the AC adapter as it may become disconnected and cause a malfunction.

■ About handling CD-R/RW discs

1. Do not store discs in areas subject to excessive humidity or heat (i.e., in direct sunlight or near a heater).
2. Do not touch the surface of a disc.
When handling a disc, hold it by the edges.
3. Remove dust and dirt from the surface of a disc.
Use an air-blower (i.e., camera lens blower) to remove dust. The surface of a disc may be scratched if wiped with a dry cloth.
4. Do not stick labels on the surface of a disc.
5. Do not write on the surface of a disc except where indicated.
6. Do not clean discs with chemicals or detergents.
7. Do not bend or drop discs.
8. Use only circular discs. Do not use irregularly shaped discs, such as star, heart or card shaped, etc., as these could damage your new CD-R/RW drive.

- 1. The information contained in this manual is subject to change without prior notice.**
- 2. All trademarks contained in this manual belong to their respective owners.**
- 3. Yamaha does not bear any responsibility for a problem that occurs as a result of any operations carried out other than those stated in the manual included with the drive.**
- 4. Reproduction of this manual, either in part or in full, is expressly forbidden.**

■ Precautions for Transportation

Before transporting the device, always put it in its original box. If the device is transported without adequate packing, the internal components may be damaged and cause the device to malfunction.

■ Copyrights

When writing to a CD-R/RW, make sure that you do not infringe on any copyrights. It is illegal to copy audio CDs for non-personal use. When backing up software, make sure that you do not infringe on any software copyrights for that product.

■ WARRANTY

YAMAHA AND ITS SUPPLIERS ACCEPT NO LIABILITY FOR THE LOSS OF ANY DATA OR ANY PROBLEMS CAUSED AS A RESULT. AS A PRECAUTION, IT IS RECOMMENDED THAT THE DISCS BE TESTED AFTER THEY HAVE BEEN WRITTEN TO. FURTHERMORE, UNDER NO CIRCUMSTANCES DOES YAMAHA AND ITS SUPPLIERS GUARANTEE THE RELIABILITY OF THE DISCS.



Table of Contents

| | |
|--|-----------|
| Introduction | 1 |
| Features of the CRW2200IX Drive..... | 1 |
| Before Use | 4 |
| System Requirements..... | 4 |
| Supported Discs..... | 6 |
| Serial Number | 8 |
| Front and Rear of Unit | 9 |
| Front Panel | 9 |
| Rear Panel | 10 |
| Setup Procedures | 11 |
| Windows Users | 11 |
| Macintosh Users..... | 12 |
| Install the CD Writing Software..... | 13 |
| Set Up the CRW2200IX Drive..... | 13 |
| Configuring for the Operating System..... | 18 |
| Operation | 20 |
| Connecting and Disconnecting IEEE1394 Devices..... | 20 |
| Loading a Disc | 21 |
| Ejecting a Disc | 21 |
| Ejecting a Disc in an Emergency | 22 |
| Troubleshooting | 23 |
| Appendix | 28 |
| Connecting Multiple IEEE1394 Peripherals Together..... | 28 |
| Writing Modes..... | 30 |
| About the Firmware | 32 |
| LED Indicator Messages | 33 |
| CRW2200IX Specifications..... | 34 |
| Index..... | 37 |

©2001 YAMAHA CORPORATION. All Rights Reserved.

This document may not, in whole or in part, be copied, photocopied, reproduced, translated, transmitted, or reduced to any electronic medium of machine readable form without prior consent in writing from Yamaha.

Windows is a registered trademark of Microsoft Corporation.

Apple, Macintosh, Mac OS, and FireWire are registered trademarks of Apple Computer, Inc.

SafeBurn™ is a trademark of Yamaha Corporation.

All other trademarks are the property of their respective companies.



Introduction

Features of the CRW2200IX Drive

High speed writing/reading

The **CRW2200IX** drive supports up to 20X-speed writing of CD-R discs, ^{*1} and up to 10X-speed writing/rewriting of CD-RW discs. ^{*2} Furthermore, the drive supports data reading and digital audio data extraction at up to 40X speed.

Easy setup

Implementation of an IEEE1394 interface (also known as FireWire or i.LINK) eliminates the need for drive configurations (device ID, termination, etc.). You can connect and start using the drive whenever you wish without restarting your computer.

SafeBurn™ (Enhanced write stability technology)

Generous 8MB of buffer memory

Because of the large data storage area, stable disc writing is possible even at fast speeds.

Buffer Underrun Protection

When data transfer from the host PC is interrupted, Buffer Underrun Protection is activated to keep precious CD-R discs from going to waste. (→P. 3)

Optimum Write Speed Control

Before writing to a CD-R, the **CRW2200IX** drive checks the disc's capability and automatically selects the optimum writing speed^{*3} for greater reliability. The speed you set is the maximum writing speed.

Reliable writing

Yamaha's proprietary Pure-Phase Laser System (patent applied for)

This technology reduces phase interference of the laser beam, so that it projects accurately onto the disc. Jitter value, an important measure of recording quality, has been improved 25% compared with Yamaha models not using this technology.

Running OPC (Optimum Power Control)

Running OPC automatically adjusts the output of the laser according to the characteristics of the disc being used. Running OPC provides greatly enhanced recording reliability for various manufacturer's discs.

High-fidelity digital audio

The **CRW2200IX** drive supports extraction of digital audio data at up to 40X speed, as well as the recording of digital sound with complete fidelity even when writing at 20X speed.

CD TEXT support

Information such as the song name or artist name can be recorded on Audio CDs using CD creation software. The text data on the created disc can be displayed on a CD player that is compatible with the CD TEXT format.

**1 16X- or 20X-speed writing is enabled with the Partial CAV method. (→P. 7)*

**2 10X-speed writing/rewriting is enabled with the CLV method and the 4X-10X Full CAV method. (→P. 8)*

**3 The optimal writing speed automatically selected will be between 8X speed and the maximum speed designated for that disc. If the disc is rated at lower than 8X speed writing, you need to designate the most suitable writing speed manually.*

About IEEE1394

IEEE1394 is an industry standard approved by IEEE (Institute of Electrical and Electronics Engineers). The serial interface has a broad bandwidth and is fast enough to transfer large amounts of digital video and audio data bi-directionally between electronic devices including computer peripherals. Also known as FireWire and i.LINK, the IEEE1394 interface allows units to transfer data or various controls over a single IEEE1394 interface cable. Unlike legacy serial interfaces such as RS-232C, IEEE1394 allows for daisy-chaining devices (serial connection) with data transfer possible between any two devices on the chain. IEEE1394 also supports a tree (parallel) connection of devices. In addition to this flexibility, IEEE1394 also eliminates the need for complicated settings such as device ID and termination as found with SCSI (Small Computer System Interface) type interfaces. As of this writing, IEEE1394 supports three different data transfer rates: 100 Mbps, 200 Mbps, and 400 Mbps.

Buffer Underrun Defined

CD-R/RW drives are equipped with buffer memory. This memory temporarily stores data while a disc is being recorded. When buffer memory becomes empty (due to unexpected interruptions or the system's inability to keep up with the writing process), a writing error occurs. This error is known as a "buffer underrun error."

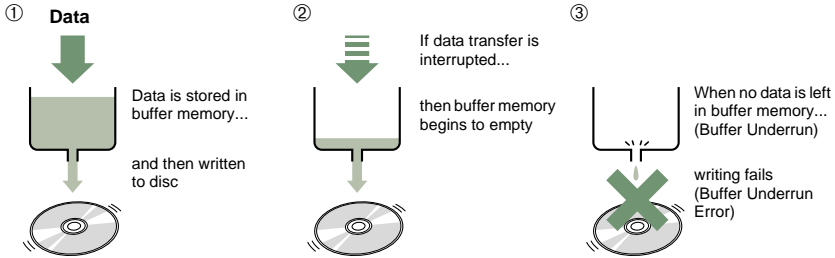

A Buffer Underrun Error will permanently ruin the disc.

Yamaha Buffer Underrun Protection

Buffer Underrun Protection is featured in Yamaha's **CRW2200** series CD-R/RW drives. When a buffer underrun is about to occur, a buffer underrun error is prevented by temporarily suspending the writing process. Writing resumes when enough data has accumulated again in buffer memory. Buffer Underrun Protection on the **CRW2200** series is extremely accurate, resulting in seamless recording between stop and continuation points.

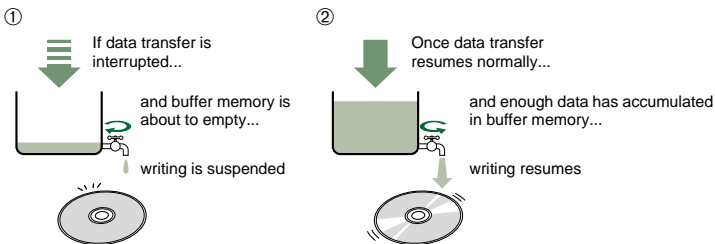

Yamaha Buffer Underrun Protection ensures error-free results.

Test-writing for Buffer Underrun

You can run a check for the likely occurrence of Buffer Underrun by Test-writing a CD-RW disc. The occurrence of a Buffer Underrun depends on your computer system.

Most writing software includes test-writing functions to check the likely occurrence of Buffer Underrun before actually writing the disc.

Buffer Underrun Protection is set to ON by default. Test-writing is not available in this setting. To use test-writing with your computer system, the Buffer Underrun Protection should be set to OFF.

System Requirements

In order to use the **CRW2200IX** drive, your computer system will need to meet the following requirements.

Notes

- The **CRW2200IX** drive may not write at the maximum speed depending on your computer's system configuration.
- For best performance, refer also to the CD writing software documentation for system requirements (e.g., hardware, OS, etc.).

Windows Users

Computer

- PC/AT-compatible computer
- CPU: Pentium II, 300 MHz or faster.
- RAM: 64 MB or more.
- IEEE1394 port: At least one IEEE1394 port is required.

Note

This port may be a built-in (onboard) type, or provided with a PCI expansion card or a CardBus card. If you newly install an IEEE1394 PCI or CardBus interface card, your computer should have an empty PCI expansion slot or a CardBus slot. For more information about the IEEE1394 interface card, refer to "IEEE1394 Interface Card (PCI or CardBus)" shown below.

Operating System (OS)

Windows 98 Second Edition, Windows Me, Windows 2000 Professional

CD-ROM Drive

You may need another CD-ROM drive for any CD-related operations (playback of an audio CD, installation from CD-ROM, etc.) until you verify that the **CRW2200IX** drive is successfully installed. Also you may need another CD-ROM drive if you are planning to copy a CD-ROM directly to a CD-R/RW disc on the **CRW2200IX** drive.

Note

The **CRW2200IX** drive cannot be used to install an operating system or to boot your computer from a CD-ROM containing an operating system.

IEEE1394 Interface Card (PCI or CardBus)

For the **CRW2200IX** drive to work properly with your computer, your IEEE1394 interface card must be OHCI compliant. As of this writing, Yamaha has verified compatibility with the following cards:

| Manufacturer | Product | Card Type |
|--------------|----------|-----------|
| Advansys | ASB30400 | PCI |
| SIIG | NN2603 | PCI |

Notes

- For the latest information about approved IEEE1394 interface cards, check the YAMAHA CD-R/RW Drive web site.
URL: <http://www.yamaha.co.jp/english/product/computer/>
- Some IEEE1394 interface cards may not work properly with your computer. Be sure to check for compatibility not only with your computer, but also with the **CRW2200IX** drive before purchasing a new IEEE1394 interface card.
- Even if you already have an IEEE1394 interface card installed and working properly in your computer, it may not be compatible with the **CRW2200IX** drive. Refer to the requirements listed on the previous page and to your interface card documentation to check for compatibility.

Macintosh Users

Computer

- Macintosh computer with a built-in FireWire port
- CPU: PowerPC G3, 300 MHz or faster.
- RAM: 64 MB or more.

Operating System

Mac OS 8.6, 9, 9.1 (Classic API with Mac OS X is not supported.)

Note

FireWire software version 2.2.2 or later is recommended for the **CRW2200IX** drive to work properly. The latest software is available from the Apple support web site.

CD-ROM Drive

You may need another CD-ROM drive for any CD-related operations (playback of an audio CD, installation from CD-ROM, etc.) until you verify that the **CRW2200IX** drive is successfully installed. Also you may need another CD-ROM drive if you are planning to copy a CD-ROM directly to a CD-R/RW disc on the **CRW2200IX** drive.

Note

The **CRW2200IX** drive cannot be used to install an operating system or to boot your computer from a CD-ROM containing an operating system.

CD Writing Software

The **CRW2200IX** drive requires a CD writing software to write onto a CD-R/RW disc. Make sure your CD writing software supports the **CRW2200IX** drive.

Note

For details about how to install and use the software, refer to the documentation that came with it.

Hard Drive Space





When writing to a CD-R/RW disc, you will need a working area (50 to 100 MB of free space) on the hard drive. If you want to create an image file containing all the data to be written to the CD-R/RW disc, in addition to the working area, you will need as much hard drive space as that data (up to 900 MB in total). However, this additional hard drive space for the image file is not needed when you are writing directly from a hard drive or CD-ROM drive, etc. (on-the-fly writing).

About disk image files

You can collect data files into a single disk image file for a CD-R/RW disc. Also, note that an image file is useful when writing multiple discs with the same content. For further details, refer to the documentation that came with your CD writing software.

Supported Discs

The **CRW2200IX** drive can write to discs that carry the following logos:

| | |
|---|---|
|  | <p>CD-R discs^{*1}</p> <p>The CRW2200IX drive can write to these discs at 1X, 2X, 4X, 8X, 12X, 16X, or 20X speed. These discs can be played back in a CD-ROM drive or a CD player.</p> <hr/> <p>Notes</p> <ul style="list-style-type: none"> • 16X- or 20X-speed writing is enabled with Partial CAV method. (→P. 7) • For 8X or faster writing, use CD-R discs that match their respective writing speeds. |
|  | <p>CD-RW discs^{*2}</p> <p>There are two types of CD-RW discs: those that support write/rewrite speeds of 1X, 2X, and 4X, and those that support only 2X. The CRW2200IX drive can write/rewrite at 2X or 4X speed on the first type of disc, and at 2X on the second type of disc. These discs can be read/played on a device (e.g., CD-ROM drive) that supports “CD-RW.”</p> |
|  | <p>High Speed CD-RW discs^{*3}</p> <p>These discs allow writing/rewriting at 4X to 10X speeds. The CRW2200IX drive can write/rewrite these discs at 4X, 8X, or 10X speed. These discs can be read/played by a CD-RW drive that bears the High Speed CD-RW logo, or by a device (e.g., CD-ROM drive) that supports “CD-RW.”</p> <hr/> <p>Note</p> <p>10X-speed writing/rewriting is enabled with the CLV method, and the 4X-10X Full CAV method. (→P. 8)</p> <p></p> <ul style="list-style-type: none"> • In order to write, erase, or read these discs using a CD-R/RW drive, a drive bearing the High Speed CD-RW logo must be used. When using a CD-ROM drive to read these discs, the drive must be capable of reading CD-RW discs. • If these discs are used in a CD-R/RW drive not bearing the High Speed CD-RW logo, the discs may not be recognized, resulting in the computer not operating correctly or other malfunctions occurring. • Refer to the page at the URL below before attempting to read these discs on a Yamaha CD-R/RW drive not bearing the High Speed CD-RW logo. URL: http://www.yamaha.co.jp/english/product/computer/ |

*1 Compatible with Orange Book Part 2.

*2 Compatible with Orange Book Part 3 Vol. 1.

*3 Compatible with Orange Book Part 3 Vol. 2.

Note

To find current information about approved discs for the drive, visit the YAMAHA CD-R/RW Drive web site.

URL: <http://www.yamaha.co.jp/english/product/computer/>

About the Orange Book

The Orange Book standard defines how all recordable discs (including CD-R and CD-RW) are written. Part 2 of the Orange Book standard relates to CD-R discs, and Part 3 to CD-RW discs. The standard was named after the color of the book's cover.

About CD-ROMs

A CD-ROM disc is a compact disc containing high-density read-only data. It has many applications, including the playback of music and video, the archiving of data, as well as on-line documentation. The following are descriptions of each CD-ROM format:

CD-DA: Up to 79 minutes of stereo audio is written in 16-bit resolution at a sampling rate of 44.1 kHz for a 79 minute disc.

Data CD: Up to 700 megabytes of computer data is stored in standard ISO9660 format for a 700 MB disc.

Video CD: These hold movies in which video and audio data has been compressed using MPEG-1 technology.

About Partial CAV (Constant Angular Velocity)

Writing to a CD-R disc is normally done using the CLV (Constant Linear Velocity) method. In this method, the disc rotation speed is adjusted so as to keep a constant data transfer rate at any portion of the disc. In other words, the disc rotation speed will vary in CLV writing.

In contrast, the CAV (Constant Angular Velocity) method uses a constant disc rotation speed for all portions of the disc so that the data transfer rate will vary. Because the CAV method has the advantage of largely increasing the data transfer rate with a minimum load to the drive's mechanism (compared to CLV's rotation speed adjustment), many current CD-ROM drives use the CAV method. CD formats define the constant linear density of written data (data should be written onto the disc at a constant pitch) so that the amount of recorded data per disc rotation will increase as the writing point moves from the inner to the outer. In other words, in CAV writing, the outer portion has an increased data transfer rate.

The **CRW2200IX** drive uses the CAV method in the inner portions as well as the CLV method in the outer portions (Partial CAV) in order to enable up to 20X-speed writing. The drive will control the disc rotation speed to start writing at 12X speed in the inner portions, gradually accelerating up to 20X speed and maintaining 20X speed in the outer portions.

About 10X-speed writing/rewriting of a High Speed CD-RW disc

10X-speed writing/rewriting of a High Speed CD-RW disc is enabled with the CLV method, and the 4X-10X Full CAV method. Commonly, writing/rewriting is enabled with the CLV method. When writing/rewriting with packet writing (→P. 31), you can also select the Full CAV method. For more details, refer to the documentation that came with your CD writing software. (Make sure that your CD writing software supports the Full CAV method.) For direct editing of a file on a CD-RW disc, the Full CAV method is recommended.

Serial Number

Once you have taken the **CRW2200IX** drive out of its packaging, you should immediately note down the serial number found at the bottom of the drive with the bar code. You may need to refer to this number when requesting Customer Support services. In the box below the following diagram, write down the 10-character serial number (consisting of 3 letters followed by 7 digits).

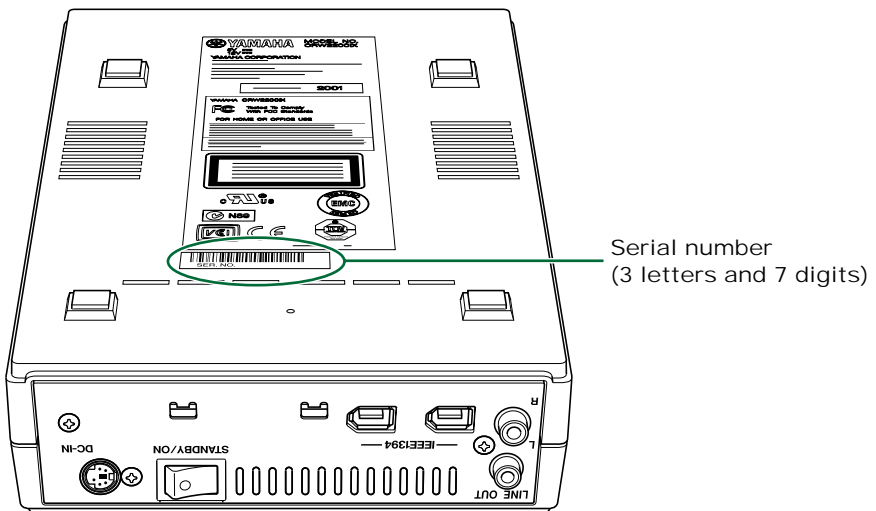

| | | | | | | | | | |
|------------|--|--|--|--|--|--|--|--|--|
| Serial No. | | | | | | | | | |
|------------|--|--|--|--|--|--|--|--|--|

Front and Rear of Unit

Front Panel

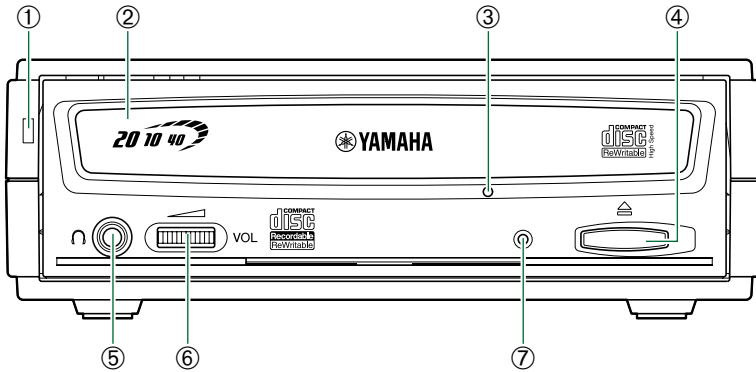

① Power LED

Lights up in green when the power of the drive is turned on.

② Disc tray

The disc tray is used to hold the disc. It slides out from the drive unit when a disc needs to be loaded or unloaded. (→P. 21)

③ Manual eject hole

Only use this if no other method is available for unloading a disc. (→P. 22)

④ Eject button

Press this button when you need to open or close the disc tray. Remove the disc after the disc tray has opened. (→P. 21)

⑤ Headphone jack

You can connect stereo headphones to this stereo mini jack and listen to an audio CD loaded in the drive.

⑥ Headphone volume control

Adjust this control to set a suitable volume level when listening to an audio CD using the headphone jack. Slide the knob to the left to decrease the volume and to the right to increase it.

⑦ LED

Indicates the operation status of the **CRW2200IX** drive. (→P. 33)

Rear Panel

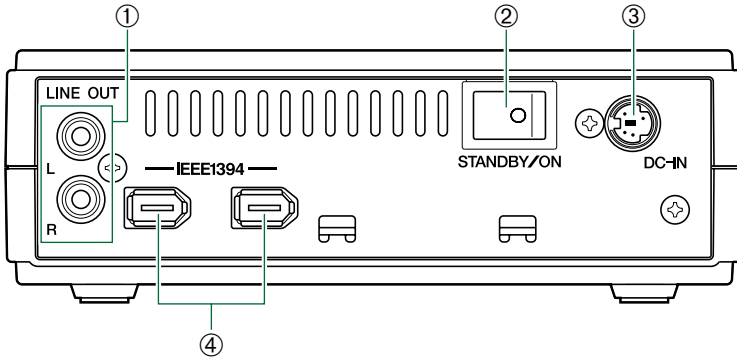

① LINE OUT jacks (L/R)

To listen to audio CDs with the **CRW2200IX** drive, connect these to the line level input (LINE IN) of the stereo equipment with a standard stereo phono cable (sold separately).

② Power switch (STANDBY/ON)

Turns the power on or off. (→P. 13, 15)

③ DC-IN connector

Insert the included AC adapter connector. (→P. 13)

④ IEEE1394 ports

Insert the connector of the IEEE1394 cable here. (→P. 16, 17)

Setup Procedures

This flowchart shows the procedure for setting up the **CRW2200IX** drive. For easy cross-referencing, the relevant pages in this manual are given.

Windows Users

Make sure that system configuration (CPU, RAM, OS, etc.) of your computer meets the requirements of the **CRW2200IX** drive (→P. 4, 5).

STEP 1 Does your computer have a built-in IEEE1394 port?

Yes

STEP 2 Install the CD writing software. Before installing the software, disconnect all IEEE1394 devices.

STEP 3 Set up the **CRW2200IX** drive (→P. 13 – 17).

- 1 Turn your computer and the drive both on before connecting.
- 2 Connect your computer and the drive using the IEEE1394 interface cable that came with the drive. You may need a different cable depending on the IEEE1394 port connector on your computer (→P. 17).

STEP 4 Make sure that the **CRW2200IX** drive is correctly recognized (→P. 18).

Start using the CRW2200IX drive

Use the drive to create an audio CD, to backup data on your hard drive, or for whatever purpose suits your needs.

Do you have an appropriate IEEE1394 interface card?

The card should be compatible with your computer.

Yes

Install the card to your computer.

Read the documentation that came with the card and properly set up your computer.

No

Purchase an IEEE1394 card.

See page 3 for more information about approved IEEE1394 interface cards that have been tested for compatibility with the **CRW2200IX** drive.

Macintosh Users

Make sure that system configuration (CPU, RAM, OS, etc.) of your computer meets the requirements of the CRW2200IX drive (→P. 5).

STEP
1 Install the CD writing software.

STEP
2 Set up the CRW2200IX drive (→P. 13 – 17).
1 Turn your computer and the drive both on before connecting.
2 Connect your computer and the drive using the IEEE1394 interface cable that came with the drive.

STEP
3 Make sure that the CRW2200IX drive is correctly recognized (→P. 19)
Before using the drive, make sure that the drive is recognized by the MacOS and CD writing software on your computer.

Start using the CRW2200IX drive

Use the drive to create an audio CD, to backup data on your hard drive, or for whatever purpose suits your needs.

Install the CD Writing Software

Before connecting the **CRW2200IX** drive and the computer as described below, make sure that you have installed appropriate CD writing software (→P. 5). If you use Windows and if the CD writing software is newly installed, first disconnect all IEEE1394 devices from your computer. After properly installing the software, you can connect the **CRW2200IX** drive. For information about how to install the software, refer to the documentation that came with it.

Set Up the CRW2200IX Drive

If your computer has no built-in IEEE1394 port, you will first need to install an IEEE1394 interface card (purchased separately). For information about how to install the card, refer to the documentation that came with it.

- 1 Turn on the computer.**
- 2 Make sure that the power switch on the rear panel of the CRW2200IX drive is set to STANDBY.**

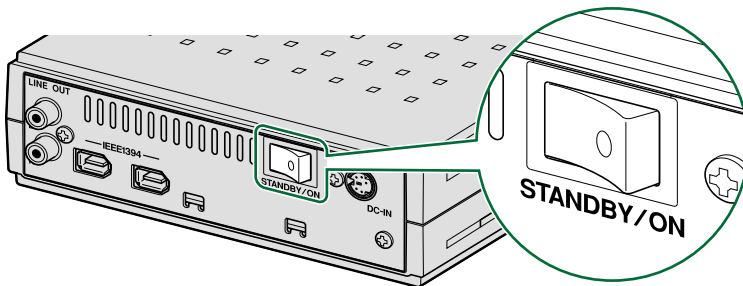

- 3 Connect the included AC adapter to the DC-IN connector of the drive with the arrow on the adapter plug facing left, as shown below.**

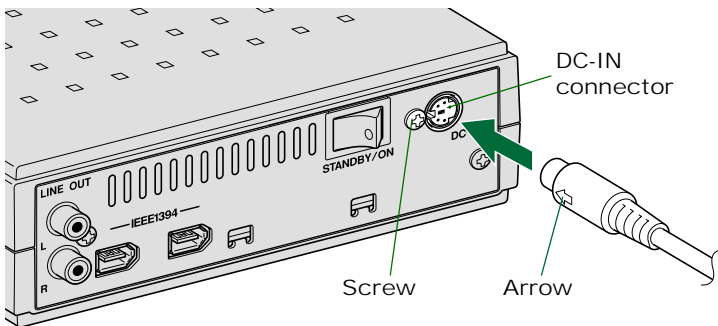

- 4** Connect the included power cable to the AC adapter (①).
Connect the other end of the power cable to the AC outlet (②).

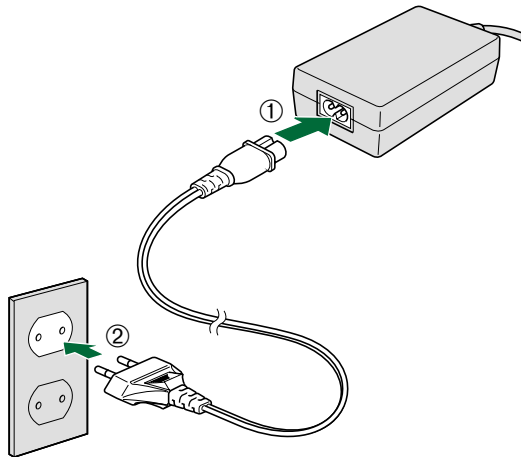

Electrical plugs/sockets vary according to country/region.

Notes

- Operate the drive only with the included AC adapter.
- The bottom of the drive and the AC adapter become warm during use.
This is not a malfunction.
- With the included AC adaptor connected to an AC outlet, even with the power of the drive turned off, power consumption is as shown in the table below. Always unplug the AC adapter from the AC outlet when you do not intend to use the drive for a long time.

| AC adapter (model) | Power source | Power consumption |
|--------------------|--------------|-------------------|
| SKB2505A | 100 V | 2.1 W |
| | 120 V | 2.4 W |
| SMB2505A | 220 – 240 V | 1.4 W |

5 Turn on the CRW2200IX drive.

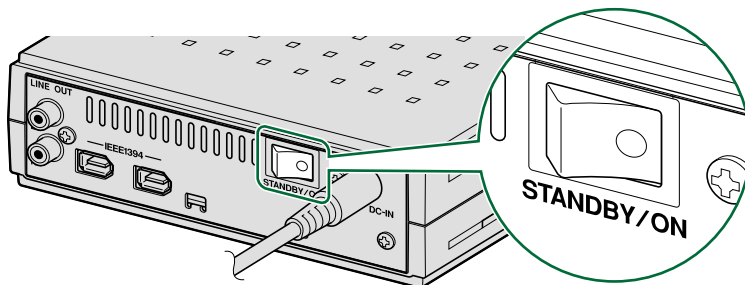

When the power of the **CRW2200IX** drive is turned on, the power LED on the front panel lights up in green.

Power LED

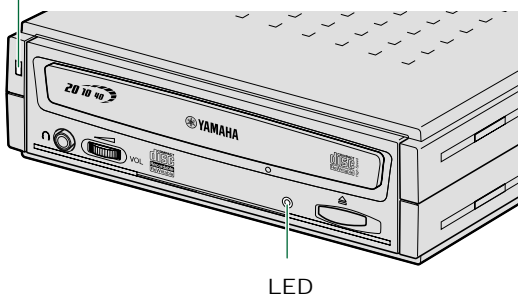

Note

When you turn on the **CRW2200IX** drive, make sure the LED on the front panel blinks in green, which indicates that it is reading disc information. (→P. 33)

- 6 Connect either IEEE1394 port on the drive's rear panel to an IEEE1394 (FireWire or i.LINK) port on the computer using the included IEEE1394 interface cable (with a 6-pin connector at each end).

Connection to a PC desktop or tower type computer

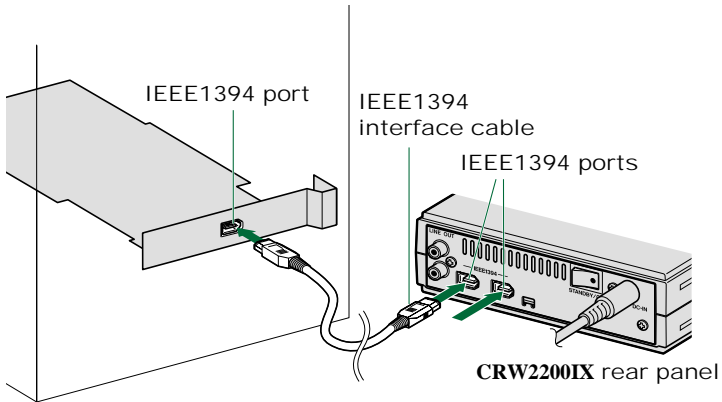

Connection to a PC notebook computer via CardBus card

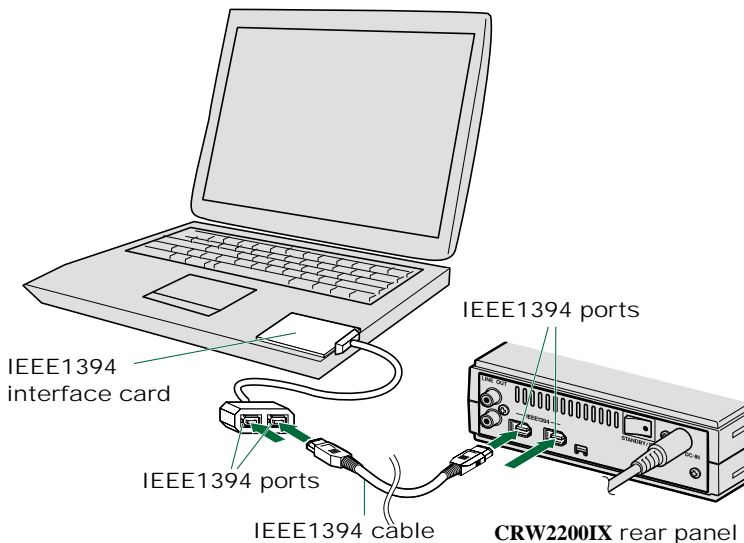

Connection to a Macintosh computer

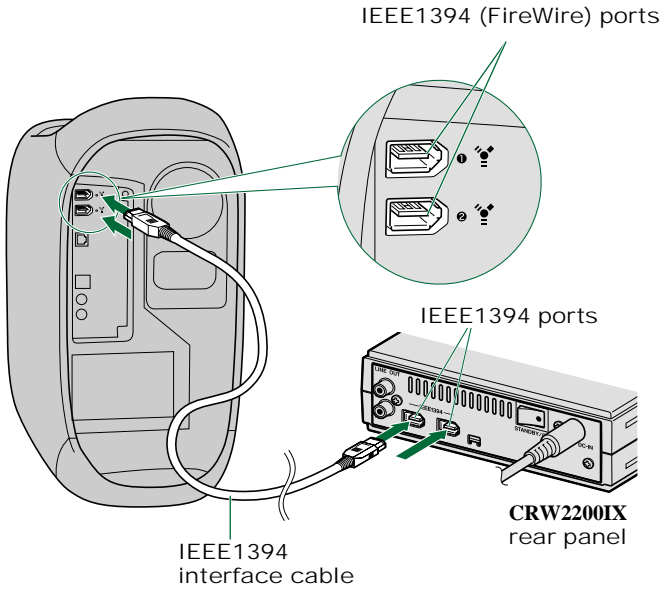

Notes

- You can connect the interface cable to either IEEE1394 port on the **CRW2200IX** drive.
- The IEEE1394 standard defines the maximum cable length of a single interface cable as 4.5 meters. Bear this in mind if using an interface cable longer than the included one.

If your computer has a 4-pin IEEE1394 port connector (especially common on notebook computers), use a cable with a 6-pin connector on one end and a 4-pin connector on the other.

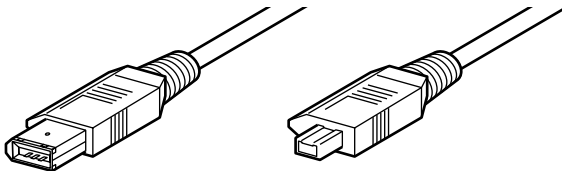

6-pin IEEE1394 connector

4-pin IEEE1394 connector

Configuring for the Operating System

After connecting the **CRW2200IX** drive to the computer (or an IEEE daisy-chain or tree), you can verify that the drive is correctly recognized by your computer.

Windows Users

For Windows 98 Second Edition/Me

Open “Control Panel” and double-click on the “System” icon. Select the “Device Manager” tab. If you can find a new CD drive icon (**YAMAHA CRW2200E**), an IEEE1394 bus controller icon, and an SBP2 icon as shown below, you have successfully installed both the drive and the IEEE1394 interface card as Windows OS recognizes both devices.

If the devices are not recognized, read the instructions on P. 13 - P. 17 carefully and repeat the setup procedures.

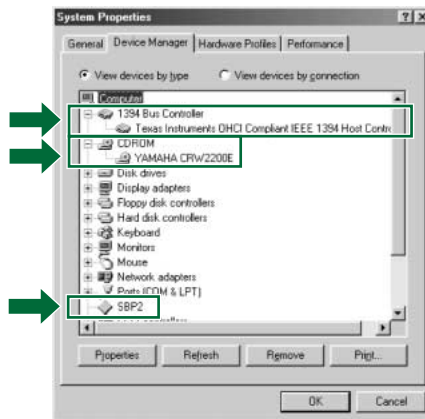

** This is a screen shown in the Windows Me environment.*

For Windows 2000 Professional

You can verify by opening “Control Panel,” double-clicking on “System,” selecting the “Hardware” tab, and clicking on the “Device Manager” button in “System Properties.”

Notes

- For details about how to use the operating system, refer to the documentation that came with it.
- If there is an **X** or **!** mark, etc., next to the icon for the **CRW2200IX** drive or the IEEE1394 bus controller, this means that it has not been installed correctly. In either case, the **CRW2200IX** drive may not work properly.

Macintosh Users

- 1 Select “Apple System Profiler” from the Apple menu.
- 2 In the Apple System Profiler window, click the “Devices and Volumes” tab.

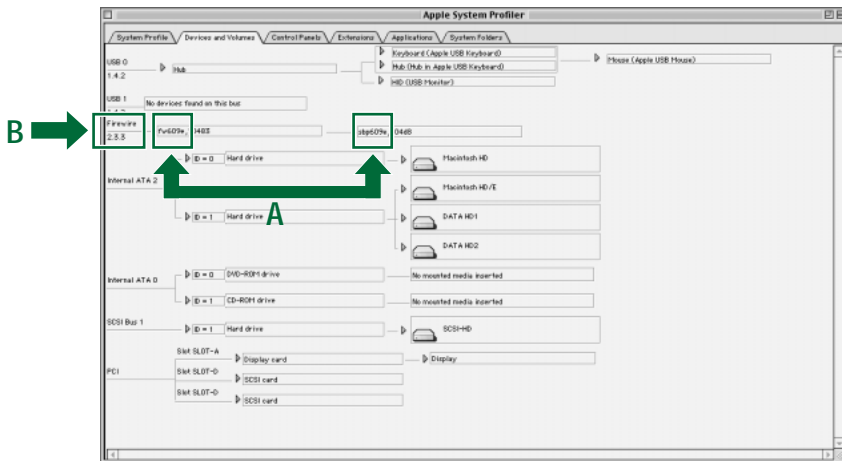

- A:** Make sure that “fw609e” and “sbp609e” are displayed in the FireWire column, showing that it is recognized by the Mac OS.
- B:** You can also check the FireWire version in this window.

Notes

- If you connect one or more storage devices other than the **CRW2200IX** drive, with the FireWire interface, “fw609e” and “sbp609e” are displayed in this window. To make sure that the **CRW2200IX** drive is recognized, drag and drop other FireWire interface device’s icons onto Trash to unmount, and disconnect those devices temporarily.
- If “FireWire” is not displayed in this window, FireWire interface devices are not recognized on the OS. Contact the supplier of your Apple Product.
- When “FireWire” is displayed in this window, if “fw609e” and “sbp609e” are not displayed, the **CRW2200IX** drive is not recognized. Consult your nearest Yamaha dealer for repair.
- The FireWire version that supports the **CRW2200IX** drive is 2.0 or later.
- If the Apple System Profiler recognizes the **CRW2200IX** drive, but extension files supporting the drive are not installed, the disc cannot be mounted or read. Extension files are included in the CD writing software. For details, refer to the documentation that came with your CD writing software.

Your CD writing software will show a device name, YAMAHA **CRW2200E**, which corresponds to the **CRW2200IX** drive (product name). For information on how to verify the **CRW2200IX** drive installation in your CD writing software, refer to the documentation that came with it.



Connecting and Disconnecting IEEE1394 Devices

Connecting Devices

Your IEEE1394 devices (including the **CRW2200IX** drive) are supposed to be connected/disconnected in an IEEE1394 daisy chain or tree connection while the host computer is turned on (Hot Swap).

Note

For more information about a IEEE1394 chain or tree connection, refer to page 28, 29.

Disconnecting Devices

When you attempt to disconnect an IEEE1394 device while the computer is turned on:

- Computers running under Windows 98 Second Edition will crash. To solve this problem, refer to the “Update Information” document bundled with the product.
- Computers running under Windows Me or Windows 2000 Professional allow for disconnection after you complete the “unplugging” procedure properly.
- Macintosh computers may show an alert message and allow for disconnection after you properly close the CD writing software and unmount the CD volume from the desktop.

Note

For more information about disconnecting IEEE1394 devices while the computer is turned on, refer to the documentation that came with your operating system.

You can load and eject a disc (as described below) only when the **CRW2200IX** drive is turned on.

Loading a Disc

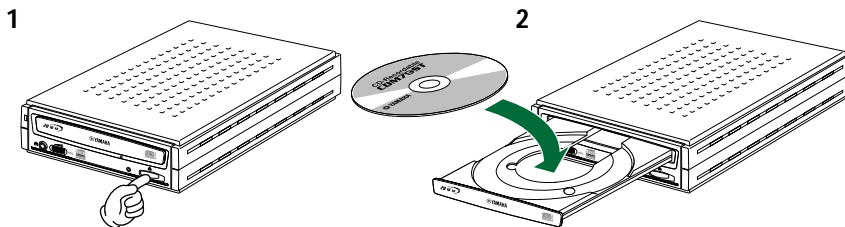

- 1** Open the disc tray by pressing the eject button on the CRW2200IX drive's front panel.
- 2** Place the disc onto the disc tray with its label or printing facing upward.
- 3** Close the disc tray by pressing the eject button again. You can also gently push it closed.



Load or unload the disc after the disc tray has fully opened. Do not push or pull the disc tray using excessive force. Doing so can damage the drive or the disc.

Ejecting a Disc

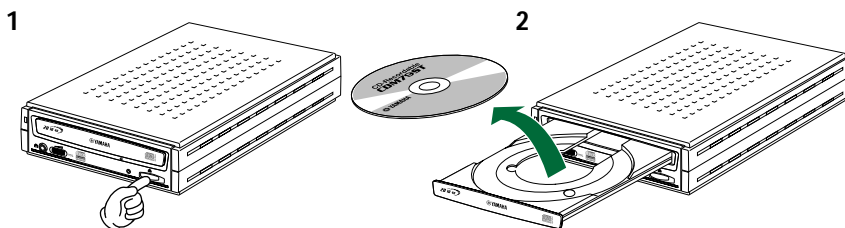

- 1** Open the disc tray by pressing the eject button on the CRW2200IX drive's front panel.
- 2** Remove the disc from the disc tray.
- 3** Close the disc tray by pressing the eject button again. You can also gently push it closed.

Notes

- It may not be possible to open the disc tray while a disc is being read or written.
- Remove the disc only after the disc tray has opened fully. Otherwise, you risk damaging the drive or the disc.

Ejecting a Disc in an Emergency

If the disc tray fails to open for some reason, such as a malfunction of the internal spring-loaded mechanism or power outage, it can be opened manually.

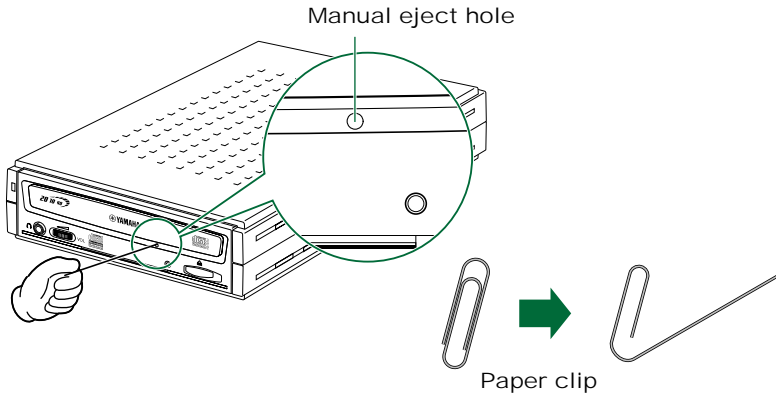

You should attempt to eject a disc manually only as a last resort. Malfunctions may occur if you do this too frequently.

- 1 Shut down the computer and the CRW2200IX drive.**
- 2 Find a pin-like tool with a diameter of 2 mm or less to fit through the manual eject hole on the drive's front panel.**

Note

A straightened large paper clip is ideal for this purpose.

- 3 Push the tool gently into the manual eject hole until the spring-loaded mechanism ejects the disc tray and disc.**
- 4 Turn on the CRW2200IX drive to close the disc tray.**

Troubleshooting

Please refer also to the YAMAHA CD-R/RW Drive web site for more information.

YAMAHA CD-R/RW Drive web site

URL: <http://www.yamaha.co.jp/english/product/computer/>

Europe

URL: <http://www.yamaha-it.de/>

The drive does not turn on.

- Are the AC adapter and the power cable connected correctly?
Make sure that the **CRW2200IX** drive is properly connected to the AC outlet using the included AC adapter and power cable. (→P. 13, 14)
- Make sure that the rear panel power switch is set to “ON.” As long as the LED on the front panel lights up or blinks in green or orange, the drive is successfully turned on. The problem may not be with the hardware (→P. 25). If the LED doesn't light up or blink, consult your nearest Yamaha dealer for repair.

The computer does not start up.

- Is the IEEE1394 interface card installed correctly?
Refer to the documentation that came with the card for details.

The CRW2200IX drive is not recognized by the operating system.

- Is the drive properly connected to the computer using a verified good IEEE1394 interface cable?
Make sure the interface cable is fully connected at both ends. (→P. 16, 17)
- Does the IEEE1394 interface (bus interface) appear in the operating system's information window?
Make sure that the IEEE1394 interface is recognized by the operating system. (→P. 18, 19)

If not, refer to the documentation that came with the IEEE1394 interface card or read the documentation that came with your computer for a built-in type IEEE1394 interface. Consult the manufacturer of your (add-on or built-in) IEEE1394 interface for possible solutions.

If the operating system recognizes the IEEE1394 interface, but the **CRW2200IX** drive is not recognized, consult your nearest Yamaha dealer for repair.

The disc tray does not open.

- Is the **CRW2200IX** drive turned on?
The power LED on the front panel of the **CRW2200IX** drive should light up when power is turned on.
- Are you using CD writing software?
If so, your CD writing software may lock the tray once the disc is loaded. If this is the case, try using the eject command from within the software. For more information, refer to the documentation that came with it. First close the software, and then try ejecting the disc.
- For Macintosh users
When the disc's icon is displayed on the screen after a disc is loaded, the eject button cannot be used.
To open the disc tray, drag the disc's icon into the Trash and drop it there to unmount the disc.
- Can you open the disc tray after attempting to restart the computer?
Close all application programs, restart the computer, and press the eject button on the drive's front panel.
- Disconnect the IEEE1394 cable from the **CRW2200IX** drive but leave the AC adapter connected, and press the eject button.
- Manually open the disc tray as a last resort. (→P. 22)
If this trouble occurs frequently, the drive's spring-loaded mechanism may be damaged. Consult your nearest Yamaha dealer for repair.

The disc keeps being ejected.

- Has the disc been placed on the disc tray correctly?
If not, place the disc properly and close the disc tray.
- Has dust or dirt collected on the disc surface?
If so, clean the disc surface using an air spray or by wiping using a lint-free cloth. Remember to wipe the surface from the center of the disc to the edge.
Be careful not to scratch it.
- Does the drive accept other discs (audio CD, CD-ROM, blank CD-R disc, etc.)?
If the drive does not accept a specific disc, the disc itself must be the problem. Check for scratches, warping, or other reasons. If the drive does not accept any disc, consult your nearest Yamaha dealer for repair.

The disc is not loaded.

- Does the drive automatically open the disc tray to eject the disc?
If so, go to the previous symptom, “The disc keeps being ejected.” (→P. 24)
- Are you attempting to load a disc supported by the drive?
Make sure that the disc is supported by the drive. (→P. 34)
- Has dust or dirt collected on the disc surface?
If so, clean the disc surface using an air spray or by wiping using a lint-free cloth.
Remember to wipe the surface from the center of the disc to the edge.
Be careful not to scratch it.
- Does the drive accept other discs (audio CD, CD-ROM, etc.)?
If the drive does not accept a specific disc, the disc itself must be the problem.
Check for scratches, warping, or other reasons. The drive may also fail to load even a supported disc if the disc is written improperly. However, blank discs cannot be played.
- For Macintosh users
If extension files supporting the drive are not installed, the disc cannot be mounted or read.
Extension files are included in the CD writing software.
For details, refer to the documentation that came with your CD writing software.
- Does the LED light properly when the disc is loaded?
The LED should flash green for a moment after the disc is loaded. It will change to a steady green when the disc is properly recognized. (→P. 33)

If the LED activity is normal and the drive does not accept a specific disc, the disc itself must be the problem. Check for scratches, warping, or other reasons.

If you load several types of disc and the LED on the front panel remains orange (indicating that the disc is not recognized), consult your nearest Yamaha dealer for repair.

The drive ejects or fails to read the disc, or the LED on the front panel remains lit in orange after the disc has been loaded (meaning that the disc has not been recognized). (→P. 33)

- Disconnect the IEEE1394 interface cable from your drive but leave the AC adapter connected. Now try loading the disc. If a specific disc is automatically ejected or not loaded, that disc has a problem. If the drive does not accept any supported discs (and the LED remains orange), consult your nearest Yamaha dealer for repair.

No sound of CD-DA (audio CD) disc is audible.

- Check that the LINE OUT jacks (L/R) of the **CRW2200IX** drive is connected correctly to the sound card or powered speakers. (→P. 10)
- For users with Windows Me, no sound is audible from headphones connected to the headphone jack of the **CRW2200IX** drive or from powered speakers connected to the LINE OUT jacks (L/R) on the rear panel of the **CRW2200IX** drive.

Make sure settings are as shown below.

(When you are using Windows Media Player 7.0 with Windows Me, the above symptom is known to exist because the default setting is set to ON for “Digital playback.”)

1 The “Properties” setting of the CRW2200IX drive.

- ① Open the “YAMAHA CRW2200E Properties” window and click on the “Properties” tab.
- ② Uncheck the “Enable digital CD audio for this CD-ROM device.” check box.

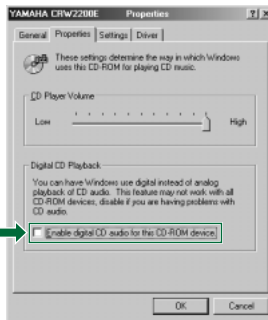

2 The setting of the Windows Media Player.

- ① Start “Windows Media Player.”
- ② Click “Tools” on the Menu and click on “Options” to open the “Options” window, then click on the “CD Audio” tab.
- ③ Uncheck the “Digital playback” check box.

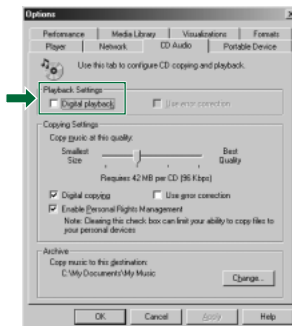

The “Buffer Underrun” error message is displayed.

- If your CD writing software supports the Buffer Underrun Protection, you must activate the Buffer Underrun Protection. For more details, refer to the documentation that came with your CD writing software.
- For more effective writing, and to avoid causing “Buffer Underrun,” try the following:
 - Lower the writing speed setting.
 - Create an image file of the CD on the computer’s hard disk.
 - Optimize the hard drive (Defragment the drive).
 - When writing, close other applications (including screen savers, etc.).
 - Turn hard disk power management off.
 - Select “Sync data transfer” for the transfer mode setting of the SCSI devices, such as a hard drive, or a CD-ROM drive, etc.
For IDE devices, select “DMA” for the setting of transfer mode.
 - Deactivate the Active Desktop (if you are using Internet Explorer 4 or later).
 - Close residential software.
 - Make sure the trouble does not stem from your CD writing software by referring to the documentation that came with it.

Notes

- If there is a slower device connected between the host computer and **CRW2200IX** drive, the data transfer between **CRW2200IX** drive and the host computer will be slowed, which may cause a failure in writing a CD.
- Errors can occur if you knock or move the **CRW2200IX** drive while it is writing to disc.

Unstable operations.

- Do you have several kinds of CD writing software installed to the same system? Such a situation may cause a conflict, resulting in unstable operations.
- Has dust or dirt collected on the disc surface?
If so, clean the disc surface using an air spray or by wiping using a lint-free cloth. Remember to wipe the surface in a motion perpendicular to the edge of the disc. Be careful not to scratch it.

Other symptoms

Your CD writing software does not recognize the **CRW2200IX** drive.

- That software you are using may not support the drive. Consult the software manufacturer for compatibility with the **CRW2200IX** drive.

Connecting Multiple IEEE1394 Peripherals Together

The way of connecting multiple devices including the **CRW2200IX** drive to the host computer is shown below.

Connecting in a daisy-chain

A daisy-chain connection strings several IEEE1394 devices in line to one IEEE1394 connector on the host computer.

Up to 16 IEEE1394 devices can be attached.

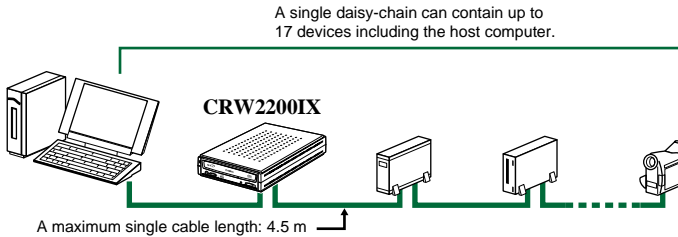

Connecting in a tree

Some host computer provides two or more IEEE1394 connectors, each IEEE1394 connector allows for the connection of multiple IEEE1394 devices.

A total of 62 IEEE1394 devices can be attached.

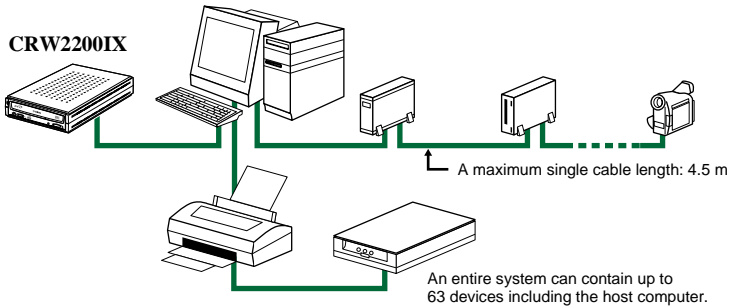

Notes on Connecting IEEE1394 Devices

Remember the following notes when connecting the **CRW2200IX** drive to the host computer along with other IEEE1394 devices.

- For optimum performance when writing a CD, connect the **CRW2200IX** drive directly or solely to the host computer.
- Do not connect or disconnect any IEEE1394 devices while the **CRW2200IX** drive is in operation (especially when writing to a disc).
- If there is a slower device connected between the host computer and the **CRW2200IX** drive, the data transfer between the **CRW2200IX** drive and the host computer will be slowed, which may cause a failure in writing a CD.
- The IEEE1394 ports on the **CRW2200IX** drive have 6-pin connectors, but do not supply power (IEEE1394 bus power).
- Do not turn off the **CRW2200IX** drive while its IEEE1394-connected computer is turned on. Otherwise, it may cause malfunctions on your computer or other IEEE1394 devices connected together, depending on the specifications of the IEEE1394 interface card (host adapter) or the writing software you are using on the computer.
- Avoid creating a looped connection that sends data output from a device back to the same device. The illustration below shows an example of such a loop (at the host computer).

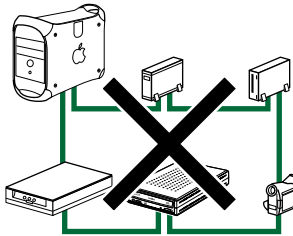

Writing Modes

Disc-at-Once (DAO)

This mode is used when writing a complete disc in a single pass without pausing. Data cannot be added later, even if the full capacity of the blank disc has not been used.

Example: General CD-ROM

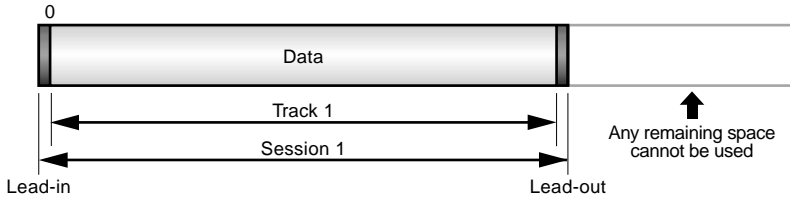

Example: Audio CD

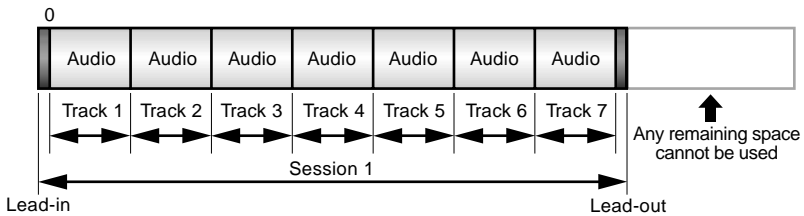

Note

The lead-in and lead-out areas signify the beginning and end points of a session. They are not part of the data but contain information about the session itself. Basically, a session consists of a lead-in, data, and a lead-out.

Track-at-Once (TAO)

This mode is used when writing data to a disc one track at a time. More tracks can be added later if there is enough space left on the disc. This is why Track-at-Once mode is sometimes referred to as Multisession.

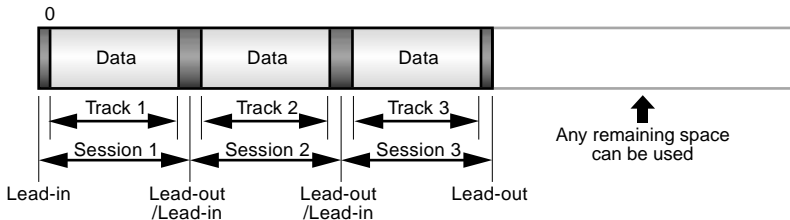

Note

Only the first session of a multisession disc can be played back on a conventional audio CD player. Single session discs can be played back completely.

Session-at-Once (SAO)

As a writing method that combines the advantages of the above-mentioned “Disc-at-Once” and “Track-at-Once,” you can combine multiple tracks into one session and write them, and then add additional data.

For example, this is the writing method used to create a CD EXTRA format CD. The music tracks will be recorded in the first session, and the data will be recorded in the second session.

Example: CD EXTRA

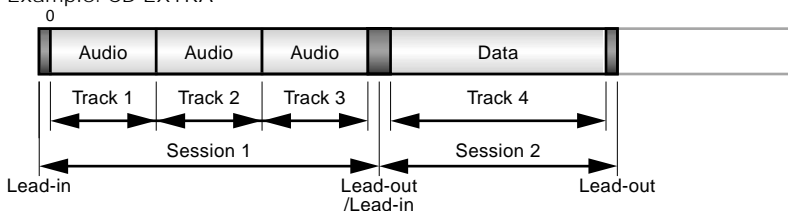

Packet Writing

This mode is used when writing to a track of a disc using small blocks of data called “packets,” in a manner similar to a floppy disk. This mode is useful when making small incremental backups of data. You will need to use software that specifically supports packet writing.

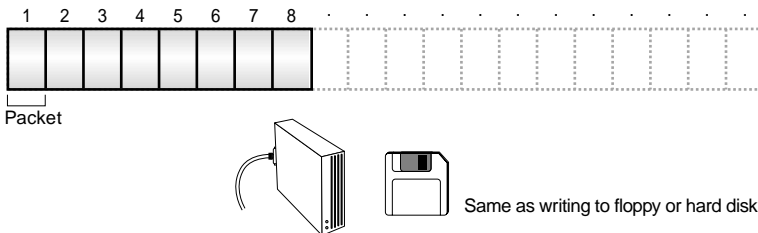

Notes on Packet Writing

- Discs must be formatted before they can be used for packet writing. With CD-RW, erased data can be overwritten until the disc is completely full.
- When using packet writing on a CD-RW disc, the actual data capacity is 100 MB less than that stated on the cover of the disc. The difference in capacity is dependent on the writing mode.
- With CD-R, the space used by the erased data cannot be reused and is “masked” so that it is no longer visible. This can be done up to 100 times.

About the Firmware

The firmware is a small piece of software built into the **CRW2200IX** drive, and is used to operate the drive. Since it resides in flash memory, it can be overwritten and updated. To ensure more reliable operations and enhanced performance of the drive, updates to the firmware will be made available. You can find information about the most recent firmware for the drive on the YAMAHA CD-R/RW Drive web site.

YAMAHA CD-R/RW Drive web site

URL: <http://www.yamaha.co.jp/english/product/computer/>

Europe

URL: <http://www.yamaha-it.de/>

The most recent user support information, including firmware updates, can be found in the YAMAHA CD-R/RW Drive web site. Please check this information regularly.

Determining the Firmware Version of the CRW2200IX drive

For Windows 98 Second Edition/Me

Go to **Control Panel | System | Device Manager** tab, double-click on “**CDROM**”, then double-click on “**YAMAHA CRW2200E**”.

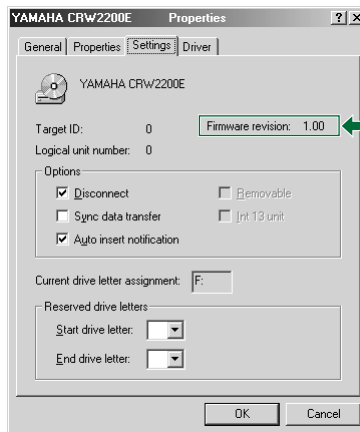

The firmware revision indicated here varies depending on the software version of the drive.

**This is a screen shown in the Windows Me environment.*

For Windows 2000 Professional

If you open the “Device Manager” window, the firmware version will not be displayed. Use your CD writing software to check the firmware version.

For Macintosh

Use your CD writing software to check the firmware version of the **CRW2200IX** drive. For details on how to use the software, refer to the documentation that came with it.

LED Indicator Messages

The following table shows the various LED signals and meanings when the CRW2200IX drive is turned on.

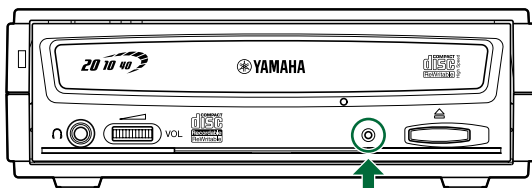

| Status | Indicator Messages | LED Color |
|--|--------------------------|-----------|
| Ready (with disc) | Lit | Green |
| Ready (no disc) | Lit | Orange |
| Tray operation (opening/closing) | Blinking (constant) | Green |
| Tray fully opened | Out | — |
| Reading disc information (TOC) | Blinking (constant) | Green |
| Initial access in writing | Blinking (constant) | Orange |
| Writing (test mode) | Blinking (constant) | Orange |
| Writing | Blinking fast (constant) | Orange |
| Reading | Flashing (inconstant) | Green |
| Playing | Blinking fast (constant) | Green |
| Power saving (combined with the computer's power saving) | Out | — |
| Failure | Flashing (inconstant) | Orange |

CRW2200IX Specifications

Supported Formats

| | Write | Read | Play |
|-------------------------------------|------------|--------|--------|
| CD-DA | ● | ● | ● (*4) |
| CD TEXT | ● | ● | ● |
| CD-ROM (*1) | ● | ● | ● |
| Mixed Mode CD-ROM (CD-ROM+CD-DA) | ● | ● | ● (*4) |
| CD-ROM XA (*1) | ● | ● | ● (*4) |
| Photo CD (*1) | ● (*2)(*3) | ● | ● (*4) |
| Video CD | ● | ● | ● (*4) |
| CD-i | ● | ● (*3) | |
| CD EXTRA (*1) | ● | ● | ● (*4) |

*1: includes multisession

*2: suitable disc required

*3: suitable application
software required*4: suitable application software
required for playback

Note

Excludes ADPCM Encode/Decode & Video Encode/Decode functions.

CRW2200IX

Writing Methods

Disc-at-Once (DAO)
Session-at-Once (SAO)
Track-at-Once (TAO)
Packet Writing

Writing/Reading Speed

| | | |
|---------|--|---|
| Writing | CD-R | 1X, 2X, 4X, 8X, 12X (CLV), 16X (12X – 16X Partial CAV), 20X (12X – 20X Partial CAV) |
| | CD-RW | 2X, 4X, 8X, 10X (CLV) 4X – 10X Full CAV |
| Reading | 40X (max.) Full CAV | Note) • DATA: 40X (max.) • CD-DA: 40X (max.) in audio extraction • CD-DA: 1X only in audio play • Video CD: 10X (max.) • Session closed disc: 40X (max.) • Session unclosed disc: 12X (max.) |
| CD-R | 1X, 2X, 4X, 8X, 12X, 16X (12X – 16X Partial CAV), 20X (12X – 20X Partial CAV) writing: | CD-R discs specified in Orange Book Part II Ver. 3.1. Note) For 8X or faster writing, use CD-R discs matched their respective writing speeds. |
| CD-RW | • 2X writing/rewriting: Rewritable discs specified in Orange Book Part III Volume 1 Version 1.0. • 2X or 4X writing/rewriting: Rewritable discs specified in Orange Book Part III Volume 1 Version 2.0. • 4X, 8X, 10X (CLV), 4X – 10X Full CAV writing/rewriting: Rewritable discs specified in Orange Book Part III Volume 2 Version 1.0. | |

Appendix

| | |
|-------------------------------------|---|
| Data Capacity | 700 MB (79 min.) 650 MB (74 min.) 550 MB (63 min.) |
| Data Transfer Rate (Mode 1) | 1X: 150 KB/sec. 16X: 2,400 KB/sec. 2X: 300 KB/sec. 20X: 3,000 KB/sec. 4X: 600 KB/sec. 24X: 3,600 KB/sec. 8X: 1,200 KB/sec. 32X: 4,800 KB/sec. 10X: 1,500 KB/sec. 40X: 6,000 KB/sec. 12X: 1,800 KB/sec. |
| Interface | IEEE1394-a compliant, 400 Mbps Two 6-pin connectors (power not supplied to connectors [ports]) |
| Data Buffer Size | 8 MB (3,224 sectors) |
| Average Random Access Time | 150 msec. (reading) |
| Sector Size | 2,048 – 2,352 bytes |
| Installing style | Horizontal |
| Disc Loading Type | Front auto-loading tray loading |
| Audio Out | Line Out Frequency range: 20 – 20,000 Hz Output level: 700 mVrms |
| Power Consumption | SKB2505A (100 – 120 V AC) : • 20 W (when writing or reading) • 10 W (standby) SMB2505A (220 – 240 V AC) : • 18 W (when writing or reading) • 9 W (standby) |
| Operating Environment | Temperature 5 – 35 °C Humidity 25 – 80% RH (no condensation) |
| Dimensions (includes projection) | Width: 164.0 mm Height: 56.0 mm Depth: 266.2 mm |
| Weight | 1.5 kg |

AC adapter

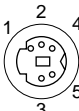
| | |
|--------------------------------------|---|
| Rated Input Voltage | SKB2505A : 100 – 120 V AC \pm 10% SMB2505A : 220 – 240 V AC \pm 10% |
| Rated Input Current | SKB2505A : 0.64 A (100 – 120 V AC) SMB2505A : 0.4 A (220 – 240 V AC) |
| Rated Output Voltage | +5 V, +12 V DC |
| Rated Output Current | 1.5 A |
| Terminal Output Polarity |  <p>1 : +12 V DC 2 : GND 3 : +5 V DC 4 : GND 5 : +5 V DC</p> |
| Operating Environment | Temperature 0 – 40 °C Humidity 20 – 90% RH (no condensation) |
| Dimensions (includes projection) | Width: 63.0 mm Height: 31.5 mm Depth: 112.0 mm |
| Weight (includes the power cable) | SKB2505A : 400 g (approx.) SMB2505A : 350 g (approx.) |

The CRW2200IX series complies with the following specifications

| Country / Region | Compliance Specifications | | | Details |
|--------------------------|---------------------------|------------|--|--|
| | Category | Item | Standards | |
| USA | Safety | Electrical | UL60950 | Information Technology Equipment |
| | | Laser | 21CFR1040.10 FDA Chapter 1, Subchapter J | Class 1 Laser Product |
| | EMC | Emission | 47CFR15 FCC Part 15, Subpart B | Class B Computing Device |
| Canada | Safety | Electrical | CSA C22.2 No. 60950 | Information Technology Equipment |
| | EMC | Emission | ICES-003 | Class B Computing Device |
| EU | Safety | Electrical | EN60950 | Information Technology Equipment |
| | | Laser | EN60825 | Class 1 Laser Product |
| | EMC | Emission | EN55022 | Class B Information Technology Equipment |
| | | Immunity | EN55024 EN61000-3-2 EN61000-3-3 | Information Technology Equipment |
| Australia New Zealand | EMC | Emission | AS/NZ 3548 | Class B Equipment |
| Taiwan | EMC | Emission | CNS13438 Class B | Class B Equipment |
| Japan | EMC | Emission | VCCI | Class B Equipment |

Index

Symbols

- 1394 bus controller 18
- 4-pin IEEE1394 connector..... 17
- 6-pin IEEE1394 connector..... 17

A

- AC adapter 14
- Apple System Profiler..... 19
- Audio CD 30

B

- Buffer Underrun 3
- Buffer Underrun Error 3
- Buffer Underrun Protection 1, 3

C

- CAV 7
- CD EXTRA..... 31
- CD TEXT 2
- CD Writing Software 5
- CD-DA 7
- CD-R discs 6
- CD-ROM..... 7, 30
- CD-RW discs 6
- CLV 7
- Configuring for the Operating System
..... 18
- Connecting Devices 20
- Connecting Multiple IEEE1394
Peripherals Together 28
- Control Panel 18

D

- Daisy-chain 28
- Data CD 7
- DC-IN connector..... 10, 13
- Device Manager 18
- Disc tray 9, 21
- Disc-at-Once (DAO)..... 30
- Disconnecting Devices..... 20
- Disk image files 5

E

- Eject button 9, 21
- Ejecting a Disc 21
- Ejecting a Disc in an Emergency 22
- Extraction of digital audio data..... 2

F

- FireWire 2, 17
- Firmware 32
- Front Panel 9
- Full CAV 8

H

- Hard Drive Space 5
- Headphone jack..... 9
- Headphone volume control 9
- High Speed CD-RW discs..... 6
- Hot Swap..... 20

I

- i.LINK 2
- IEEE1394 2
- IEEE1394 interface cable..... 16, 17
- IEEE1394 interface card 4
- IEEE1394 ports 10, 16, 17

J

- Jitter value 1

L

- Lead-in 30
- Lead-out 30
- LED 9, 15, 33
- LINE OUT jacks (L/R) 10
- Loading a Disc 21

M

- Manual eject hole 9, 22
- Multisession 30

O

- Optimum Write Speed Control 1
- Orange Book 7

P

| | |
|-------------------------------|------------|
| Packet | 31 |
| Packet Writing | 31 |
| Paper clip | 22 |
| Partial CAV | 7 |
| Power cable | 14 |
| Power LED | 9, 15 |
| Power switch | 10, 13, 15 |
| Pure-Phase Laser System | 1 |

R

| | |
|-------------------|----|
| Rear Panel | 10 |
| Running OPC | 1 |

S

| | |
|-----------------------------|----|
| SafeBurn™ | 1 |
| Serial Number | 8 |
| Session | 30 |
| Session-at-Once (SAO) | 31 |
| Single session | 30 |
| Supported Discs | 6 |
| Supported Formats | 34 |
| System Requirements | 4 |

T

| | |
|---------------------------|----|
| Test-writing | 3 |
| Track | 30 |
| Track-at-Once (TAO) | 30 |

V

| | |
|----------------|---|
| Video CD | 7 |
|----------------|---|

W

| | |
|---------------------|----|
| Writing Modes | 30 |
|---------------------|----|

Y

| | |
|--|--------------|
| YAMAHA CD-R/RW Drive web site | 5, 6, 23, 32 |
|--|--------------|

Distributors and Head Offices / Vertriebs- und Hauptgeschäftsstelle Distributeurs et sièges sociaux / Distribuidores y Casas matrices

If you have any questions, please contact your dealer or one of the following companies.

Bei weiteren Fragen wenden Sie sich bitte an Ihren Händler oder eine der folgenden Firmen.

Pour plus de détails sur les produits, veuillez vous adresser à Yamaha ou au distributeur le plus proche figurant dans la liste suivante :

Si tiene alguna pregunta, por favor póngase en contacto con su distribuidor o una de las siguientes empresas:

EUROPE, EASTERN EUROPE and RUSSIA

**Yamaha Elektronik Europa GmbH
IT-Sales Division**
Siemensstrasse 22-34,
D-25462 Rellingen, GERMANY
URL: <http://www.yamaha-it.de/>

TEL: +80092624222
(AUSTRIA, BELGIUM, DENMARK, FINLAND,
FRANCE, GERMANY, HUNGARY, ICELAND,
IRELAND, ITALY, LUXEMBOURG,
NETHERLANDS, NORWAY, PORTUGAL,
SPAIN, SWEDEN, SWITZERLAND, UNITED
KINGDOM)

TEL: +80093067
(MONACO)

If you are calling from outside the countries mentioned
above, or if you can't get through on the Yamaha toll-
free number, use the following number instead:

TEL: +3214400793

U.S.A.

Yamaha Electronics Corporation, USA
6660 Orangethorpe Avenue,
Buena Park, CA 90620, U.S.A.
TEL: +1 714 522 9105
FAX: +1 714 670 0108
URL: <http://www.yamaha.com/>

CANADA

Yamaha Canada Music Ltd.
135 Milner Avenue, Scarborough,
Ontario M1S 3R1, CANADA
TEL: +1 416 298 5664
FAX: +1 416 292 0732
URL: <http://www.yamaha.ca/>

AUSTRALIA

Yamaha Music Australia Pty., Ltd.
Level 1, 99 Queensbridge Street
Southbank, Victoria 3006
AUSTRALIA
TEL: +61 3 9693 5111
FAX: +61 3 9699 2332

SINGAPORE, MALAYSIA, THAILAND, PHILIPPINES, INDIA, VIETNAM, CAMBODIA, MYANMAR, INDONESIA and IRAN

Yamaha Electronics Asia Pte Ltd.
138 Cecil Street
#05-02/03 Cecil Court, Singapore 069538
SINGAPORE
TEL: +65 223 3992
FAX: +65 223 9810

TAIWAN

Yamaha KHS Music Co., Ltd.
11F, No.150, Tun Hua North Rd.
Taipei, TAIWAN R.O.C.
TEL: +886 2 2713 8999
FAX: +886 2 2713 8666
URL: <http://www.yamahakhs.com/>

JAPAN

**Yamaha Corporation
AV & IT Business Group
IT Sales & Marketing Division**
203 Matsunokijima, Toyooka-mura, Iwata-gun,
Shizuoka-ken 438-0192, JAPAN
TEL: +81 539 62 6558
FAX: +81 539 62 5346
URL: <http://www.yamaha.co.jp/english/>



COMPACT
disc
Recordable
ReWritable

COMPACT
disc
ReWritable
High Speed

YAMAHA CORPORATION
X0408A0 CRW2200 IX(W)
Printed in Malaysia