

SPC-57

**5.7" STN LCD Smart Panel
Computer with Intel^R Xscale^R CPU
and Windows^R CE.NET**

Users Manual

Copyright

This document is copyrighted, © 2004. All rights are reserved. The original manufacturer reserves the right to make improvements to the products described in this manual at any time without notice.

No part of this manual may be reproduced, copied, translated or transmitted in any form or by any means without the prior written permission of the original manufacturer. Information provided in this manual is intended to be accurate and reliable. However, the original manufacturer assumes no responsibility for its use, nor for any infringements upon the rights of third parties that may result from such use.

Acknowledgements

IBM, PC/AT, PS/2 and VGA are trademarks of International Business Machines Corporation.

Intel[®] is trademark of Intel Corporation.

Microsoft[®] Windows[®] CE.NET is a registered trademark of Microsoft Corp.

All other product names or trademarks are properties of their respective owners.

For more information on this and other Advantech products, please visit our websites at:

<http://www.advantech.com>

For technical support and service, please visit our support website at:

<http://eservice.advantech.com.tw/eservice/>

This manual is for the SPC-57 series products.

FCC Class A

This equipment has been tested and found to comply with the limits for a Class A digital device, pursuant to Part 15 of the FCC Rules. These limits are designed to provide reasonable protection against harmful interference when the equipment is operated in a residential environment. This equipment generates, uses, and can radiate radio frequency energy. If not installed and used in accordance with this user's manual, it may cause harmful interference to radio communications. Note that even when this equipment is installed and used in accordance with this user's manual, there is still no guarantee that interference will not occur. If this equipment is believed to be causing harmful interference to radio or television reception, this can be determined by turning the equipment on and off. If interference is occurring, the user is encouraged to try to correct the interference by one or more of the following measures:

- Reorient or relocate the receiving antenna
- Increase the separation between the equipment and the receiver
- Connect the equipment to a power outlet on a circuit different from that to which the receiver is connected
- Consult the dealer or an experienced radio/TV technician for help

Warning! HIGH VOLTAGE!!!



Please do NOT touch the inverter between main board and LCD panel with your hands or any other electric conductors.

Warning! *Any changes or modifications made to the equipment which are not expressly approved by the relevant standards authority could void your authority to operate the equipment.*



Packing List

Before you begin to use SPC, please make sure that the following materials have been shipped.

- SPC-57 Smart Panel Computer
- Windows® CE.NET end user license agreement (for Windows® CE.NET version)
- Advantech Software Support CD (Windows® CE.NET)
 - Readme.txt
 - Datasheet
 - User manual
 - Windows® CE.NET 4.2 platforms SDK (for Windows® CE.NET)
 - Microsoft ActiveSync Version 3.7 install files (for Windows® CE.NET).
- Power connector
- Plastic Stylus for touch-screen
- 1 x USB client ActiveSync cable
- Warranty card
- 1 X 4P to 4P power cable (for SPC-57E only)

If any of these items are missing or damaged, contact your distributor or sales representative immediately.

Additional Information and Assistance

Step 1: Visit the Advantech web site at **www.advantech.com/risc** where you can find the latest information about the product.

Step 2: Contact your distributor, sales representative, or Advantech's customer service center for technical support if you need additional assistance. Please have the following information ready before you call:

- Product name and serial number
- Description of your peripheral attachments
- Description of your software (operating system, version, application software, etc.)
- A complete description of the problems
- The exact wording of any error messages

Safety Instructions

1. Read these safety instructions carefully.
2. Keep this User's Manual for later reference.
3. Disconnect this equipment from any AC outlet before cleaning. Use a damp cloth. Do not use liquid or spray detergents for cleaning.
4. For plug-in equipment, the power outlet socket must be located near the equipment and must be easily accessible.
5. Keep this equipment away from humidity.
6. Put this equipment on a reliable surface during installation. Dropping it or letting it fall may cause damage.
7. The openings on the enclosure are for air convection. Protect the equipment from overheating. **DO NOT COVER THE OPENINGS.**
8. Make sure the voltage of the power source is correct before connecting the equipment to the power outlet.
9. Position the power cord so that people cannot step on it. Do not place anything over the power cord.
10. All cautions and warnings on the equipment should be noted.
11. If the equipment is not used for a long time, disconnect it from the power source to avoid damage by transient over voltage.
12. Never pour any liquid into an opening. This may cause fire or electrical shock.
13. Never open the equipment. For safety reasons, the equipment should be opened only by qualified service personnel.
14. If one of the following situations arises, get the equipment checked by service personnel:
 - a. The power cord or plug is damaged.
 - b. Liquid has penetrated into the equipment.
 - c. The equipment has been exposed to moisture.
 - d. The equipment does not work well, or you cannot get it to work according to the user's manual.
 - e. The equipment has been dropped and damaged.
 - f. The equipment has obvious signs of breakage.
15. **DO NOT LEAVE THIS EQUIPMENT IN AN ENVIRONMENT WHERE THE STORAGE TEMPERATURE MAY GO BELOW -20° C (-4° F) OR ABOVE 60° C (140° F). THIS COULD DAMAGE THE EQUIPMENT. THE EQUIPMENT SHOULD BE IN A CONTROLLED ENVIRONMENT.**

The sound pressure level at the operator's position according to IEC 704-1:1982 is no more than 70dB (A).

DISCLAIMER: This set of instructions is given according to IEC 704-1. Advantech

disclaims all responsibility for the accuracy of any statements contained herein.

Wichtige Sicherheitshinweise

1. Bitte lesen sie Sich diese Hinweise sorgfältig durch.
2. Heben Sie diese Anleitung für den späteren Gebrauch auf.
3. Vor jedem Reinigen ist das Gerät vom Stromnetz zu trennen. Verwenden Sie Keine Flüssig-oder Aerosolreiniger. Am besten dient ein angefeuchtetes Tuch zur Reinigung.
4. Die Netzanschlussteckdose soll nahe dem Gerät angebracht und leicht zugänglich sein.
5. Das Gerät ist vor Feuchtigkeit zu schützen.
6. Bei der Aufstellung des Gerätes ist auf sicheren Stand zu achten. Ein Kippen oder Fallen könnte Verletzungen hervorrufen.
7. Die Belüftungsöffnungen dienen zur Luftzirkulation die das Gerät vor überhitzung schützt. Sorgen Sie dafür, daß diese Öffnungen nicht abgedeckt werden.
8. Beachten Sie beim. Anschluß an das Stromnetz die Anschlußwerte.
9. Verlegen Sie die Netzanschlusbleitung so, daß niemand darüber fallen kann. Es sollte auch nichts auf der Leitung abgestellt werden.
10. Alle Hinweise und Warnungen die sich am Geräten befinden sind zu beachten.
11. Wird das Gerät über einen längeren Zeitraum nicht benutzt, sollten Sie es vom Stromnetz trennen. Somit wird im Falle einer Überspannung eine Beschädigung vermieden.
12. Durch die Lüftungsöffnungen dürfen niemals Gegenstände oder Flüssigkeiten in das Gerät gelangen. Dies könnte einen Brand bzw. elektrischen Schlag auslösen.
13. Öffnen Sie niemals das Gerät. Das Gerät darf aus Gründen der elektrischen Sicherheit nur von autorisiertem Servicepersonal geöffnet werden.
14. Wenn folgende Situationen auftreten ist das Gerät vom Stromnetz zu trennen und von einer qualifizierten Servicestelle zu überprüfen:
 - a - Netzkabel oder Netzstecker sind beschädigt.
 - b - Flüssigkeit ist in das Gerät eingedrungen.
 - c - Das Gerät war Feuchtigkeit ausgesetzt.
 - d - Wenn das Gerät nicht der Bedienungsanleitung entsprechend funktioniert oder Sie mit Hilfe dieser Anleitung keine Verbesserung erzielen.
 - e - Das Gerät ist gefallen und/oder das Gehäuse ist beschädigt.
 - f - Wenn das Gerät deutliche Anzeichen eines Defektes aufweist.

Der arbeitsplatzbezogene Schalldruckpegel nach DIN 45 635 Teil 1000 beträgt 70 dB(A) oder weiger.

DISCLAIMER: This set of instructions is given according to IEC704-1.

Advantech disclaims all responsibility for the accuracy of any statements contained herein.

General Information

This chapter gives background

Information of the SPC-57

Sections include:

- Introduction
- Specification
- LCD Specification
- Touchscreen Specification
- Power
- I/O ports
- Mounting
- Dimension and cutout

1.1 Introduction

Intel® XScale®, Ultra Low Power, Embedded Applications Anywhere!!

Advantech smart panel computers enable great embedded flexibility when powered by Intel® XScale® technology. Built with an Intel PXA255 CPU, LCD display, touchscreen, and pre-installed with Microsoft® Windows CE .NET 4.2 and LAN, the SPC series provide the best cost-effective and stable solution to customers for a diverse range of embedded applications. The great features of SPC, ultra low power, compact size, IP65 front bezel, and fanless

Removable back cover: The back cover of the SPC series is easily removed to fit customer application needs. With the flexibility of a removable back cover, customers can better utilize the location and type of I/O by designing their own back for seamless integration.

Dust and spill resistant: IP65 rated front bezel for protection from dust and water damage.

Fanless and ultra low power consumption

Compact size

Rich connectivity for external accessories: GPS modules, wireless LAN modules, GPRS modules are verified to work well with the SPC series.

SM bus for battery power: SPC keep the SM bus interface inside, users can equip battery through SM bus to provide mobility on their own solution. The SM bus is made through I²C

Versatile I/O: RS-232, RS-485, USB host, LAN, PCMCIA slot, CF slot, audio jack, DIO, etc.

Applications

Factory automation in manufacturing and warehousing

Kiosks in public places – airports, information centers, railway stations and shopping malls

HMI: Human Machine Interface

Entertainment – Gaming, Casino

Hotel, Restaurant, and Hospitality

Medical and health care in Hospital

Portable/Mobile device

In-vehicle device

1.2 Specifications

There are 2 models of SPC-57 series, SPC-57E and SPC-57C. SPC-57C is the fully enclosure with standard external I/O connector. SPC-57E is without back cover, without standard external I/O connector, and without Flash memory on board. SPC-57E and SPC-57C can fulfill different applications and various demands from the customer.

SPC-57C

System kernel	
CPU	Intel PXA-255 200MHz on board
OS	Windows CE .NET 4.2
SDRAM	64MB SDRAM on board
Flash	32MB on board for OS pre-installed
WDT	PXA-255 internal
RTC	HT1381, backup by internal backup battery
Boot loader	1MB AMD Flash ROM for boot loader
Display	
LCD	5.7" STN QVGA 320 x 240
Touch screen	4 wire resistant touch screen
VGA chip	PXA-255 internal
I/O	
RS-232	Full 9 pin RS-232 X 3; D-sub 9-pin external connector X 1; Pin headers inside the case X 2
RS-485	RS-485 X 1, D-sub 9-pin external connector
RJ-45	10/100 base-T RJ-45 connector X 1
USB	USB host X 2; USB client X 1
PCMCIA	PCMCIA slot type II X 1
CF	CF slot type II X 1
Digital I/O	8 DI & 8 DO. Pin header output. Provide API to access DIO
GPIO	8 GPIO. Pin header output inside the case. Default as hotkey
Audio	Audio line out jack X 1
Power	
V-in range	DC 10V ~ 28V
Protection	Over current protection Electric pole reverse protection
SM bus	For smart battery, pin headers

Power switch	1 power switch
Power conn	1 power connector
SW reset	Through system configurator to execute the SW reset
Mechanical	
Dimension	210 X 155 X 41 (mm)
Material	SPCC
Certification	CE, FCC class A, UL
Environmental	
Operating temp	0 degree C ~ 50 degree C
Storage temp	-20 degree C ~ 60 degree C
Water/dust resistance	IP65 for front bezel

SPC-57E

System kernel	
CPU	Intel PXA-255 200MHz on board
OS	Windows CE .NET 4.2
SDRAM	64MB SDRAM on board
Flash	N/A for SPC-57E. Users have to get CF card by themselves to store the image file and boot from CF card
WDT	PXA-255 internal
RTC	HT1381, backup by internal backup battery
Boot loader	1MB AMD Flash ROM for boot loader
Display	
LCD	5.7" STN QVGA 320 x 240
Touch screen	4 wire resistant touch screen
VGA chip	PXA-255 internal
I/O	
RS-232	Full 9 pin RS-232 X 3; Pin headers output X 3
RS-485	RS-485 X 1, Pin headers output X 1
RJ-45	10/100 base-T Pin headers output X 1
USB	USB host X 2; USB client X 1; Pin headers output
PCMCIA	PCMCIA slot type II X 1
CF	CF slot type II X 1
Digital I/O	8 DI & 8 DO. Pin header output. Provide API to access DIO
GPIO	8 GPIO. Pin header output inside the case. Default as hotkey
Audio	Pin headers output

Power	
V-in range	DC 10V ~ 28V
Protection	Over current protection; Electric pole reverse protection
SM bus	For smart battery, pin headers
Power switch	1 power switch
Power conn	1 power connector
SW reset	Through system configurator to execute the SW reset
Mechanical	
Dimension	210 X 155 X 41 (mm)
Material	SPCC
Certification	CE, FCC class A, UL
Back cover	Without back cover; without I/O board;
Environmental	
Operating temp	0 degree C ~ 50 degree C
Storage temp	-20 degree C ~ 60 degree C
Water/dust resistance	IP65 for front bezel



SPC-57E: Smart Panel Computer without back cover and I/O board. Users have to get their own CompactFlash card (more than 32MB) to restore Windows CE .NET 4.2 image. The system will boot from CF card.

1.3 LCD Specifications

LCD model	Nan Ya LMB61-23
Display type	STN color LCD
Size (Diagonal)	5.7"
Resolution	320 x 240 (VGA)
Maximum colors	256
Pixel pitch (WxH, mm)	0.36 X 0.36
Luminance (cd/m ²)	165 cd/m ²
Contrast ratio	35
Response time	Rise 300 ms, Fall 80 ms
Lamp lifetime	20000 hours

1.4 Touchscreen Specifications

Type	Resistive
Base glass construction	Tempered Glass
Resolution	Continuous
Light transmission	75% typical
Durability	100000 activations for written characters 10000 activations for each single point

1.5 Power

SPC-57 works by 10 ~ 28Vdc power input. The maximum current is about 1.5A, and the nominal power consumption is 6 Watts.

1.6 I/O Ports Arrangement

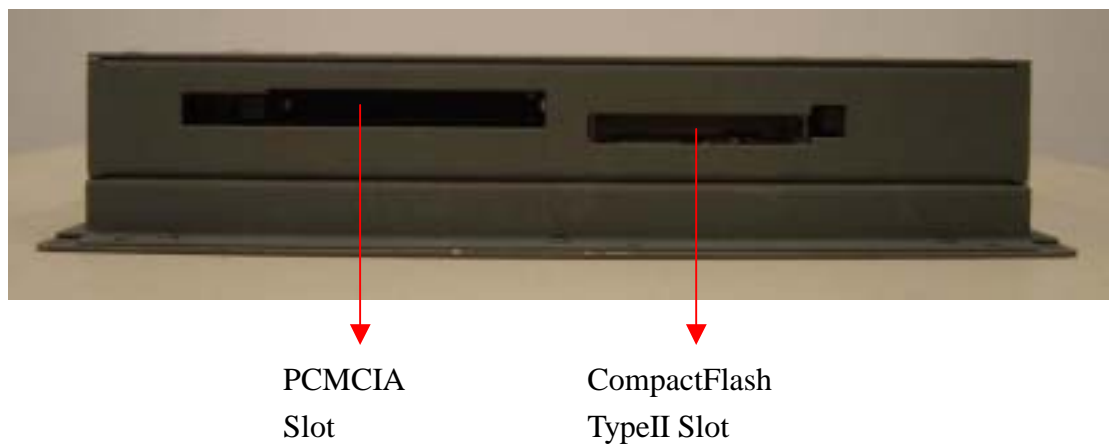
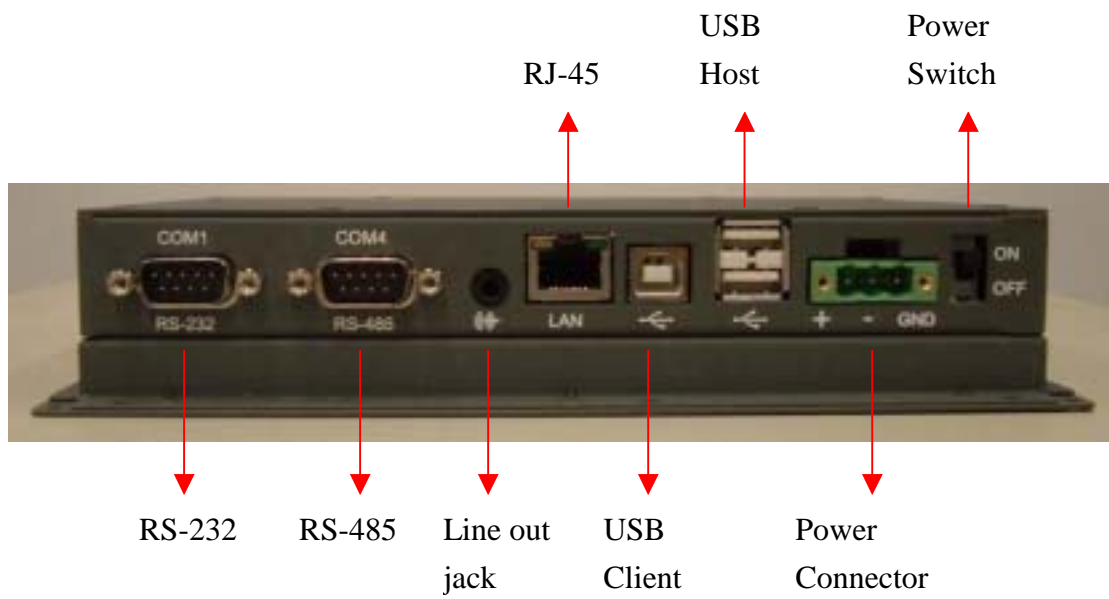

1.7 Mounting

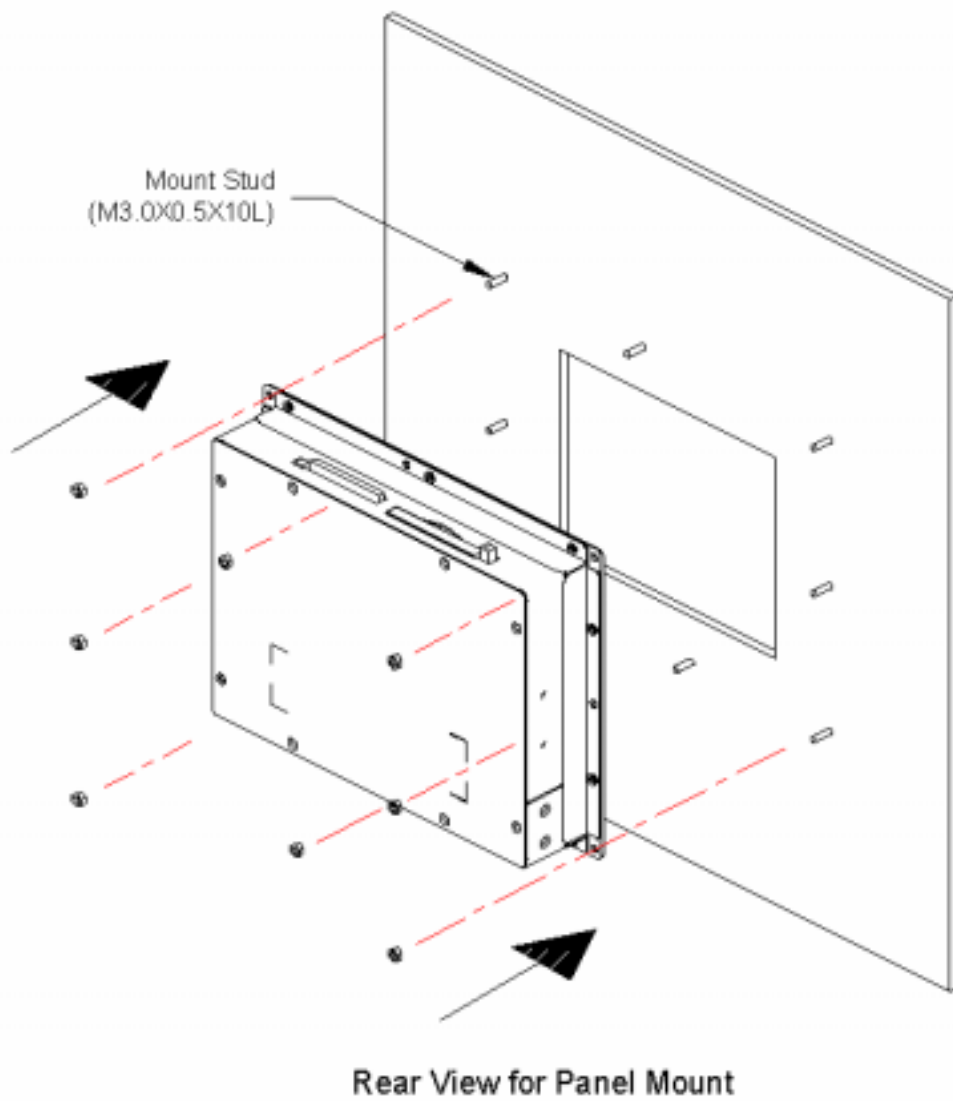

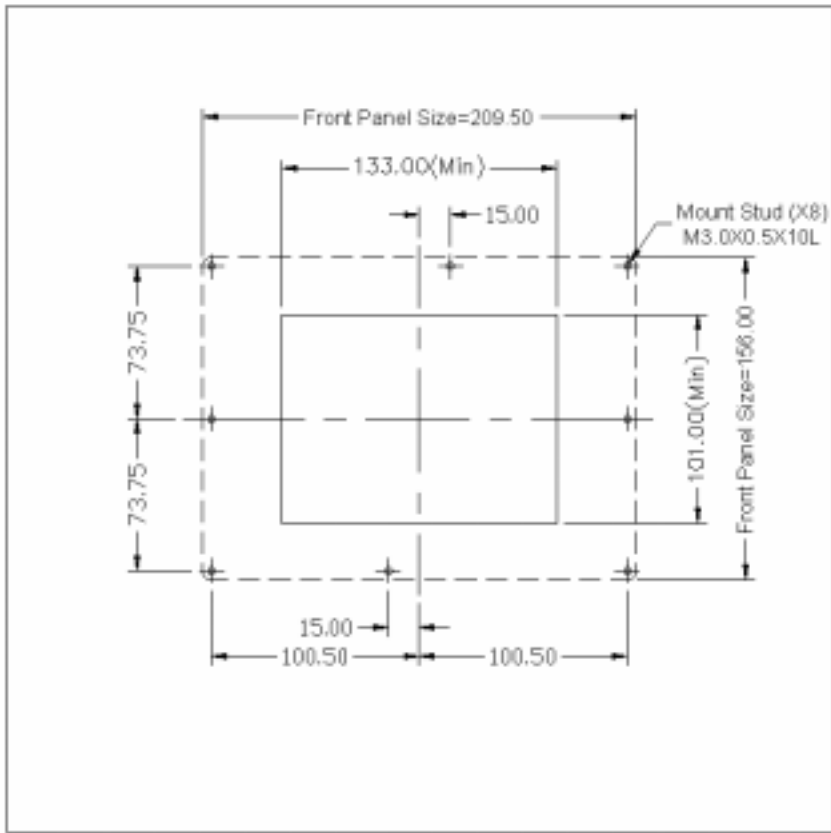

Front View for Panel Mount

Units:mm

1.8 Dimension and cutout

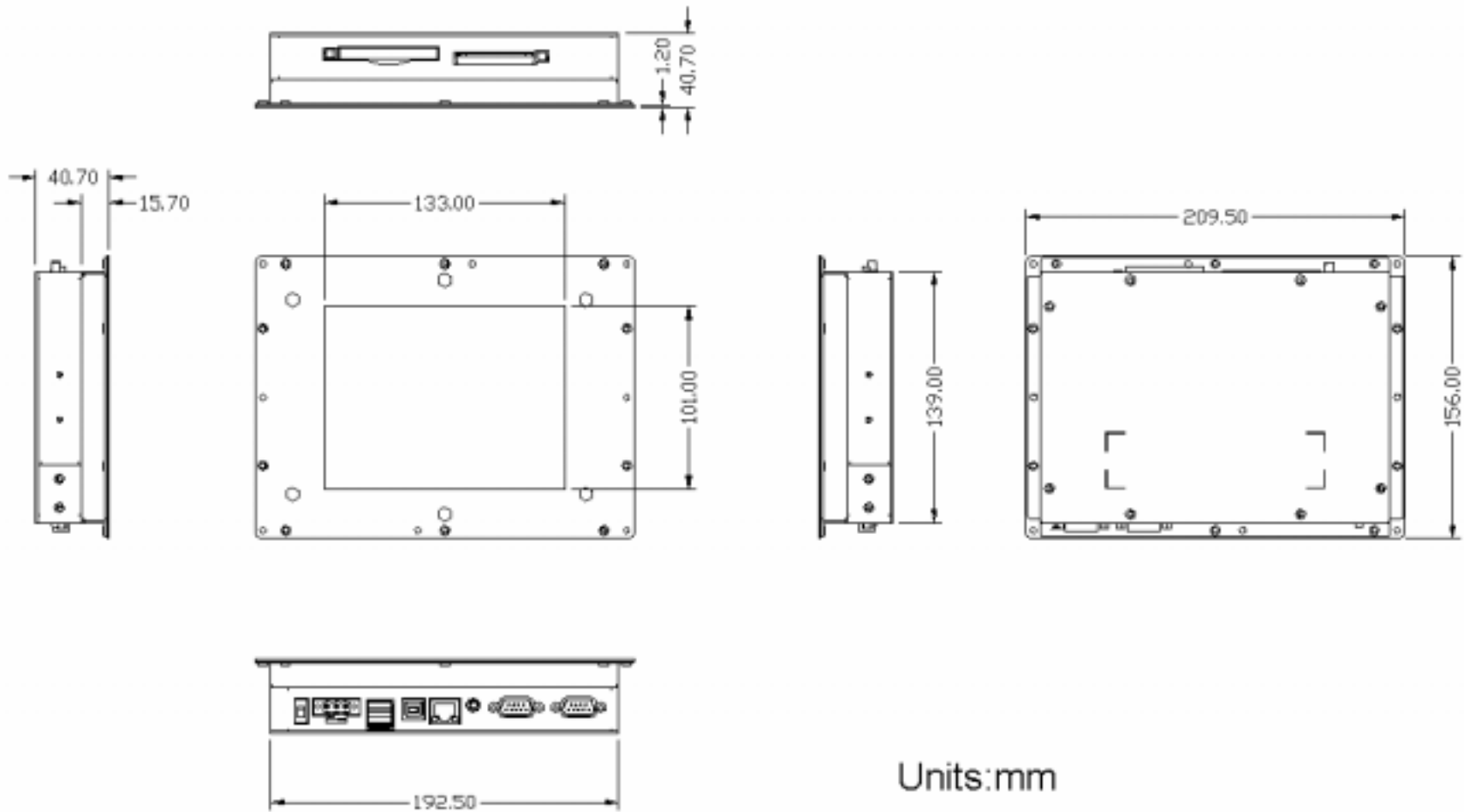

Units:mm

Getting Start

This chapter provides brief instructions for operating the SPC-57

2.1 Quick Starting

Step1: Unpack the SPC-57 from its packing. Please check the packing list at the beginning of this manual.

Step2: Connect the power connector to 10 ~ 28 Vdc power source. The power source can either be from a power adapter or an in-house power source.

Step3: Connect the power source to the system power supply.

Step4: Plug in the power lines and turn on the system power switch, you will see the Welcome screen of Windows[®] CE.NET. Then you can start to use SPC-57.

Step5: Turn on the power switch.

Step6: Calibrate the touchscreen.



2.2 Supplying Power to SPC

2.1.1 Supplying Power to SPC-57C

1. SPC accepts only DC power, not AC power
2. The DC input range for SPC is 10V ~ 28V.
3. Install the Vcc cable and GND cable into the male power connector (male power connector is in the package of SPC)

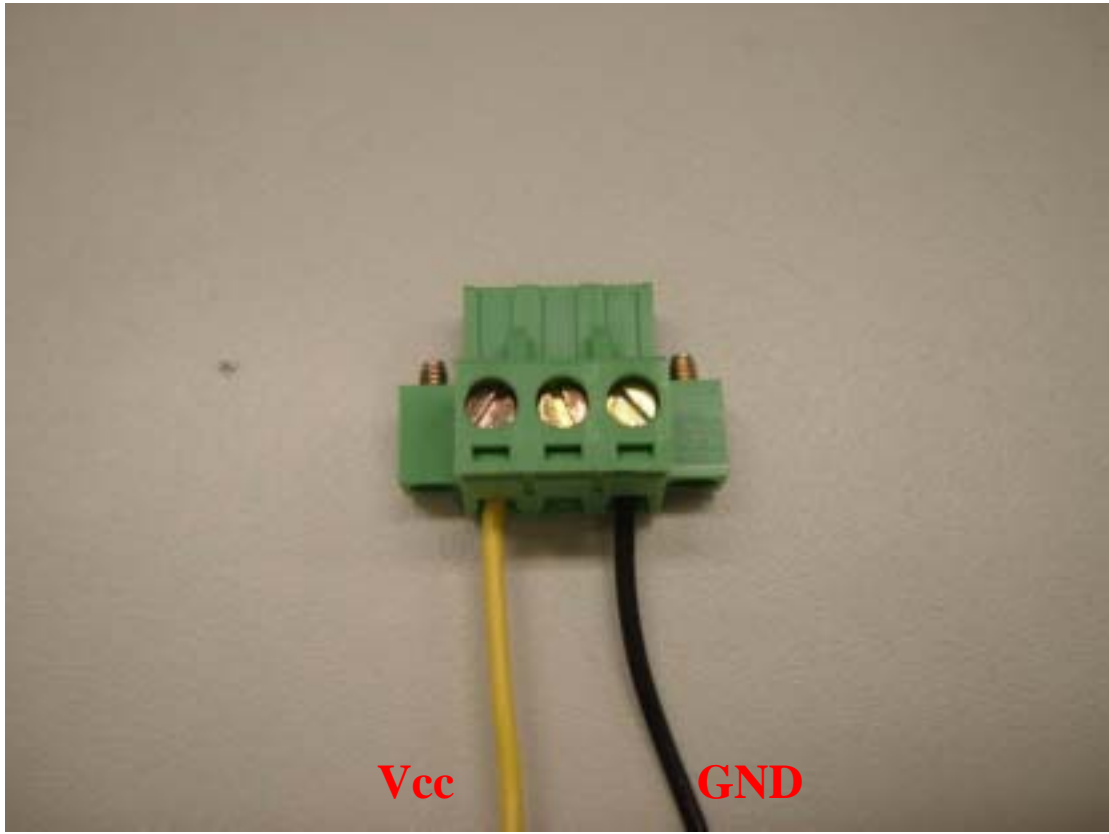

4. Plug the male power connector into female power connector in SPC.



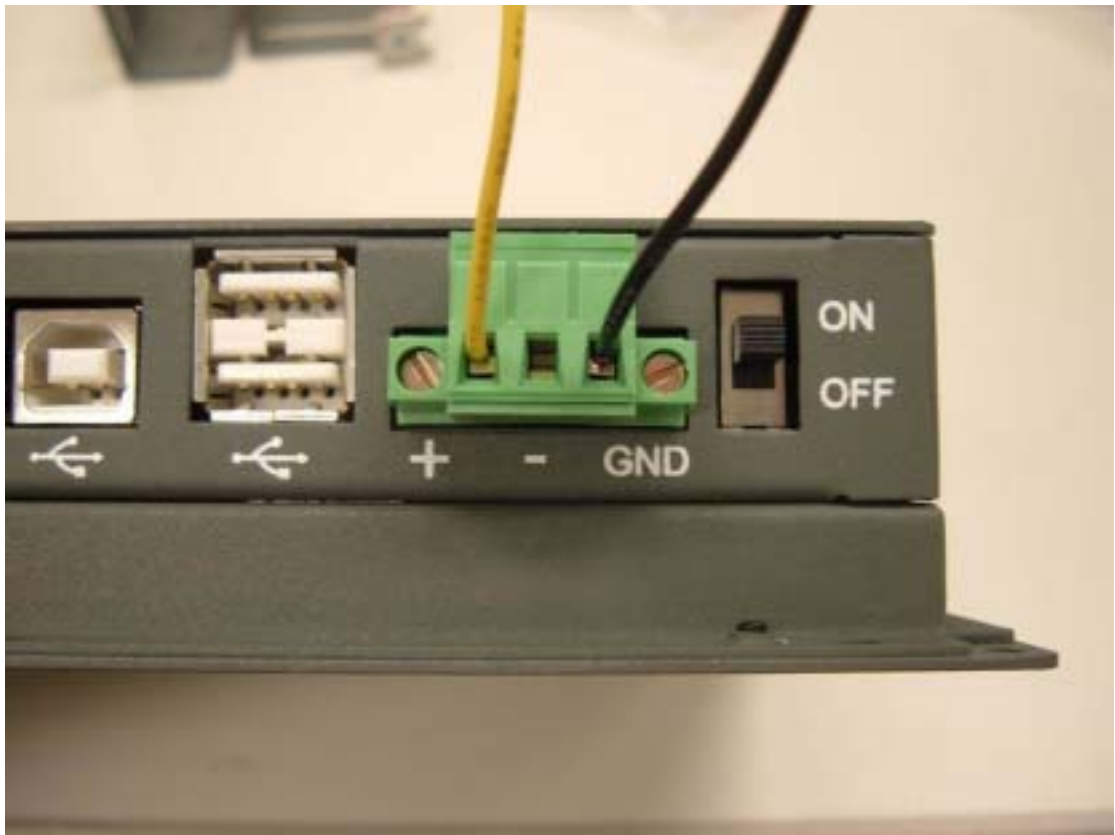

5. Turn on the power switch

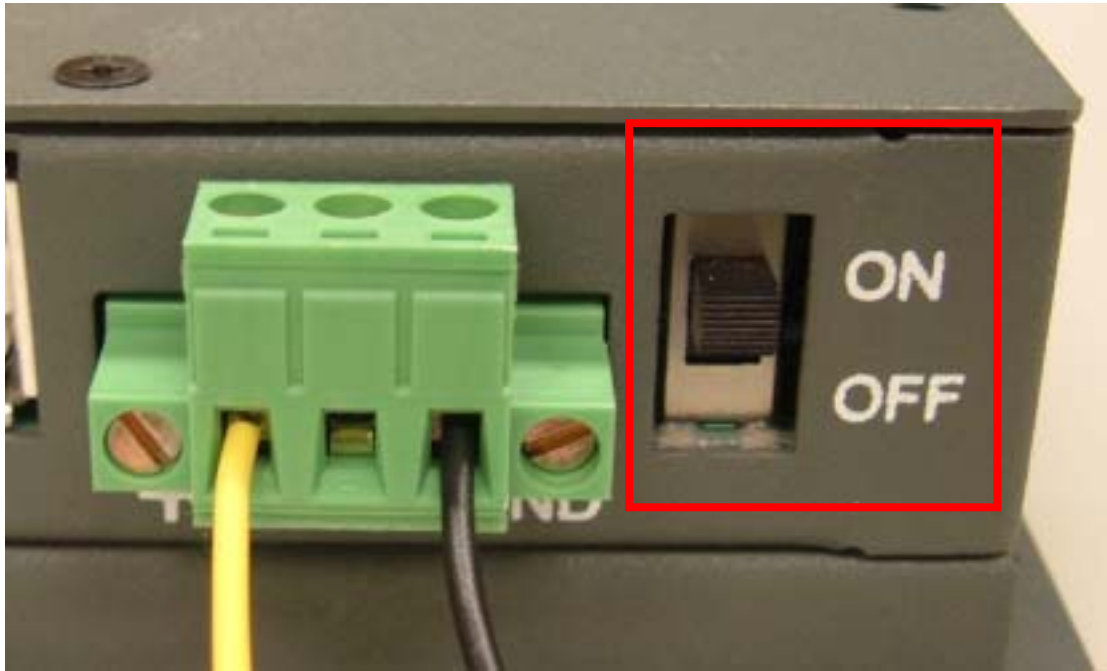

2.1.2 Supplying Power to SPC-57E

1. SPC accepts only DC power, not AC power
2. The DC input range for SPC is 10V ~ 28V.
3. Use the power cable (in SPC-57E package) to connect the board of SPC-57 and power source.



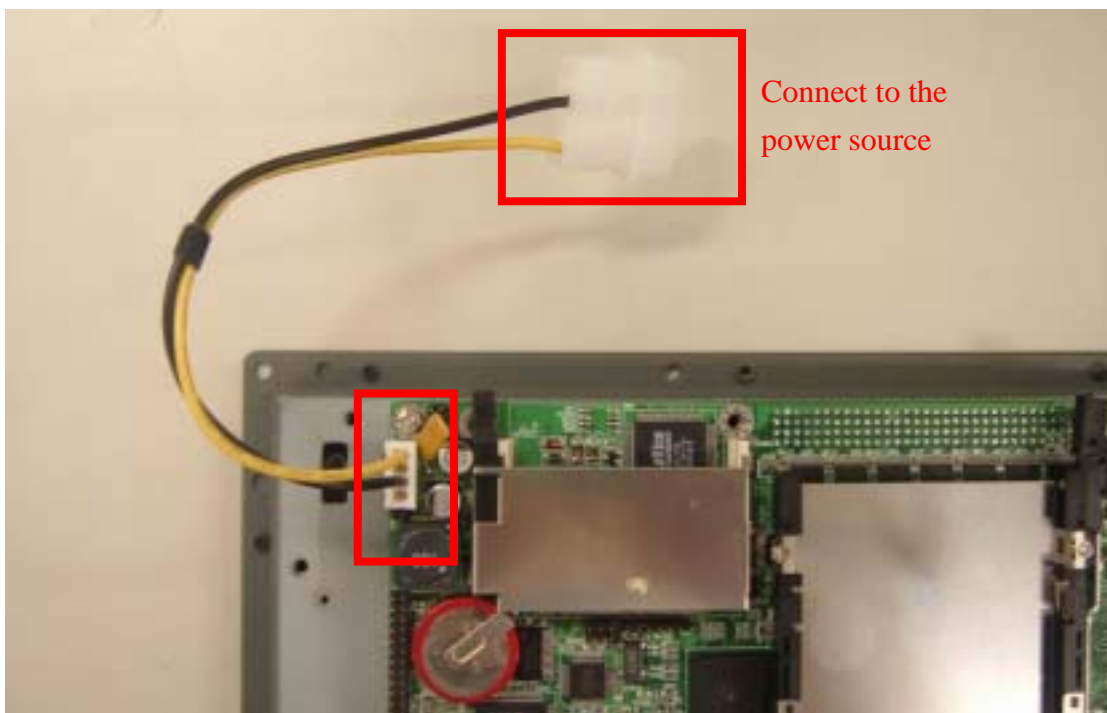
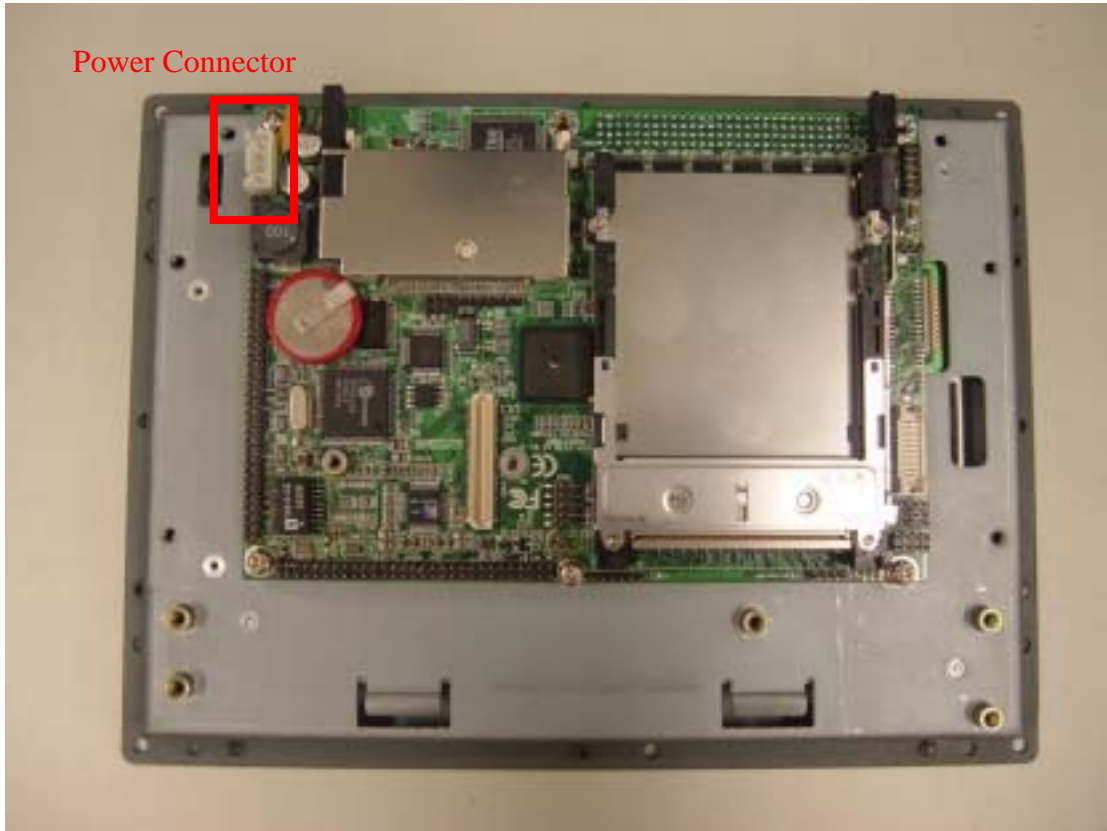

4. If the power cable included in the SPC-57E package is not suitable to users' application, users have to make their own cable to supply power to SPC.

The Engine of the SPC-57

This chapter details hardware's setting and functionality in the SPC-57

Sections include:

- PCM-7230 SBC for SPC-57
- I/O Board
- LCD and touch-screen
- Power system

This chapter will detail hardware setting and functionality in the SPC-57. Following will introduce (1) PCM-7230 SBC for SPC-57; (2) The I/O Board (there is no I/O board of SPC-57E) (3) LCD and touch-screen; (4) Power system.

3.1 PCM-7230 Mainboard for SPC-57

The Engine of SPC-57 is constructed by the combination of 2 PCBA – one mainboard and one I/O board. The mainboard is slightly modified based on Advnatech standard product PCM-7230 to fulfill SPC-57 specification. In this manual, we will still use PCM-7230 to mean the mainboard although it is slightly different from our standard product. The PCM-7230 SBC for SPC-57 is a 3.5” (145mm x 102 mm x 21.1mm) single board computer with the Intel[®] PXA255 processor running at 200 MHz. The milli-watt power consumption by its kernel makes the PCM-7230 suitable for power conscious applications.

3.1.1 Specification

Model PCM-7230 SBC for SPC-57

Model		PCM-7230 SBC for SPC-57
Kernel part	CPU	Intel [®] PXA255 processor at 200 MHz
	System memory	1MB NOR flash for bootloader and 64MB SDRAM
	Memory Module	N/A
	WDT	PXA-255 Internal (2, 5, 10 Sec as default)
	RTC	HT-1381 with rechargeable coin battery
	Power Input	DC 10V~28V, with power protect (protect for over voltage, over current & short).
	OS	Microsoft [®] Windows [®] CE.NET 4.2
I/O ports	Serial Ports	Three full-function RS-232 ports and one RS-485 w/ AFC -COM1 full-function transceiver level RS-232 -COM2 full-function transceiver level RS-232 -COM3 full-function transceiver level RS-232 -COM4 RS-485 w/ AFC
	Ethernet	10/100 BASE-T Ethernet Port
	USB host port	2 X USB 1.1 host ports
	USB Client Port	USB Client Port for ActiveSync function
	PCMCIA	One type-II hot-swappable PCMCIA slot
	CF	One type-II hot-swappable CF slot
	DI & DO	8 digital input pins & 8 digital output pins. All are TTL level.
	GPIO	8 GPIO pin headers out put. Default as hotkeys.
	Display	LCD
CRT		SVGA at default to align with LCD setting, Pin header output
System Part	JTAG	7x1 pin header for upgrade the bootloader in AMD flash.
	Inverter	4-pin inverter interface for 5V inverter
	touch-screen	4-wire resistive T/S interface. 2x2 2.00mm pin header.

	Audio	AC'97 Stereo Audio w/ 2W Amp. - Line-In, Line-Out, Speaker-out and Mic-In
	SM Bus	For sensing DC power and battery status. 2x2 2.00mm pin header
	Backup Battery	For RTC
	LED Indicator	On board : IO_VCC3P3 indicator(beside CN12), CF interface busy indicator(beside CN20). Pin header: SYS_VCC3P3, CF card busy indicator, PCMCIA card busy indicator, battery status indicator, LAN link, LAN speed 10/100 indicator.
	SW reset	Through system configurator to execute the SW reset
Environment	Operating Temperature	0~50°C (32°~140°F)
	Operating Humidity	0%~90% Relative Humidity

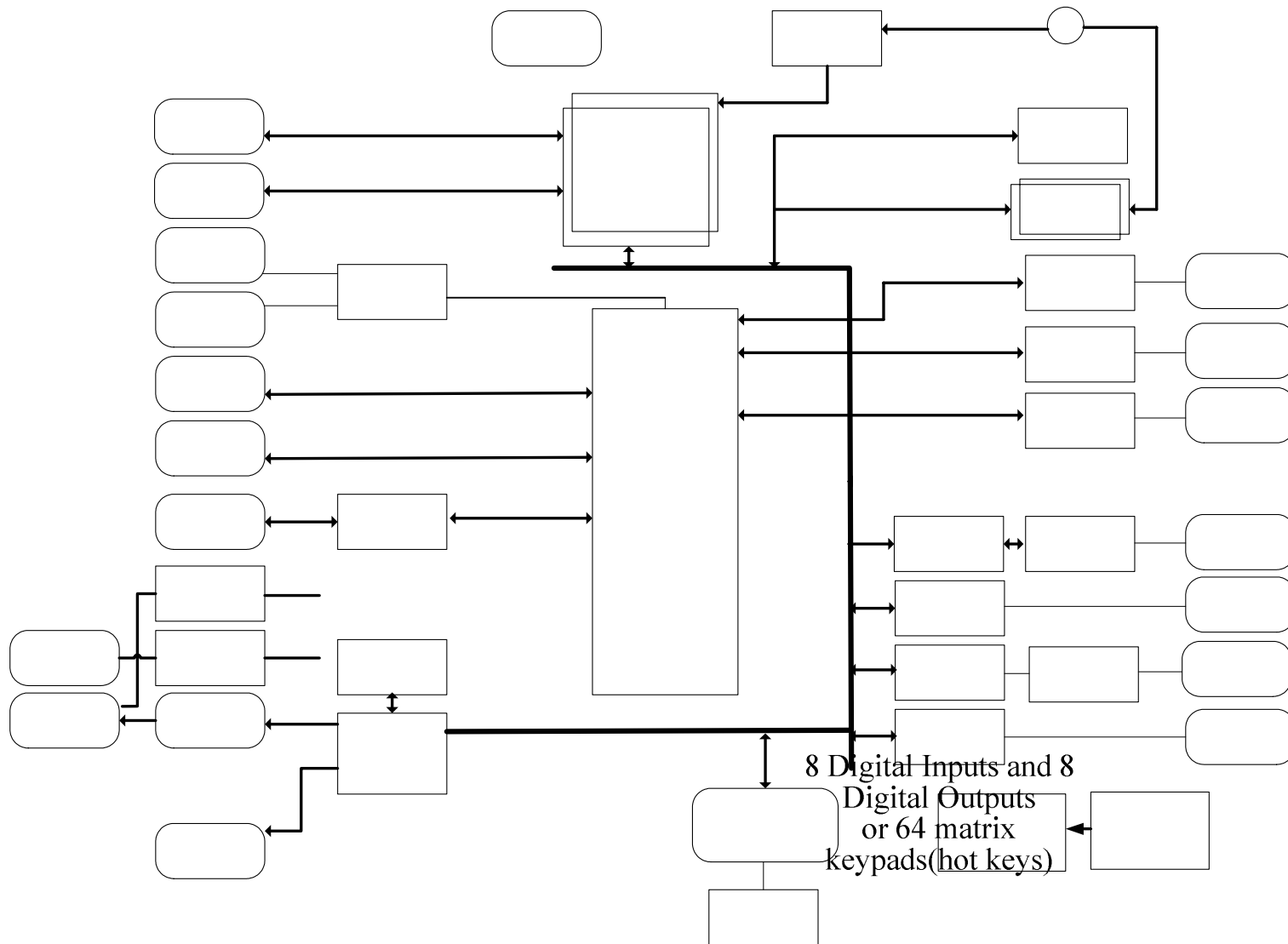

8 Hotkeys

Figure 3.1 The PCM-7230 for SPC-57 Block Diagram

3.1.2 Headers and connectors

This section locates headers and connectors of PCM-7230 and describes their functionality.

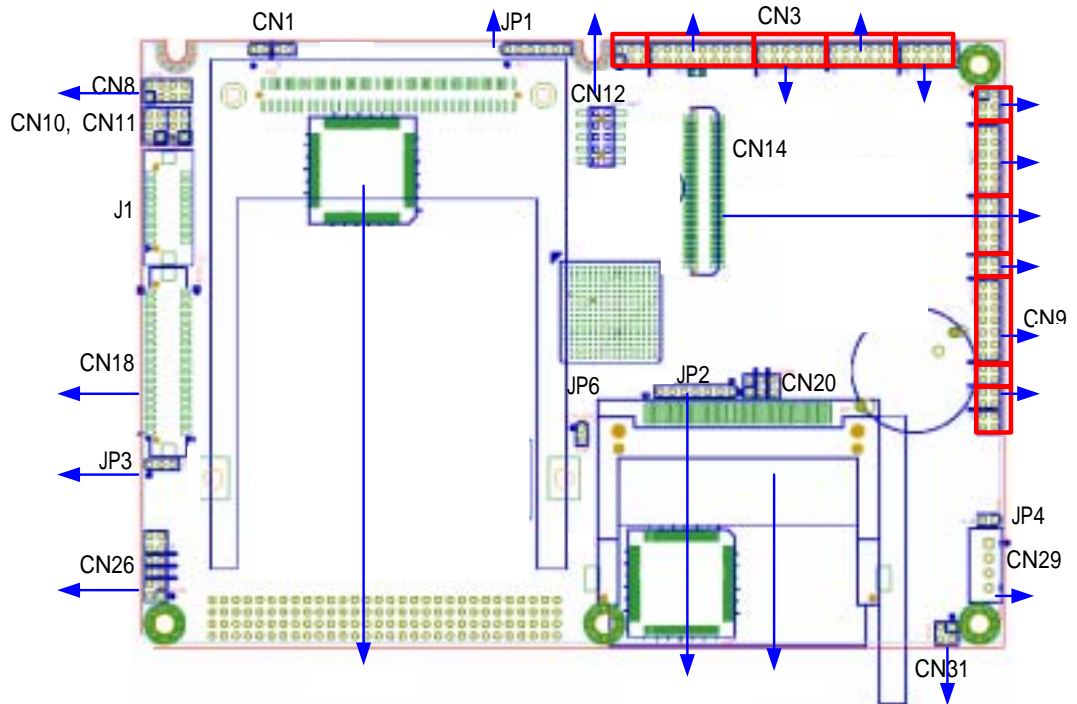

Figure 3.2: Component side of the PCM-7230

CRT out

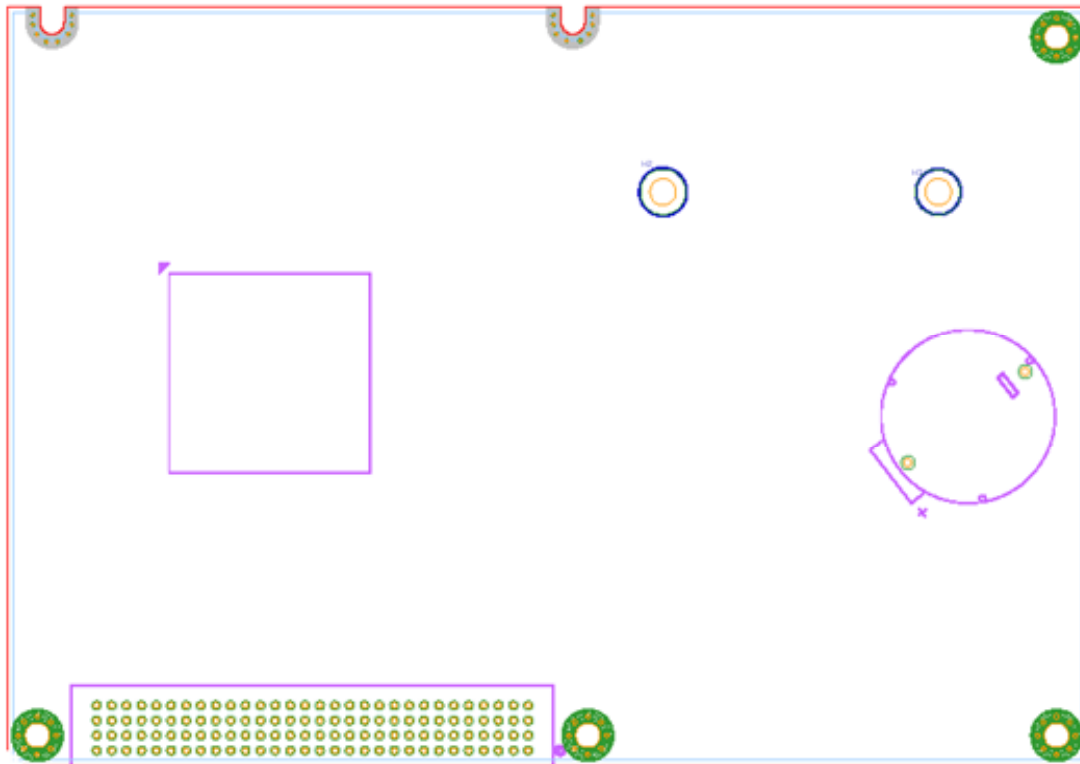

Figure 3.3: Solder side of the PCM-7230

Table 3.1 Header Description

Label	Function
JP 1	CPLD JTAG port
JP 2	CPU PXA255 JTAG port
JP 3	LCD signal voltage level select
JP 4	Power switch header
CN 1	PCMCIA accessing status port
CN 3	multi-function I/O header(I)
CN 8	CRT-out header
CN 9	multi-function I/O header(II)
CN 12	HotKey function header
CN 14	memory module 100-pin board-to-board connector
CN 18	TTL level LCD signal connector
CN 20	LAN status LED header
CN 25	type II CF slot
CN 26	Inverter signals header
CN 29	Power-in connector
CN 31	SM bus port

3.1.3 Headers and connectors pin definition

Because the board size limitation & wants to keep the flexible of I/O connector placement,

The following lists are I/O pin definitions of PCM-7230 SBC. All the pin headers' pin order is the same as the figure. As you see, the first pin has a white mark on PCB. Except the pin headers, all the other connectors have white mark at 1st pin.

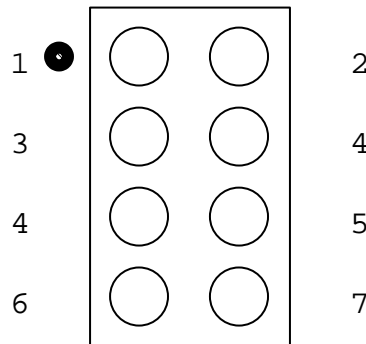

The following tables are the pin definition of all the connectors on PCM-7230 SBC.

JP 1 : CPLD JTAG port

there are two CPLDs on PCM-7230. Advantech doesn't suggest users to modify the CPLD code. If users have to do it, please contact your distributor or sales representative.

JP 2 : CPU PXA255 JTAG port

Pin Number	Pin function	Ps.
1	TCK	
2	TDI	
3	TDO	
4	TMS	
5	nJTAG_TRST	
6	nRESET	

Note: Users can use this port to modify the bootloader.

JP 3 : LCD signal voltage level select

Pin Number	Pin function	Ps.
1	SYS_VCC	+5V
2	LCD_VCC	power of LCD-signal buffers
3	VCC3P3	+3.3V. VCC3P3 will change to 0V when system enter sleep mode.

Note: when User wants to use CN18 (40 pin TTL level LCD signal) to drive LCD panel, user needs to setup this pin header. If the LCD panel signal is 3.3V then set the 2.00mm jumper at 1-2 pin of JP3; if the LCD panel signal is 5V then set the jumper at 2-3 pin.

JP 4 : Power switch header

Pin Number	Pin function	Ps.
1	POW_SW_P	connect to power switch positive pole
2	POW_SW_N	connect to power switch negative pole

Note: Only pin 1 is shorted with pin 2 of JP4, the system power is on.

CN 1 : PCMCIA accessing status port

Pin Number	Pin Function	Ps.
1	Resv.	
2	Resv.	
3	PCM_RDY	
4	PCM_VR	

Note: If user wants to know the accessing status of PCMCIA slot, user can directly connect the LED positive pole to 4th pin and negative pole to 3rd pin.

CN 3 : multi-function I/O header (I)

Pin Number	Pin Function	Ps.
1	Resv.	
2	Resv.	
3	Resv.	
4	Resv.	
5	Resv.	
6	Resv.	
7	DI 0*	Digital input bit 0.
8	DO 0*	Digital output bit 0.
9	DI 1*	Digital input bit 1.
10	DO1*	Digital output bit 1.
11	DI 2*	Digital input bit 2.
12	DO2*	Digital output bit 2.
13	DI 3*	Digital input bit 3.
14	DO3*	Digital output bit 3.
15	DI 4*	Digital input bit 4.
16	DO 4*	Digital output bit 4.

17	DI 5*	Digital input bit 5.
18	DO 5*	Digital output bit 5.
19	DI 6*	Digital input bit 6.
20	DO 6*	Digital output bit 6.
21	DI 7*	Digital input bit 7.
22	DO 7*	Digital output bit 7.
23	GND	
24	VCC3P3	
25	SPK_OUT_RP	positive port of right channel speaker-out function
26	SPK_OUT_RN	negative port of right channel speaker-out function
27	SPK_OUT_LP	positive port of left channel speaker-out function
28	SPK_OUT_LN	negative port of left channel speaker-out function
29	LINE_OUT_RP	
30	LINE_OUT_LP	
31	AC97_AGND	
32	AC97_AGND	
33	LINE_IN_L	left channel of audio line-in port
34	LINE_IN_R	right channel of audio line-in port
35	MIC_IN	audio microphone-in port
36	AC97_AGND	
37	nUART3_DCD	
38	UART3_RXD	
39	UART3_TXD	
40	nUART3_DTR	
41	GND	
42	nUART3_DSR	
43	nUART3_RTS	
44	nUART3_CTS	
45	nUART3_RI	
46	VCC_UART3	+5V
47	nRESET_OUT	
48	MODE	reserved for future use. pull-high by 100K resistor.
49	nUART2_DCD	
50	UART2_RXD	
51	UART2_TXD	
52	nUART2_DTR	
53	GND	
54	nUART2_DSR	
55	nUART2_RTS	
56	nUART2_CTS	
57	nUART2_RI	
58	VCC_UART2	+5V

**Warning! Be careful when these DI/DO are used. Surge or over voltage may damage*

the circuits.

CN 8 : CRT-out header

Pin Number	Pin function	Ps.
1	Reserv.	reserve for the future
2	CRT_Vsync	
3	Reserv.	reserve for the future
4	CRT_Hsync	
5	CRT_B	CRT blue signal
6	GND	
7	CRT_G	CRT green signal
8	CRT_R	CRT red signal

CN 9 : multi-function I/O header(II)

Pin Number	Pin function	Ps.
1	TPTX100P	Lan TX signal
2	TPTX100N	Lan TX signal
3	TPRX100P	Lan RX signal
4	TPRX100N	Lan RX signal
5	RJ45_P4_P5	LAN connector P4 & P5. in order to avoid noise
6	RJ45_P7_P8	LAN connector P7 & P8. in order to avoid noise
7	Resv.	
8	Resv.	
9	Resv.	
10	Resv.	
11	Resv.	
12	Resv.	
13	Resv.	
14	Resv.	
15	Resv.	
16	Resv.	
17	UART4_485_TXN	Negative signal of RS485 function.
18	UART4_485_TXP	Positive signal of RS485 function.
19	Resv.	
20	Resv.	
21	Resv.	
22	Resv.	
23	Resv.	
24	Resv.	
25	Resv.	
26	Resv.	
27	Resv.	
28	Resv.	
29	XP	X axis positive signal of

		touch screen function
30	YP	touch screen signal
31	XN	touch screen signal
32	YN	touch screen signal
33	nUART1_DCD	
34	UART1_RXD	
35	UART1_TXD	
36	nUART1_DTR	
37	GND	
38	nUART1_DSR	
39	nUART1_RTS	
40	nUART1_CTS	
41	nUART1_RI	
42	VCC_UART1	+5V
43	GND	
44	VCC_UART1	
45	N.C.	No function
46	N.C.	No function
47	USB_VCC5	
48	GND	
49	SA_BUSB_DPR	
50	SA_BUSB_DNR	
51	USB1_V	USB 1st host power +5V
52	GND	
53	USB1_P	USB 1st host signal
54	USB1_N	USB 1st host signal
55	USB2_V	USB 2ed host power +5V
56	GND	
57	USB2_P	USB 2ed host signal
58	USB2_N	USB 2ed host signal

CN 12 : HotKey function header

Pin Number	Pin function	Ps.
1	HK 1	1 st pin of hotkey function
2	HK 5	5 th pin of hotkey function
3	HK 2	2 nd pin of hotkey function
4	HK 6	6 th pin of hotkey function
5	HK 3	3 rd pin of hotkey function
6	HK 7	7 th pin of hotkey function
7	HK 4	4 th pin of hotkey function
8	HK 8	8 th pin of hotkey function
9	GND	
10	SYS_VCC3P3	

note : when HKx connects to SYS_VCC3P3, then hotkey function works. HKx signals are triggered by rising edge.

CN 18 : TTL level LCD signal connector

Pin Number	Pin function	Ps.
1	VCC	+5V
2	VCC	+5V
3	GND	
4	GND	
5	VCC3P3	+3.3V
6	VCC3P3	+3.3V
7	LCD_VEE	
8	GND	
9	LCD_D0	
10	LCD_D1	
11	LCD_D2	
12	LCD_D3	
13	LCD_D4	
14	LCD_D5	
15	LCD_D6	
16	LCD_D7	
17	LCD_D8	
18	LCD_D9	
19	LCD_D10	
20	LCD_D11	
21	LCD_D12	
22	LCD_D13	
23	LCD_D14	
24	LCD_D15	
25	LCD_D16	
26	LCD_D17	
27	LCD_D18	
28	LCD_D19	
29	LCD_D20	
30	LCD_D21	
31	LCD_D22	
32	LCD_D23	
33	GND	
34	GND	
35	SHCLK	
36	FLM_VSYNC	
37	M_DE	
38	LP_HSYNC	
39	N.C.	no function
40	ENVEE	

note : User can use JP3 to change the LCD signals level.

CN 20 : LAN status LED header

Pin Number	Pin function	Ps.
1	CF_VR	compact flash slot LED indicator, positive pole
2	CF_RDY	compact flash slot LED indicator, negative pole
3	LED_LINK_P	positive pole of LAN link status LED
4	LED_LINK_N	negative pole of LAN link status LED
5	LED_SPEED_P	negative pole of LAN 10/100 speed status LED
6	LED_SPEED_N	negative pole of LAN 10/100 speed status LED

Note: If user wants to know the accessing status of CF slot, he can connect the LED positive pole to pin 1 and negative pole to pin 2.

CN 26 : Inverter signals header

Pin Number	Pin function	Ps.
1	SYS_VCC	+5V
2	GND	
3	ENVBK5V	inverter enable signal
4	BLCTRL_SW	backlight strength switch
5	Resev.	reserve pin for future
6	GND	
7	Power_LED	System power LED indicator. +3.3V
8	GND	
9	Resev.	reserve pin for future
10	Resev.	reserve pin for future
11	Resev.	reserve pin for future
12	Resev.	reserve pin for future

Note: If user wants to know the system power status by self-connected LED, he can connect the LED positive pole to pin 7 and negative pole to pin 8.

CN 29 : Power-in connector

Pin Number	Pin function	Ps.
1	GND	negative pole of power input
2	GND	negative pole of power input
3	DC_IN	positive pole of power input
4	DC_IN	positive pole of power input

Note: CN29 is the main power input port. The DC_IN range is 10V ~ 28V.

CN 31 : SM bus port

Pin Number	Pin function	Ps.
1	I2CSCL	clock pin of SM bus for smart battery
2	GND	
3	I2CSDA	data pin of SM bus for smart battery
4	nDC_IN	This pin is pulled low on PCM-7230 by 2M ohm.

3.1.4 COM1~COM4 serial ports

The PCM-7230 offers four full-functions RS-232 (COM1, COM2, and COM3) and one RS-485 w/ AFC (COM5) serial communication interface ports.

➤ Automatic Data Flow Control Function for RS-485

The RS-485 in PCM-7230 will automatically sense the direction of incoming data and switch its transmission direction accordingly. Therefore no handshaking signal (e.g. RTS signal) is necessary. This feature lets users build an RS-485 network simply and quickly with just two wires. More importantly, application software previously written for half duplex RS-232 environments can be maintained without need for modification.

3.1.5 LAN: Ethernet Connector(CN9,Pin1~Pin6)

The PCM-7230 is equipped with one Davicom DM9000 10/100 Base-T Ethernet LAN controller. The second and third LED indicators (approach AMI-120 Interface) on board show the Link and Active (Green LED) status of this Ethernet port.

3.1.6 USB client connector(CN9,Pin47~Pin50)

This USB client connector is used to communicate with PC for ActiveSync. Users may connect the PCM-7230 with PC to develop their own applications and download files to PCM-7230.

3.1.7 DC power connector(CN29)

The DC power connector carries 12 VDC external power input and features reversed wiring protection. Therefore, it will not cause any damage to the system by reversed wiring of ground line and power line.

3.1.8 LCD display connector(TTL level:CN18 ; LVDS:J1)

This 40-pin LCD display connector is for LCD connectivity.

3.1.9 LCD inverter connector for 5V inverter(CN26, Pin1~Pin4)

Connect the PCM-7230 with the 5V inverter for adjusting LCD panel's brightness. The voltage range of this signal is from 0 to 5V. When enable backlight is on, the voltage of this signal is 5V; otherwise is 0V. Brightness voltage is adjustable by Advantech SW utility.

3.1.10 Audio connector(CN3,P25~P36)

The PCM-7230 provides audio signals on pin25 ~ pin36 of CN3. These audio signals include Microphone in (mono), Line in/out (stereo) and two speaker-out function.

3.1.11 Battery and DC power status monitor connector(CN31)

With this connector, the PCM-7230 can monitor and report the battery and DC power status thru I2C bus.

3.1.12 4-wire touch-screen connector(CN9,Pin29~Pin32)

Connect the PCM-7230 with the 4-wire touch-screen. The PCM-7230 supports 4-wire resistive touch-screen. Figure 3.7 shows the cable connected to this connector.

3.1.13 8 DI,8 DO pin header (CN3,Pin7~Pin24) & GPIO pin header(CN12)

This connector connects the PCM-7230 with the 8 DI & 8 DO. The PCM-7230 has 8-channel digital inputs,8-channel digital outputs and 8 GPIO pins. The GPIO is default for hotkey function.

3.1.14 PCMCIA slot (U10)

The PCM-7230 default provides one type II hot-swappable PCMCIA slots in the solder side for CompactFlash card, wireless LAN card, etc.

3.1.15 100-pin board-to-board connector for Memory Module (CN14)

Another issue related to the Memory Module is boot priority. Users may put your image files into flash on the Memory Module by Advantech upgrade utility. Users may also put your image files in the CompactFlash card as another choices and boot from PCMCIA or CF slots. *The CompactFlash card always comes the first priority when system is booting.*



Figure 3.4: Component Side of Memory Module



Figure 3.5 Solder side of Memory Module

3.1.16 Backup Battery (BT1)

The PCM-7230 series build in one 3.0V, coin-type rechargeable backup battery for external RTC. This backup battery is charging when system power is on.

3.1.17 Form factor

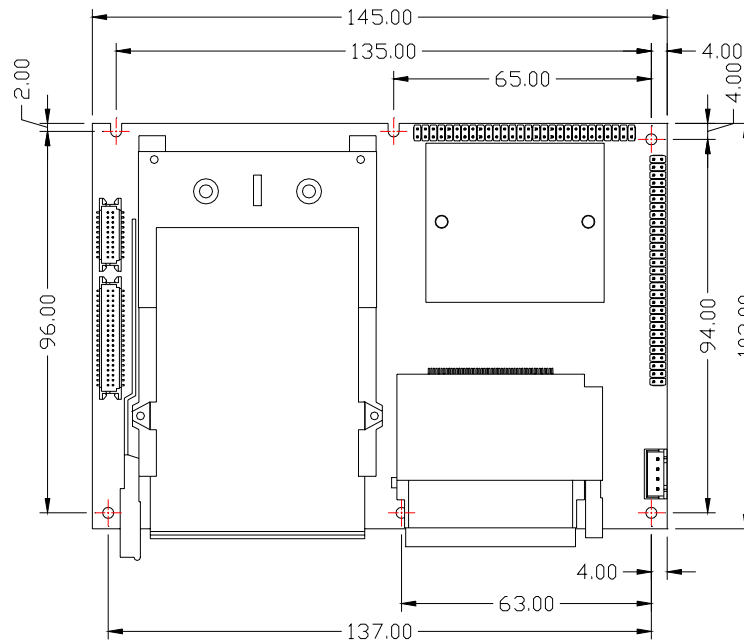

Figure 3.6 Form factor of the PCM-7230

3.2 I/O Board

The I/O Board can expand its I/O function thru two I/O cables. The expand functions have RS-232*1(COM1); RS-485*1(COM4) ; Audio(Line-out) ; RJ-45 for Ethernet port ; USB Client ; 2 port USB Host ; Power connector (10~28 V) ; Power switch ; Power Source to main board ;

Multi-function I/O header (I) ; Multi-function I/O header (II).

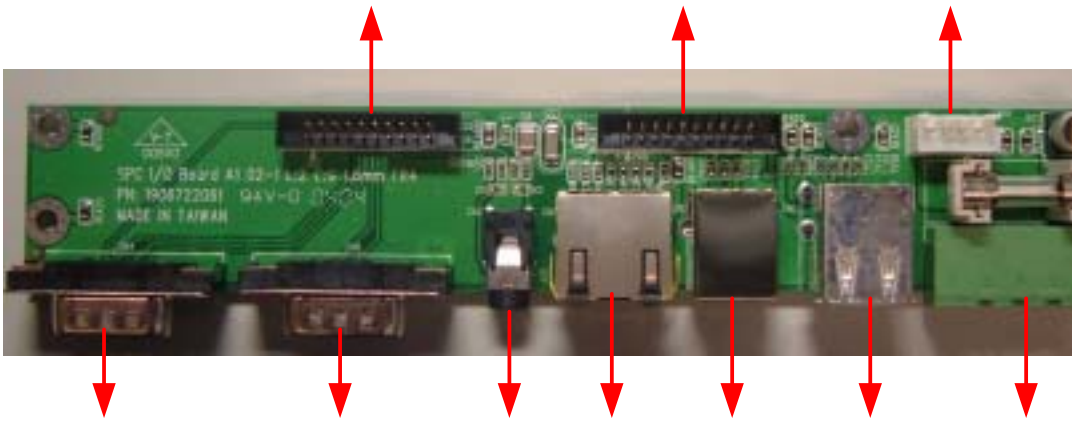

Figure 3.7 Component side of the I/O Board

PN	Position	Description
1	CN4	COM1 (RS-232) Serial Port
2	CN6	COM4(RS-485) Serial Port
3	CN2	Audio(Line-out) Port
4	CN5	RJ-45 for Ethernet Port
5	CN3	USB Client Port
6	CN1	USB Host Port
7	CN9	Power Connector
8	SW1	Power Switch
9	CN10	Power Source to main board
10	CN7	Multi-function I/O header (I)

1

CN 6 : RS-232 serial port

Pin	Signal
1	DCD
2	RXD
3	TXD
4	DTR
5	GND
6	DSR
7	RTS
8	CTS
9	RI

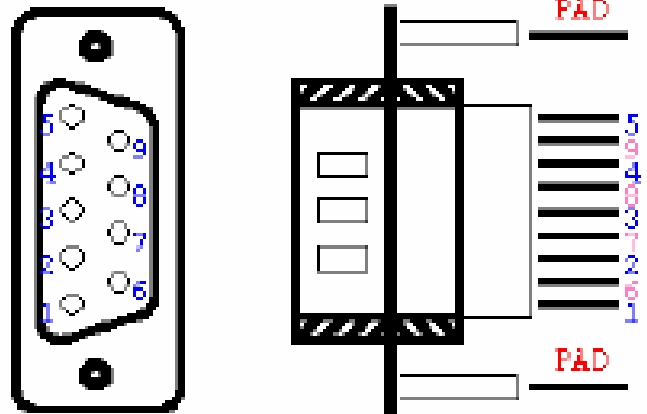

Figure 3.8 I/O Board COM1(RS-232) serial port

CN 4 : RS-485 serial port

Pin	Signal
1	N/C
2	Data+
3	Data-
4	N/C
5	GND
6	N/C
7	N/C
8	N/C
9	N/C

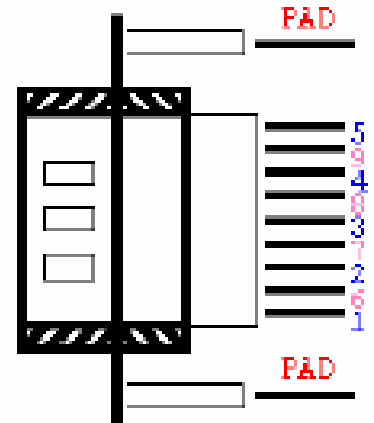
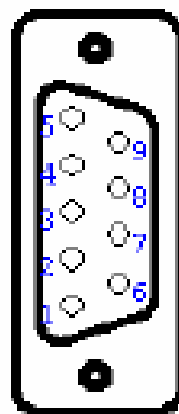

Figure 3.8 I/O Board COM4(RS-485) serial port

CN 2 : Audio (Line-out) port

Pin	Signal
1	Right channel
2	Left channel
3	GND
4	Left channel

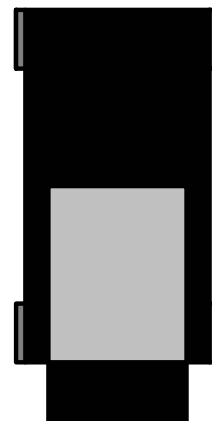

Figure 3.9 I/O Board Audio(Line-out) port

CN 5 : RJ-45 for Ethernet port

Pin	Signal
1	TPTX100P
2	TPTX100N
3	TPRX100P
4	N/C
5	N/C
6	TPRX100N
7	N/C
8	N/C
9	NC
10	NC
11	GND
12	GND
13	LED1+
14	nLINK
15	LED2+
16	nSPEED100

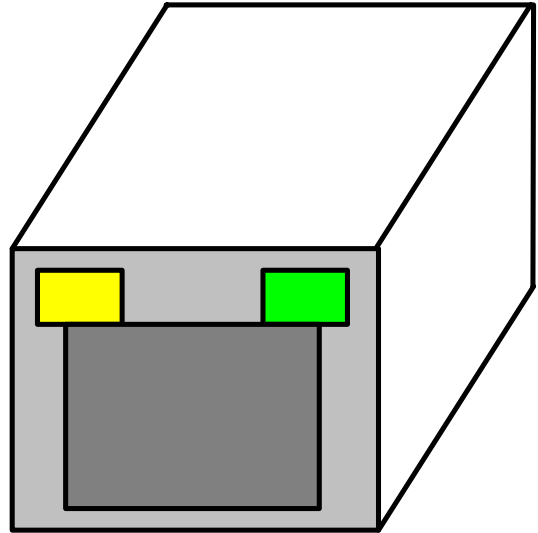

Figure 3.10 I/O Board RJ-45 for Ethernet port

CN 3 : USB Client port

Pin	Signal
1	USB_VCC5
2	SA_BUSB_DNR
3	SA_BUSB_DPR
4	GND

rij

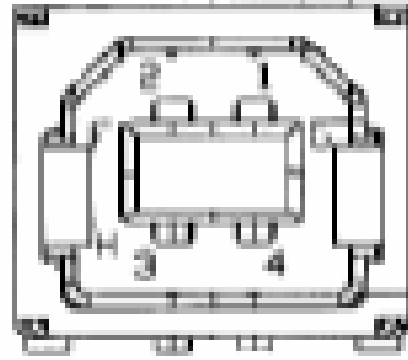
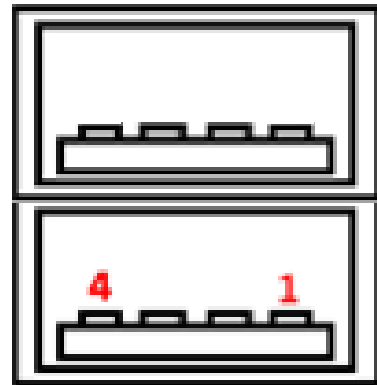

Figure 3.11 I/O board USB client port

CN 1 : USB Host port

Pin	Signal
1	VCC_USB_H1
2	USB_N1
3	USB_P1
4	GND
5	VCC_USB_H2
6	USB_N2
7	USB_P2
8	GND



3.12 I/O Board USB Host port

CN 9 : Power Connector

Pin	Signal
1	19 VDC (+)
2	19 VDC (-)
3	GND

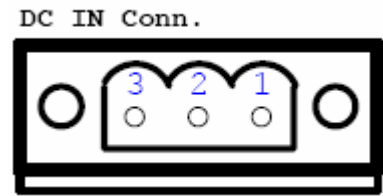

Figure 3.12 I/O Board Power connector

CN 10 : Power source to Main Board

Pin	Signal
1	GND
2	GND
3	DC in
4	DC in

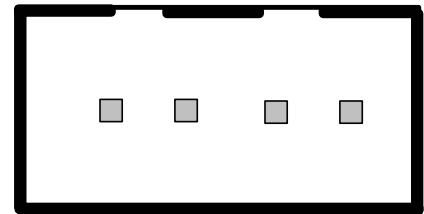

Figure 3.13 I/O Board Power source to main board

CN 7 : Multi-function I/O header (I)

Pin Number	Pin function	Ps.
1	UART1_RDCD	
2	UART1_RRXD	
3	UART1_RTXD	
4	UART1_RDTR	
5	GND	
6	UART1_RDSR	
7	UART1_RRTS	
8	UART1_RCTS	
9	UART1_RRI	
10	IO_VCC3P3	
11	C950_485_RTXP	
12	C950_485_RTXN	
13	GND	
14	GND	
15	SPK_OUTRP	
16	SPK_OUTLP	
17	USB_VCC5	
18	GND	
19	SA_BUSB_DPR	
20	SA_BUSB_DNR	

CN 8 : Multi-function I/O header (II)

Pin Number	Pin function	Ps.
1	AC97_AGND	
2	AC97_AGND	
3	TPRX100N	
4	TPRX100P	
5	TPTX100N	
6	TPTX100P	
7	nSPEED100	
8	nLINK	
9	AC97_AGND	
10	AC97_AGND	
11	IO_VCC3P3	
12	IO_VCC3P3	
13	VCC_USB_H1	
14	VCC_USB_H2	
15	USB_P1	
16	USB_N1	
17	USB_P2	
18	USB_N2	
19	AC97_AGND	
20	AC97_AGND	

3.3 Power system

The power system of the SPC-57 includes IO board, adapter and power cord.

Users can only use a Terminal Block 5.08mm 3P MALE 19Vdc power adapter to be SPC-57's power input. There is one 3.0V, coin-type rechargeable backup battery on SPC-57. This coin battery is mainly for external RTC of the PCM-7230. When the power switch is on, the external DC power will automatically charge this coin battery.

4

Software Functionality

This chapter details the Windows®
CE.NET operating system on the

Sections include:

- Introduction
- Windows® CE Startup Procedure
- Upgrade Procedure
- Utilities
- Network
- Intel Persistent Storage Manger
- Application Program Development
- Windows® CE.NET 4.2 Require Components

4.1 Introduction

The SPC series is one embedded system with Windows® CE.NET OS. The Windows® CE.NET is a compact OS that occupies less storage space or system resources compared with other operating systems such as Windows® NT or Windows® XP. By its modular nature, it is possible to choose those functions that are useful for specific application. Not only reducing the system resources required, but also reduces start-up time. In the field of embedded applications, this is an appealing feature because the impact of downtime would be minimized.

Furthermore, the small storage space it needs makes OS on solid-state disk possible, which implies higher robustness to harsh environments.

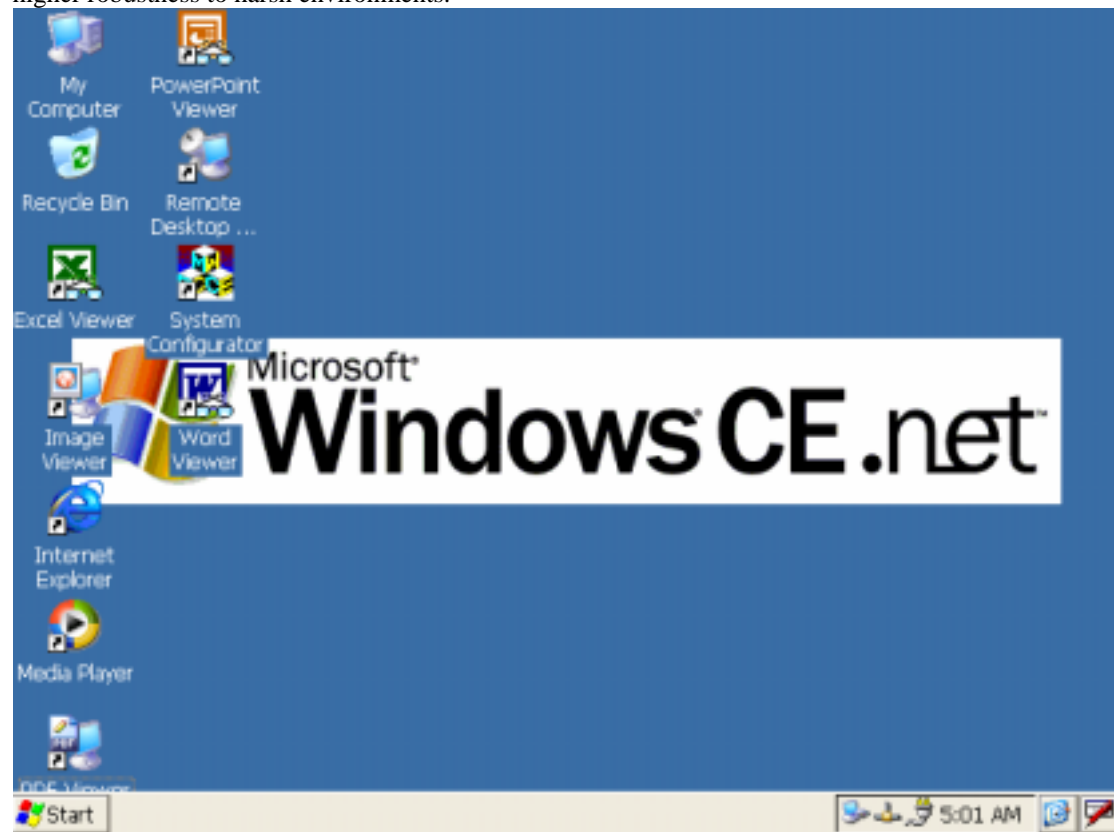

Figure 4.1 Windows® CE.NET on the SPC Series

4.2 Windows CE Startup Procedure

Windows CE can be loaded by two methods, first is by Compact Flash card, and second is by on-board flash chip. Compact Flash card is high boot priority than on-board flash chip. In BOOTLOADER criteria, it will first read the Windows CE image in Compact Flash card. If Compact Flash card is unavailable or no Windows CE image inside, BOOTLOADER will load the Windows CE image from on-board flash chip. BOOTLOADER copy Windows CE image to DRAM and launch WinCE from DRAM, whenever loaded by Compact Flash card or on-board flash chip.

Therefore, there are some advantages,

1, Easy Windows CE image installation: Customer can copy Windows CE image they

want to Compact Flash card, and then load this image by BOOTLOADER.

2, Flexible Hardware design : Flash on board design is unnecessary. The Windows CE can be loaded by Compact Flash card.

4.3 Upgrade Procedure

After the OS image was built, we may want to burn it to the on-board flash ROM. Advantech provides the upgrade utility “Upgrade” to upgrade Bootloader image, WinCE image or boot logo to onboard flash ROM. The upgrade procedure is described as following :

Step1. Copy “Upgrade” utility and image files you want (for example, NK.NB0, EBOOT.NB0, and WINDOWSCE.BMP) to CF storage card.

Note : NK.NB0 is WinCE image.

EBOOT.NB0 is Bootloader image.

WINDOWSCE.BMP is boot bitmap.

Step2. Insert CF storage card to platform, and then launch Upgrade.exe.

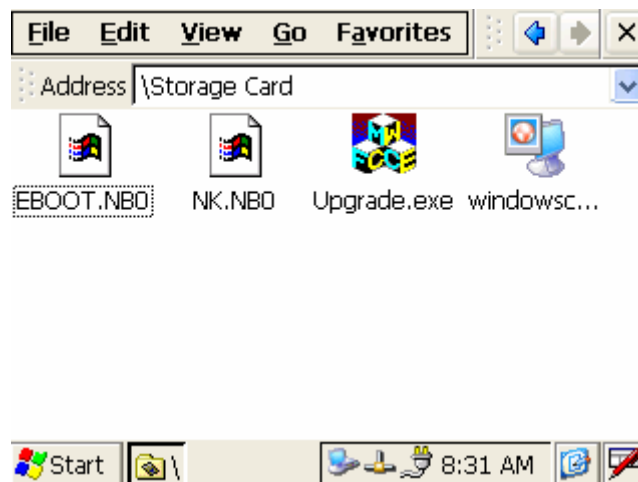

Figure 4.2 Image files and upgrade utility in CF storage card

Step3. Check the items you want to upgrade as the figure shown below. If you want to upgrade boot logo, you can input the path of the bitmap file in the edit box or click ‘Browse’ button to select the file.

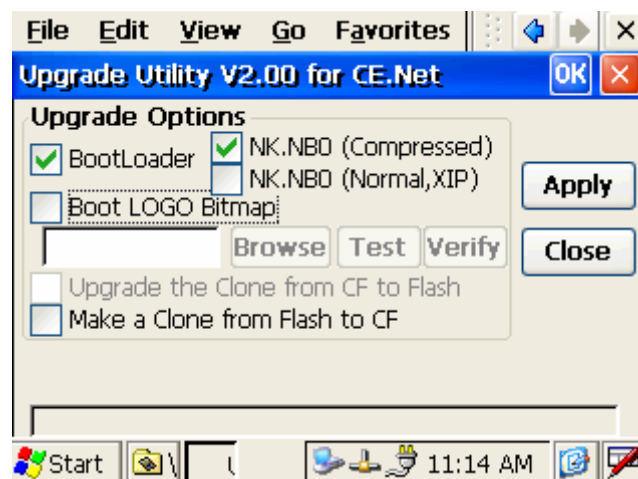

Figure 4.3 Upgrade utility

Note: The difference between NK.NB0 (Compressed) and NK.NB0 (Normal, XIP) : The option “NK.NB0 (Normal, XIP)” means that the nk.nb0 will be upgraded directly to the flash ROM, and “NK.NB0 (Compressed)” means that we compress nk.nb0 first, and then write the compressed data to the flash ROM. :

- (1) Boot time : compressed image take more time in system bootup.
- (2) IPSM size : compressed OS image would result in larger IPSM size.

Step4. Press ‘Apply’ button on the dialog. Then the items you select will be upgraded to the flash ROM. See Figure 4-4.

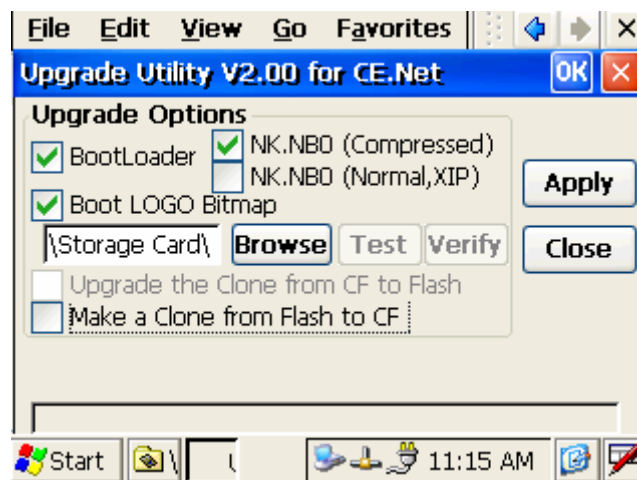

Figure 4.4 Press Apply button in order to upgrade onboard flash ROM After the upgrade process done, to power off platform and power on it. On the first time boot, it will take about 1 minute to format the IPSM.

4.4 Utilities

There are several useful utilities added in the standard Windows® CE.NET OS:

4.4.1 Regflash

The utility "Regflash" is a convenient tool to save, overwrite or delete registry data, as well as erase the content of IPSM folder. From the Windows® CE.NET status bar, tap "Start/Run". Use the soft-keyboard to type "regflash" command in the command text box and press "OK". There are four selections here:

Save to Flash, Delete from Flash, Save to CF Disk, Erase IPSM.

Choose the options you want and press "Save" button to proceed. "Save to Flash" option was used to save the registry setting to on board flash ROM. In contrast, "Delete from Flash" option was intended to erase the on board registry data. "Save to CF Disk" option would save the registry data to CompactFlash card as a file "wince.reg". "Erase IPSM" option erase the IPSM region of the on board flash.

Note: Please be careful using this utility "Regflash". This utility is able to overwrite all registry data.

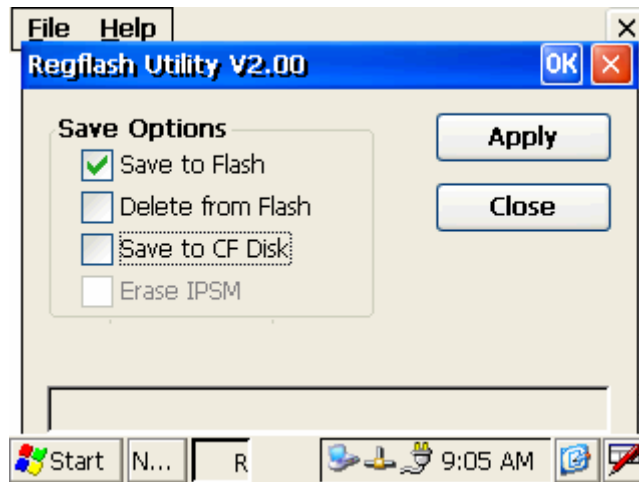

Figure 4.5 Regflash utility

It is important to keep the power normal during "Save to Flash" process. If the power were broken down during the registry saving process, then the registry would be lost and corrupted. On the next time you turn on platform, the system would load the default registry setting rather than the previously customized registry setting.

4.4.2 Reboot

The utility "Reboot" is a convenient tool to reset the system. From the Windows® CE.NET status bar, tap "Start/Run". Use the soft-keyboard to input "reboot" command in the command text box and press "OK". The other ways to reboot are clicking the "Reboot" button on the Watchdog page of the built-in utility System Configurator and hardware reboot button.

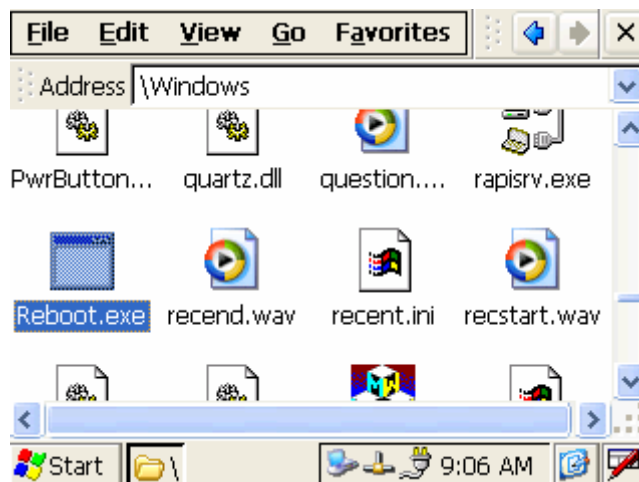

Figure 4.6 Reboot the system

4.4.3 Startup execution

The SPC has one useful function call "Startup execution". After the system boot up, the startup execution function would automatically perform. This function is useful for control system to do the initialization processes or some other procedures. In SPC,

there are two ways to perform "Starup" function.

Method 1:

Step1: Create "startup" directory in CF storage card or in folder "\IPSM\".

Step2: Copy executable files to "startup" directory that is created by Step 1.

Example:

We copy two executable files "REGFLASH.exe" and "Notepad.exe" in "\IPSM\Startup", and then reboot the system. After the system boot up, the two executable files would automatically execute.

Method 2:

Step1: The same as Step1 in Method 1.

Step2: Create a file called "startup.ini" in "startup" directory. Type in the commands you want to execute after boot up in that file.

Example:

Create "Startup.ini" in "\IPSM\Startup" directory and reboot the system. The content of startup.ini was listed below:

```
\windows\tty.exe
```

```
\windows\registry.exe
```

After the system reboot, "\windows\ tty.exe" and "\windows\ registry.exe" would automatically execute. Be sure that the two methods are independent. It means they can be used simultaneously.

4.4.4 Safemode

SPC allow user to alter registry setting, and save it by either "regflash.exe" or the registry frame of the "Misc" page of the System Configurator. But sometimes user may make some non-appropriate registry setting, and cause SPC fail to boot. In the circumstance, the easiest way to boot up SPC is to use the default registry setting from the Windows[®] CE.NET image. When the SPC is booted up with the default registry setting, we say that it is working in "safemode". To enter "safemode", user must perform several steps as described below:

Step 1: Create a file whose filename is "safemode" or a folder whose name is "safemode" in the CompactFlash card.

Step 2: Insert the CompactFlash card into the SPC series platform.

Step 3: Turn on the power switch of SPC series platform.

4.4.5 System Configurator

System Configurator is an outstanding utility designed by Advantech Windows® CE.NET software team. It is an integrated environment where user can get useful system information as well as configure favorite system settings and apply system control function on demand. Double click the icon of System Configurator on the desktop. Following sections illustrate the functions of System Configurator.

4.4.5.1 General

The memory information including DRAM, CF Disk and IPSM FLASH are displayed in the General page. And the versions of each part of the installed embedded OS, including Windows® CE.NET, Registry, Bootloader and System Configurator respectively.

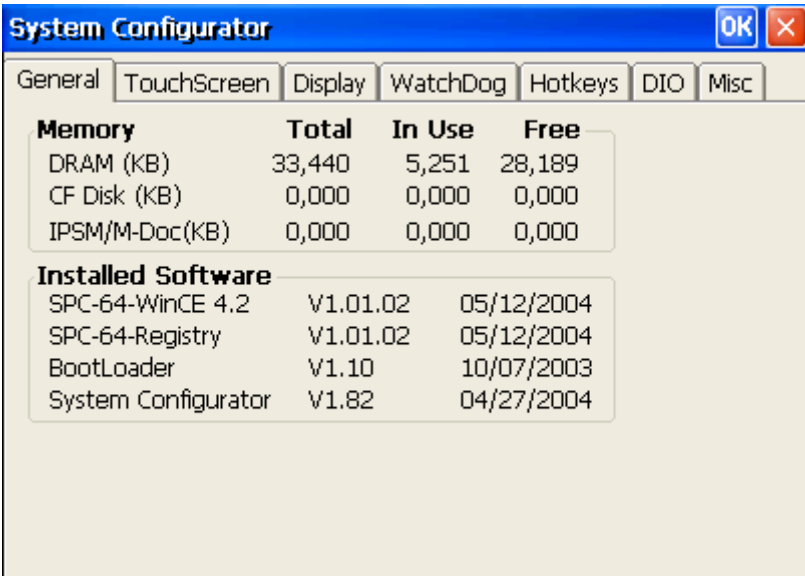

The screenshot shows the 'System Configurator' window with the 'General' tab selected. It displays two tables: 'Memory' and 'Installed Software'.

Memory	Total	In Use	Free
DRAM (KB)	33,440	5,251	28,189
CF Disk (KB)	0,000	0,000	0,000
IPSM/M-Doc(KB)	0,000	0,000	0,000

Installed Software	Version	Date
SPC-64-WinCE 4.2	V1.01.02	05/12/2004
SPC-64-Registry	V1.01.02	05/12/2004
BootLoader	V1.10	10/07/2003
System Configurator	V1.82	04/27/2004

Figure 4.7 General information

4.4.5.2 Calibration

The Touch-screen page provides the calibration function. Click the "calibration" button, the "Stylus Properties" windows would appear. Then click "calibrate" button in the Stylus Properties window to enter calibration process. In the calibration process, user taps on the center of the target on the screen then the target will move to the next position. After calibration, press "OK" to leave Stylus Properties window, and then the Regflash utility process would automatically start to save the registry setting.

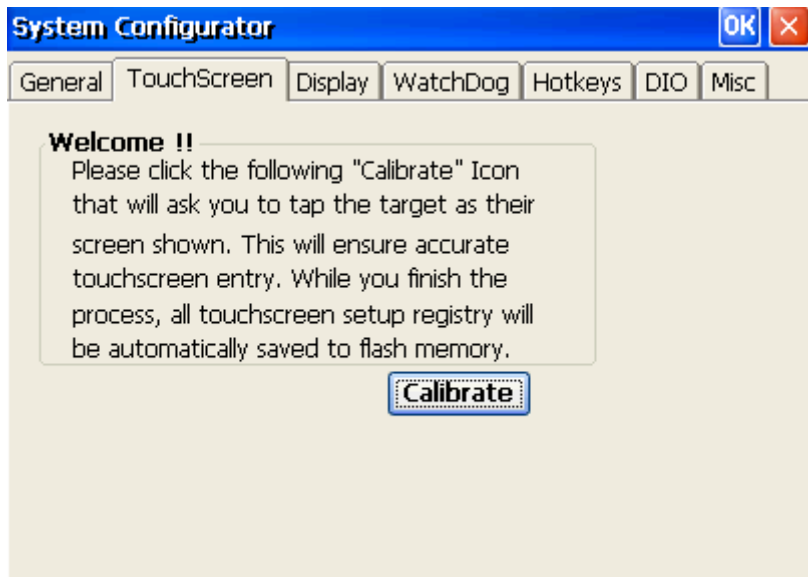

Figure 4.8 Touch-screen calibration

4.4.5.3 Display

From time to time it is unnecessary to turn on the display attached to the SPC all the day. The Display page provides several frequently used functions such as turning off the LCD and backlight to elongate the display repair period, adjusting brightness or contrast. For example, if user wants the backlight turn-off setting function, he can press "setting" button. Then the backlight page of Display Properties of Control Panel will appear on the screen. Besides, user can click the "Off Now" button to turn off the backlight of the display panel immediately without waiting. Once the backlight was turned off, there were three inputs to turn it on: (1) mouse; (2) keyboard; (3) touch-screen; user can use any one of them to turn on the display. The lower "Brightness" and "Contrast" blocks have scroll bars by which users can tune brightness level of TFT LCD or the contrast level of passive matrix LCD.

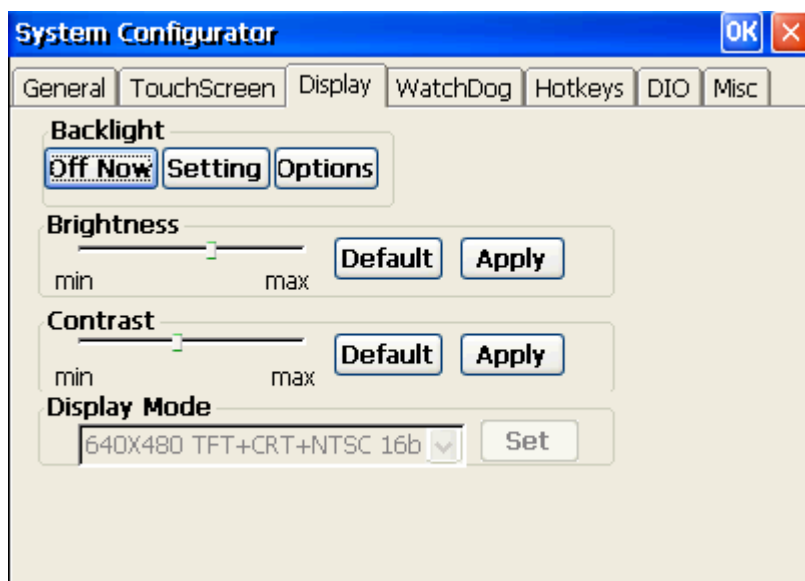

Figure 4.9 Display configuration

4.4.5.4 WatchDog timer

It is important in industrial applications that the control systems are rarely crashed, or are capable of self-reset if they are halted somehow. Watchdog function of automatic resetting system is therefore provided in SPC. There is a timer inside the watchdog function. User's AP could invoke the associated APIs in Watchdog function to start the timer, then Watchdog function would repeat the countdown of the specified period of time to reboot the system if the user's AP does not clear the timer in time periodically. The Watchdog function in the SPC provides eight different time intervals: 2 seconds, 5 seconds, 10 seconds, 30 seconds, 60 seconds, 2 minutes, 5 minutes and 10 minutes. The "Enable" button is used to simulate the Watchdog function. Detail programming guide is illustrated at section 4.7.5. The "Sleep" button could make the system enter suspend mode as "Suspend" of "Start" could. Press the "SoftReset" button will cause system warm boot that clears DRAM, reloads all drivers and refresh the newest registry settings. Press the "REBOOT" button will cause the system cold boot.

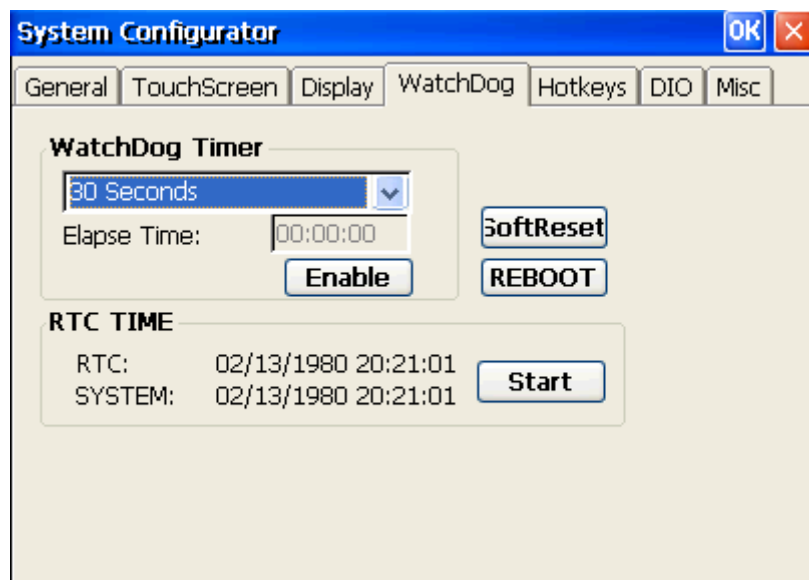

Figure 4.10 Watchdog timer

4.4.5.5 Hotkeys

There are 8 Hotkeys reserved for users on the SPC. These Hotkeys are assigned to invoke different application programs as defaults:

- Hot key 1: invokes Windows Explorer
- Hot key 2: invokes Advantech homepage
- Hot key 3: invokes System Configurator
- Hot key 4: invokes Windows Media Player
- Hot key 5: invokes Control Panel
- Hot key 6: invokes Command prompt
- Hot key 7: invokes Calibration dialog
- Hot key 8: invokes repllog.exe

These settings can be freely revised by keying in new paths in the edit boxes.

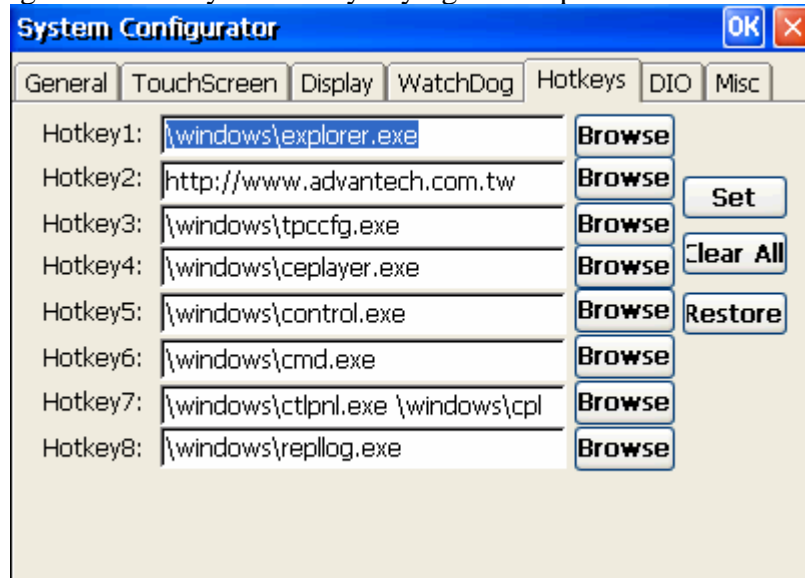

Figure 4.11 Hotkeys setting

4.4.5.6 DIO

There are 8 digital inputs and 8 digital outputs. This DIO page of the System Configurator can show their status. When the “Start” button is pressed, the 8 DI will try to retrieve external inputs, then those pins having positive inputs will mark respective radial buttons inside the “Digital Input Status” block, others will make their radial buttons empty. On the other hand, when users use mouse, finger or stylus to check some of the 8 check boxes, the level of the related DO pins will be changed to positive level. The DO pin status will sustain until users change them again.

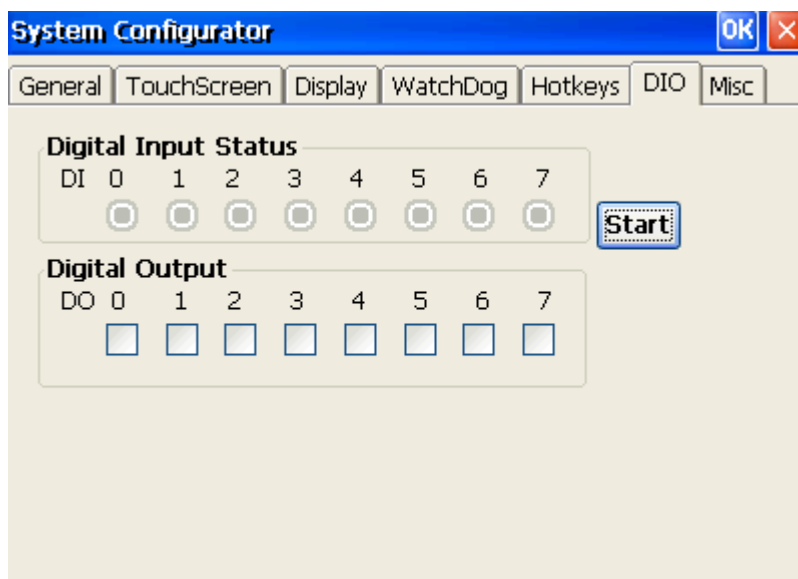

Figure 4.12 DIO setting

4.4.5.7 Miscellaneous

The Misc page provides several functions as described below. The "Registry" block provides registry save and registry view function. The "A. Sync" button invokes ActiveSync to the host computer. The "HTTP Server Root" block was used to specify the root directory of http server. The default directory is "\windows\www\wwwpub", user can specify another directory by type the directory in the edit box and press "Set" button. The new setting would become effective after the system reboot. The "CF Disk Folder Name" block specifies the folder name of the storage card inserted. The default name is "Storage Card". User can specify another directory by type the directory in the edit box and press "Set" button. The new setting would become effective after the system reboot. The "MAC ID" block shows the network MAC address. The "COMM" block provides the communication functions, including IPConfig and Pinging Yahoo.

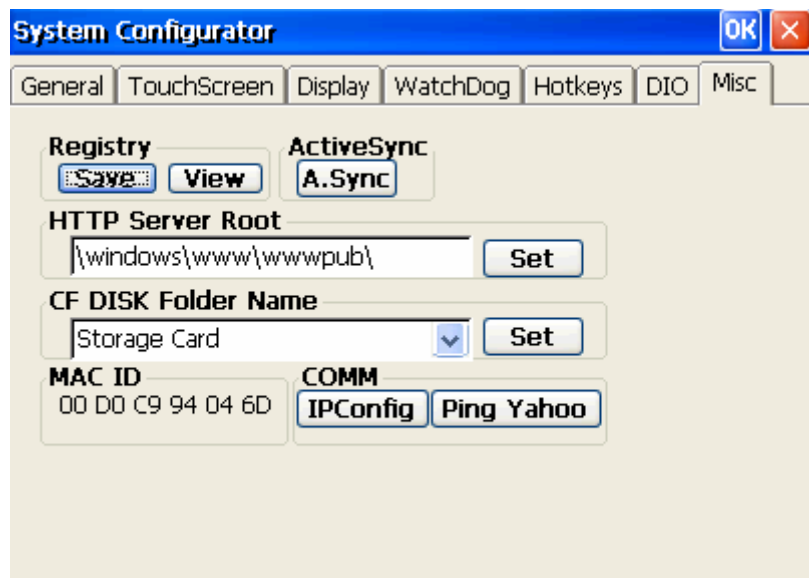

Figure 4.13 Miscellaneous settings

4.5 Network

4.5.1 Networking via Ethernet

SPC build in one 100Base-T Ethernet controller. It appears at “Control Panel/Network and Dial-up Connections” via “DM9CE1”. User can configure its Ethernet support as follows:

1. Click "Start/Settings/Control Panel"
2. Double click "Network and Dial-up Connections"
3. This window will display all available connections. Pressing the connection icon, its pop-up menu appears and users could disable, rename or modify properties from there.
4. If the SPC is a node of the LAN with DHCP servers, it is now available.
5. If the SPC is a node of the LAN with fixed IP, the user has to consult with MIS to get specific IP addresses. Then fill them into the associated fields of the Properties Dialog that could be popped up by the properties item of the step 3 above. Then use the "Regflash" utility to save this changed registry. Reboot the system, the Ethernet functions would be available as previous configuration.

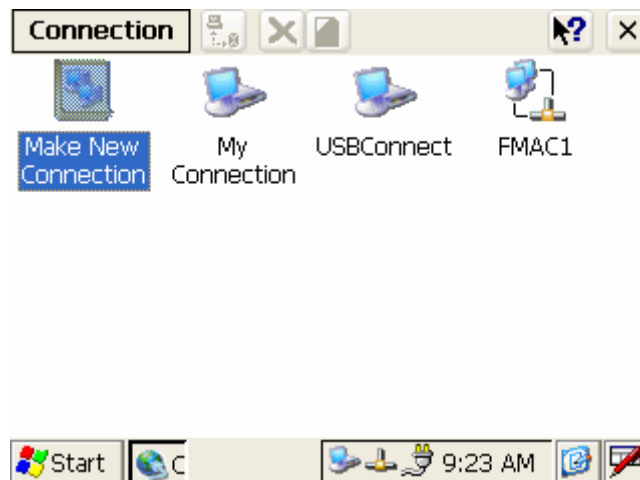

Figure 4.14 Networking via Ethernet

4.5.2 Networking via USB port

The SPC supports USB port direct-connections to host computer. The host computer must install the Microsoft ActiveSync service offered by Microsoft. Use the USB cable to connect the USB ports of them. Then activate ActiveSync service on the host computer. The host will automatically scan the USB ports to make a connection.

1. Make sure the Microsoft ActiveSync service and the Microsoft embedded Visual Tools are properly installed in the host PC.

2. Connect the USB port of the host PC and the SPC by a USB ActiveSync cable.
3. If users are using the Microsoft eMbedded Visual Tools to develop Windows® CE.NET application runtimes, make sure the SPC SDK provided in the SPC support CD is also properly installed in the host PC.
4. Click "Start/Settings/Network and Dial-up Connections"
5. Make a new connection. As the dialogue box pops out, choose the default "Direct Connection" radial button. Click "Next".
6. Select "USB Cable" from the combo box and click "Finish" to complete making new connection. It is recommended to keep the default settings of the ports connection.
7. Click "PC Connection" icon in the Control Panel. As the "PC Connection Properties" dialogue box pops up, change the connection to the newly made connection by clicking the "Change..." button.
8. If the ActiveSync service on the host PC has been activated, the above seven steps will make the SPC automatically try to connect the host, ;otherwise you can invoke "\windows\repllog.exe" to do the activesync connection.

NOTE: Users should properly install the associated USB driver on the host computer while plugging in the SPC as a USB client device at the first time.

NOTE: The USB driver--wceusbsh.inf and wceusbsh.sys--are included in SPC support CD.

NOTE: Users may also use COM ports to do ActiveSync function thru RS-232 cable.

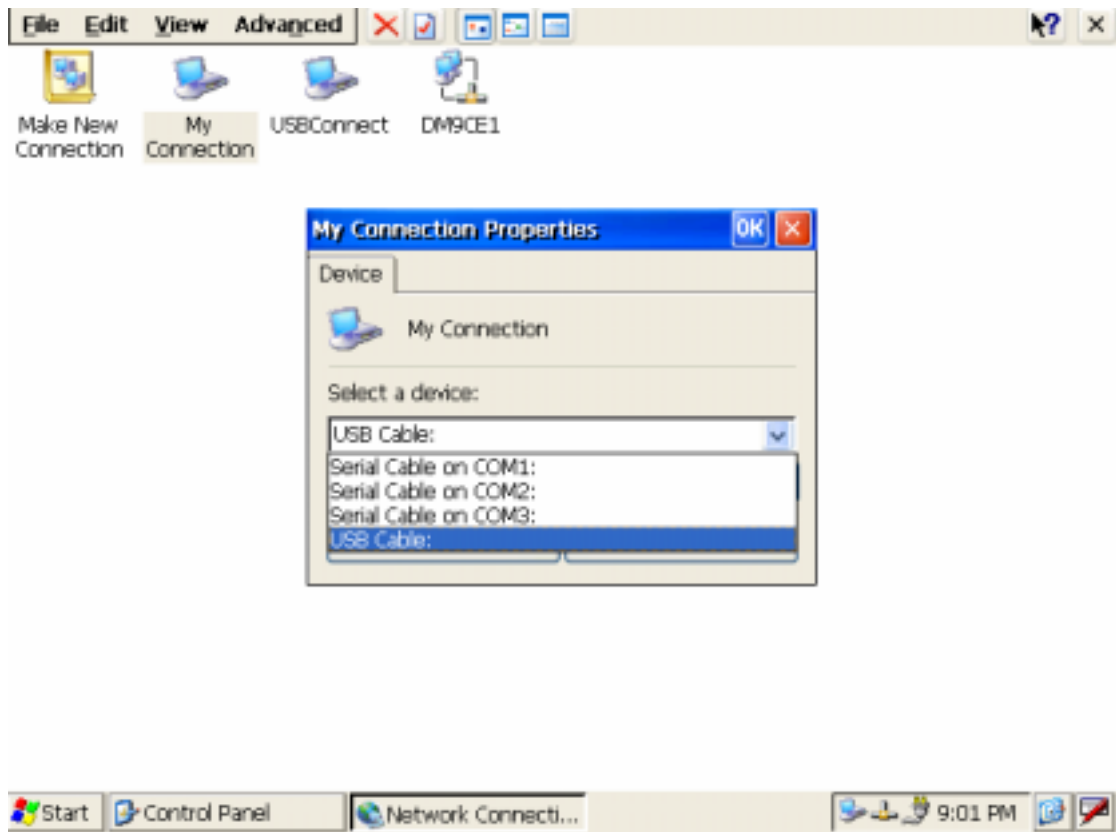

Figure 4.15 Networking via USB port

4.5.3 Networking via PPP

The SPC supports PPP protocol. To setup and utilize it, follow the steps below:

1. Click "Start/Settings/Network and Dial-up Connections"
2. Make a new connection. As the dialogue box pops out, choose the "Dial-Up Connection". Click "Next".
3. Click "Configure" to setup the device according to the specification of your modem, and then click "OK" on the top-right corner of the window.
4. Click "Next". Input the telephone number in the "Phone Number" window. Press "Finish" to complete the setup process.
5. Turn on your modem and use RS-232 cable to connect modem and COM1 of SPC series.
6. Double click the connection you have made in Step 4. Key in the user name, password and domain for the dial-up connection and press "Connect".

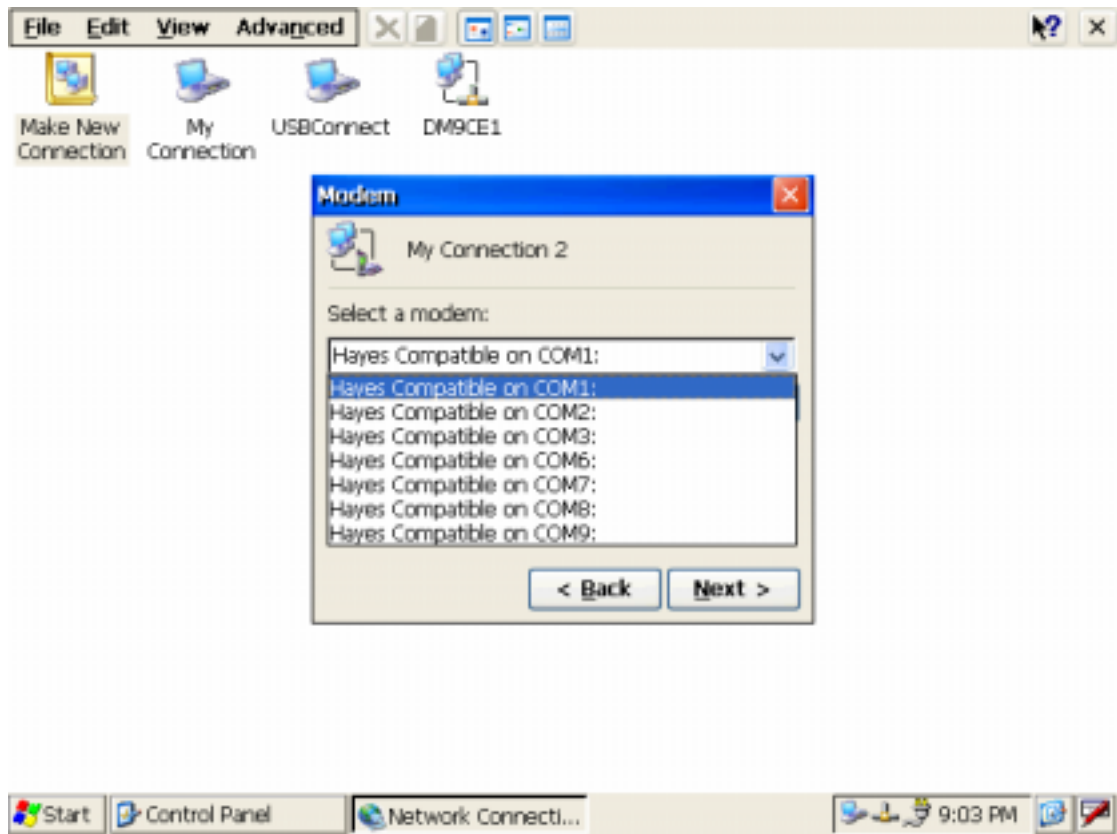

Figure 4.16 Networking via PPP

4.5.4 Web browser

The SPC builds-in Windows CE OS includes IE Browser. It can be used to browse web pages on World Wide Web via LAN or PPP.

4.6 Intel Persistent Storage Manger (IPSM)

4.6.1 Introduction to Intel Persistent Storage Manger

Intel Persistent Storage Manager was designed and developed specifically as an enhancement to Microsoft Windows CE operating systems. IPSM eliminates extra disk-like storage such as storage cards, redundant RAM and ROM.

4.6.2 IPSM folder in SPC Series

SPC uses Intel Persistent Storage Manger to utilize the free space of flash ROM for persistent storage. The IPSM region in the system is located in "\IPSM" directory. Any file or directory stored in "\IPSM" directory would be keep persistently, even if the power of SPC were turned off. The user can store software or data in \IPSM rather in CF card to avoid inconvenience.

4.7 Application Program Development

The SPC is bundled with built-in Windows[®] CE.NET operating system. In real application user need to execute various application programs on it. However, unlike its other CPU family, the Windows[®] CE.NET is a hardware-dependent operating system. That is to say, Windows[®] CE.NET application programs are only portable in the source code level. Users must rebuild the runtime file for a different Windows[®] CE.NET platform even though the source code may not be changed at all.

4.7.1 System requirements

- Intel[®] Pentium-90 CPU or more advanced
- Microsoft[®] Windows[®] 2000 Professional or Windows[®] XP
- Microsoft[®] eMbedded Visual Tools 4.0
- Platform SDK for SPC
- 64MB DRAM
- CD-ROM drive
- Monitor with VGA resolution at least
- Mouse
- 200MB free hard disk space at least
- SPC series platform
- Let the host PC and SPC connect on the same LAN to do kernel debugging if necessary
- USB cable (bundled in the standard SPC series)

4.7.2 Building Windows CE program

By the platform SDK bundled with the standard SPC, users can build the Windows CE runtime application program by the eMbedded Visual Tools.

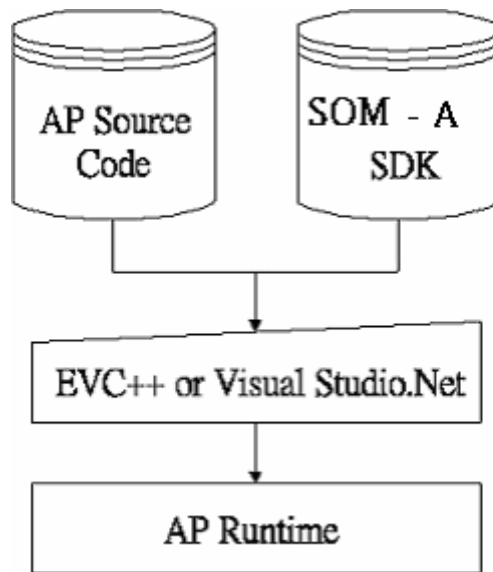

Figure 4.17 Flow-chart of Building Windows® CE.NET runtime

4.7.3 How to install SDK

Copy SPC SDK file “SOM_A_SDK.msi” to your PC, and launch it. You can install SDK by steps.

Step 1, Launch SPC SDK file, and then tap Next button.



Figure 4.18

Step 2, Accept License Agreement and go next.

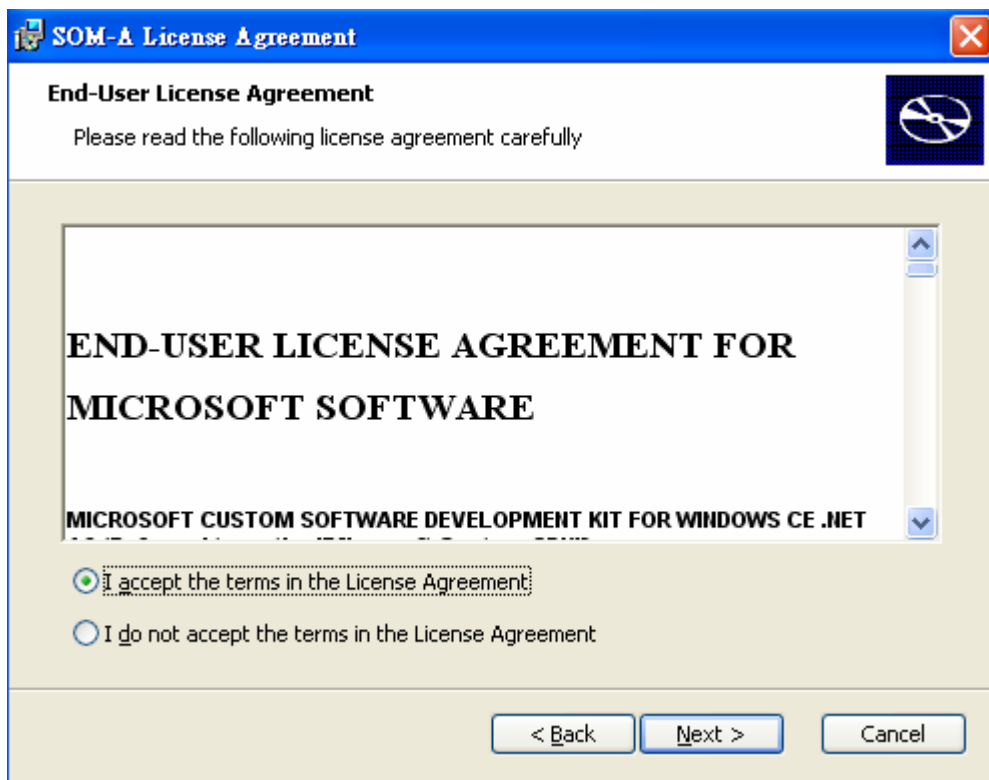

Figure 4.19

Step 3, Key in your information and go next.

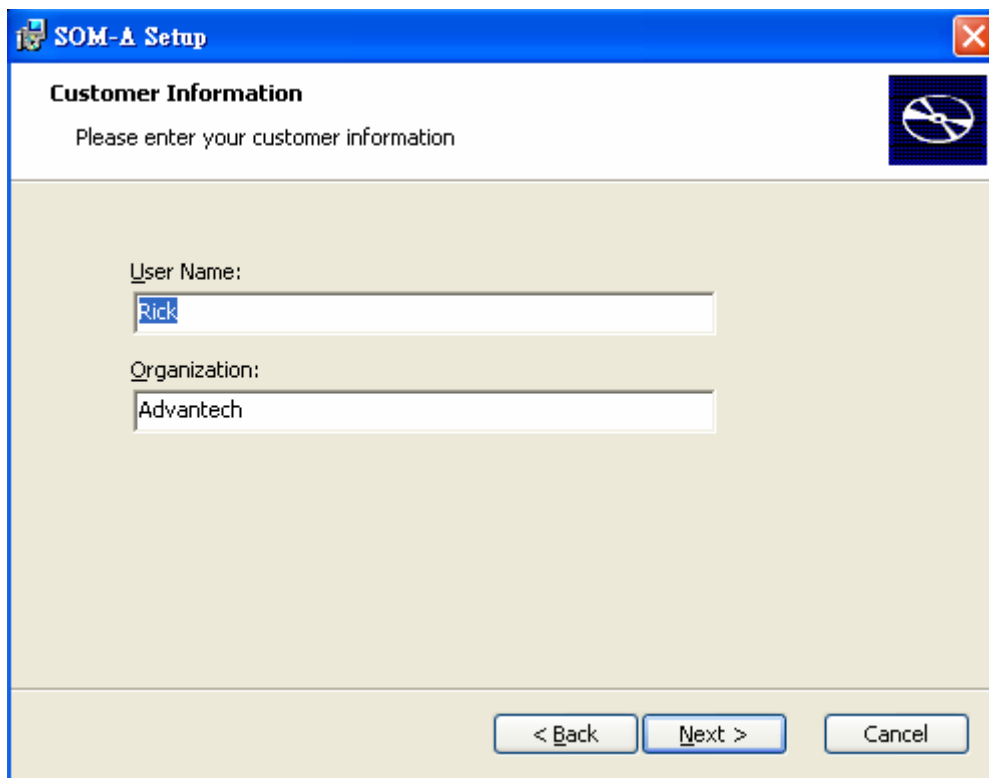

Figure 4.20

Step 4, Choose setup type.

There are 3 options “Embedded Visual C++”, “Microsoft .NET Compact Framework”, and “Documentation” in Custom Setup.

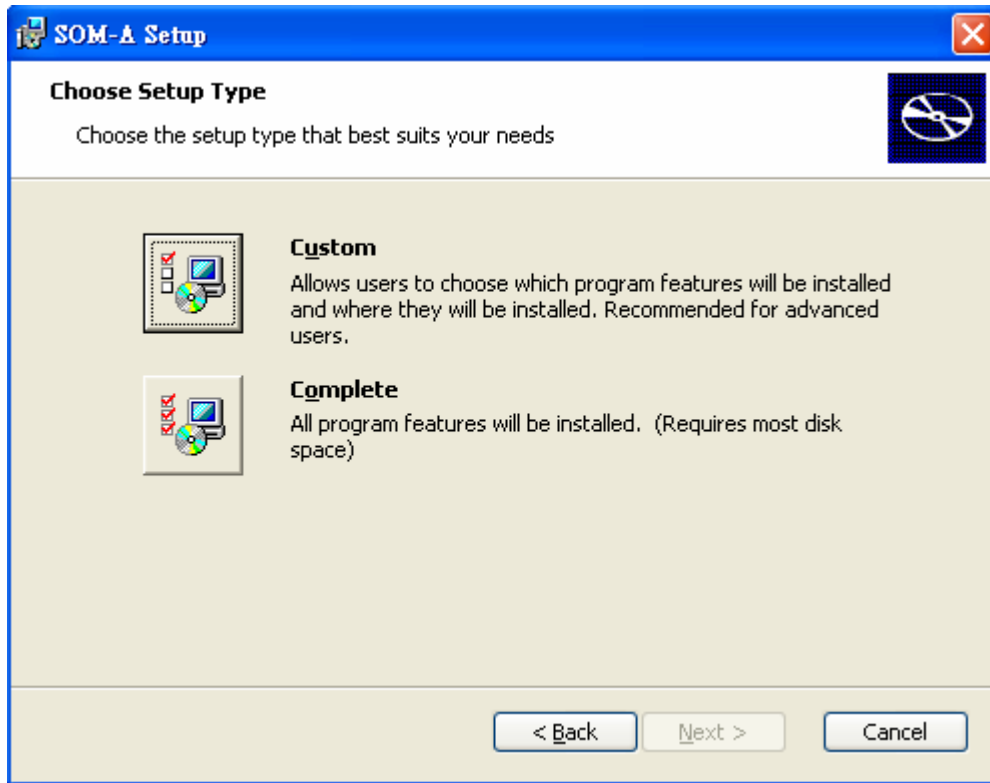

Figure 4.21

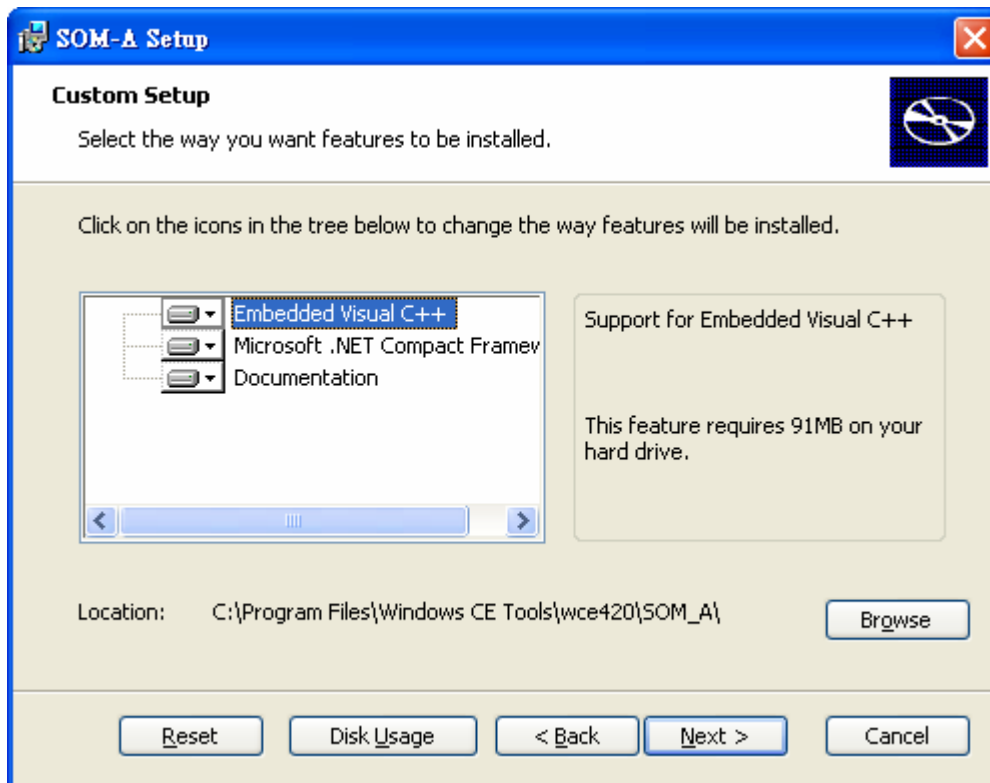

Figure 4.22

Step 5, Tap “Install” button to install SDK.

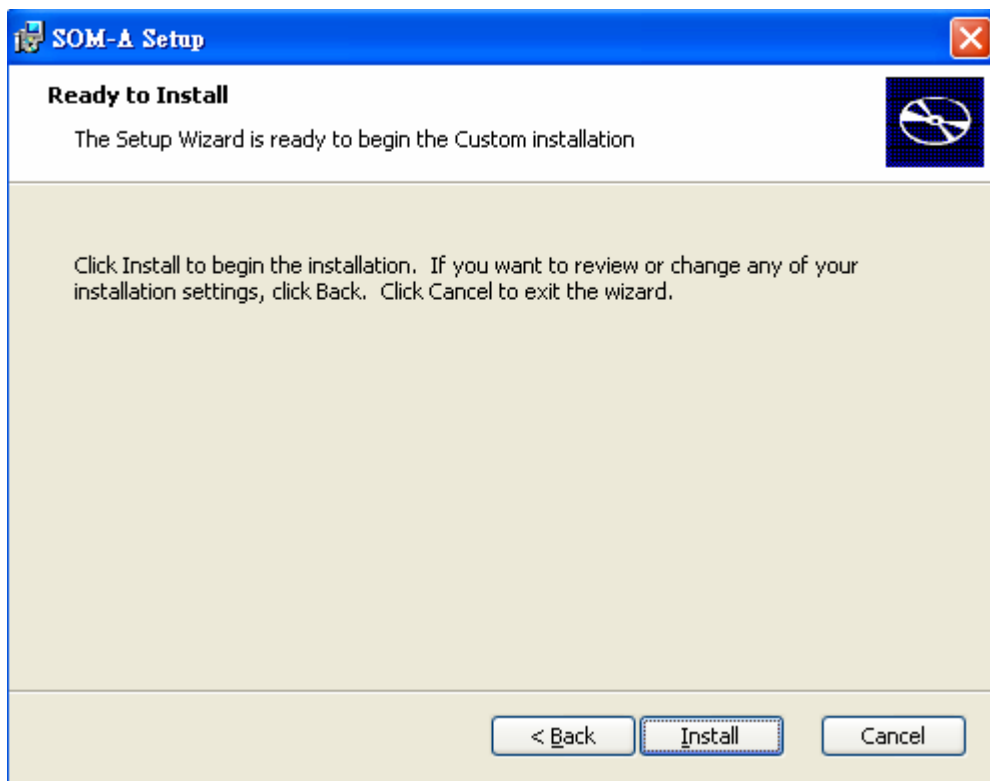

Figure 4.23

Install SDK.....

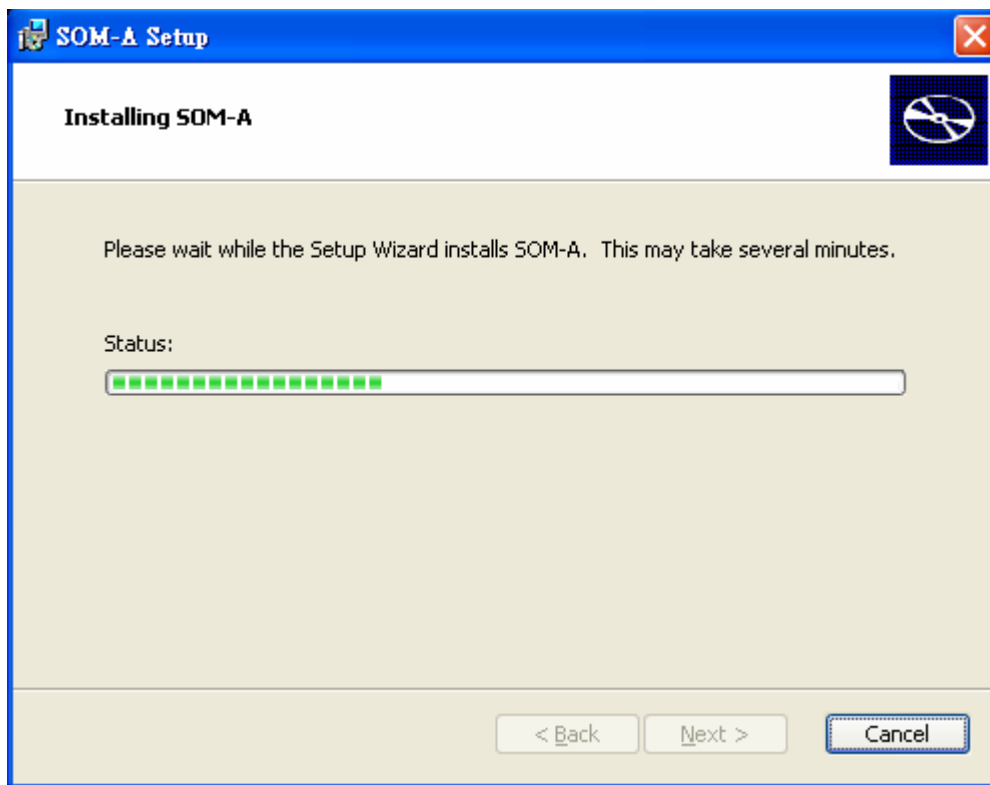

Figure 4.24

Step6, Finish installing.

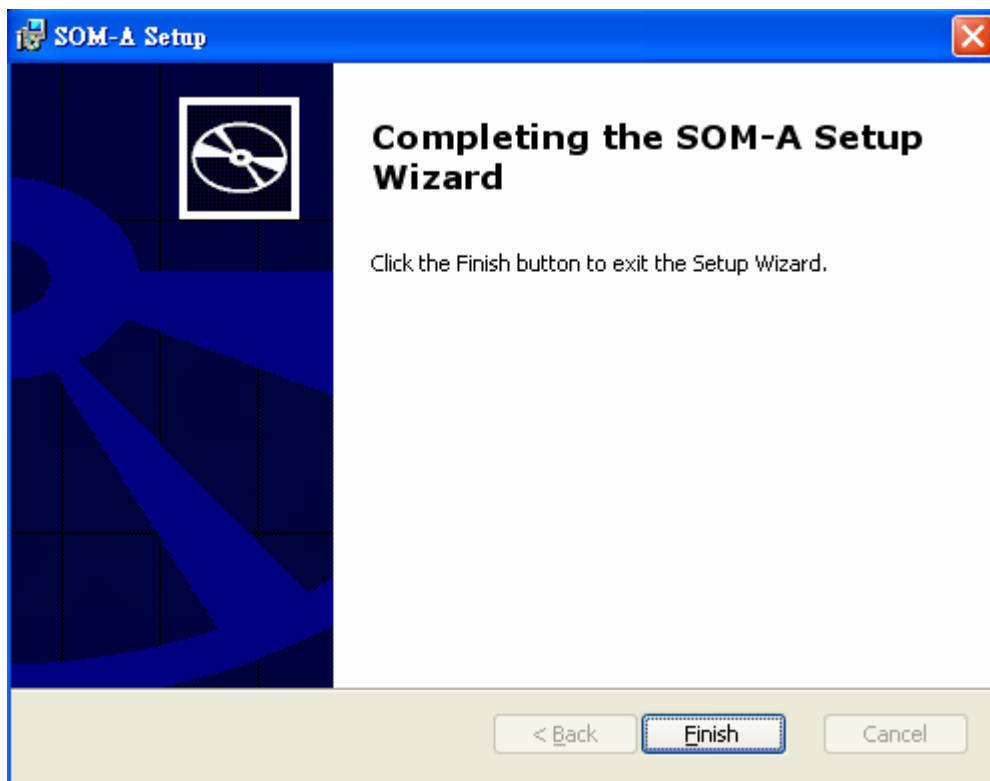

Figure 4.25

4.7.4 Running your application programs

ActiveSync would automatically transfer the built application program to platform. Choose SDK type as SOM_A once compile your application program.

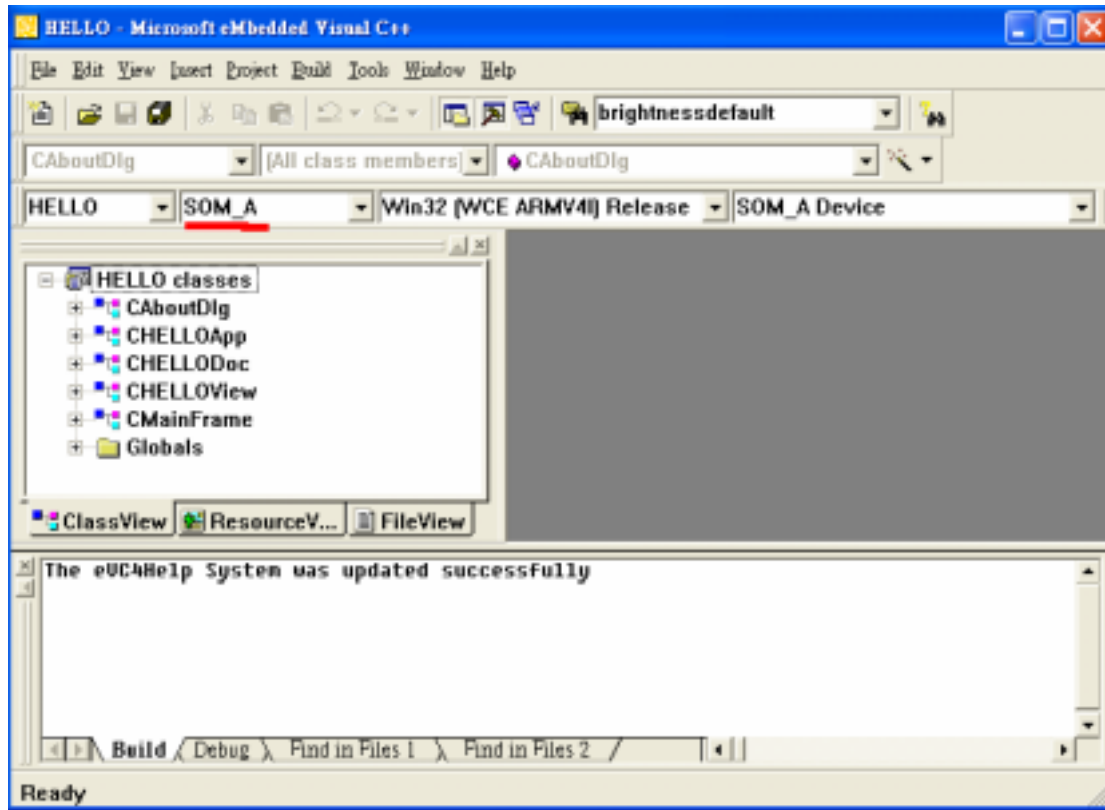

Figure 4.26

4.7.5 WDT Modules

SPC is targeted to be the embedded device for web-enabled and data-acquisition systems. It is built-in with a useful dynamic link library, WATCHDOG.DLL, which has been designed to help AP developer easily implement his requirements of handling the system resources such as Watchdog timer and LCD brightness control etc. Programmers who are familiar with WIN32 API programming would feel very easy to use this DLL to create his functions. The DLL make its device services look as a file whose name is "WDT1:". The programmer could use this file name in "CreateFile()" to open it and get the file handler. Then the following controls of user required device services would be achieved by way of the file handler in one function call of "DeviceIOControl()". At most 5 applications can access watchdog timer simultaneously. The DeviceIOControl function is following:

- DeviceIoControl

This function sends a control code directly to a specified device driver, causing the corresponding device to perform the specified operation.

```
BOOL DeviceIoControl(  
  
HANDLE hDevice,  
  
DWORD dwIoControlCode,  
  
LPVOID lpInBuffer,  
  
DWORD nInBufferSize,  
  
LPVOID lpOutBuffer,  
  
DWORD nOutBufferSize,  
  
LPDWORD lpBytesReturned,  
  
LPOVERLAPPED lpOverlapped);
```

- Parameters

hDevice

[in] Handle to the device that is to perform the operation. Call the Create- File function to obtain a device handle.

dwIoControlCode

[in] Specifies the control code for the operation. This value identifies the specific operation to be performed and the type of device on which the operation is to be performed. No specific values are defined for the dwIo- ControlCode parameter. However, the writer of a custom device driver can define IOCTL_XXXX control codes, per the CTL_CODE macro.

These control codes can then be advertised, and an application can use these control codes with DeviceIoControl to perform the driver-specific functions.

lpInBuffer

[in] Long pointer to a buffer that contains the data required to perform the operation.

This parameter can be NULL if the dwIoControlCode parameter specifies an operation that does not require input data.

nInBufferSize

[in] Size, in bytes, of the buffer pointed to by lpInBuffer.

lpOutBuffer

[out] Long pointer to a buffer that receives the operation's output data.

This parameter can be NULL if the dwIoControlCode parameter specifies an operation that does not produce output data.

nOutBufferSize

[in] Size, in bytes, of the buffer pointed to by lpOutBuffer.

lpBytesReturned

[out] Long pointer to a variable that receives the size, in bytes, of the data stored into the buffer pointed to by lpOutBuffer.

The lpBytesReturned parameter cannot be NULL. Even when an operation produces no output data, and lpOutBuffer can be NULL, the Device-IoControl function makes use of the variable pointed to by lpBytesReturned. After such an operation, the value of the variable is without meaning.

lpOverlapped

[in] Ignored; set to NULL.

- Return Values

Nonzero indicates success. Zero indicates failure. To get extended error information, call GetLastError.

WDT Control Codes

There are 8 control codes for the operation codes in the WDT1 driver:

1. IOCTL_ENABLE_WDT (0x1001):

Enables the Watchdog timer on your application. Your application must trigger to Watchdog timer by IOCTL_ACCESS_WDT interface during specified period, otherwise the device will reboot automatically

lpInBuffer : unused.

nInBufferSize: unused.

lpOutBuffer: unused.

nOutBufferSize: unused.

2. IOCTL_DISABLE_WDT (0x1002):

Disable the Watchdog time on your application.

lpInBuffer : unused.

nInBufferSize: unused.

lpOutBuffer: unused.

nOutBufferSize: unused.

3. IOCTL_GET_WDTPERIOD (0x1003):

lpInBuffer :unused.

nInBufferSize: unused.

lpOutBuffer: the DWORD pointer to your Watchdog time setting. The unit is mini-second. Its value should be greater 1000. The default setting is 5000 mini-seconds.

nOutBufferSize: unused.

4. IOCTL_SET_WDTPERIOD (0x1004):

lpInBuffer : the DWORD pointer to your Watchdog time setting. Its value should be greater 1000. The unit is mini-second. If your application opens the WDT driver, the default Watchdog timer is set to 5000 mini-seconds.

nInBufferSize:.unused.

lpOutBuffer: unused.

nOutBufferSize: unused.

5. IOCTL_ACCESS_WDT (0x1005):

Your application must trigger the Watchdog once during your Watchdog timer period. If your application has not trigger at the specified period, the device will reboot automatically.

lpInBuffer :unused.

nInBufferSize:.unused.

lpOutBuffer: unused.

nOutBufferSize: unused.

6. IOCTL_GET_SCREENOFFTIME (0x1006):

lpInBuffer :unused.

nInBufferSize: unused.

lpOutBuffer: the DWORD pointer to your screen off time if user-interface idled. The unit is mini-second. If the value is 0, screen-off function is disabled.

nOutBufferSize: unused.

7. IOCTL_SET_SCREENOFFTIME (0x1007):

lpInBuffer : the DWORD pointer to your screen off time if user-interface idled. The unit is mini-second. If the value is 0, screen-off function is disabled.

nInBufferSize:unused.

lpOutBuffer: unused.

nOutBufferSize: unused.

8. IOCTL_SET_SCREENOFF (0x1010):

Set the LCD power off immediately.

lpInBuffer : unused.

nInBufferSize:.unused.

lpOutBuffer: unused.

nOutBufferSize: unused.

Examples:

```
#define IOCTL_ENABLE_WDT          0x1001
#define IOCTL_DISABLE_WDT        0x1002
#define IOCTL_GET_WDTPERIOD      0x1003
#define IOCTL_SET_WDTPERIOD      0x1004
#define IOCTL_ACCESS_WDT         0x1005
#define IOCTL_GET_SCREENOFFTIME  0x1006
#define IOCTL_SET_SCREENOFFTIME  0x1007
#define IOCTL_SET_SCREENON       0x100F
#define IOCTL_SET_SCREENOFF      0x1010
```

```

HANDLE m_hWDT=NULL;

TCHAR szClassName[60];

...

// assign the WDT driver name

wsprintf(szClassName, TEXT("WDT1:"));

// Open the WDT driver

m_hWDT = CreateFile(szClassName, GENERIC_READ | GENERIC_WRITE, 0,

                    NULL, OPEN_EXISTING, FILE_ATTRIBUTE_NORMAL, NULL);

if ( m_hWDT == INVALID_HANDLE_VALUE )

{

    DebugMsg(CString("WDT driver fail"));

    return;

}

...

DWORD dwTemp;

DWORD nPeriod=10000;

// Set the Watchdog Timer as 10 seconds (10000 mini-seconds)

DeviceIoControl(m_hWDT, IOCTL_SET_WDTPERIOD, &nPeriod, 4, NULL, 0, &dwTemp, NULL);

// Enable the Watchdog timer

DeviceIoControl(m_hWDT, IOCTL_ENABLE_WDT, NULL, NULL, NULL, 0, &dwTemp, NULL);

While (1)

{

    // do your job here...

    Sleep(8000);

    DeviceIoControl(m_hWDT, IOCTL_ACCESS_WDT, NULL, NULL, NULL, 0, &dwTemp, NULL);

}

DeviceIoControl(m_hWDT, IOCTL_DISABLE_WDT, NULL, NULL, NULL, 0, NULL, NULL);

CloseHandle(m_hWDT);

```

4.8 Windows® CE.NET 4.2 Require Components

(Advantech Recommend)

Applications and Services Development (: with; : without)

Feature	Default Selection
Active Template Library (ATL)	
C Libraries & Runtimes	
Component Services (COM)	
Device Management	
Lightweight Directory Access Protocol (LDAP)	
Message Queuing (MSMQ)	
Microsoft Foundation Classes (MFC)	
Object Exchange Protocol (OBEX)	
Pocket Outlook Object Model (POOM) API	
Simple Object Access Protocol (SOAP) Toolkit	
Standard SDK for Windows CE .NET	
.NET Compact Framework	
XML	

Applications – End User

Feature	Default Selection
ActiveSync	
File Viewers	
Help	
Inbox	
Remote Desktop Connection	
Terminal Emulator	
Windows Messenger	
WordPad	

Core OS Services

Feature	Default Selection
Serial Port Support	
Parallel Port Support	
USB Host Support	
Debugging Tools	
Power Management	

Kernel Features	
-----------------	--

Communication Services and Networking

Feature	Default Selection
Networking Features	
Networking - Local Area Network (LAN)	
Networking - Personal Area Network (PAN)	
Networking - Wide Area Network (WAN)	
Servers (HTTPD)	

File Systems and Data Store

Feature	Default Selection
Storage Manager	
File & Database Replication (Bit-based)	
File System – Internal (RAM & ROM File System)	
Registry Storage (RAM-based Registry)	

Fonts

Feature	Default Selection
Arial	
Comic Sans MS	
Courier New	
Georgia	
Impact	
Kino	
MSLogo	
Symbol	
Tahoma	
Times New Roman	
Trebuchet MS	
Verdana	
Webdings	
Wingding	

International

Feature	Default Selection
Locale Services	

Locale Specific Support (Input Method Selector Sample Application)	
Multilingual User Interface (MUI)	

Internet Client Services

Feature	<i>Default Selection</i>
Browser Application (Internet Explorer 5.5 for Windows CE - Standard Components)	
Internet Explorer 5.5 for Windows CE Components	
- Internet Explorer Browser Control Host	
- Internet Explorer HTML/DHTML API	
- Internet Explorer Multiple-Language API	
- Internet Explorer TV-Style Navigation	
- URL Moniker Services	
- Windows Internet Services	
Pocket Internet Explorer HTML View (WEBVIEW)	
Sample IE 5.5 Internet Options Control Panel	
Scripting	

Multimedia Technologies

Feature	<i>Default Selection</i>
Basic Multimedia	
Multimedia Components	
- Audio	
- DirectMusic	
- Digital Rights Management	
- Direct3D	
- DirectDraw	
- DirectShow	
- DVD-Video	
- Windows Media Player	
- Windows Media Technologies	

Security

Feature	<i>Default Selection</i>
Authentication Services (SSPI)	
Cryptography Services (CryptoAPI 1.0) with High Encryption Provider	

Shell and User Interface

Feature	<i>Default Selection</i>
Shell	
User Interface	
- Accessibility	
- Customizable UI	
- Mouse	
- Touch Display (Stylus)	
- Network User Interface	
- Overlapping Menus	
- Software Input Panel	
- Speech Interface	

Appendix A Boot & Registry Searching Sequence

The following diagram demonstrates the boot sequence and registry searching sequence when SPC boot-up.

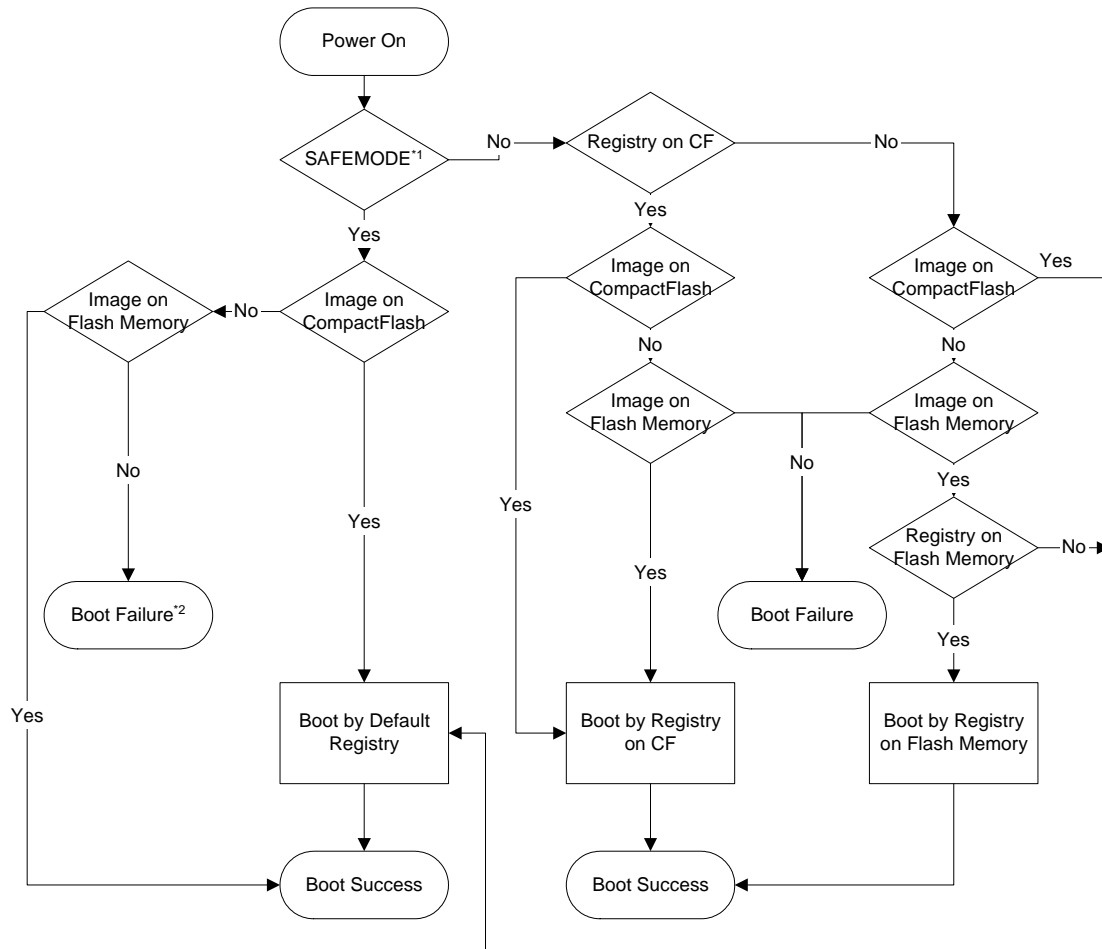

Figure A: Boot & Registry Searching Sequence

