

## Before Putting Into Use

---

- Before connecting the appliance to the power supply, let it stand for about 2 hours, which will reduce a possibility of malfunctions in the cooling system due to transport handling.
- Clean the appliance, and be thorough, especially in the interior (See Cleaning and Maintenance).
- In case the interior accessories are not correctly placed, rearrange them as described in chapter "NAME OF THE PARTS".

### Instructions for Use

These instruction for use are intended for the user. They describe the appliance and its correct and safe use. They were prepared for various types/modes of refrigerators therefore you may find in it description of some functions and accesories that your appliance does not have.

## Tips for Energy Savings

---

- Try not to open the door too often, especially when the weather is wet and hot. Once you open the door, mind to close it as soon as possible.
- Every now and then check if the appliance is sufficiently ventilated (adequate air circulation behind the appliance).
- Set thermostat from higher to lower settings as soon as possible (depends on how loaded the appliance is ambient temperature etc).
- Before loading the appliance with packages of fresh foods, make sure they are cooled to ambient temperature.
- Ice and frost layer increase energy consumption, so do clean the appliance as soon as the layer is 1/8" thick.

## Important

---

- If you have bought this appliance to replace an old one equipped with a lock that cannot be opened from inside (lock, bolt), make sure that the lock is broken. This will make it impossible for children to lock themselves inside the appliance and suffocate.
- The appliance must be correctly connected to the power supply. (See: How to install)
- Do not touch the cooled surfaces while the appliance operates, especially not with wet hands, because the skin may stick to the cold surfaces.
- Do not freeze bottles containing liquid, especially not soft drinks, such as mineral water, sparkling wine, beer, cola etc., because liquid expands during freezing and the glass bottle is very likely to blow up.
- Do not eat frozen food (bread, fruit, vegetables), because you can get frostbites.
- If the food has strange smell or color, throw it away, because it is very likely that it is spoiled and therefore dangerous to eat.
- Disconnect the appliance from the power supply before repairing it (only a qualified technician should repair it), before cleaning.
- Do not defrost the appliance with other electric devices (hair dryer etc.) and never scrape the ice or frost layer with sharp tools.
- The rating plate is inside the appliance or outside on the rear wall.

**DANGER:** Risk of child entrapment. Before you throw away your old refrigerator or freezer: Take off the doors and leave the shelves in place so that children may not easily climb inside.

# NAMES OF THE PARTS

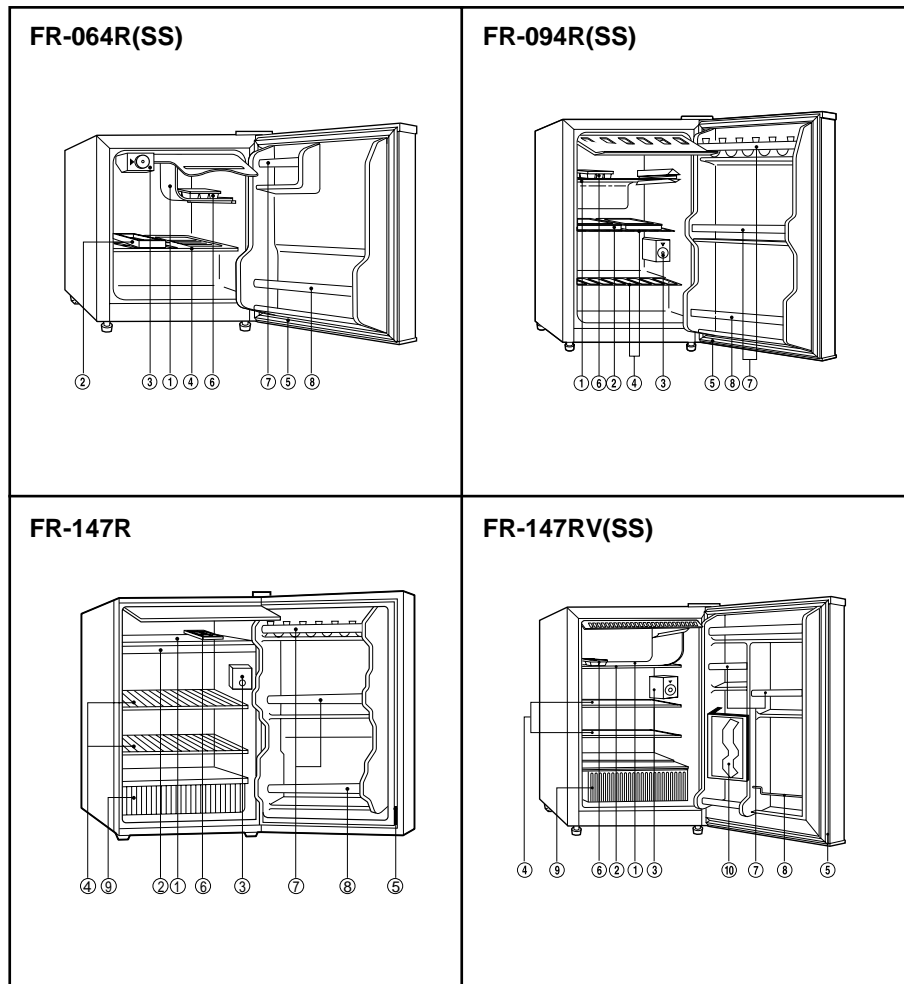

- ① Chiller
- ② Drain Pan
- ③ Control Box
- ④ Shelf
- ⑤ Magnetic Door Seal
- ⑥ Ice Cube Tray
- ⑦ Rack
- ⑧ Bottle Rack
- ⑨ Crisper
- ⑩ Can Dispenser

# HOW TO OPERATE

## Starting your new Refrigerator

1. Clean the refrigerator thoroughly. Wipe the outside with a soft dry cloth, the interior with a clean moist cloth.
2. Insert the power supply cord into the socket.
3. Turn the thermostat dial to "7". Close the door and let the refrigerator operate for 15-20 minutes.

## Temperature control

To control the internal temperature, adjust the thermostat dial. The dial is numbered from 1-7. Number 1 is the warmest setting, number 7 the coldest. The dial may be set any place on the scale. It does not have to be set exactly on a number. To make ice cubes in the freezer compartment, adjust the thermostat to the coldest setting.

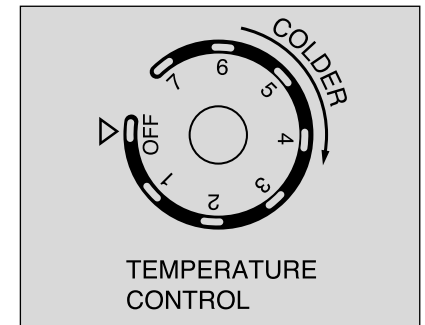

**NOTE:** Wait 3-5 minutes before restarting if you unplug the refrigerator. The unit may fail to operate properly if restarted too quickly.

## How to defrost

Defrost the refrigerator when the frost accumulated on the evaporator is about 5mm (1/5inch) thick. Set the thermostat dial to "OFF". Remove frozen or perishable foods. Keep drip tray in place. Defrosting usually takes a few hours. To defrost quickly remove all foods from the refrigerator and leave the door open. **Never use a knife or other metal instrument to scrape ice/frost from the evaporator.** After defrosting, empty water from drip tray and return the thermostat dial to the desired position.

## HOW TO CLEAN

**Cleaners** : Never use harsh, abrasive cleaners, heavy-duty cleaners, or solvents on any surface.

**Exterior** : Wipe with damp, sudsy cloth, rinse and dry. For stubborn stains and for periodic waxing, use silicon wax.

**Freezer** : When refrigerator needs defrosting turn thermostat dial to "OFF". Do not use sharp instruments to scrape off ice/frost.

**Refrigeration Section** : Wash shelves and other removable parts in warm sudsy water, rinse and dry. Wash interior with baking soda solution (3 Tablespoons to 1 Liter of water) or warm sudsy water, rinse and dry.

**Magnetic Door Seals** : Wash with warm sudsy water.

**The Finishing Touch** : Replace all parts and return thermostat dial to desired setting.

## HOW TO INSTALL

■ Install refrigerator in a convenient location away from extreme heat and cold. Allow sufficient clearance between the refrigerator and side wall so the door will open without obstruction. Refrigerator is not designed for recessed installation.

■ Select a space with strong level floor.

■ Allow 5 inches of space between the refrigerator's side and the wall.

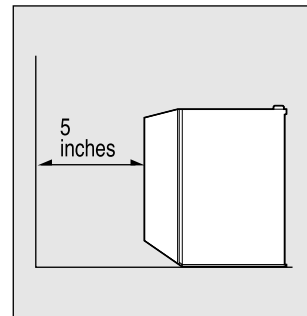

### POWER CORD REPLACEMENT

If the refrigerator's power cord is damaged, have it replaced by a qualified repair agent.

## WHAT TO DO...

### When the fridge is not in use for a prolonged period:

- Remove the power plug from the power point.
- Remove all contents from the fridge.
- Dry the interior and leave the door open for a few days.

### When you wish to move the fridge:

- Secure all movable parts and contents. (Package them separately if necessary.)
- Transport the fridge only in an upright position. In any other position you may damage the compressor.

Before calling service, please follow the checklist below. This may save you an expensive service call.

### If the refrigerator seems too warm inside:

- Check that the door has not been opened too frequently or for too long.
- Check that the interior circulation is not obstructed by having too many goods stored. (The fridge is overloaded)
- Did you store anything hot, without first cooling it to room temperature?
- Is there sufficient clearance around all sides and above the fridge?

### If the fridge starts making any unusual noises:

- Is it wobbling? Re-level it and check if it now operates normally.
- Have any objects fallen behind the fridge? If so, remove them and check if operation is now normal.
- Are any containers inside the fridge vibrating or resonating? If so, rearrange them then check to see if operation has returned to normal.

**WARNING**-Improper use of the grounding plug can result in a risk of electric shock. If it is necessary to use an extension cord, use only a 3-wire extension cord that has a 3-blade grounding plug and a 3-slot receptacle that will accept the plug on the appliance. The marked rating of the extension cord should be AC115-120V, 10A, or more. If a grounding adapter is used, make sure the receptacle box is fully grounded.

# CHANGING THE REVERSIBLE DOOR

This refrigerator has been built with the door hinges on the right. If you wish to change the opening direction, follow the instruction below:

- Unplug the refrigerator from its electrical outlet.
- Empty everything in the refrigerator, including shelves, food, etc.

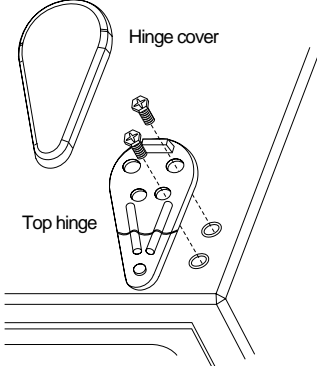
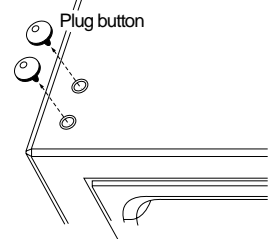
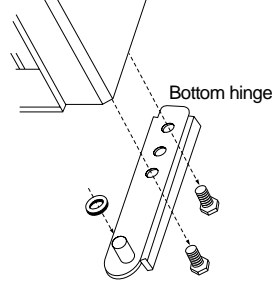
<ol style="list-style-type: none"> <li>1. Remove the hinge cover on the right top of the cabinet.</li> <li>2. Remove the two screws (using a ratchet tool with a 8MM socket) that hold the top hinge to the cabinet. Keep these screws for later use.</li> <li>3. Lift the top hinge straight up to free the pin from the socket on the top of the door.</li> <li>4. Lift the door and place it on a padded surface to prevent scratching it.</li> </ol>	
<ol style="list-style-type: none"> <li>5. Remove the plug buttons from the upper left holes as illustrated and transfer them to the uncovered holes at the right side. Be sure to press the plug buttons firmly into the holes.</li> </ol>	
<ol style="list-style-type: none"> <li>6. Lay the cabinet on its side down on the floor. Remove the two screws that hold the bottom hinge to the cabinet using a 10MM socket. Keep these screws and washer for later use.</li> </ol>	

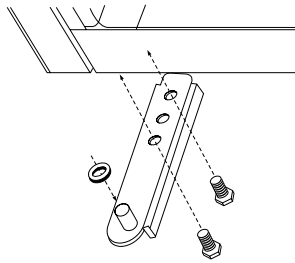
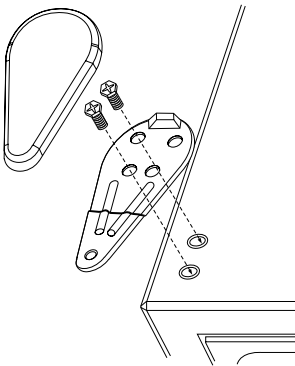
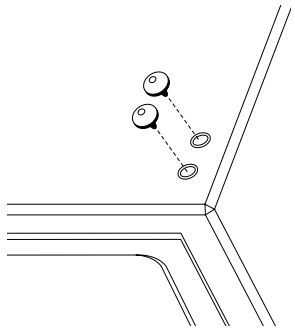
<ol style="list-style-type: none"> <li>7. Insert the bottom hinge at the left side using the two screws previously removed in step 6. NOTE: Do not tighten screws.</li> <li>8. Stand the cabinet.</li> <li>9. Replace the door making sure the bottom socket enters the bottom hinge pin. Be sure washer is in place.</li> </ol>	
<ol style="list-style-type: none"> <li>10. While holding the door in the closed position, secure the top hinge at the left side using the two screws previously removed at the beginning in step 2. Do not tighten the screws until the top of the door is leveled with the top cabinet.</li> <li>11. Replace the hinge cover.</li> </ol>	
<ol style="list-style-type: none"> <li>12. Replace plugs.</li> </ol>	
<ol style="list-style-type: none"> <li>13. Tools required: -8MM &amp; 10MM socket-ratchet. -Putty knife or thin-blade screwdriver.</li> </ol>	

# Limited Warranty



DAEWOO ELECTRONICS AMERICA INC. warrants the following Refrigerators to be free from defective material and workmanship and agrees to remedy any such defect or to furnish a new part (at the Company's option) in exchange for any part of any unit of its manufacture which under normal installation, use and service disclosed such defect, provided the unit is delivered by the owner to us or to our authorized distributor from whom purchased or authorized service station, intact, for our examination with all transportation charges prepaid to our factory. To establish and receive warranty service at our factory or authorized service facilities, a sales receipt or bill of sales is required for proof of purchase.

Written authorization must be obtained before any merchandise is returned to the factory.

This warranty does not extend to any of our electronic products which have been subjected to misuse, neglect, accident, incorrect wiring not our own, improper installation, unauthorized modification, or to use in violation of instructions furnished by us, nor units which have been repaired or altered outside of our factory, nor to cases where the serial number there of has removed, defaced, or changed.

This warranty is in lieu of all warranties expressed or implied and no representative or person is authorized to assume for us any other liability in connection with the sales of our electronic products.

For units that are initially defective.  
Initial defective is described as when the dealer opens the unit and finds that it is inoperative or an individual customer opening a new unit and finding that it is initially defective. This unit may be returned to the factory by the dealer for exchange. Under no circumstances will an individual customer be permitted to return defective unit directly to factory. Exchange must be directly with the dealer. When this unit is returned to dealer, a copy of the purchase evidence stating the date of purchase is to be put in the individual box for dealer's further control with the factory.

<u>MODEL</u>	<u>PARTS</u>	<u>LABOR</u>	<u>COMPRESSOR</u>
Refrigerator	1 year	1year	5years
Model: <b>FR-064R(SS), FR-094R(SS), FR-147R , FR-147RV(SS)</b>			

Note: **For Service or Assistance, please call: 1-800-553-4355**



# REFRIGERATOR INSTRUCTION MANUAL

Model No.

**FR-064R(SS) / FR-094R(SS)  
FR-147R / FR-147RV(SS)**

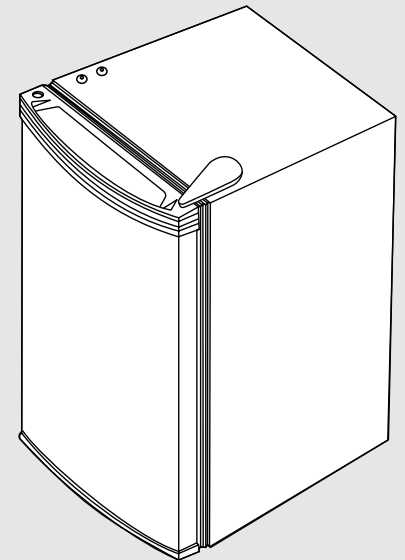

Before use, please read this manual carefully.  
Always remove the drain pan while this refrigerator is running.  
Removing the drain pan will enhance the cooling power and save your electric cost.