

BeoLink[®] Active

Setting-up Guide

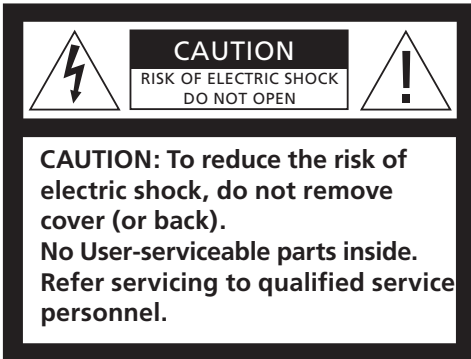

WARNING: To reduce the risk of fire or electric shock, do not expose this appliance to rain or moisture. Do not expose this equipment to dripping or splashing and ensure that no objects filled with liquids, such as vases, are placed on the equipment.

To completely disconnect this equipment from the AC Mains, disconnect the mains plug from the wall socket. The disconnect device shall remain readily operable.



The lightning flash with arrowhead symbol within an equilateral triangle, is intended to alert the user to the presence of un-insulated “dangerous voltage” within the product’s enclosure that may be of sufficient magnitude to constitute a risk of electric shock to persons.



The exclamation point within an equilateral triangle is intended to alert the user to the presence of important operating and maintenance (servicing) instructions in the literature accompanying the product.

For the US-market only!

NOTE: This equipment has been tested and found to comply with the limits for a class B digital device, pursuant to part 15 of the FCC Rules. These limits are designed to provide reasonable protection against harmful interference in a residential installation. This equipment generates, uses and can radiate radio frequency energy and, if not installed and used in accordance with the instructions, may cause harmful interference to radio communications. However, there is no guarantee that interference will not occur in a particular installation. If this equipment does cause harmful interference to radio or television reception, which can be determined by turning the equipment off and on, the user is encouraged to try to correct the interference by one or more of the following measures:

- Reorient or relocate the receiving antenna.
- Increase the separation between the equipment and receiver.
- Connect the equipment into an outlet on a circuit different from that to which the receiver is connected.
- Consult the dealer or an experienced radio/TV technician for help.

Note: Building and electrical codes may vary from locality to locality. Make sure that the installation is in compliance with applicable codes. Bang & Olufsen shall not be legally responsible for injury or damage caused by improper installation.

For the Canadian market only:

This class B digital apparatus meets all requirements of the Canadian Interference-Causing Equipment Regulations.

BEFORE YOU START...

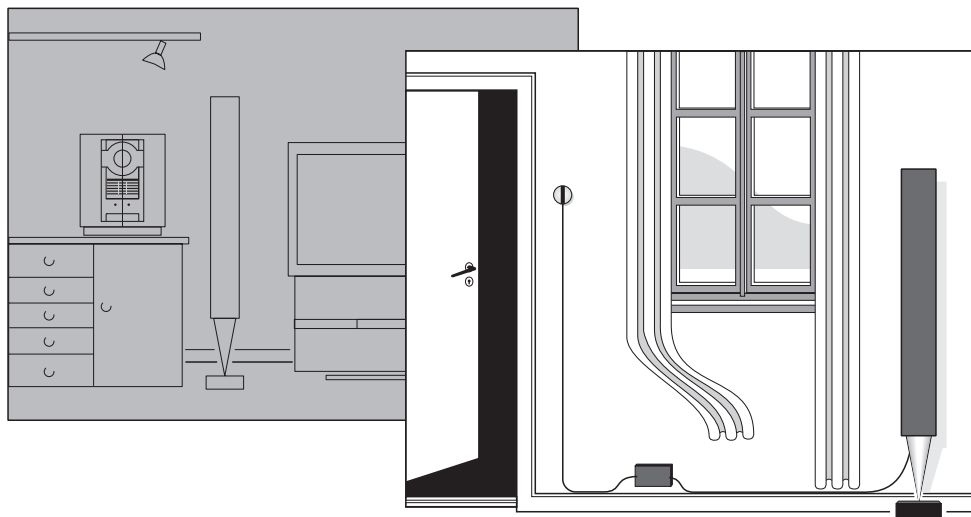

Setting-up guide

This guide describes how to install your BeoLink Active kit in a BeoLink distribution system.

If you have never carried out cable installation before, we suggest you leave it to your Bang & Olufsen dealer. Likewise, we recommend that you follow the instructions in this guide carefully.

The User's guide which is also supplied with the BeoLink Active kit describes how to operate your system once it has been installed.

BeoLink system

The BeoLink distribution system enables you to control your main system and to hear it in the Link room. Your Link room must be connected to the main room via a special (Master Link) cable. To join the Master Link cable from the main system and the cable from the BeoLink Active box you will need a Master Link junction box. These accessories can be purchased at your Bang & Olufsen dealer.

The main room is the room in which you have placed your audio system and/or video system (the main system). The link room is where you are about to set up the BeoLink Active with a pair of active speakers.

When you set up your BeoLink Active kit, we recommend the following sequence:

- 1 Switch off all products and disconnect them from the mains.
- 2 Make your installation.
- 3 Connect all products to the mains.
- 4 Carry out the preprogramming.

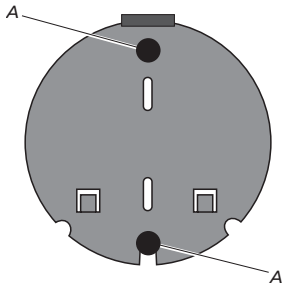

To fasten the BeoLink Active receiver to the wall:

- 1 Using the wall bracket as a template, mark and drill the holes in the wall.
- 2 Using the two screws and wall plugs supplied (A), fasten the wall bracket.
- 3 When you have mounted the receiver cable (see page 5) hang the receiver on the wall bracket and then secure it with the tiny screw (B).
- 4 Fasten the cable to the wall and run it to the BeoLink Active box.

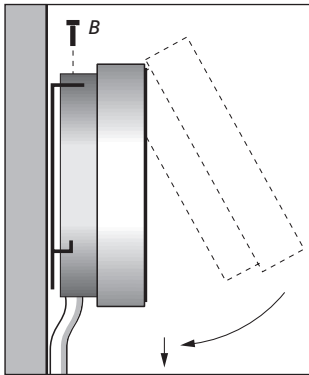

In the following we have listed some advice and requirements for the placement of the BeoLink Active:

- The units in the system must all be placed in a dry place, i.e. not outdoors (the Master Link cable, however, may very well be run outdoors). Once connected, the BeoLink Active box should be fastened to the wall – e.g. concealed behind a curtain or a piece of furniture.
- Place the BeoLink Active receiver so it can receive the remote control signals.
- If the receiver is placed next to a door and at a suitable height, you can easily switch on or off by close-up operation when entering or leaving the room. Likewise, if it is placed near your telephone, you can switch off the speakers while you are on the phone.
- Avoid placing the receiver in direct sunlight or direct artificial light, e.g. a spotlight, or near objects generating electrical noise, e.g. light dimmers, as this will reduce the sensitivity of the receiver.
- The receiver is designed to function within a temperature range of 0 – 55°C (32 – 130°F). If it is exposed to higher or lower temperatures, it may block the whole system. The box is designed to function within a temperature range of 10 – 40°C (50 – 105°F).
- The receiver cable supplied is 5 metres (15'). This is the maximum length of cable to be used.

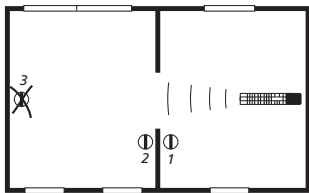

If you have installed more units throughout the house, make sure that the remote control can only activate one receiver at a time.

Cables should always be handled with great care. When running the cables, avoid bending them too sharply and be careful not to twist them. Avoid subjecting the cables to pressure or impact.

Using the cable supplied, connect the BeoLink Active receiver as follows:

- 1 Detach the rear cover of the BeoLink Active receiver (unscrew the two screws (C) and loosen the two screws (D), then lift off the cover).
- 2 Cut the cable to the required length (from the BeoLink Active box to the receiver) and strip it as shown.
- 3 Insert the cable end through the cable clamp (E) and connect the leads to the terminals inside the receiver in the order indicated. Then tighten the clamp (E).
- 4 Attach the rear cover again and fasten the BeoLink Active receiver to the wall (see page 4).
- 5 Plug the cable into the socket marked IR on the BeoLink Active box.

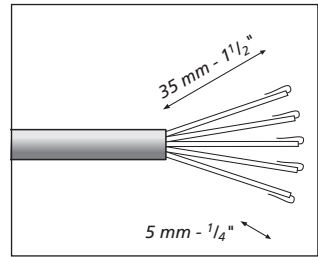
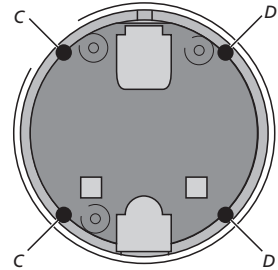

Strip the cable end. Twist the cores in each lead and bend them back.

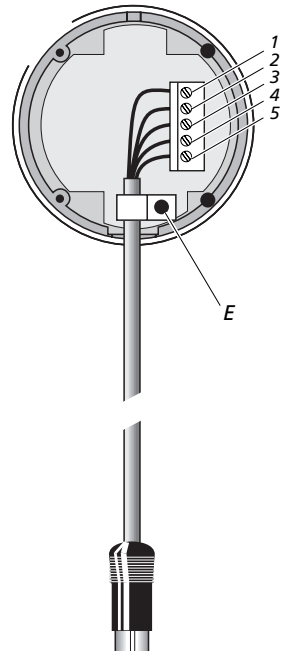

NOTE! Disconnect your entire Bang & Olufsen system from the mains while you make the connections!

Connect the leads in the receiver cable to the terminals inside the receiver in this order:

- 1 = Yellow
- 2 = Grey
- 3 = Green
- 4 = White
- 5 = Brown

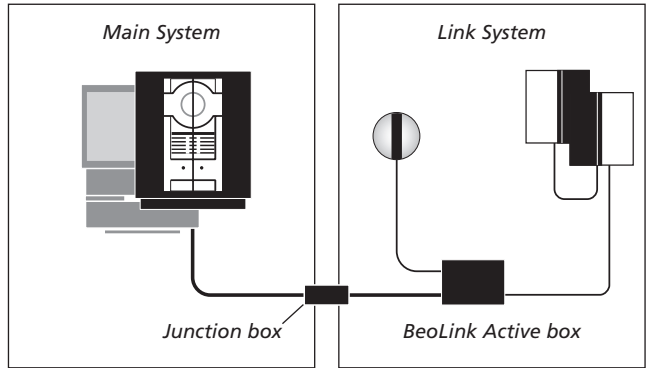
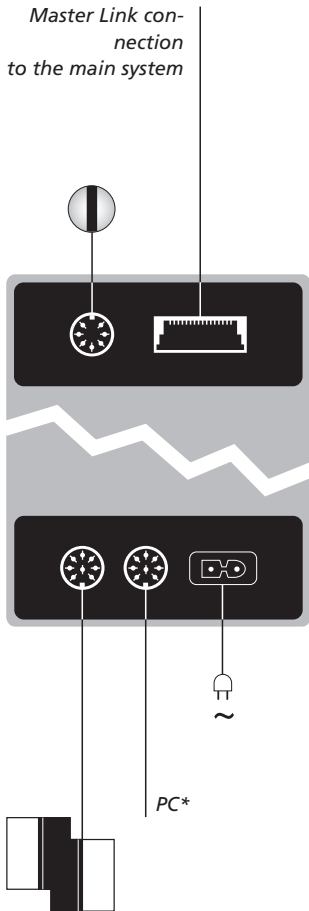

In the link room: Using a Master Link cable, connect the multi-pin plug to the socket marked MASTER LINK on the BeoLink Active box, and run the cable to the junction box.

Using Power Link cables (8-pin DIN), connect your active speakers to the sockets marked POWER LINK. Remember to set the L • R • LINE switch on each speaker to L and R (left and right channel), respectively.

In the main room: Using a Master Link cable, connect the flat multi-pin plug to the socket marked MASTER LINK on the main system, and run the cable to the junction box.

Inside the junction box: Join the cables as explained in the documentation enclosed with the box. This document contains information of the many possibilities of the box and how to join the cables.

Connect one speaker to the socket marked Power Link and then loop the signals through to the other speaker as described in the User's guide for your speakers.

*The socket marked PC is used in BeoLink PC setups only. Please refer to the User's guide enclosed with the BeoLink PC kit.

When you have made all the connections as described in the previous chapter you may start using the system.

However, in order for your setup to function properly, you may need to preprogram it.

Your BeoLink Active can be preprogrammed for the following setup situations (*Options*):

Option 0: To be used if you want to disable remote control operation of the BeoLink Active (to re-enable remote control, select one of the other options).

Option 4: To be used if you install the BeoLink Active in the same room as your main system (e.g. in a large L-shaped living room with two separate listening positions).

Option 5: To be used if you install a TV set in the same room as your BeoLink Active.

Option 6: To be used for a setup with the main system in one room and the BeoLink Active in another, as described in this guide, and in a setup with BeoLink PC Office (this is the factory setting).

NOTE! To ensure correct function of your setup, it is essential that you connect both the main system and the speakers to the mains – before connecting the BeoLink Active box to the mains!

Using a Beolink 1000:

- Press LINK, the appropriate number (0, 4, 5 or 6), and then STORE.

Using a Beo4:

- Hold the • button while pressing LIST. When the Beo4 display reads OPTION?, press GO.
- Press LIST twice to display L.OPT and then key in the appropriate number (0, 4, 5 or 6).

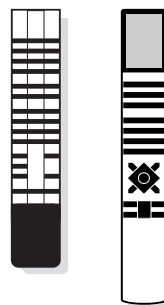

The preprogramming is done with a Bang & Olufsen remote control, and must be carried out with both the main and link system switched to stand-by!

