



DISHWASHER SERVICE TRAINING MANUAL

BOSCH

SIEMENS

GAGGENAU

Thermador[®]

Dishwasher Service Training Manual

Each section contains:

- Access/Disassembly
- Installation/Reassembly
- Service Tips, including quick measurements from fascia panels

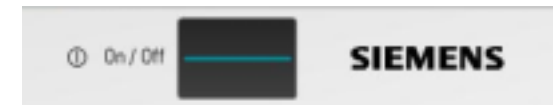

This manual includes the S line of dishwashers, the high tech leader worldwide.

There's also helpful serial # label information.

Distinctive Features & Innovations (1)

By definition, service professionals are only called when there are problems -- getting only one side of the story. The complete story includes many innovations and features not found on other dishwashers. Because of these distinctive features & innovations, many more people will be owning **B**, **S**, **G** or *Thermador* dishwashers -- making learning how to repair them more important than ever.

Separate circulation & drain pumps

Separate pumps are quieter, more efficient and use less energy.



Flow-through water heater

Flow-through water heaters allow use of tall tubs (with more space for dishes), prevent damage to dishes & allow 100% water filtering.

A safety flow switch prevents heating without water flow.



Distinctive Features & Innovations (2)

No Pre-washing Needed

Dishwashers clean so well no pre-washing is needed.



NSF Sanitizing

Many wash cycles are NSF certified, providing sanitized dishes. Many models have an indicating light showing dishes are sanitized.



Insulation

Tank & door insulation provides quiet dishwashers.

Bitumen insulation also holds heat in, saving time/energy and enabling condensation drying.



*Dishwasher insulation packages vary by model.

Condensation Drying

Dishes are dried quickly without using an element in the tank.



Distinctive Features & Innovations (3)

*Sensotronic™ & hydroSensor™
Washes*

*Provides energy &
water savings.*

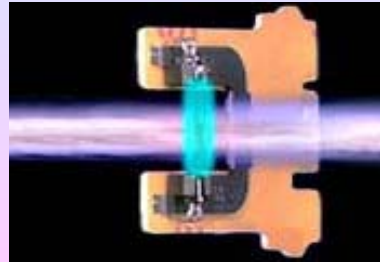

*Suspended circulation pump +
solid base*

*Helps provide
the quietest
dishwashers
in the industry.*



*Did you know **B** & **S**
are the industry leaders in
dishwasher innovations worldwide
as well as in the U.S.?*



Distinctive Features & Innovations (4)

100% Filtered Wash Water

Unlike other dishwashers, 100% of water is filtered.



Tall Stainless Steel Tanks



Adjustable Racks

Adjustable racks and many other options provide complete flexibility in dishwasher loading.



Energy Star Rated

All dishwashers are certified energy savers.



Warranty Serial # Info



The serial label is fastened to the right edge of the inner door.

FD8303 00001

Understanding FD Serial # (used for warranty)

The FD # shows the Fabrication Date

- The first 2 #'s represent the year: 83 = 2003
- The next 2 #'s represent the month: 03 = March
- The next 5 #'s represent the unit made that month: 00011 = 11th SHU3307UC made that month

This helps the factory investigate product problems.

Please hold all warranty parts for (60) days for possible return for analysis.

10 3 03 0081344 00011 5

Understanding Factory Serial

- The first 2 #'s represent a factory code: 10 = New Bern dishwasher, 82 = New Bern cooking
- The 3rd # represents the last digit of the year: 3 = 2003
- The next 2 #'s represent the month: 03 = March
- The next 7 #'s represent the model: 0081344 = SHY99S05UC
- The next 5 #'s represent the unit made that month: 00011 = 11th SHY99A05UC made that month
- The last # represents a check digit = 5 in this case (is dependent on all preceding #'s)

Dishwasher Service Training Contents

Dishwasher Main Parts:

NOTE: Dishwashers are rated 120V, 60 Hz, 15A, 1450W (max.).
Maximum amp draw when heaters running ~ 11A.

- ① **Water valves**.... Most damaged valves occur from being cracked by fittings being overtightened -- some valves are damaged from hard water or debris from customer pipes clogging them so they can't close securely. A damaged valve can allow some water onto kitchen floors.
- ② **Impellers or circulation pumps**....They're improved and perform well, but expectations are high for dishwashers in rarely used summer homes.
- ③ **Control modules**....From heater relay solder joints to broken buttons to "F" or "2H" fault codes, modules can fail occasionally. However, many good modules have been replaced due to unrelated problems.
- ④ **Heaters & NTC's**....Either one can cause heating problems, but there can be other parts to check as well....
- ⑤ **Drain pumps**....Check drain hose installation 1st to confirm if it's the pump or not. Many good pumps have been replaced because high loops were missing.
- ⑥ **Dispensers**....Repairs often due to customer abuse.
- ⑦ **Cosmetic damage**....Dinged doors and broken buttons, often during shipment.
- ⑧ **Door latches**....Often broken microswitches on integrated models, understandable seeing how dishwashers are treated. Can be misaligned latches or miswired switches.
- ⑨ **Aqua sensors**....Not crucial to operation, but can affect energy & water usage.
- ⑩ **Water fill assemblies**....Microswitches can fail. Can be affected when units have been flipped upside-down, allowing sump water to get into diaphragm.

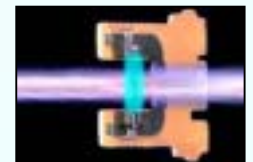

Table of Contents

🔧	Water valves.....	5
🔧	Circulation pumps & impellers.....	7
🔧	Service Tips.....	12
🔧	Control modules.....	25
🔧	Service Tips.....	33
🔧	Heater assemblies & NTC's.....	59
🔧	Service Tips.....	65
🔧	Drain pumps.....	73
🔧	Service Tips.....	74
🔧	Dispensers.....	75
🔧	Service Tips.....	78
🔧	Cosmetic damage.....	82
🔧	Service Tips.....	83
🔧	Door latches.....	84
🔧	Service Tips.....	87
🔧	Aqua sensors.....	89
🔧	Water fill assemblies.....	91
🔧	Miscellaneous service tips.....	94



NOTE: Dishwashers are rated 120V, 60 Hz, 15A, 1450W (max.). Maximum amp draw when heaters running ~ 11A.

This 2nd edition replaces the 1st edition and is intended for service personnel.

Part # 1 -- Water Valve (1)

Disassembly

The water valve is accessed from the front of the dishwasher base by removing the toe kick.

To remove water valve:

- ✂ Remove two (2) T-20 Torx screws from toe kick and tilt toe kick out from under dishwasher.
- ✂ Remove base insulation (on models with insulation).
- ✂ Move sump inlet hose away from water valve (without disconnecting it).
- ✂ Disconnect wires from water valve, including ground wire.
- ✂ Remove two (2) T-20 Torx screws from water valve.
- ✂ Pull valve out from dishwasher and disconnect water hose from rear of valve. Remove any water from sump & base.

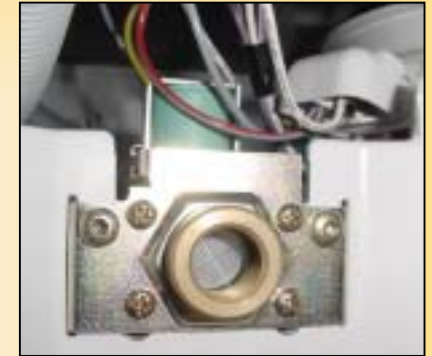

CONNECTION HINTS: Water connection 3/8" NPT female. Inlet water pressure range 5 - 120 psi (0.3 – 8.27 bars).

Removing toe kick

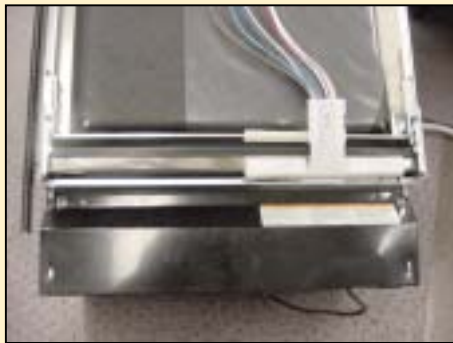

Moving sump hose

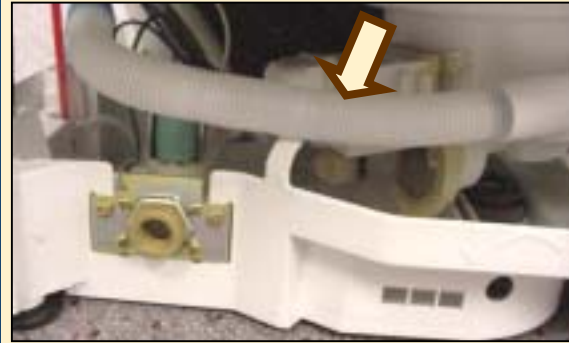

Removing hose clamp



Part # 1 -- Water Valve (2)

Service Tips

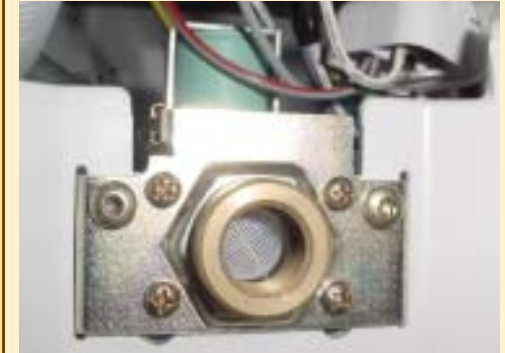

HINTS:

- When reconnecting the water supply to the water valve, don't overtighten the fitting. On valves with vertical solenoids, the plastic can crack and cause leaking if excessive force is used.
- Using Teflon tape on water fittings can help prevent leaking.
- The water valve can be accessed without removing outer door or base cover. However, removing them will provide easier access.

NOTE: Water valves have been upgraded several times since 1st 1/4 of 1999. All valves with upgraded solenoids have yellow solenoid stems. All old valves have white solenoid stems.

- The newest valve (part # **189533**) has the solenoid mounted horizontally and the water fitting held in place by the metal mounting bracket. It is the only replacement valve available and it replaces all other valves.
- The previous valve (part # **580009**) had the solenoid mounted vertically, a yellow solenoid stem and a fine brown mesh filter screen. Use # **189533** horizontal valve whenever it needs to be replaced.
- The oldest valve, used March, 1999 and earlier (part # **167081**), had the solenoid mounted vertically, a white solenoid stem and a white mesh filter screen. Use # **189533** horizontal valve whenever it needs to be replaced.

Part # 2 -- Circulation Pump & Impeller (1)

Access

The circulation pump & capacitor are accessed from the right side of the dishwasher by removing the right side panel and blocking the tank.

To remove outer door:

- ✂ Remove six T-20 Torx inner door screws below fascia panel -- three per side (1).
- ✂ Carefully pull bottom of outer door out from dishwasher until top door tabs clear, then pull door down until it releases from dishwasher (2). Take care to not scratch outer door.
- ✂ Remove two plastic door guards (3). They occasionally fall out when the outer door is removed.



NOTE: Circulation pump motor rated 120V, 60 Hz, 160W, insulation class A. Motor has an auto-reset thermal protector and uses a 10 μ F capacitor.

HINT: The fascia panel and door don't need to be removed to access the circulation pump. However, they must be removed to completely remove the tank.

Part # 2 -- Circulation Pump & Impeller (2)

To remove toe kick:

- ✖ Remove two T-20 Torx screws from toe kick (1).
- ✖ Tilt toe kick out from under dishwasher (2).

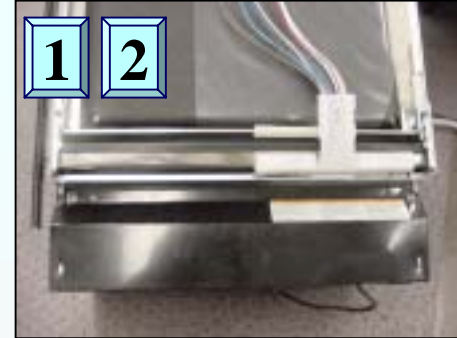

To remove right & left side panels:

- ✖ Remove two T-20 Torx side panel screws through holes in right & left trim strips (1).
- ✖ Carefully slide trim strips up and out of dishwasher (2). If side panels are removed carefully to avoid damaging trim strips, then trim strips don't need to be removed.
- ✖ Lift side panels up and out from dishwasher (3). Panels can be removed with trim strips. Although removing the left side panel isn't necessary for access, it does allow the right side of the tank to be blocked upward.



Part # 2 -- Circulation Pump & Impeller (3)

To raise right side of tank for circulation pump access:

- ✘ Remove one T-20 Torx screw from both rear corners holding tank to base (1) -- removing screw from both sides allows tank to be blocked upward.
- ✘ Remove right toe kick bracket by removing T-20 Torx screw (2).
- ✘ Remove T-20 Torx screws from front right bottom corner holding tank to base (3).
- ✘ Remove right hinge cover (4a), release right door tension cord from hinge (4b) & remove ground wire (4c).
- ✘ Raise and block up tank as shown with strut onto base (5a), sliding a piece of wood or other solid material between the tank and base to keep tank from falling back onto base (5b).



CAUTION: Its not recommended to turn dishwashers upside-down for tank access. When dishwashers are turned upside-down, water can flow into the diaphragm of the water fill assembly and cause water to not fill properly.

Part # 2 -- Circulation Pump & Impeller (4)

Disassembly

To remove motor to access impeller or change complete pump:

- ✘ Disconnect wire harness from motor after carefully noting connections (1).
- ✘ For UC/11 & later models with softer bearing, lift up rubber straps from both sides of motor (2). For older models, lift motor up from base.
- ✘ To release plastic latch on pump/motor housing, carefully push onto latch with screwdriver (3).
- ✘ To release motor from pump housing, twist motor to the right (clockwise). Some force may be required. Capacitor should be ~ 11:00 position (4). Pull motor out from pump housing.



HINT: When replacing complete circulation pumps for softer bearing models (UC/11 & later), reusing existing front pump housings (& discarding replacement housings) can save time by not having to change hose clamps. If desired, order # **172272** hose clamps & replace entire pumps.

CAUTION: Don't grab motor next to the capacitor to avoid jamming your hand on the capacitor.

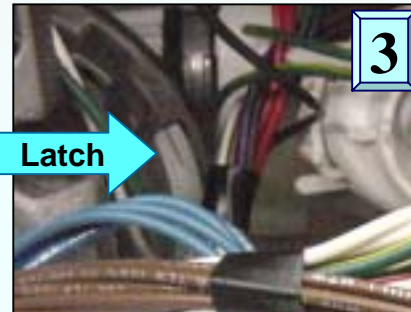
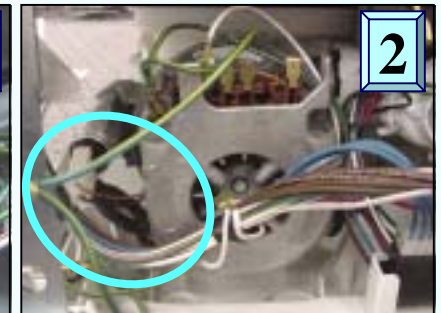

Part # 2 -- Circulation Pump & Impeller (5)

Reassembly

To remove & install impeller (using kit # 167085):

- ✂ While holding motor fan so shaft won't spin (1a), unscrew impeller counterclockwise (1b).
- ✂ Rotate pump housing counterclockwise until tabs clear, then lift housing from motor (2).
- ✂ Remove spring and O-ring from pump housing, then lift spacer up from motor shaft (3).
- ✂ Place replacement spacer onto motor shaft (4). Note larger end goes onto shaft 1st.
- ✂ Install replacement spring & O-ring onto pump housing, then line up housing-motor tabs to screw pump housing onto motor (5a). Screw replacement impeller onto motor shaft (5b).
- ✂ Align motor to pump housing with capacitor @ 11:00 position to facilitate reassembly.

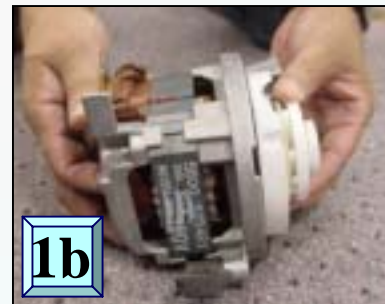

Service Tips -- Checking (PTC) Pump Motor Starter (1)

The (PTC) circulation pump motor starter (# 182318) is used on **SHX99B / SHV99A / SHY99A** (“Apexx”), **SL95A & SHX56B / SHV66A / SHY56A-66C** (“ExactWash”) models with water switches. The matching circulation pump (# 437345) has three slightly smaller & more efficient windings compared to the traditional pump with two larger windings (# 266511 motor / # 239144 pump). The 3rd (start) winding is cut out when the motor gets running. This stronger pump is needed due to the increased water flow resistance from the water switch.



NOTE: Install starter with terminal pointing inward.

NOTE: Pump # 437345 includes starter # 182318.



HINT: (PTC) motor starter is located on top of the pump motor and faces inward over the motor.

To install (PTC) motor starters, push female terminals over pump motor terminals 2 & 4. The terminals are different sizes to match the smaller motor terminal 4.

The (PTC) motor starter helps start the circulation pump. It's a ceramic thermal switch which conducts current & heats up, cutting out the 3rd (start) winding at a preset temperature. The two main windings (with the start/run capacitor) have power whenever the pump is running.

✘ Check the motor starter if the pump motor won't start (starter stuck open) or runs hot (starter stuck closed).

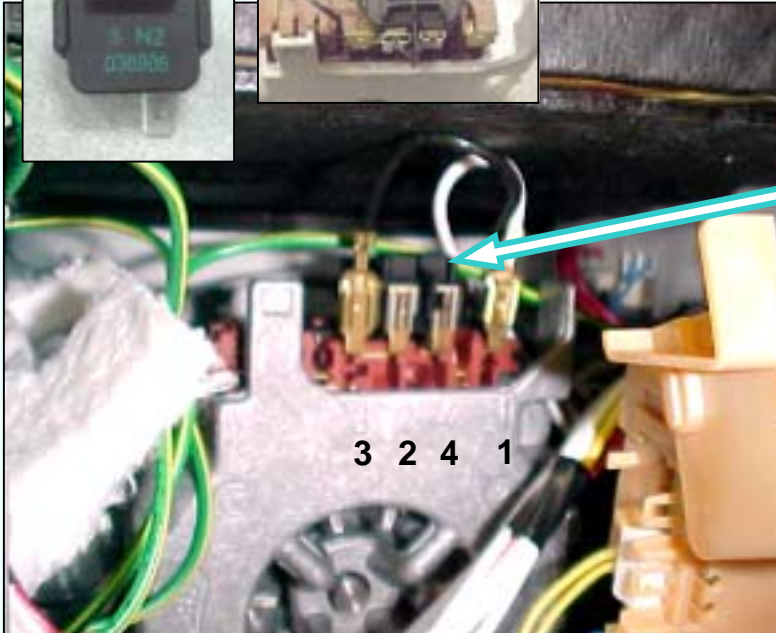

Service Tips -- Checking (PTC) Pump Motor Starter (2)

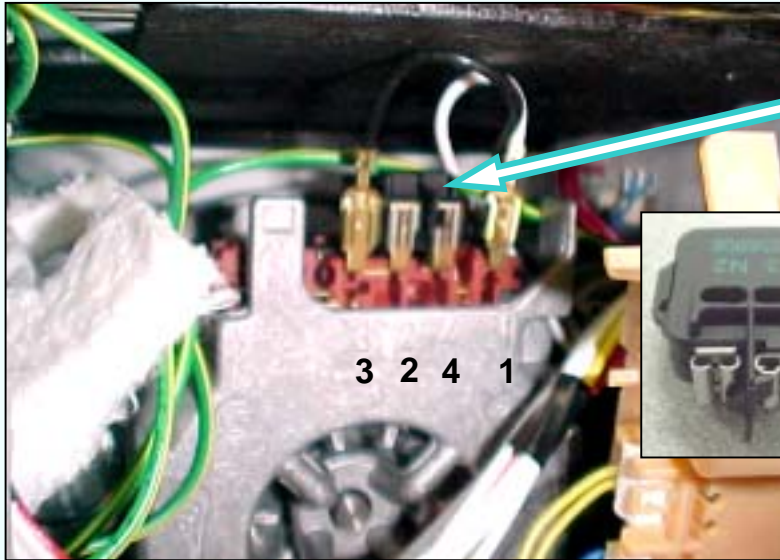

PTC

NOTE: Unlike standard two-winding pump motors, these three-winding pump motors have four terminals instead of three.



Apex
model
shown

NOTE: Encountering original equipment pumps & motor starters:

- ① **11/11/03 & later:** Circulation pump # **437345** (with 135°C OVLP) with motor starter # **182318** (4.7 – 4.8Ω).
- ① **9/16/03 – 11/11/03:** Circulation pump # **239129** (with 120°C OVLP) with motor starter # **423023** (16.8Ω).
- ① **6/6/02 – 9/16/03:** Circulation pump # **239129** (with 120°C OVLP) with motor starter # **182318** (4.7 – 4.8Ω).

TECH TIPS: Resistance measurements:

- Ω Between terminals 1 - 2 is ~ **7 Ω** (one of the main run windings).
- Ω Won't help between terminals 2 - 4 (start winding, a run winding & the motor starter). The motor starter can't be measured since the windings are always connected. Must disconnect PTC 1st to measure its continuity.

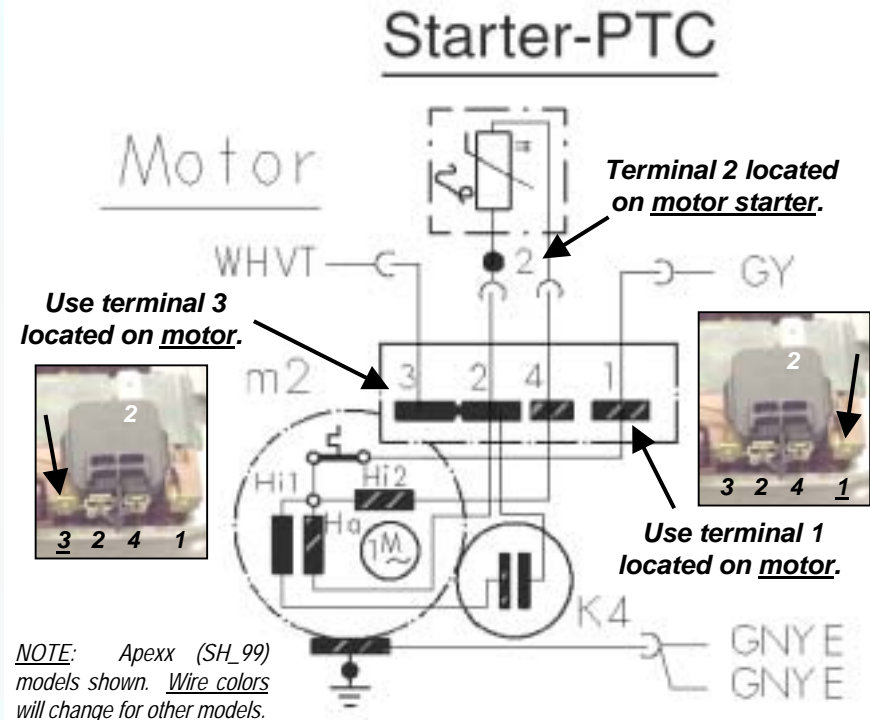

NOTE: Motor terminals 2 - 3 and both PTC terminals are tied together. Although factory units are connected to motor terminal 3, it doesn't matter if motor terminal 3 or PTC terminal 2 is used (both will work). Use motor terminal 3 to be consistent with factory units.

Service Tips – Water Switch Pump Nuisance Tripping (1)

There has been some nuisance tripping & failing of motor thermal protectors on three-winding circulation pumps for use with water switches (# **239129**) on units built on or before October, 2003 (FD # 8310 or before). To prevent this, these pumps have been replaced by pumps with upgraded thermal protectors (# **437345**).

NOTE: Circulation pump # **437345** includes motor starter # **182318**. When replacing any pump, **always** replace the motor starter as well.

NOTE: Encountering original equipment pumps & motor starters:

- ① **11/11/03 & later:** Circulation pump # **437345** (with 135°C OVLP) with motor starter # **182318** (4.7 – 4.8Ω).
- ① **9/16/03 – 11/11/03:** Circulation pump # **239129** (with 120°C OVLP) with motor starter # **423023** (16.8Ω).
- ① **6/6/02 – 9/16/03:** Circulation pump # **239129** (with 120°C OVLP) with motor starter # **182318** (4.7 – 4.8Ω).

TECH NOTES: Motor starter # **423023** (16.8Ω) has a larger resistance to limit current draw through pump motor start windings. Winding temperatures are reduced, but starting torque is reduced as well (by **10%**). To obtain designed start torque and keep UL certification, do **not** use motor starter # **423023** with circulation pump # **437345**. Use **only** motor starter # **182318** with circulation pump # **437345**.

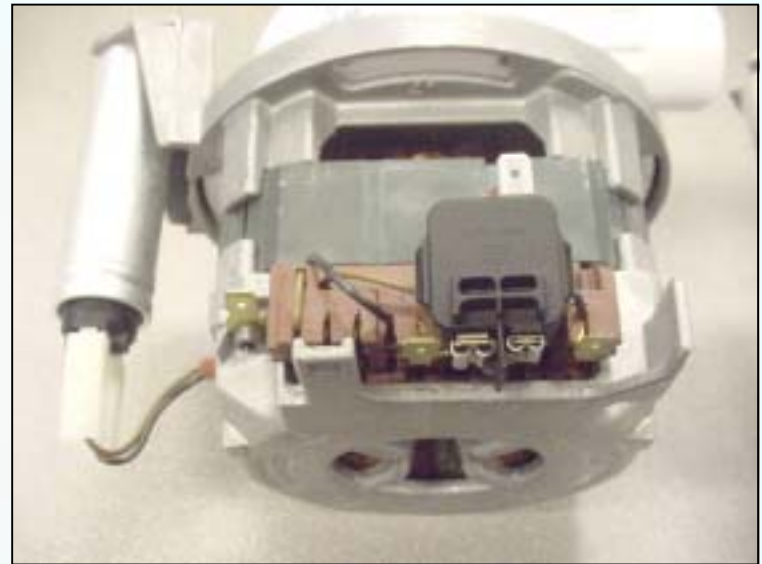

TECH TIPS: All circulation pump motors use auto-reset thermal protectors. Once motor windings cool below a preset temperature, protectors reset and pumps will work again. If thermal protectors fail to reset, replace pumps.

Service Tips – Water Switch Pump Nuisance Tripping (2)

HINTS: Identifying circulation pumps & motor starters:

- ① Circulation pump # 437345 – look for # “5600 060022” stamped on housing.
- ① Motor starter # 182318 – look for # “036906” stamped on housing.
- ① Circulation pump # 239129 – look for # “5600 050139” stamped on housing.
- ① Motor starter # 423023 – look for # “041692” stamped on housing.



Service Tips -- Measuring Pump Resistance @ Control Module (1)

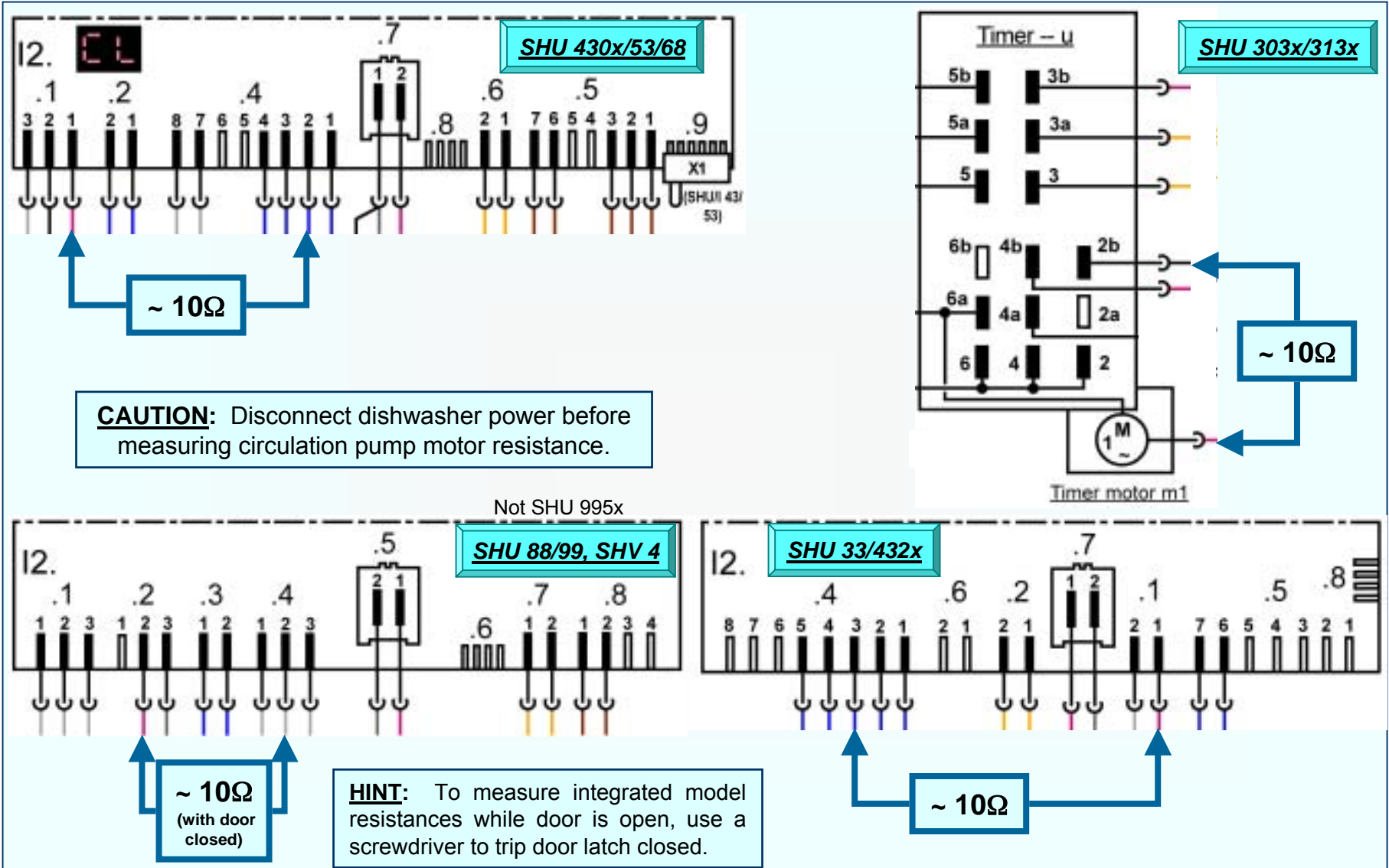

Service Tips -- Measuring Pump Resistance @ Control Module (2)

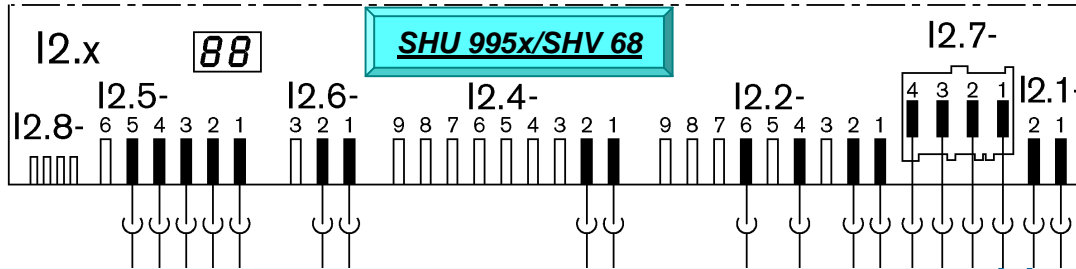

HINT: To measure integrated model resistances while door is open, use a screwdriver to trip door latch closed.



~ 10Ω (with door closed)

HINT: Can also measure between **VT** wire on terminal # 2 on **e1** door switch and **GY** wire on module terminal **I2.7-1**.

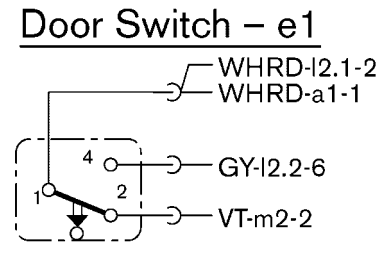

CAUTION: Disconnect dishwasher power before measuring circulation pump motor resistance.

Service Tips -- Impeller Troubleshooting

Symptom	Problem	Solution
Impeller won't turn.	Impeller is frozen.	Replace impeller with impeller kit # 167085 . If not able to replace impeller immediately, place 8mm nutdriver on 8mm stud on impeller and rotate clockwise twice until impeller is freed up (for temporary fix until impeller can be replaced).
Impeller won't turn.	Debris binding pump.	Open sump & remove sump pump cover, then carefully remove debris from impeller. Check for broken glass to avoid being cut.
Impeller won't turn.	Motor is faulty.	Check resistance at motor terminals or at control panel (~ 7Ω with water switch or 10Ω without). Replace motor if faulty.

WARNING! Unplug dishwasher before starting any repairs.

Service Tips -- Replacing Impellers (1)

Occasionally, a circulation pump impeller can stick if a dishwasher hasn't been used for a long time. Impeller ceramic rings and carbon rings had been changed (during January, 2001) to reduce or eliminate impeller sticking (ceramic rings are located around shaft on rear of impeller). For temporary repairs when impeller replacement isn't possible, impellers can be loosened by rotating them (accessed through the sump) using an **8mm** nut driver (impellers should be replaced shortly thereafter when repairs are possible).

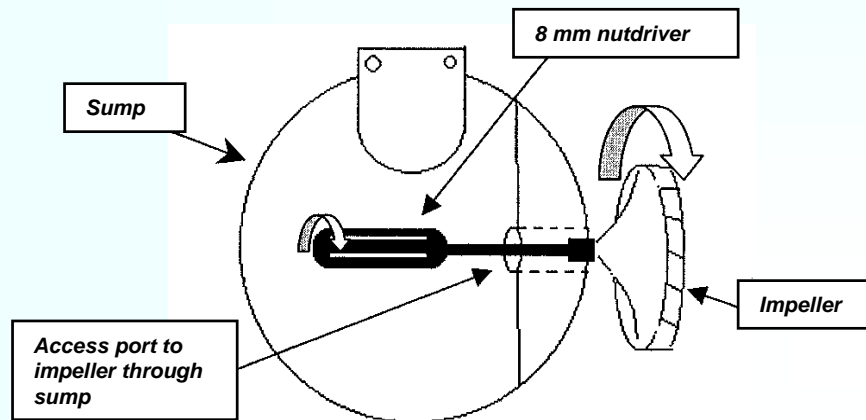

NOTE: Impellers should be replaced, not loosened, whenever possible. Loosening impellers should only be done as a temporary fix.

INSTRUCTIONS FOR LOOSENING IMPELLER: To loosen stuck impeller, access sump by removing microfilter and sump screen. Insert an 8mm nutdriver through sump hole to impeller -- place nutdriver onto 8mm stud on impeller and carefully rotate impeller clockwise until it becomes free (at least two full revolutions).

NOTE: Upgraded spacers and ceramic rings (January, 2001 and later) provide lower friction and less contact area, preventing impeller sticking when dishwashers haven't been used for long periods of time.

HINTS:

- ✓ **Upgraded impellers fit all pumps regardless of age or type (2 or 3-winding).**
- ✓ **Check color of impeller ceramic rings to those shown below – replace impellers if they have dull white or cream ceramic rings.**
- ✓ **Make sure black spacer is reinstalled -- failure to reinstall spacer can cause motor to bind.**

HINT: Impeller ceramic ring color code:

Bright white -- **upgraded ring**

Pink -- **upgraded ring**

Dull yellow/cream -- **old ring (impeller should be replaced)**

Dull white (off white) -- **old ring (impeller should be replaced)**



Service Tips -- Replacing Impellers (2)

“Softer bearing” circulation pump supported by rubber straps

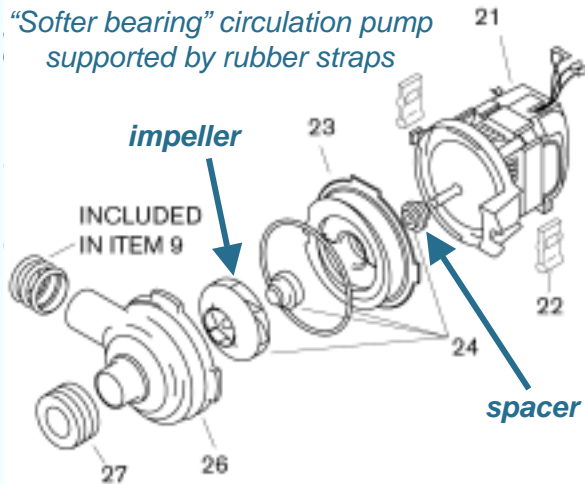

Occasionally, a circulation pump will jam when debris gets caught inside (when the sump filter wasn't tightened down) or when a dishwasher hasn't been used for months. Often circulation pumps are replaced when merely changing the **impeller** (kit # **167085**, item # **24**) will solve the problem.

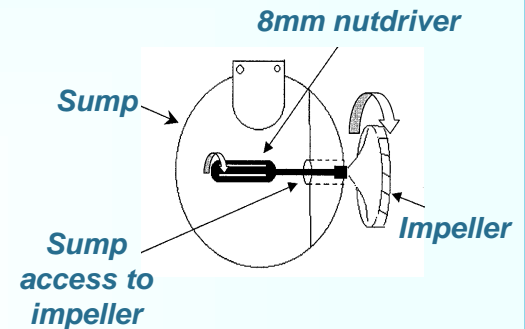

CAUTION: When replacing an impeller, install the black spacer between the pump motor and the rear pump housing. Failure to do so may lock up the pump and damage the rear pump housing!



HINT: When replacing an impeller, instruct the customer to tighten the sump filter properly to avoid future problems.

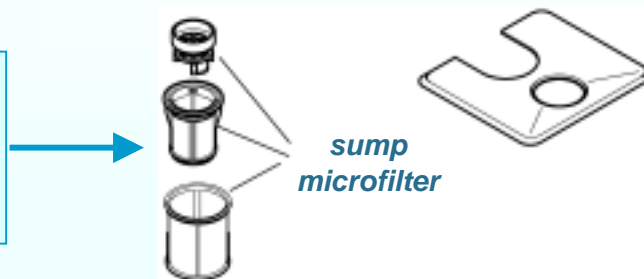

“Old” style circulation pump supported by rubber bushings

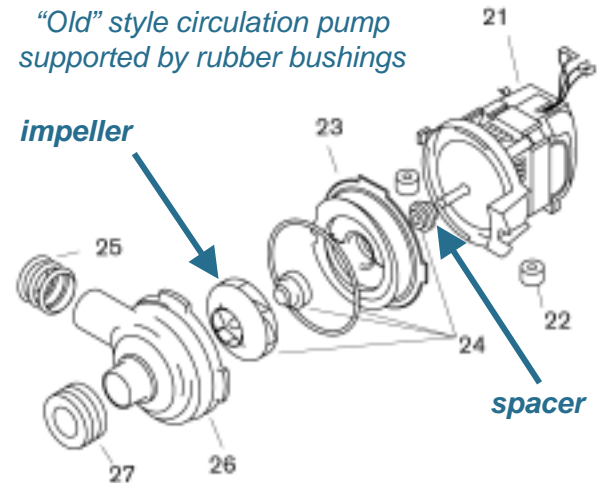

Service Tips -- Replacing Impellers (3)



Replacement impellers will have a **green** tint compared to older impellers. The impeller ceramic ring should be **pink** or bright white.

Note **pink** ceramic ring around impeller shaft.

NOTE: Starting January, 2003, carbon rings were upgraded with a smaller contact surface and an improved contact surface treatment. **167085** impeller kits include these upgraded carbon rings.

Impeller kit # **167085**, showing front and rear sides of impeller and carbon ring (spring).

HINT: To remove or temporarily break loose an impeller, place a 8mm nut driver (or similar tool) on 8mm stud in center of impeller. Freed impellers should be replaced as soon as possible.

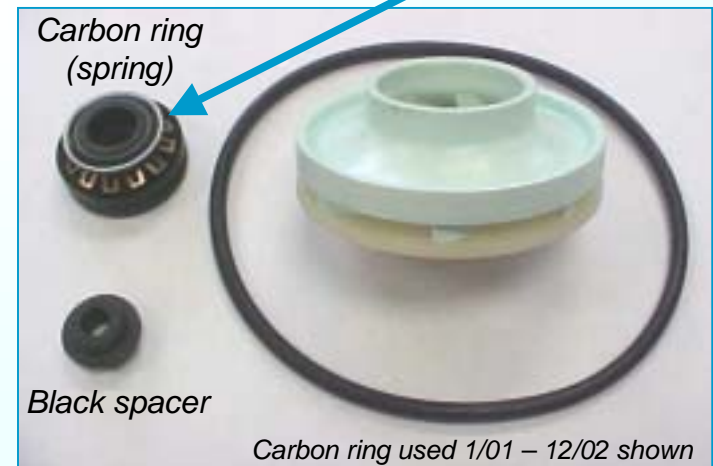



Service Tips -- UC/07, 11 & 12 Parts Changes

<i>Part description</i>	<i>Old part #</i>	<i>Models used on</i>	<i>Softer bearing part #</i>	<i>Models used on</i>
Circulation pump	263835 (motor only)	All models (index #'s UC/06 & UC/09)	491434 (pump) or 266511 (motor only)	All models (index #'s UC/07, UC/11 & UC/12)
Pump support bushings	167244	All models (index #'s UC/06 & UC/09)	-----	-----
Pump support straps	-----	-----	171596	All models (index #'s UC/07, UC/11 & UC/12)
Gasket (pump to heater)	165268	All models (index #'s UC/06 & UC/09)	-----	-----
Pipe clamp (pump to heater)	-----	-----	172272	All models (index #'s UC/07, UC/11 & UC/12)
Pump rear housing	263314	All models (index #'s UC/06 & UC/09)	267739	All models (index #'s UC/07, UC/11 & UC/12)
Pump front housing	263838	All models (index #'s UC/06 & UC/09)	266514	All models (index #'s UC/07, UC/11 & UC/12)
Seal (pump to sump)	165269	All models (index #'s UC/06 & UC/09)	171598	All models (index #'s UC/07, UC/11 & UC/12)

NOTE: Most circulation pump part #'s have changed due to the “softer bearing” upgrade -- the circulation pump has been suspended by flexible straps instead of being mounted onto the base (onto rubber bushings) to make the dishwashers quieter. The impeller kit hasn't changed – its still # **167085**.

NOTE: Parts can be changed without notice. Please refer to published CD parts lists for up to date part #'s.



Service Tips -- UC/14 Water Switch Parts Changes

<i>Part description</i>	<i>Old part #</i>	<i>Models used on</i>	<i>Water switch part #</i>	<i>Models used on</i>
Circulation pump	491434 (pump) or 266511 (motor only)	All models (index #'s UC/07, UC/11 & UC/12)	437345 (pump)	All <i>ExactWash</i> & <i>Apexx</i> models (index # UC/14)
Pump motor starter	-----	-----	182318	All <i>ExactWash</i> & <i>Apexx</i> models (index # UC/14)
Heater assembly	Various	Various	219639 or 431412	All <i>ExactWash</i> & <i>Apexx</i> models (index # UC/14)
Sump	263103	All models (index #'s UC/07, UC/11 & UC/12)	482035	All <i>ExactWash</i> & <i>Apexx</i> models (index # UC/14)
Pump support straps	171596	All models (index #'s UC/07, UC/11 & UC/12)	171596	All models (index #'s UC/07, UC/11, UC/12 & UC/14)
Pipe clamp (pump to heater)	172272	All models (index #'s UC/07, UC/11 & UC/12)	172272	All models (index #'s UC/07, UC/11, UC/12 & UC/14)
Pump rear housing	267739	All models (index #'s UC/07, UC/11 & UC/12)	267739	All models (index #'s UC/07, UC/11, UC/12 & UC/14)
Pump front housing	266514	All models (index #'s UC/07, UC/11 & UC/12)	266514	All models (index #'s UC/07, UC/11, UC/12 & UC/14)

NOTE: This affects (*ExactWash* & *Apexx*) models with water switches -- **SH_56, SHV/Y66 & SH_99**.

NOTE: Parts can be changed without notice. Please refer to published CD parts lists for up to date part #'s.



NOTE: This does **not** affect (*Sensotronic*) UC/14 models without water switches. They use the same parts used on models from UC/06 through UC/12.

Service Tips -- Pump & Motor Part #'s Change

The softer bearing (UC/07, UC/11 & UC/12 index) circulation pump and motor only part #'s for all **B**, **Thermador** & **G** models have been changed to make parts ordering more consistent throughout the world. All parts in stock have been changed to new part #'s as follows:

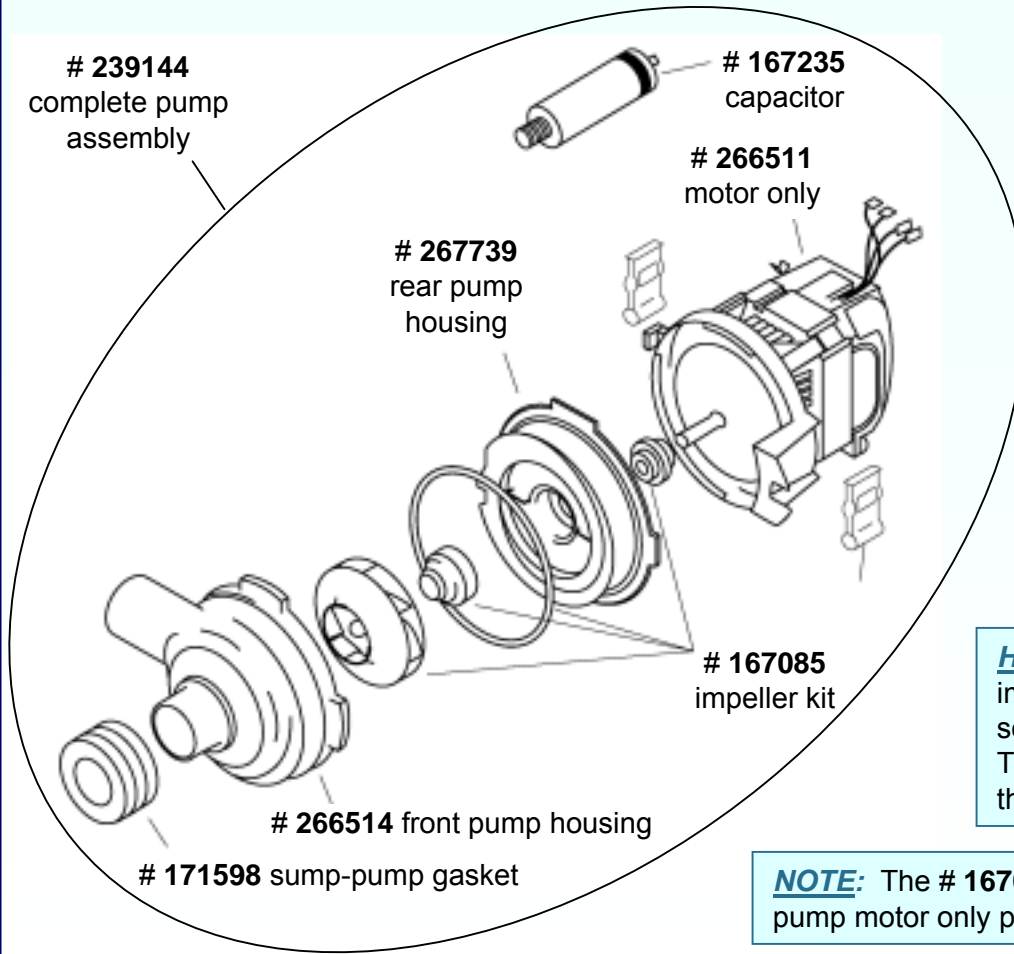

- **239144** -- complete circulation pump assembly (with impeller) for all **B**, **Thermador** & **G** models with softer bearing (models with index #'s UC/07, UC/11 & UC/12).
- **266511** -- circulation pump motor only for all **B**, **Thermador** & **G** models with softer bearing (models with index #'s UC/07, UC/11 & UC/12).

NOTE: The circulation pump assembly part # has been changed from # **266511** to # **239144**. Please check all pumps ordered or already in stock to make sure they show part # **239144**.

HINT: The preferred repair for replacing pump impellers is the # **167085** impeller kit. The other solution is using complete pump assembly # **239144**. The # **266511** pump motor only should only be used if the motor fails (which rarely happens).

NOTE: The # **167085** impeller kit and # **263835** index UC/06 circulation pump motor only part #'s have not changed and still are used.

Part # 3 -- Control Module (1)

Disassembly *(SHU 9922 shown)*

Control modules are easily removed from fascia panels by bending console tabs.

- ⚡ Remove fascia panel by removing T-20 Torx inner door screws.
- ⚡ Disconnect wire harnesses from module after noting connector locations.
- ⚡ Pry out metal console tabs holding module to console.
- ⚡ Carefully pry back plastic tabs, then slide module from console.



Removing door screws



Removing fascia panel



Viewing control module



Disconnecting wires



Bending back tabs



Sliding module out



Console without module

NOTE: Control modules for non-integrated models look differently and have different tabs, but are removed using the same procedure.

Part # 3 -- Control Module (2)

Disassembly *(SHU 995x shown)*

SL95A, SHY56A/66C, SHU 995x & SHV 68 control modules are different than other models and are removed differently.

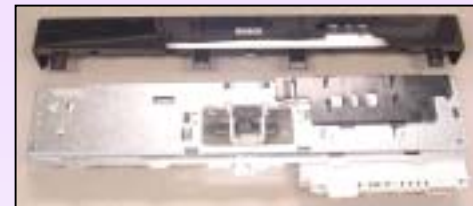

These instructions apply to SL95A, SHY56A/66C, SHU 995x & SHV 68 models.

- ✦ Remove fascia panel by removing six (6) T-20 Torx inner door screws.
- ✦ Disconnect wire harnesses from module after noting connector locations.
- ✦ Remove fascia panel from console by removing four (4) T-20 Torx screws.
- ✦ Remove two (2) T-20 Torx screws holding module to console.
- ✦ Carefully pry back locking tabs on each front corner of module, then remove module from console. Remove button pad from module.



Removing door screws



Removing fascia screws



Removing module screws



Prying back module tabs



Sliding module out



Removing button pad -- buttons can come off pad

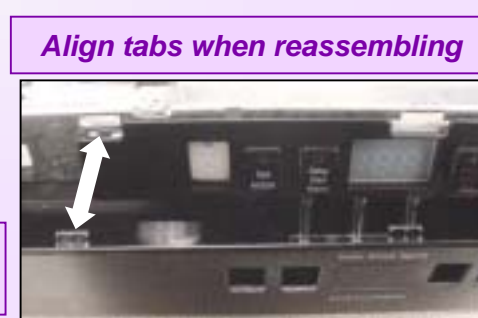

Align tabs when reassembling

Part # 3 – Control Modules with Displays

Disassembly

SHY66C control modules have separate 3-digit display modules (# 489021) mounted on the front of fascia panels.



These instructions apply only to SHY66C models.

To remove/install display module:

- ✦ Remove outer door & fascia panel.
- ✦ Confirm the (4) pushbutton carrier display latches are intact.
- ✦ Route display wire harness through (door latch) console opening, press harness onto pushbutton carrier wire guide & connect terminal.
- ✦ Insert display into top latches (on pushbutton carrier), then push bottom of display up and rotate it into bottom latches.

wire guide



1 Removing door & fascia

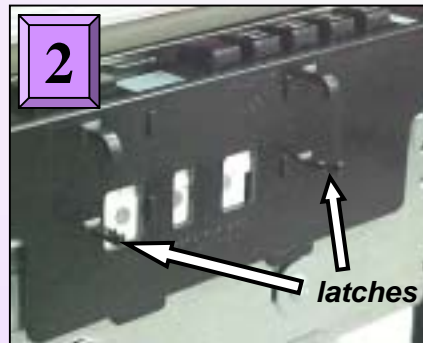

2 Checking display latches

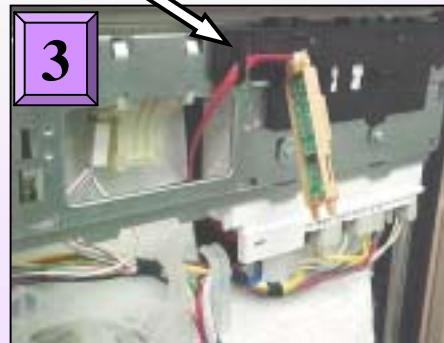

3 Connecting wire harness

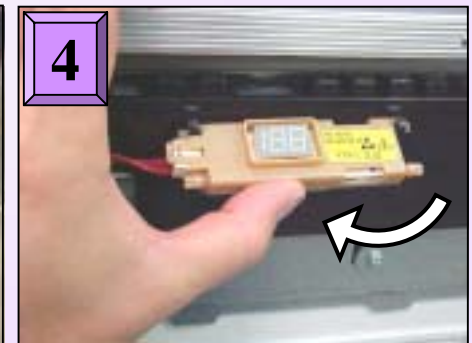

4 Locking display in place

Part # 3 – Apexx Control Modules (1)

Disassembly



These instructions apply to SHV/SHX/SHY99A models.

Apexx (SHV99A/SHX99B/SHY99A) control modules are different than other models and are removed differently. Modules are mounted on the **base** (where base wiring connectors were), not behind fascia panels. This means:

- ***Dishwashers must be pulled out to change control modules.***
- ***Dishwashers must be pulled out to measure voltages & resistances -- dishwashers cannot be diagnosed from the front.***

HINT: *Its not necessary to remove outer doors to access Apexx control modules.*

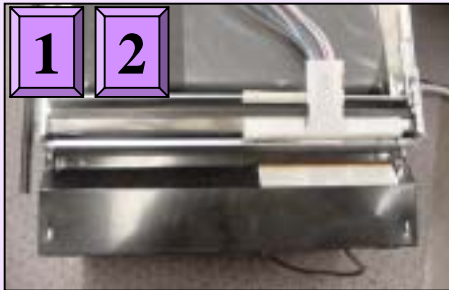

To remove toe kick:

- ✖ Remove two (2) T-20 Torx screws from toe kick (1).
- ✖ Tilt toe kick out from under dishwasher (2).

NOTE: *Modules were moved to the base to make room for the larger full text displays in the fascia panel.*

HINT: *Apexx control modules cannot be checked or have resistances measured from the front of dishwashers.*

HINT: *It may be possible to reach behind modules without blocking up tanks. If not, then follow these instructions to block up tanks.*

Part # 3 -- Apexx Control Modules (2)

To remove right & left side panels (where necessary):

- ✖ Remove two T-20 Torx side panel screws through holes in left & right trim strips (1).
- ✖ Carefully slide trim strips up and out of dishwasher (2). If side panels are removed carefully to avoid damaging trim strips, then trim strips don't need to be removed.
- ✖ Lift side panels up and out from dishwasher (3). Panels can be removed with trim strips. Although removing the left side panel isn't necessary for access, it does allow the right side of the tank to be blocked upward.

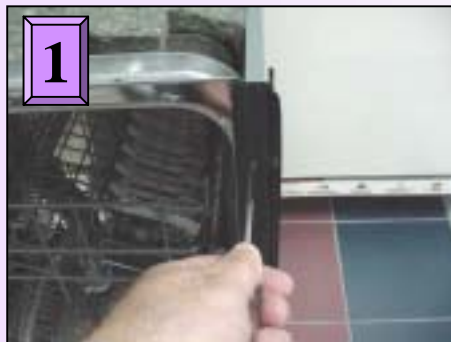

Removing trim strip screws



Removing trim strips



Removing side panels

HINT: Apexx control modules cannot be checked or have resistances measured from the front of dishwashers.

HINT: It may be possible to reach behind modules without blocking up tanks. If not, then follow these instructions to block up tanks.

Part # 3 -- Apexx Control Modules (3)

To raise right side of tank for Apexx module access (where necessary):

- ✂ Remove one T-20 Torx screw from both rear corners holding tank to base (1) -- removing screw from both sides allows tank to be blocked upward.
- ✂ Remove right toe kick bracket by removing T-20 Torx screw (2).
- ✂ Remove T-20 Torx screws from front right bottom corner holding tank to base (3).
- ✂ Remove right hinge cover (4a), release right door tension cord from hinge (4b) & remove ground wire (4c).
- ✂ Raise and block up tank as shown with strut onto base (5a), sliding a piece of wood or other solid material between the tank and base to keep tank from falling back onto base (5b).

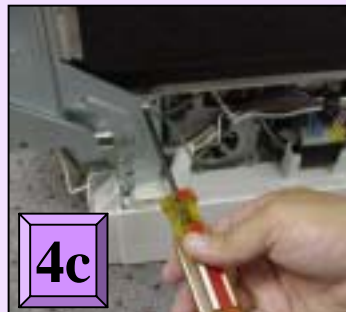
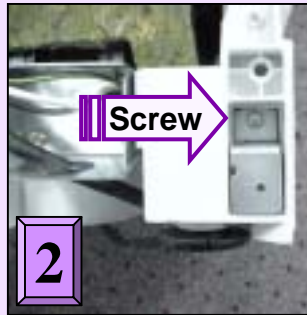

CAUTION: Its not recommended to turn dishwashers upside-down for tank access. When dishwashers are turned upside-down, water can flow into the diaphragm of the water fill assembly and cause water to not fill properly.

Part # 3 -- Apexx Control Modules (4)



1 Locating module in base



2 Opening module cover



3 Disconnecting module terminals

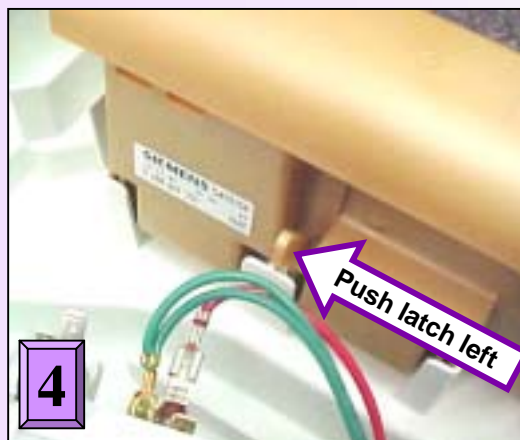

4 Pushing back module latch



5 Sliding module out

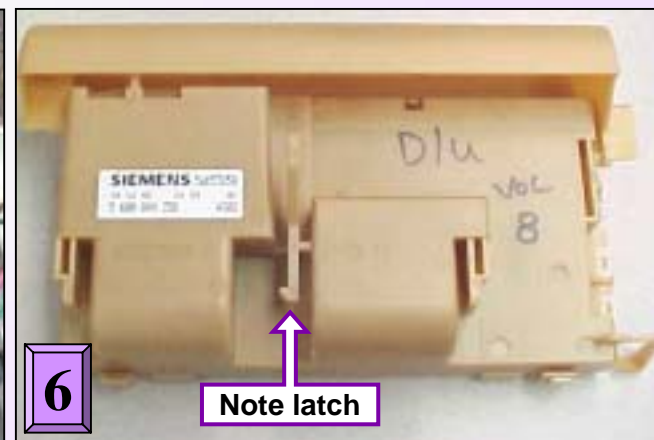

6 Align module tabs when reassembling

HINT: Apexx control modules cannot be checked or have resistances measured from the front of dishwashers.

Part # 3 – Apexx Display Modules

Disassembly



These instructions apply to SHV/SHX/SHY99A models.

NOTE: Control modules were moved to the base to make room for the larger full text displays in the fascia panel.

Apexx (SHV99A/SHX99B/SHY99A) display modules are mounted on fascia panels (where control modules are mounted on other models).

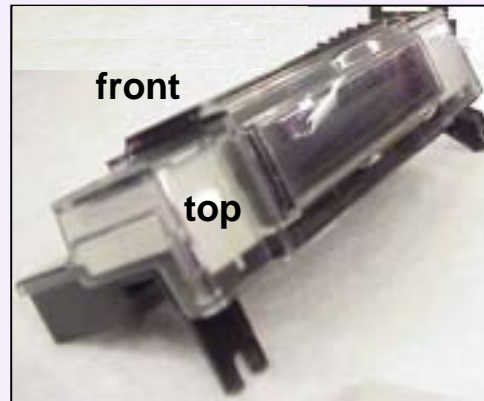

1

Removing fascia screws

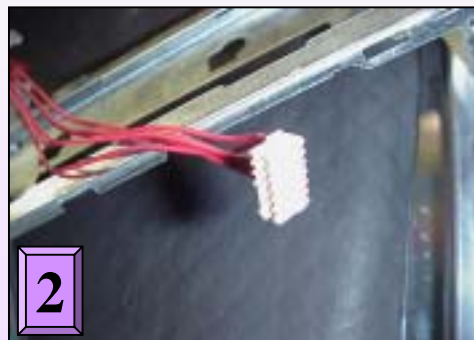

2

Removing wire harness



3

Removing display module

Service Tips – Test Programs (1)

Using test programs for various models (UC/06 - UC/17)

Models	Buttons to Enter Test Program
SHU/SHI430x, SHU431x	Power Scrub Plus + Regular Wash
SHU33/DLX	Power Scrub Plus + Rinse & Hold
SHU43C, SL34A, SHU432x	Regular Wash + Rinse & Hold
SHU53/66C/68, SHI66A/68	Scrub Wash + Delicate/Econo
SHU53A, SHX/SHY56, SL95A	Regular Wash + Quick Wash
SHU88	Power Scrub Plus + Quick Wash
SHU990x, SHV43/48	Power Scrub Plus + Regular Wash
SHU991x (thru UC/11)	Power Scrub Plus + Quick Wash
SHU991x (UC/12), SHU992x	Power Scrub Plus + Delicate/Econo
SHU995x	Regular Wash + Delicate Wash
SHV66A, SHY66A	Scrub Wash + Delicate/Econo
SHV68	Scrub Wash + Regular Wash
GI976/966, GM276	Intensive + Delicate
DW44	Heavy Wash + Light Wash

- ◆ To enter test programs, hold down buttons above (2nd & 4th from left), then turn dishwasher on by pushing on/off button. Push buttons above a 2nd time to start test program. Allow program to finish to see fault codes. Turn dishwasher off to exit test program.

Example of a Test Program (varies by model)

TEST	TIME	NOTES
Entering test program	----	Press <i>On/Off</i> button at the same time you press both the <i>Power Scrub Plus</i> & <i>Regular Wash</i> buttons (SHU/43 models) or the <i>Scrub Wash</i> & <i>Delicate/Econo</i> buttons (SHU/53 & 68 models). Indicating lights will flash.
Starting test program	----	Press both the <i>Power Scrub Plus</i> & <i>Regular Wash</i> buttons (SHU/43 models) or the <i>Scrub Wash</i> & <i>Delicate/Econo</i> buttons (SHU/53 & 68 models) a 2nd time.
Skipping a test	----	Press <i>Scrub Wash</i> button (SHU/43 models) or <i>Regular Wash</i> button (SHU/53 & 68 models).
Draining	30 seconds	Allow dishwasher to drain.
Aqua Sensor calibration	65 seconds	Not on SHU/43 models. <i>Skip this test.</i>
Filling	Until water level switch closes	Can't skip this test
Heating & Circulating	Until water reaches 150°F (rises ~ 2°F/minute)	Don't run entire test (to save time) -- when water starts circulating, measure current in main power line to dishwasher. Skip test once current has been measured. If current is ~ 11A, heater, flow switch and Hi-Limit are OK. If current ~ 1.5-2A, turn off dishwasher, remove or block up tank and measure resistance of heater, Hi-Limit & flow switch (see below).
Draining	60 seconds	Last test. To end test program, press <i>On/Off</i> button (all models).

HINT: Dishwasher test programs heat water to 150°F, so test programs will generally run > 20 minutes for incoming water temperatures ~ 120°F.

HINT: Open door to select test program for fully-integrated models, then close door to run program.

NOTE: Flow through heaters heat water ~ 2°F / minute.

Service Tips – Test Programs (2)

Using test programs for various models (UC/14 - UC/17)

Models	Buttons to Enter Test Program
SHV46C, SL84A, SHX43E/ 46A-B	Regular Wash + Delicate/Econo
SHX33A	Regular Wash + Rinse & Hold
SHU43E/53E/66E	Turn knob (see below) + Start/Stop
SHV99, SHX99, SHY99	(2) left buttons (see below)

HINT: Dishwasher test programs heat water to 150°F, so test programs will generally run > 20 minutes for incoming water temperatures ~ 120°F.

HINT: Open door to select test program for fully-integrated models, then close door to run program.

NOTE: Flow through heaters heat water ~ 2°F / minute.

◆ To enter SHV46C, SL84A, SHX33A/43E/ 46A-B test programs, hold down buttons above (2nd & 3rd from left of three test program buttons), then turn dishwasher on by pushing on/off button. When in test program, 2nd button light (Regular Wash) will be lit and 3rd button light will flash. Push 2nd button (Regular Wash) to scroll until test program is chosen -- when 3rd button light is lit (○ ○ ●). Push 3rd button to start test program. Allow program to finish to see fault codes. Push 2nd button (Regular Wash) to skip certain steps. Turn dishwasher off to exit test program.

◆ To enter SHV/X/Y99 test programs, open door, hold down 2 left buttons & turn dishwasher on by pushing on/off button. Press "+" button repeatedly until "S-3-" shows on display, then push start button to check faults on last 8 washes. Close door to begin test program. Allow program to finish to see fault codes. Push "-" button to skip test steps. Turn dishwasher off to exit test program. Choose "S-6-" to clear fault codes.

◆ To enter SHU43E/53E/66E test programs, 1st rotate knob to 6:00 position (pointing straight down). Hold down Start/Stop button, then turn dishwasher on by pushing on/off button. Push Start/Stop button to start test program. When test program has finished, Clean light light will flash and all other lights will be lit.

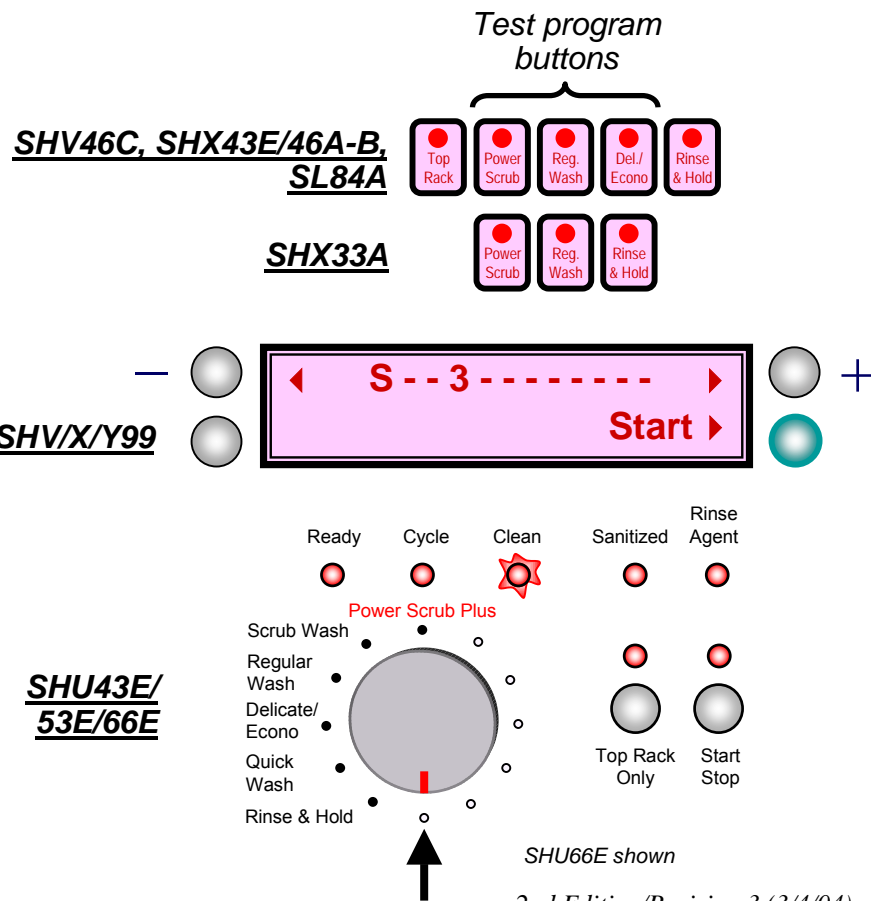

Service Tips – Fault Codes (1)

DISHWASHER TEST PROGRAM ERROR CODES (on 2 & 3-digit digital displays):

- ✘ 0 – No faults
- ✘ 1 – Aqua Sensor (Sensotronic) fault
- ✘ 2 – Heating system fault (heater, Hi-Limit, flow switch, NTC, control heater relay)
- ✘ 4 – Water filling fault
- ✘ 8 – NTC (temperature sensor) fault
- ✘ 16 – Water switch fault

00

000

TIP: Fault codes add up for multiple faults (e.g. heating + water filling fault = 2 + 4 = 6)

HINT: Apexx heater runs during steps 05 – 08. Press “.” button to skip to test 05 to measure heater amp draw.

DISHWASHER CUSTOMER USE ERROR CODES (on 2 & 3-digit digital displays):

- ✘ F – Water filling fault (underfill, overflow or water in the base)
- ✘ 2H – Last wash cycle too long (> 99 minutes). Can be cold inlet water or heating system fault (heater, Hi-Limit, flow switch, NTC, control module heater relay).
- ✘ _h – Delay Start feature (not a fault code)

00

000

DISHWASHER TEST PROGRAM ERROR CODES (on lower line of full text Apexx SH 99 displays):

- ✘ S3 – No faults
- ✘ A – Aqua Sensor (red) fault
- ✘ B – Aqua Sensor (green) fault
- ✘ E – Water switch fault (no pulses detected)
- ✘ F – Water filling fault
- ✘ G – Water switch fault (won't stop running)
- ✘ H – Heating system fault (heater, Hi-Limit, flow switch, NTC, control module heater relay)
- ✘ K – NTC fault (short-circuited or open-circuited)
- ✘ xx – Test program step count (testing done when = 00)

Selecting test program

Checking fault codes

Test program steps

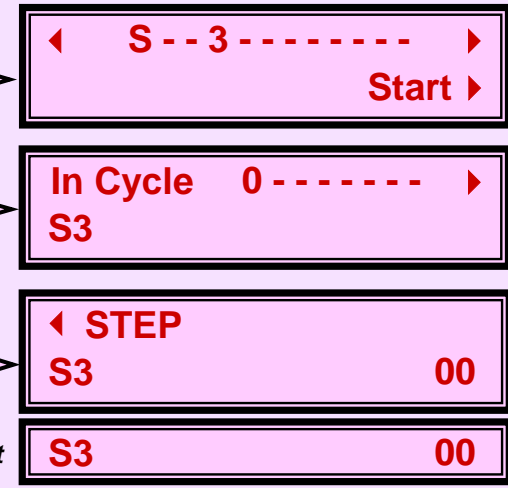

TIP: Top line shows wash cycle & bottom line shows fault code.

HINT: Dishwasher test programs heat water to 150°F, so test programs will generally run > 20 minutes for incoming water temperatures ~ 120°F.

HINT: Open door to select test program for fully-integrated models, then close door to run program.

NOTE: Flow through heaters heat water ~ 2°F / minute.

Service Tips – Fault Codes (2)

DISHWASHER TEST PROGRAM ERROR CODES (on SHX33A/43E/46A-B, SHV46C, SL84A models):

- ✘ ○ ○ ● – Heating system fault (heater, Hi-Limit, flow switch, control heater relay)
- ✘ ○ ● ○ – NTC (temperature sensor) fault
- ✘ ○ ● ● – Water filling fault
- ✘ ● ○ ○ – N/A
- ✘ ● ○ ● – N/A
- ✘ ● ● ○ – Aqua Sensor (Sensotronic) fault
- ✘ ● ● ● – N/A

Fault code LED's

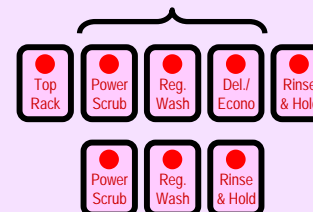

SHV46C, SHX43E/46A-B, SL84A

SHX33A

TIP: Fault codes do NOT add up for multiple faults – shows highest fault code on list above (1st – heating, 2nd – NTC, 3rd – water filling, 4th – aqua sensor)

DISHWASHER TEST PROGRAM ERROR CODES (on SHU43E/53E/66E models):

Faults	LED Fault Codes			
0 - No faults	READY	CYCLE	CLEAN	NSF
1 - Heater Element	READY	CYCLE	CLEAN	NSF
2 - Water Filling	READY	CYCLE	CLEAN	NSF
3 - NTC	READY	CYCLE	CLEAN	NSF
4 - Aquasensor	READY	CYCLE	CLEAN	NSF

- LED flashes
- LED lit
- LED off

NOTE: Flow through heaters heat water ~ 2°F / minute.

HINT: Open door to select test program for fully-integrated models, then close door to run program.

HINT: Dishwasher test programs heat water to 150°F, so test programs will generally run > 20 minutes for incoming water temperatures ~ 120°F.

Service Tips -- Control Module Heater Relays

HINT: Occasionally, a heater relay terminal soldered to a # 266746, 263832 or 264461 control module pc board can burn or have insufficient solder. **If so, do not resolder the relay, but replace the control module.**

The heater relay is the **largest** of three relays in the **center** of the pc board & can be one of two colors:



Black

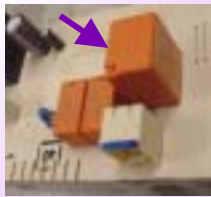

Orange

HINT: Faulty heater relays can cause modules to count down to "1" and stop.

Please hold all warranty parts for (60) days for possible return for analysis.

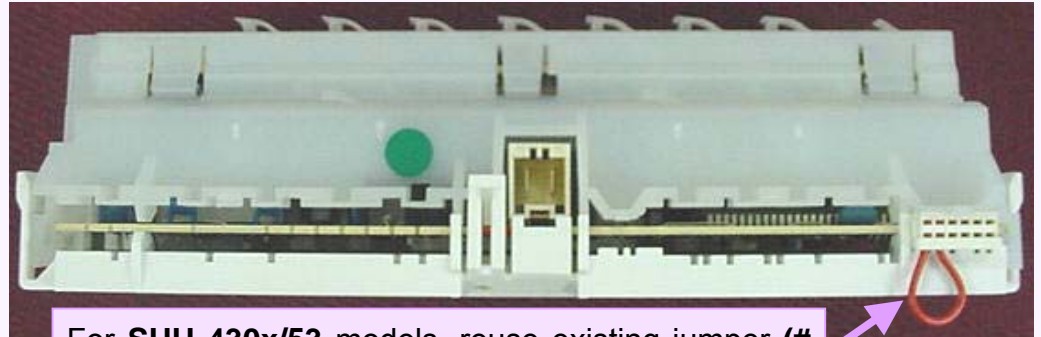

For SHU 430x/53 models, reuse existing jumper (# 167782) for replacement module (SHU 53 shown).

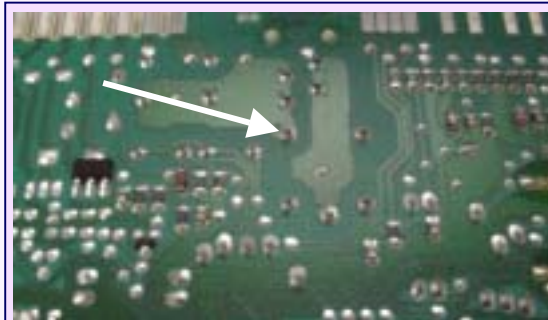

Good board -- showing proper soldering on back of pc board.

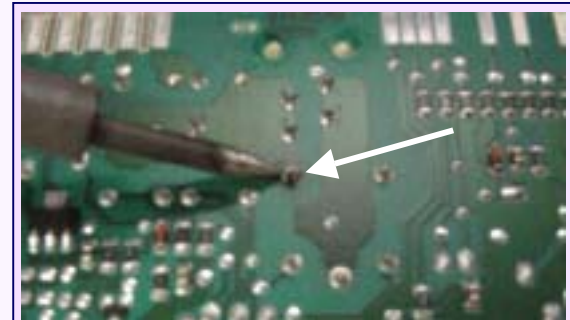

Burned board -- showing burned terminal on back of pc board.

NOTE: Replace all faulty control modules and hold them for (60) days for possible return for analysis. **Do not resolder control module pc boards.**

Service Tips -- Measuring Resistances @ Modules (1)

**SHU 43C/
53A UC/14**

- Wire color codes:
- BK = Black
 - BN = Brown
 - BU = Blue
 - GY = Gray
 - RD = Red
 - WH = White
 - YE = Yellow

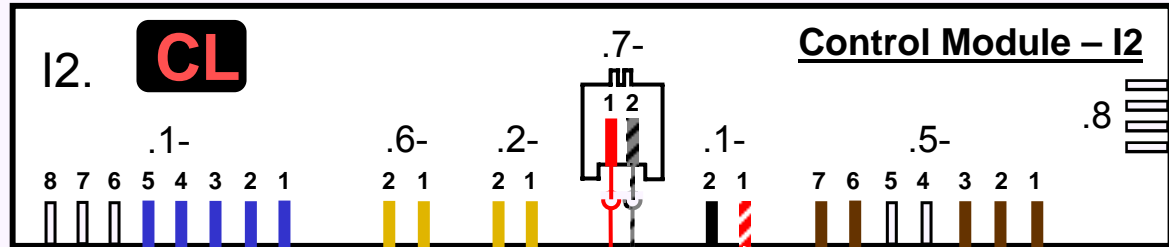

To water fill valve

To water level switch

Resets control module

Measure rinse-aid sensor (~ .4Ω)

Measure dispenser actuator (~ 2150Ω)

To heater, Hi-Limit & flow switch

Measure drain motor (~ 16.5Ω)

Measure circulation motor (~ 10Ω)

To line

To on/off switch

Measure NTC (~ 55kΩ @ 72°F)

To neutral line

To Aqua Sensor

HINT: Water valve and drain motor can be measured from front of dishwasher without accessing control module wire harnesses. Resistances are:

- Water valve ~ 1 kΩ
- Drain motor ~ 16.5Ω

Service Tips -- Measuring Resistances @ Modules (1)

**SHU 33A/43C/
53A UC/17**

Wire color codes:

- BK = Black
- BN = Brown
- BU = Blue
- GY = Gray
- RD = Red
- WH = White
- YE = Yellow

HINT: Water valve and drain motor can be measured from front of dishwasher without accessing control module wire harnesses. Resistances are:

- Water valve ~ 1 kΩ
- Drain motor ~ 16.5Ω

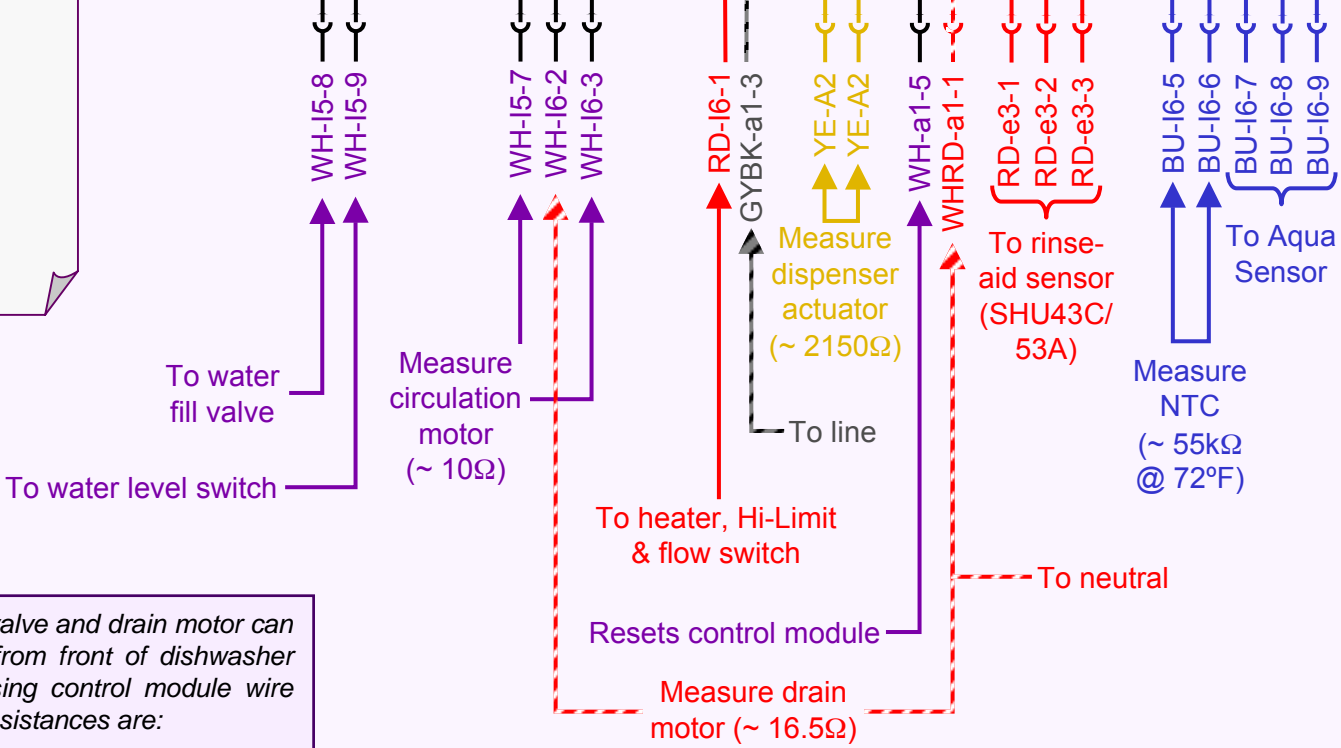
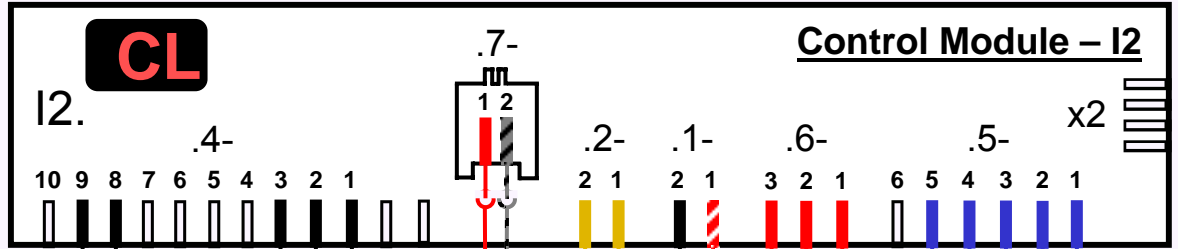

Service Tips -- Measuring Resistances @ Modules (1)

**SHU 43E/
53E/66E**

Wire color codes:

- BK = Black
- BN = Brown
- BU = Blue
- GY = Gray
- RD = Red
- WH = White
- YE = Yellow

HINT: Water valve and drain motor can be measured from front of dishwasher without accessing control module wire harnesses. Resistances are:

- Water valve ~ 1 kΩ
- Drain motor ~ 16.5Ω

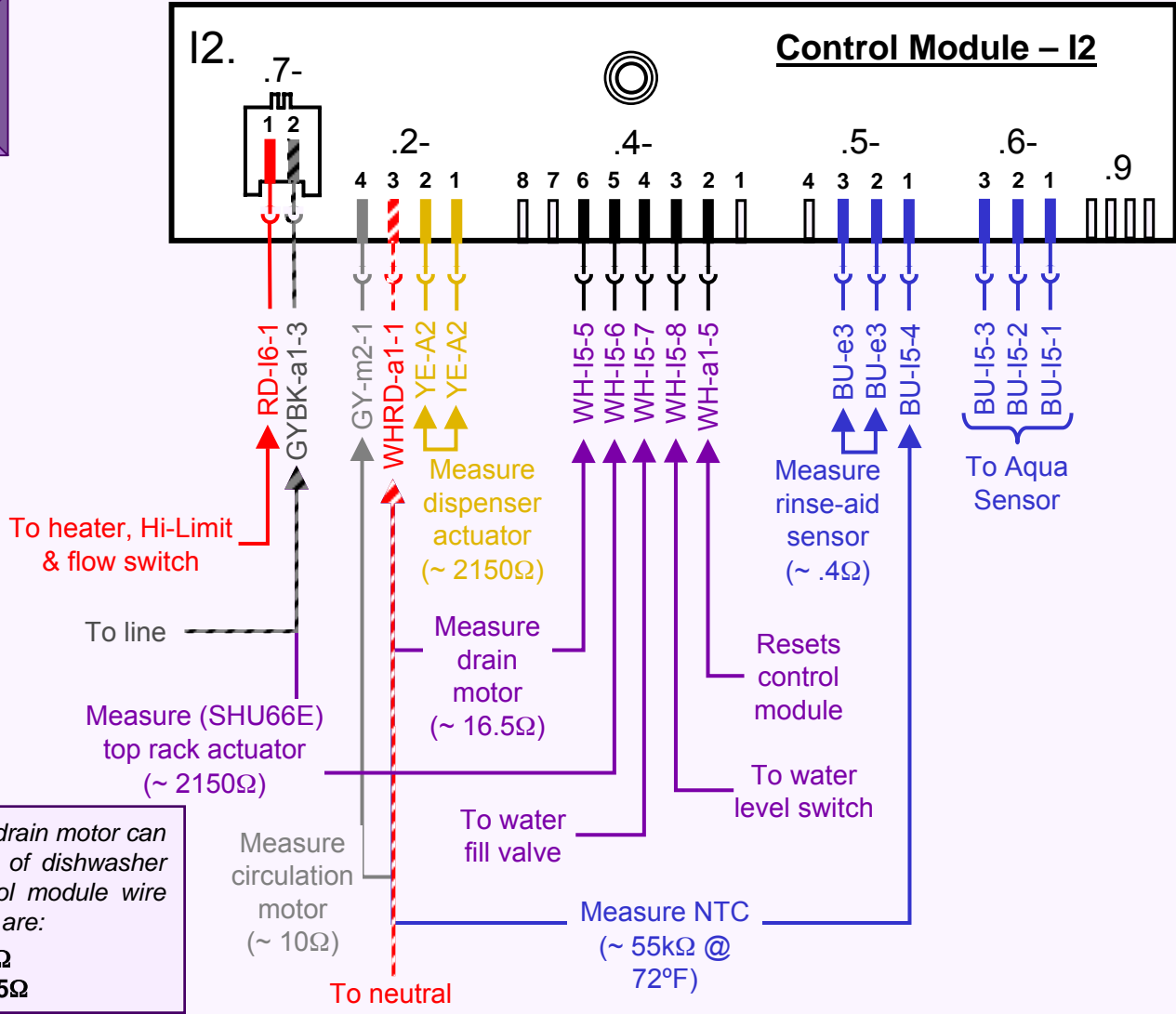

Service Tips -- Measuring Resistances @ Modules (1)

SL34A

Wire color codes:

- BK = Black
- BN = Brown
- BU = Blue
- GY = Gray
- RD = Red
- WH = White
- YE = Yellow

HINT: Water valve and drain motor can be measured from front of dishwasher without accessing control module wire harnesses. Resistances are:

- Water valve ~ 1 kΩ
- Drain motor ~ 16.5Ω

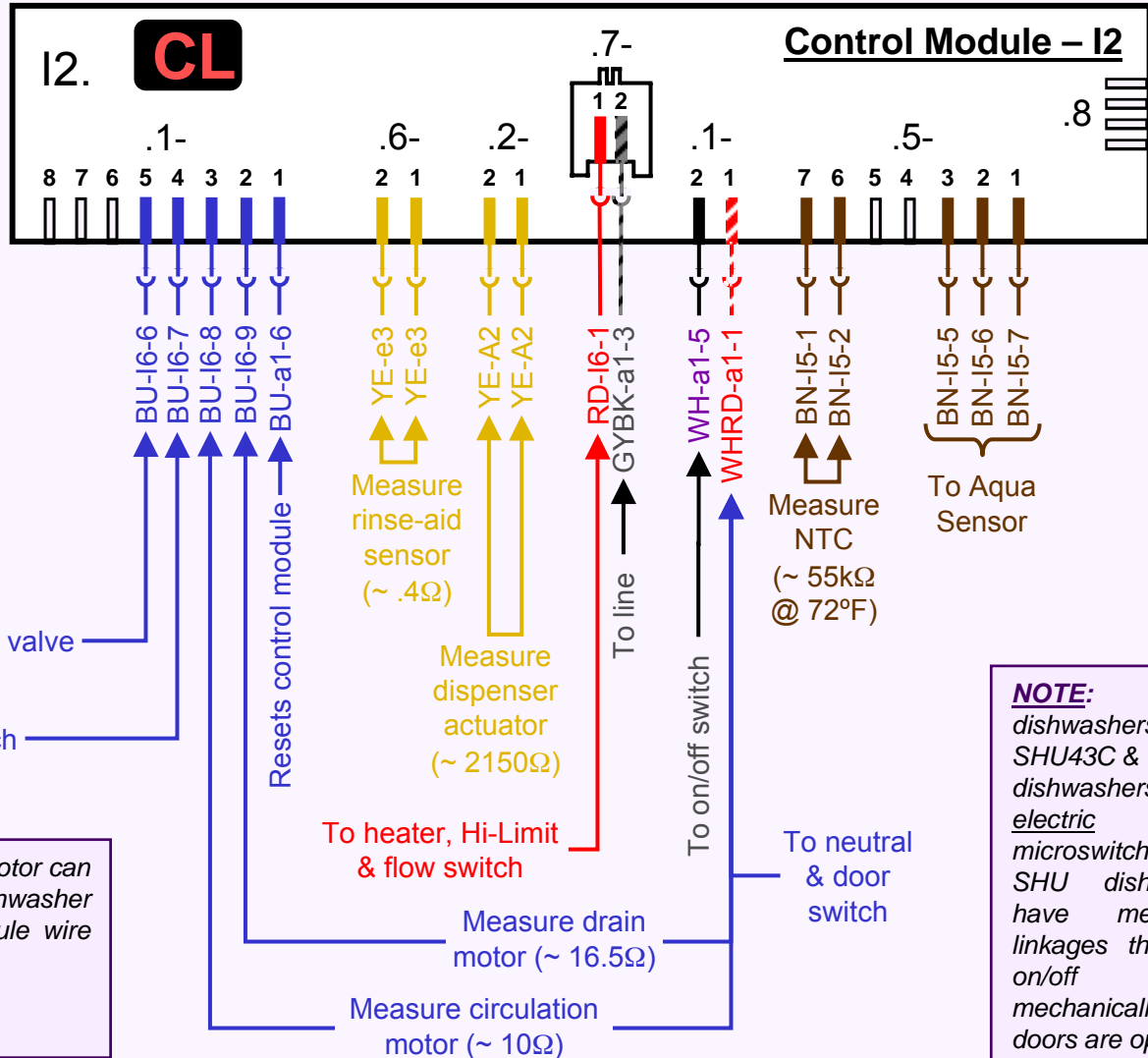

NOTE: SL34A dishwashers, unlike SHU43C & SHU53A dishwashers, have electric door microswitches. All SHU dishwashers have mechanical linkages that open on/off switches mechanically when doors are opened.

Service Tips -- Measuring Resistances @ Modules (2)

SL84A, SHX33A,
SHX43E/46A/B,
SHV46C, DW44



Wire color codes:

- BK** = Black
- BN** = Brown
- BU** = Blue
- GY** = Gray
- RD** = Red
- WH** = White
- YE** = Yellow

HINT: Water valve and drain motor can be measured from front of dishwasher without accessing control module wire harnesses. Resistances are:

- **Water valve ~ 1 kΩ**
- **Drain motor ~ 16.5Ω**

NOTE: This control module measures the NTC differently – measuring voltage (NTC - neutral) instead of current.

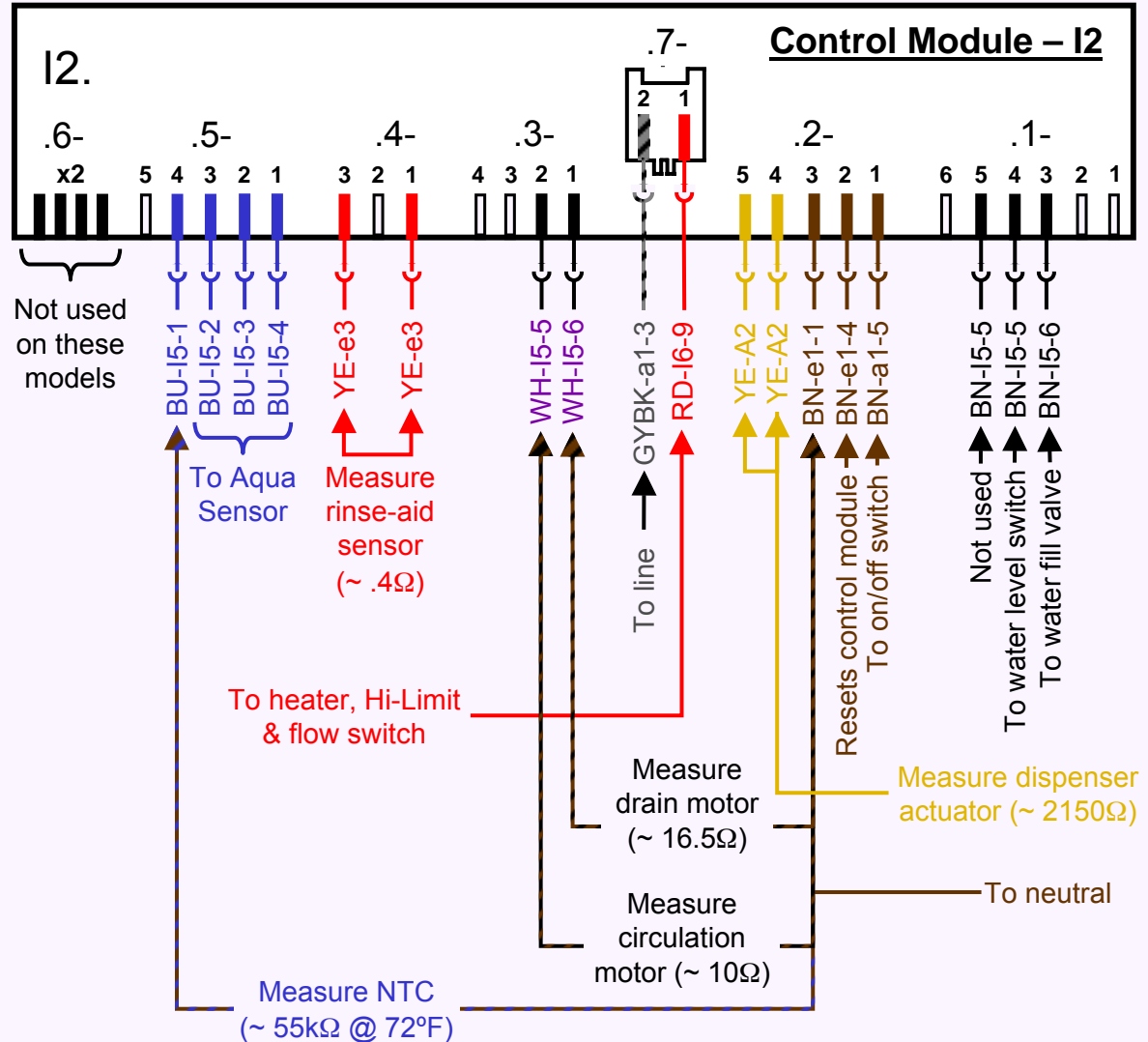

Service Tips -- Measuring Resistances @ Modules (3)

SHU66C, SHI66A

Wire color codes:

- BK** = Black
- BN** = Brown
- BU** = Blue
- GY** = Gray
- RD** = Red
- WH** = White
- YE** = Yellow

HINT: Water valve and drain motor can be measured from front of dishwasher without accessing control module wire harnesses. Resistances are:

- **Water valve ~ 1 kΩ**
- **Drain motor ~ 16.5Ω**

NOTE: These models use the top-load dispenser, which has different actuator & rinse-aid sensor resistances.

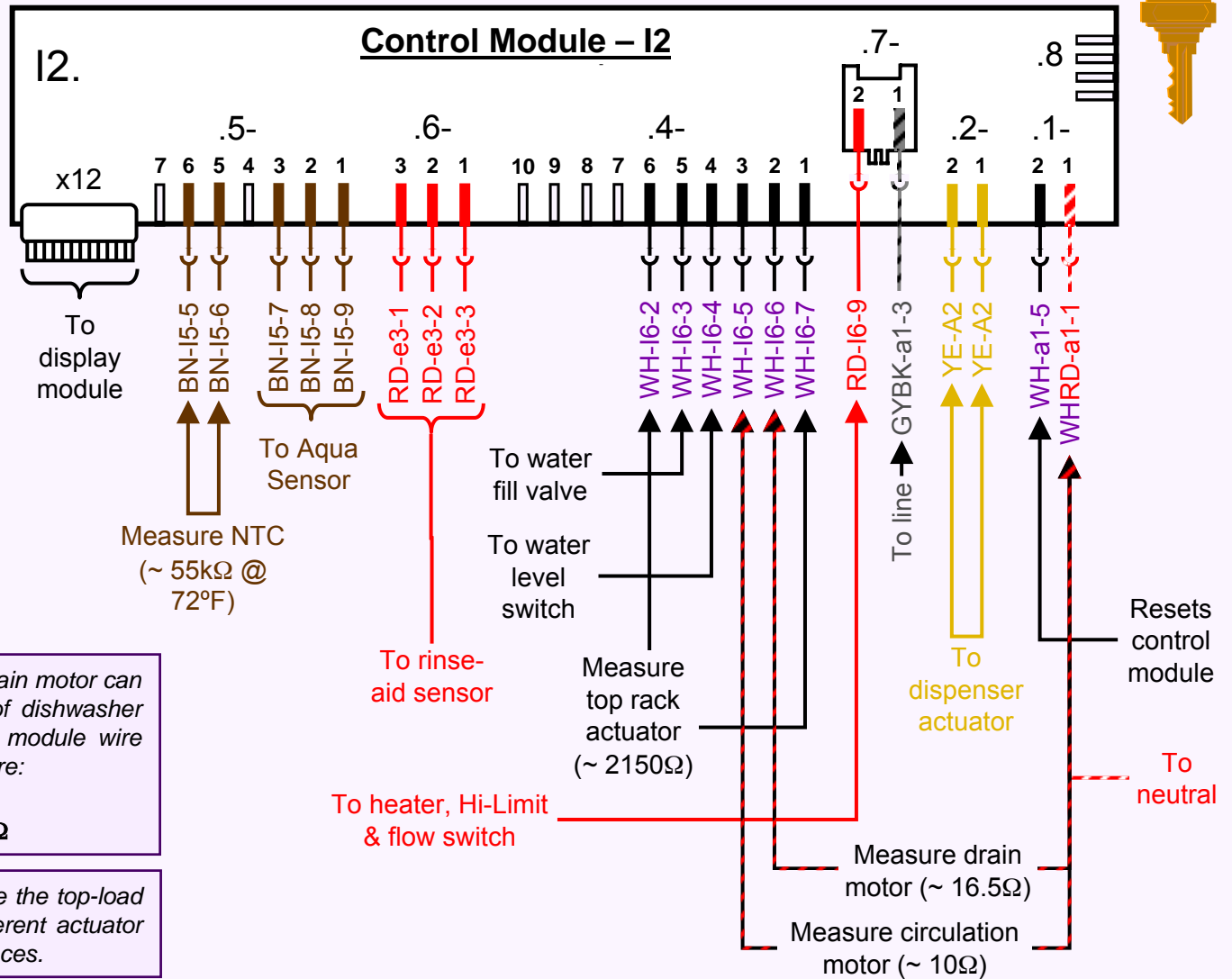

Service Tips -- Measuring Resistances @ Modules (4)

**SL95A,
SHX56B,
SHV66A,
SHY56/66**

Wire color codes:

- BK** = Black
- BN** = Brown
- BU** = Blue
- GY** = Gray
- RD** = Red
- WH** = White
- YE** = Yellow

HINT: Water valve and drain motor can be measured from front of dishwasher without accessing control module wire harnesses. Resistances are:

- **Water valve** ~ 1 kΩ
- **Drain motor** ~ 16.5Ω

NOTE: The wiring diagram calls the "water switch" a "flow control motor".

Flow Control Motor

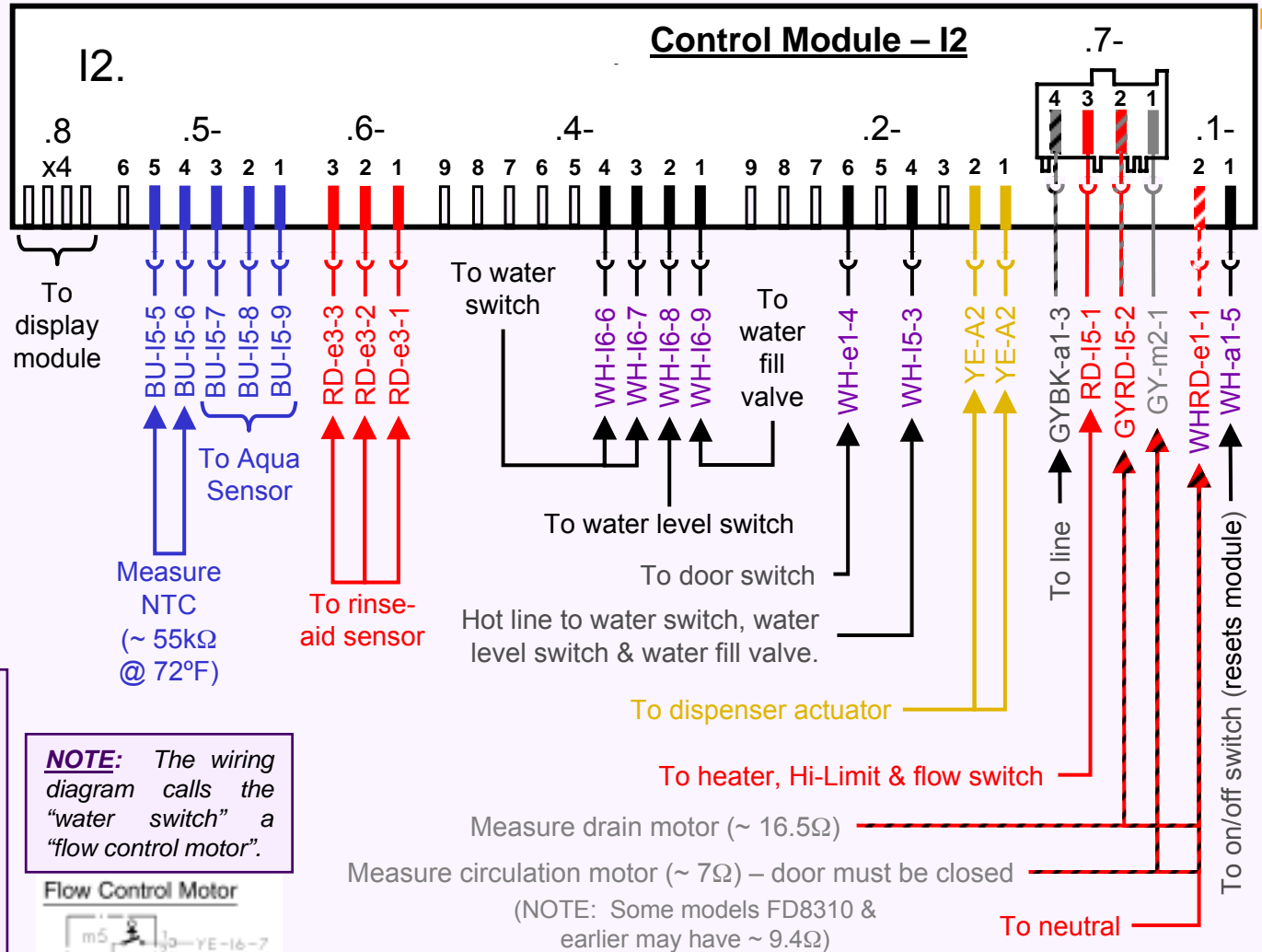
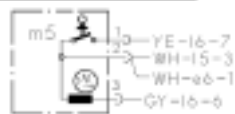

NOTE: These use the top-load dispenser with different actuator & rinse-aid sensor.

Service Tips -- Measuring Resistances @ Modules (5)

SHV/X/Y99

Wire color codes:

- BK** = Black
- BN** = Brown
- BU** = Blue
- GY** = Gray
- RD** = Red
- WH** = White
- YE** = Yellow

NOTE: These use the top-load dispenser with different actuator & rinse-aid sensor.

HINT: Water valve and drain motor can be measured from front of dishwasher. Resistances are:

- **Water valve ~ 1 kΩ**
- **Drain motor ~ 16.5Ω**

NOTE: Control modules for SHV/SHX/SHY99 models are mounted on bases where base wiring harnesses are mounted for other models. Control modules are accessed through the right side after pulling dishwashers out, so resistances cannot be measured from the front.

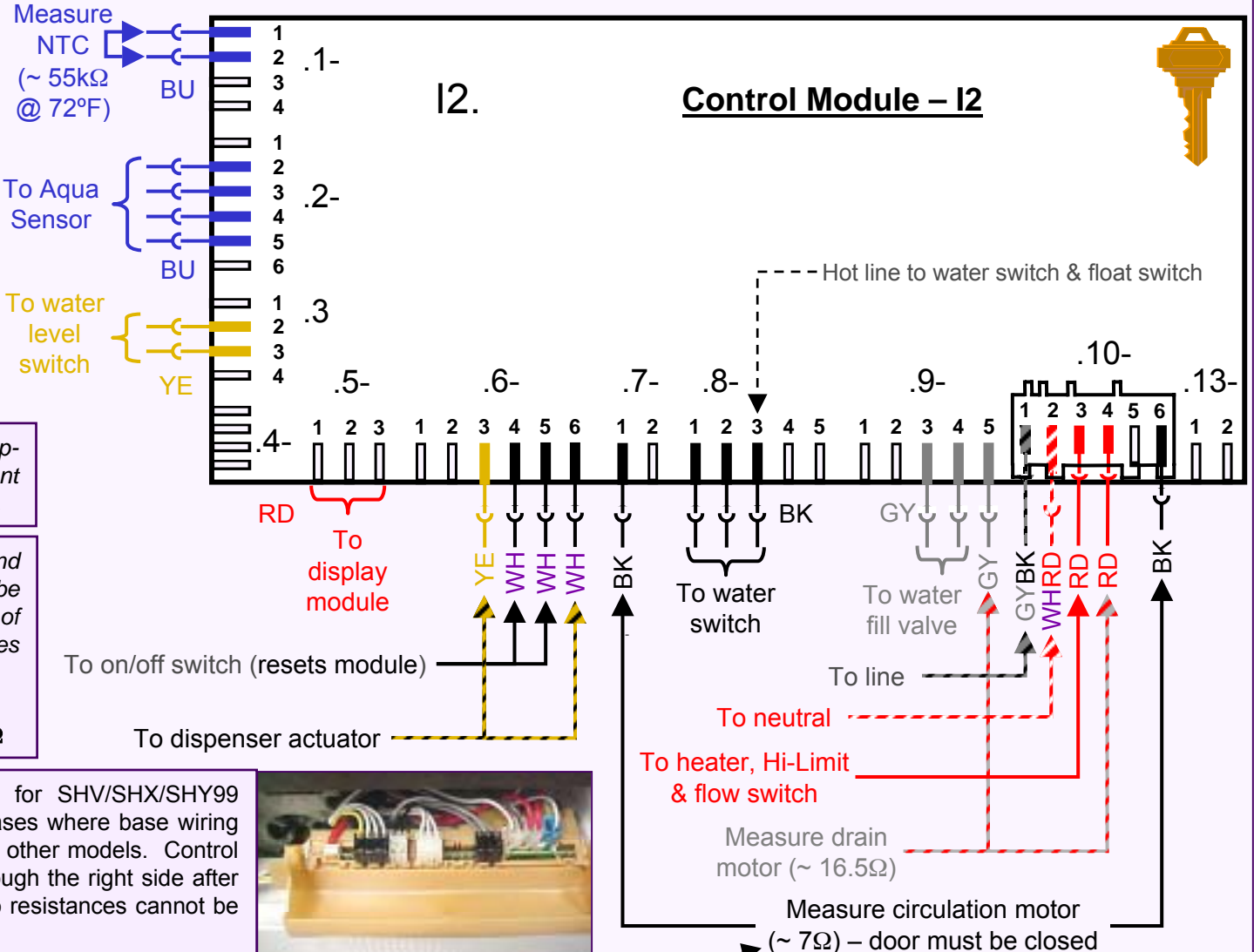

(NOTE: Some models FD8310 & earlier may have ~ 9.4Ω)

Service Tips -- Measuring Resistances @ Modules (6)

SHU/
43/53/68



Wire color codes:

- BK = Black
- BN = Brown
- BU = Blue
- GY = Gray
- RD = Red
- WH = White
- YE = Yellow

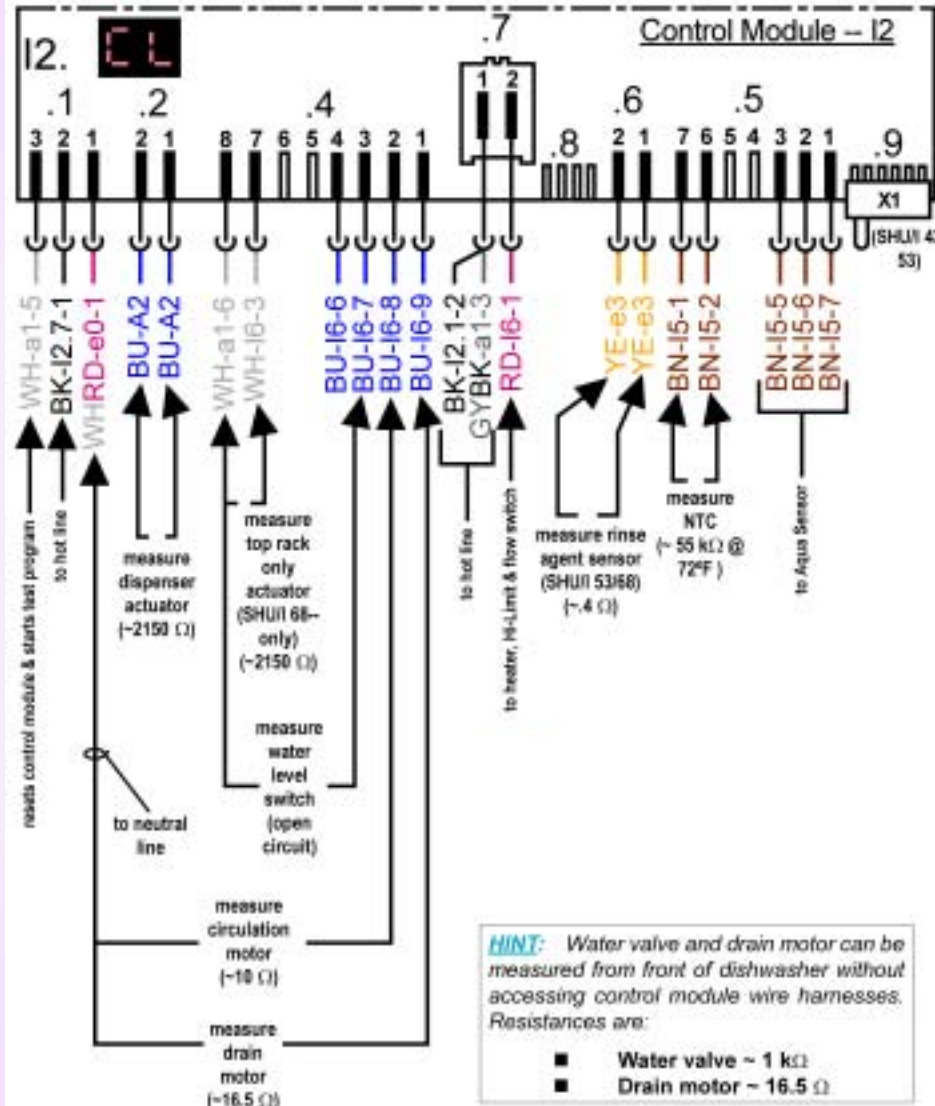

Service Tips -- Measuring Resistances @ Modules (7)

SHU 995x,
SHV 68,
GM276, GI
976/966

Wire color codes:

- BK = Black
- BN = Brown
- BU = Blue
- GY = Gray
- RD = Red
- WH = White
- YE = Yellow

HINT: To measure integrated model resistances while door is open, use a screwdriver to trip door latch closed.

HINT: Water valve and drain motor can be measured from front of dishwasher without accessing control module wire harnesses. Resistances are:

- **Water valve ~ 1 kΩ**
- **Drain motor ~ 16.5 Ω**

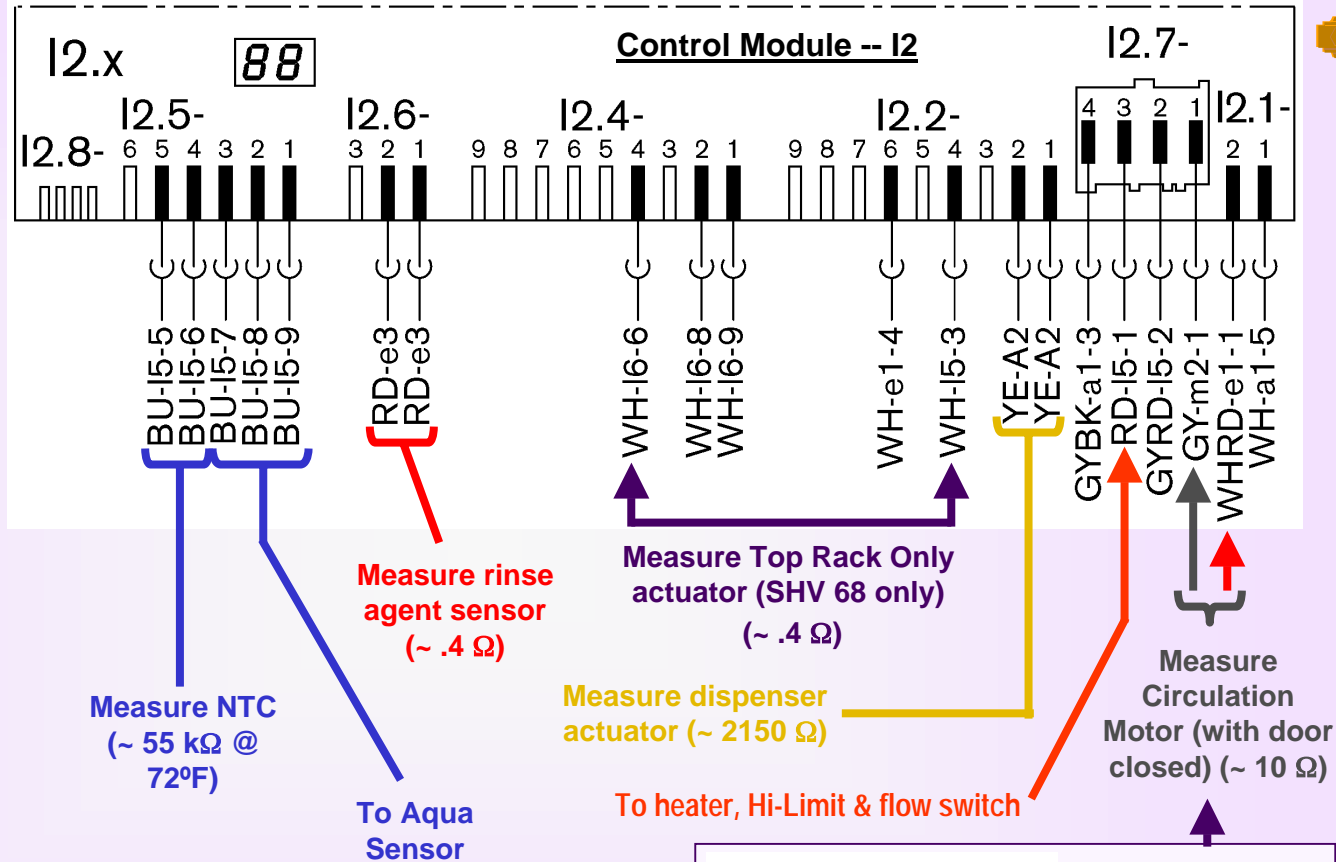

Door Switch – e1

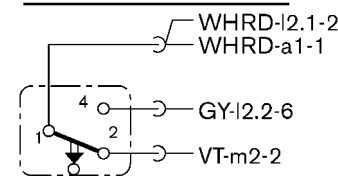

NOTE: Can also measure between **VT** wire on terminal # 2 on e1 door switch and **GY** wire on module terminal 12.7-1



Service Tips -- Measuring Resistances @ Modules (8)

**SHU 88/99,
SHV 43/48**
(not SHU 995x)

Wire color codes:

- BK = Black
- BN = Brown
- BU = Blue
- GY = Gray
- RD = Red
- WH = White
- YE = Yellow

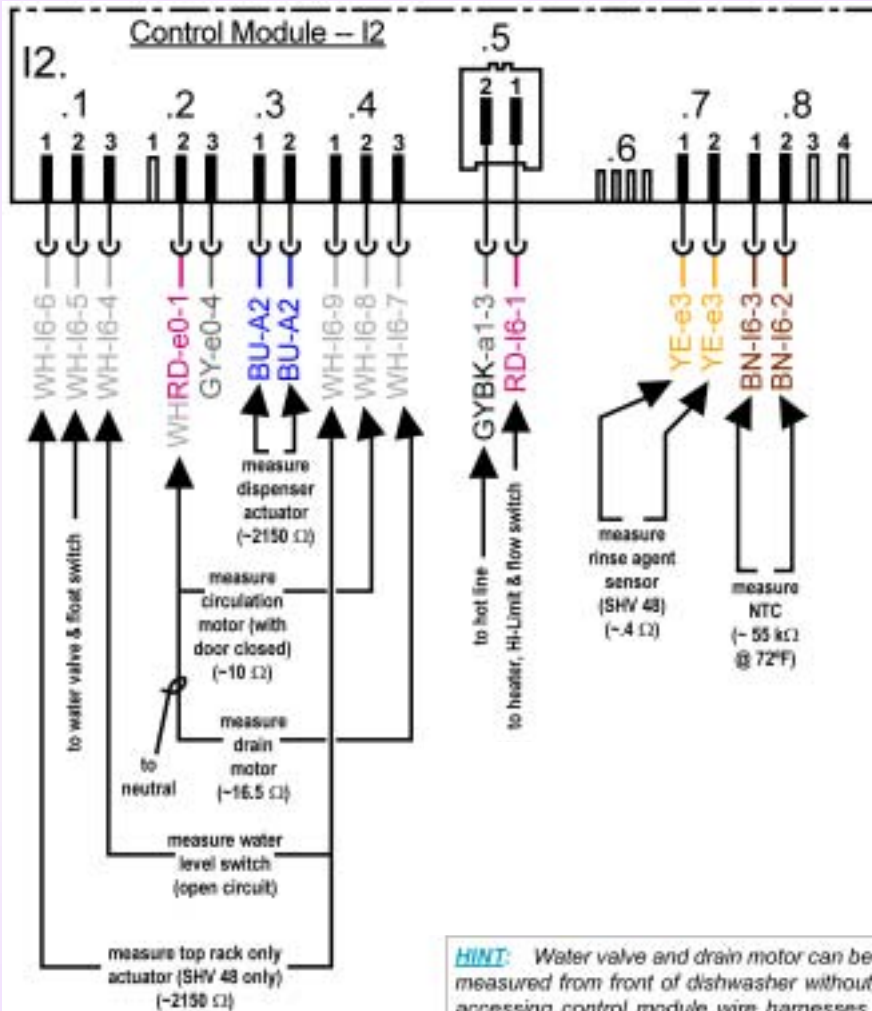

HINT: Water valve and drain motor can be measured from front of dishwasher without accessing control module wire harnesses. Resistances are:

- Water valve ~ 1 kΩ
- Drain motor ~ 16.5 Ω



Service Tips -- Measuring Resistances @ Modules (9)

SHU 33/432x (all),
SHU33A UC/14

Wire color codes:

- BK = Black
- BN = Brown
- BU = Blue
- GY = Gray
- RD = Red
- WH = White
- YE = Yellow

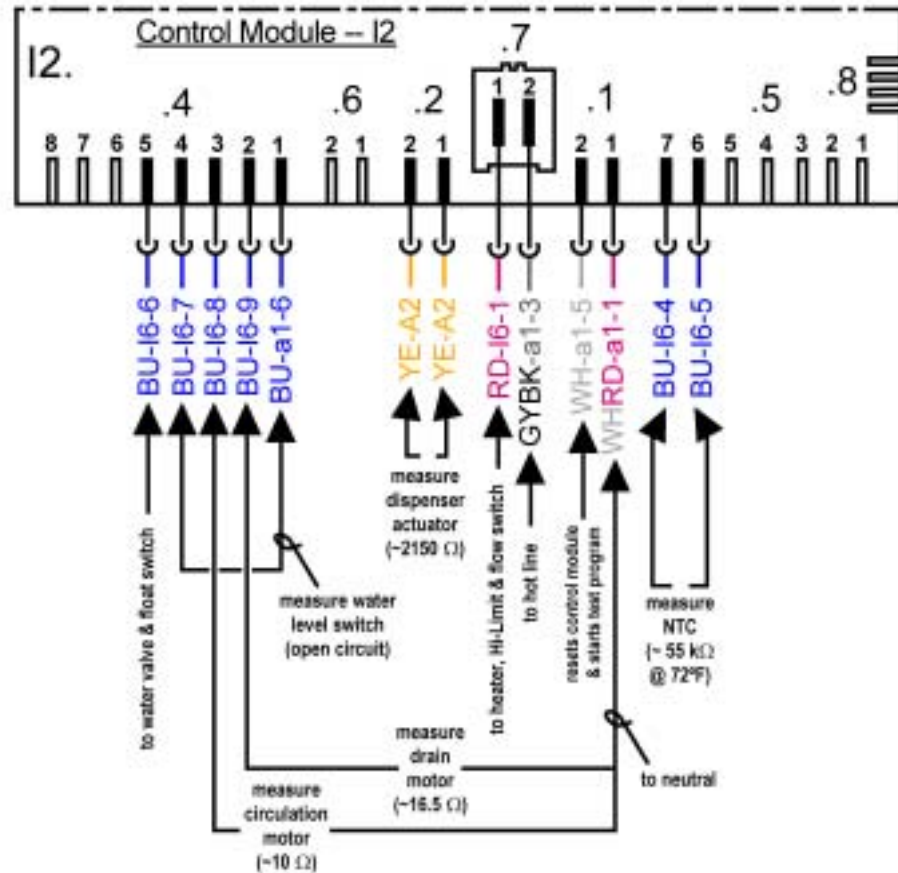

HINT: Water valve and drain motor can be measured from front of dishwasher without accessing control module wire harnesses. Resistances are:

- Water valve ~ 1 kΩ
- Drain motor ~ 16.5 Ω

Service Tips -- Measuring Resistances @ Modules (10)

SHU
303x/
313x



Wire color codes:

- BK = Black
- BN = Brown
- BU = Blue
- GN = Green
- GY = Gray
- RD = Red
- WH = White
- YE = Yellow

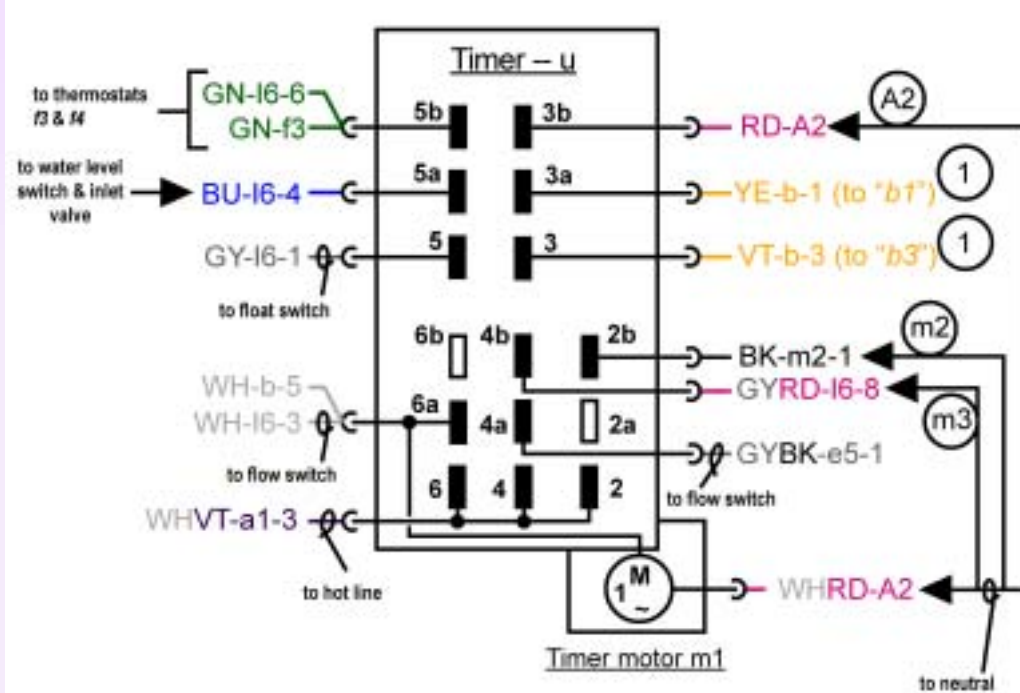

- (m2)** measure circulation motor (~10 Ω)
- (m3)** measure drain motor (~16.5 Ω)
- (A2)** measure detergent actuator (~2150 Ω)
- (1)** see circuit / schematic diagram for b1 & b3 selector switches

HINT: Water valve and drain motor can be measured from front of dishwasher without accessing timer wire harnesses. Resistances are:

- Water valve ~ 1 kΩ
- Drain motor ~ 16.5 Ω

Service Tips -- Modules Displaying "1"

Occasionally dishwashers will run for hours, not finish washing & show a "1" in the display. This means the module has timed out due to an unidentified heating problem -- all heating related parts must be checked until the problem is found.

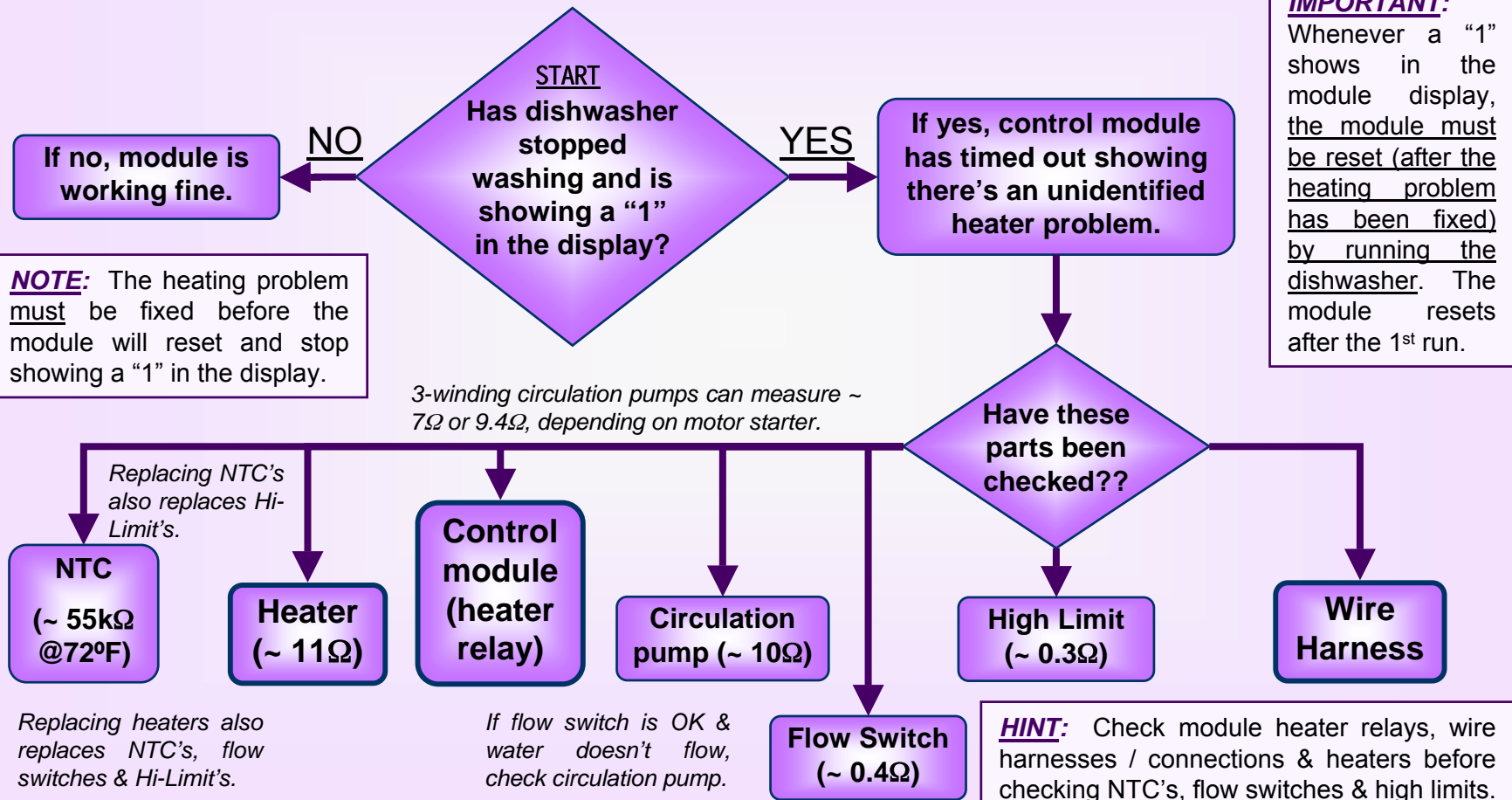

Service Tips – Turning Off End of Cycle Tones (1)

Control modules on integrated models (**SHV, SHX, SHY**) have been replaced when end of cycle tones couldn't be turned off, not for module failures. Following these instructions for turning off cycle tones, instead of replacing entire control modules, will save customers time and money. Use these instructions (copied from *Use & Care Manuals*) when manuals aren't available.

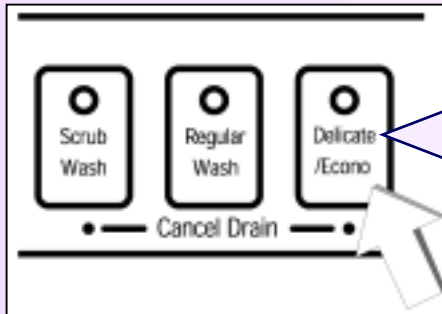

Push right-hand button marked "Cancel Drain"



HINT: Open door slightly to access buttons.

MODELS WITHOUT DISPLAYS:

- 🎵 While pushing & holding right-hand button marked **Cancel Drain** (regardless of model), push **On/Off** button. When light on button and tone come on, release both buttons.
- 🎵 Push right-hand button again to scroll through tone volumes until no tone is heard (or desired volume is reached if tone is to be kept on).
- 🎵 To save changes, push **On/Off** button and close door. Dishwasher can now be run.

MODELS WITH DISPLAYS:

- 🎵 While pushing & holding **Delay Start** button (regardless of model), push **On/Off** button. When display shows a # (**0, 1** or **2**) and tone comes on (if tone is on), release both buttons. (If no tone comes on, tone is already off -- push **On/Off** button to exit change mode.)
- 🎵 Push **Delay Start** button again to scroll through tone volumes until no tone is heard (or desired volume is reached if tone is to be kept on). Volume level on display will show "0" when tone is off.
- 🎵 To save changes, push **On/Off** button and close door. Dishwasher can now be run.

Service Tips – Turning Off End of Cycle Tones (2)

Control modules on Apexx models (**SHV99**, **SHX99**, **SHY99**) have been replaced when end of cycle tones couldn't be turned off, not for module failures. Following these instructions for turning off cycle tones, instead of replacing entire control modules, will save customers time and money. Use these instructions (copied from *Use & Care Manuals*) when manuals aren't available.

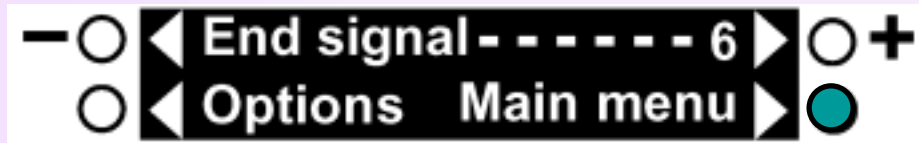

- 🎵 Open door slightly to access buttons, then push **On/Off** button. Push “Option” button four (4) times until “End signal” option shows (see above). The dishwasher then starts playing the present tone volume level.
- 🎵 Push “+” or “-” buttons to change volume of end of cycle tone: push “+” button to raise volume (6 is max.) & push “-” button to lower volume (0 turns tone off).
- 🎵 If desired, push the **green** Main Menu button once to change other options or twice to start the dishwasher (close the door to begin the wash cycle).

Service Tips -- Using # 264946 Front Cover to Replace Broken # 266746, # 263832 or # 264461 Control Module Buttons

266746, # 263832 or # 264461 control modules are often replaced when buttons break, not for electronic failures. Replacing the # 264946 front cover when buttons break instead of replacing the entire control module will save customers time and money.

NOTE: # 264946 front cover fits on all three modules -- # 266746, # 263832 & # 264461.

CAUTION: Some pc board components are sensitive to static electricity and can be damaged when touched. Personnel handling pc boards should be grounded.

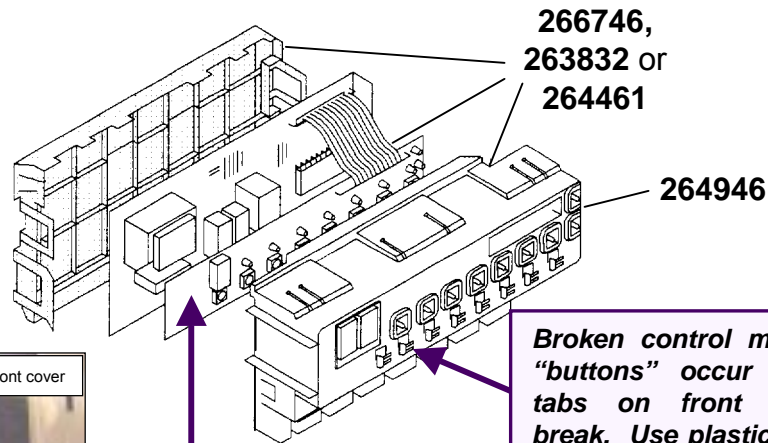

INSTALLATION: To install a front cover, insert the hinge tabs into the control module housing -- do NOT force the cover into the housing. To INSERT the hinge tabs, rotate the front cover (with the tabs contacting the housing hinge) until the cover hinge tabs slide easily into the hinge. When the hinge is in place, close the front cover until all three tabs lock the cover in place.

HINT: Use # 264946 front cover instead of replacing an older # 263832 module with a # 266746 module since modules cost more & have longer lead times than covers. Many # 263832 modules have been replaced merely for broken buttons.

Broken control module "buttons" occur when tabs on front cover break. Use plastic front cover when replacing "broken buttons".

CAUTION: Insert display module board carefully to prevent breaking spring locking tabs on front cover. When installing display module, carefully slide top of board into top of front cover, making sure board is fully seated into tabs. Then, carefully rotate bottom of board into position so spring locking tabs spring back and lock without cracking or breaking. DO NOT FORCE bottom or top of display board into position.

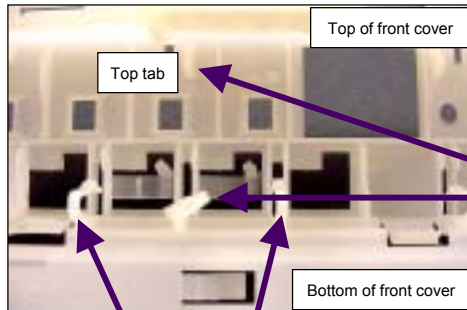

Note cracks in plastic locking tabs.

NOTE: To determine which control module you have, check the model #'s on the following list:

266746 -- SHU 5302/5304/5305/5306/5312/5314/5315/5316/6802/6805/6806 UC 11 - UC/12, SHU 5307/5317 UC/12 and SHI 6802/6805/6806 UC/11 - UC/12.

263832 -- SHU 5302/5304/5305/5306/5312/5314/5315/5316/6802/6805/6806 UC 06 and SHI 6802/6805/6806 UC/06.

264461 -- SHU 4302/4306/4312/4316 UC 06 - UC/11 - UC/12 and SHI 4302/4306 UC/06 - UC/11 - UC/12.

Service Tips -- Using # 481055 Control Modules in Older SHU 99 and SHV 43/48 Dishwashers (1)

Control module # **265401** used on older **SHV 43/48** and **SHU 990x/991x UC/06, UC/07 & UC/11** models has been replaced by control module # **481055** used on all newer **SHU 99 & SHV 43/48 UC/12** models. Since module # **481055** has slightly different wash cycles and an end of cycle tone compared to the # **265401** module, the pushbutton pad for the dishwasher must also be changed so the wash cycles will be shown correctly. Please follow these instructions to order the correct pushbutton pad and to turn off the end of cycle tone for older models.

NOTE: When replacing pushbutton pads for older **SHV 43/48 & SHU 990x/991x** models when the # **265401** control module won't be replaced (i.e. the # **265401** control is functional and is still being used), use the following button pads:

- # **170424** 4-button pad for **SHV 43 & SHU 990x/991x** models (instead of # **182605**)
- # **170423** 5-button pad for **SHV 48** models (instead of # **182600**)



NOTE: When replacing control module # **481055** for newer **SHV 43/48 & SHU 991x/992x** models, button pads don't need to be replaced. If the button pads are worn, order # 4-button pad # **182605** (for **SHV 43 & SHU 991x** models) or 5-button pad # **182600** (for **SHV 48 & SHU 992x** models).

NOTE: When replacing control module # **265401** for older **SHV 43/48 & SHU 990x/991x** models, use module # **481055** along with 4-button pad # **182605** (for **SHV 43 & SHU 990x/991x** models) or 5-button pad # **182600** (for **SHV 48** models).

Service Tips -- Using # 481055 Control Modules in Older SHU 99 and SHV 43/48 Dishwashers (2)

**New
pushbutton
pads:**



INSTRUCTIONS FOR TURNING OFF END OF CYCLE TONE:

- ♪ Open door, push and hold *Delicate/Econo* button, then turn dishwasher on while holding *Delicate/Econo* button.
- ♪ Release *Delicate/Econo* button. If module beeps, end of cycle tone is on -- press *Delicate/Econo* button again to disable tone. If module doesn't beep after button is pressed, tone is disabled.
- ♪ Turn off dishwasher to save selection.
- ♪ **NOTE:** If buttons don't match those above and there's an end of cycle tone, press 2nd button from right instead of *Delicate/Econo* button.

Service Tips -- Using # 481055 Control Modules in Older SHU 99 and SHV 43/48 Dishwashers (3)

Comparison of old and new pushbutton pads:

SHV 4303 UC/06 & UC/11 models program buttons & indicator lights:

old

○
Clean

○
Power
Scrub
Plus

○
Scrub
Wash

○
Regular
Wash

○
Rinse
& Hold

SHV 4303 UC/12 models program buttons & indicator lights:

new

○
Clean

○
Power
Scrub
Plus

○
Regular
Wash

○
Delicate
/Econo

○
Rinse
& Hold

SHV 4803 UC/06 & UC/07 models program buttons & indicator lights:

old

○
Clean

○
Refill
Rinse
Agent

○
Top
Rack
Only

○
Power
Scrub
Plus

○
Scrub
Wash

○
Regular
Wash

○
Rinse
& Hold

SHV 4803 UC/12 models program buttons & indicator lights:

new

○
Clean

○
Refill
Rinse
Agent

○
Top
Rack
Only

○
Power
Scrub
Plus

○
Regular
Wash

○
Delicate
/Econo

○
Rinse
& Hold

Service Tips -- Using # 481055 Control Modules in Older SHU 99 and SHV 43/48 Dishwashers (4)

Comparison of old and new pushbutton pads:

SHU991x UC/06 & UC/11 models program buttons & indicator lights:

old

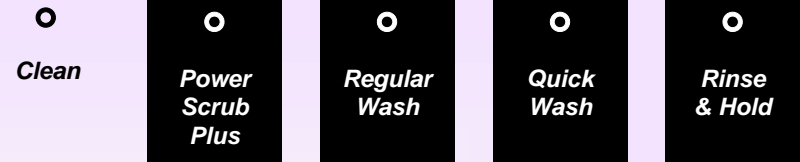

SHU991x UC/12 models program buttons & indicator lights:

new



SHU990x UC/06 Millennium models program buttons & indicator lights:

old

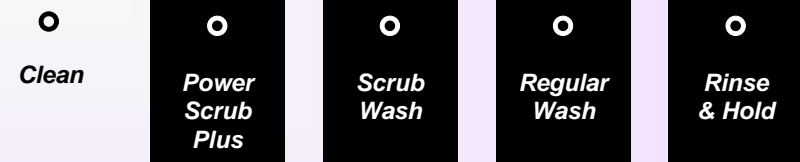

SHU992x UC/12 models program buttons & indicator lights:

new

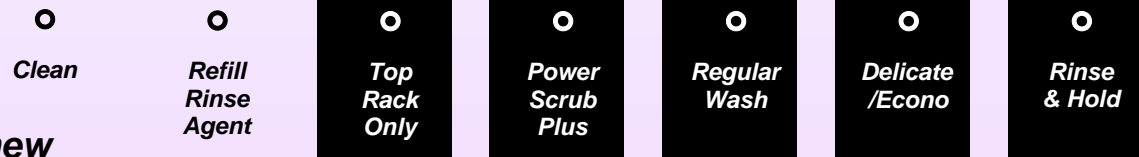

Part # 4 -- Heater & NTC (1)

Access

The heater & NTC can be accessed or measured from the right side of the dishwasher, but can only be removed by dropping the entire base (by flipping the dishwasher on its back) since they are wedged underneath the tank.

To remove outer door:

- ✂ Remove six (6) T-20 Torx screws from inner door below fascia panel (three (3) per side).
- ✂ Carefully pull bottom of outer door out from dishwasher until top door tabs clear, then pull door down until it releases from dishwasher. Take care to not scratch outer door.
- ✂ Remove two (2) plastic door guards. They can fall out when the outer door is removed.



Remove inner door screws



Slide out outer door



Remove door guards

HINT: Remove all water from the sump and hoses before accessing the heater -- when the dishwasher is flipped on its back, water can enter the water fill assembly diaphragm and cause the dishwasher to not fill properly.

Part # 4 -- Heater & NTC (2)

To remove toe kick:

- ✖ Remove two (2) T-20 Torx screws from toe kick.
- ✖ Tilt toe kick out from under dishwasher.

HINT: The fascia panel and door don't need to be removed to access the heater & NTC. However, the door must be removed to completely remove the tank.

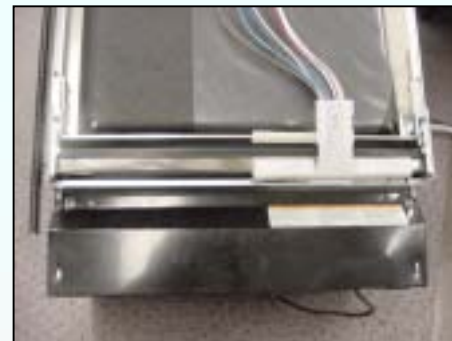

To remove right & left side panels:

- ✖ Remove two (2) T-20 Torx side panel screws from each side (through holes in trim strip).
- ✖ Carefully slide trim strips up and out of dishwasher. If side panels are removed carefully to avoid damaging trim strips, then trim strips don't need to be removed.
- ✖ Lift side panels up and out from dishwasher. Panels can be removed with trim strips.



Remove panel screws



Slide out trim strips



Lift panels up and out

Part # 4 -- Heater & NTC (3)

To separate base from tank (1):

- ✂ Carefully lay dishwasher on its back.
- ✂ Carefully pull door springs out from base.
- ✂ Remove terminal blocks from base.
- ✂ Separate water valve from base by removing two (2) T-20 Torx screws, then move water valve out of the way.

HINT: Remove water from sump and hoses before laying dishwasher on its back (to avoid water entering water fill assembly & causing faulty water filling).



Place on back



Pull out door springs from base & disconnect cords



Remove terminal blocks from base

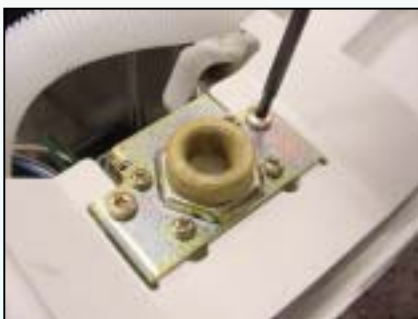

Disconnect water valve from base



Part # 4 -- Heater & NTC (4)

To separate base from tank (2):

- ✂ Disconnect J-box ground wire, then pull wires out of J-box.
- ✂ Pull out inlet hose from sump.
- ✂ Carefully pull base away from tank and sump.



Pull wires from J-box



Pull out sump inlet hose



HINT: Its simpler & quicker to remove the two water valve screws than to remove the hose clamp.



Carefully pull base away from tank & sump





HINT: Don't order duplicate parts when ordering parts below -- when these parts are replaced, others are included:

- **Heater assy.** -- includes NTC, Hi-Limit, flow switch (& aqua sensor where applicable).
- **NTC** -- includes Hi-Limit.

Part # 4 -- Heater & NTC (5)

Removing & Installing Heater & NTC:

-  Remove two (2) T-20 Torx screws holding heater assembly to sump.
-  Disconnect wires from heater, flow switch, NTC & Hi-Limit after noting connections.
-  Pull clips, then carefully pull heater assembly from sump & pump. Note heater comes as an assembly (with housing & gasket).

NOTE: Softer bearing & non-softer bearing heater assemblies, circulation pumps and sumps **cannot** be mixed and matched. Softer bearing heaters don't fit in older models and older heaters don't fit in softer bearing models.

HINT: If needed, use rinse-aid to lubricate gaskets to make it easier to assemble heater to sump and pump.



Heater assembly Remove heater screws Remove heater from sump/pump

NOTE: Softer bearing & non-softer bearing heater assemblies are connected to circulation pumps differently:

- Softer bearing models (UC/11 & above) have gasket assembled to heater and have a separate hose clamp (order # **172272**).
- Older models (UC/06) have a separate gasket and do not have a hose clamp.

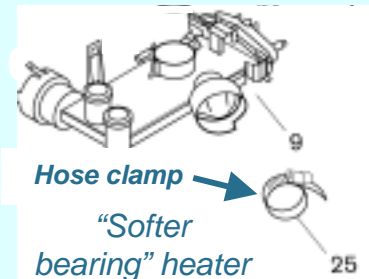

HINT: Heater assemblies contain NTC's, Hi-Limit's & flow switches (& aqua sensors where applicable). If heaters are replaced, these parts are replaced too.

Part # 4 -- Heater & NTC (6)

Removing & Installing NTC:

- ✂ Remove heater assembly -- NTC is located on top of heater assembly.
- ✂ Disconnect wires after noting connections (since NTC & Hi-Limit are included in the same part -- # 165281).
- ✂ Remove NTC cover, pull NTC holding tabs apart and pull NTC out of heater.

NOTE: Softer bearing & non-softer bearing heater assemblies, circulation pumps and sumps **cannot** be mixed and matched. Softer bearing heaters don't fit in older models and older heaters don't fit in softer bearing models.



Disconnect wires



Remove cover & pull tabs



Remove NTC

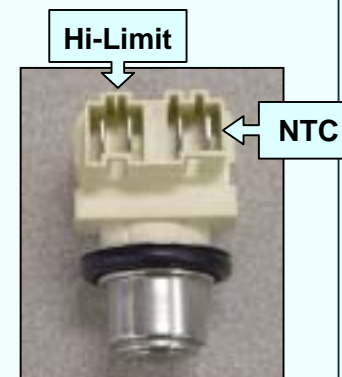

NTC w/ Hi-Limit

NOTE: To remove flow switch, carefully pry housing away from switch (until tabs clear switch), then snap switch out.



HINT: If needed, use rinse-aid to lubricate gaskets to make it easier to assemble heater to sump and pump.

Service Tips -- Heater Troubleshooting Flowchart

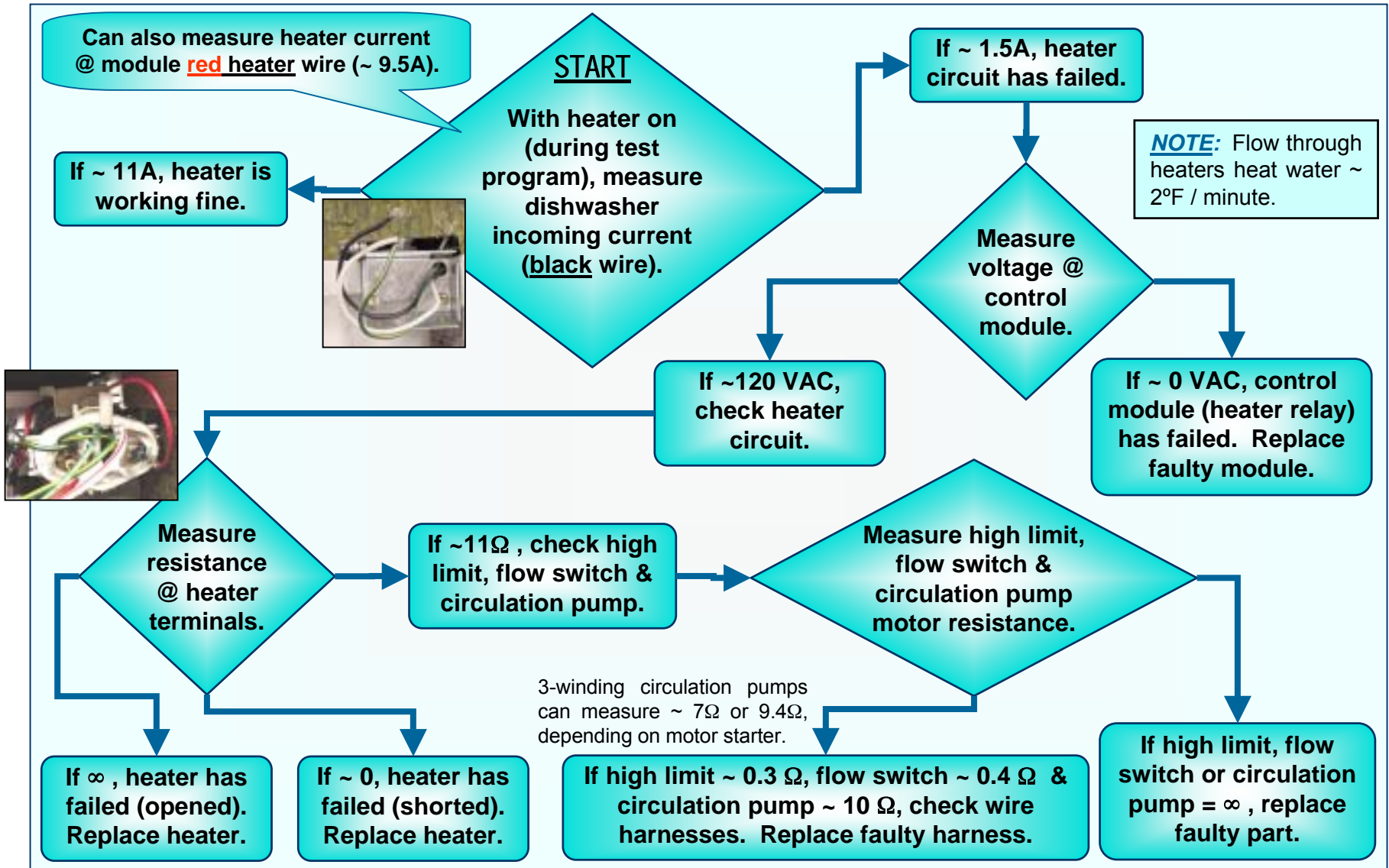

Service Tips -- Modules Displaying "1"

Occasionally dishwashers will run for hours, not finish washing & show a "1" in the display. This means the module has timed out due to an unidentified heating problem -- all heating related parts must be checked until the problem is found.

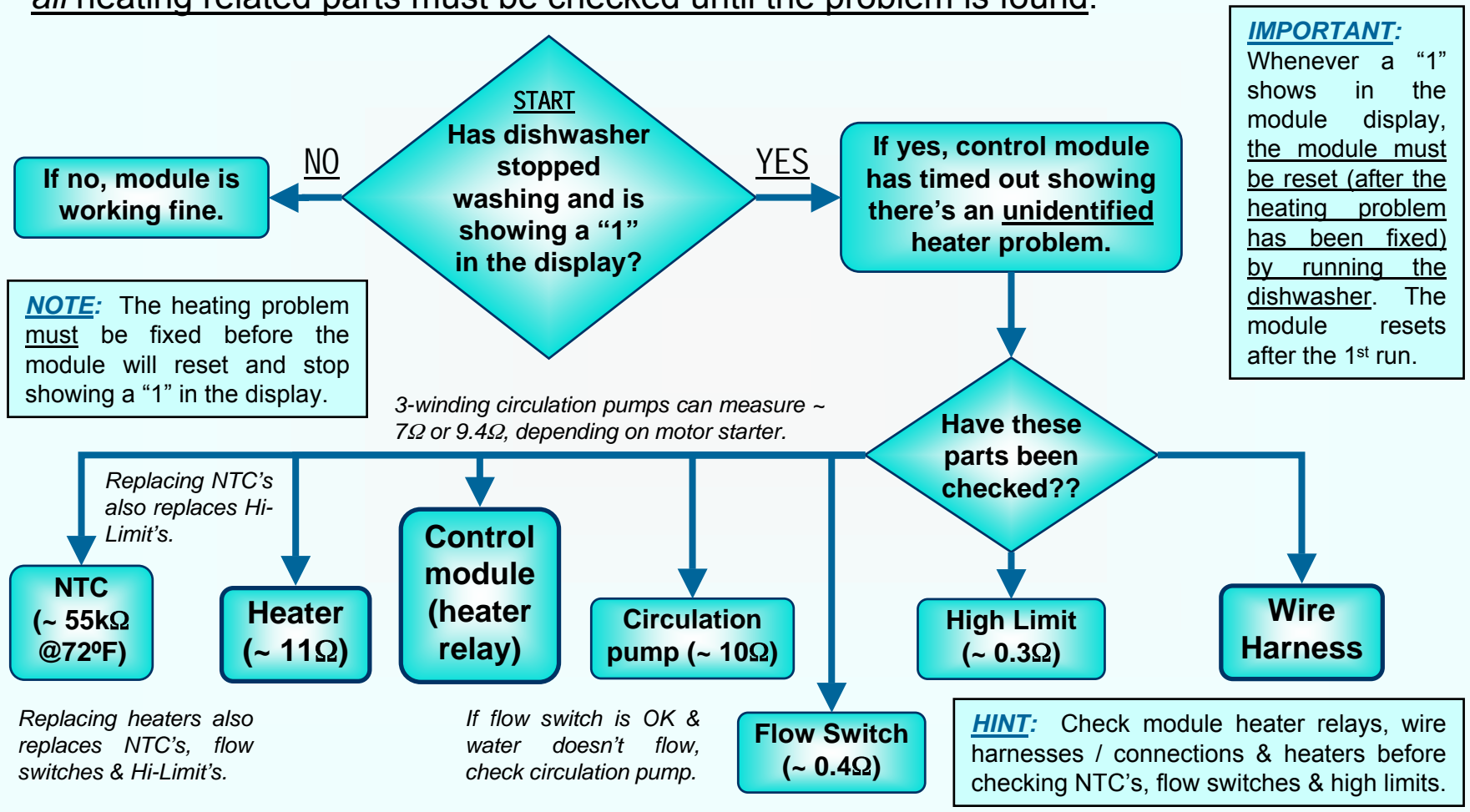

Service Tips -- Measuring Heater/NTC Resistances (1)

TEST	TIME	NOTES
Entering test program	----	Press <i>On/Off</i> button at the <u>same time</u> you press both the <i>Power Scrub Plus & Regular Wash</i> buttons (SHU1 43 models) or the <i>Scrub Wash & Delicate/Econo</i> buttons (SHU1 53 & 68 models). Indicating lights will flash.
Starting test program	----	Press both the <i>Power Scrub Plus & Regular Wash</i> buttons (SHU1 43 models) or the <i>Scrub Wash & Delicate/Econo</i> buttons (SHU1 53 & 68 models) a 2nd time.
Skipping a test	----	Press <i>Scrub Wash</i> button (SHU1 43 models) or <i>Regular Wash</i> button (SHU1 53 & 68 models).
Draining	30 seconds	Allow dishwasher to drain.
Aqua Sensor calibration	65 seconds	Not on SHU1 43 models. Skip this test.
Filling	Until water level switch closes	Can't skip this test
Heating & Circulating	Until water reaches 150°F (rises ~ 2°F/minute)	Don't run entire test (to save time) -- when water starts circulating, measure current in main power line to dishwasher. Skip test once current has been measured. If current is ~ 11A, heater, flow switch and Hi-Limit are OK. If current ~ 1.5-2A, turn off dishwasher, remove or block up tank and measure resistance of heater, Hi-Limit & flow switch (see below).
Draining	60 seconds	Last test. To end test program, press <i>On/Off</i> button (all models).

Use dishwasher test program to turn on heater, then measure dishwasher incoming current. If ~ 1.5A, heater, Hi-Limit, flow switch or circulation pump has failed. Check voltage @ module (or timer) -- if 0V, module (or timer) has failed.

For electronic models, current can also be measured through **red** heater wire at control module (~ 9.5A). Since there can be more than one **red** wire, check wiring diagram to select heater wire.



HINT: Because the flow switch only closes when water is flowing, the heater resistance can only be measured at the heater terminals (not at the control module).

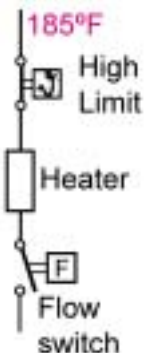

NOTE: Once its found one of these parts is faulty (from incoming current being 1.5 - 2A), check each part (once tank has been removed or blocked up) by measuring its resistance at its terminals:

- Heater ~ 11 Ω
- Hi-Limit ~ .3 Ω
- Flow switch ~ .4 Ω -- must remove microswitch from heater housing & close its contacts to measure this. A spring loaded plunger closes microswitch when water is flowing.

NOTE: Flow through heaters heat water ~ 2°F / minute.

NOTE: Open door to run test program for fully-integrated models.



HINT: The NTC and High Limit are contained in the same part. When either fails, replace entire part # **165281**.

Service Tips -- Measuring Heater/NTC Resistances (2)

Using test programs for various models (UC/06 - UC/17)

Models	Buttons to Enter Test Program
SHU/SHI430x, SHU431x	Power Scrub Plus + Regular Wash
SHU33/DLX	Power Scrub Plus + Rinse & Hold
SHU43C, SL34A, SHU432x	Regular Wash + Rinse & Hold
SHU53/66C/68, SHI66A/68	Scrub Wash + Delicate/Econo
SHU53A, SHX/SHY56, SL95A	Regular Wash + Quick Wash
SHU88	Power Scrub Plus + Quick Wash
SHU990x, SHV43/48	Power Scrub Plus + Regular Wash
SHU991x (thru UC/11)	Power Scrub Plus + Quick Wash
SHU991x (UC/12), SHU992x	Power Scrub Plus + Delicate/Econo
SHU995x	Regular Wash + Delicate Wash
SHV66A, SHY66A	Scrub Wash + Delicate/Econo
SHV68	Scrub Wash + Regular Wash
GI976/966, GM276	Intensive + Delicate
DW44	Heavy Wash + Light Wash

- ◆ To enter test programs, hold down buttons above (2nd & 4th from left), then turn dishwasher on by pushing on/off button. Push buttons above a 2nd time to start test program. Allow program to finish to see fault codes. Turn dishwasher off to exit test program.

HINT: Dishwasher test programs heat water to 150°F, so test programs will generally run > 20 minutes for incoming water temperatures ~ 120°F.

Using test programs for various models (UC/14 - UC/17)

Models	Buttons to Enter Test Program
SHV46C, SL84A, SHX43E/ 46A-B	Regular Wash + Delicate/Econo
SHX33A	Regular Wash + Rinse & Hold
SHU43E/53E/66E	Turn knob (see below) + Start/Stop
SHV99, SHX99, SHY99	(2) left buttons (see below)

- ◆ To enter SHV46C, SL84A, SHX33A/43E/ 46A-B test programs, hold down 2nd & 3rd from left of three test program buttons, then turn dishwasher on by pushing on/off button. When in test program, 2nd button light (Regular Wash) will be lit and 3rd button light will flash. Push 2nd button (Regular Wash) to scroll until test program is chosen -- when 3rd button light is lit (○ ○ ●). Push 3rd button to start test program. Allow program to finish to see fault codes. Push 2nd button (Regular Wash) to skip certain steps. Turn dishwasher off to exit test program.
- ◆ To enter SHV/X/Y99 test programs, open door, hold down 2 left buttons & turn dishwasher on by pushing on/off button. Press "+" button repeatedly until "S-3-" shows on display, then push start button to check faults on last 8 washes. Close door to begin test program. Allow program to finish to see fault codes. Push "-" button to skip test steps. Turn dishwasher off to exit test program. Choose "S-6-" to clear fault codes.
- ◆ To enter SHU43E/53E/66E test programs, 1st rotate knob to 6:00 position (pointing straight down). Hold down Start/Stop button, then turn dishwasher on by pushing on/off button. Push Start/Stop button to start test program. When test program has finished, Clean light light will flash and all other lights will be lit.

Service Tips – Replacing Older UC/06 NLA Heaters

Heater assemblies # **264463** (for **SHU3000/4000 UC/06** models) & # **269255** (for **SHU3030 UC/06** models) have been replaced by kits requiring preparing **264463** and # **269255** heater assemblies from # **266662** heater assemblies by replacing thermostats and flow switches.

To create replacement for # **264463** & # **269255** heaters, push latches to remove NTC # **165281**, then replace with thermostat # **168575** (SHU3000 / 4000 UC/06) or # **165384** (SHU3030 UC/06).

NOTE: Kit #'s **264463** and **269255** have all parts for conversions.

Must replace 2-terminal # **175711** flow switch with 3-terminal switch # **069796**.

NOTE: **263869** (SHU53/68 models) or **264462** (SHU 33/43/99 models) heater assemblies aren't recommended for conversion since they're needed for popular models with aqua sensors.

HINT: Do **not** use softer bearing heater assemblies (UC/11 & later) such as # **480317** on older UC/06 models since the sump, circulation pump, base and heater clamps/gaskets have to be replaced as well for the heaters to fit.

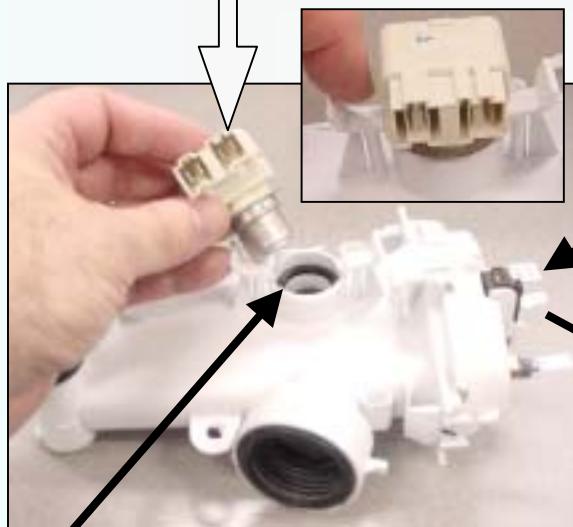

Make sure O-ring is installed.

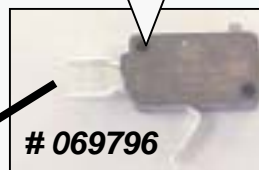

To replace flow switch, gently pry both sides of housing at top of switch until tabs clear switch, then pull switch out.

Service Tips -- Water Switch (“Flow Control”)(1)

All **SL95A**, *Apexx (SH_99)* & *ExactWash (SHX/Y56 & SHV/Y66)* & model heater assemblies have motor operated water switches inside them, with motors attached where *Top Rack Only* housings have been traditionally mounted (underneath heater assemblies). They consist of a motor-controlled disk (with 3 holes) which rotates to provide precise water flow control -- using both spray arms, upper spray arm only or lower spray arm only.

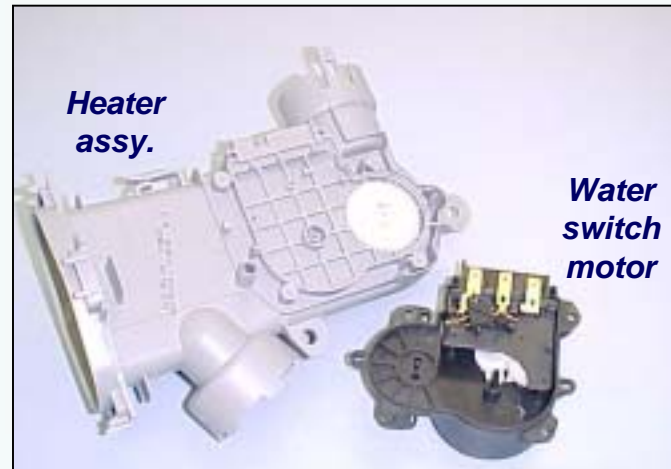
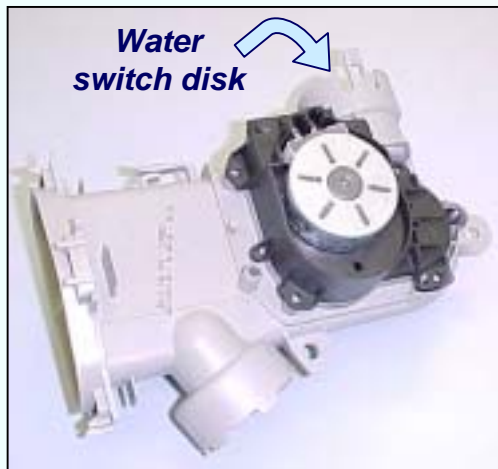

HINT: Models with water switches and *Top Rack Only* have the *Top Rack Only* parts integrated with the water switches. No separate actuators are needed.

HINT: Models with water switches require stronger circulation pumps (# **437345**) with separate motor starters (# **182318**). Circulation pumps, heaters & sumps for water switch and non-water switch models **cannot** be interchanged.

Service Tips -- Water Switch (“Flow Control”)(2)



<i>Part description</i>	<i>Old part #</i>	<i>Models used on</i>	<i>Water switch part #</i>	<i>Models used on</i>
Circulation pump	491434 (pump) or 266511 (motor only)	All models (index #'s UC/07, UC/11 & UC/12)	437345 (pump)	All <i>ExactWash</i> & <i>Apexx</i> models (index # UC/14)
Pump motor starter	-----	-----	182318	All <i>ExactWash</i> & <i>Apexx</i> models (index # UC/14)
Heater assembly	Various	Various	219639 or 431412	All <i>ExactWash</i> & <i>Apexx</i> models (index # UC/14)
Sump	263103	All models (index #'s UC/07, UC/11 & UC/12)	482035	All <i>ExactWash</i> & <i>Apexx</i> models (index # UC/14)
Pump support straps	171596	All models (index #'s UC/07, UC/11 & UC/12)	171596	All models (index #'s UC/07, UC/11, UC/12 & UC/14)
Pipe clamp (pump to heater)	172272	All models (index #'s UC/07, UC/11 & UC/12)	172272	All models (index #'s UC/07, UC/11, UC/12 & UC/14)
Pump rear housing	267739	All models (index #'s UC/07, UC/11 & UC/12)	267739	All models (index #'s UC/07, UC/11, UC/12 & UC/14)
Pump front housing	266514	All models (index #'s UC/07, UC/11 & UC/12)	266514	All models (index #'s UC/07, UC/11, UC/12 & UC/14)

NOTE: This affects (*ExactWash* & *Apexx*) models with water switches – **SL95A, SH_56, SHV/Y66 & SH_99.**

NOTE: This does **not** affect (*Sensotronic*) models without water switches. They use the same parts used on models from UC/06 through UC/12.

NOTE: Parts can be changed without notice. Please refer to published CD parts lists for up to date part #'s.

Service Tips – Top Rack Only

Models with the *Top Rack Only* feature have separate actuators mounted underneath heater assemblies. The actuator moves a magnetic plunger in the lower rack heater port, diverting water to the top rack.



Heater with top rack housing



Both racks



Top rack only



Plunger



Where plunger engages sump

HINT: Models with water switches and *Top Rack Only* have the *Top Rack Only* parts integrated with the water switches. No separate actuators are needed.



UC/11 heater

UC/06 heater

HINT: Do not use softer bearing heater assemblies (UC/11 & later) on older UC/06 models since the sump, circulation pump, base and heater clamps/gaskets have to be replaced as well for the heaters to fit.

Part # 5 -- Drain Pumps

Drain pumps are mounted to sumps in the front of dishwashers -- they're easily accessible from the front of dishwashers by removing toe kicks.

Removing & installing drain pump:

- ✎ Remove toe kick, then pull up terminal cover and disconnect wires. For easier access, remove base cover 1st.
- ✎ To remove pump, push latch (on circular collar) & rotate pump clockwise (cw). To install new pump, insert @ 2:00 position & rotate counterclockwise (ccw).
- ✎ Clean water & debris from base, then check float operation.
- ✎ Connect wires, then install base cover & toe kick.

HINT: Improper installation issues causing dishwashers to not drain properly -- its usually not a drain pump problem:

- 💡 Drain hoses without high loops or drains without air gaps
- 💡 Drain hoses > 10' long (i.e. > 4' extension)
- 💡 Drain hoses kinked when dishwashers installed under cabinets

NOTE: Standard 6-vane drain pumps (# **167082**) are quieter and smoother than 4-vane pumps. Drain pumps used in installations (in Washington State) with Johnson Tees must use stronger 4-vane pumps (# **184178**). 4-vane pumps will be slightly noisier, which is normal.



NOTE: Drain pump is rated 120V, 60 Hz, 35W, 0.85A.

DRAIN HOSE INSTALLATION TIPS:

- ❶ Must have drain hoses with high loops or drains with air gaps.
- ❶ Drain hoses can be up to 10' long – can add up to 4' to dishwasher hose.
- ❶ Secure drain hoses to rear of dishwashers with non-metal bands.

Service Tips – Sump Improvements to aid Draining

Two improvements have been made in sump parts during mid 2003 to improve draining. Drain pump performance can be optimized if these parts are replaced when drain pumps are replaced.

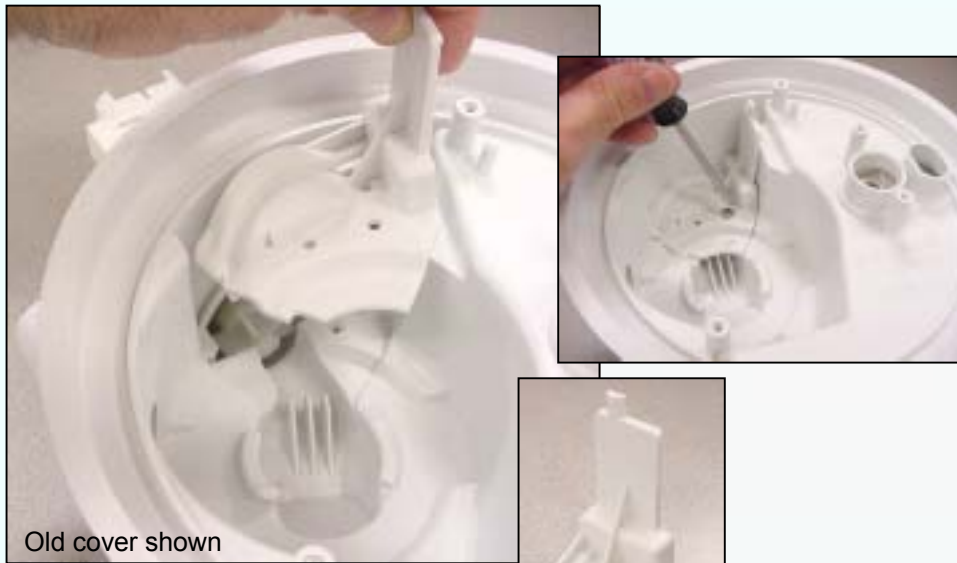

Old cover shown

Drain pump covers were changed to provide better water flow and resistance to jamming. Part # is still **165263**.



Old valve shown

Check (backflow) valves were changed to provide superior leak resistance. The new material is leak proof. Part # is still **165262**.



Part # 6 -- Dispensers (1)

Disassembly

CAUTION: Inner door edges are sharp! Cover door edges and remove dispenser carefully.



Disconnecting wire harness

Bending retainer tabs

HINT: To remove/install dispensers:

- ✘ Remove outer door, remove fascia panel & disconnect wire harness from fascia panel.
- ✘ Disconnect wire harness from above dispenser, then remove wires to wax motor & reed switch.
- ✘ Disconnect condensation tube (for older models with condensation tubes in doors).
- ✘ Remove any tape or wire ties. Bring replacement wire ties for reassembly.
- ✘ Bend retainer tabs, then push dispenser inward toward tank. Protect hand with towel as edges are sharp.
- ✘ Replace from inside of tank -- position O-ring seal and bend tabs to secure. When replacing dispensers, lubricate O-rings with rinse-aid & support inner doors to avoid damage if O-rings stick.

Part # 6 -- Dispensers (2)

During each wash program, the wax motor opens twice -- once to dispense detergent and again to dispense rinse-aid. The wax motor opens the same way -- the linkages make the separate compartments open.

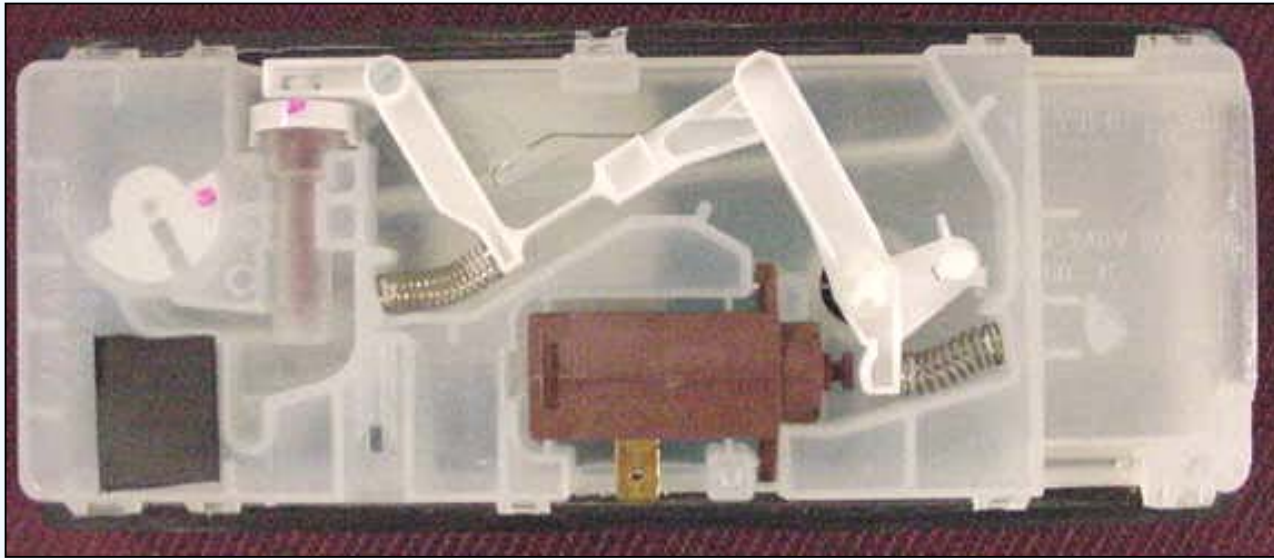

**Condensation
tube (for vented
dispenser)**

NOTE: The white plastic linkage 1st opens the detergent dispenser door, then cocks in place to dispense rinse-aid when the wax motor operates the 2nd time. After the 2nd operation, the linkage resets itself so it will open the dispenser detergent door for the next wash program.

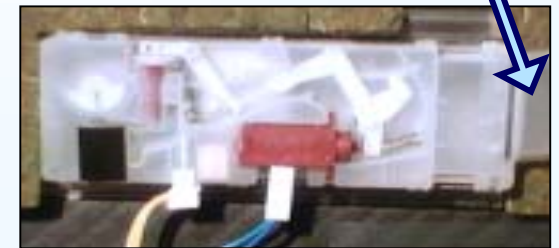

Part # 6 -- Dispensers (3)/Condensation Tubes

For UC/12 and later dishwashers, condensation tubes were moved (from dispensers) to the right side of tanks. This required a change from vented dispensers to unvented dispensers.



HINT: UC/12 model condensation tubes exit in the base behind the sump. There is no drain connection for these tubes.

HINT: Vented dispensers cannot be used to replace unvented dispensers. If they are, dishes won't dry properly and there can be water leaking inside dishwasher doors.

HINT: There are a limited number of UC/11 dishwashers with condensation tubes in tanks and with unvented dispensers. Treat them like UC/12 dishwashers.

Service Tips -- Replacing Dispenser Doors

Most dispenser problems occur from dispenser doors being damaged or pulled off (due to misuse). Please follow the instructions below when replacing doors.



- 🔧 Connect spring to door & dispenser housing posts.
- 🔧 While keeping spring attached to posts, carefully slide door onto housing -- making sure door tabs engage dispenser door rails.
- 🔧 Door levers don't need to be preset during installation.

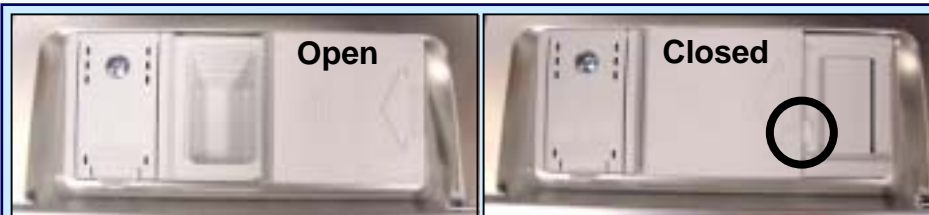

HINT: To close dispenser doors, slide doors closed, then push white lever until lever locks (showing doors are closed). Levers don't need to be preset during installation.



HINT: Make sure door tabs engage dispenser door rails.

Service Tips -- Top Load Dispensers (1)

Many high-end models (with digital displays) have top-load dispensers, enabling detergent and rinse-aid to be added while doors are partially open (preferably @ 45°).



HINT: Top-load dispensers are mounted similarly to standard dispensers.

HINT: Check the Use & Care Manual on changing top-load dispenser rinse-aid dosage using dishwasher controls.

Rinse-aid dosage is shown on the digital display and is changed through the dishwasher controls, not through a dispenser dial.



Standard dispenser



Top-load dispenser

NOTE: Top-load and standard dispensers are **NOT** interchangeable.

Push onto the **blue** button to release the detergent cup (once the door has been opened).

Service Tips -- Top Load Dispensers (2)

Top-load dispensers measure rinse-aid levels, but not with removable reed switches as with traditional dispensers. The dispensing mechanism also operates differently from traditional dispensers. All top-load dispensers are unvented.

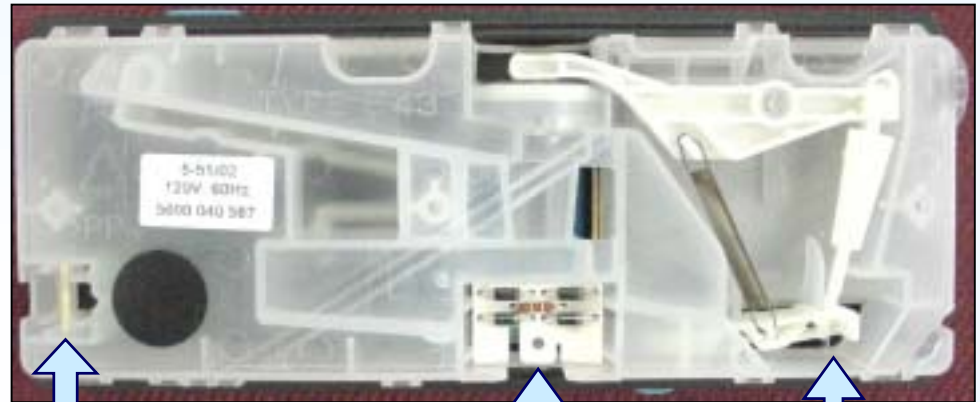

Rinse-aid level sensor

Top-load dispenser actuator terminal

Mechanism latches at the bottom of the dispenser

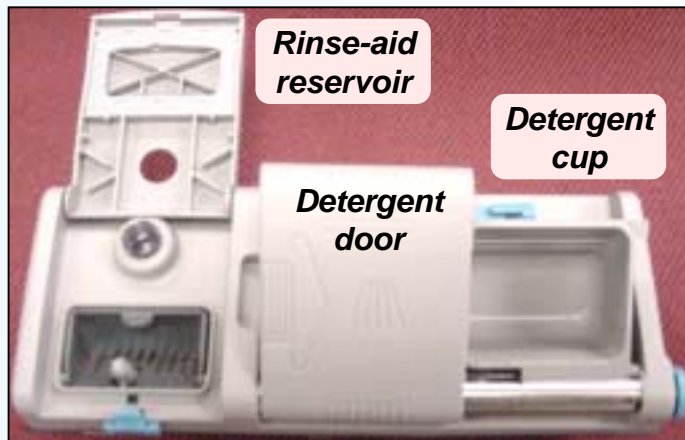

Rinse-aid reservoir

Detergent cup

Detergent door

HINT: Resistances of actuator and rinse-aid sensor cannot be measured.

Service Tips -- Top Load Dispensers (3): Rinse-aid Dosage

Unlike with standard dispensers, top-load dispenser rinse-aid dosage is adjusted on the fascia (control) panel. Use these instructions when *Use & Care Manuals* aren't available.

**SHI66A, SHU66C, SHV66A,
SHX56B, SHY66C**

SHV99A, SHX99B, SHY99A

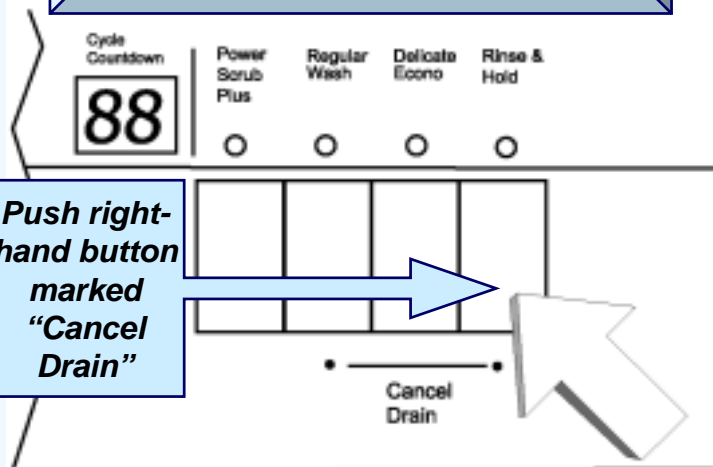

Push right-hand button marked "Cancel Drain"



- 🔧 While pushing & holding right-hand button marked **Cancel Drain**, push **On/Off** button. Display will show a # from 0 – 6.
- 🔧 Push right-hand button again to adjust rinse-aid dosage – higher # to reduce spotting & a lower # to reduce streaking.

- 🔧 Open door slightly to access buttons, then push **On/Off** button. Push "**Option**" button **5** times until "**Rinse-aid**" option shows (see above).
- 🔧 Push "+" or "-" buttons to adjust rinse-aid dosage: push "+" button to get a higher # to reduce spotting & push "-" button to get a lower # to reduce streaking.
- 🔧 If desired, push the **green Main Menu** button once to change other options or twice to start the dishwasher (close the door to begin the wash cycle).

HINT: On SHV, SHX & SHY models, open door slightly to access buttons.

Part # 7 -- Top Ten Dishwasher Cosmetic/Customer Use/Installation Issues

Top Ten Cosmetic/Customer Use/Installation Issues:

- ⑩ Not cleaning sump filters....Customers often don't know they exist.
- ⑨ Smelly dishwashers....Often occurs from filters not being cleaned, drain hose high loops missing or drain gases being present. If all else is OK, then problem can be preservative not purged from tank door gasket.
- ⑧ Doors leaking or not latching....Usually an installation issue (dishwasher brackets installed before dishwashers are leveled front to back, tanks & doors out of square, wooden doors not drilled accurately). Can be blockage in condensation tubes or having condensation tubes connected to drain hose air gaps.
- ⑦ Inner door damage....From upper rack during improper shipping and handling (dishwashers clamped on wrong sides or dropped).
- ⑥ Doors hit toe kicks....Toe kick installation issue.
- ⑤ Junction boxes....Comes from wires not being connected correctly during installation.
- ④ Dispensers....Customers using too much detergent, not using rinse-aid & not knowing how to close the door.
- ③ Drain hoses not installed properly....Often no air gap or high loop + pinched hoses -- causes poor draining & smelly dishwashers. Most drain pumps are mistakenly replaced for drain hose installation issues.
- ② Outer doors....Most are dinged during shipment.

...and the # 1 dishwasher cosmetic/customer use/installation issue is...

- ① **Damaged water valves**....Primarily from fittings being overtightened. A damaged valve can allow some water onto kitchen floors.

Service Tips -- Water Leaking Past Doors

Water seldom leaks out of bottom of dishwasher doors. Usually it's a customer or installation issue. Occasionally temporary blockages of condensation tubes by air pockets (from standing water in loops) or kinks in tubes causes leaking. Pressure builds in tanks, blowing water past lower door seals. Draining condensation tubes and straightening out kinks solves these occasional problems.

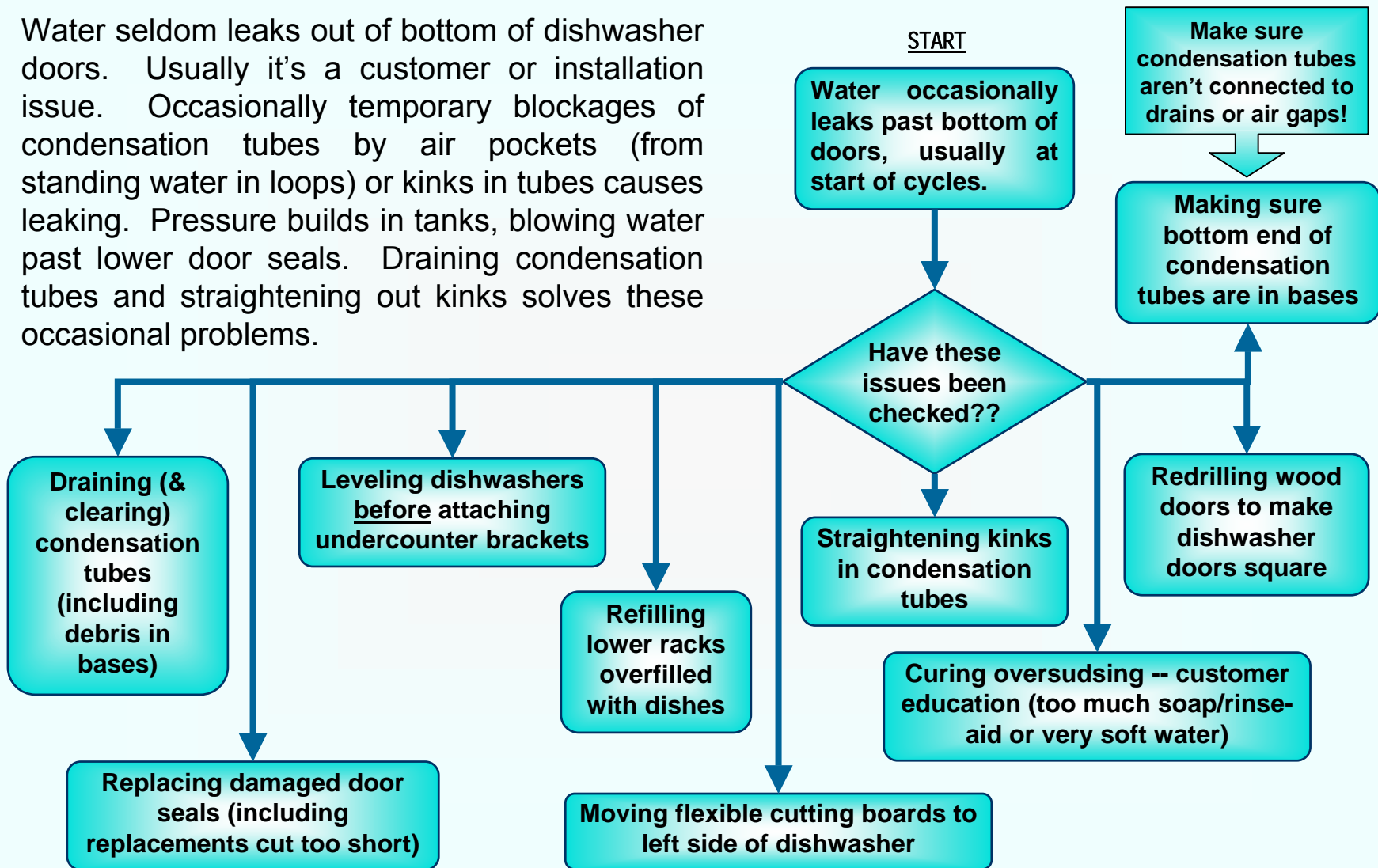

Part # 8 -- Door Latches (1)

Disassembly/ Installation

Other than occasional misalignment, the only door latch repairs will be replacing microswitches on fully integrated models (e.g. **SHV, SHX, SHY, DW44, SHU 88/99, SL84/A95A**, etc.). **SL34A** models also use these door latches.

To disassemble door latches for integrated models:

- ✂ Remove T-20 Torx fascia panel screws from inner door.
- ✂ Lower fascia panel from door.
- ✂ Locate door latch in console.
- ✂ Bend out console metal tabs to allow latch removal.



NOTE: Door latches for UC/14 & up models are different than UC/06 - UC/12 models -- they cannot be interchanged. Must replace strike plate & door latch together.

Remove panel screws

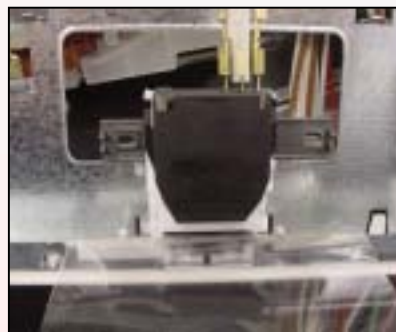

Lower fascia panel





Door latch in console

Tabs (inner view)

Bend out metal tabs

Part # 8 -- Door Latches (2)

To remove & install door latches for integrated models (continued):

-  Remove door latch from console.
-  Disconnect wire harness, then remove microswitch & cover.
-  Disconnect wires, then remove microswitch from cover.
-  Replace microswitch, then reassemble.

HINT: Make sure plastic latch tabs are aligned & metal console tabs are bent back completely during reassembly.



Remove door latch



Remove microswitch



Microswitch



Replace cover (in slots)



Insert latch into tabs



Bend tabs back



Replace fascia panel



Replace screws

Part # 8 -- Door Latches (3)

SHU & SHI dishwashers have door latches linked mechanically to door switches. All other dishwashers (**SL, SHV, SHX, SHY, SHU88/99, DW44 & GI936**) use electronic door switches (microswitches activated by door latches).

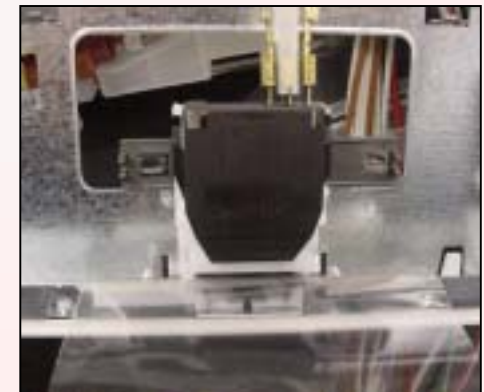

Service Tips -- Misaligned latches

Occasionally integrated dishwasher door latches can be misaligned, causing doors to not close properly or dishwashers to run with doors open (when latches don't reset). Follow these steps to realign door latches.

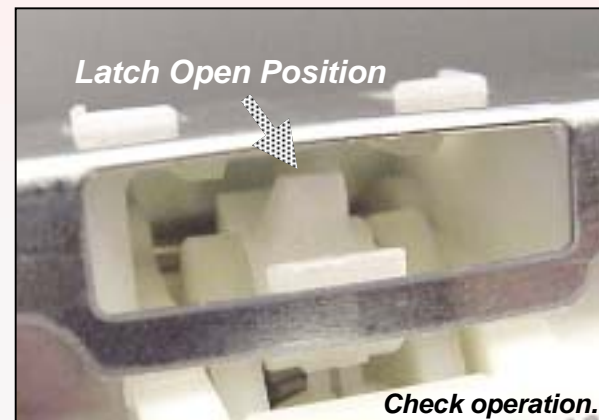
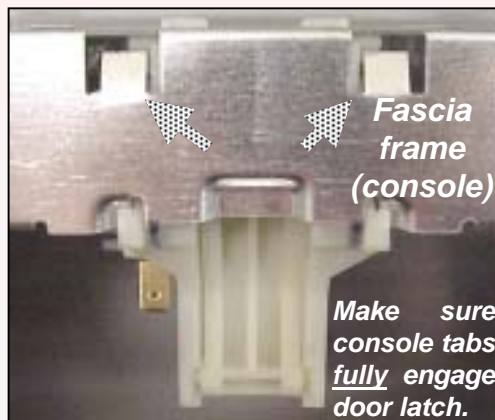
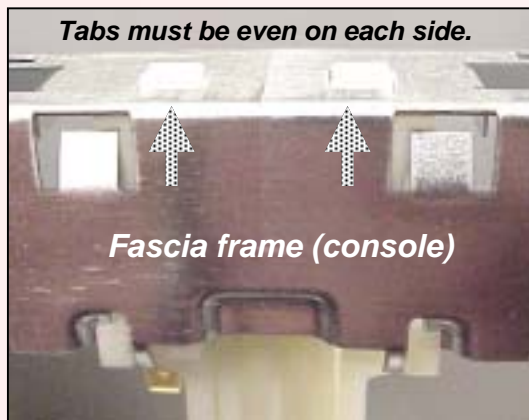

Insert latch tabs into frame

Bend tabs down into latch

Reset latch to open position



419828 door latch with microswitch

HINT: Make sure latch tabs are seated, all fascia frame (console) tabs are bent completely, door strikes are aligned with latches and door latches get reset.



187184 ball bearing door latch with microswitch

NOTE: Integrated dishwashers include the following models: SHV, SHX, SHY, SHU88/99/995x, GI936-760, SL84A/95A & DW44.

Service Tips -- Miswired latches

If replacement **SHV46/66**, **SHU995x**, **SHV68**, **SHX33/43/46**, **SHY56/66** or **SL95A** door latches/wire harnesses are miswired (with door latch terminals backwards), dishwashers run with doors open and lights won't turn on when doors are open. Control modules can be irreversibly damaged.



Rewiring door latches:

- Check wiring to photos at right – the double wire must be connected to the silver door latch terminal.
- With door open, turn on dishwasher – keep door open. If display doesn't turn on, immediately turn off dishwasher and reverse door latch terminal.

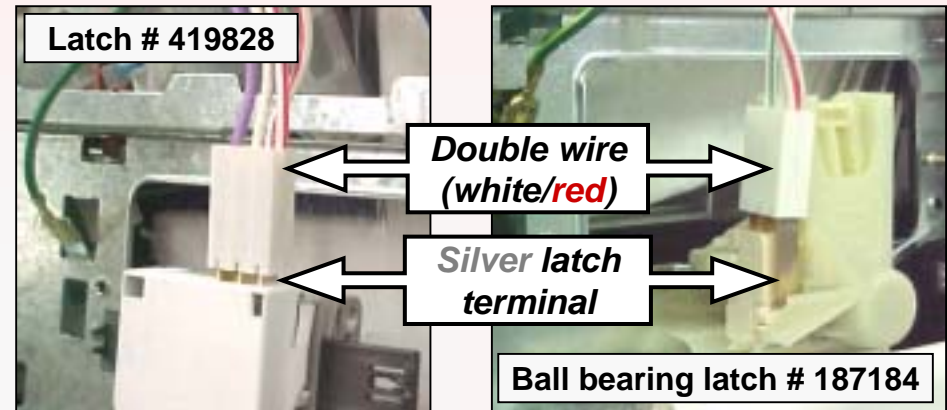

CAUTION: Operating dishwashers with miswired door latches will cause **irreversible** damage to control modules if doors have been closed and circulation pumps have started – modules must be replaced. Check door latch wiring whenever door latch terminals are changed or disconnected or when displays don't light up when dishwashers are turned on.

IMPORTANT: If dishwashers with miswired door latches are corrected before doors are closed and circulation pumps started, modules can still be used. If displays don't light up, turn off dishwashers and reverse door latch terminals before modules are damaged.

Part # 9 -- Aqua Sensors (1)

The aqua sensor only affects energy usage, eliminating a pre-wash and/or pre-rinse cycle if water is clean. Most customers won't notice the difference if an aqua sensor fails.

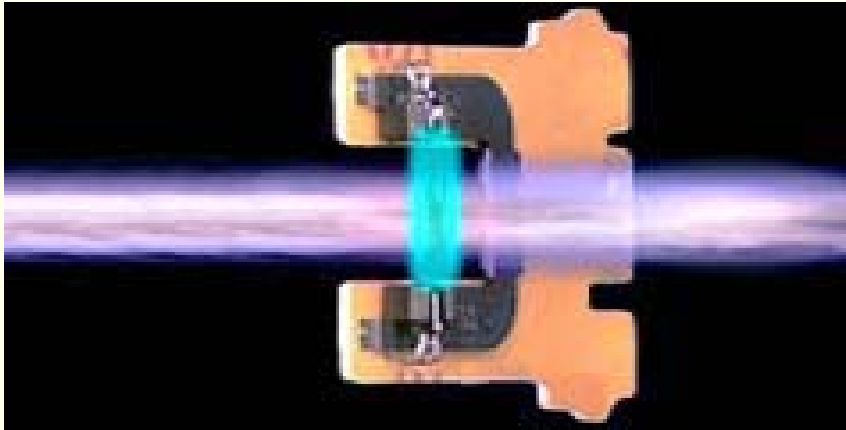

NOTE: Aqua sensors provide ~ 20% energy savings.

HINT: Dishwashers still operate adequately when aqua sensors fail.

HINT: Customers will only notice aqua sensors failing if they see their dishwashers running slightly longer or their electric and water usage getting slightly higher.

NOTE: If water is clean enough, it will be kept for the wash cycle. If not, the aqua sensor directs the dishwasher to add an additional pre-rinse or pre-wash cycle.



Part # 9 -- Aqua Sensors (2)

The aqua sensor is located on the rear of the sump. It can be reached through the left side of the dishwasher (after the left side panel is removed). Its not necessary to block up the tank to reach the aqua sensor.

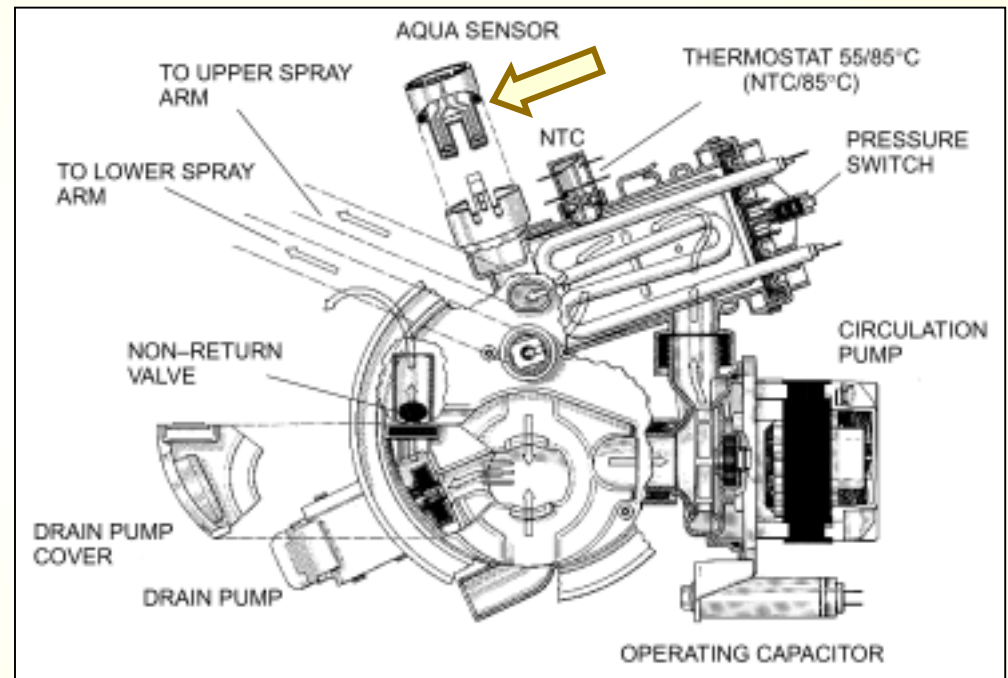
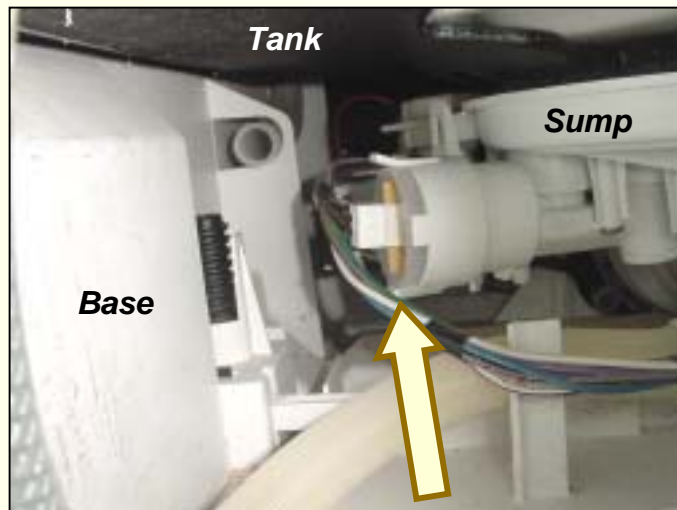

HINT: To change out the aqua sensor, pull off the connector and pull out the aqua sensor (toward the rear of the dishwasher).

NOTE: The *Apexx Sensotronic 2* aqua sensor # **175340** is similar to standard aqua sensor # **165279**, except it has two (red & green) soil sensors. They mount the same way, but are **not** interchangeable.

HINT: The aqua sensor slides into slots in the sump. Make sure the aqua sensor is properly inserted into the slots.

Part # 10 -- Water Fill Assembly (1)

Water fill assemblies insure dishwashers fill properly at various incoming pressures.

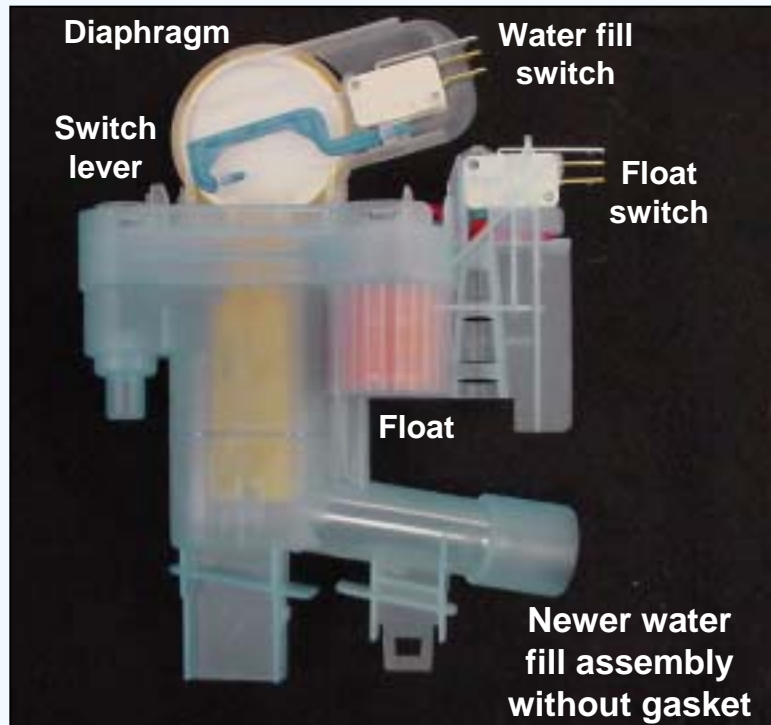

NOTE: Older water fill assemblies required a gasket between the upper and lower housings. Newer ones do not require gaskets and are a drop-in replacement for older ones.



HINT: Floats should be checked and bases should be cleared of water & debris whenever water fill assemblies are worked on.

Part # 10 -- Water Fill Assembly (2)

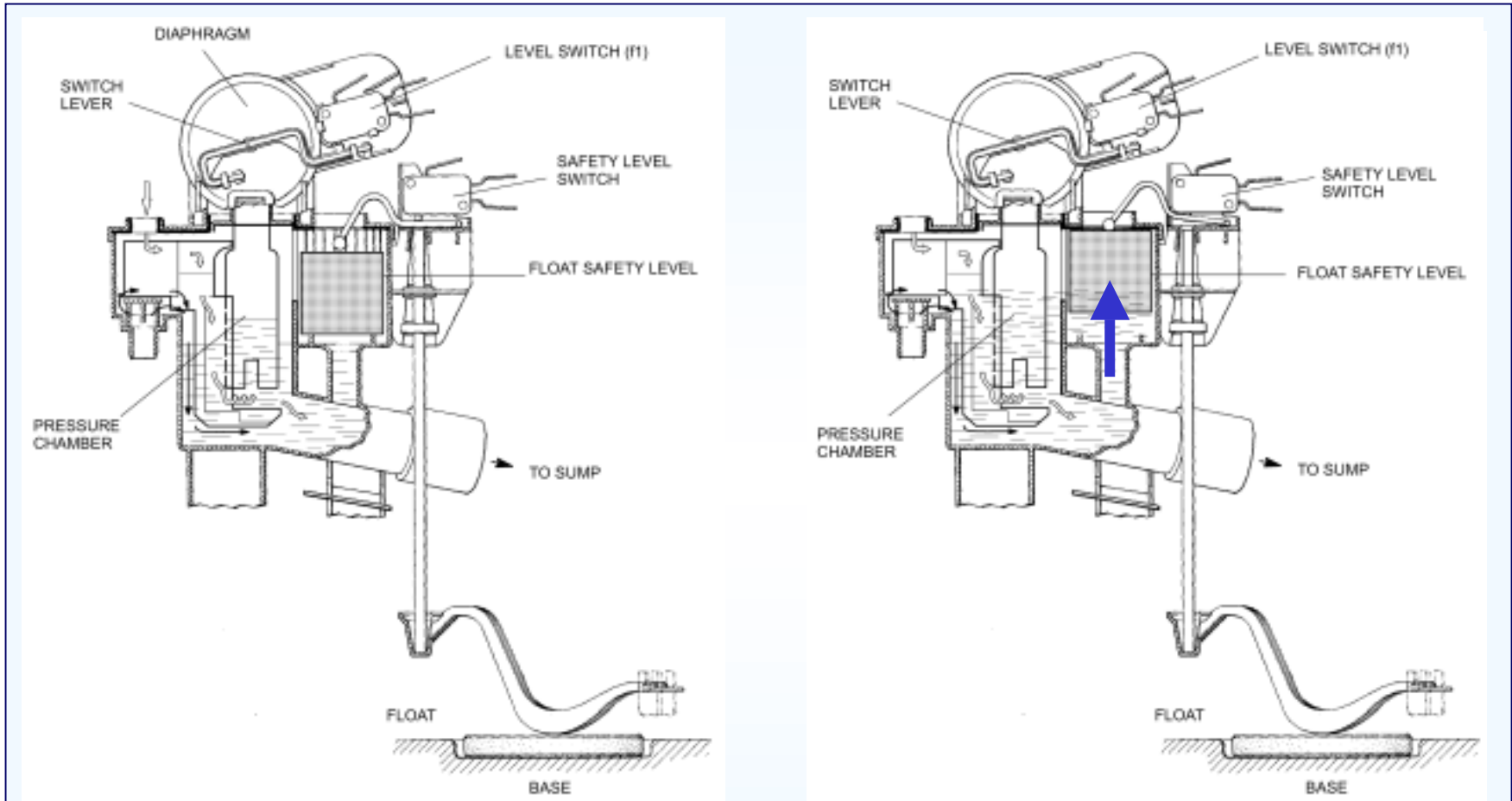

Normal fill: Water rises to proper level, pushing air in pressure chamber which operates diaphragm.

Overfill: Water rises too high & operates float switch, causing drain pump to remove water from sump.

Part # 10 -- Water Fill Assembly (3)

The water fill assembly is easily accessed from the left side by just removing the left side panel.

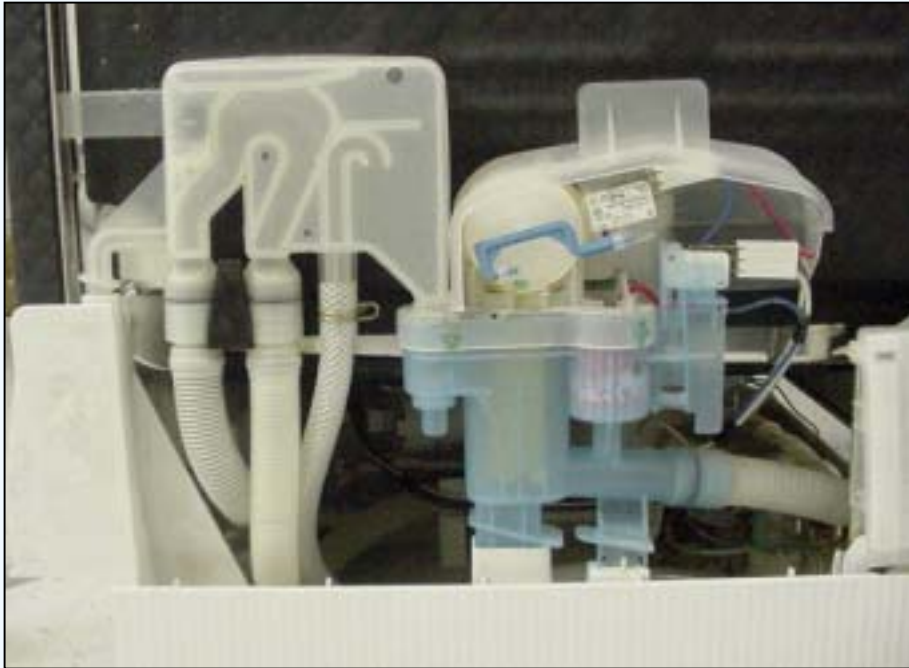

HINT: Most water fill assembly repairs will involve replacing microswitches. Occasionally tank insulation or other debris can prevent the diaphragm switch lever from operating, allowing overfilling.

Miscellaneous Service Tips – Terminal Box Covers

Since September, 2003, all dishwashers have included larger terminal boxes (“junction boxes” or “J-boxes”) with covers.



Old terminal boxes

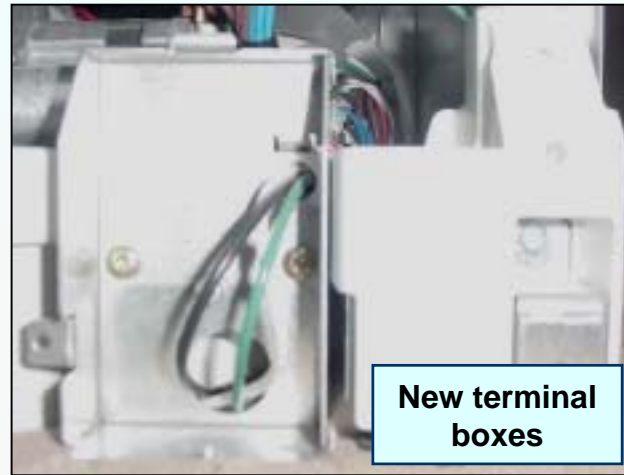

New terminal boxes

NOTE: Unlike old boxes (where conduits exited bottom of boxes), new terminal boxes have rear conduit exits.



New box with cover



New box with cover



Conduit exit shown

NOTE: Old terminal boxes met UL standards – toe kicks were approved as terminal box covers. There's no need to change out old terminal boxes.

Miscellaneous Service Tips – Repairing SHV66A/99A, SHX56B/99B & SHY56A/66C/99A Dishwashers (FD # 8310 & earlier): (1)

Whenever working on **SHV66A/99A**, **SHX56B/99B** & **SHY56A/66C/99A** dishwashers built on or before October, 2003 (FD # 8310 and earlier) for any reason, please also perform the following repairs.

1. **If the pump works**, check ratings on rear of pump motor (see photos below & tech hints on page xx). If pump motor shows # “5600.060022” (service # 437345), pump is OK. If pump motor shows # “5600.050139” (service # 239129), verify motor starter shows # “041692” (service # 423023) by removing starter and turning it upside-down (see photos below). If motor starter shows # “036906” (service # 182318), replace it with starter # 423023. See page xx for motor starter installation instructions.

If the pump has failed, replace both pump and pump motor starter with pump # 437345, which includes motor starter # 182318 packed with it.



2. **Check door latch and realign if necessary** (see page 97). Access door latch by removing outer door and fascia panel.

Miscellaneous Service Tips – Repairing SHV66A/99A, SHX56B/99B & SHY56A/66C/99A Dishwashers (FD # 8310 & earlier): (2)

TECH HINTS: Checking pump motor & motor starter #'s requires pulling out dishwashers & removing right side panels. To save time working on **SHV66A**, **SHX56B** & **SHY56A/66C** models (since fascia panels must also be removed to check door latch alignment), measure pump resistance at control module – between white/red wire (2nd from right) & gray wire (3rd from right). Close door or trip door latch before measuring resistances.

- If resistance ~ 9.4Ω, motor & starter are OK.
- If resistance ~ 7Ω, pull out dishwasher and check pump motor & motor starter #'s as shown in #1 on previous page.

Motor Terminals	Motor Only	With Starter # 182318	With Starter # 423023
1-3	14.3Ω	7Ω	9.4Ω
1-4	8.7Ω	6.2Ω	7Ω
2-4	22.4Ω	3.5Ω	9.9Ω

Starter # 182318	4.7-4.8Ω
Starter # 423023	16.8Ω

**Resistance Readings
at Motor Terminals:**

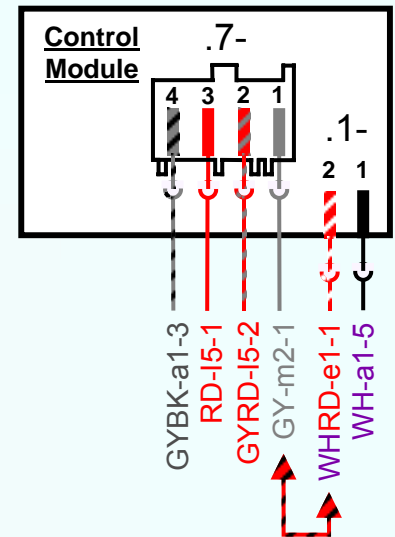

Installing circulation pump motor starters:



To install (PTC) motor starters, push female terminals over pump motor terminals 2 & 4. The terminals are different sizes to match the smaller motor terminal 4.

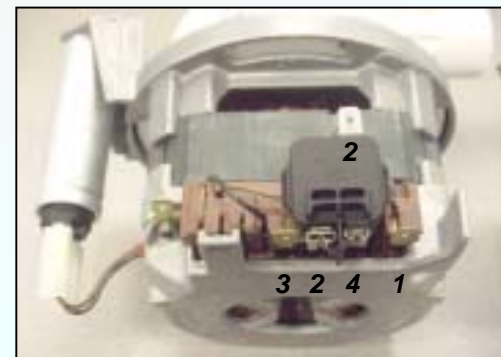

HINT: (PTC) motor starter is located on top of the pump motor – install it with terminal 2 facing inward (as shown above).

Miscellaneous Service Tips – Repairing SHV66A/99A, SHX56B/99B & SHY56A/66C/99A Dishwashers (FD # 8310 & earlier): (3)

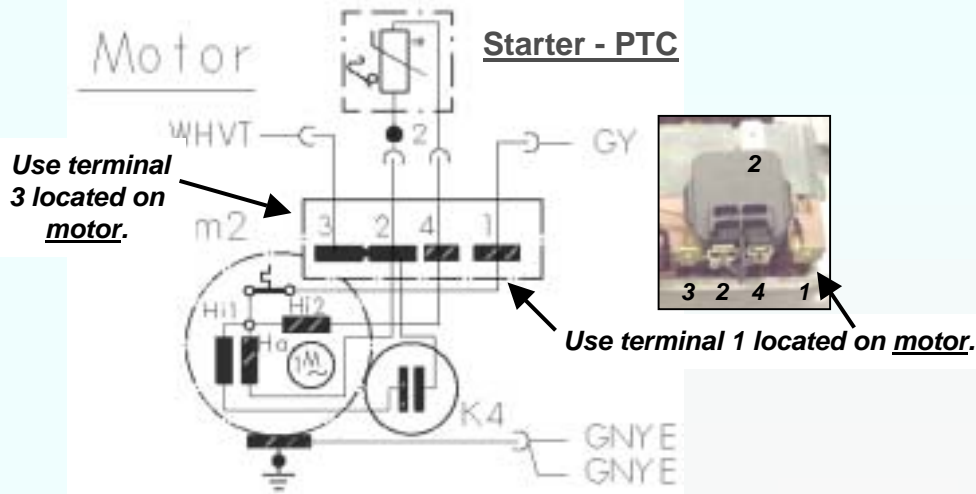

HINTS: Identifying circulation pumps & motor starters:

- ① Circulation pump # **437345** – # “5600 060022” on housing (on rear of motor).
- ① Motor starter # **182318** – # “036906” on housing.
- ① Circulation pump # **239129** – # “5600 050139” on housing (on rear of motor).
- ① Motor starter # **423023** – # “041692” on housing.

NOTE: Circulation pump # **437345** includes motor starter # **182318**. When replacing any pump, **always** replace the motor starter as well.

Realigning door latches:

Occasionally dishwasher door latches can be misaligned, causing doors to not close properly or dishwashers to run with doors open (when latches don't reset). Please follow these steps to realign door latches.



First: Insert latch tabs into frame, insuring they're even on each side.

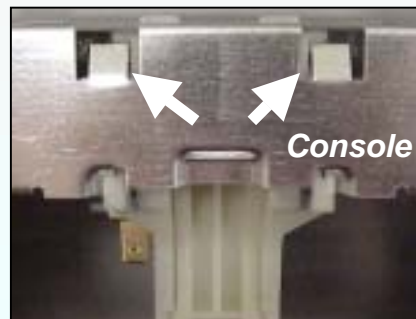

Second: Bend console tabs into door latch until they're fully engaging it.

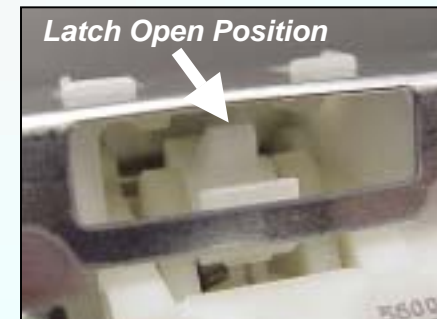

Third: Reset latch to the open position and check for proper operation.