

RELEASED APRIL 2002

CINEMA RHAPSODY

MACH II

VERSION 3.4G

INSTALLATION MANUAL

ada audio
design
associates®

Safety Instructions & Electrical Warning

READ INSTRUCTIONS - All the safety and operating instructions should be read before the appliance is operated.

RETAIN INSTRUCTIONS - The operating instructions should be retained for future reference.

HEED WARNING - All warnings on the appliance and in the operating instructions should be adhered to.

FOLLOW INSTRUCTIONS - All operating and use instructions should be followed.

WATER AND MOISTURE - The appliance should not be used near water - for example, near a bathtub, washbowl, kitchen sink, laundry tub, in a wet basement, or near a swimming pool, etc.

LOCATION - The appliance should be installed in a stable location.

WALL OR CEILING MOUNT - The appliance should not be mounted to a wall or ceiling.

VENTILATION - The appliance should be situated so that its location or position does not interfere with its proper ventilation. For example, the appliance should not be situated on a bed, sofa, rug or similar surface that may block the ventilation openings.

HEAT - The appliance should be situated away from heat sources such as radiators, heat registers, stoves, or other appliances that produce heat.

POWER SOURCES - The appliance should be connected to a power supply only of the type described in the operating instructions or as marked on the appliance.

GROUNDING - Make sure that this unit is always connected to a standard three-prong grounded outlet (the circular pin is ground). When operating this unit at a higher voltage with a different power cord configuration, consult your dealer for the proper power cord/outlet combination to use before operating this unit.

POWER CORD PROTECTION - Power supply cords should be routed so that they are not likely to be walked on or pinched by items placed upon or against them, paying particular attention to cords at plugs, convenience receptacles, and the point where they exit from the appliance.

CLEANING - The appliance should be cleaned only with a polishing cloth or a soft dry cloth. Never clean with furniture wax, benzene, insecticides or other volatile liquids since they may corrode the face plate.

POWER LINES - An outdoor antenna should be located away from power lines.

NONUSE PERIODS - The power cord of the appliance should be unplugged from the outlet when left unused for a long period of time.

OBJECT AND LIQUID ENTRY - Care should be taken so that objects do not fall and liquids are not spilled into the enclosure through openings.

DAMAGE REQUIRING SERVICE - The appliance should be serviced by an authorized service center or qualified service personnel when:

- The power supply cord or plug has been damaged; or
- Objects have fallen, or liquid has been spilled into the appliance; or
- The appliance has been exposed to rain; or
- The appliance does not appear to operate normally or exhibits a marked change in performance; or
- The appliance has been dropped; or the enclosure has been damaged.

SERVICING - The user should not attempt to service the appliance beyond that described in the operating instructions. For all other service requirements, the user should contact an Authorized Dealer or Service Center.

WARNING:

TO REDUCE THE RISK OF FIRE OR ELECTRICAL SHOCK, DO NOT EXPOSE THIS APPLIANCE TO RAIN OR MOISTURE. REPLACE FUSE ONLY AS MARKED.

CAUTION:

TO PREVENT ELECTRIC SHOCK, DO NOT PLUG THIS UNIT INTO ANY OUTLET OR EXTENSION CORD WITHOUT THE STANDARD THREE-PRONG CONFIGURATION, WHERE THE CIRCULAR HOLE IS USED FOR THE GROUND PLUG. ANY UNITS NOT SOLD IN THE UNITED STATES OR CANADA ARE NOT SUPPLIED WITH A POWER CORD. THEREFORE, AN AUDIO DESIGN ASSOCIATES DEALER SHOULD BE CONSULTED BEFORE CONNECTING THIS UNIT TO ANY POWER SOURCE.

LINE VOLTAGE SELECTOR SWITCH AND REMOVABLE POWER CORD:

THIS UNIT IS EQUIPPED WITH A VOLTAGE SELECTOR SWITCH. IN MOST CASES, THIS SWITCH WILL REMAIN IN THE 115V POSITION (SEE PICTURE BELOW), WHICH IS HOW THE UNIT LEAVES THE FACTORY. HOWEVER, IF YOU WANT TO OPERATE THE UNIT IN AN AREA THAT USES THE 230V SETTING, CONSULT YOUR DEALER BEFORE PLUGGING THE UNIT IN. IN A CASE WHERE THE 230V SETTING WOULD BE NEEDED, AUDIO DESIGN ASSOCIATES WILL NOT PROVIDE A POWER CORD FOR THE UNIT. THEREFORE, THE USER MUST CONSULT AN AUTHORIZED DEALER OR ADA TO OBTAIN THE PROPER POWER CORD, AS WELL. **MAKE SURE THAT THE VOLTAGE SELECTOR SWITCH IS IN THE PROPER POSITION AND THAT YOU HAVE THE CORRECT POWER CORD BEFORE THIS UNIT IS PLUGGED IN AND OPERATED!**

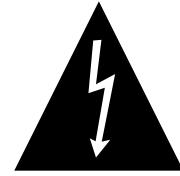

The lightning flash with the arrow-head, within an equilateral triangle, is intended to alert the user of the presence of uninsulated "dangerous voltage" within the product's enclosure that may be of sufficient magnitude to constitute a risk of electrical shock to persons.



CAUTION: TO PREVENT RISK OF ELECTRICAL SHOCK, DO NOT REMOVE COVER (OR BACK). NO USER-SERVICEABLE PARTS INSIDE. REFER SERVICING TO QUALIFIED SERVICE PERSONNEL.



The exclamation point within the equilateral triangle is intended to alert the user of the presence of important operating and maintenance (servicing) instruction in the literature accompanying the appliance.

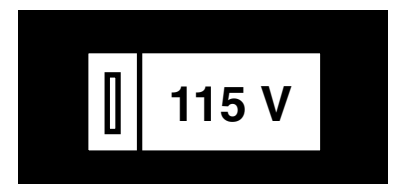

Contents

Safety Instructions & Electrical Warning	1
AC Connections	4
Power Amplifier (& Powered Subwoofer) Connections	5
Introduction - Front Panel Controls & Displays	6
Power On, Mute, Off, & Master Volume Control	7
Input Selector	8
Record Selector	9
Rear Panel Connections	10
Out of the Box Input Configuration	11
DVD Player Connection	12
DVD Audio/SACD Player Connection	13
DSS Receiver Connection	14
TOS-Link Optical Interconnects & Audio Dropouts	14
DSS Receiver Connection - Coaxial Connection	15
DVR/PVR Connection	16
VCR Connection	17
Cable or TV Tuner Connection	17
CD Player Connection	18
CD Player Digital Connections	19
Tuner (Radio) Connection	20
Auxiliary Component Connection	20
Multi-Room System Connection	21
Camcorder Connection	21
Video Game Connection	22
Computer Connection	23
Phonograph Connection	23
Laserdisc Player with Internal RF Demodulator	24
Laserdisc Player with only an AC-3 RF Output	25
Theater (Main) Video Connections	26
Recording Output	28
Custom Input Configuration	32
Final Input	32
Label Inputs	33
Audio Input Configuration	36
Composite Video Input Configuration	37
S-Video Input Configuration	38
Component Video Input Configuration	38
Auxiliary DC Triggers	38
Turn On Input	40
Illumination	40
Speaker Size Setup 1	41
Subwoofer Crossover Point Setup	43
Multi-Pin Speaker Setup	44
Multi-Pin Input LFE Boost Switch	45
Speaker Level Setup 2	46
Balance Presets	48
Delay Level Setup 3	49
Bass Setup 4	51
Bass Limiter	51
THX Ultra Setup 5	52
Boundary Gain Control (BGC)	52
Advanced Speaker Array (ASA)	52

DTS LFE Settings	53
DTS LFE Adjustment Enable	53
DTS LFE Adjustment	53
Tone Controls	54
Tone Presets - Out of the Box	54
Recalling Tone Presets	55
Speaker Groups	56
Treble Group A	57
Bass Group A	57
Treble Group B	57
Bass Group B	58
Storing Tone Presets	58
Volume Setups	59
Storing Volume Presets	59
Recalling Volume Presets	59
Turn-On Volume Level Setup	59
Maximum Volume Level	60
Analog Gain	60
Channel Volume Adjustment	61
Solo Mode	61
RS-232 Control Options	62
ADA Bus Data Port	62
ISO-232 ADA Bus to RS-232 Wired I/O Device	62
RS-232 Connection & Settings	62
RS-232 Connection with Other ADA Bus Systems/Components	63
IRT-232 IR Transceiver to RS-232 Wireless I/O Device	64
PC Setup & Control Software	64
External IR Receiver Options	65
Baud Rate Setup	67
IR Transceiver (Front Panel) Settings	68
Address Setup	68
Output Channel Indicator Lamps	70
Mode Selection	71
Multi-Channel Formats	72
Cinema Modes & Indicator Lamps	73
Two Channel Modes & Indicator Lamps	76
Proprietary Two Channel ADA Modes	81
Fun Modes	83
THX Enhancements	85
Dynamic Range	87
Default Modes	88
User Modes	90
Appendix A - Out Of The Box Settings Overview	92
Appendix B - Custom Setup Work Sheet	93
Appendix C - Resetting Factory Defaults	94
Appendix D - Master Reset Power Button (Vacation Switch)	95
Appendix E - Cinema Rhapsody Mach II PC Program	96
Appendix F - Cinema Rhapsody Mach II Hex Codes	103

Dolby and the double-D symbol are trademarks of Dolby Laboratories Licensing Corporation. Confidential Unpublished Works. © Copyright 1992-2002, Dolby Laboratories, Inc. All Rights Reserved. Lucasfilm and THX are trademarks or registered trademarks of Lucasfilm, Ltd. ©Lucasfilm Ltd. & TM. Surround EX is a jointly developed technology of THX and Dolby Laboratories, Inc. and is a trademark of Dolby Laboratories, Inc. All rights reserved. used under authorization. Manufactured under license from DTS Technology, LLC. DTS Digital Surround is a trademark of DTS Technology LLC. ©2002, Audio Design Associates, Inc. All rights reserved. Technical data and information contained in this manual is subject to change without notice.

AC Connections

AC Connection

Before you plug your Cinema Rhapsody into an AC outlet, make certain that the voltage selector switch is set to the proper position. The Cinema Rhapsody's safety fuse is set to match the voltage selector's setting. There are two voltage selector switches and two safety fuse holders. When viewing the Cinema Rhapsody from the front, the Main Switch/Fuse are on the units left side. The VGA Switch/Fuse are located on the units rear panel.

If you are altering the Voltage Selector Switches, you will also most likely need to change the safety fuses.

Before You Begin

As you remove the Cinema Rhapsody Mach II from its packaging, inspect the condition of the component prior to proceeding with the following steps for AC connection. In the event that the Cinema Rhapsody Mach II appears to have suffered cosmetic damage due to shipping, please contact your Authorized ADA Dealer immediately and do not proceed to plug the unit into an AC outlet.

Caution

Before plugging your Cinema Rhapsody Mach II into an AC outlet, check the Voltage Selector Switch settings (the Main Switch and Fuse holder is located on the units left side when looking at the Cinema Rhapsody from the front and the VGA Switch and Fuse holder is located on the units back panel) and make certain that the selector is set to your appropriate voltage position. For U.S. customers, this setting should be 115V. For international customers, you may need to set this switch to 230V.

Fuse Values

For U.S. customers or international customers also operating on a 115V AC system, the Main fuse value of the Cinema Rhapsody Mach II should be a 1 Amp Slow Blow fuse. For international customers operating on a 230V AC system, the Main fuse value should be 1/2 Amp Slow Blow. The safety Main fuse is located next to the Voltage selector switch on the Cinema Rhapsody's left side (when viewing it from the front.) The VGA fuse is located on the rear panel. For systems operating at 115V AC, the fuse value is 2/10 Amp Slow Blow. For systems operating at 230V AC, the VGA fuse value is 1/10 Amp Slow Blow.

AC Connection

For customers who are using the U.S. standard AC receptacle, you will use the EIC AC Power Cord provided with the Cinema Rhapsody Mach II. Simply plug this AC cord into an operative AC outlet. For customers who are using a non-U.S. standard AC receptacle, you will need to acquire an EIC AC Power Cord with the appropriate receptacle connector. ADA only provides AC Power Cords with the U.S. standard AC prongs.

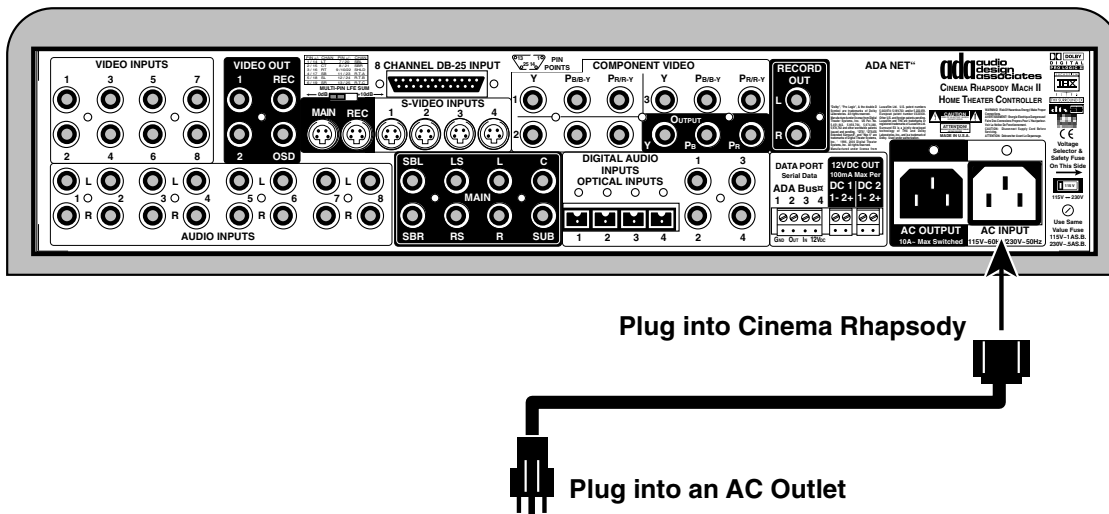

Power Amplifier (& Powered Subwoofer) Connections

Audio Connections

The Cinema Rhapsody Mach II's Audio Outputs are clearly marked in a white field on the back of the unit. ADA strongly suggests not using directional interconnects that lift the grounds. This diagram includes ADA's PTM-8150 Eight Channel Power Amplifier. While you may decide to vary the input arrangement if you are using a PTM-8150, the following input arrangement will cause the amplifier's front panel LED display to spread outward from Channel 4, the center channel speaker. If you are using a self-powered subwoofer, you will connect the Cinema Rhapsody's SUB Output directly to the subwoofer. If you are using a self powered subwoofer with the PTM-8150, you may opt to "Y" split the SUB output so as to illuminate channel eight of the PTM-8150.

Amplifier AC Connections

The Cinema Rhapsody Mach II incorporates a switched AC outlet which is rated at 10 Amps. This is powerful enough for ADA's PTM-8150 or PTM-6150 Power Amplifiers. Several other power amplifiers could also be plugged directly into this switched AC outlet. However, if the power amplifier is going to draw more than 10 Amps (such as ADA's MPA-501 Five Channel THX High-Power Amplifier), you will want to avoid using this switched AC outlet. To connect the power amplifier to the Cinema Rhapsody Mach II, you will need to use an EIC Male to EIC Female AC Cord. These AC cords are also used for computers and computer monitors and are available in stores that support computer and AC products.

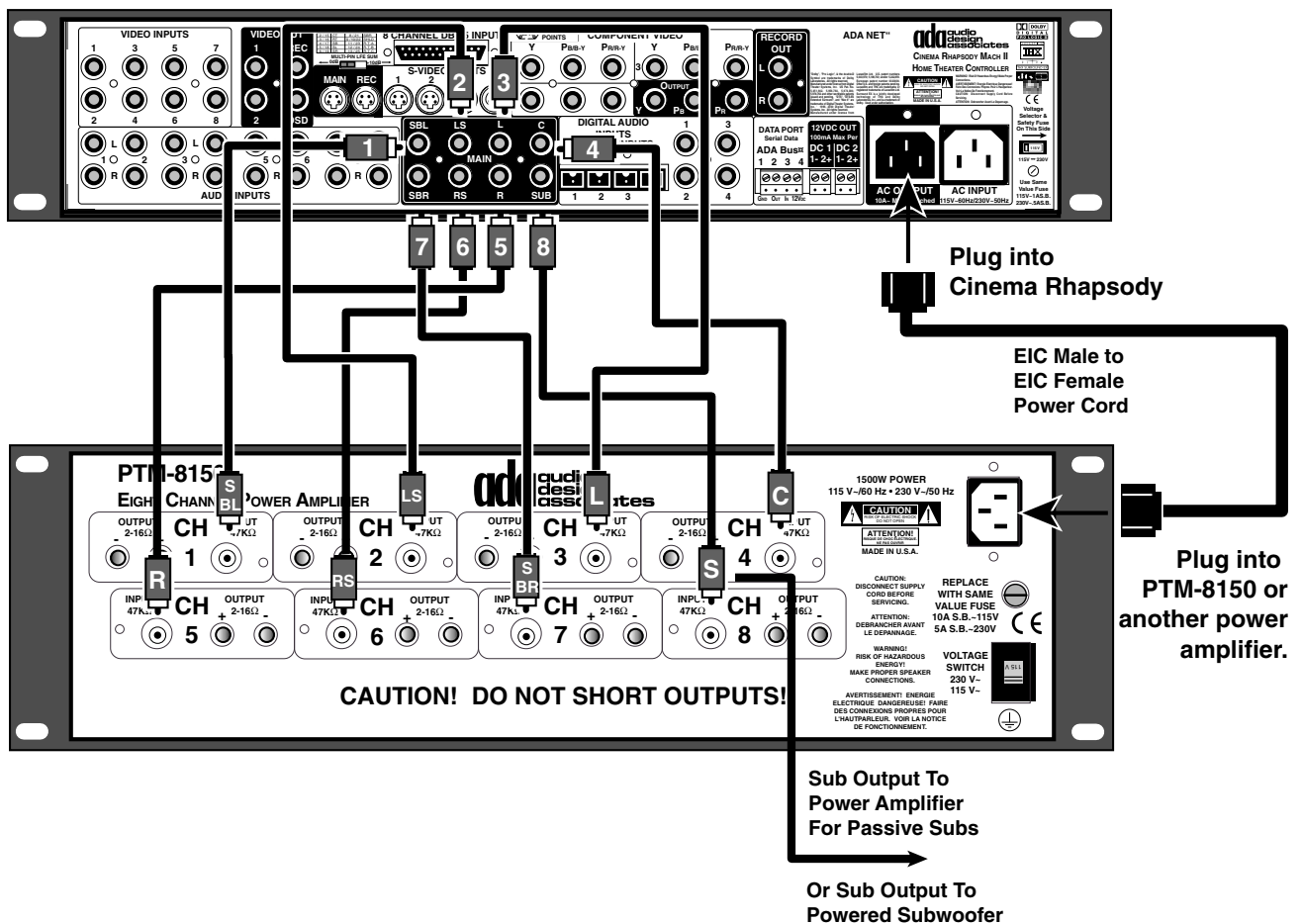

Introduction - Front Panel Controls & Displays

Overview

The Cinema Rhapsody Mach II is factory set for optimum operation. This section details the front panel features of the Cinema Rhapsody. All component functions can be operated through the five control knobs located on the units front panel. The front panel displays are also explained in this section.

Welcome

The Cinema Rhapsody Mach II is the world's most advanced audio video surround sound preamplifier. **It is also configured "Out Of The Box" for optimum operation.** While it is designed to be easy to setup and operate, ADA strongly recommends spending some time familiarizing yourself with the units many functions and features. For those who wish to customize their home theater system, the Cinema Rhapsody Mach II is also equipped to be configured to operate ideally in almost any environment and with many varying source components. While the connection of components and accessories are discussed in the following sections, this area will explain the front panel features and basic operation commands of the Cinema Rhapsody Mach II's front panel. The text found in italic type in this manual's margins will act as a quick reference when reviewing these materials.

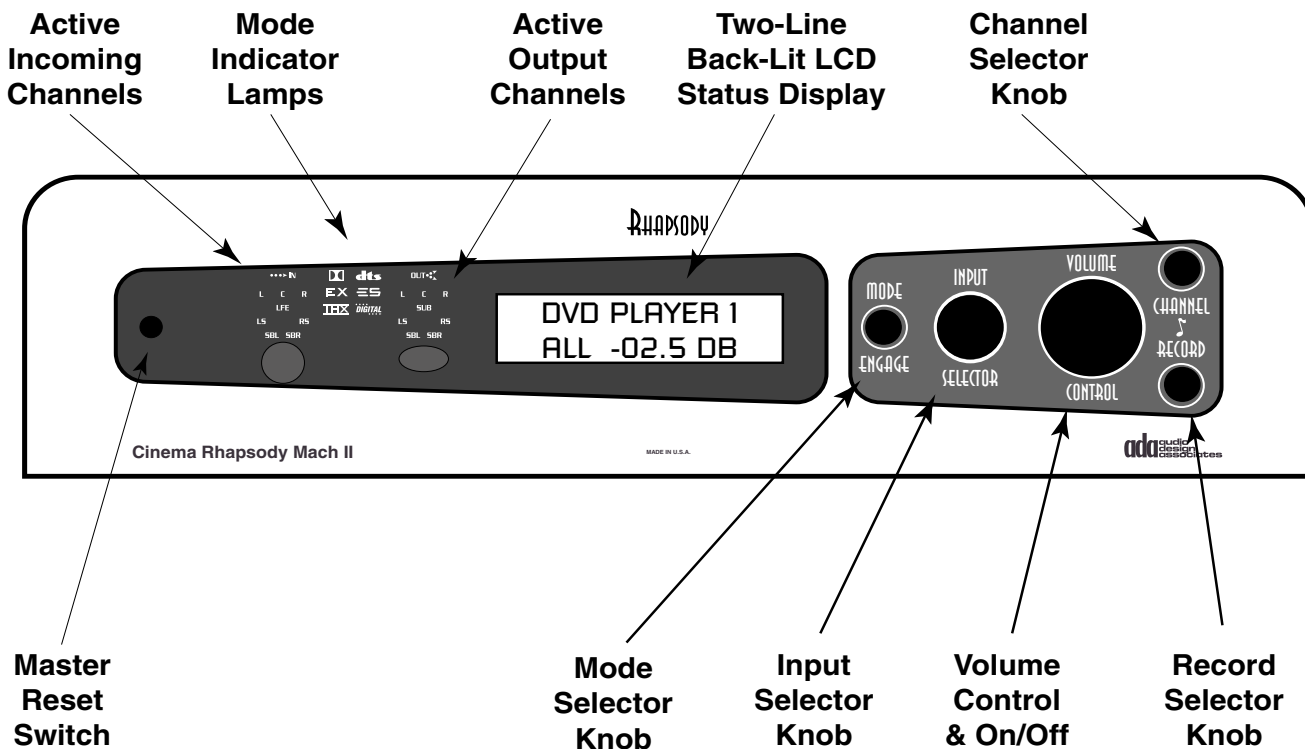

Features

The Cinema Rhapsody Mach II acts as both an input selector and surround sound decoder. It is capable of decoding Dolby Pro Logic, Dolby Digital (AC-3), and DTS encoded formats and also provide Lucasfilm THX Ultra 2 enhancements and filters. While the Cinema Rhapsody Mach II can automatically detect between Dolby Digital, DTS, Dolby Pro Logic, and Dolby Digital/Dolby Pro Logic (both decoding formats are used when playing two-channel encoded DVD discs {typically older movies available on DVD that are not mixed in six channels}), the option to engage either full THX enhancements or only THX Re-EQ must be manually set on the Cinema Rhapsody Mach II. The Cinema Rhapsody also provides several additional modes ideal for music playback. There are additional settings that permit the Cinema Rhapsody Mach II to also operate in home theaters where a full eight channel speaker array may only be partially implemented (i.e. no back surround and/or no center channel). Furthermore, the Cinema Rhapsody Mach II also permits each channel to be set to its own volume level with respect to all other channels as well as have its own delay setting. These features and more are discussed in the upcoming sections.

Power On, Mute, Off, & Master Volume Control

When the Cinema Rhapsody is off, turning any knob or pushing any knob other than the Volume knob will cause the Cinema Rhapsody's center LCD display to indicate:



To turn on the Cinema Rhapsody, providing the unit is not in Mute, press the Volume knob once. Pressing of the Volume knob performs only three functions.

If the unit is off, pressing it will turn it on.
If the unit is on, pressing it once will engage Mute.
If the unit is in Mute, pressing it again will turn it off.

(To regain the audio (exit Mute), turn the Volume knob).

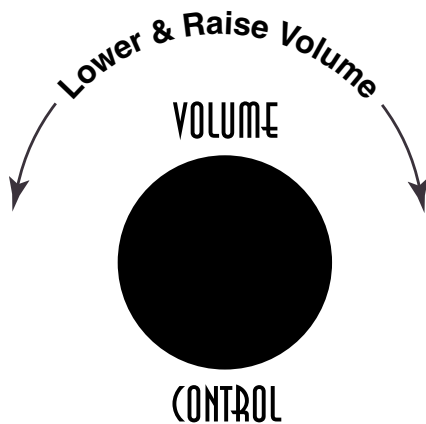

Once the Cinema Rhapsody is on, turning the Volume knob will only raise or lower the system's volume level. This is considered the Master Volume Control as it will adjust all eight channels of volume, maintaining the balance of levels that are preset between channels.

Power On

Press the Cinema Rhapsody's Volume knob to engage power on.

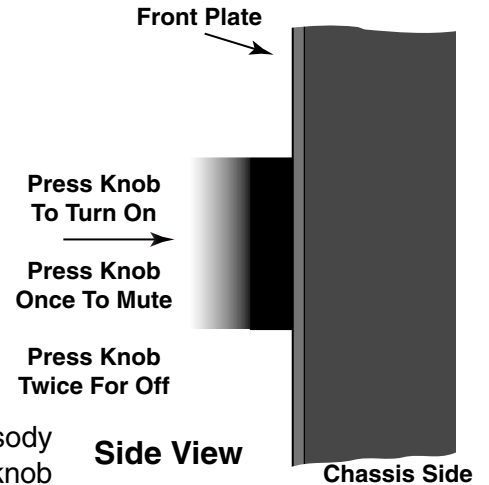

Side View

Mute

While the Cinema Rhapsody is on, pressing it's Volume knob once will mute all channels.

Power Off

While the Cinema Rhapsody is in Mute, pressing the Volume knob a second time will turn the Cinema Rhapsody off.

Un-Mute

While the Cinema Rhapsody is in Mute, turning the volume knob, will regain audio.

Power On/Off Via AC Control

If the Cinema Rhapsody is on when it is unplugged or when power is removed through the use of an AC Controller, it will also automatically turn back on when power is restored.

Input Selector

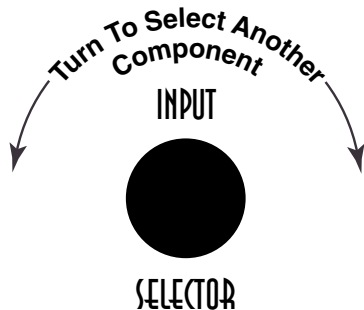

The Cinema Rhapsody Mach II permits you to scroll to the next input without having all of the components you are passing actively process through the Cinema Rhapsody Mach II. This prevents the clicking that is commonly associated with changing TV channels up and down. To best access another component from the front of the Cinema Rhapsody, turn the Input Selector knob. As you turn this knob, you will notice that the top row of the LCD display will not change, still indicating the current component in use (in this example, DVD PLAYER 1). The second line of the LCD display will advance through the input names until the desired component is displayed.

Front View

1. Dial In New Input

Turn the Input Selector knob until the second line of the LCD display reads the component you wish to select. As you turn the knob, you will notice that the top line of the display still indicates the current source in play. Also, this component is still being routed and processed by the Cinema Rhapsody.

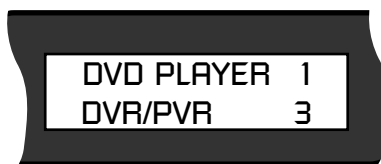
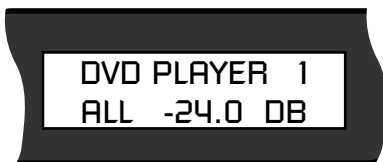

2. Engage New Input

Once the second line of the display indicates the next component you wish to access, press the Input Selector knob to engage this input. This method permits you to select an input without switching all of the inputs you are scrolling through.

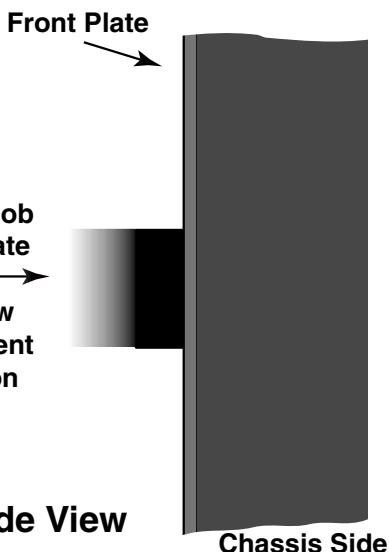

Once the desired component is displayed on the LCD's second row, press the Input Selector knob to engage that component. The display will then return to read the new selection (i.e. DSS) along with the Volume Level.

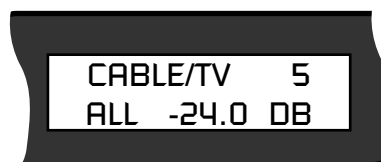

Record Selector

The Cinema Rhapsody Mach II incorporates a record selector that operates independently from the actual source component selected for the home theater room. This record selector can be used in several ways.

- 1 Use the Record Selector to send audio and video signals from a particular component to a recording device (i.e. VCR)
- 2 Use the Record Selector to send a video signals to a second monitor or TV set. Ideal for the sports fanatic, this option would permit a second TV to display a broadcast from a DSS receiver, TV tuner, or VCR TV tuner, while the primary viewing display would be set to a particular channel from another component.
- 3 Use the Record Selector to determine the image inserted into a TV's PIP (Picture In Picture). This would provide the same effect as described in option 2 (above) using the PIP function in place of a second TV or monitor.
- 4 Use the Record Selector to send the audio and video signal of a particular device to a whole-house multi-room audio video system. This setup would cause the Record Selector to act as a separate zone from the actual home theater.

Please note, that the Record audio output of the Cinema Rhapsody Mach II is a pure analog output. There is no analog-to-digital or digital-to-analog conversion taking place in this circuit. This preserves the audio quality for those who opt to use the Record output to pass audio to a premium two-channel audio system. If a component is connected to a digital input on the Cinema Rhapsody Mach II, a special setup will need to be done in order for the unit to play through the record output. This is discussed under Recording Connections.

Record Selector Functions

To determine what component the Record Selector is currently set to, press the Record Selector knob. The display will read as follows where the second line of the display indicates the component selected.



To select another source component, turn the Record Selector knob until the new component appears in the display.

Then press the Record Selector knob to engage this device.



Front View

The Record Selector operates independently from the main output providing the ability to record, view, or play (in another room) a component other than the one selected in the home theater.

To determine which device is currently selected, press the Record Selector knob. To change components:

- 1. Dial In New Device**
Turn the Record Selector knob until the second line of the LCD display reads the component you wish to select.
- 2. Engage New Device**
Once the second line of the display indicates the next component you wish to access, press the Record knob to engage this input.

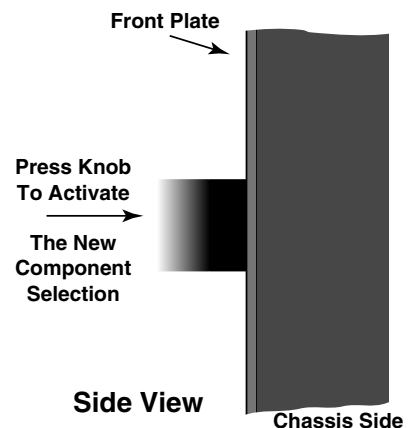

Rear Panel Connections

Composite Video Inputs (8)

S-Video Inputs (4)

Component Video Inputs (3)

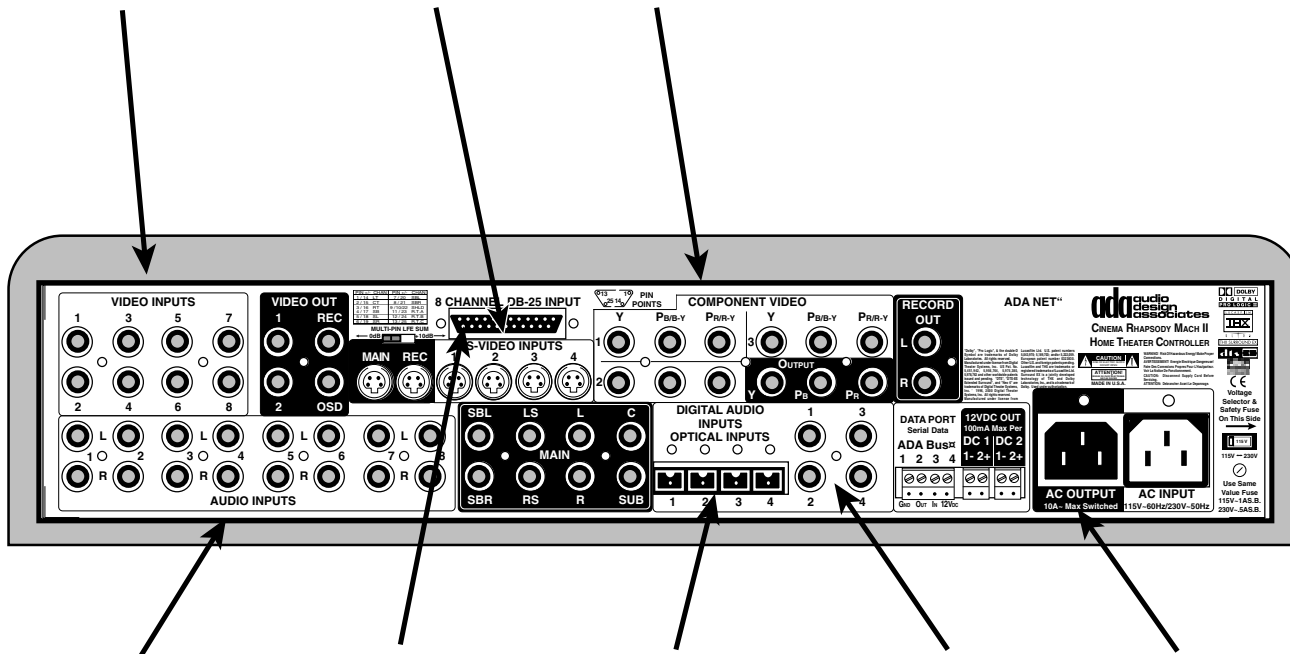

Analog Audio Inputs (8)

DVD Audio/SACD Input (1)

Digital Audio Optical TOS-Link Inputs (4)

Digital Audio Coaxial Inputs (4)

10 Amp Switched AC Outlet

Record Composite Video Output

Record S-Video Output

Component Video Output

Record Audio Output

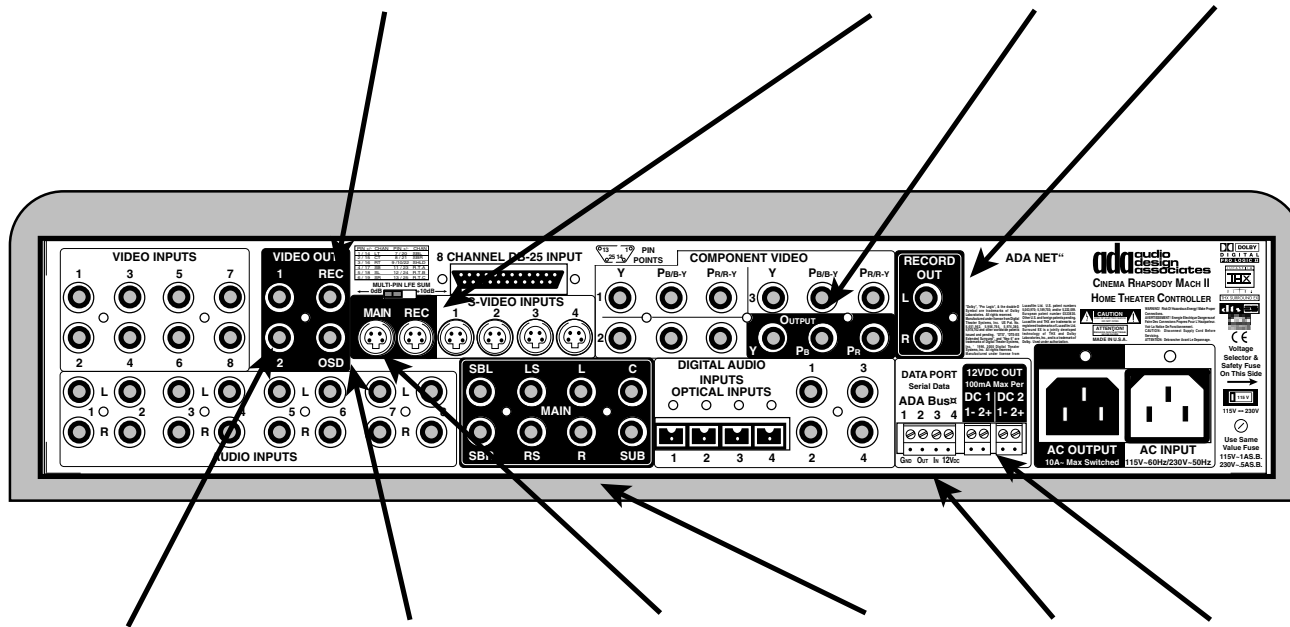

Main Composite Video Outputs (2)

Main Composite Video Output with On-Screen Display (1)

Main S-Video Output (1)

Main Eight Channel Audio Output (7.1)

ADA Bus Data Port

Low Voltage Triggers (2)

Out of the Box Input Configuration

The Cinema Rhapsody Mach II is an incredibly flexible home theater controller that can accommodate a wide array of components. For easy and quick setup, one can use the “Out of the Box” input configurations shown on the following pages. One can also elect to do a completely “Custom” input configuration or a combination of “Out of the Box” and “Custom” input configurations.

The “Out of the Box” input configuration is easy to follow and offers connection of as many as 15 components without adjustment of the Cinema Rhapsody's input configurations (providing that the sources have the appropriate outputs and that the TV has at least an S-Video input). Below is a chart showing the Cinema Rhapsody's 20 “input labels” and the assignment of the A/V jacks on the rear panel of the unit. While there are 20 available input labels, the Out of the Box setup utilizes only the first fifteen labels were the remaining five are record options.

INPUT #	INPUT LABEL	AUDIO INPUT	ALTERNATE AUDIO INPUT	COMPOSITE VIDEO INPUT	S-VIDEO INPUT	COMPONENT VIDEO INPUT
1	DVD PLAYER	DIGITAL 1	-	1	1	1
2	DSS	OPTICAL 2	DIGITAL 2	2	2	2
3	DVR/PVR	ANALOG 3	OPTICAL 3	3	3	-
4	VCR	ANALOG 4	-	4	4	-
5	CABLE/TV	ANALOG 5	OPTICAL 4	5	-	-
6	CD PLAYER	ANALOG 6	OPTICAL 1	-	-	-
7	TUNER	ANALOG 7	-	-	-	-
8	AUXILIARY	ANALOG 8	-	8	-	-
9	DVD AUDIO	MULTI-PIN	-	1	1	1
10	MULTI-ROOM	ANALOG 2	-	-	-	-
11	CAMCORDER	ANALOG 1	-	7	-	-
12	VIDEO GAME	DIGITAL 3	OPTICAL 1	6	-	3
13	COMPUTER	DIGITAL 4	OPTICAL 1	6	-	-
14	LASERDISC	OPTICAL 1	-	8	-	-
15	LASER AC3	DIGITAL 2	-	8	-	-
16	PHONOGRPH	ANALOG 1	-	-	-	-
17	DSS RECORD	ANALOG 2	-	2	2	2
18	DVR RECORD	ANALOG 3	-	3	3	-
19	TV RECORD	ANALOG 5	-	5	-	-
20	CD RECORD	ANALOG 6	-	-	-	-

Please note, that the Out of the Box input configuration is designed to maximize the home theater experience. Because only analog audio connections play through the record output, the components that are connected digitally (DVD, DSS) will not provide audio through the record output. This can be changed and is discussed in the Record Connection section of this manual.

“Custom” input configuration permits any input label to be renamed to best suit the actual system. For example, the input label DSS could be changed to read SATELLITE. Also, each input label can be assigned to any of the eight analog or eight digital audio inputs, as they do not have to be fixed to the A/V jacks that are assigned in the Out of the Box setup. The same is true for the composite video, S-Video and component video inputs. This flexibility permits you to maximize the Cinema Rhapsody Mach II's A/V jacks to accommodate a wide assortment of components. Lastly, the Cinema Rhapsody features an option called Final Input. Here, you can reduce the number of input labels that are displayed. For example, if you are only connecting six components to the Cinema Rhapsody Mach II, you could set the final input to CD PLAYER 6. After this adjustment, turning the input knob will only display the first six inputs. As such, combining the Final Input feature with the ability to rename input labels and reassign A/V jacks to any input label, one has the ability to completely customize a Cinema Rhapsody Mach II to perfectly match any system. And should a component be added at some later time, the final input can be opened back up to seven (or more) to accommodate connection of the new devices. To learn more about “Custom” input configuration of the Cinema Rhapsody Mach II, skip forward to this section. To proceed with the Out of the Box setup, follow the instructions on the following pages.

DVD Player Connection

The Out of the Box input configuration for a DVD player is set to use the digital coaxial audio output of the DVD player as most DVD players have this type of RCA jack.

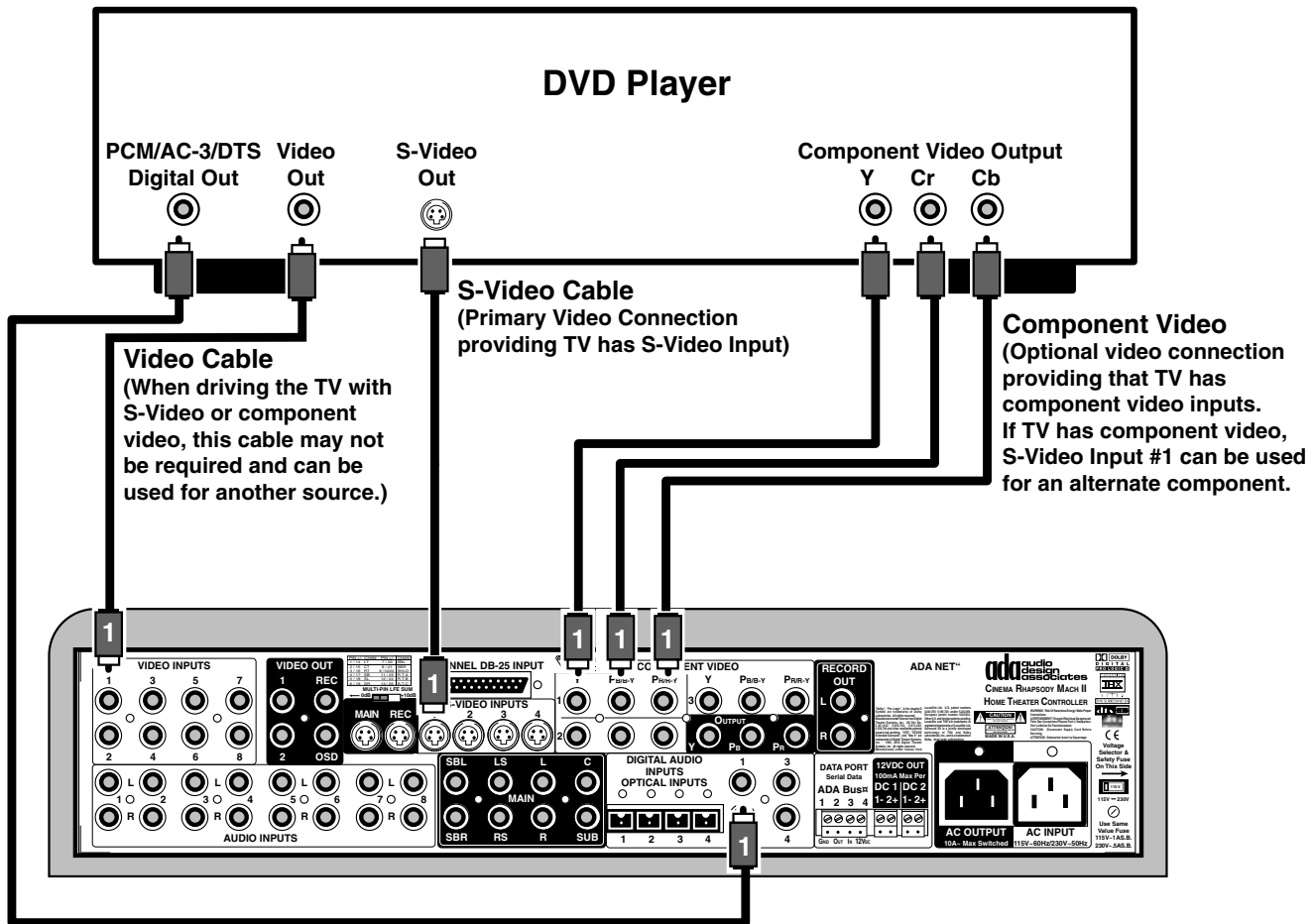

Digital Output
(This cable carries Dolby Digital (AC-3) and DTS 6 channel audio from DVDs and standard 2 channel digital audio from CDs.)

The above illustration shows composite video, S-Video, and component video connections. You may not require all of these connections and will need to determine this based on the input connections on your TV, projector, or line-doubling device.

Composite Video

ADA suggests connecting the composite video signal from the DVD player to the Cinema Rhapsody Mach II. Because the Cinema Rhapsody's front panel preview monitor only displays a composite video signal, it will be necessary to use this connection regardless if your display device is capable of showing S-Video or Component Video.

S-Video

S-Video offers superior image resolution than composite video. Most home theater displays, either TV or projector, offer an S-Video input.

Component Video

Component video is superior to S-Video. While most TVs do not feature a component video input, most projectors or line-doublers do. This connection is only useful if your TV or projector feature a component video input.

DVD Audio/SACD Player Connection

The Out of the Box input configuration also has provisions for a DVD Player that is capable of playing DVD Audio and/or SACD. These multi-channel high-resolution discs are designed to offer superior sound quality. Because of concerns regarding copy-protection, the decoding of the material actually takes place in the DVD player. For this reason, DVD Audio and SACD players feature six channel analog audio outputs which are labeled left, center, right, left surround, right surround and subwoofer.

The Cinema Rhapsody Mach II features a DB-25 multi-pin connection for the six channel high-resolution audio input. This standardized jack permits connection to a DVD or SACD player's using a multi-channel RCA (male) to DB-25 (male) interconnect cable. This cable is readily available by several cable manufacturers.

To listen to DVD Audio or SACD, select the DVD AUDIO 9 input label. To view normal DVDs, return to the DVD PLAYER 1 input label.

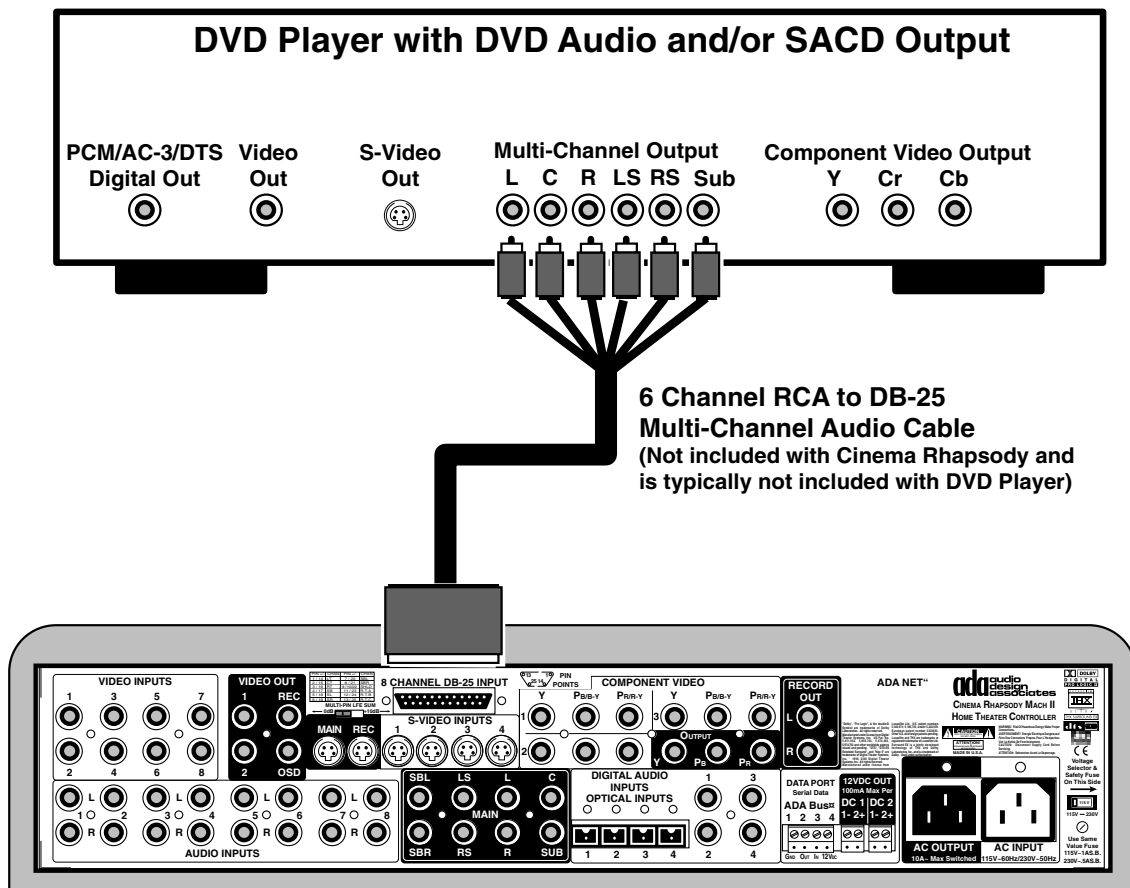

DSS Receiver Connection

The Out of the Box input configuration for a DSS receiver is set to use the optical digital audio output of the DSS receiver as most DSS receivers have this type of TOS-Link jack. In the event your DSS receiver features a digital audio coaxial jack, you may wish to use this connection instead of the optical connection. Coaxial connections are better than optical connections, especially when basic optical interconnects are all that are available.

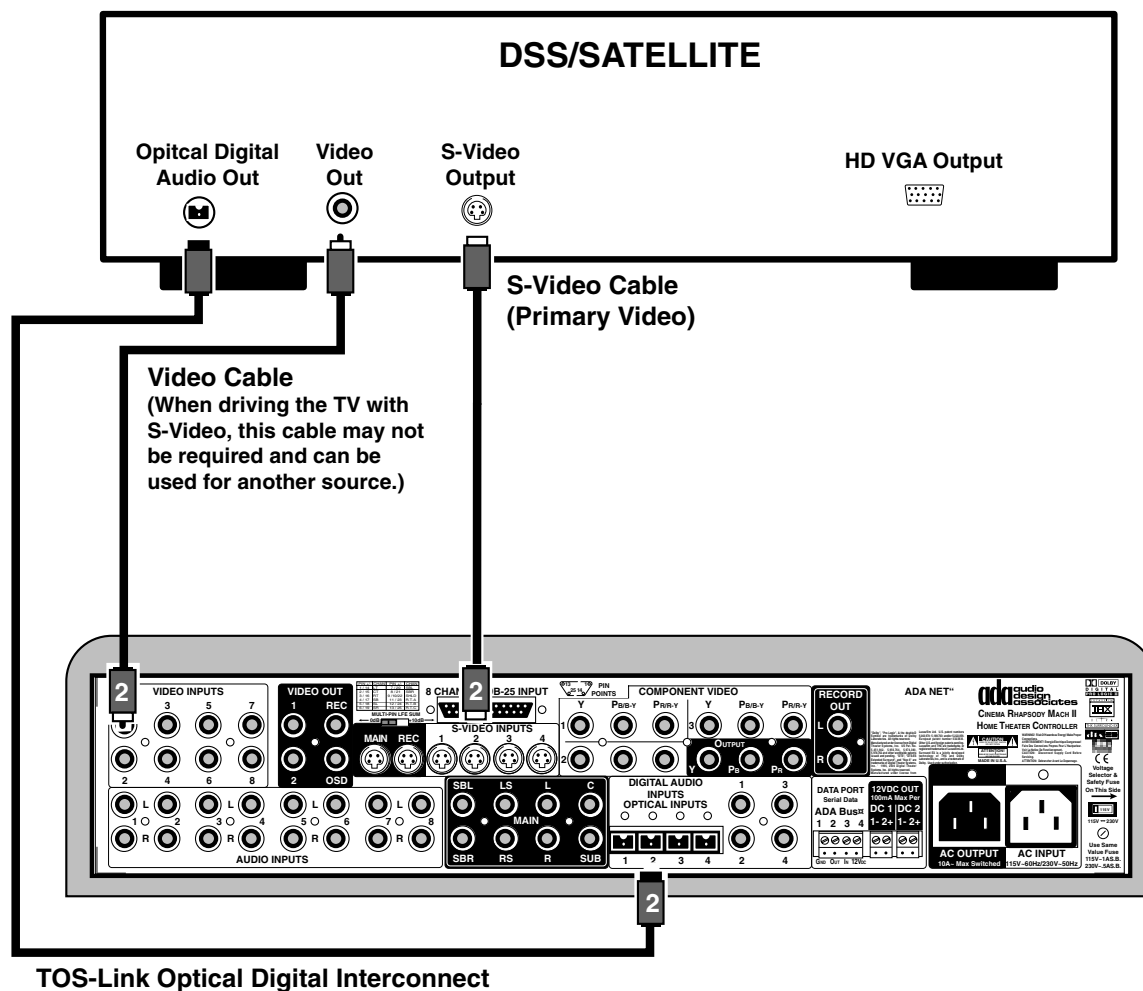

TOS-Link Optical Interconnects & Audio Dropouts

The issue regarding TOS-Link optical interconnects stems from the manner in which they are manufactured. The most basic TOS-Link cables have the fiber optic line cut with a hot wire. Cutting the fiber optic line in this manner forms a smooth reflective surface. It is this reflective surface which causes digital data, in the form of light, to reflect off of the optical receiver, and in essence, back feed into the TOS-Link interconnect. As such, the flow of light (the flow of digital data) is then interrupted. This will cause audio dropouts during playback.

When selecting a TOS-Link interconnect, ADA strongly suggests using the very best cable available. Typically, these cables offer some type of frosted tip which greatly reduces the reflective interference. The very best TOS-Link interconnects provide convex tips which eliminate reflective interference.

If your DSS receiver features a digital coaxial audio output and you wish to use this type of interconnect, follow the instructions as outlined on the next page.

DSS Receiver Connection - Coaxial Connection

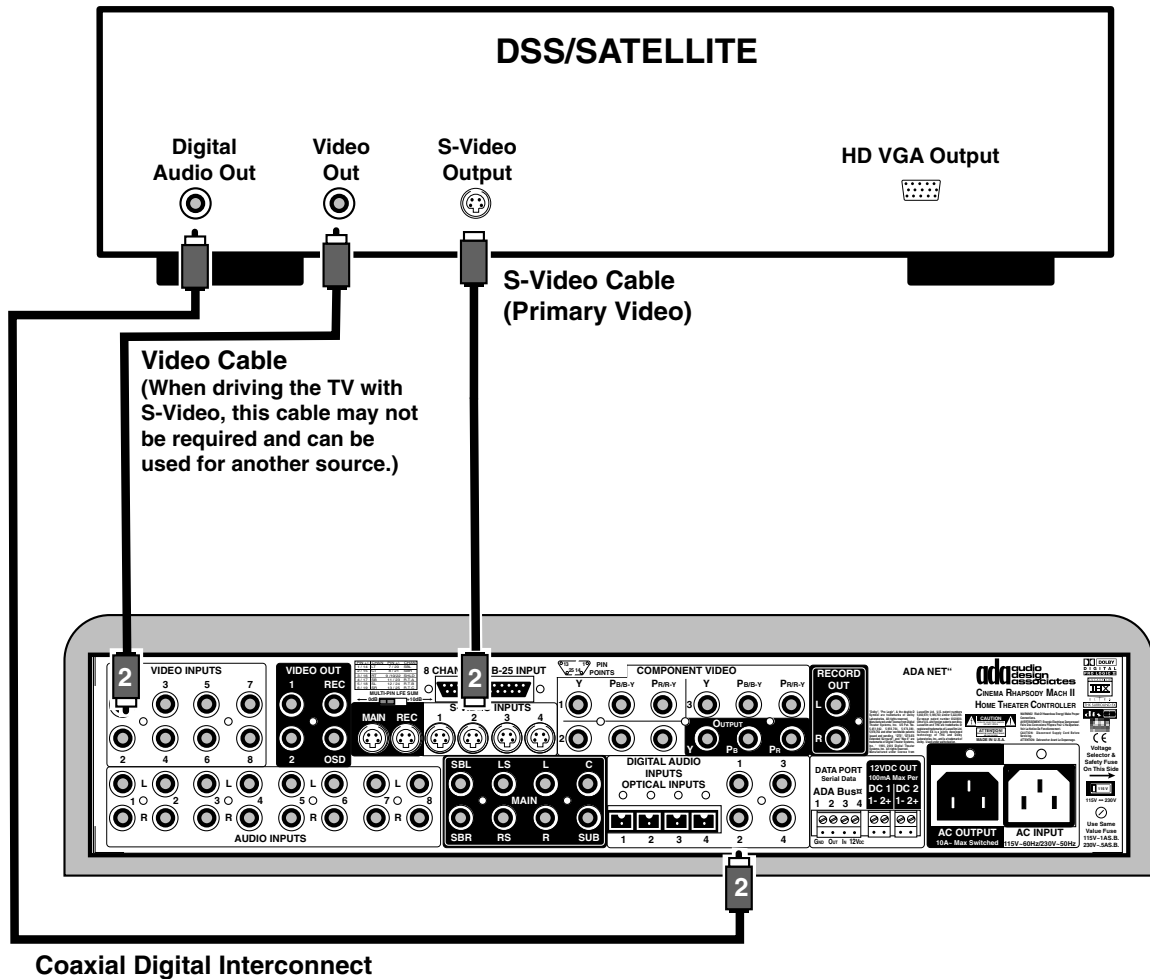

In the event that the DSS receiver features a coaxial digital audio output which you intend to use instead of the TOS-Link output, you will need to connect a 75Ω interconnect to Digital Input #2. When doing this, you will also need to change the audio jack assigned to the DSS input label. To do this:

- 1 Turn the input knob until display's second line reads DSS 2 and then press the Input knob.
- 2 Turn the Mode knob clockwise until the display's second line reads SETUP MENU and press the Mode knob.
- 3 Turn the Mode knob clockwise until the display's second line reads AUDIO INPUTS and press the Mode knob.
- 4 Turn the Mode knob clockwise until the display's second line reads DIGITAL 2.

At this time, you have reassigned the DSS 2 input label from tracking the Optical 2 input to the Digital 2 input.

Please note that regardless of which wiring option you choose to use when connecting a DSS receiver to the Cinema Rhapsody Mach II, you may still need to make adjustments to the DSS receiver. As many DSS receivers have multiple audio output setup configurations, ADA strongly suggests reviewing the DSS manual to insure proper setup.

DVR/PVR Connection

The Out of the Box input configuration for a DVR (Digital Video Recorder) are sometimes called PVRs (Personal Video Recorders). There are several different models available and the diagram below shows connection of the most basic type of models. These units feature analog audio outputs along with both composite video and S-Video outputs.

If your DVR features a digital audio output TOS-Link (as found on the Replay 4000), you may opt to connect this output to Optical 3 on the Cinema Rhapsody. When doing so, you will need to reassign the DVR/PVR Input label to track Optical input #3. To do this:

- 1 Turn the input knob until display's second line reads DVR/PVR and then press the Input knob.
- 2 Turn the Mode knob clockwise until the display's second line reads SETUP MENU and press the Mode knob.
- 3 Turn the Mode knob clockwise until the display's second line reads AUDIO INPUTS and press the Mode knob.
- 4 Turn the Mode knob clockwise until the display's second line reads OPTICAL 3.

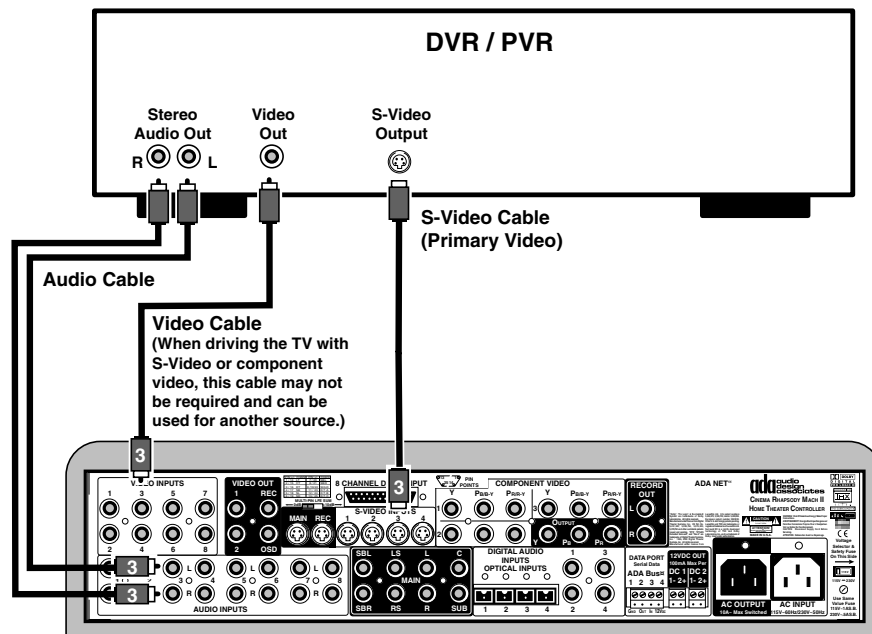

DVRs are designed to record material that is being broadcast and may require an output from a broadcast tuner to permit this recording function. Some units feature an internal tuning device of their own. As such, you may be able to record into the DVR while you watch something else. To maximize the connectivity of your DVR and the Cinema Rhapsody Mach II, you will need to consult with the DVR's instruction manual regarding connecting other devices to the DVR. Please note, that you may wish to connect some components to both the DVR and the Cinema Rhapsody.

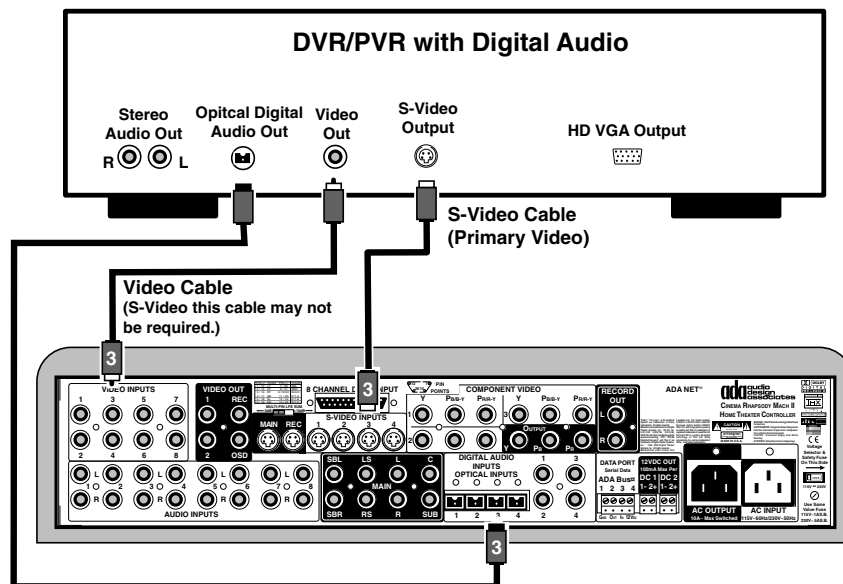

VCR Connection

The Out of the Box input configuration for a VCR permits for both composite and S-Video as well as right and left analog audio. Use inputs number 4.

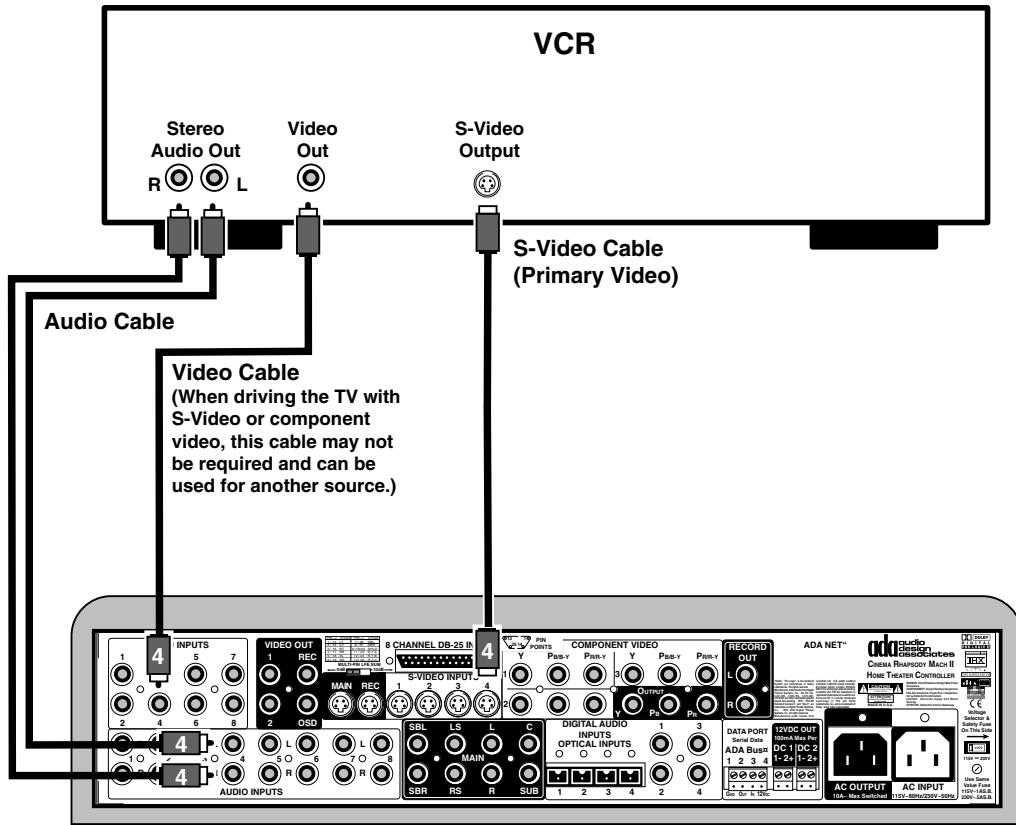

Cable or TV Tuner Connection

The Out of the Box input configuration for a Cable TV box or TV tuner permits for both composite and right and left analog audio. Use inputs number 5. For advanced tuners, see the next page.

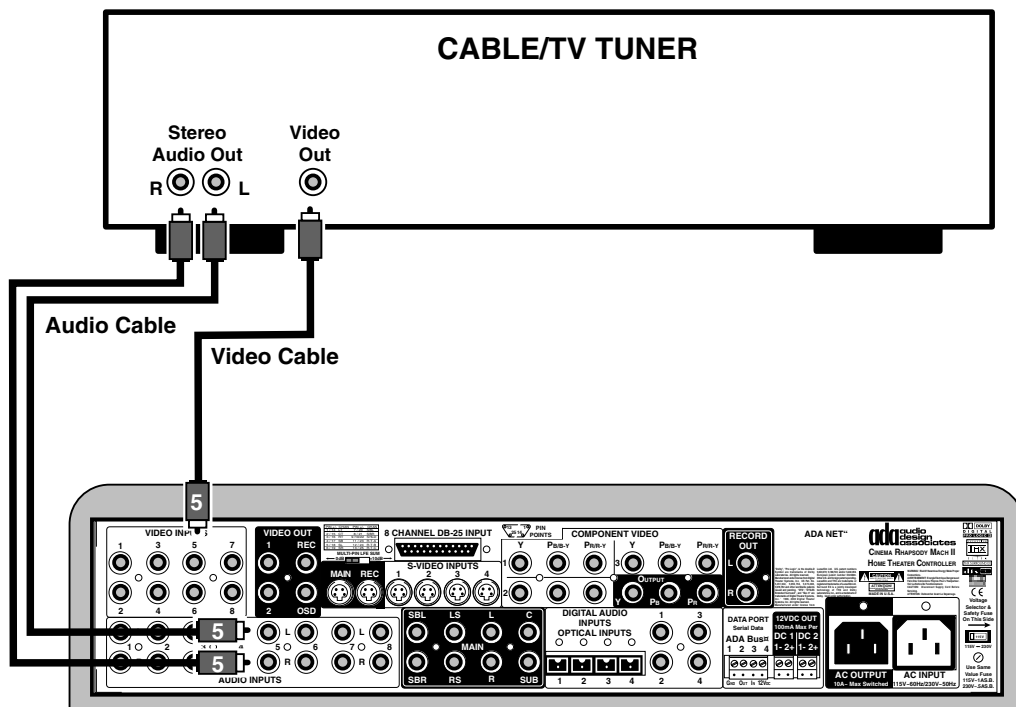

CD Player Connection

The Out of the Box input configuration for CD Player provides for analog audio connections. Connect your line-level audio outputs from your CD player to the Cinema Rhapsody Mach II's Analog Audio input #6.

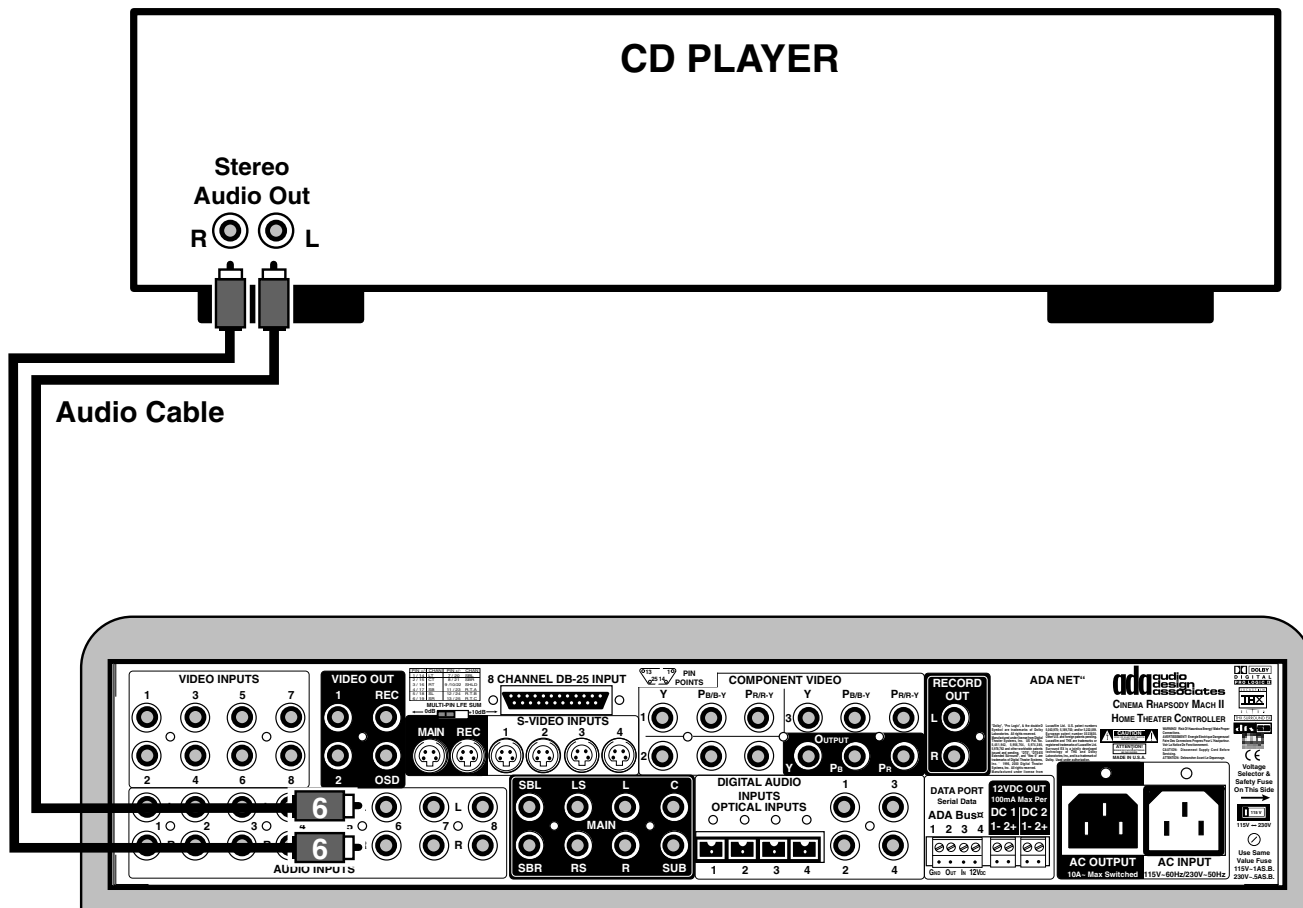

If you are using a CD Player with either TOS-Link Optical or Coaxial digital audio outputs, you can connect this component to the Cinema Rhapsody Mach II for digital audio playback. When connecting a CD Player to an analog input, the audio signal is first converted to analog internal to the CD player and then the signal is converted back to digital internal to the Cinema Rhapsody Mach II. As such, it is best to bypass this down/up conversion by connecting the CD player directly to a digital input on the Cinema Rhapsody.

To maintain the most flexible Out of the Box setup, ADA suggests using a TOS-Link connection from the CD Player to the Cinema Rhapsody. In the event, that your CD Player does not feature, a TOS-Link Output, you can opt to use one of the four Digital Coaxial inputs on the Cinema Rhapsody, providing these inputs are not already assigned to other source input labels. You will need to assess the other connections you have already made, as well as those you will make in the upcoming pages, to determine which Digital Coaxial input is open. If you have connected a DSS receiver to the Cinema Rhapsody using a TOS-Link interconnect, then Digital Coaxial Input #2 is available for use with the CD Player.

CD Player Digital Connections

CD Player Digital Audio TOS-Link Connection

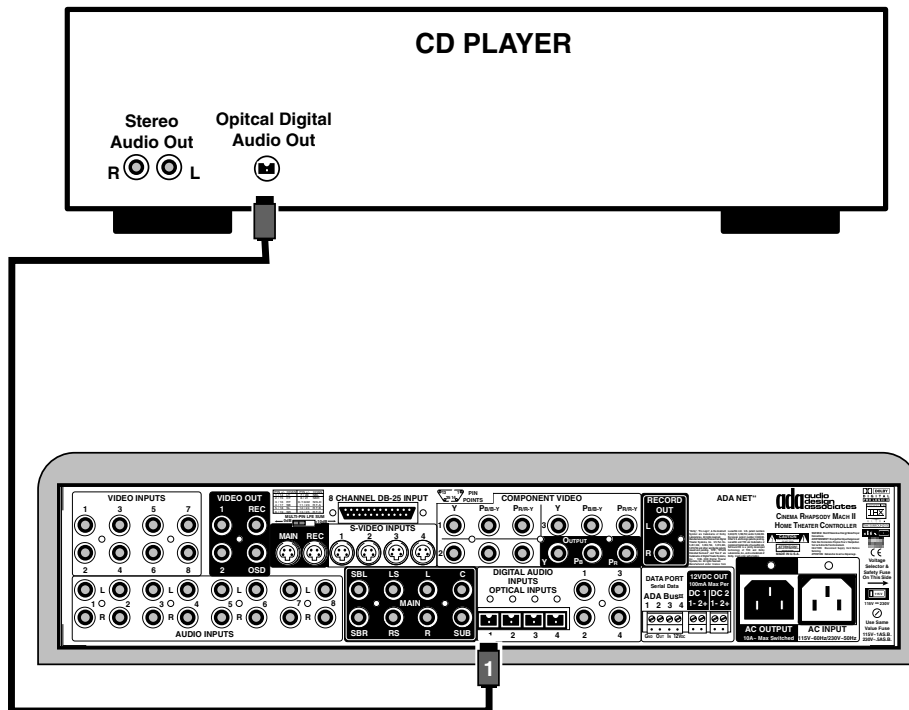

For TOS-Link connections use Optical Input #1. For Coaxial connections, use Digital Input #2 if it is not already assigned to the DSS. You will also need to reassign the CD PLAYER 7 input label from Analog Input #6 to the appropriate digital input. To do so, follow these steps.

- 1 Turn the input knob until display's second line reads CD PLAYER 7 and then press the Input knob.
- 2 Turn the Mode knob clockwise until the display's second line reads SETUP MENU and press the Mode knob.
- 3 Turn the Mode knob clockwise until the display's second line reads AUDIO INPUTS and press the Mode knob.
- 4 Turn the Mode knob counterclockwise until the display's second line reads OPTICAL 1 (or DIGITAL 2).

CD Player Digital Audio Coaxial Connection

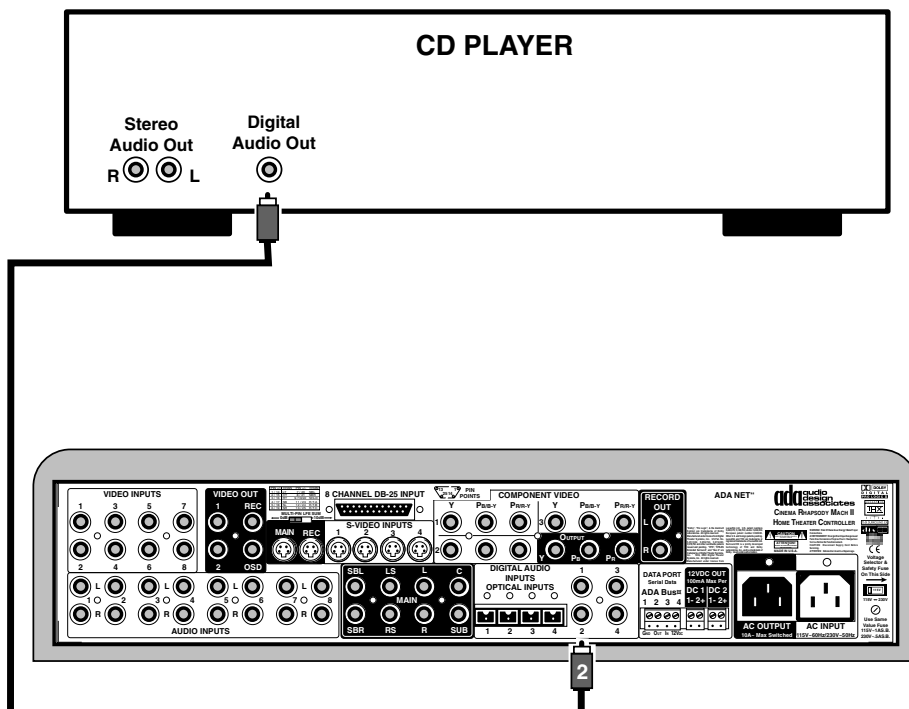

At this time, you have reassigned the CD PLAYER 7 input label from tracking the Analog 6 input to the Optical 1 (or Digital 2) input.

Please note that when using a TOS-Link interconnect, ADA strongly suggests using the very best interconnect available to prevent audio dropouts.

Tuner (Radio) Connection

The Out of the Box input configuration for a Radio Tuner provides for analog audio connections. Connect your line-level audio outputs from your Tuner to the Cinema Rhapsody Mach II's Analog Audio input #7.

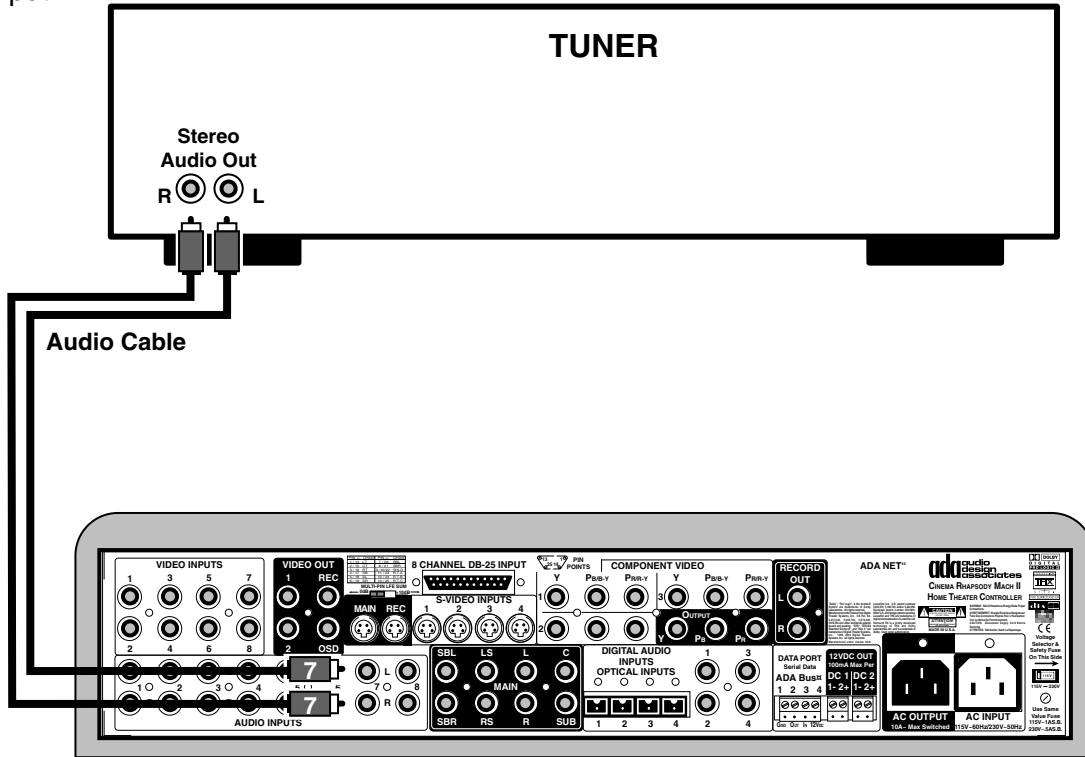

Auxiliary Component Connection

The Out of the Box input configuration for an extra A/V component provides for analog audio and composite video connections on inputs #8. If you use this input label and wish to rename it, you can do so by following the instructions found under Input Labels.

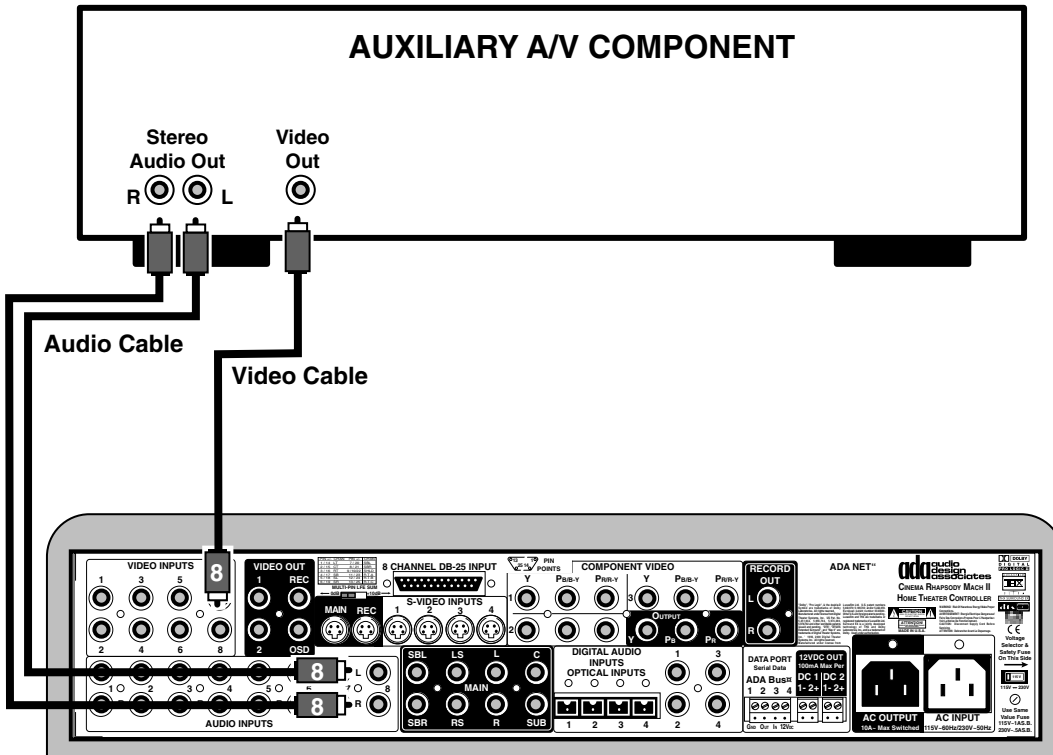

Multi-Room System Connection

The Out of the Box input configuration for a Multi-Room System provides for analog audio connections. Connect your line-level audio outputs from your Multi-Room System to the Cinema Rhapsody Mach II's Analog Audio input #2.

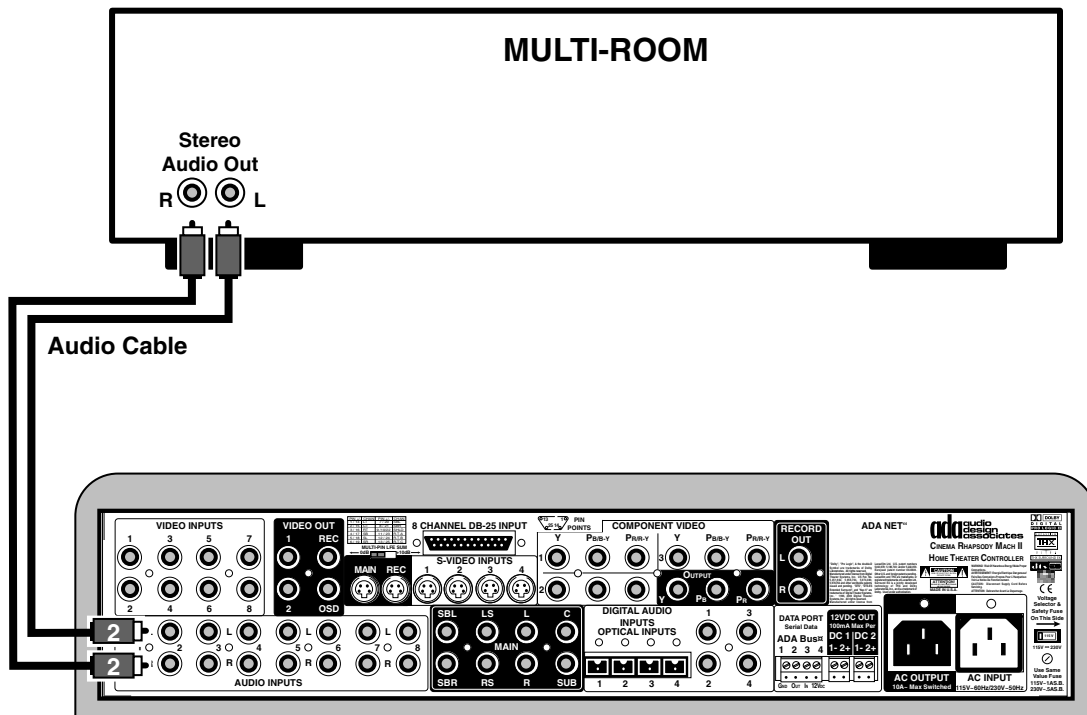

Camcorder Connection

The Out of the Box input configuration for a Camcorder provides for analog audio and composite video connections on analog audio input #1 and composite video input #7.

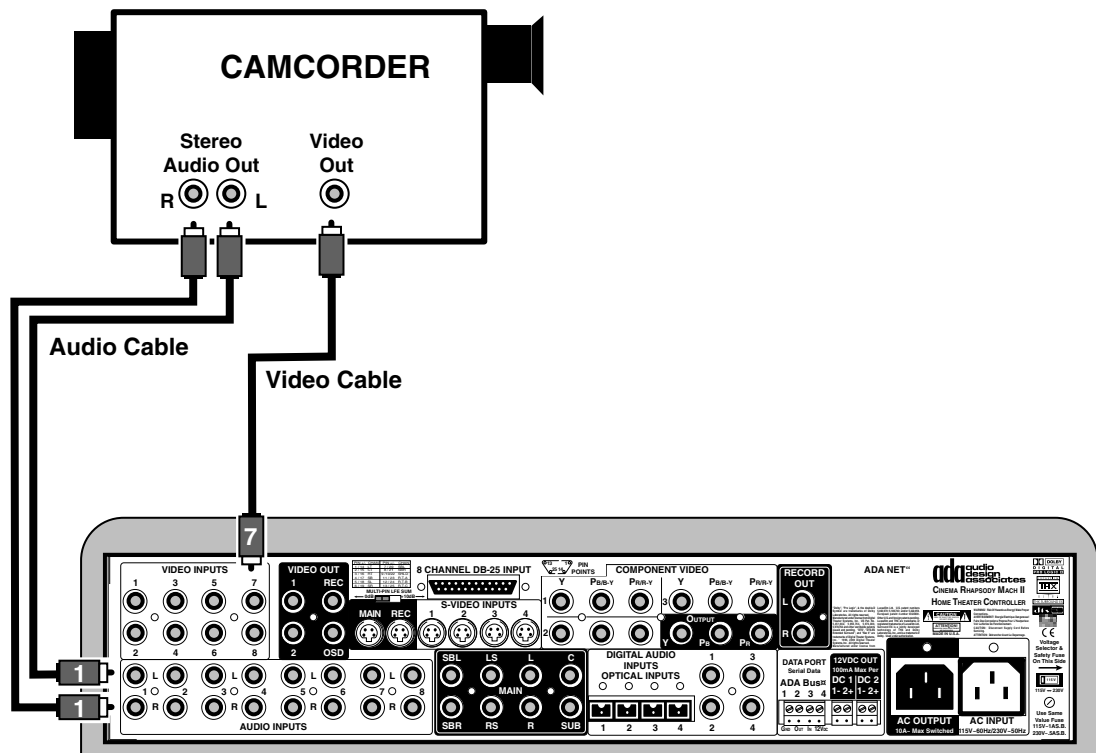

Video Game Connection

The Out of the Box input configuration for a Video Game provides for digital audio as well as composite and component video connections. Connect your Digital audio output to Digital input #3. For video connect your Composite video output to input #6. If your display device is capable of showing a component video signal, connect the video games component video output to input #3. Please note, if your video game does not have a component video output, you can still display it using the composite video connection.

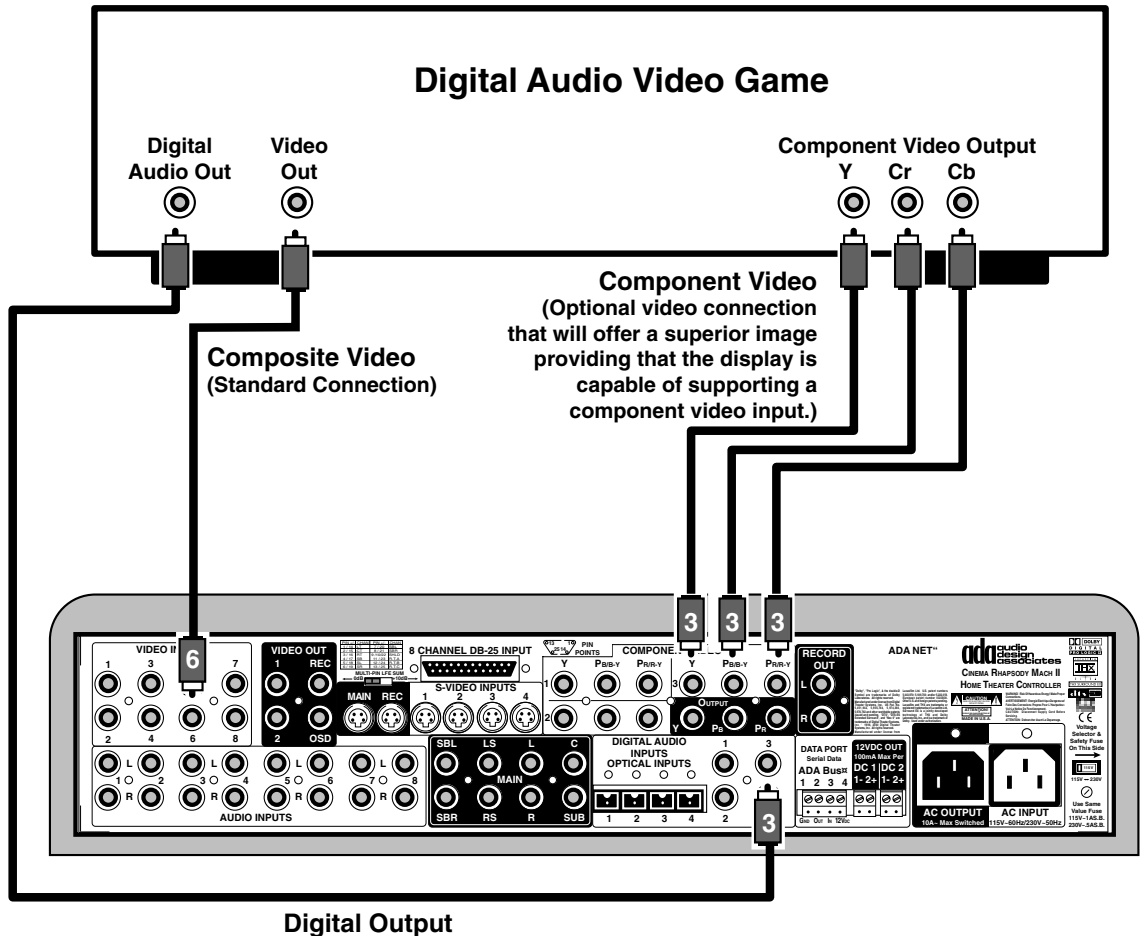

If you are connecting an older video game which only features analog audio outputs, you will need to reassign the VIDEO GAME input label to track an open analog audio jack. As the Cinema Rhapsody Mach II's Out of the Box setup uses all available analog inputs, an open input may be available depending on the number of devices you have connected to the unit. For example, if you changed your CD Player connection to a digital input, then Analog input #6 is available for connection of the video game.

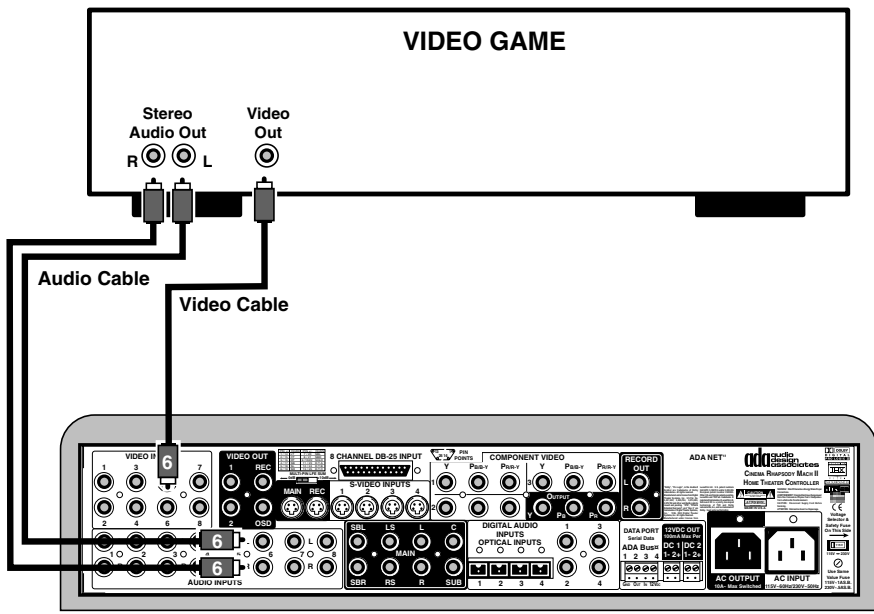

Computer Connection

The Out of the Box input configuration for a Computer provides for digital coaxial audio as well as a composite video connection. Connect your Digital audio output to Digital input #4. Connect the video output of your PC to the Cinema Rhapsody Mach II's Video input #1 (providing that your video game is not already connected to this video input).

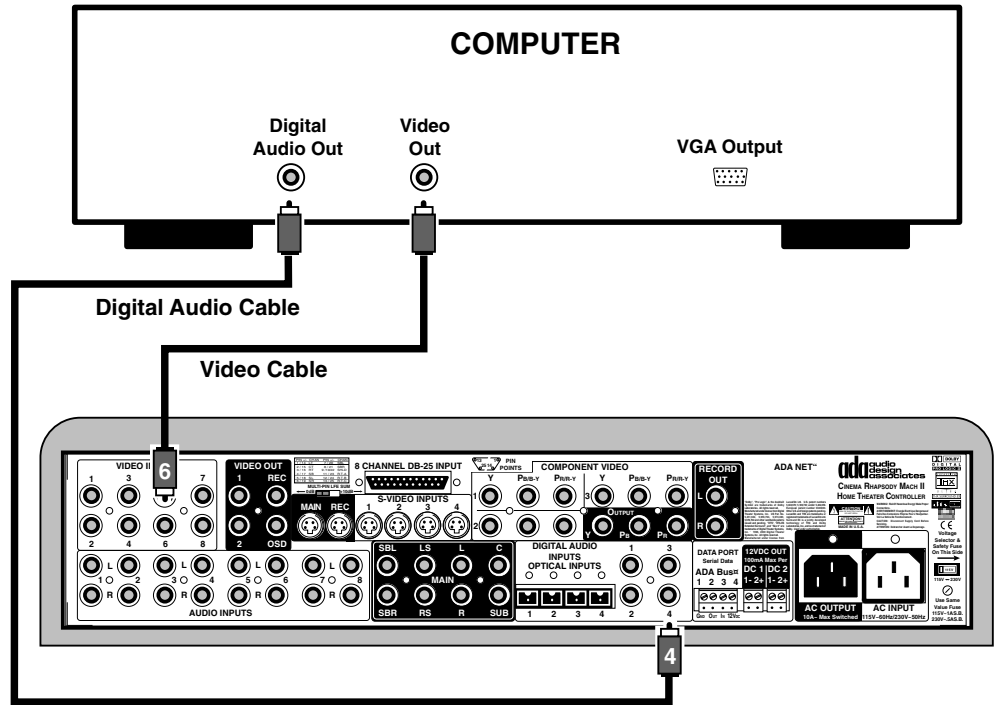

Phonograph Connection

The Out of the Box input configuration for a phonograph (record player) is on Analog Input 1, providing this input has not been already used for the connection of a Camcorder. Alternately, you may opt to use Analog 2 (Multi-Room System) or any other open analog input. Please note, that this would require you to change the audio input assignment for the PHONOGRPH Input label. ADA has purposely included a phonograph connection in the Out of the Box setup, because we believe you will be amazed from the sound you experience when playing your vinyl in either Quad Bypass mode, Pro Logic II Music mode, or a Pro Logic II Custom mode.

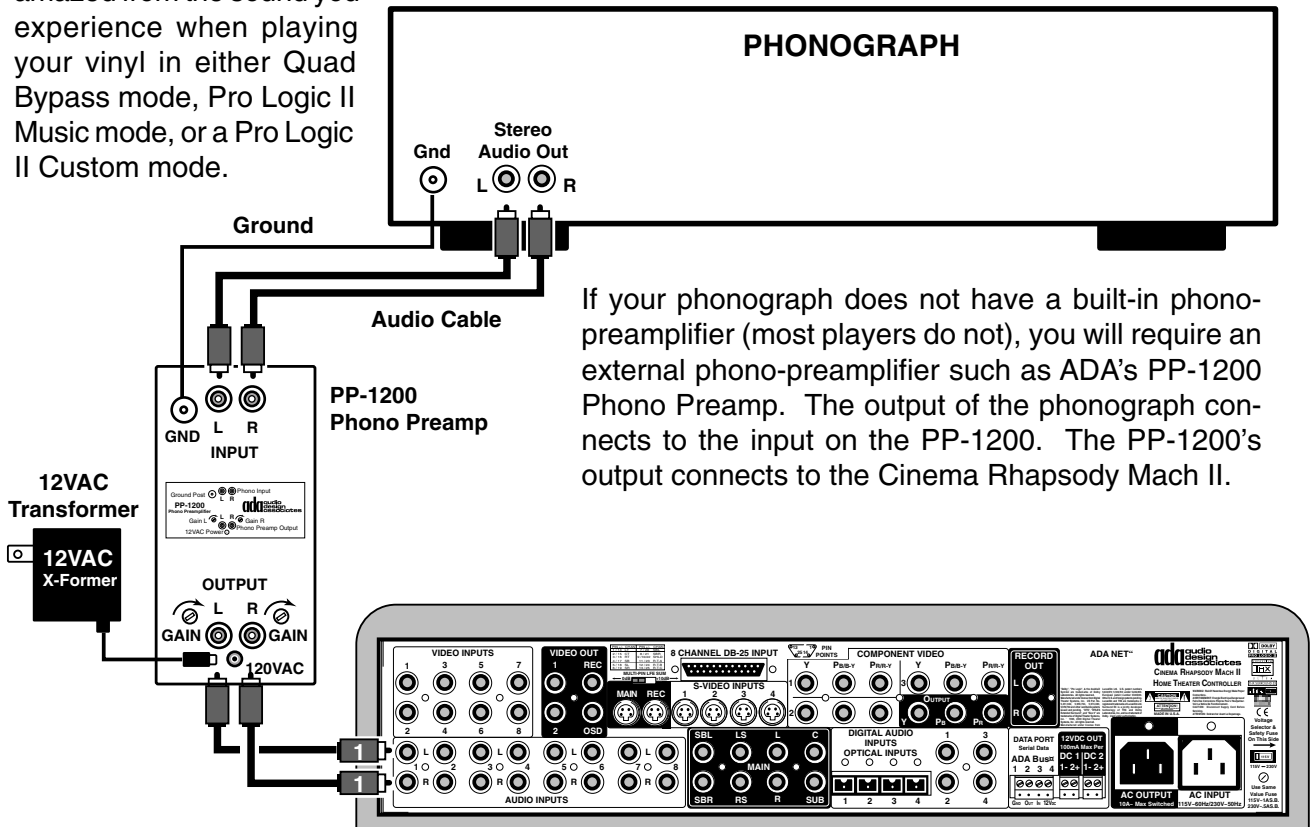

If your phonograph does not have a built-in phono-preamplifier (most players do not), you will require an external phono-preamplifier such as ADA's PP-1200 Phono Preamp. The output of the phonograph connects to the input on the PP-1200. The PP-1200's output connects to the Cinema Rhapsody Mach II.

Laserdisc Player with Internal RF Demodulator

The Out of the Box input configuration for a Laserdisc player has several different options depending on the type of laser disc player you are using. The most current laser disc players feature an internal AC-3 RF demodulator which is necessary to play Dolby Digital laser discs in a Dolby Digital mode. As such, these players permit a single digital audio connection for playback of two-channel (PCM digital audio), Dolby Digital, and even DTS laser discs (DTS discs are encoded in PCM digital audio and do not require an RF demodulator). If your laserdisc player features an AC-3 RF Output, use the instructions on the following page.

For laserdisc players that feature a combined digital audio output (PCM audio, DTS audio, and Dolby Digital), connect either a TOS-Link Optical or coaxial digital audio to the Cinema Rhapsody Mach II. The Out of the Box setup for the LASERDISC input label has the audio input assigned to the Optical 1 jack on the Cinema Rhapsody Mach II. The video jack assigned to this input label is Composite Video 8. S-Video input 4 is also assigned to this Input Label and can be connected to the laser disc player providing the VCR is not already connected in place.

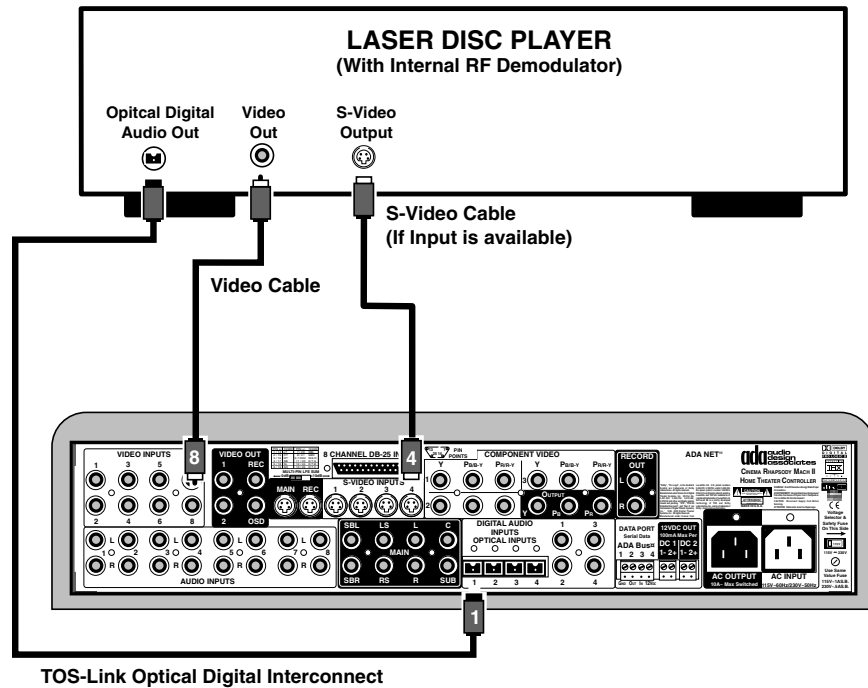

In the event the TOS-Link optical jack is already occupied or if your laserdisc player does not have an optical TOS-Link audio output, you may use the Digital 2 coaxial audio input (assuming it has not been assigned to the DSS receiver).

- 1 Turn the input knob until display's second line reads LASERDISC and then press the Input knob.
- 2 Turn the Mode knob clockwise until the display's second line reads SETUP MENU and press the Mode knob.
- 3 Turn the Mode knob clockwise until the display's second line reads AUDIO INPUTS and press the Mode knob.
- 4 Turn the Mode knob counterclockwise until the display's second line reads DIGITAL 2.

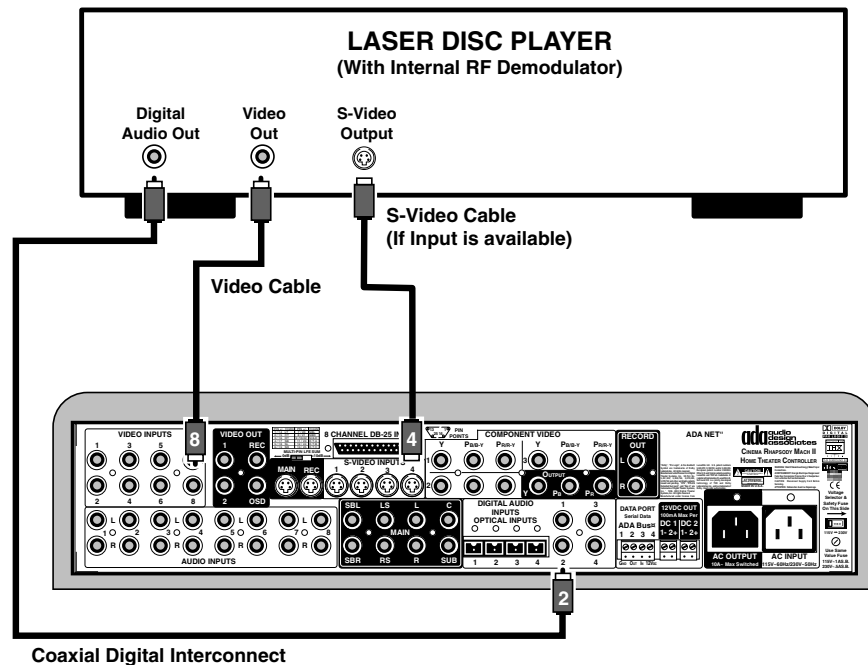

Laserdisc Player with only an AC-3 RF Output

The Cinema Rhapsody Mach II features an input label for connection to an AC-3 RF demodulator, needed for laserdisc players that have a Dolby Digital AC-3 RF output. Some players manufactured after 1994 feature this output while others may have been modified with an additional AC-3 RF Output (MSB Technologies provided this modification). These players require an external AC-3 RF demodulator (ADA's RFD-1) for playback of Dolby Digital (a.k.a. AC-3) laserdiscs using Dolby Digital decoding. Here, the laserdisc's AC-3 RF output is passed into the RFD-1 and then to an open digital coaxial input on the Cinema Rhapsody Mach II. You need to use one of the four digital coax inputs for connection to the RFD-1.

The Out of the Box configuration for the LASER AC3 input label is the Digital 2 coaxial jack. Please note, you will also need to make the secondary optical TOS-Link digital audio connection (for non-AC3 laserdiscs) and video connections to the Cinema Rhapsody Mach II. As such, when playing regular stereo or DTS laserdiscs, you will need to select the LASERDISC input label. When playing Dolby Digital (AC-3) laserdiscs, you will need to select the LASER AC3 input label.

Laserdisc History

As a point of information, the laserdisc, introduced in the late 1970's, today contains four audio channels. Two channels contain PCM digital audio for playback of standard laserdiscs (CDs also contain two channels of PCM digital audio). The other two channels on a laserdisc date back to the late 1970's, prior to the implementation of PCM digital audio (1983). Here, an audio signal is modulated onto a mono FM radio frequency. There is a mono FM channel for left and another for right. Those who viewed laser discs prior to the mid-1980's, listened to the analog channels as the digital channels did not yet exist.

In 1994, when Dolby Laboratories introduced AC-3 (now called Dolby Digital) for the home theater market, they decided that it would be best to include the AC-3 multi-channel digital bit stream on every laserdisc pressed (rather than release a special-order laserdisc). Because all players since the mid-80's read the digital PCM channels (rendering the mono-FM channels obsolete), Dolby decided to use one of these two antiquated mono-FM channels to embed (or modulate) the AC-3 bit stream. Thus, in order to decode the AC-3 bit stream from a laserdisc, one must first demodulate the mono-FM channel to extract the bit stream. In essence, the RFD-1 is a radio-frequency tuner (demodulator), hence the terminology-RFD. As the mono-FM signal passes through the RFD-1, the AC-3 bit stream is demodulated, emerging from the RFD-1 as a Dolby Digital signal, the exact same output as that of a DVD player.

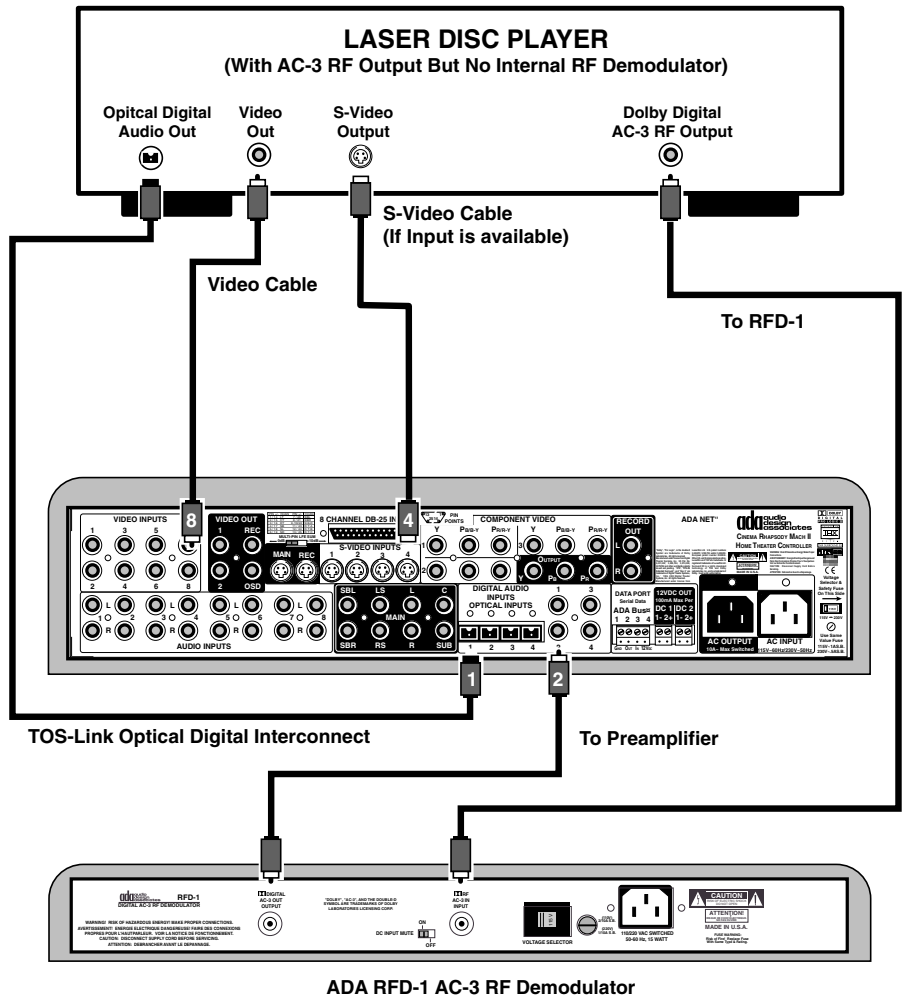

Theater (Main) Video Connections

To connect the Cinema Rhapsody Mach II to your video display or line-doubler, first determine what connections your device has. Generally speaking, this section will discuss the following three options: an HD capable TV or projector, a line-doubler, or a TV or projector with only composite and S-Video inputs.

HD Capable TV or Projector

With this type of display device, you will most likely have a host of video inputs. You will need to connect both composite and S-Video cables to the TV/projector. The only additional connection that is required is the component video connection.

The only additional connection that can be made is the composite video output of the Cinema Rhapsody Mach II marked OSD. This output provides On Screen Display which may be useful during setup.

As such, in this installation, when the display device is set to the composite video input, you will be able to utilize the Cinema Rhapsody's on-screen readout during setup. Then for normal operation, select either the, S-Video or composite video inputs. For component video sources, such as DVD players or video games, set the TV/projector to the component video input.

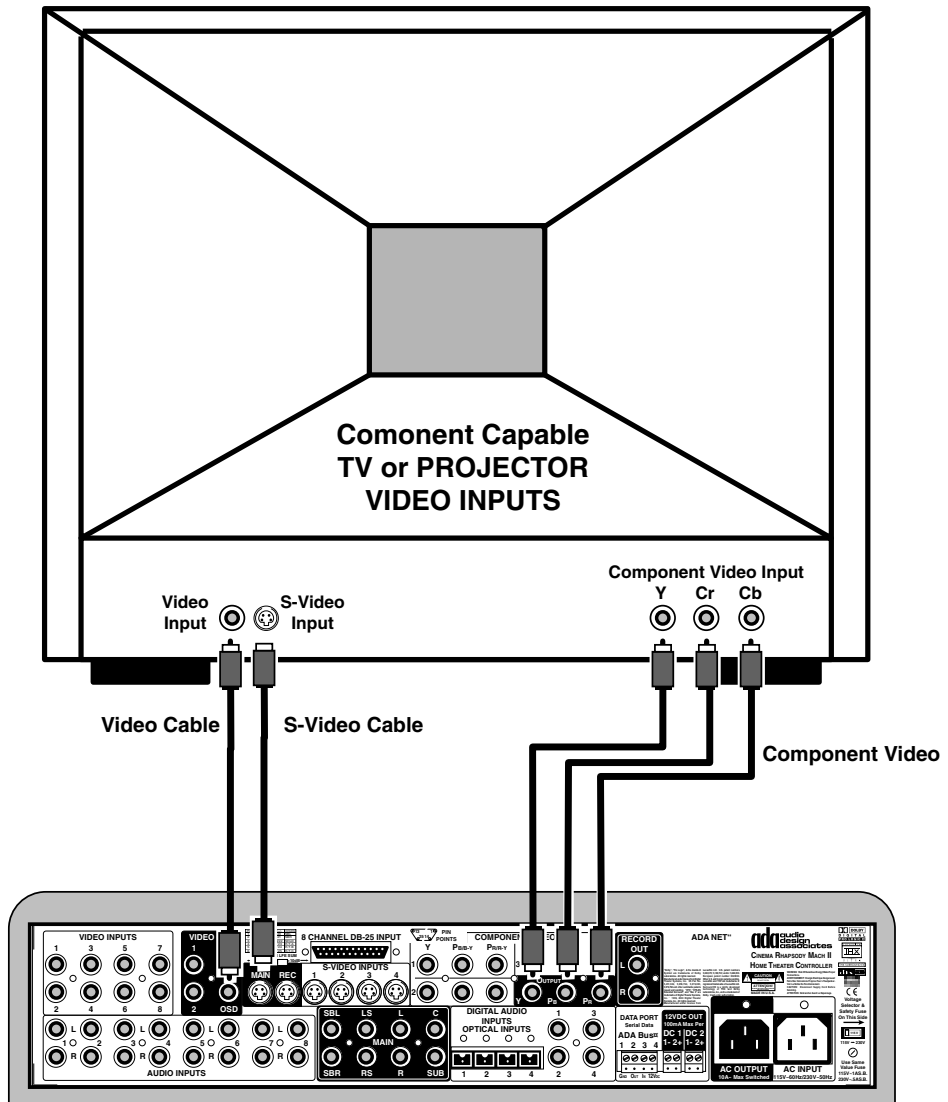

Line-Doublers

While you cannot see anything on a line-doubler, they are used to both up-convert, scale, and double (or even quadruple) the incoming source signals. In high-end home theater installations, use of this type of device between the Cinema Rhapsody Mach II and the TV or projector is quite common. Please note, that as you switch between inputs on the Cinema Rhapsody, you may also need to switch between inputs on your line-doubler.

LINE DOUBLER VIDEO INPUTS

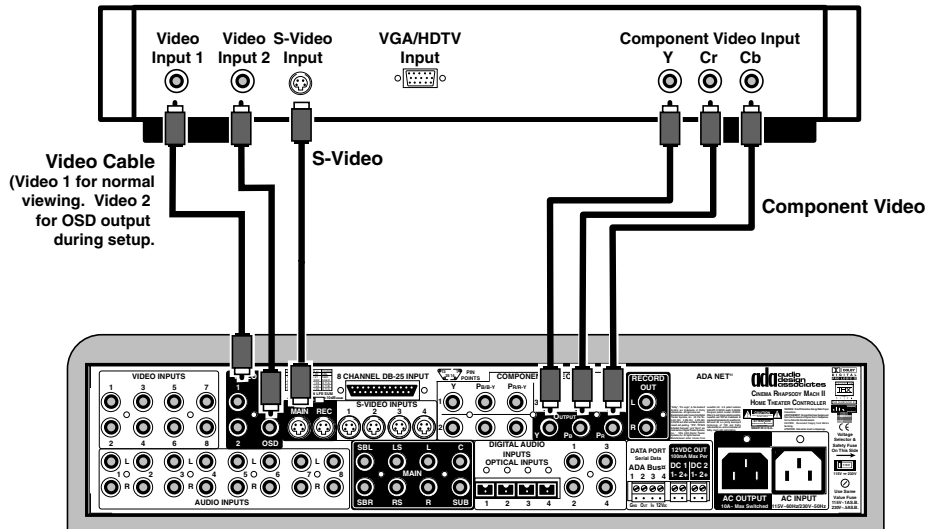

you will see the OSD useful during setup. For viewing composite video sources (cable TV), you would switch the line-doubler to video input #1, the same composite video signal without the OSD. In the event your line-doubler does not have two composite video inputs, you can connect the OSD output during setup and then replace it with the non-OSD composite video signal.

Basic (Non-HDTV) TVs and Projectors

When using a more basic TV or projector, you will need to closely examine the type of video inputs available. For discussion purposes, the diagram does show a component video input however, this connection will not exist on most TV's capable of both composite and S-Video. Remember that for this level of display device, there is no up or down conversion available. As such, if your TV only features composite and S-Video inputs, any sources that are solely connected to the Cinema Rhapsody Mach II with component video, will not play to the TV. Naturally, if the TV also features the component video

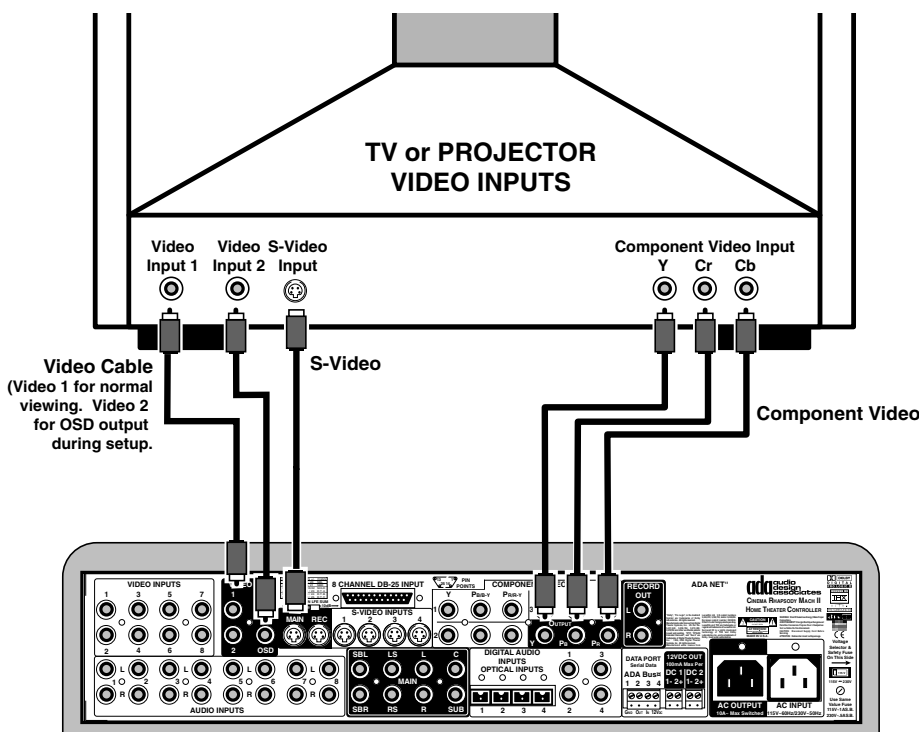

Because the line-doubler is handling all the video processing, you will need to run separate feeds to the line-doubler for composite video, S-Video, and component video. If your line-doubler has two composite video inputs, you can connect the Cinema Rhapsody Mach II's Main 1 video output to the line-doubler's video input #1, while the Cinema Rhapsody's OSD composite video output is connected to the line-doubler's video input #2. When on video input #2,

it will display sources connected to the Cinema Rhapsody via component video. As with other display devices mentioned, you will need to switch the TV to the correct input based on what is selected on the Cinema Rhapsody.

Again, there are two composite video connections that can be made to a more basic TV. One provides the OSD (On-Screen Display) output of the Cinema Rhapsody Mach II, useful for setup. The other composite video signal does not overlay the OSD output and may be more ideal for normal viewing of composite video sources.

Recording Output

The Cinema Rhapsody Mach II features a recording output which permits selection of a stereo (analog) audio signal, as well as composite and S-Video, independent of the output playing in the theater environment. This is useful for either sending a signal to a recording device, a high-end two channel audio system, a second monitor, a second zone, or perhaps even a multi-room system. There are some rules that must be considered when working with the Cinema Rhapsody Mach II's record output. Connect the component you wish to record to as shown.

Record Audio Output Only Passes Analog Audio Inputs

The record audio output only passes analog audio. Regardless of the number of digital sources connected to your system, only the eight analog audio inputs are available through the record output. The record output is designed to satisfy purists who want to be able to select an audio source without any analog/digital conversion. As such, digital sources are not down-converted to analog.

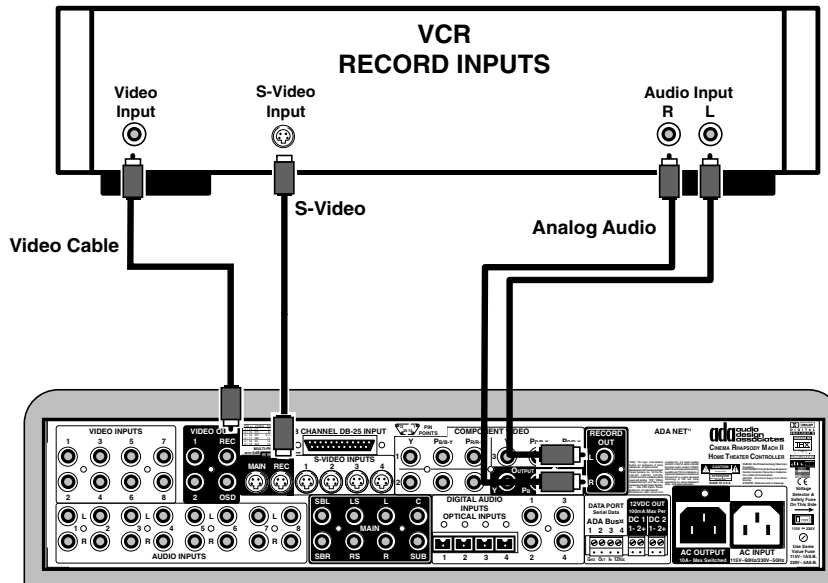

Record Video Output Only Passes Composite or S-Video

Composite video and S-Video are also not converted to each other. As such, only a composite video input is passed through the composite video output. Also, S-Video inputs are only passed through S-Video outputs.

Record Audio Outputs Do Not Pass Digital Audio Inputs

In order to play a digital source through the analog record output, you will need to connect that component's analog audio output to the Cinema Rhapsody Mach II in addition to its digital audio output. Furthermore, because each input label can only have one audio input assigned to it (analog 1-8, digital 1-4, or optical 1-4), you will need to use alternate input labels which share the same video jacks but are assigned to alternate analog audio input.

For example, if you want to record your DSS receiver to a VCR and your DSS receiver is connected digitally to the Cinema Rhapsody for Dolby Digital surround sound, you will need to connect the DSS receiver's analog audio output to an open analog audio input.

The Cinema Rhapsody Mach II's Out of the Box input configuration already has A record specific input label for DSS, whose primary audio connection will always be digital. For the other three components that could be set to an alternate digital audio input, including DVR/PVR, CABLE/TV, or CD PLAYER, there are also record input labels that access their original analog audio input. The chart below details these Out of the Box options.

INPUT #	INPUT LABEL	REASON FOR SPECIAL RECORD INPUT LABEL	RECORD INPUT LABEL AUDIO INPUT	STANDARD INPUT LABEL AUDIO INPUT	ALTERNATE AUDIO INPUT	POTENTIAL OUT OF THE BOX RECORD INPUT CONFLICT
17	DSS RECORD	CONNECTED DIGITALLY	ANALOG 2	OPTICAL 2	DIGITAL 2	MULTI-ROOM
18	DVR RECORD	MAY BE CONNECTED DIGITALLY	ANALOG 3	ANALOG 3	OPTICAL 3	NONE
19	TV RECORD	MAY BE CONNECTED DIGITALLY	ANALOG 5	ANALOG 5	OPTICAL 4	NONE
20	CD RECORD	MAY BE CONNECTED DIGITALLY	ANALOG 6	ANALOG 6	OPTICAL 1	NONE

DSS Receiver Analog Record Connection

If you do not have a multi-room system's output connected to the Cinema Rhapsody's analog audio input #2, proceed to connect the DSS receiver's analog audio output as noted in the diagram. Again, this cable is in addition to the other digital audio and video cables connected to the Cinema Rhapsody from the DSS receiver. If the Cinema Rhapsody's analog audio input #2 is already connected to another component (i.e. Multi-Room System), follow the procedures in this section under Reassigning Record Audio Inputs.

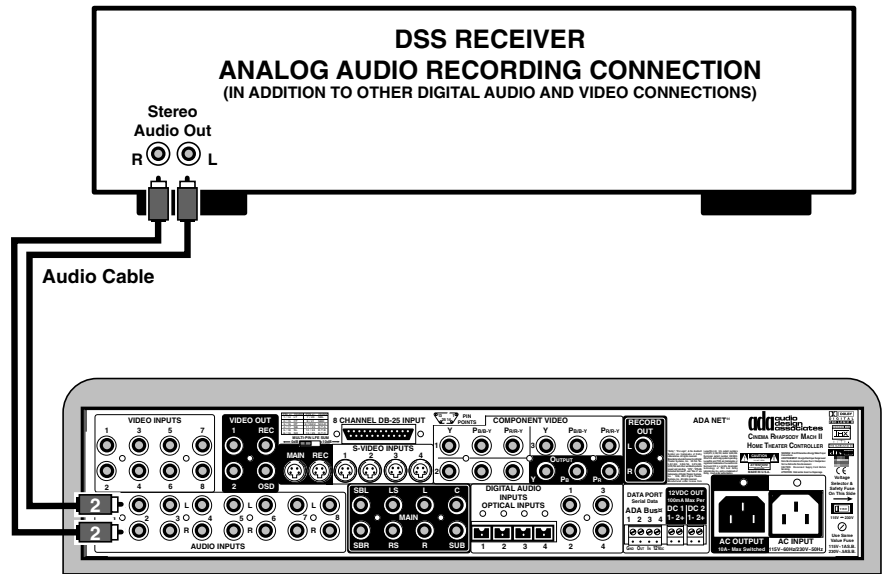

DVR/PVR Analog Record Connection

If you connected your DVR to the Cinema Rhapsody using an optical digital audio connection, you will still need to connect the DVR's analog audio output to the Cinema Rhapsody's analog input #3 as in the diagram. If you did not connect your DVR digitally, ignore this step as it is already in place.

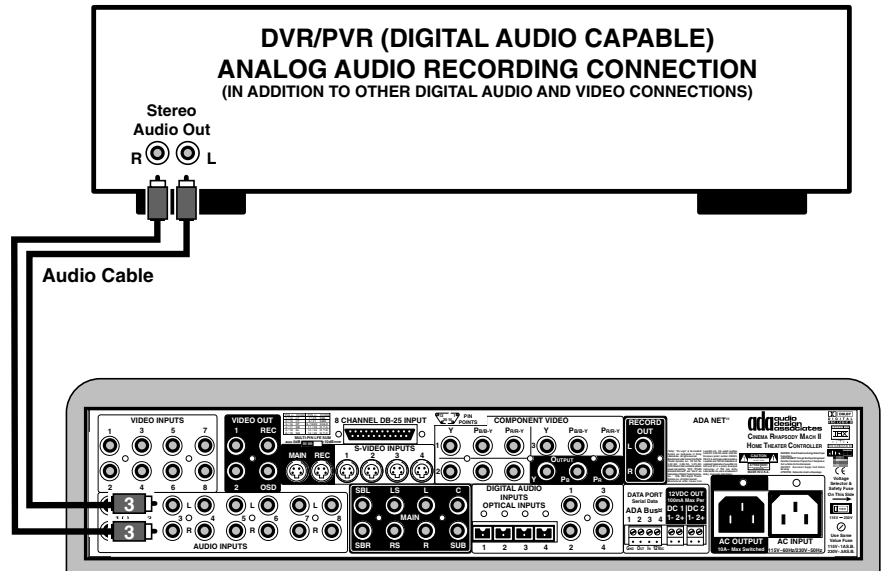

CABLE/TV Analog Record Connection

If you connected your digital capable CABLE/TV tuner to the Cinema Rhapsody using an optical digital audio connection, you will still need to connect the tuner's analog audio output to the Cinema Rhapsody's analog input #5 as in the diagram. If you did not connect your tuner digitally, ignore this step as it is already in place.

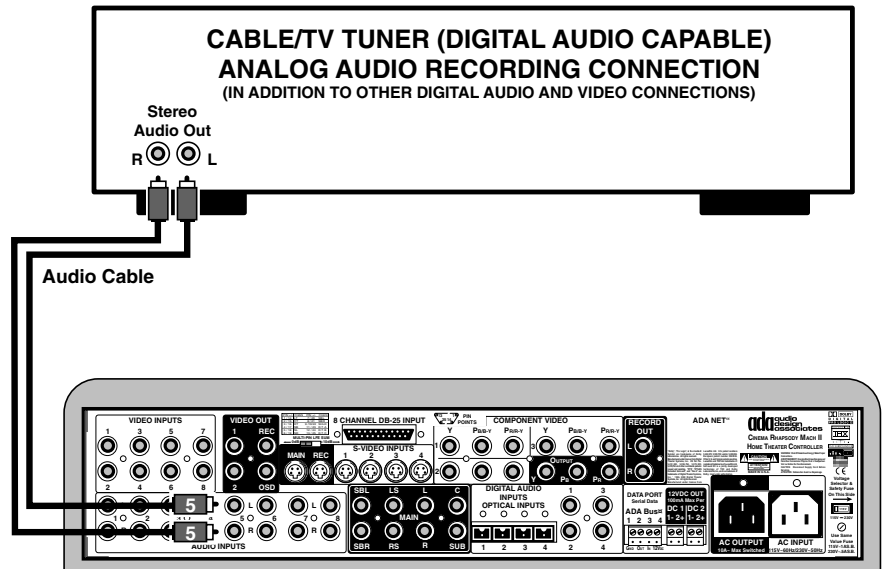

CD Player Analog Record Connection

If you connected your CD PLAYER to the Cinema Rhapsody using an optical digital audio connection, you will still need to connect the CD's analog audio output to the Cinema Rhapsody's analog input #6 as in the diagram. If you did not connect your CD player digitally, ignore this step as it is already in place.

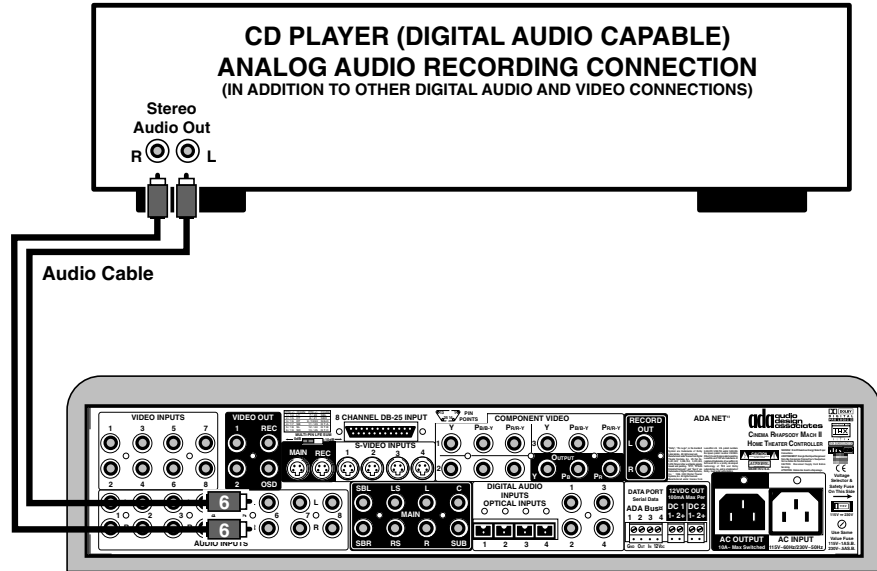

DVD Player Analog Record Connection

In order to maximize the Out of the Box input configuration options, ADA has purposely not included a DVD RECORD input label, with the primary consideration that DVD discs incorporate copyright protection that will prevent the copying of a DVD disc to VCR.

In the event you wish to pass the DVD player through your record output to feed to a second zone or are using your DVD player as your primary CD transport, which you wish to record from, you will need to create a DVD RECORD Input label as well as use an open analog input on the Cinema Rhapsody.

If no open analog input exists, you will have to skip this option. To alter the text of an Input label that is not being utilized, see the section entitled Label Inputs. Once the Input Label has been created for DVD RECORD, you can then assign the analog audio jack on the Cinema Rhapsody to this Input label's audio input. You will also need to need to assign the existing composite video, S-Video, component video, and RGB video input jacks to this Input label (DVD uses all video inputs #1). This is explained under Custom Input Configuration.

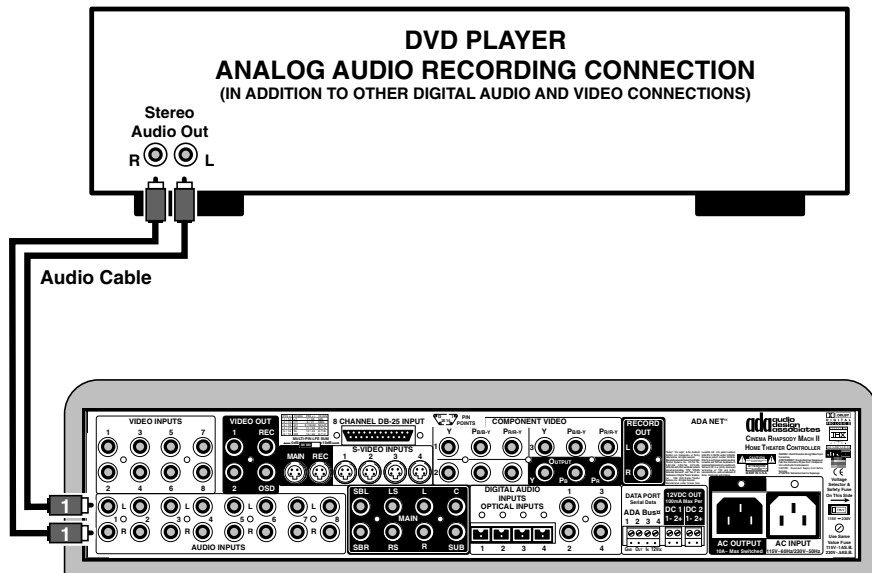

Components Inability to Play both Digital and Analog Audio

Please note, that some components are only capable of playing either a digital audio signal or analog audio signal. For these devices, there is typically a setup operation that permits you to select which audio jack is active. If you are not getting analog audio to pass through the record output, even though your connections are as illustrated, check the component's operation manual to make certain that it can play both digital and analog audio simultaneously.

Reassigning Record Audio Inputs

If you are limited on the number of open analog inputs on the back of the Cinema Rhapsody Mach II, ADA suggests making certain that the DSS receiver takes precedence to the DVD player. Because you may only get questionable results from attempting to record a DVD to VCR, ADA recommends first connecting the DSS. To begin:

- 1 Find an open analog audio input on the back of the Cinema Rhapsody and connect the DSS receiver's analog audio output to it. Remember the input number used for step #5.
- 2 Turn the Input knob until the display's second line reads DSS RECORD and press the Input knob.
- 3 Turn the Mode knob clockwise until the display's second line reads SETUP MENU and press the Mode knob.
- 4 Turn the Mode knob clockwise until the display's second line reads AUDIO INPUTS and press the Mode knob.
- 5 Turn the Mode knob until the display reads the ANALOG # that you connected the DSS to in step #1.

Turn the Volume knob to exit the setup mode. At this time, you should be able to turn the Record knob and send audio and video to your recording device.

To test this with a VCR as a recording device, you can do the following.

- 1 Make certain that the DSS is on an active channel, that your DVR is operating, that your Cable/TV Tuner is on a station, and that your CD player is in play. You can do this by selecting the various components using the Input knob.
- 2 Then turn the Input knob to the VCR and select. Make certain that your VCR is set to accept a video input. This may involve pressing the VCR's TV/Video button as this typically toggles between the VCR's internal TV tuner and its rear panel A/V jacks.

At this time, by selecting the VCR on the main input (using the Input knob), the main output is monitoring what the VCR is receiving. To check that your devices are properly going through the record output:

- 3 Turn the Record knob until the first record option is selected (i.e. DSS RECORD) and press the Record knob. The main output (theater) should play this component through the VCR indicating that the VCR is receiving both the audio and video signal.
- 4 Repeat this process for other components. Please note, that for common analog components, such as radio tuners, simply selecting the standard TUNER input will work. If you did not connect the DVR/PVR, Cable/TV, or CD input digitally to the Cinema Rhapsody, the non-RECORD versions of these input labels will pass to the VCR as well.

Custom Input Configuration

The Cinema Rhapsody Mach II's input configuration can also be completely customized to suite your specific system. ADA suggests to begin connecting components to the Cinema Rhapsody Mach II using the Out of the Box options discussed on the previous pages. You can then modify your setup to best suit your needs. This will save some time.

When desiring to work with a Custom input configuration, you may want to consider the following items prior to making any changes to the setup.

How many source components (input devices) are in the system?

Begin the process by determining the number of source (input) devices that will be connected to the Cinema Rhapsody Mach II.

Will you be using the record output?

While this is discussed in greater detail on the previous pages, if you plan on recording from the Cinema Rhapsody Mach II's record output, make a quick review of the devices that are connected digitally (using either coaxial or optical interconnects) to the Cinema Rhapsody Mach II. At this time, determine if all of the digital devices are going to need to pass audio out of the record output. For example, because of copy-protection features, you will most likely not be able to record a DVD disc onto video tape and as such, you may select to eliminate worrying about record options for DVD.

In order to record a source component that is digitally connected to the Cinema Rhapsody Mach II, you will need to setup a separate input label for that source. While this new record input label tracks the same video options of the input label that has a digital audio connection, the record input label will need to be set to track an analog audio connection. The record output only passes analog audio inputs.

Final Input

Add together the number of source components and the number of record components (that are connected digitally to the Cinema Rhapsody). This total is the number of input labels you will need the Cinema Rhapsody to display.

For example, your system has a total of seven source components; DVD, DSS, DVR, VCR, CABLE box, CD, and TUNER. DVD and DSS are connected digitally but as you won't be recording off the DVD player, you only need to pass the DSS receiver to the record output. As such, you will need a total of eight input labels to display, seven for the primary seven sources and one additional Record type input for DSS record.

You can now set the Cinema Rhapsody Mach II to display only the first eight input labels instead of the factory default 20 input labels. As you continuously turn the Input knob, only the first eight labels will be displayed. Please note, that if either the main Input or the Record Input is set to any input above input number 8, the Cinema Rhapsody will not permit you to proceed. To proceed with this setup feature:

- 1 Turn the Input knob so that the second line displays an input below the input 9 label and press the Input knob.
- 2 Turn the Record knob so that the second line displays an input below the input 9 label and press the Input knob.
- 3 Turn the Mode knob clockwise until the display's second line reads SETUP MENU and press the Mode knob.

- 4 Turn the Mode knob clockwise until the display's second line reads FINAL INPUT and press the Mode knob.
- 5 Turn the Mode knob counterclockwise until the display's second line reads the appropriate final input number. This number is displayed after the input label name. For this step, disregard the name of the input labels as these can be altered later. Please note, that if the display flashes the words CONFLICT WITH and then an input label, you have reached an input that is still being directed to either the main or the record output. You will notice that the Cinema Rhapsody will not permit you to select a Final Input that is below an actively selected input, hence the conflict warning. To permit a Final Input below this number, exit the setup mode and make certain to select both a main Input and Record input lower than your desired final input.
- 6 Turn the Volume knob to exit this setup operation.

At this time, turning of either the Input or Record knob will display only the first eight input label names. Final Input is the first step under Custom Input Configuration because it sets the number of inputs to correspond to the number of device connections. Again, if some of the input labels do not match the components in your system, the next steps will permit you to make these custom changes as well.

Label Inputs

The Cinema Rhapsody Mach II permits you to alter any input label. The label length allows for up to twelve letters, characters, and/or numbers. ADA strongly suggests leaving the original number (i.e. the number "8" as in AUXILIARY 8) in place. This number refers to the inputs position for control purposes and is important when selecting inputs from a remote control, PC, or control system. Eliminating this number from the input label does not defeat the ability for the input to be selected from a control, it just makes it harder for you to identify it numerically.

Now that you have set the final input, ADA suggests renaming any input label that does not match your system. In the example used for Final Input, where the system will consist of eight input labels:

DVD, DSS, DVR/PVR, VCR, CABLE/TV, CD, TUNER, DSS RECORD

with the current display reading

DVD, DSS, DVR/PVR, VCR, CABLE/TV, CD PLAYER, TUNER, AUXILIARY

ADA suggests leaving as many Out of the Box input labels (and their configuration) alone. This will permit you to customize your system faster and easier. For example, in viewing the current display input label options, it appears that only one input label really requires any change (AUXILIARY). We will need to change this to DSS RECORD. Naturally, if you are particular about the order components appear as you turn the Input or Record knobs, you may wish to alter other input labels as well. If so, remember that you will also need to reassign several other Out of the Box and Default settings as well.

ADA provides a PC program (Cinema Ref PCOS) that permits you to make these and further changes quite easily. You will need either an ISO-232 or IRT-3000 to communicate from your PC to the Cinema Rhapsody Mach II. This is discussed in the section marked PC Control.

When entering the LABEL INPUT setup mode on the Cinema Rhapsody Mach II, there are three tiered levels in which you navigate. The first level permits you to select the input label you wish to alter. Even though you may have already specified a Final Input, all twenty input labels appear in this level.

To enter the Label Inputs setup mode, turn the Mode knob clockwise until the display's second line reads SETUP MENU and then press the Mode Knob. You then turn the Mode knob clockwise until the display's second line reads LABEL INPUTS and then again, press the Mode knob. The display will now read:

LABEL INPUTS
DVD PLAYER 1

You navigate out of this level by turning the Mode knob all the way clockwise until the display reads BACK TO MAIN and then pressing the mode knob.

The second level permits you to select which character in the input label you wish to alter. Here the selected character is flashing and underlined while the display looks like:

LABEL INPUTS
<DVD PLAYER 1>

You navigate into this level with the press of the Mode knob going to >...<. You navigate back to the previous level by turning the Mode knob all the way clockwise until the display reads BACK TO LABEL and then pressing the mode knob.

The third level is the stage in which you change the letter, number, or symbol. At this level, the selected character is flashing and underlined the display looks like:

LABEL INPUTS
>DVD PLAYER<

You navigate into this level with the press of the Mode knob going from <...> to >...<. You navigate back to the previous level by pressing the Mode knob going from >...< back to <...>.

In the example defined earlier with the eight input labels, we only need to alter AUXILIARY to read DSS RECORD as shown below:

DVD, DSS, DVR/PVR, VCR, CABLE/TV, CD, TUNER, DSS RECORD

with the current display reading

DVD, DSS, DVR/PVR, VCR, CABLE/TV, CD PLAYER, TUNER, AUXILIARY

To enter the setup mode and alter the AUXILIARY input label to read DSS RECORD:

- 1 Turn the Mode knob clockwise until the display's second line reads SETUP MENU and then press the Mode knob.
- 2 Turn the Mode knob clockwise until the display's second line reads LABEL INPUTS and then press the Mode knob.
- 3 The top line of the display will read LABEL INPUTS and the second line will display the first input label, DVD PLAYER 1. Turn the Mode knob clockwise until the display's second line reads AUXILIARY 8 and then press the Mode knob.

- 4 The second line of the display will now show <AUXILIARY 8> where the <...> indicates that you are in the select character position mode. Here the A will be underlined and blinking.
- 5 To change the A to a D, as in DSS RECORD, press the Mode knob. The second line of the display will now change to >AUXILIARY 8<, where the >...< indicates that you are in the change character mode. Again, the A will be underlined and blinking, indicating that you can now change the A to a D.
- 6 Turn the Mode knob clockwise to change the A to a D and then press the Mode knob so that the display now reads <DUXILIARY 8>.
- 7 Turn the Mode knob clockwise one click so that U is underlined and blinking and then press the Mode knob. The display will again change from the select character position mode (<...>) to the change character mode (>...<).
- 8 Turn the Mode knob counterclockwise so that the U changes to the letter S and then press the Mode knob to return to the select character mode (<...>).
- 9 Turn the Mode knob clockwise one click so that the X is underlined and blinking and then press the Mode knob to switch to change character mode (>...<).
- 10 Turn the Mode knob counterclockwise so that the X changes to an S and then press the mode knob.
- 11 Turn the Mode knob clockwise one click so that the I is underlined and blinking and then press the Mode knob.
- 12 To turn the letter I into a blank space (as in DSS RECORD), turn the Mode knob all the way counterclockwise. The very last position is the blank space. Then press the Mode knob.
- 13 With the display now reading <DSS LIARY 8>, turn the Mode clockwise one click until the L is underlined and flashing. Then press the Mode knob.
- 14 Turn the Mode knob clockwise until the letter L has been replaced by the letter R and press the Mode knob.
- 15 With the display now reading <DSS RIARY 8>, turn the Mode knob clockwise one click until the I is flashing and press the Mode knob.
- 16 Turn the Mode knob counterclockwise until the I is replaced with letter E and then press the Mode Knob.
- 17 With the display now reading <DSS REARY 8>, turn the Mode knob clockwise one click until the A is flashing and press the Mode knob.
- 18 Turn the Mode knob counterclockwise until the A is replaced with letter C and then press the Mode Knob.
- 19 With the display now reading <DSS RECRY 8>, turn the Mode knob clockwise one click until the R is flashing and press the Mode knob.

20 Turn the Mode knob counterclockwise until the R is replaced with letter O and then press the Mode Knob.

21 With the display now reading <DSS RECOY 8>, turn the Mode knob clockwise one click until the Y is flashing and press the Mode knob.

22 Turn the Mode knob counterclockwise until the Y is replaced with letter D and then press the Mode Knob.

23 With the display now reading <DSS RECOR 8>, turn the Mode knob clockwise one click until the blank space is flashing and press the Mode knob.

24 Turn the Mode knob counterclockwise until the blank space is replaced with letter D and then press the Mode Knob.

25 With the display now reading <DSS RECORD 8>, turn the Mode knob clockwise until the display read's BACK TO LABL and press the Mode knob.

26 To continue with other setup options, turn the mode knob clockwise until the display reads BACK TO MAIN. To exit the setup mode entirely, turn the Volume knob.

Audio Input Configuration

The Cinema Rhapsody Mach II is extraordinarily flexible in that any A/V jack on the back of the unit can be assigned to any input label. Also, a specific A/V jack can be assigned to multiple input labels. While the Out of the Box input configuration of the Cinema Rhapsody Mach II has the jacks preassigned as noted in the previous sections, you may wish to alter some of these conditions when customizing your system. Use the Out of the Box input configuration chart below as a guide to determining what jacks are already assigned in the Out of the Box setup.

INPUT #	INPUT LABEL	AUDIO INPUT	ALTERNATE AUDIO INPUT	COMPOSITE VIDEO INPUT	S-VIDEO INPUT	COMPONENT VIDEO INPUT
1	DVD PLAYER	DIGITAL 1	-	1	1	1
2	DSS	OPTICAL 2	DIGITAL 2	2	2	2
3	DVR/PVR	ANALOG 3	OPTICAL 3	3	3	-
4	VCR	ANALOG 4	-	4	4	-
5	CABLE/TV	ANALOG 5	OPTICAL 4	5	-	-
6	CD PLAYER	ANALOG 6	OPTICAL 1	-	-	-
7	TUNER	ANALOG 7	-	-	-	-
8	AUXILIARY	ANALOG 8	-	8	-	-
9	DVD AUDIO	MULTI-PIN	-	1	1	1
10	MULTI-ROOM	ANALOG 2	-	-	-	-
11	CAMCORDER	ANALOG 1	-	7	-	-
12	VIDEO GAME	DIGITAL 3	OPTICAL 1	6	-	3
13	COMPUTER	DIGITAL 4	OPTICAL 1	6	-	-
14	LASERDISC	OPTICAL 1	-	8	-	-
15	LASER AC3	DIGITAL 2	-	8	-	-
16	PHONOGRPH	ANALOG 1	-	-	-	-
17	DSS RECORD	ANALOG 2	-	2	2	2
18	DVR RECORD	ANALOG 3	-	3	3	-
19	TV RECORD	ANALOG 5	-	5	-	-
20	CD RECORD	ANALOG 6	-	-	-	-

Taking the example in this section with the eight input labels, the first seven input labels follow the Out of the Box setup. The eight input label, previously AUXILIARY now labeled DSS RECORD, will require alteration.

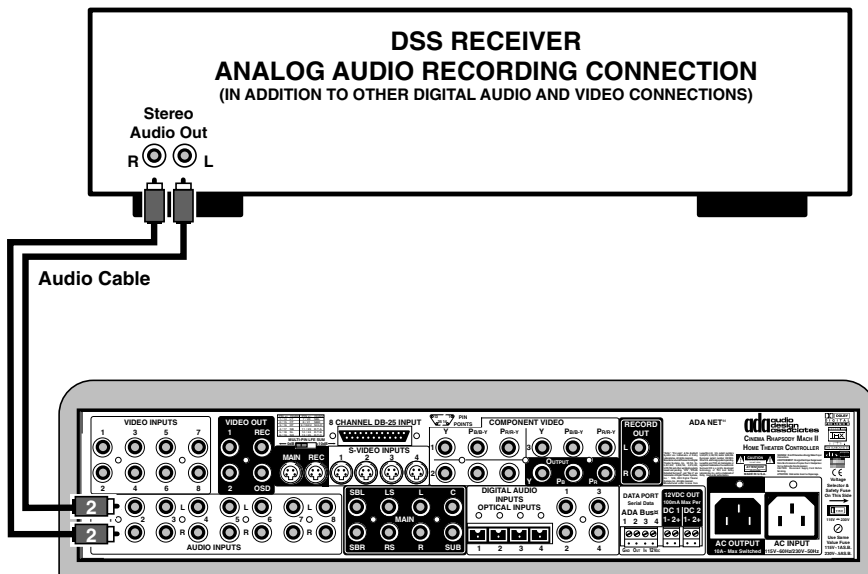

Assuming that the DSS RECORD setup was followed as outline under the Record section of this manual, the DSS receiver's analog audio output has already been connected to the Cinema Rhapsody's Analog input #2 as in the diagram. This connection is in addition to the standard DSS connections in the Out of the Box setup.

The first step is to now configure the DSS RECORD 8 input label to track analog input #2.

- 1 Turn the Input knob until DSS RECORD is seen on the display's second line and press the Input knob.
- 2 Turn the Mode knob clockwise until the display's second line reads SETUP MENU and press the Mode knob.
- 3 Turn the Mode knob clockwise until the display's second line reads AUDIO INPUTS and press the Mode knob.
- 4 Turn the Mode knob counterclockwise until the display's second line reads ANALOG 2 instead of ANALOG 8.
- 5 Press the Mode knob to return the display to read SETUP MENU & AUDIO INPUTS. As we will be making changes to the video inputs, you need not exit the setup mode yet.

These steps can be used to reassign any input label to either a digital coaxial, optical TOS-Link, or analog stereo audio input.

Composite Video Input Configuration

To alter an input label's composite video rear panel connection, one uses the same process as with the audio jack. Continuing with this example, the DSS receiver's normal playback input label is assigned to Composite Video input #2. The AUXILIARY input label is Out of the Box defaulted to composite video input #8. As such, with the DSS RECORD input label replacing AUXILIARY, we will need to reassign the video input so that DSS RECORD tracks the same video jack as normal DSS. To do so, follow these steps (assuming you have not exited the SETUP MENU).

- 6 Turn the Mode knob clockwise until the display's second line reads COMPOSITE IN and press the Mode knob.
- 7 Turn the Mode knob counterclockwise to change the display from COMPOSITE IN 8 to COMPOSITE IN 2.
- 8 Press the Mode knob to return to the previous state where the display reads SETUP MENU & COMPOSITE IN.

S-Video Input Configuration

As with the composite video input, the S-Video for the DSS RECORD input label needs to be set to track the S-Video input for the DSS's normal input. As the DSS is set to track S-Video input #2, proceed with the following:

- 9 Turn the Mode knob clockwise until the display's second line reads SVIDEO INPUT and press the Mode knob.
- 10 Turn the Mode knob until the display reads SVIDEO INPUT 2 and then press the Mode knob.

Component Video Input Configuration

To keep the system perfectly aligned, we will need to assign the component video input for the eighth input label, DSS RECORD 8, to match that of the normal DSS input. To do so:

- 11 Turn the Mode knob clockwise until the display's second line reads COMPONENT IN and press the Mode knob.
- 12 Turn the Mode knob until the display reads COMPONENT IN 2 and press the mode knob.

At this time, you have reassigned all of the A/V inputs on the Cinema Rhapsody Mach II from the factory default settings for the AUXILIARY 8 input label to work for the DSS RECORD 8 input label.

Auxiliary DC Triggers

The Cinema Rhapsody Mach II has two low voltage outputs which can be used to trigger other components or devices. These triggers can be used to perform several different operations such as:

- a Engaging a projector, screen, etc., for only video devices.
- b Alternate speaker drivers between music and film playback.
- c Turning on a power amplifier using an external AC switcher (ADA ACC-3 - 15 Amp Rating) if the amplifier will draw more than 10 amps current (Cinema Rhapsody's Switched AC Outlet maximum).

The Cinema Rhapsody sports two such triggers and both of these triggers are input specific. The Out of the Box setup is as follows:

AUX DC TRIG 1 = Engages with all inputs.

AUX DC TRIG 2 = Engages with only the components that have a video inputs:

DVD PLAYER 1, DSS 2, DVR/PVR 3, VCR 4, CABLE/TV 5, AUXILIARY 8, DVD AUDIO 9, CAMCORDER 11, VIDEO GAME 12, COMPUTER 13, DVD RECORD 14, DSS RECORD 15, DVR RECORD 16, TV RECORD 17, AUXILIARY 2, & AUXILIARY 3

Since most home theaters using this feature will involve some level of professional setup, you can alter the Aux DC Triggers using the following steps. If you are planning on adjusting the Final Input or Input Labels, ADA suggests first making these adjustments prior to proceeding with the Aux DC Trigger setup.

To setup and verify the Aux DC Triggers:

- 1 Turn the Input knob to the input label you wish to set the trigger for and press the Input knob.
- 2 Turn the Mode knob clockwise until the display's second line reads SETUP MENU and press the Mode knob.
- 3 Turn the Mode knob clockwise until the display's second line reads either AUX TRIGGER1 or AUX TRIGGER2 and press the Mode knob.
- 4 Turn the Mode knob to turn the AUX TRIGGER # ON or OFF, then press the Mode knob.

Repeat this step as necessary.

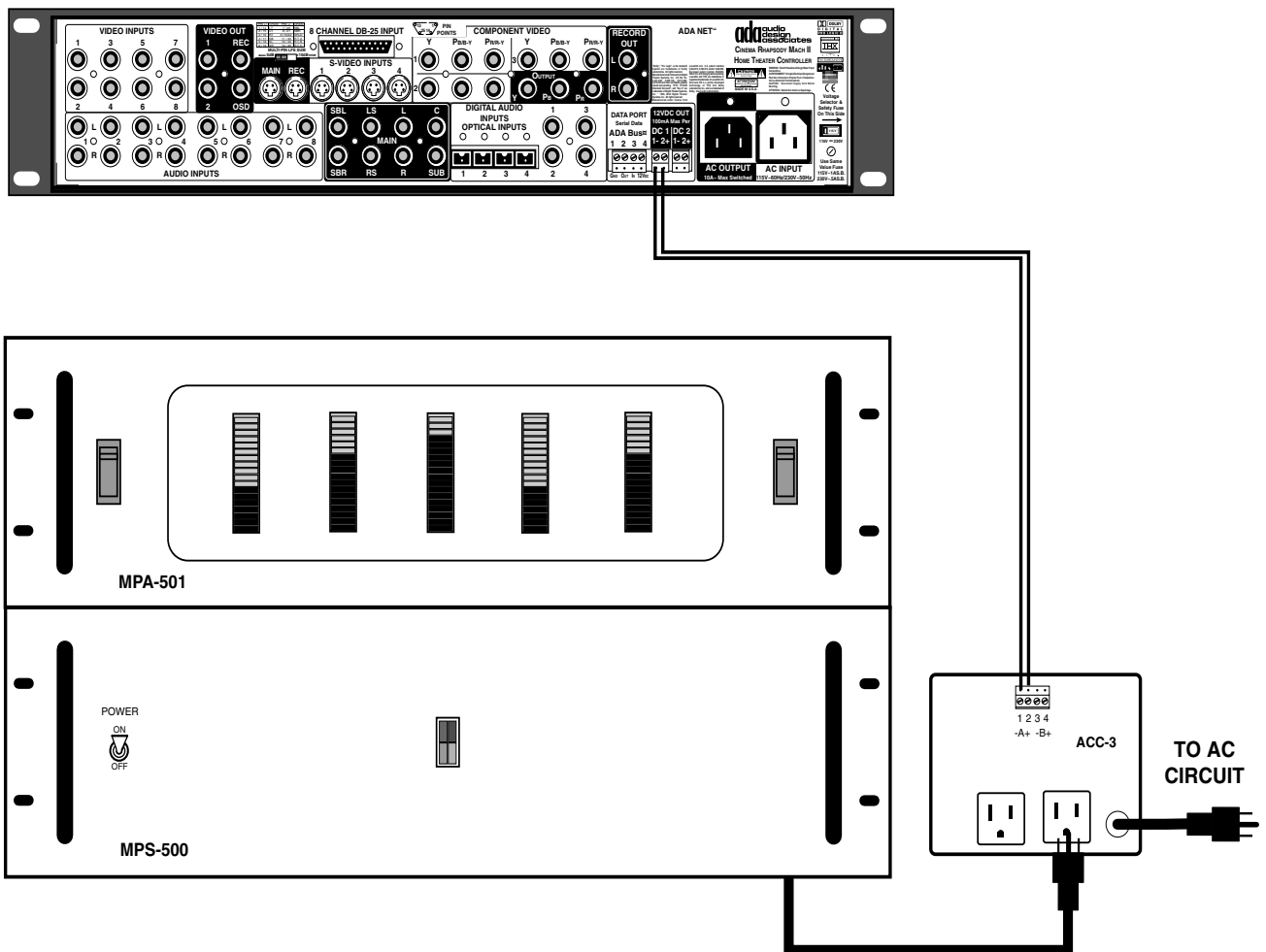

Turn On Input

When controlling the Cinema Rhapsody Mach II from a remote control or control system, the action of first selecting an input, causes the Cinema Rhapsody to turn on and switch to that input.

However, when turning the Cinema Rhapsody on from its front panel, by pressing the Volume knob, the Cinema Rhapsody's Out of the Box default setting will cause it to turn on to the last input that was used. If you would prefer to have the Cinema Rhapsody turn on to a specific input, every time the front panel Volume knob is pressed (assuming the unit was off), then follow the steps below. Please note, that altering the Turn On input from Last Used to a specific device does not affect your ability to turn the Cinema Rhapsody on to a selected input via its remote control or from a control system.

- 1 Turn the Mode knob clockwise until the display's second line reads SETUP MENU and press the Mode knob.
- 2 Turn the Mode knob clockwise until the display's second line reads TURNON INPUT and press the Mode knob.
- 3 Turn the Mode knob to select the desired turn-on component and then press the mode knob. To exit the Setup Menu completely, turn the Volume knob.

Illumination

The Cinema Rhapsody Mach II permits you to adjust the brightness of the front panel not including the LCD preview monitor. This includes the labeling around the five control knobs, the input/output/mode lamps, and the two line alphanumeric display. The Cinema Rhapsody Mach II's Out of the Box setup has this feature set to 100%. You can opt to set it to a specified value lower than 100% or to AUTO. In Auto, the Cinema Rhapsody's front panel electric eye will lower the intensity of these displays depending on room light. The darker the room becomes, the lower the levels go. To alter this setting to either AUTO or to an alternate percentage value:

- 1 Turn the Mode knob clockwise until the display's second line reads SETUP MENU and press the Mode knob.
- 2 Turn the Mode knob clockwise until the display's second line reads ILLUMINATION and press the Mode knob.
- 3 Turn the Mode knob clockwise to select AUTO or turn it counterclockwise to select a specific percentage value. Then press the mode knob. To exit the Setup Menu completely, turn the Volume knob.

Speaker Size Setup 1

Once you have your inputs configured properly, you will need to setup the Cinema Rhapsody Mach II's outputs which pass to your power amplifier and then the speakers. In this section, you will need to proceed with several steps that focus on the type of speaker you are using in your system.

The Cinema Rhapsody Mach II uses the description of SMALL, LARGE, and NONE with respect to the speakers.

SMALL refers to speakers that are not designed to handle low frequencies.

LARGE refers to speakers that are capable of playing low frequencies.

NONE refers to that speaker not existing in your system (i.e. no back-center surround speakers)

There is another Cinema Rhapsody feature that works in conjunction with SMALL settings called:

SW CROSSOVER which refers the Sub Woofer crossover frequency point.

The subwoofer crossover frequency point determines at which frequency the Small speakers bass information is "rolled off" and sent to the subwoofer. Speakers that are set to Large are never rolled off. The crossover frequency point is fully adjustable on the Cinema Rhapsody Mach II and is discussed in the tail end of this section.

What type of speakers are your using?

If you are using THX speakers, most such speaker designs are purposely engineered to not handle low frequencies because the subwoofer is providing all of the bass sound reinforcement. The typical crossover frequency point for THX speaker is 80Hz (Hertz). In a THX speaker system, all bass information below 80Hz intended for the left, center, right, surround left, surround right, back surround left, and back surround right speakers is redirected to the subwoofer and summed (combined) with the LFE (Low Frequency Effects or the ".1" in a 5.1 mix). As such, these speakers are rolled off at 80Hz.

If you have a mix of home theater speakers and full-range speakers (speakers that can handle bass), you can opt to set some speakers to the Large setting and other speakers to the Small setting.

The Cinema Rhapsody groups speakers as such: the front left and right are one group, the center speaker is a second group, the surround left and right speakers are a third group, the back left and right surround speakers are fourth group, and subwoofer is a fifth group.

Prior to proceeding with the speaker setup for your system, here are a few considerations.

- a ADA generally recommends that all speakers are set to small for the optimum theater experience, even if some of your speakers are full range. This suggestion coincides with the understanding that your system contain at least one subwoofer and that it is a quality subwoofer. The reason behind this suggestion is based on two considerations. First, most bass information in film content is mixed into the front left and right channels as well as the ".1" LFE channel. By directing all of the bass information to the subwoofer, you will create a more theater-like experience. Second, the subwoofer control section of the Cinema Rhapsody Mach II is extremely powerful, giving you extensive control of all bass information.
- b While systems can be run in a phantom mode, where the center channel information is redirected to the front right and left speakers, ADA strongly suggests that you utilize a center channel speaker in your system. As this channel handles mostly dialogue, it is an important speaker in your system.

- c When trying to decide what type of surround speakers to utilize, either dipole or directional speakers, there is much discussion as to which will perform better with 5.1 digital source material. Some suggest placing directional speakers in the back left and right corners. While this will work, if you are also employing back-surround speakers in addition to left and right surround speakers, you will most likely have a better sound field with dipole speakers placed at the listening position slightly above head level. You can then opt for directional or dipole speakers for the back-surround channels.
- d When employing back surround speakers, you will need to determine if you are using one or two speakers. If the back wall of the theater is not very wide, you may opt to include a single speaker in the middle. If the rear wall is wide, you can include two speakers evenly spaced along the back wall. The Cinema Rhapsody Mach II permits you to have two, one, or no back-surround speakers (and if they are large or small).

The Cinema Rhapsody Mach II's Out of the Box speaker setup has all speakers set to SMALL, all speakers are on including two back surround speakers, and the subwoofer ACTIVE. To alter any of these features:

- 1 Turn the Mode knob clockwise until the display's second line reads SETUP MENU and then press the Mode knob.
- 2 Turn the Mode knob clockwise until the display's second line reads PRO SETUP and then press the Mode knob.
- 3 Turn the Mode knob clockwise one click so that the display's second line reads STEP 1 SPKRS and press the Mode knob.
- 4 Turn the Mode knob to the desired speaker group (FRONT, CENTER, SURR, BACK, SUB) and then press the Mode knob. To return to the previous Pro Setup menu level, turn the Mode knob clockwise until the display's second line reads BACK TO MAIN and press the Mode knob.
- 5 Turn the Mode knob to select LARGE, SMALL, or NONE (FRONT does not have a NONE option, BACK has large and small options for one or two speakers) and press the Mode knob.
- 6 Continue altering speaker size settings for all speaker groups. Note that the option for the subwoofer is not large or small, but rather ACTIVE (if your system has a subwoofer or INACTIVE if your system does not have a subwoofer).
- 7 To return to the Pro Setup menu options, the second line of the display needs to read either SPEAKER or SPKER. Turn the Mode knob clockwise until the display reads BACK TO MAIN and then press the Mode knob. To exit the setup mode completely, turn the Volume knob.

At this time, the Cinema Rhapsody Mach II is setup for your specific speaker system with respect to the number of speakers and their size.

Subwoofer Crossover Point Setup

The Cinema Rhapsody Mach II permits you to set the subwoofer to best match the speakers in your system. While the THX crossover frequency point (roll off point) is 80Hz, some speakers may operate better with a slightly lower roll off and others with a slightly higher roll off. For example, ribbon speakers typically operate best at frequencies above 180Hz. ADA suggests consulting with the manufacturer of your home theater speakers prior to altering this setting. While the Cinema Rhapsody Mach II's factory default is the THX 80Hz setting, the range of the crossover is Off or 60Hz to 220Hz, in increments of 10Hz.

When setting the crossover, remember that it will affect only those speakers that are set to Small, as their bass information (below the crossover setting) will be summed with the LFE (".1" effects channel) and be directed to the subwoofer.

To set the Subwoofer Crossover:

- 1 Turn the Mode knob clockwise until the display's second line reads SETUP MENU and then press the Mode knob.
- 2 Turn the Mode knob clockwise until the display's second line reads PRO SETUP and then press the Mode knob.
- 3 Turn the Mode knob clockwise one click so that the display's second line reads SW CROSS-OVER and press the Mode knob.
- 4 To turn the crossover completely off, turn the Mode knob counterclockwise until the display reads FILTER OFF. Otherwise, turn the Mode knob until the display reads the desired crossover frequency point.
- 5 To proceed with other Pro Setup options, press the Mode button. To completely exit the setup menu, turn the Volume knob.

Multi-Pin Speaker Setup

The Cinema Rhapsody Mach II has a secondary Large/Small setting for multi-channel DVD Audio or SACD connections. This crossover applies only to the Multi-Pin (25 pin D connector) and takes place in the analog domain because the DVD Audio or SACD input completely bypasses the DSP and D/A convertors. As such, the crossover has more limited features than those internal to the DSP.

The Multi-Pin crossover frequency is fixed to 80Hz and offers four options; all speakers Small, all speakers Large, front right & left Large with others small, or front right and left small with all others large.

This feature is an important circuit in the Cinema Rhapsody Mach II because unlike Dolby Digital or DTS decoding, where there is ample bass management, DVD Audio or SACD offers none. This is an extremely important issue because DVD Audio and SACD are mixed such that all channels output full range. When playing full range on a THX speaker system, the main speakers end up getting signals well below 80Hz. Furthermore, the subwoofer may also end up receiving a full range signal. This will result in an extremely poor sound field as speakers that are not designed to deliver bass have to do so while the subwoofer, designed just to play low frequencies, has to put out full range. As such, this aspect of the Cinema Rhapsody Mach II makes it an ideal choice for those looking to add DVD Audio or SACD to their system.

While the standard speaker setup options, including the variable crossover frequency point, apply to all input labels set to track either analog or digital audio inputs, the Multi-Pin speaker setting is independent and only is activated for input labels that are linked to the Multi-Pin audio input. For example, if you are using full-range front and right speakers but setup these speakers as Small in the previous page for the best movie audio experience, you may opt to run these speakers as Large for the Multi-Pin input, as this input is designed to primarily play music from either DVD Audio or SACD discs.

The Cinema Rhapsody's Out of the Box Multi-Pin speaker setup is set to all speakers Small. To alter this:

- 1 Turn the Mode knob clockwise until the display's second line reads SETUP MENU and then press the Mode knob.
- 2 Turn the Mode knob clockwise until the display's second line reads MULTI-PIN and then press the Mode knob.
- 3 Turn the Mode knob to select the desired speaker option as described above and then press the Mode knob.
- 4 To exit the setup mode completely, turn the Volume knob.

At this time, you have set the Multi-Pin output to conform with your speaker system.

Multi-Pin Input LFE Boost Switch

For the Multi-Pin input, the Cinema Rhapsody Mach II has a special bass setting that will permit you to increase (or decrease) the presence of the LFE (".1") channel by a differential of 10dB.

For the Multi-Pin input, speakers that are set to the Small option have their bass information below 80Hz summed with the LFE channel and sent to the subwoofer.

When the LFE gain switch is set to the left, the LFE is not boosted. As such, the LFE is summed with the bass information of all Small speakers and then sent to the subwoofer.

When the LFE gain switch is set to the right (+10dB), the LFE is first boosted by 10dB and is then summed with the bass information of all speakers set to Small. This enhanced LFE output is then sent to the subwoofer.

As you listen to multi-channel DVD Audio or SACD material, you may wish to either increase, or if already set to +10dB, decrease the bass output using this switch, rather than readjusting the bass levels for the DVD AUDIO input label.

Please note, that this should be a one time setting that is best performed while playing a DVD Audio or SACD signal through the system.

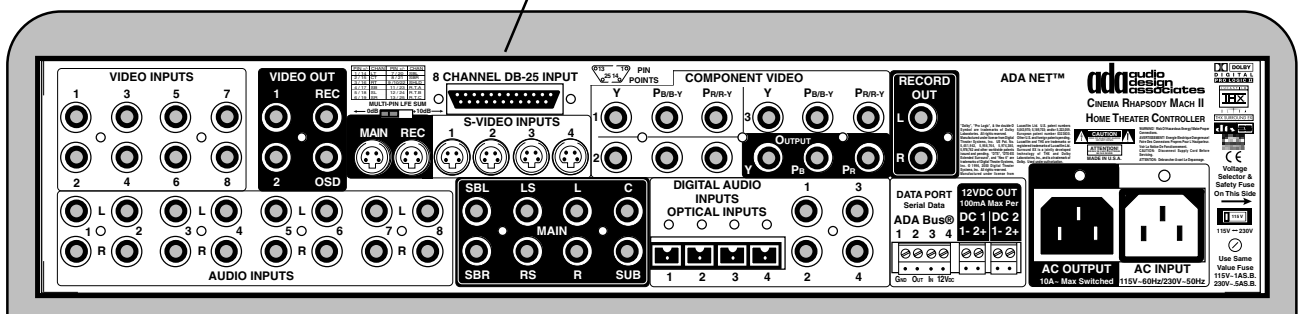
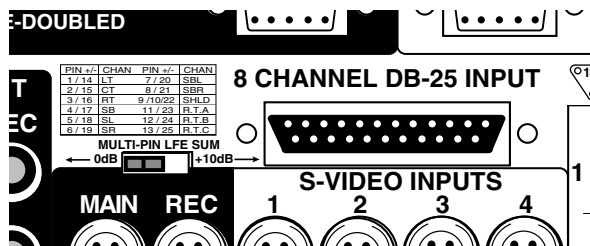

Speaker Level Setup 2

The Cinema Rhapsody Mach II's next step involves the balancing of the speaker channels for the optimum home theater experience. This step permits you to make certain that the individual speaker levels are balanced appropriately. Prior to entering this step, you should already have completed the positioning of your speakers and programmed their size into the Cinema Rhapsody Mach II.

The Cinema Rhapsody Mach II has been calibrated in the factory for optimum operation. Thus you can at this time decide to run your system with just minor adjustments to the Master Volume Control (center knob).

However, since not all speaker configurations and rooms are the same, for correct setup you should adjust the channel balance (as well as the delay settings) to best suit your home theater system. If you are unfamiliar with the process of home theater level calibration and the use of an SPL meter (Sound Pressure Level meter), ADA strongly suggests contacting an Authorized ADA Dealer for assistance prior to proceeding.

The Cinema Rhapsody Mach II features an internal Pink Noise generator which is used to determine the signal level to each speaker. In order to best proceed with the remainder of this section's setup instructions, it is recommended that you use an SPL meter. Set your SPL meter to "C" weighted and "Slow". The optimum SPL level should read 75 dB for each channel. Prior to entering this setup, please note that pink noise is a static type sound that will not harm your speakers and is used strictly for level calibration. To begin this setup:

- 1 Turn the Mode knob clockwise until the display's second line reads SETUP MENU and then press the Mode knob.
- 2 Turn the Mode knob clockwise until the display's second line reads PRO SETUP and then press the Mode knob.
- 3 Turn the Mode knob clockwise until the display's second line reads STEP 2 LEVEL and press the Mode knob.
- 4 The display's second line will read NOISE LEFT and you will now hear pink noise coming from just the Left channel. Turn on your SPL meter to the 70dB range, Slow, C Weighted setting. Sit in your listening position and hold the meter at comfortable arms length, pointed upwards. If the meter is reading 75dB, proceed to the next step. If the reading is not on 75dB, press the Mode knob to adjust the left channel's level up or down so that the meter reads 75dB. When completed press the Mode knob.
- 5 Turn the Mode knob clockwise one click until the display reads NOISE CENTER. If the meter is reading 75dB, proceed to the next step. If the reading is not on 75dB, press the Mode knob to adjust the center channel's level up or down so that the meter reads 75dB. When completed press the Mode knob.
- 6 Turn the Mode knob clockwise one click until the display reads NOISE RIGHT. If the meter is reading 75dB, proceed to the next step. If the reading is not on 75dB, press the Mode knob to adjust the right channel's level up or down so that the meter reads 75dB. When completed press the Mode knob.
- 7 Turn the Mode knob clockwise one click until the display reads NOISE R SURR. If the meter is reading 75dB, proceed to the next step. If the reading is not on 75dB, press the Mode knob to adjust the right surround channel's level up or down so that the meter reads 75dB. When completed press the Mode knob.

- 8 Turn the Mode knob clockwise one click until the display reads NOISE R BACK. If the meter is reading 75dB, proceed to the next step. If the reading is not on 75dB, press the Mode knob to adjust the right back-surround channel's level up or down so that the meter reads 75dB. When completed press the Mode knob.
- 9 Turn the Mode knob clockwise one click until the display reads NOISE L BACK. If the meter is reading 75dB, proceed to the next step. If the reading is not on 75dB, press the Mode knob to adjust the left back-surround channel's level up or down so that the meter reads 75dB. When completed press the Mode knob.
- 10 Turn the Mode knob clockwise one click until the display reads NOISE L SURR. If the meter is reading 75dB, proceed to the next step. If the reading is not on 75dB, press the Mode knob to adjust the left surround channel's level up or down so that the meter reads 75dB. When completed press the Mode knob.
- 11 Turn the Mode knob clockwise one click until the display reads NOISE SUB. If the meter is reading 75dB, proceed to the next step. If the reading is not on 75dB, press the Mode knob to adjust the subwoofer channel's level up or down so that the meter reads 75dB. When completed press the Mode knob.

At this time you have calibrated the pink noise to THX specifications. To quickly review all channel levels:

- 12 Turn the Mode knob clockwise one click until the display reads NOISE SEQ. At this time, the noise will automatically sequence through all channels permitting you to focus on the SPL meter and verify that the levels are even to each other.
- 13 To return to the previous setup menu level, turn the Mode knob clockwise until the display's second line reads BACK TO MAIN and then press the Mode knob. To exit the setup menu completely, turn the Volume knob.

Balance Presets

The Cinema Rhapsody Mach II features four balance presets which store the channel levels settings. At this time, with the channel balance settings in place, ADA strongly suggests storing Balance Preset 1. This will preserve the work you have just completed in Speaker Level Setup 2 . To proceed:

- 1 Turn the Channel knob clockwise until the display reads RECALL/STORE BAL PRESETS. Do not stop on the option PUSH RECALLS BAL PRESET 1. If you are on this option and then press the Channel knob, you will recall the ADA factory settings and erase the calibration you just performed under Speaker Level Setup 2.
- 2 With the display reading RECALL/STORE BAL PRESETS, press the Channel knob.
- 3 The display will now read RECALL BAL PRESET 1. Do not press the Channel knob.
- 4 Turn the Channel knob clockwise until the display reads STORE BAL PRESET 1. Now press the Channel knob to store your presets. The display will briefly indicate STORED.
- 5 To continue with other Preset setup features, turn the Channel knob clockwise until the display's second line reads BACK TO MAIN and then press the Channel knob. To exit this setup menu entirely, turn the Volume knob.

At this time you have successfully stored the previous adjustments in Speaker Level Setup 2. To recall Balance Preset 1 at any time:

- 1 Turn the Channel knob until the display reads PUSH RECALLS BAL PRESET 1 and then press the Channel knob.

As mentioned, the Cinema Rhapsody features four Balance Presets that can be recalled from the units front panel, a remote control, or a control system. While Balance Preset 1 is used almost exclusively for all film playback, the additional three Balance Presets can be used to store alternate channel levels. For example, if additional rear channel level is desired for less enveloping sound tracks, one can store an alternate balance preset that is stored with a slightly higher level for the surround channels. Alternately, when viewing film material in the evening, when the normal bass levels might be too loud, disturbing other members of the household who might be sleeping, a balance preset could be created in which the subwoofer is slightly lower than that during normal operation. This flexibility gives you the power to contour balances between speakers and easily recall them.

Delay Level Setup 3

The adjustment of the Delay setting can be configured independently for each of the Cinema Rhapsody Mach II's eight channels (including the subwoofer channel). The goal of setting channel delays is to have the sound from each speaker reach the primary seating position at the same time or perhaps better put, the correct time. Since the Cinema Rhapsody Mach II can delay the signal of a channel from reaching that channel's output (and as such, the amplifier, then the speaker, and then your ears), the delay is applied to all speakers that are closer to the listener than the furthest speaker. This speaker, the one at the greatest distance from the primary listening/viewing position, for the sake of this section, will be called the "Reference Speaker", because all of the other speakers closer to the listening position will use this speaker's distance as a reference point.

The process of setting the delays will require the use of a tape measure or some other distance measuring instrument. ADA suggests using the U.S./British standard to measure these distances in feet as sound travels at approximately 1 foot per millisecond (1/100th of a second). If you are using the metric standard to measure your distances, ADA suggests converting all measurements to feet as it will be easier to calibrate the delay time settings (1 foot is approximately equal to 30.5 cm).

The example details an extreme sample speaker placement where each speaker is located at a different distance from the primary seating position. The chart below is filled in with the sample distances from diagram.

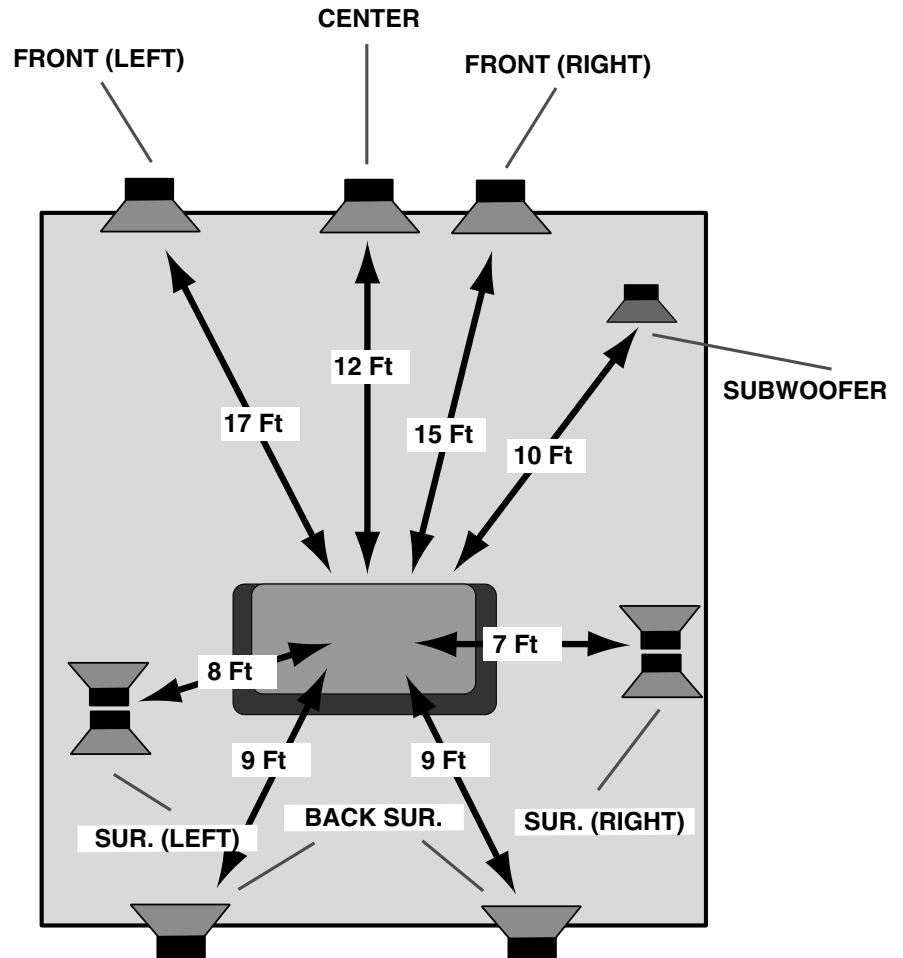

	FRONT LEFT	CENTER	FRONT RIGHT	SUBWOOFER	LEFT SURROUND	RIGHT SURROUND	LEFT BACK SURROUND	RIGHT BACK SURROUND	
ENTER DISTANCE OF FURTHEST SPEAKER (REFERENCE SPEAKER)	17	17	17	17	17	17	17	17	
ENTER DISTANCE OF EACH SPEAKER	17	12	15	10	8	7	9	9	
SUBTRACT SPEAKER'S DISTANCE FROM REFERENCE SPEAKER	0	5	2	7	9	10	8	8	THESE ARE THE SPEAKER'S DELAY SETTINGS

To proceed, you will first determine where your primary listening viewing seating position will be. Next you will want to measure the distance from the primary listening/viewing position each speaker using a tape measure. Your measurements need to be accurate to within 1 foot. Use can use the accompanying blank chart to fill in your speaker distances. Once you have filled in the speaker distances on the second line, take the highest value distance and insert it into the top row of each speaker column. Then subtract the distance of the speaker from the distance of the Reference Speaker. The end value (in feet) is the distance value for the delay setting for that speaker.

	FRONT LEFT	CENTER	FRONT RIGHT	SUBWOOFER	LEFT SURROUND	RIGHT SURROUND	LEFT BACK SURROUND	RIGHT BACK SURROUND	
ENTER DISTANCE OF FURTHEST SPEAKER (REFERENCE SPEAKER)									
ENTER DISTANCE OF EACH SPEAKER									
SUBTRACT SPEAKER'S DISTANCE FROM REFERENCE SPEAKER									THESE ARE THE SPEAKER'S DELAY SETTINGS

With the distance information collected, you can now proceed to calibrate the Cinema Rhapsody Mach II using the steps below. The Cinema Rhapsody Mach II's Out of the Box delay settings have all delays set to 0 Feet.

Please note, at least one channel needs to remain at a delay setting of 0 Feet. If you apply a delay distance to each channel, you will cause the Cinema Rhapsody's DSP to loose the delay reference point. It is extremely important that at least one delay distance point remain at 0.

- 1 Turn the Mode knob clockwise until the display's second line reads SETUP MENU and then press the Mode knob.
- 2 Turn the Mode knob clockwise until the display's second line reads PRO SETUP and then press the Mode knob.
- 3 Turn the Mode knob clockwise until the display's second line reads STEP 3 DELAY and press the Mode knob.
- 4 The display will indicate DELAY LEFT. If the left channel is the at the furthest distance from the seating area, you will not need to delay this channel. To proceed to delay other channels, turn the Mode knob to the next channel you need to adjust and proceed with the steps below. To return to the previous setup menu level, turn the Mode knob clockwise until the display's second line reads BACK TO MAIN and press the Mode knob. To completely exit the setup mode at any time, turn the Volume knob.
- 5 When the display's second line displays a channel whose delay you need to set, press the Mode knob.
- 6 Turn the Mode knob to the appropriate delay distance noted in Feet. When completed, press the Mode knob.
- 7 Turn the Mode knob to the next channel requiring a delay setting and press the Mode knob.
- 8 Repeat steps 6 and 7 until all channel delays have been appropriately set. Remember to leave the speaker at the greatest distance from the listening area to a delay setting of 0 Feet. When completed, turn the Volume knob to exit the setup mode.

Bass Setup 4

The Cinema Rhapsody provides you with the ability to engage a Bass Peak Limit Manager that operates in a range from 0 dB (decibels) to -24 dB. The function of the Bass Peak Limit Manager is to reduce the possibility of overloading the subwoofer in cases of extreme volume and/or software that provides extremely dynamic bass information. If your subwoofer is capable of providing a large level of bass without bottoming out, you may not need to engage the Bass Peak Limit Manager. If however, you play your system at volume levels that, on occasion, will cause your subwoofer to play distorted audio segments, you will wish to engage the Bass Peak Limit Manager. The Cinema Rhapsody's "Out Of The Box" setup has the Bass Peak Limit Manager, also known as the Bass Limiter, set to -24dB, the THX reference. There are two different ways in which to set the Bass Limiter on the Cinema Rhapsody Mach II, using either a pink noise or using actual playback material. The first is described in this segment and the latter in the segment below.

The Bass Peak Limit Manager has a range with the options of OFF or -24 dB up to 0 dB. The range operates as such: As an example, assume that the Bass Peak Limit Manager is set to -12dB. During operation, as the Master Volume Level is raised and goes above -12 dB, the volume of the subwoofer channel will stop rising. As such, regardless of how loud the sound system gets (-11 dB all the way to +10 dB), the bass level will never exceed -12 dB bass limit. To turn off or adjust the Bass Peak Limit Manager using test tones:

- 1 Turn the Mode knob clockwise until the display's second line reads SETUP MENU and then press the Mode knob.
- 2 Turn the Mode knob clockwise until the display's second line reads PRO SETUP and then press the Mode knob.
- 3 Turn the Mode knob clockwise until the display's second line reads STEP 4 BASS and press the Mode knob.
- 4 The pink noise will play through the subwoofer and the display will indicate the current settings. To change the settings, turn the Mode knob. To turn the limiter completely off, turn the Mode knob counterclockwise until the display reads LIMITER OFF.
- 5 Press the Mode knob to exit this setup menu. Turn the Volume knob to completely exit the setup menu.

Bass Limiter

The BASS LIMITER under Pro Setup is manual and does not provide any subwoofer noise (as in Noise Test). To set the Bass Peak Limit Manager in this manner requires that you listen to your subwoofer for distortion. You can use either STEP 4 BASS or BASS LIMITER to dial in the desired Bass Peak Limit Manager level or to turn it completely off. You do not need to use both methods, as adjusting one, will affect the other. To set the Bass Peak Limit Manager using no test tones:

- 1 While in the Pro Setup menu, turn the MODE knob clockwise until the display reads BASS LIMITER and then press the MODE knob. The Cinema Rhapsody's display will read BASS LIMITER on the top line and the second line will read OFF or LIM and a number (-24 to 0 dB).
- 2 Turn the MODE knob gradually and stop just prior to the subwoofer distorting. You can also turn the Mode knob counterclockwise until the display reads LIMITER OFF.
- 3 Press the Mode knob to exit this setup menu. Turn the Volume knob to completely exit the setup menu.

THX Ultra Setup 5

The Cinema Rhapsody permits the adjustment of features that are specific to THX Ultra 2. These two elements include Boundary Gain settings and Advanced Speaker Array settings.

Boundary Gain Control (BGC)

When the chosen listening room layout (for practical or esthetic reasons) results in the listener being too close to the rear wall, the resulting bass level can be sufficiently reinforced by the boundary that the overall sound quality becomes “boomy”. Boundary Gain Compensation (BCG) can be switched on to restore the correct bass performance.

- 1 Turn the Mode knob clockwise until the display’s second line reads SETUP MENU and then press the Mode knob.
- 2 Turn the Mode knob clockwise until the display’s second line reads PRO SETUP and then press the Mode knob.
- 3 Turn the Mode knob clockwise until the display’s second line reads STEP 5 THX and press the Mode knob.
- 4 Turn the Mode knob until the display’s second line reads BOUNDRY GAIN and press the Mode knob.
- 5 Turn the Mode knob to turn Boundry Gain (BNDRY GN) ON or OFF and then press the Mode knob. Continue below.

Advanced Speaker Array (ASA)

The optimum blend of ambient and rear directional information provides an enhanced surround experience over a wider listening area for all multi-channel formats. With stereo surround tracks and multi-channel music,, the signal is fed unprocessed to the left and right surrounds and, after further processing, to the surround back speakers. This processing uses THX ASA (Advanced Speaker Array) Technology and provides an enveloping rear surround field over a wide listening area. The adjustment to the ASA is based on three settings; if the two back surround speakers are less than 12 inches apart, if they are between 12 and 48 inches apart, or if they are greater than 48 inches apart. To set the ASA for your system.

- 1 If you are still in the STEP 5 THX setup menu from the above step, turn the Mode knob until the display reads ADJ SPKR ARY (Adjust Speaker Array), then press the Mode knob. If you are not in the STEP 5 THX setup menu, follow the instructions from step 1 in the section above.
- 2 Turn the MODE knob to select between ASA < 12” (ASA less than 12 inches), ASA 12”-48” (ASA between 12 and 48 inches), and ASA > 48” (ASA greater than 48 inches). Then press the Mode knob.
- 3 To return to other Pro Setup features, turn the Mode knob clockwise until the display’s second line reads BACK TO MAIN and then press the Mode knob. To completely exit the setup menu, turn the Volume knob.

DTS LFE Settings

The Cinema Rhapsody permits the adjustment of the DTS LFE level prior to the summing of the bass information from all speakers that are set to small. This LFE level adjustment applies only to DTS decoding modes. When listening to DTS encoded software, you may notice a preponderance of bass as compared to non-DTS material. Based on laboratory testing, ADA has determined that some DTS material has an increased LFE level of 10dB. As such, the Cinema Rhapsody Mach II offers a setup feature that permits you to minimize the LFE signal from DTS encoded material. With this feature enabled, as you change between DTS and non-DTS decoding, you will not need to make on-going adjustments to your systems bass and subwoofer settings.

The Out of the Box setup for this feature is turned off (FLAT). In order for this setting to take effect, you must first Enable the feature as outlined in the first section on this page, DTS LFE Adjustment Enable. You can then proceed with the second section on this page, DTS LFE Adjustment. The range of this adjustment is from -20dB to 0db. The Out of the Box configuration for DTS LFE Adjustment is -10dB. If you are planning on making an adjustment to the DTS LFE level, ADA recommends doing so while playing a DTS encoded source with the Cinema Rhapsody Mach II in a DTS mode. While enabling this feature and setting the level to 0dB are in effect the same as setting the Enable option from on (ATTN) to off (FLAT), the concept of offering a single on/off function, without changing the underlying level, permits the creation of on/off buttons on controls and touch screens. As such, the actual level control remains untouched.

DTS LFE Adjustment Enable

To engage the DTS LFE Attenuation Adjustment:

- 1 Turn the Mode knob clockwise until the display's second line reads SETUP MENU and then press the Mode knob.
- 2 Turn the Mode knob clockwise until the display's second line reads PRO SETUP and then press the Mode knob.
- 3 Turn the Mode knob clockwise until the display's second line reads DTS LFE ENBL and press the Mode knob.
- 4 Turn the Mode knob so that the display's second line reads DTS LFE ATTN if you wish this filter to be on. To turn this feature off, turn the Mode knob so that the display reads DTS LFE FLAT.
- 5 If you selected DTS LFE ATTN, when DTS decoding takes place, the LFE will be lowered by 10dB (Out of the Box setting) prior to the summing of bass information from all the speakers that are set to small. To adjust the actual DTS LFE level, proceed with the steps below. To completely exit the setup menu, turn the Volume knob.

DTS LFE Adjustment

The Out of the Box configuration for DTS LFE Adjustment is -10dB. To change this setting:

- 6 Turn the Mode knob counterclockwise until the display's second line reads DTS LFE ADJ and press the Mode knob.
- 7 Turn the Mode knob to set the desired level for the LFE and then press the Mode knob. Please note, that you may wish to be listening to a DTS source while making this adjustment.
- 8 Press the Mode knob to continue with other Pro Setup options. To completely exit the setup menu, turn the Volume knob.

Tone Controls

In a perfectly acoustic room environment, a THX system (electronics and speakers) would not require any tone control, as the film experience would be delivered across a controlled system, providing a sound field as intended by the film maker. However, in the real world, no room is acoustically perfect. Even in a high-end custom home theater, where special attention has been paid to the room's acoustics, there will still be subtle acoustical issues which will benefit from some slight level of tone control.

The Cinema Rhapsody permits the adjustment of bass and treble levels in what is best described as a parametric tone control, because in addition to setting a level (in dB) for bass and treble, you can also adjust the frequency point for bass and the frequency point for treble. This is a critical feature of the Cinema Rhapsody Mach II, as the tone control takes place in the DSP.

The Cinema Rhapsody also features two tone groups (A & B), where each individual speaker can be assigned to either group A, B, both A & B, or to neither group. The premise for the two tone groups allows you to group like speakers together in two distinct groups, where levels and frequency points are aligned to best contour the speakers. In a THX speaker system, the front right, front center, and front left speakers are typically similar in size, driver configuration, etc,. The same is true for the surround speakers, as they too are typically the same size, driver configuration, etc. As such, you may opt to set the front speakers to group A and the surround speakers to group B. As each group provides a for a unique Bass Frequency & Level and Treble Frequency & Level, you have significant control over the Cinema Rhapsody Mach II's acoustics and as such, the power to correct deficiencies in the room's acoustics.

While Tone presets are discussed in the next section, it is important to note that the Cinema Rhapsody Mach II features four tone presets. Not only do these presets store the frequency and levels of each group, but they also store the speakers assigned to the various groups. As such, you can create some tone presets more ideal for film playback, while other tone presets can be recalled that might be more pleasing for music playback. ADA strongly suggests storing tone presets as you proceed with these adjustments, to preserve the calibrations performed while permitting you to experiment with alternate configurations. As a point of information, Tone Preset 1 is easily recalled under the Channel knob. The other three Tone presets require additional maneuvering, also under the Channel knob.

Tone Presets - Out of the Box

ADA has designed four tone presets as shown in the chart below. These Tone Presets may be useful to you as you select to customize your home theater with tone control. As such, you may actually skip the Speaker Group setup entirely by first recalling one of these four presets. Please note, that while the presets do have frequency settings in place, all levels are set flat to 0dB. At the very least, you will need to adjust the levels to hear any effect these presets may have on improving your home theater sound.

GROUP A			SPEAKER GROUP A						TREB A	TREB A	BASS A	BASS A
(X=SPKR ACTIVE)	C	S	L	R	SL	SR	BL	BR	FREQ	LEVEL	FREQ	LEVEL
TONE PRESET 1	X	X	X	X	X	X	X	X	6KHZ	0DB	260HZ	0DB
TONE PRESET 2	X	-	X	X	-	-	-	-	12KHZ	0DB	120HZ	0DB
TONE PRESET 3	-	-	X	X	-	-	-	-	12KHZ	0DB	120HZ	0DB
TONE PRESET 4	X	-	X	X	X	X	X	X	12KHZ	0DB	120HZ	0DB
GROUP B			SPEAKER GROUP B						TREB B	TREB B	BASS B	BASS B
(X=SPKR ACTIVE)	C	S	L	R	SL	SR	BL	BR	FREQ	LEVEL	FREQ	LEVEL
TONE PRESET 1	-	-	-	-	-	-	-	-	6KHZ	0DB	260HZ	0DB
TONE PRESET 2	-	-	-	-	X	X	X	X	8KHZ	0DB	180HZ	0DB
TONE PRESET 3	X	-	-	-	X	X	X	X	8KHZ	0DB	180HZ	0DB
TONE PRESET 4	X	-	X	X	X	X	X	X	8KHZ	0DB	180HZ	0DB

The thinking behind these four presets is:

Tone Preset 1 - All speakers are active to only Speaker Group A. Here, one can simply adjust levels up and down for bass and treble, effecting all speakers.

Tone Preset 2 - The front three speakers are on Group A (where the center channel is more similar in size, driver configuration, etc. to the front right and left speakers) and the surround speakers are on Group B. Note that the front speakers have different frequency points and that the subwoofer is not active in either Speaker Group.

Tone Preset 3 - Only the front right and left speakers are on Group B. This setup takes into consideration a system where the center speaker is more similar in size, driver configuration, etc. to the surround speakers. Note that the front speakers have different frequency points and that the subwoofer is not active in either Speaker Group.

Tone Preset 4 - Here all speakers are active on both Tone Groups A and B, which also have different frequency points. As such, this option sets the tone control section up as a four band parametric equalizer. The subwoofer is not active in either Speakers Group.

Please note, that the primary preset and current Cinema Rhapsody Mach II setting is Tone Preset 1. Here all speakers are assigned to Group A with a Treble frequency point of 6KHz and a Bass frequency point of 260Hz. Both Treble and Bass levels are defaulted to flat (0dB). As the remote control may offer a Bass and Treble up/down function, these buttons will offer a uniform bass and treble control across all speakers.

If you are interested in the adjustment of the tone levels, ADA suggests first trying the three additional presets shown above. You will want to listen to an actual source component when doing this. If you prefer to assign either Tone Presets 2, 3, or 4 to Tone Preset number 1 (thereby erasing the current Tone Preset 1), you can do so. This is discussed under Storing Tone Presets.

If you choose to use one of these presets as a basis for setting tone levels in your home theater, thereby skipping the Speaker Group setup, continue with the next section, Recalling Tone Presets.

Recalling Tone Presets

To recall the Tone Preset 1:

- 1 Turn the Channel knob until the display reads PUSH RECALLS TONE PRESET 1 and then press the Channel knob.

To recall any of the four Tone Presets:

- 1 Turn the Channel knob until the display reads RECALL/STORE TONE PRESETS and press the Channel knob.
- 2 Turn the Channel knob so that the display's top line reads RECALL while the second line reads the TONE PRESET number you wish to recall and then press the Channel knob.

At this time, you can choose to modify the Speaker Groupings or skip directly to Treble and Bass adjustment.

Speaker Groups

In this section, we will determine which speakers are in Group A and which speakers are in Group B. Please note, that there are no set rules here. A speaker can be disengaged from both groups so that it is not effected at all by any tone control. Alternately, speakers can be engaged to both tone groups. Here you can set the frequency points for treble and bass to different values (as well as different levels), providing a four-band tone equalizer. As such, you will want to give some thought to this feature prior to randomly proceeding. To include/exclude speakers from the tone groups.

- 1 Turn the Channel knob clockwise until the display's second line reads TONE GROUP A and then press the Channel knob.
- 2 The top line of the display will indicate a channel (speaker) and if it is IN or OUT of Tone Group A. To include or exclude this speaker from Tone Group A, press the Channel knob.
- 3 Turn the Channel knob clockwise one click so that the top line of the display moves to the next channel. Again press the Channel knob to either include or exclude this channel from Tone Group A.
- 4 Repeat step 3 for all channels in Tone Group A. To return to the previous menu option, turn the Channel clockwise until the display's second line reads BACK TO MAIN. To completely exit this setup menu, turn the Volume knob.
- 5 Turn the Channel knob clockwise until the display's second line reads TONE GROUP B and then press the Channel knob.
- 6 The top line of the display will indicate a channel (speaker) and if it is IN or OUT of Tone Group B. To include or exclude this speaker from Tone Group B, press the Channel knob.
- 7 Turn the Channel knob clockwise one click so that the top line of the display moves to the next channel. Again press the Channel knob to either include or exclude this channel from Tone Group B.
- 8 Repeat step 7 for all channels in Tone Group B. To return to the previous menu option, turn the Channel clockwise until the display's second line reads BACK TO MAIN. To completely exit this setup menu, turn the Volume knob.

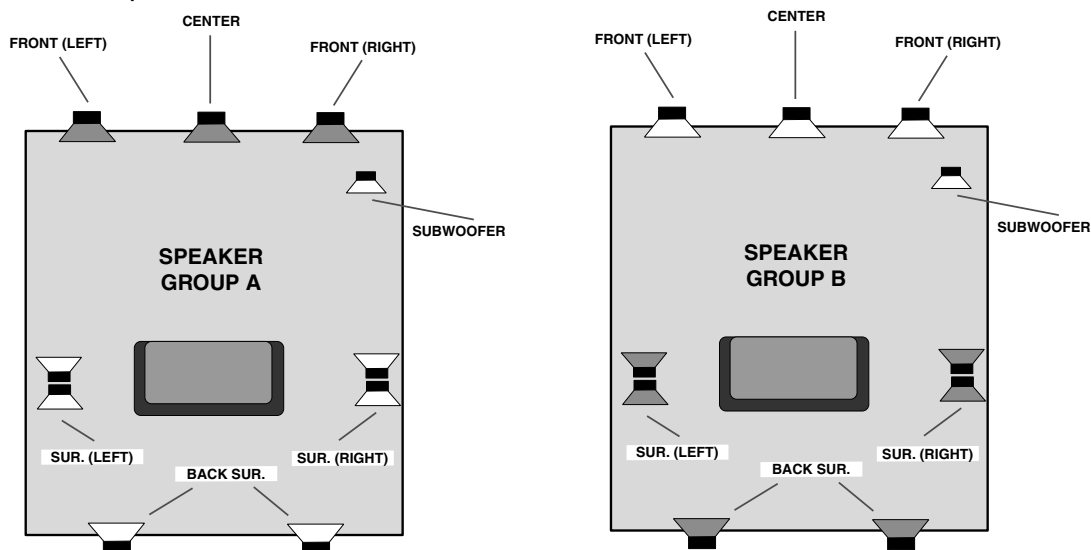

Treble Group A

In this section, we will set the Treble Level and Frequency point for Treble Group A.

- 1 Turn the Channel knob clockwise until the display's second line reads TREB GROUP A and then press the Channel knob.
- 2 The top line of the display will read TREB GROUP A and the second line will display the LEVEL in DB. To skip the Level adjustment and move directly to adjustment of the treble frequency, skip to step 3. To adjust the Treble Level, press the Channel knob and then dial in the level you desire using the Channel knob (-20dB to +20dB). When set, press the Channel knob.
- 3 Turn the Channel knob one click such that the display's top line reads TREB GROUP A and the second line reads FREQ in K HZ. To skip the Frequency adjustment and move directly to adjustment of Bass Group A, skip to step 4. To adjust the Treble Frequency, press the Channel knob and then dial in the frequency you desire using the Channel knob (1KHz to 30KHz). When set, press the Channel knob.
- 4 Turn the Channel knob clockwise until the display's second line reads BACK TO MAIN and press the Channel knob.

Bass Group A

In this section, we will set the Bass Level and Frequency point for Bass Group A.

- 5 Turn the Channel knob clockwise until the display's second line reads BASS GROUP A and then press the Channel knob.
- 6 The top line of the display will read BASS GROUP A and the second line will display the LEVEL in DB. To skip the Level adjustment and move directly to adjustment of the bass frequency, skip to step 7. To adjust the BASS Level, press the Channel knob and then dial in the level you desire using the Channel knob (-20dB to +20dB). When set, press the Channel knob.
- 7 Turn the Channel knob one click such that the display's top line reads BASS GROUP A and the second line reads FREQ in HZ. To skip the Frequency adjustment and move directly to adjustment of Treble Group b, skip to step 8. To adjust the Bass Frequency, press the Channel knob and then dial in the frequency you desire using the Channel knob (20Hz to 980Hz). When set, press the Channel knob.
- 8 Turn the Channel knob clockwise until the display's second line reads BACK TO MAIN and press the Channel knob.

Treble Group B

In this section, we will set the Treble Level and Frequency point for Treble Group B.

- 9 Turn the Channel knob clockwise until the display's second line reads TREB GROUP B and then press the Channel knob.
- 10 The top line of the display will read TREB GROUP B and the second line will display the LEVEL in DB. To skip the Level adjustment and move directly to adjustment of the treble frequency, skip to step 11. To adjust the Treble Level, press the Channel knob and then dial in the level you desire using the Channel knob (-20dB to +20dB). When set, press the Channel knob.

- 11 Turn the Channel knob one click such that the display's top line reads TREB GROUP B and the second line reads FREQ in K HZ. To skip the Frequency adjustment and move directly to adjustment of Bass Group B, skip to step 12. To adjust the Treble Frequency, press the Channel knob and then dial in the frequency you desire using the Channel knob (1KHz to 30KHz). When set, press the Channel knob.
- 12 Turn the Channel knob clockwise until the display's second line reads BACK TO MAIN and press the Channel knob.

Bass Group B

In this section, we will set the Bass Level and Frequency point for Bass Group A.

- 13 Turn the Channel knob clockwise until the display's second line reads BASS GROUP B and then press the Channel knob.
- 14 The top line of the display will read BASS GROUP B and the second line will display the LEVEL in DB. To skip the Level adjustment and move directly to adjustment of the bass frequency, skip to step 15. To adjust the BASS Level, press the Channel knob and then dial in the level you desire using the Channel knob (-20dB to +20dB). When set, press the Channel knob.
- 15 Turn the Channel knob one click such that the display's top line reads BASS GROUP B and the second line reads FREQ in HZ. To skip the Frequency adjustment and move directly to storing these settings in a Tone Preset, skip to step 16. To adjust the Bass Frequency, press the Channel knob and then dial in the frequency you desire using the Channel knob (20Hz to 980Hz). When set, press the Channel knob.
- 16 Turn the Channel knob clockwise until the display's second line reads BACK TO MAIN and press the Channel knob.

Storing Tone Presets

In this section, we will set store the Speaker Groups, Treble adjustments, and Bass adjustments in a Tone Preset. Remember that when you Store a Tone Preset, it will overwrite the original Out of the Box (or previous) Tone Preset settings.

- 17 Turn the Channel knob counterclockwise until the display reads RECALL/STORE TONE PRE-SETS and press the Channel knob.
- 18 Turn the Channel knob clockwise until the top line reads STORE. With the top line of the display reading STORE, turn the Channel knob and select a TONE PRESET number. Then press the Channel knob to store the Speaker Groups and Tone Adjustments on this Tone Preset #. Please note, that this will replace the current settings for this Tone Preset.
- 19 To completely exit RECALL/STORE TONE PRESETS menu, turn the Volume knob.

Volume Setups

Once all of the system features have been set, you can proceed to set volume related features on the Cinema Rhapsody Mach II. The order for these settings is specific. Follow the steps below in order to best setup the Cinema Rhapsody Mach II.

Storing Volume Presets

The Cinema Rhapsody Mach II features four volume presets. These are easily stored and can be used to quickly recall different volume levels depending on how loud you want the system to play. One way to recall a Volume preset is to set a one of the four Volume Presets as the Turn On Volume Level. Whenever the Cinema Rhapsody is turned on, this Volume Preset will be recalled. Volume Presets 1 and 2 can be easily recalled under the Channel. All volume presets can be recalled in a slightly more involved manner, also under the channel. All four volume presets can also be programmed into a remote control or control system for one button recall.

- 1 To store a Volume Preset, first engage the system to a playing input and adjust the volume using the Master Volume Control.
- 2 Turn the Channel knob clockwise until the display reads RECALL/STORE VOL PRESETS and press the Channel knob.
- 3 Turn the Channel knob clockwise until the display's top line reads STORE while the second line reads the VOL PRESET number you wish to store the volume level on and press the Channel knob.
- 4 Turn the Volume knob to exit this setup menu.

At this time you have stored a Volume Preset. You can now repeat these steps for other Volume Presets.

Recalling Volume Presets

To recall Volume Presets 1 or 2:

- 1 Turn the Channel knob until the display reads PUSH RECALLS VOL PRESET 1 or PUSH RECALLS VOL PRESET 2 and press the Channel knob.

To recall any Volume Preset:

- 1 Turn the Channel knob until the display reads RECALL/STORE VOL PRESETS and press the Channel knob.
- 2 Turn the Channel knob clockwise until the display's top line reads RECALL while the second line reads the VOL PRESET number you wish to recall and press the Channel knob.

Turn-On Volume Level Setup

The Cinema Rhapsody features a Turn-On Volume Level which is engaged every time the Cinema Rhapsody is first turned on. The Turn-On Volume level is based on one of the four Volume Presets. You can also opt to use the alternate setting, Last Used, which is also the Out of the Box setting. To change the Turn On Volume from Last Used to a specific Volume Preset level:

- 1 Turn the Mode knob clockwise until the display's second line reads SETUP MENU and then press the Mode knob.

- 2 Turn the Mode knob clockwise until the display's second line reads TURNON VOL and press the Mode knob.
- 3 Turn the Mode knob to select either LASTUSE or RECALL1 through RECALL4.
- 4 Turn the Volume knob to completely exit the setup menu.

Maximum Volume Level

The Cinema Rhapsody Mach II also permits you to set the systems Maximum Volume Level. This will prevent the system from ever playing too loud, averting distortion or damage to the speakers. The Out of the Box default setting is left wide-open to the maximum available +31.5dB level.

- 1 To set this level it is advised to play an input (digital) and test the system to determine the loudest level you ever wish the system to play at, note this volume level, and then lower the Master Volume control.
- 2 Turn the Mode knob clockwise until the display's second line reads SETUP MENU and then press the Mode knob.
- 3 Turn the Mode knob clockwise until the display's second line reads VOLUME MAX and press the Mode knob.
- 4 Turn the Mode knob counterclockwise to the level that your noted in step 1.
- 5 Turn the Volume knob to completely exit the setup menu.

Analog Gain

As you change from digital input labels to analog input labels, often the volume level may vary. The Cinema Rhapsody features an Analog Input Gain control that can be set individually per input labels linked to analog audio inputs. Here you can alter the level of analog input between -10dB and +10dB. The Out of the Box setting for all input labels is 0dB (or no gain). To assist you in making certain that the level selected is optimal, the Cinema Rhapsody will prompt you if the gain level is causing clipping.

- 1 To set this level you will first need to select the analog component and engage it into play.
- 2 Turn the Mode knob clockwise until the display's second line reads SETUP MENU and then press the Mode knob.
- 3 Turn the Mode knob clockwise until the display's second line reads ANALOG GAIN and press the Mode knob.
- 4 If the component you are playing is louder when compared to digital components, lower the Analog Gain level by turning the Mode knob counterclockwise. If the component is playing softer than digital components, slowly raise the analog gain by turning the Mode knob clockwise. If you raise this level too high, the display will indicate clipping. ADA suggests lowering the gain so that clipping does not occur.
- 5 Turn the Input knob to exit the setup menu. Select another analog input label and repeat steps 2-4.

Channel Volume Adjustment

The Cinema Rhapsody also permits you to adjust volume levels of specific channels while you are listening to a component. This will allow you to for example, raise the center channel volume level, if the movie you are watching has dialogue that is not loud enough.

To access any of the eight channels and raise or lower their levels:

- 1 Turn the Channel knob clockwise until the display's second line reads PUSH TO EDIT while the top line indicates the channel you can select and its current volume level in DB. Then press the Channel knob.
- 2 Turn the Channel knob to raise or lower the channel's volume level.
- 3 To proceed to alter other channel levels, press the Channel knob, then turn the Channel knob to the next channel you wish to alter and press the Channel knob to repeat step 2. To exit this menu, turn any knob other than the Channel knob.

Solo Mode

The Cinema Rhapsody Mach II features a testing mode that is unique to ADA. Solo Mode permits you to have just one speaker playing while all other channels are muted. In order to achieve this on lesser preamps, you would need to lower the level of all channels and then raise just the channel you wish to hear. In Solo Mode, you can select just one channel and easily switch between single channels.

Solo Mode is useful when trying to determine if you have a damaged speaker or driver. It is also useful for determining if a speaker is out of phase with the other speakers.

Solo Mode is also ideal when trying to get an understanding of how multi-channel recordings are mixed, as you can select to listen to just one channel at a time. This is particularly useful when playing multi-channel music recordings.

To fully understand the use of Solo Mode and the power of multi-channel music, ADA suggests playing the DTS version of the Eagles "Hell Freezes Over" CD or DVD. The DTS version of these discs contains a bonus track, "Seven Bridges Road". Please note, that this is a 5.1 mix and not a 7.1 mix. As such, it is best to select a DTS playback mode that leaves the back surrounds off, at least for a Solo Mode test. In this powerful mix, each of the Eagles band members is recorded on his own speaker channel; five band members hence the five channels.

Begin to listen to the track and about halfway through, return to the beginning and enter the Solo Mode. As you skip through the various channels, you will notice just how discrete each vocalist is. As you return to playing all channels at once, you will have realized firsthand, the power of multi-channel music as the harmonies on this recording are blending, not in some mixing console, but live, in your home theater.

To activate Solo Mode:

- 1 Turn the Channel knob clockwise until the display reads PUSH TO EDIT SOLO MODE, then press the Channel knob.
- 2 Turn the Channel knob to select the channel you wish to isolate and listen to. To return to the previous menu level, turn the Channel knob clockwise until the second line of the display reads BACK TO MAIN and press the Channel knob. To completely exit this setup menu, turn any knob other than Channel.

RS-232 Control Options

The Cinema Rhapsody Mach II is capable of being fully controlled via RS-232, providing status feedback of all preamplifier aspects. This makes the Cinema Rhapsody Mach II ideal for integration with advanced control systems. It also permits the Cinema Rhapsody Mach II to be setup and controlled from its custom PC software setup and test program (Cinema Ref. II PCOS).

ADA Bus Data Port

The primary two-way data port on the Cinema Rhapsody Mach II is the four-pin screw terminal (ADA Bus) port on the back of the unit. Here, pin 1 is the ground terminal and pin 4 provides power (+15-24VDC). Pin three is the control input (In or RX), taking control signals from external devices for operating functions on the Cinema Rhapsody Mach II. Pin two provides feedback output (Out or TX).

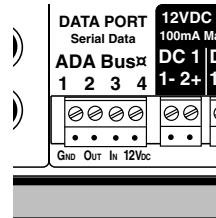

ISO-232 ADA Bus to RS-232 Wired I/O Device

When connecting to a control system (touch-screen based system), you will require an ADA Bus to RS-232 convertor box, ADA's ISO-232. This device not only permits two-way RS-232 communication but it also incorporates isolation, preventing ground loops in the control system from imposing noise into the Cinema Rhapsody Mach II. The ISO-232's two jumper pins need to be in the horizontal Normal position for communication to occur.

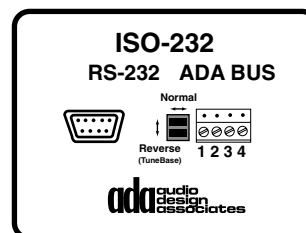

RS-232 Connection & Settings

When only a Cinema Rhapsody Mach II is connected to a control system, the ISO-232 plugs directly into the back of the Cinema Rhapsody Mach II. The control system connects its RS-232 output to the ISO-232 using a straight-through 9-pin D type connector. Do not use a null-modem cable. The Cinema Rhapsody Mach II's communication settings are: 8 Data Bits, 1 Stop Bit, No Parity with either a 1200 or 19200 Baud Rate.

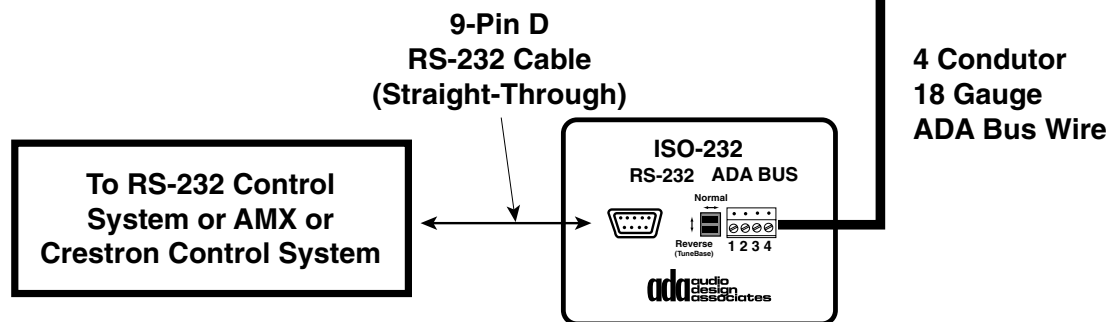
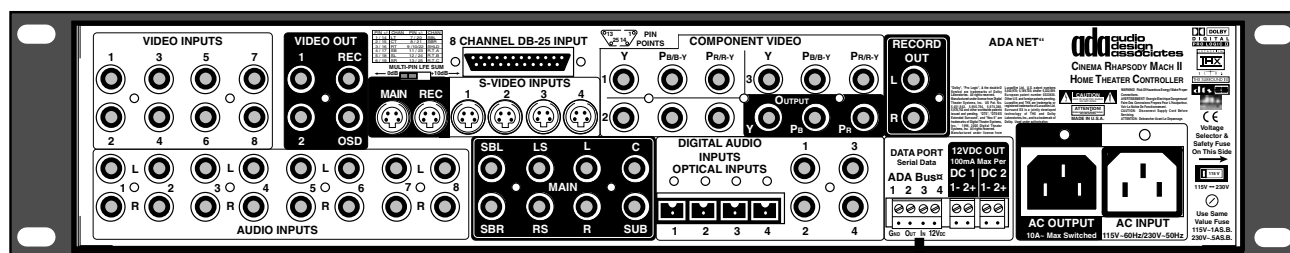

IRT-232 IR Transceiver to RS-232 Wireless I/O Device

The secondary two-way data port on the Cinema Rhapsody Mach II is the IR transceiver located in the front panel. Not only does this transceiver receive infrared commands, it also transmits the Cinema Rhapsody's feed back out in IR form. Using an ADA IRT-232 IR Transceiver to RS-232 hand-held box, you can run the Cinema Ref II PCOS software on your lap-top PC and communicate to the Cinema Rhapsody Mach II without any hardwired connections, directly through the Cinema Rhapsody's front panel. When using the IRT-232, the Cinema Rhapsody Mach II must be set to a Baud Rate of 1200 Baud with the front panel IR Active.

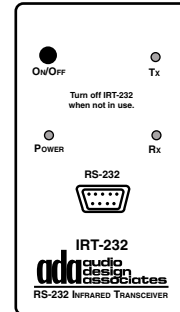

PC Setup & Control Software

The Cinema Ref. II PCOS software is ideal for setup and calibration of the Cinema Rhapsody. While all setup operations in this technical manual are capable of being fully executed using the front panel knobs on the Cinema Rhapsody Mach II, the PC software will most definitely reduce the time spent programming the unit. It permits you to program: the editing of input labels; assigning A/V jacks and default modes to input labels; setting up speaker groups, tone frequency points, tone levels, and setting tone presets; speaker size setup and crossover; channel levels and balance presets, delay levels; bass limiter and bass management settings; all volume related adjustments and all volume preset features. Furthermore, the software permits configurations to be saved internal to the PC for use at a later time. The software permits you to fully control the Cinema Rhapsody Mach II even after your setup is complete. You can communicate to the Cinema Rhapsody Mach II from your PC through a hardwired connection using an ADA ISO-232 (at either 1200 or 19200 Baud) or wireless through the units front panel IR Transceiver using an ADA IRT-232 (1200 Baud Only - IR Transceiver must be active).

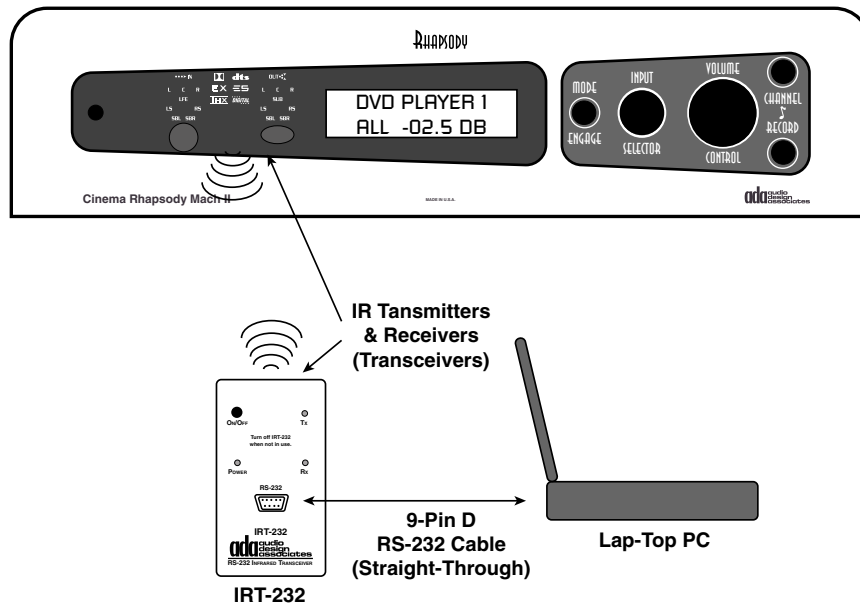

For those who desire to capture IR commands into learning remotes, in particular IR commands that are not available in the IR remote control that ships with the Cinema Rhapsody Mach II, ADA suggests using your PC, the Cinema Ref II PCOS software, and an IRT-232. Any button press in the PC software is translated to an infrared command which can readily be captured instead.

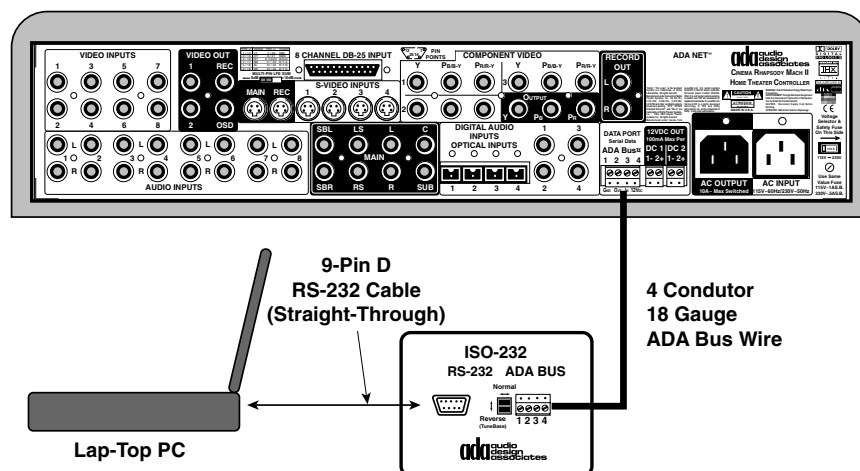

External IR Receiver Options

ADA manufactures two different IR receivers that can be connected to the Cinema Rhapsody Mach II. When using an external IR receiver, ADA recommends turning off (Inactive) the Cinema Rhapsody's front panel IR transceiver.

IRT-3000 IR Transceiver

The IRT-3000 is both an IR receiver and emitter (transceiver) much like the front panel IR transceiver. The IRT-3000 fits a single-gang decora plate and can be remotely located away from the equipment rack. The IRT-3000 should be wired with an ADA Bus cable (3 conductor, 18 gauge, tin-coated copper wire, with an overall braided shield that is a 90% braid - specifically by name, ADA Bus wire). You can connect the IRT-3000 to the Cinema Rhapsody Mach II directly into the preamplifier's rear panel ADA Bus connector. You can also connect the IRT-3000 to an ADA Bus jack on either the WH-2000 or WH-3000, which is then connected to the Cinema Rhapsody. You can use the IRT-3000 with the IRT-232 and your PC. As such, if the Cinema Rhapsody is located in an equipment closet away from the theater room, you can still communicate two-way wireless, from your PC, providing you aim the IRT-232 (connected to your PC) to the in-wall IRT-3000. ADA also offers a single-gang metal decora box for IRT-3000's that are intended to sit on a bookshelf or cabinet.

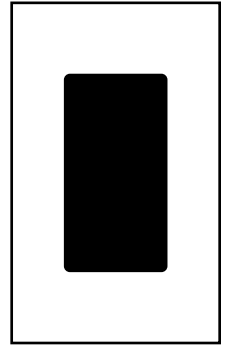

Cinema Rhapsody Mach II

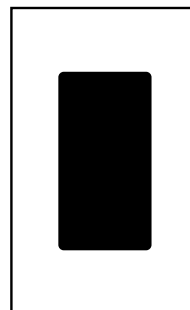
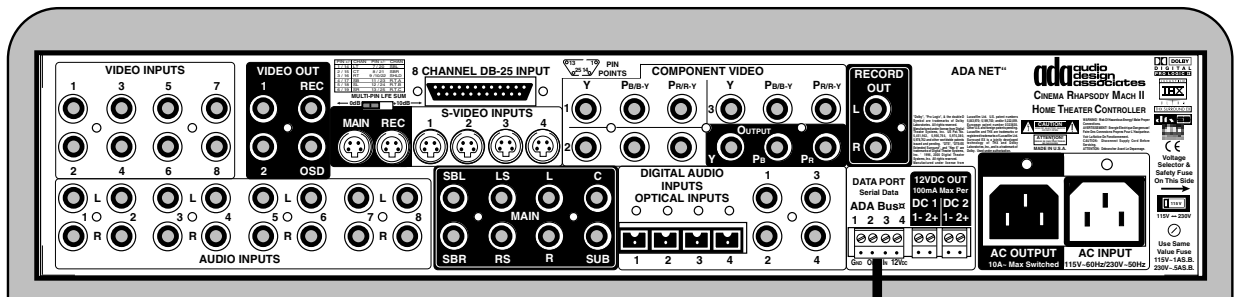

**IRT-3000
IR Transceiver
(Single-Gang Decora)**

IRR-5000 IR Receiver

The IRR-5000 is a peep-hole size IR receiver that features an RJ-45 jack and is run to the equipment rack via Cat. 5 cable. In order to connect the IRR-5000 to the Cinema Rhapsody Mach II, you will require a WH-2000 Cat-Link Wire Harness. The WH-2000 features both ADA Bus and RJ-45 connectors and is required if you are going to use the IRR-5000. The IRR-5000, unlike the IRT-3000, is a receiver only, one-way IR receiver. You can control the Cinema Rhapsody Mach II, but you will not be able to get feedback from the Cinema Rhapsody Mach II out of the IRR-5000.

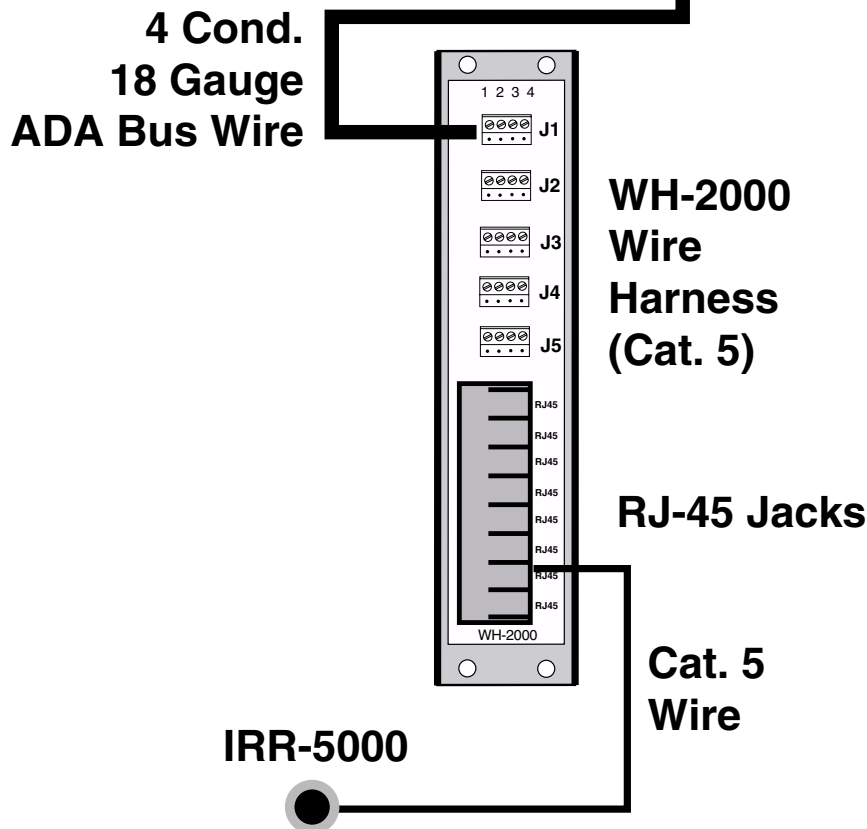
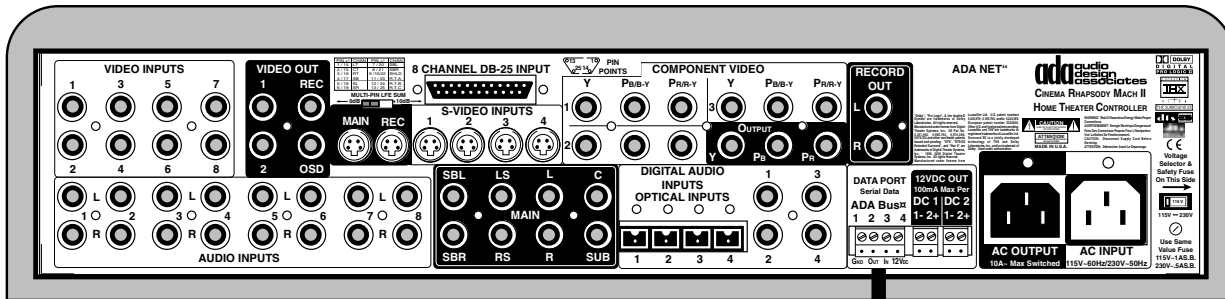
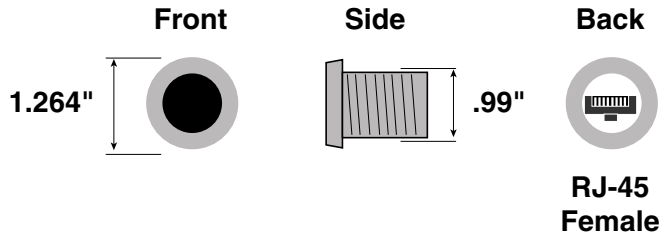

BRT-1 Baud Rate Translator

The BRT-1 is used when your Cinema Rhapsody is set to run at 19200 for control system reasons, yet you also wish to control the unit via IR. The BRT-1 will upconvert a 1200 Baud IR signal to 19200 Baud. It does not down-convert a 19200 signal to 1200 and as such, will only permit the Cinema Rhapsody to receive commands. It will not down-convert feedback to IR. The BRT-1 is a passive device that connects to an open ADA Bus port on the ADA Bus wire harness. It does not require any additional settings.

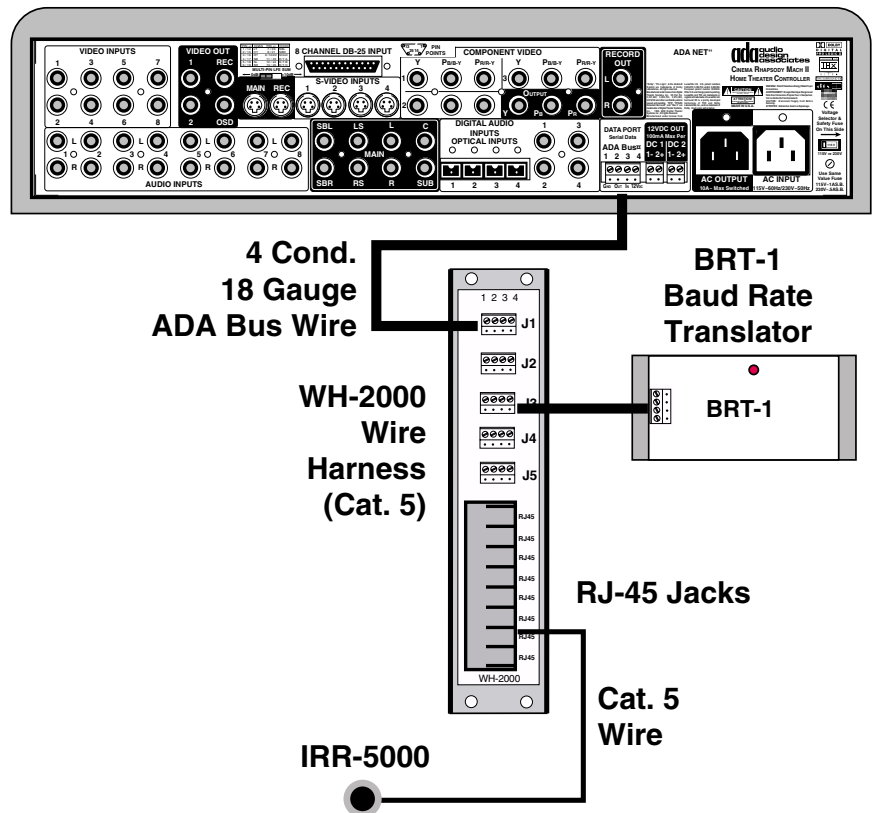
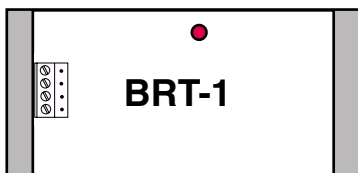

Baud Rate Setup

ADA provides two operating speeds (baud rates), either 1200 Baud or 19200 Baud. While 19200 Baud enables faster control and feedback, it will eliminate the ability to control the Cinema Rhapsody Mach II from being controlled via an infrared (unless you add a BRT-1 Baud Rate Translator to the system). At 1200 Baud, a 40KHz IR carrier is capable of being attached to the Cinema Rhapsody's Hex control strings, hence creating an IR command. This command can be learned into most learning IR remote controls. However, these IR remote controls cannot capture or pass an IR signal with a baud rate of 19200. The BRT-1 can be added to systems that need to operate at 19200 but it is important to note that you can opt to run the Cinema Rhapsody Mach II at 1200 baud without compromising system features.

The Out of the Box default is 1200 Baud. To set the Cinema Rhapsody Mach II's Baud Rate:

- 1 Turn the Mode knob clockwise until the display's second line reads SETUP MENU and press the Mode knob.
- 2 Turn the Mode knob clockwise until the display's second line reads PRO SETUP and press the Mode knob.
- 3 Turn the Mode knob clockwise until the display's second line reads NETWORK BAUD and press the Mode knob.
- 4 Turn the Mode knob to select between 1200 MODE or 19.2K MODE. Press the Mode knob to continue with other setups. To completely exit the setup menu, turn the Volume knob.

IR Transceiver (Front Panel) Settings

When connecting the Cinema Rhapsody Mach II to an external control system, you may run into a data conflict resulting from sending data into the Cinema Rhapsody while it's front panel IR transceiver is active. If you are having difficulty establishing communication with the Cinema Rhapsody Mach II serially, ADA suggests turning the Cinema Rhapsody's front panel IR transceiver off.

The Out of the Box default is set so that the IR Transceiver is active. To alter the Cinema Rhapsody Mach II's IR Transceiver's state (On or Off):

- 1 Turn the Mode knob clockwise until the display's second line reads SETUP MENU and press the Mode knob.
- 2 Turn the Mode knob clockwise until the display's second line reads IR REMOTE and press the Mode knob.
- 3 Turn the Mode knob to select between IR REMOTE IS ACTIVE and IR REMOTE IS INACTIVE. Press the Mode knob to continue with other setups. To completely exit the setup menu, turn the Volume knob.

Address Setup

The Cinema Rhapsody Mach II can be set to a myriad of addresses in the event multiple Cinema Rhapsody's are connected to the same network. As such, one can connect a single ISO-232 to the control system and communicate independently to all Cinema Rhapsody Mach II's. In order to prevent conflicts here, each Cinema Rhapsody Mach II needs to be set to a unique address (there are 256 available addresses). A point of caution is worth noting here. The concept of putting multiple Cinema References on the same network, works best if they are in the same location (i.e. central equipment rack). Second, the units should all be set to run at the optimal baud rate of 19200. Finally, be certain that your control system is capable of handling the amount of feedback from the units in the event they are turned on or updating in short order. A single Cinema Rhapsody Mach II will update approximately 1.5K Bytes of data during boot-up (or update request). Multiply this by the number of units on the network and you have a fair amount of data. and some control system buffers may overload. If you wish to connect your PC to a multiple network, it is worth noting that you can actually select which Cinema Rhapsody you wish to communicate with by selecting the corresponding address in the PC software provided. Because ADA recommends that you run the Cinema Rhapsody Mach II's at 19200 Baud, you cannot expect to use the IRT-232 to communicate with your PC via IR.

The Out of the Box default address is set to 0. The IR remote controls included with the Cinema Rhapsody only work if the unit is set to address 0. Altering the address will cause this remote control to no longer function. To alter the Cinema Rhapsody Mach II's Address:

- 1 Turn the Mode knob clockwise until the display's second line reads SETUP MENU and press the Mode knob.
- 2 Turn the Mode knob clockwise until the display's second line reads PRO SETUP and press the Mode knob.
- 3 Turn the Mode knob clockwise until the display's second line reads NETWORK BUS and press the Mode knob.
- 4 Turn the Mode knob to select an alternate address. Press the Mode knob to continue with other setups. To completely exit the setup menu, turn the Volume knob.

Cinema Rhapsody Mach II (Address 0)

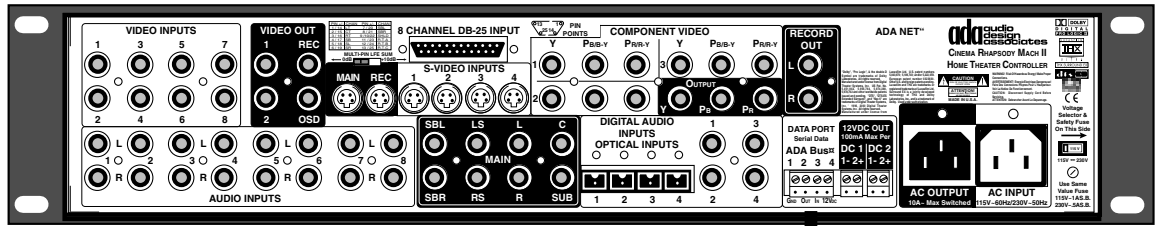

Cinema Rhapsody Mach II (Address 1)

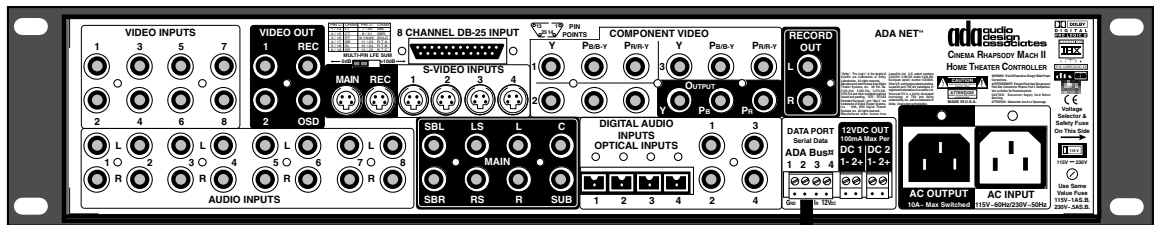

Cinema Rhapsody Mach II (Address 2)

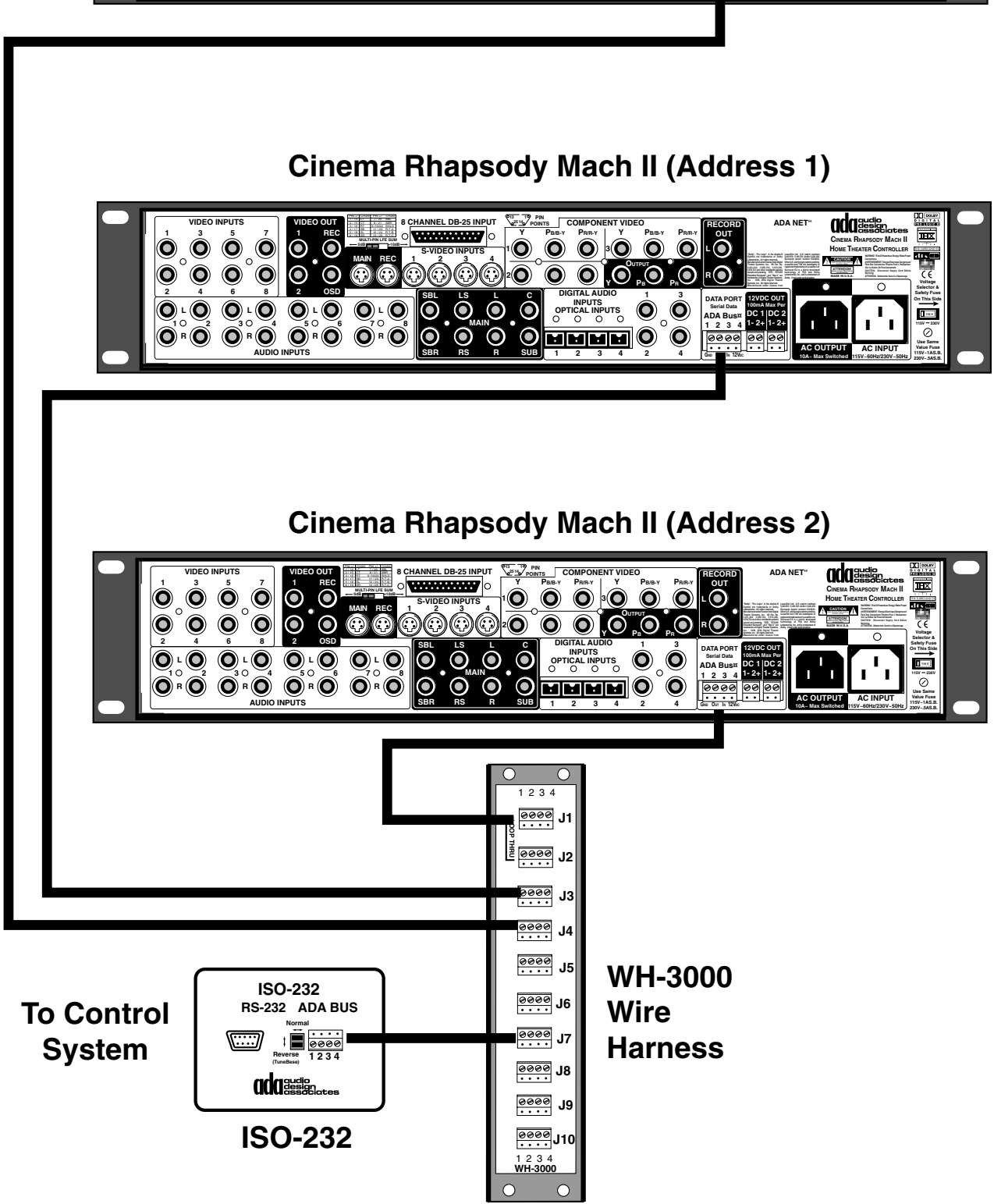
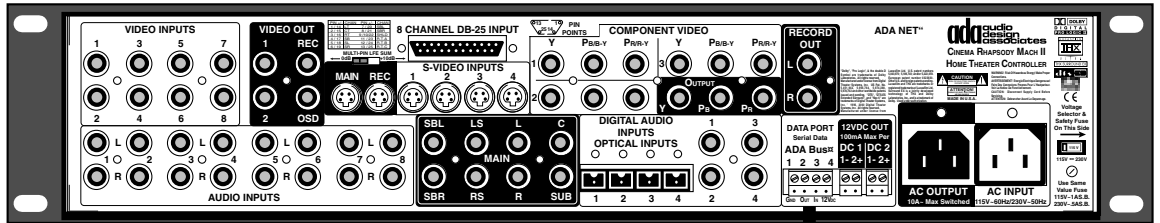

To Control System

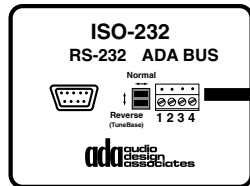

ISO-232

WH-3000 Wire Harness

Output Channel Indicator Lamps

The Cinema Rhapsody Mach II is extremely flexible when it comes to decoding today's advanced multi-channel digitally encoded signals. While the process of selecting decoding modes on its surface may appear confusing, there are several aspects of decoding that the Cinema Rhapsody Mach II does automatically. To even further simplify the mode selection process, ADA has also included several default options that will make it easy to operate.

The Cinema Rhapsody Mach II features Channel and Mode indication lamps which will make it easy to understand the type of input signal, how it was encoded, how many channels are present, and to how many channels are playing in the system. Prior to proceeding with a discussion on the mode and input channel lamps, it is important that you already determined the number of the speakers in your system. This is discussed under Speaker Setup 1. Please note, that the output lamps will only illuminate active speaker channels based on this setup. Furthermore, all active channels will only have their lamps on if a mode is selected that is designed to play to all speakers. For a 7.1 speaker setup, the back surround lamps will only illuminate if an EX/ES Mode is selected while playing multi-channel material or Quad/Hex (or Neo-6) for two-channel material. If you have all speakers engaged by you selected a Stereo Mode, only the right, left, and subwoofer Output lamps would be on.

7.1 Channel Speaker Array

Here, the system will include three speakers in the front of the room (left, center, and right channels), two surround speakers (typically dipole in nature, placed to the left and right side of the seating area), two back surround speaker (left and right against the back of the theater), and a subwoofer(s). The subwoofer represents the “.1” and the other channels represent the “7”. Here the Output channel indicator will display all channels, providing the correct mode is selected.

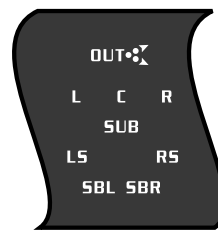

6.1 Channel Speaker Array

In a 6.1 speaker array, only one back surround speaker exists, typically centered along the back wall of the theater. In this case, the Output channel indicator will only display the SBL leaving the SBR lamp off, providing the correct mode is selected. This indicates that the system has been setup for only one Surround Back channel.

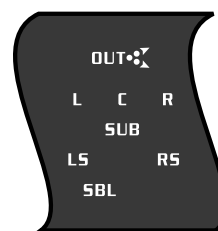

5.1 Channel Speaker Array

This speaker array was the most common configuration prior to the introduction of THX EX. Here, the system will consist of three speakers across the front of the room (left, center, right), two surround speakers, and a subwoofer(s).

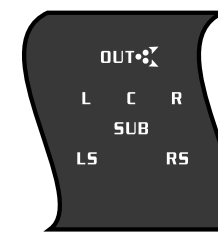

4.1 Channel Speaker Array

In a 4.1 speaker array, the system is void of a center channel speaker. If the room environment cannot support the placement of a center channel speaker, the center channel will be turned off so its information can be redirected to the front left and right speakers. While this is not the most ideal situation, turning off the center channel will ensure that no signal is lost. Here the Output channel indicators will show the absence of the center channel while indicating the presence of the front left and right, as well as surround left and right and subwoofer. As a point of information, when running surround back speakers, either one or two, these channels will indicate as described above, providing the correct mode is selected.

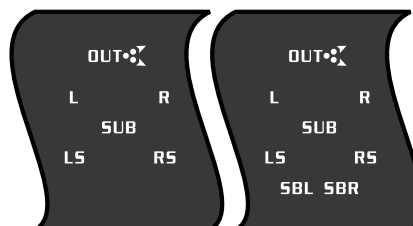

Mode Selection

The Cinema Rhapsody Mach II is first and foremost an auto-detecting processor. As such, when it receives an input signal, it will automatically determine its makeup and in turn, engage the appropriate decoding mode. There are three primary types of signals that the Cinema Rhapsody is capable of decoding, a Dolby Digital encoded signal, a DTS encoded signal, and a stereo or mono audio signal (PCM digital audio {Pulse Code Modulation} or analog audio).

For discussion in this manual, Dolby Digital and DTS are referred to as Cinema Modes (although they are also used for music playback). Cinema decoding modes differ significantly from 2 Channel modes, where there are 27 options when playing a stereo signal, there are only 9 Cinema mode options when playing Dolby Digital or DTS encoded material. While this seems unusual, the fact is that most of the critical settings are automatic when playing a Dolby Digital or DTS source, because the complex bit stream contains significant information that permits the Cinema Rhapsody Mach II to play the material to perfection. To better understand the Cinema Modes, both Dolby Digital and DTS bit streams will be examined more closely.

When wishing to select a mode

- 1 Turn the Mode knob until the desired mode is on the display's second line and press the mode knob.

When a stereo or mono source is being played, the following 2 Channel modes are active:

Stereo, Mono, DTS Neo 6, DTS Neo 6 THX, Pro Logic II - Pro Logic, Pro Logic II - Pro Logic THX, Pro Logic II Movie, Pro Logic II Movie THX, Pro Logic II Matrix, Pro Logic II Virtual, Pro Logic II Music, Pro Logic II Custom 1, Pro Logic II Custom 1 THX, Pro Logic II Custom 2, Pro Logic II Custom 2 THX, Pro Logic II Custom 3, Pro Logic II Custom 3 THX, Quad/Hex Bypass, Stereo Enhance, Mono Enhance, Stereo 5, Mono 5, Stadium, Theater, Hall, Club, Church.

Please note, that Dolby Digital or DTS audio tracks may only contain a two-channel mix. For some of these tracks, certain rules apply that may limit mode selections. Two channel digital sources may have an encoded flags that will specifically request specific decoding. Some Dolby Digital two channel mixes may specify some type of Pro Logic decoding with the presence of a Pro Logic flag. Some DTS two channel mixes may specify DTS Neo 6 using a similar flag. When listening to a multi-channel encoded source, either Dolby Digital or DTS, the following Cinema modes are available:

Stereo Downmix, Mono Downmix, Discrete & Direct, Discrete, Discrete & THX, Discrete and EX/ES, THX & EX/ES, THX Ultra 2 Cinema, THX Music Mode.

Depending on the type of signal the Cinema Rhapsody Mach II is receiving, only the modes that can be engaged will be available for selection.

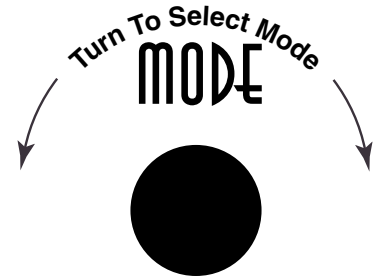

- 1. Dial-In New Mode**
Turn the Mode Selector knob until the second line of the LCD display reads the mode you wish to select. As you turn the knob, you will notice that the top line of the display indicates the current source in play and the second line indicates the modes available. The Cinema Rhapsody will not engage the new mode until Step 2 is accessed.

- 2. Engage New Mode**
Once the second line of the display indicates the next mode you wish to access, press the Mode Selector knob to engage this mode.

Multi-Channel Formats

Dolby Digital and Dolby Digital Surround EX

A Dolby Digital bit stream most typically contains a 5.1 channel mix or upon closer inspection, a 3.2.1.0 mix. To examine this further, the 3 refers to the front three channels (left, center, right), the 2 refers to the surround channels (left and right), and the 1 or “.1” refers to the subwoofer (also often called LFE - Low Frequency Effects). While there are other options for mixing Dolby Digital (older movies that were never mixed in multi-channel but play off a DVD are often encoded in Dolby Digital, as 2.0.0.0 or stereo), most material is available in a 5.1 format.



Dolby Digital Surround EX is best described as an enhancement to Dolby Digital. Here a mono signal is embedded into the discrete surround left and right channels. This signal creates an image in the back of the room, between the surround left and right channels. If a film has been encoded in Dolby Digital Surround EX, the digital bit stream will contain a “flag” which tells the Cinema Rhapsody Mach II that it has been specifically mixed and mastered to take into consideration a playback system that has one or two surround back speakers. While a standard 5.1 mix can be engaged to play through a 7.1 or 6.1 speaker system, Dolby Digital Surround EX material is specifically mastered for these systems. In the event that you have only a 5.1 speaker array in your system and you are playing a Surround EX DVD, the Cinema Rhapsody Mach II will redirect this information to the surround speakers in place. Please note, that even a Dolby Digital Surround EX signal is still only considered to be a 5.1 channel mix (or 3.2.1.0) because the surround back channel is not discrete.



DTS, DTS ES Matrix, and DTS ES Discrete

DTS, much like Dolby Digital is most frequently mixed in a 5.1 format or 3.2.1.0. Also, similar to Dolby Digital Surround EX, material encoded with a DTS ES Matrix will contain a flag in the digital bit stream that indicates that this material was specifically mixed with a mono surround back image contained in the left and right surround channels. While this mix is intended to play through a 7.1 or 6.1 speaker array, it is still only a 5.1 (or 3.2.1.0) mix in that there are only six discrete encoded channels.

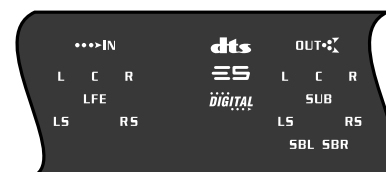

DTS ES Discrete is a more involved encoding format in that it is a true 7.1 or eight channel mix. Here there are two additional channels in the bit stream and the source material is a true 3.2.1.2 mix, where the last 2 refers to the additional two channels for surround back left and right. In the event you are playing a source encoded with DTS ES Discrete through a system that is setup with either a 5.1 or 6.1 speaker array, the Cinema Rhapsody Mach II will redirect the information to either the single surround back speaker or in if it is not present, the two surround back speakers.

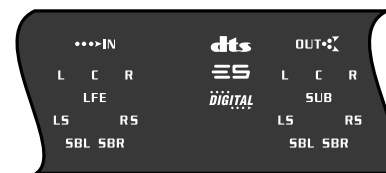

Cinema Modes & Indicator Lamps

Some multi-channel material you play on your home theater system offer only one type of audio track. From a HDTV or DSS broadcast, this will be Dolby Digital. When playing a DVD, you may have several audio track options also known as Language Selections. Most DVD discs indicate the available audio tracks on the back of the disc jacket/box. In order for the Cinema Rhapsody Mach II to decode the audio track you desire, you may need to select this track (Language) prior to playing of the movie. This is typically done in the DVD's menu.

The following describes what the Cinema modes do to the encoded material specified. While output lamp indicators depend on the number of speakers in your system, the discussion here presumes a full 7.1 home theater speaker array.

Dolby Digital 5.1 Surround

Source material encoded in Dolby Digital 5.1 Surround will cause the DOLBY symbol to illuminate along with the DIGITAL symbol. Also, the L, C, R, LFE, LS, RS Input channel indicators will also be lit. The following Output lamps will illuminate depending on the Mode selected.

STEREO DNMX - Stereo Downmix takes the center channel and surround information and sends it to the front left and right speakers. The bass information is sent to subwoofer. - L, R, & SUB Output lamps & channels are on.

MONO DNMX - Mono Downmix sends every channel to just the center speaker. The bass information is sent to subwoofer. - C & SUB Output channel lamps are on.

DIRECT - Sets all speakers to the Large setting and cancels all other filters. This mode is mandated by DTS, not Dolby or THX. ADA does not recommend this mode if your speaker system is not be able to play full range audio through the front and surround speakers. - L, C, R, SUB, LS, RS Output channel lamps are on.

DISCRETE - This is ADA's primary Cinema mode as it does not alter your Speaker Setup and bass filter setups. - L, C, R, SUB, LS, RS Output channel lamps are on.

DISCRETE +THX - This mode applies THX enhancements to the Discrete mode and is ideal for film playback. - L, C, R, SUB, LS, RS Output channel lamps are on. The THX lamp is also on and THX enhancements are engaged.

Dolby Digital 5.1 Stereo Downmix



Dolby Digital 5.1 Mono Downmix

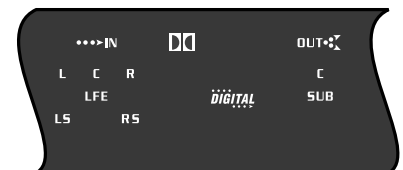

Dolby Digital 5.1 Direct



Dolby Digital 5.1 Discrete

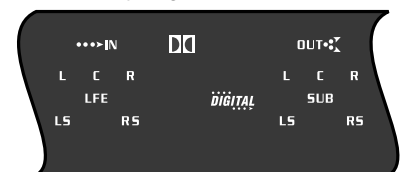

Dolby Digital 5.1 Discrete + THX

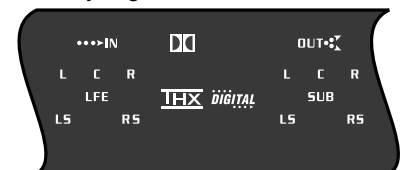

Dolby Digital 5.1 Discrete + EX/ES



DISCRETE +EX/ES - This mode will engage the two back surround speakers which will then receive mono information contained in the left and right surround channels. This mode is ideal when viewing a movie that is Dolby Digital 5.1 encoded (without EX), where still want the additional back surround speakers to be active. - L, C, R, SUB, LS, RS Output channel lamps are on. The EX lamp is also on as are the SBL and SBR channel lamps.

Dolby Digital 5.1 THX + EX/ES



THX +EX/ES - This mode applies THX enhancements to the Discrete +EX/ES mode. - L, C, R, SUB, LS, RS Output channel lamps are on. The EX lamp is also on as are the SBL and SBR channel lamps. The THX lamp is also on and THX enhancements are engaged.

Dolby Digital 5.1 THX Ultra 2

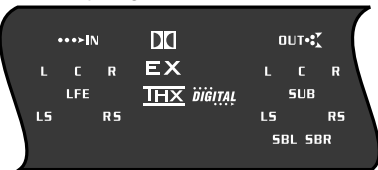

THX ULTRA 2 - This mode is to be used for film playback and also has all channels active, much like EX/ES. It also applies THX Ultra 2 enhancements including those that are set in THX Ultra Setup 5. - L, C, R, SUB, LS, RS Output channel lamps are on. The EX lamp is also on as are the SBL and SBR channel lamps. The THX lamp is also on and THX Ultra 2 enhancements are engaged.

Dolby Digital 5.1 THX Music

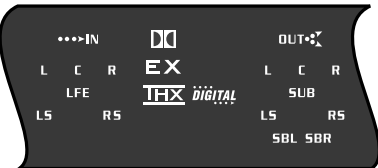

THX MUSIC - This mode is to be used for music playback and also has all channels active, much like EX/ES. It also applies THX Ultra 2 enhancements including those that are set in THX Ultra Setup 5. - L, C, R, SUB, LS, RS Output channel lamps are on. The EX lamp is also on as are the SBL and SBR channel lamps. The THX lamp is also on and THX Ultra 2 Music enhancements are engaged.

Dolby Digital Surround EX

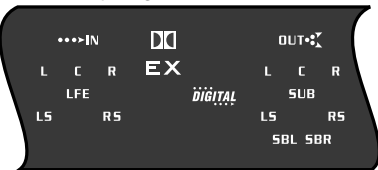

Dolby Digital Surround EX

Source material encoded in Dolby Digital Surround EX will cause the DOLBY and EX symbols to illuminate along with the DIGITAL symbol. While you can force the EX symbol to appear with standard Dolby Digital 5.1 material by selecting an EX/ES mode, a DVD track that is specifically encoded with EX, will cause the EX lamp to engage when on the more basic DISCRETE mode. This indication confirms that this audio track is a true (flagged) EX mix. Also, the L, C, R, LFE, LS, RS Input channel indicators will also be lit. The Output lamps will illuminate depending on the Mode selected as described in the previous section under Dolby Digital 5.1.

DTS 5.1 Surround

Source material encoded in DTS 5.1 Surround operate in a manner similar to Dolby Digital 5.1 Surround material. When playing software encoded in DTS 5.1 Surround, the DTS lamp will illuminate along with the L, C, R, LFE, LS, and RS Input lamps. Selecting a more basic Discrete mode will engage the L, C, R, SUB, LS, and RS Output lamps.

Again, like Dolby Digital 5.1 material, selecting an EX/ES mode will send audio to the back surround speakers activating the ES lamp as well as L, C, R, LFE, LS, RS, SBL, and SBR Output channel lamps. This feature performs similar to the EX feature for Dolby Digital 5.1 tracks. Also, like Dolby Digital 5.1 material, selecting a THX or THX Ultra 2 mode will engage the appropriate THX enhancements and activate the THX indicator lamp.

DTS ES Matrix

Much like Dolby Digital Surround EX, DTS ES Matrix encoded material contains the ES flag in the digital bit stream, indicating that this track was specifically mixed on a system with back surround speakers. When on a more basic Discrete mode, playing a disc track that contains an ES flag, will cause the DTS and ES symbols to illuminate along with the Digital symbol. The number of Output channels is not effected by the ES flag unless and EX/ES or THX Ultra 2 mode is selected. Then the BSL and BSR Output channel lamps will engage with audio from the back surround speakers. Again, like DTS 5.1 Surround, Dolby Digital 5.1 Surround, or Dolby Digital Surround EX, all Cinema Mode features, as previously described, are available.

DTS ES Discrete

A disc containing a DTS ES Discrete audio track is unlike the other 5.1 or 5.1 with EX/ES encoding formats. DTS ES Discrete material has a sixth discrete channel in addition to LFE. Hence it is a true 6.1 format. Furthermore, the decoding process electronically manipulates this channel such that it acts more like a full seven channel system in addition to LFE (7.1). At the time of this printing, DTS ES Discrete material is the only software that provides a true eight channel input.

When playing a DTS ES Discrete audio track, the Cinema Rhapsody Mach II will detect the ES Discrete flag in the digital bit stream. If you are on even the more basic Discrete mode, the Cinema Rhapsody Mach II indicate all channels; L, C, R, LFE, SL, SR, SBL, and SBR on the Input channel lamps. This is the only time that the SBL and SBR Input channel lamps will engage. Furthermore, because of the presence of the DTS ES Discrete flag, the ES indicator will also engage in addition to the L, C, R, SUB, SL, SR, SBL, and SBR Output channel lamps. Note, that with DTS ES Discrete material, you do not need to select an EX/ES or THX Ultra 2 mode in order to engage the back surround channels. For this decoding format, all Cinema modes, as previously described apply.

DTS 5.1 Surround Direct or Discrete



DTS 5.1 Surround Discrete +EX/ES

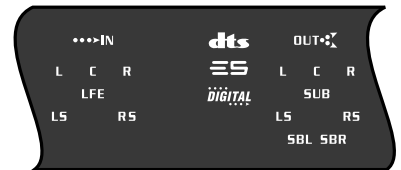

DTS Matrix ES Discrete

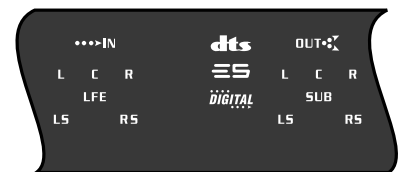

DTS Matrix ES Discrete +EX/ES

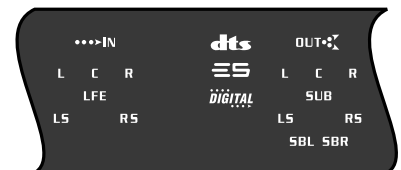

DTS ES Discrete

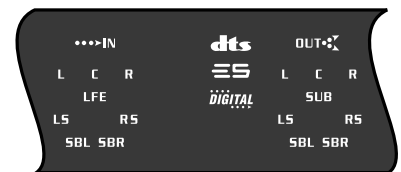

Two Channel Modes & Indicator Lamps

Dolby Surround 2.0

While many discs offer an alternate stereo Dolby Digital track, often older films on DVD only feature this track, as these movies were never mastered in more than two channels. The Cinema Rhapsody Mach II indicates this type of audio track by illuminating only the L & R Input channel lamps along with the Dolby Digital lamp. If you see this combination when playing a DVD of a more current film, one which most likely features the more advanced 5.1 mix, chances are that you may have selected the wrong audio track (Language) in the DVD's title menu. Prior to proceeding with the film, confirm the proper audio track selection. Please note, that the 2.0 indication may occur as the movie loads, prior to the opening scene, even if you have made certain that the 5.1 track has been selected.

Because Dolby Surround 2.0 is only a two-channel mix, the Cinema Modes are no longer available. Here, you now have the ability to select from the 27 Two-Channel Mode options.

PCM Digital Audio

PCM digital audio (Pulse Code Modulation) is the stereo audio that is digitally encoded onto CDs and laser discs, as well as the audio output of some broadcast receivers. For standard PCM digital audio, no prior decoding takes place to derive the stereo signal (as in Dolby Surround 2.0). Again, the Cinema Rhapsody features 27 decoding modes for PCM digital audio.

Analog Audio (Stereo or Mono)

Just like PCM digital audio, the same 27 Two-Channel modes available for PCM digital audio (and Dolby Surround 2.0) are available here as well.

When the Cinema Rhapsody does detect a Dolby or DTS two-channel mix as well as when the unit simply detects no encoding at all (complete absence of a Dolby or DTS bit stream), the Cinema modes are defeated and the two channels modes are engaged. The Input Channel lamp will illuminate just the L & R channel lamps. If you are on an analog input, the Digital symbol will turn off. Here, the following modes are available and the output lamps correspond to the mode selected.

STEREO - This two channel mode will active only the left and right speakers along with the subwoofer. The L, R, and SUB Output channel lamps will also illuminate.

MONO - In this mode, only the center channel and the subwoofer are active. If a stereo signal is in play, both right and left channels mix to mono and play through the center speaker. The C and SUB Output channel lamps are on.

DTS NEO 6 - DTS Neo 6 is one of the few Two Channel modes that will permit you to engage your entire speaker array (7.1) when playing a two channel source. Here, the L, C, R, SUB, LS, RS, SBL, and SBR Output channel lamps are on and all speakers are active.

DTS NEO6+THX - This mode is the same as DTS Neo 6 and includes the addition of THX enhancements. Here, the L, C, R, SUB, LS, RS, SBL, and SBR Output channel lamps are on, all speakers are active, and the THX symbol is illuminated.

Dolby Surround 2.0 Pro Logic Movie

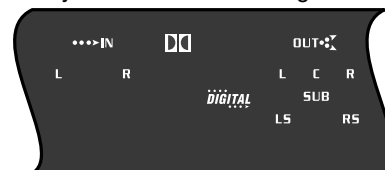

PCM Digital Audio Pro Logic Movie

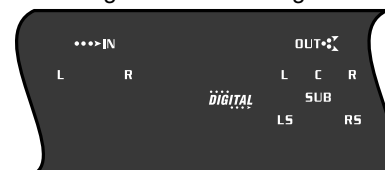

Analog Audio Pro Logic Movie

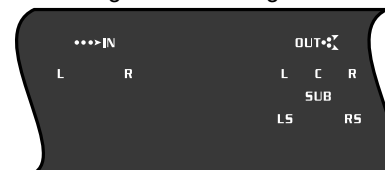

PROLOGIC - Pro Logic decoding is a matrix decoding mode for two-channel sound-tracks and works best with material that was specifically encoded in Dolby Surround. Here the surround channels have a mono, not stereo type of sound field. Here, the L, C, R, SUB, LS, and RS Output channel lamps are on.

PROLOGIC THX - This mode is the same as Pro Logic and includes the addition of THX enhancements. Here, the L, C, R, SUB, LS, and RS Output channel lamps are on, all speakers are active, and the THX symbol is illuminated.

PLII MOVIE - Pro Logic II Movie decoding is an advanced matrix decoding mode for two-channel film sound-tracks and is optimized for programs or movies that are encoded in Dolby Surround. Here the surround speakers have greater spatial separation, providing a more stereo like sound field. This mode is also appropriate for video games. This mode retains the important features of Pro Logic, but with full-bandwidth stereo surround output, the listening experience is much closer to the sound you get from Dolby Digital. Here, the L, C, R, SUB, LS, and RS Output channel lamps are on.

PLII MVE + THX - This mode is the same as Pro Logic II Movie and includes the addition of THX enhancements. This is also an excellent mode for film playback when THX enhancements are preferred. Here, the L, C, R, SUB, LS, and RS Output channel lamps are on, all speakers are active, and the THX symbol is illuminated.

PLII MATRIX - Pro Logic II Matrix produces surround sound from mono material. Here, the L, C, R, SUB, LS, and RS Output channel lamps are on.

PLII VIRTUAL - Pro Logic II Virtual is the same as the Movie mode but here, no delay is applied to the surround channels. - Here, the L, C, R, SUB, LS, and RS Output channel lamps are on.

PLII MUSIC - Pro Logic II Music creates a rich and enveloping surround ambience from stereo sources such as CDs. In Pro Logic II Music mode, three controls permit you to fine-tune the sound-field.

CENTER WIDTH control allows you to gradually spread the center channel sound into the front left and right speakers. At its widest setting, all the sound from the center is mixed into the left and right. This control may help achieve a more spacious sound or a better blend of the front image.

PANORAMA wraps the sound of the front left and right speakers around you for an exciting perspective.

DIMENSION control which adjusts the front/back balance to suit your taste.

To adjust Center Width, Panorama, or Dimension Control:

- 1 Select an Input label that is playing music and press the Input knob. (You will want to be listening to a source component as you make the following changes).
- 2 Turn the Mode knob until the display's second line reads PLII MUSIC and press the Mode knob.
- 3 Turn the Mode knob clockwise until the display's second line reads SETUP MENU and press the Mode knob.

- 4 Turn the Mode knob one click so that the display's second line reads PLII OPTIONS and press the Mode knob.
- 5 The second line of the display will now read PANORAMA. To alter the Panorama settings, press the Mode knob. To alter another setting skip to Step 7. To completely exit the setup menu, turn the Volume knob.
- 6 Turn the Mode knob to either turn Panorama ON or OFF. Then press the Mode knob.
- 7 Turn the Mode knob one click so that the display's second line reads CENTER WIDTH. To alter the Center Width settings, press the Mode knob. To alter another setting skip to Step 9. To completely exit the setup menu, turn the Volume knob.
- 8 Turn the Mode knob to alter the Center Width setting from 0 to 7, in increments of 1. When you are done, press the Mode knob.
- 9 Turn the Mode knob one click so that the display's second line reads DIMENSION. To alter the Dimension settings, press the Mode knob. To return to the previous setup menu option, turn the Mode knob clockwise until the display's second line reads BACK TO MAIN and press the Mode knob. To completely exit the setup menu, turn the Volume knob.
- 10 Turn the Mode knob to alter the Dimension settings from 0 to 7 in increments of 1. Then press the Mode knob. To return to the previous setup menu option, turn the Mode knob clockwise until the display's second line reads BACK TO MAIN and press the Mode knob. To completely exit the setup menu, turn the Volume knob.

PLII CUSTOM1, PLII CUSTOM2, PLII CUSTOM3 - The Cinema Rhapsody Mach II features three Pro Logic II modes that are completely custom in nature, permitting you complete control over all Pro Logic II features. For each of these three modes, you can create different settings so that as you switch between these modes, the sound field alters. These modes are ideal for music playback but can also be used for custom sound fields when watching sporting events. The features that can be altered here include:

CENTER WIDTH control allows you to gradually spread the center channel sound into the front left and right speakers. At its widest setting, all the sound from the center is mixed into the left and right. This control may help achieve a more spacious sound or a better blend of the front image.

PANORAMA wraps the sound of the front left and right speakers around you for an exciting perspective.

DIMENSION control which adjusts the front/back balance to suit your taste.

AUTO BALANCE - When the auto balance is on, the Cinema Rhapsody Mach II compensates for the discrepancies in the left and right channels.

SURROUND DELAY - When surround delay is on, the delays for the surround channels are activated.

SURROUND FILTERS - There are three surround filters which in the Cinema Rhapsody's menu are marked 0,1, & 2. 0 refers to all filters off, where the surround channels receive full range audio. 1 refers to the low pass filter being active and set to 7KHz (as in the Pro Logic mode). 2 refers to the high pass filter and shelf filter being active. You can select one of the three options under this setting.

RS INVERTED - When this setting is on, the polarity of the right surround sound speaker is inverted.

COEF MATRIX - There are three surround filters which in the Cinema Rhapsody's menu are marked 0,1, & 2. 0 refers to a setting most in line with traditional Pro Logic decoding with a more mono surround image. 1 is used in creating virtual, music, movie, and matrix modes where a more stereo like image is applied to the surround channels. 2 is used with modes where the panorama option is enabled, thereby providing the wrap-around effect.

ADA suggests altering these settings while you are listening to a two channel source (CD). To adjust these settings:

- 1 Select an Input label that is playing music and press the Input knob. (You will want to be listening to a source component as you make the following changes).
- 2 Turn the Mode knob until the display's second line reads PLII CUSTOM1 (2 or 3) and press the Mode knob.
- 3 Turn the Mode knob clockwise until the display's second line reads SETUP MENU and press the Mode knob.
- 4 Turn the Mode knob one click so that the display's second line reads PLII OPTIONS and press the Mode knob.
- 5 The second line of the display will now read PANORAMA. To alter the Panorama settings, press the Mode knob. To alter another setting skip to Step 7. To completely exit the setup menu, turn the Volume knob.
- 6 Turn the Mode knob to either turn Panorama ON or OFF. Then press the Mode knob.
- 7 Turn the Mode knob one click so that the display's second line reads CENTER WIDTH. To alter the Center Width settings, press the Mode knob. To alter another setting skip to Step 9. To completely exit the setup menu, turn the Volume knob.
- 8 Turn the Mode knob to alter the Center Width setting from 0 to 7, in increments of 1. When you are done, press the Mode knob.
- 9 Turn the Mode knob one click so that the display's second line reads DIMENSION. To alter the Dimension settings, press the Mode knob. To alter another setting skip to Step 11. To completely exit the setup menu, turn the Volume knob.
- 10 Turn the Mode knob to alter the Dimension setting from 0 to 7, in increments of 1. When you are done, press the Mode knob.

- 11 Turn the Mode knob one click so that the display's second line reads AUTO BALANCE. To alter the Auto Balance setting, press the Mode knob. To alter another setting skip to Step 13. To completely exit the setup menu, turn the Volume knob.
- 12 Turn the Mode knob to set the Auto Balance ON or OFF, then press the Mode knob.
- 13 Turn the Mode knob one click so that the display's second line reads SURR DELAY. To alter the Surround Delay setting, press the Mode knob. To alter another setting skip to Step 15. To completely exit the setup menu, turn the Volume knob.
- 14 Turn the Mode knob to set the Surround Delay ON or OFF, then press the Mode knob.
- 15 Turn the Mode knob one click so that the display's second line reads SURR FILTER. To alter the Surround Filter setting, press the Mode knob. To alter another setting skip to Step 17. To completely exit the setup menu, turn the Volume knob.
- 16 Turn the Mode knob to select the Surround Filter setting you desire (0, 1, or 2), then press the Mode knob.
- 17 Turn the Mode knob one click so that the display's second line reads RS INVERTED. To alter the polarity of the Right Surround speaker, press the Mode knob. To alter another setting skip to Step 19. To completely exit the setup menu, turn the Volume knob.
- 18 Turn the Mode knob to set the RS INVERTED ON or OFF, then press the Mode knob.
- 19 Turn the Mode knob one click so that the display's second line reads COEF MATRIX. To alter the Matrix Coefficient setting, press the Mode knob. To completely exit the setup menu, turn the Volume knob.
- 20 Turn the Mode knob to select the Matrix Coefficient setting you desire (0, 1, or 2), then press the Mode knob. To return to the previous setup menu option, turn the Mode knob clockwise until the display's second line reads BACK TO MAIN and press the Mode knob. To completely exit the setup menu, turn the Volume knob.

You can repeat these steps for the two additional PLII CUSTOM modes.

PLII CM1+THX, PLII CM2+THX, PLII CM3+THX - These modes apply THX enhancements to the three custom Pro Logic II modes you created. Here, the L, C, R, SUB, LS, and RS Output channel lamps are on and all speakers are active.

Proprietary Two Channel ADA Modes

QUAD BYPASS - Quad Bypass is a proprietary ADA Mode that will permit you to engage your entire speaker array (7.1) when playing a two channel source. Quad Bypass is ideal for music playback and utilizes the entire sound field. Here, the L, C, R, SUB, LS, RS, SBL, and SBR Output channel lamps are on and all speakers are active.

STEREO ENH - Stereo Enhance is a proprietary ADA Mode that is applied to two channel signal and is useful for playback of source material with relatively weak stereo separation. There are two adjustments that can be made to the Stereo Enhance mode, Effect Delay and Effect Level. When Stereo Enhance is engaged, the Effect Delay setting (0-20 ms range) is applied to the left channel, leaving the right channel untouched, all prior to Pro Logic decoding. The Effect Level can best be described as the throttle for the decoding circuit. The Effect Level has a range from -20dB to +20dB. At +20dB, the Stereo Enhance mode has its effect set to maximum where at -20dB, the effect is least present. You can sample changes to the Effect Delay and the Effect level as they are being made. Here, the L, C, R, SUB, LS, and RS Output channel lamps are on.

To alter the Effect Delay and Level for Stereo Enhance:

- 1 Select an Input label that is playing a two channel signal and press the Input knob. (You will want to be listening to a source component as you make the following changes).
- 2 Turn the Mode knob until the display's second line reads STEREO ENH and press the Mode knob.
- 3 Turn the Mode knob clockwise until the display's second line reads SETUP MENU and press the Mode knob.
- 4 Turn the Mode knob so that the display's second line reads STEREO ENHNC and press the Mode knob.
- 5 The second line of the display will now read LEVEL. To alter the Effect Level settings, press the Mode knob. To alter the Effect Delay setting skip to Step 7. To completely exit the setup menu, turn the Volume knob.
- 6 Turn the Mode knob to set the Effect Level between -20dB to +20dB. Then press the Mode knob.
- 7 Turn the Mode knob one click so that the display's second line now reads DELAY and press the Mode knob.
- 8 Turn the Mode knob to set the Effect Delay between 0ms and 20ms. Then press the Mode knob.
- 9 To continue with other setup menu options, turn the Mode knob clockwise until the display's second line reads BACK TO MAIN and press the Mode knob. To completely exit the setup menu, turn any knob other than the Mode knob.

MONO ENH - Mono Enhance is a proprietary ADA Mode that is applied to a mono signal and is useful for playback of source material with no stereo separation. There are two adjustments that can be made to the Mono Enhance mode, Effect Delay and Effect Level. In this mode, the two channels are first mixed mono together, then the mono enhancement feature is applied, with the delay set to the left channel (after mixing down to mono) and prior to the Pro Logic decoding. This permits the Mono Enhance mode to deliver surround sound with depth and feel, even though the input signal is mono and during standard Dolby Pro Logic playback, would only provide audio out of the center channel. The Effect Level can best be described as the throttle for the decoding circuit. The Effect Level has a range from -20dB to +20dB. At +20dB, the Mono Enhance mode has its effect set to maximum where at -20dB, the effect is least present. You can sample changes to the Effect Delay and the Effect level as they are being made. Here, the L, C, R, SUB, LS, and RS Output channel lamps are on.

To alter the Effect Delay and Level for Mono Enhance:

- 1 Select an Input label that is playing a mono signal and press the Input knob. (You will want to be listening to a source component as you make the following changes).
- 2 Turn the Mode knob until the display's second line reads MONO ENH and press the Mode knob.
- 3 Turn the Mode knob clockwise until the display's second line reads SETUP MENU and press the Mode knob.
- 4 Turn the Mode knob so that the display's second line reads MONO ENHANCE and press the Mode knob.
- 5 The second line of the display will now read LEVEL. To alter the Effect Level settings, press the Mode knob. To alter the Effect Delay setting skip to Step 7. To completely exit the setup menu, turn the Volume knob.
- 6 Turn the Mode knob to set the Effect Level between -20dB to +20dB. Then press the Mode knob.
- 7 Turn the Mode knob one click so that the display's second line now reads DELAY and press the Mode knob.
- 8 Turn the Mode knob to set the Effect Delay between 0ms and 20ms. Then press the Mode knob.
- 9 To continue with other setup menu options, turn the Mode knob clockwise until the display's second line reads BACK TO MAIN and press the Mode knob. To completely exit the setup menu, turn any knob other than the Mode knob.

Fun Modes

The Cinema Rhapsody Mach II also features seven Fun Modes that may prove interesting to you.

Stereo 5, Mono 5, Stadium, Theater, Hall, Club, & Church

STEREO 5 - Stereo 5 is only capable of being engaged when playing two-channel source material. This mode applies the stereo image across the entire sound field and will also play out of the back surround speakers. Here, the L, C, R, SUB, LS, RS, SBL, and SBR Output channel lamps are on.

MONO 5 - Mono 5 is only capable of being engaged when playing two-channel source material. This mode applies a mono image across the entire sound field and will also play out of the back surround speakers. Here, the L, C, R, SUB, LS, RS, SBL, and SBR Output channel lamps are on.

The other five Fun Modes are room type modes; Stadium, Theater, Hall, Club, and Church. Unlike either Cinema Modes which are specific to only multi-channel digital source material or Two Channel Modes which are specific to only stereo or mono source material, these five Fun Modes can be applied to all types of material playing through the Cinema Rhapsody Mach II (with the exception of DVD Audio or SACD).

STADIUM - This mode is supposed to sound like a stadium and is useful for playback of a concert or sporting event. Here, the L, C, R, SUB, LS, and RS Output channel lamps are on.

THEATER - This mode is supposed to sound like a theater and is useful for playback of plays or operas. Here, the L, C, R, SUB, LS, and RS Output channel lamps are on.

HALL - This mode is supposed to sound like a hall and is useful for playback of chamber music. Here, the L, C, R, SUB, LS, and RS Output channel lamps are on.

CLUB - This mode is supposed to sound like a dance club and is useful for playback of music videos and other dance music. Here, the L, C, R, SUB, LS, and RS Output channel lamps are on.

CHURCH - This mode is supposed to sound like a church and is useful for playback of choral music. Here, the L, C, R, SUB, LS, and RS Output channel lamps are on.

When playing a non-multi-channel source, to select one of these modes:

- 1 Turn the Mode knob until the display's second line reads the desired mode and press the Mode knob.

When playing a multi-channel source (i.e. DVD), these modes can also be applied. Please note, that when selecting any of these modes, the multi-channel signal is first down-mixed to two-channel prior to the mode effects being applied. This implies, that a 5.1 source is first mixed to 2.0 and then delivered in 5.1 output. While the output is 5.1, the discrete input channels are no longer discrete on the output. Here, the L, C, R, SUB, LS, and RS Output channel lamps are on.

On Cinema Rhapsody Mach II preamplifiers with a Release Version of 3.46 or less, these five modes are not accessible directly when playing a multi-channel source. To determine the Release Number, turn the Cinema Rhapsody Mach II completely off and then turn it on again. The Release Number will briefly appear on the front panel display. To access these modes, you need to:

- 1 Pause your player such that 5.1 material is no longer detected by the Cinema Rhapsody Mach II.
- 2 Turn the Mode knob until the display's second line reads one of these room type modes (Stadium , Theater, Hall, Club, or Church) and press the Mode knob.
- 3 Press play on your DVD player, reactivating the 5.1 signal.
- 4 Turn the Mode knob until the display's second line reads STEREO DNMX and press the Mode knob.

Dolby Digital 5.1 Stereo Downmix

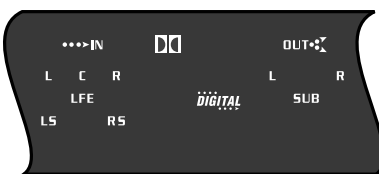

At this time, the selected room type mode will engage. Please note, that when selecting STEREO DNMX, where the two-channel mode for this input label is something other than Stadium , Theater, Hall, Club, or Church, the Output channel lamps typically indicate only L, R, and SUB channel lamps.

Dolby Digital 5.1 Stereo Downmix with Room Type Mode (Stadium, Theater, Hall, Club, or Church)

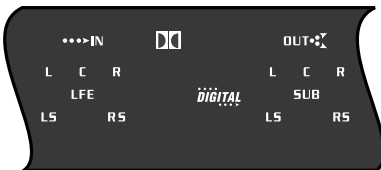

When the input labels two-channel mode is set to one of these room type modes, the Output channel lamps now indicate L, C, R, SUB, LS, and RS when the STEREO DNMX mode is activated on a 5.1 source. This indicates that a room type mode is engaged.

On Cinema Rhapsody Mach II preamplifiers with a Release Number greater than 3.46, these five modes can be directly accessed while actively playing a 5.1 source. To determine the Release Number, turn the Cinema Rhapsody Mach II completely off and then turn it on again. The Release Number will briefly appear on the front panel display. To engage the room-type modes:

- 1 Turn the Mode knob until the display reads the desired room type mode (STADIUM DNMX, THEATER DNMX, HALL DNMX, CLUB DNMX, or CHURCH DNMX) and then press the Mode knob.

THX Enhancements

For either Dolby Digital, Dolby Digital EX, DTS, or DTS ES, THX enhancements can be turned on or off. If THX is present, the THX mode lamp will be lit.

When playing a two channel source signal, the IN indicator will display the L and R for Left and Right. The only mode lamp that might be illuminated is THX, identifying the engagement of THX enhancements.

Please note, the Cinema Rhapsody Mach II does not detect the presence of THX as it is not an encoded process but rather an enhancement process. Use THX mode for any cinematic sources. THX certification to video tapes, laser discs, and DVDs is intended to ensure that the material was properly mixed and transferred and does not directly relate to the THX certification of the Cinema Rhapsody. To engage either full-blown THX or THX Re-EQ, you must do so manually on the Cinema Rhapsody.

THX is an exclusive set of standards and technologies established to make your experience of the film soundtrack as faithful as possible to what the director intended. Movie soundtracks are mixed in special movie theaters called dubbing stages and are designed to be played back in movie theaters with similar equipment and conditions. The soundtrack created for the movie theater is then transferred directly onto Laserdisc, VHS tape, DVD, etc., and is not changed for playback in a small home theater environment. THX engineers developed patented technologies to accurately translate the sound from the movie theater environment into the home, correcting the tonal and spatial errors that occur. When the THX mode is on, the following three THX technologies are automatically added after the decoded signal:

Re-Equalization™ - The tonal balance of a film soundtrack will be excessively bright and harsh when played back over audio equipment in the home because the film soundtracks were designed to be played back in large movie theatres using very different professional equipment. Re-Equalization restores the correct tonal balance for watching a movie soundtrack in a small home environment.

Timbre Matching™ - The human ear changes our perception of a sound depending on the direction from which the sound is coming. In a movie theater, there is an array of surround speakers so that the surround information is all around you. In a home theater, you use only two speakers located to the side of your head. The Timbre Matching feature filters the information going to the surround speakers so that they more closely match the tonal characteristics of the sound coming from the front and surround speakers.

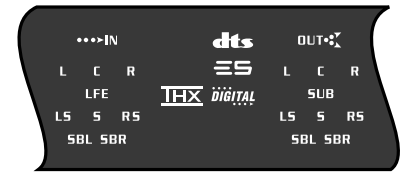

Adaptive Decorrelation™ - In a movie theater, a large number of surround speakers help create an enveloping surround sound experience, but in a home theater there are usually, only two speakers. This can make the surround speakers sound like headphones that lack spaciousness and envelopment. The surround sounds collapse into the closest speaker as you move away from the middle seating position. Adaptive Decorrelation slightly changes on surround channel's time and phase relationship with respect to the other surround channel. This expands the listening position and creates--with only two speakers--the same spacious surround experience as in a movie theater.

When you select a mode that includes THX Enhancements, all three enhancements are active (On). When you select a non-THX mode, these filters are off.

While the THX modes permit instant access to certain THX enhancements, the Cinema Rhapsody Mach II also permits you to selectively turn the Re-EQ, Timbre Match, and Decorrelation enhancements to on or off. If you are interested in adjusting the effects of Re-EQ, Timbre Match, and Decorrelation, you can do so following the steps below.

- 1 While playing a source, select a non-THX mode.
- 2 Turn the Mode knob clockwise until the display's second line reads SETUP MENU and press the Mode knob.
- 3 The display's second line will now read RE-EQUALIZE. To turn THX Re-Equalization on or off, press the Mode knob. To adjust other THX filters, skip to step 4.
- 4 While the display's top line reads RE-EQUALIZE, you can activate (IS ACTIVE) or deactivate (IS INACTIVE) the Re-EQ filter by turning the Mode knob. Then press the Mode knob.
- 5 Turn the Mode knob clockwise one click until the display's second line will now read TIMBRE MATCH. To turn THX Timbre Match on or off, press the Mode knob. To adjust other THX filters, skip to step 6.
- 6 While the display's top line reads TIMBRE MATCH, you can activate (IS ACTIVE) or deactivate (IS INACTIVE) the Timbre Match filter by turning the Mode knob. Then press the Mode knob.
- 7 Turn the Mode knob clockwise one click until the display's second line will now read DECORRELATE. To turn THX Decorrelation on or off, press the Mode knob.
- 6 While the display's top line reads DECORRELATE, you can activate (IS ACTIVE) or deactivate (IS INACTIVE) the Decorrelation filter by turning the Mode knob. Then press the Mode knob to continue with other setup menu options. To completely exit the setup menu, turn any knob other than Mode.

Dynamic Range

For all Dolby Digital (AC-3) and DTS Modes, you can opt to alter the setting for Dynamic Range, which when set to either DYNAMIC MID (Medium) or DYNAMIC MIN (Minimum), causes for some compression of the sound field. The Out of the Box setting for Dynamic Range is set to maximum (DYNAMIC MAX).

The ability to lower the Dynamic Range of these modes in essence, narrows the liveliness of the home theater system. The bangs and booms are not as boomy when selecting either the middle or minimum position. For some theaters, where the sound is too lively, selecting an alternate setting other than Maximum might prove worthwhile. To alter the Dynamic Range setting:

- 1 Turn the Mode knob clockwise until the display's second line reads SETUP MENU and press the Mode knob.
- 2 The display's second line will now read DYNAMIC RANGE and press the Mode knob.
- 3 Turn the Mode knob to select between DYNAMIC MAX, MID, or MIN. To continue with other setup menu features, press the Mode knob. To completely exit the setup menu, turn any knob other than the Mode knob.

Default Modes

The Cinema Rhapsody Mach II, while being among the most sophisticated of all home theater controllers, is also designed to be easy to use. As such, when properly setup, the end user need only select an input label without having to adjust any other parameters.

The Default Mode setup feature permits you to assign specific modes to an Input Label, such that, whenever that Input Label is selected, the appropriate mode is automatically recalled. This feature is extremely useful and most advanced. There are two Default Mode settings for each Input Label, one for Two-Channel source material and a second for non-Two-Channel source material (5.1).

As an example, since a DVD player can play both 5.1 and 2.0 DVDs, you may select a specific Cinema Mode for 5.1 playback and an alternate Two Channel mode for 2.0 playback.

Similarly, a CD player with a digital output is capable of playing both two-channel CDs and DTS 5.1 CDs. Here a musical Two-Channel Mode can be set for CD playback while a Discrete or Direct mode might be selected for 5.1 playback.

Alternately, if you enjoy listening to CDs in either STEREO mode (front right, left, and subwoofer only) or QUAD mode (all speakers active), you can opt to create two Input Labels for the CD player. One might be called CD STEREO with the Two-Channel Default Mode set to STEREO while the other Input Label is called CD QUAD with the Default Mode set to QUAD. Here instead of changing modes when playing the CD's Input Label, you would simply select the Input Label that will automatically engage the desired mode.

The Cinema Rhapsody Mach II's Out of the Box setup features the Default Modes as specified in the chart.

INPUT #	INPUT LABEL	NON-TWO CHANNEL (5.1) DEFAULT MODE	TWO CHANNEL (2.0) DEFAULT MODE	NON-TWO CHANNEL (5.1) USER MODE	TWO CHANNEL (2.0) USER MODE
1	DVD PLAYER	THX +EX/ES	PRO LOGIC II MOVIE + THX	DISCRETE +EX/ES	PRO LOGIC II MOVIE
2	DSS	THX +EX/ES	PRO LOGIC II MOVIE + THX	DISCRETE +EX/ES	PRO LOGIC II MOVIE
3	DVR/PVR	THX +EX/ES	PRO LOGIC II MOVIE + THX	DISCRETE +EX/ES	PRO LOGIC II MOVIE
4	VCR	THX +EX/ES	PRO LOGIC II MOVIE + THX	DISCRETE +EX/ES	PRO LOGIC II MOVIE
5	CABLE/TV	THX +EX/ES	PRO LOGIC II MOVIE + THX	DISCRETE +EX/ES	PRO LOGIC II MOVIE
6	CD PLAYER	THX MUSIC	QUAD/HEX BYPASS	DISCRETE +EX/ES	PRO LOGIC II MUSIC
7	TUNER	THX MUSIC	QUAD/HEX BYPASS	DISCRETE +EX/ES	PRO LOGIC II MUSIC
8	AUXILIARY	THX +EX/ES	PRO LOGIC II MOVIE + THX	DISCRETE +EX/ES	PRO LOGIC II MOVIE
9	DVD AUDIO	-	-	-	-
10	MULTI-ROOM	THX MUSIC	QUAD/HEX BYPASS	DISCRETE +EX/ES	PRO LOGIC II MUSIC
11	CAMCORDER	THX +EX/ES	PRO LOGIC II MOVIE + THX	DISCRETE +EX/ES	PRO LOGIC II MOVIE
12	VIDEO GAME	THX +EX/ES	PRO LOGIC II MOVIE	DISCRETE +EX/ES	PRO LOGIC II VIRTUAL
13	COMPUTER	DISCRETE +EX/ES	PRO LOGIC II MOVIE	THX MUSIC	PRO LOGIC II MUSIC
14	LASERDISC	THX +EX/ES	PRO LOGIC II MOVIE + THX	DISCRETE +EX/ES	PRO LOGIC II MOVIE
15	LASER AC3	THX +EX/ES	PRO LOGIC II MOVIE + THX	DISCRETE +EX/ES	PRO LOGIC II MOVIE
16	PHONOGRPH	THX MUSIC	QUAD/HEX BYPASS	DISCRETE +EX/ES	PRO LOGIC II MUSIC
17	DSS RECORD	THX +EX/ES	PRO LOGIC II MOVIE + THX	DISCRETE +EX/ES	PRO LOGIC II MOVIE
18	DVR RECORD	THX +EX/ES	PRO LOGIC II MOVIE + THX	DISCRETE +EX/ES	PRO LOGIC II MOVIE
19	TV RECORD	THX +EX/ES	PRO LOGIC II MOVIE + THX	DISCRETE +EX/ES	PRO LOGIC II MOVIE
20	CD RECORD	THX MUSIC	QUAD/HEX BYPASS	DISCRETE +EX/ES	PRO LOGIC II MUSIC

To change Default Modes:

- 1 Turn the Input knob until the display's second line reads the Input Label for the device whose Default Mode you wish to alter. Then press the Input Knob.
- 2 Turn the Mode knob clockwise until the display's second line reads SETUP MENU and press the Mode knob.
- 3 Turn the Mode knob clockwise until the display's second line reads DEFAULT MODE and press the Mode knob.

- 4 The display's second line will now read NON2 CHANNEL referring to non-Two Channel source material (5.1). To alter the non-Two Channel Default Mode for this Input Label, press the Mode knob. To alter the Two-Channel Default Mode for this Input Label, skip to step 6.
- 5 Turn the Mode knob to select the desired non-Two Channel Default Mode for this Input Label. If you wish to have the Default Mode always engage the last mode used, you can select this option by turning the Mode knob counterclockwise until the display's second line reads LAST USED. When done, press the Mode knob to continue with setting the Two-Channel Default Mode for this Input Label. To completely exit the setup menu, turn any knob other than the Mode knob.
- 6 Turn the Mode knob clockwise one click until the display's second line reads 2 CHANNEL and then press the Mode knob.
- 7 Turn the Mode knob to select the desired Two Channel Default Mode for this Input Label. If you wish to have the Default Mode always engage the last mode used, you can select this option by turning the Mode knob counterclockwise until the display's second line reads LAST USED. When done, press turn any knob other than the Mode knob to completely exit the setup menu.
- 8 Repeat steps 1-7 for all Input Labels whose Default Modes you wish to alter.

User Modes

The Cinema Rhapsody Mach II features special modes called User Modes. These are not additional modes that can be created using filter adjustments. Instead, User Modes represent an instantly selectable mode (one push from a remote control) that activates a specific Cinema Rhapsody mode. As such, a single button on a control can be labeled User Mode, which when pressed, will activate a specific mode that is most preferred by the end user for that Input Label.

User Mode has two settings, one for the desired mode when playing a Two-Channel source and a second when playing a non-Two Channel source (5.1) and each Input Label has its own set of User Modes. Once these two modes are assigned to the User Mode setup feature, pressing the User Mode button will engage the set mode, depending on the type of material that is auto-detected by the Cinema Rhapsody Mach II.

When setting the User Mode features, ADA suggests selecting modes that are not different from the Default Modes programmed. The reasoning is that since a Default Mode is automatically engaged based on the input label selected, the User Mode feature permits one to alter the playing mode easily. If the Default Mode and the User Mode are the same, then the User Mode feature provides no added value.

The Cinema Rhapsody Mach II's Out of the Box setup features the User Modes as specified in the chart.

INPUT #	INPUT LABEL	NON-TWO CHANNEL (5.1) DEFAULT MODE	TWO CHANNEL (2.0) DEFAULT MODE	NON-TWO CHANNEL (5.1) USER MODE	TWO CHANNEL (2.0) USER MODE
1	DVD PLAYER	THX +EX/ES	PRO LOGIC II MOVIE + THX	DISCRETE +EX/ES	PRO LOGIC II MOVIE
2	DSS	THX +EX/ES	PRO LOGIC II MOVIE + THX	DISCRETE +EX/ES	PRO LOGIC II MOVIE
3	DVR/PVR	THX +EX/ES	PRO LOGIC II MOVIE + THX	DISCRETE +EX/ES	PRO LOGIC II MOVIE
4	VCR	THX +EX/ES	PRO LOGIC II MOVIE + THX	DISCRETE +EX/ES	PRO LOGIC II MOVIE
5	CABLE/TV	THX +EX/ES	PRO LOGIC II MOVIE + THX	DISCRETE +EX/ES	PRO LOGIC II MOVIE
6	CD PLAYER	THX MUSIC	QUAD/HEX BYPASS	DISCRETE +EX/ES	PRO LOGIC II MUSIC
7	TUNER	THX MUSIC	QUAD/HEX BYPASS	DISCRETE +EX/ES	PRO LOGIC II MUSIC
8	AUXILIARY	THX +EX/ES	PRO LOGIC II MOVIE + THX	DISCRETE +EX/ES	PRO LOGIC II MOVIE
9	DVDAUDIO	-	-	-	-
10	MULTI-ROOM	THX MUSIC	QUAD/HEX BYPASS	DISCRETE +EX/ES	PRO LOGIC II MUSIC
11	CAMCORDER	THX +EX/ES	PRO LOGIC II MOVIE + THX	DISCRETE +EX/ES	PRO LOGIC II MOVIE
12	VIDEO GAME	THX +EX/ES	PRO LOGIC II MOVIE	DISCRETE +EX/ES	PRO LOGIC II VIRTUAL
13	COMPUTER	DISCRETE +EX/ES	PRO LOGIC II MOVIE	THX MUSIC	PRO LOGIC II MUSIC
14	LASERDISC	THX +EX/ES	PRO LOGIC II MOVIE + THX	DISCRETE +EX/ES	PRO LOGIC II MOVIE
15	LASER AC3	THX +EX/ES	PRO LOGIC II MOVIE + THX	DISCRETE +EX/ES	PRO LOGIC II MOVIE
16	PHONOGRPH	THX MUSIC	QUAD/HEX BYPASS	DISCRETE +EX/ES	PRO LOGIC II MUSIC
17	DSS RECORD	THX +EX/ES	PRO LOGIC II MOVIE + THX	DISCRETE +EX/ES	PRO LOGIC II MOVIE
18	DVR RECORD	THX +EX/ES	PRO LOGIC II MOVIE + THX	DISCRETE +EX/ES	PRO LOGIC II MOVIE
19	TV RECORD	THX +EX/ES	PRO LOGIC II MOVIE + THX	DISCRETE +EX/ES	PRO LOGIC II MOVIE
20	CD RECORD	THX MUSIC	QUAD/HEX BYPASS	DISCRETE +EX/ES	PRO LOGIC II MUSIC

To change User Modes:

- 1 Turn the Input knob until the display's second line reads the Input Label for the device whose User Mode you wish to alter. Then press the Input Knob.
- 2 Turn the Mode knob clockwise until the display's second line reads SETUP MENU and press the Mode knob.
- 3 Turn the Mode knob clockwise until the display's second line reads USER MODES and press the Mode knob.
- 4 The display's second line will now read NON2 CHANNEL referring to non-Two Channel source material (5.1). To alter the non-Two Channel Default Mode for this Input Label, press the Mode knob. To alter the Two-Channel User Mode for this Input Label, skip to step 6.

- 5 Turn the Mode knob to select the desired non-Two Channel User Mode for this Input Label. When done, press the Mode knob to continue with setting the Two-Channel User Mode for this Input Label. To completely exit the setup menu, turn any knob other than the Mode knob.
- 6 Turn the Mode knob clockwise one click until the display's second line reads 2 CHANNEL and then press the Mode knob.
- 7 Turn the Mode knob to select the desired Two Channel User Mode for this Input Label. When done, press turn any knob other than the Mode knob to completely exit the setup menu.
- 8 Repeat steps 1-7 for all Input Labels whose User Modes you wish to alter.

Appendix A - Out Of The Box Settings Overview

Input Labels - AV Jacks - RGB Output - Low Voltage Triggers

The Cinema Rhapsody does not defeat composite video, S-Video, or RGB input jacks from being assigned to each and every input label. Only the Component Video Input can be turned off per Input Label. As such, all Input Labels will have a composite video, S-Video, and RGB input jack assigned to them, even if that device does not output (or connect) in that manner to the Cinema Rhapsody Mach II. If for example, your TV is set to the S-Video input and the Cinema Rhapsody is on the CABLE/TV Input Label, you will see the image from the VCR (S-Video 4). This is because the CABLE/TV Input Label will still track the S-Video #4 input. To see the image from the CABLE/TV Input Label, you will need to set your TV to either a composite video input or, if applicable, the RGB input. The chart below shows Input Labels and illustrates in brackets {}, the assigned composite, S-Video, or RGB jack even though the Out of the Box setup is not relevant to these connections. You can opt to alter these “blind” input links if for example, you prefer to have the DSS {2} image on screen instead of the VCR {4} image, when listening to the CD player.

INPUT #	INPUT LABEL	AUDIO INPUT	COMPOSITE VIDEO INPUT	S-VIDEO INPUT	COMPONENT VIDEO INPUT	DC LOW VOLTAGE 1	DC LOW VOLTAGE 2
1	DVD PLAYER	DIGITAL 1	1	1	1	ON	ON
2	DSS	OPTICAL 2	2	2	2	ON	ON
3	DVR/PVR	ANALOG 3	3	3	OFF	ON	ON
4	VCR	ANALOG 4	4	4	OFF	ON	ON
5	CABLE/TV	ANALOG 5	5	{4}	OFF	ON	ON
6	CD PLAYER	ANALOG 6	{4}	{4}	OFF	ON	OFF
7	TUNER	ANALOG 7	{4}	{4}	OFF	ON	OFF
8	AUXILIARY	ANALOG 8	8	{4}	OFF	ON	ON
9	DVD AUDIO	MULTI-PIN	1	1	1	ON	ON
10	MULTI-ROOM	ANALOG 2	{8}	{4}	OFF	ON	OFF
11	CAMCORDER	ANALOG 1	7	{4}	OFF	ON	ON
12	VIDEO GAME	DIGITAL 3	6	{4}	3	ON	ON
13	COMPUTER	DIGITAL 4	{6}	{4}	OFF	ON	ON
14	LASERDISC	OPTICAL 1	8	{4}	OFF	ON	ON
15	LASER AC3	DIGITAL 2	8	{4}	OFF	ON	ON
16	PHONOGRPH	ANALOG 1	{8}	{4}	OFF	ON	OFF
17	DSS RECORD	ANALOG 2	2	2	2	ON	ON
18	DVR RECORD	ANALOG 3	3	3	OFF	ON	ON
19	TV RECORD	ANALOG 5	5	{4}	OFF	ON	ON
20	CD RECORD	ANALOG 6	{4}	{4}	OFF	ON	OFF

Default Modes and User Modes per Input Label

INPUT #	INPUT LABEL	NON-TWO CHANNEL (5.1) DEFAULT MODE	TWO CHANNEL (2.0) DEFAULT MODE	NON-TWO CHANNEL (5.1) USER MODE	TWO CHANNEL (2.0) USER MODE
1	DVD PLAYER	THX +EX/ES	PRO LOGIC II MOVIE + THX	DISCRETE +EX/ES	PRO LOGIC II MOVIE
2	DSS	THX +EX/ES	PRO LOGIC II MOVIE + THX	DISCRETE +EX/ES	PRO LOGIC II MOVIE
3	DVR/PVR	THX +EX/ES	PRO LOGIC II MOVIE + THX	DISCRETE +EX/ES	PRO LOGIC II MOVIE
4	VCR	THX +EX/ES	PRO LOGIC II MOVIE + THX	DISCRETE +EX/ES	PRO LOGIC II MOVIE
5	CABLE/TV	THX +EX/ES	PRO LOGIC II MOVIE + THX	DISCRETE +EX/ES	PRO LOGIC II MOVIE
6	CD PLAYER	THX MUSIC	QUAD/HEX BYPASS	DISCRETE +EX/ES	PRO LOGIC II MUSIC
7	TUNER	THX MUSIC	QUAD/HEX BYPASS	DISCRETE +EX/ES	PRO LOGIC II MUSIC
8	AUXILIARY	THX +EX/ES	PRO LOGIC II MOVIE + THX	DISCRETE +EX/ES	PRO LOGIC II MOVIE
9	DVD AUDIO	-	-	-	-
10	MULTI-ROOM	THX MUSIC	QUAD/HEX BYPASS	DISCRETE +EX/ES	PRO LOGIC II MUSIC
11	CAMCORDER	THX +EX/ES	PRO LOGIC II MOVIE + THX	DISCRETE +EX/ES	PRO LOGIC II MOVIE
12	VIDEO GAME	THX +EX/ES	PRO LOGIC II MOVIE	DISCRETE +EX/ES	PRO LOGIC II VIRTUAL
13	COMPUTER	DISCRETE +EX/ES	PRO LOGIC II MOVIE	THX MUSIC	PRO LOGIC II MUSIC
14	LASERDISC	THX +EX/ES	PRO LOGIC II MOVIE + THX	DISCRETE +EX/ES	PRO LOGIC II MOVIE
15	LASER AC3	THX +EX/ES	PRO LOGIC II MOVIE + THX	DISCRETE +EX/ES	PRO LOGIC II MOVIE
16	PHONOGRPH	THX MUSIC	QUAD/HEX BYPASS	DISCRETE +EX/ES	PRO LOGIC II MUSIC
17	DSS RECORD	THX +EX/ES	PRO LOGIC II MOVIE + THX	DISCRETE +EX/ES	PRO LOGIC II MOVIE
18	DVR RECORD	THX +EX/ES	PRO LOGIC II MOVIE + THX	DISCRETE +EX/ES	PRO LOGIC II MOVIE
19	TV RECORD	THX +EX/ES	PRO LOGIC II MOVIE + THX	DISCRETE +EX/ES	PRO LOGIC II MOVIE
20	CD RECORD	THX MUSIC	QUAD/HEX BYPASS	DISCRETE +EX/ES	PRO LOGIC II MUSIC

Tone Presets

GROUP A	SPEAKER GROUP A								TREB A	TREB A	BASS A	BASS A	GROUP B	SPEAKER GROUP B								TREB B	TREB B	BASS B	BASS B
	(X=SPKR ACTIVE)	C	S	L	R	SL	SR	BL						BR	FREQ	LEVEL	FREQ	LEVEL	(X=SPKR ACTIVE)	C	S				
TONE PRESET 1	X	X	X	X	X	X	X	X	6KHZ	0DB	260HZ	0DB	TONE PRESET 1	-	-	-	-	-	-	-	-	6KHZ	0DB	260HZ	0DB
TONE PRESET 2	X	-	X	X	-	-	-	-	12KHZ	0DB	120HZ	0DB	TONE PRESET 2	-	-	-	-	X	X	X	X	8KHZ	0DB	180HZ	0DB
TONE PRESET 3	-	-	X	X	-	-	-	-	12KHZ	0DB	120HZ	0DB	TONE PRESET 3	X	-	-	-	X	X	X	X	8KHZ	0DB	180HZ	0DB
TONE PRESET 4	X	-	X	X	X	X	X	X	12KHZ	0DB	120HZ	0DB	TONE PRESET 4	X	-	X	X	X	X	X	X	8KHZ	0DB	180HZ	0DB

Appendix B - Custom Setup Work Sheet

The work sheet below is provided for you to complete your own Custom Input Configuration. Please note that the numbers in the lower left hand corner of each box indicate the Out of the Box input assignment as a reference. Note that A1 refers to Analog 1, while D1 refers to Digital 1, and O1 refers to Optical 1. ADA recommends using a pencil to fill in this work sheet in the event you find yourself altering your configuration along the way.

INPUT #	INPUT LABEL	AUDIO INPUT	COMPOSITE VIDEO INPUT	S-VIDEO INPUT	COMPONENT VIDEO INPUT
1	DVD PLAYER	D1	1	1	1
2	DSS	O2	2	2	2
3	DVR/PVR	A3	3	3	OFF
4	VCR	A4	4	4	OFF
5	CABLE/TV	A5	5	4	OFF
6	CD PLAYER	A6	4	4	OFF
7	TUNER	A7	4	4	OFF
8	AUXILIARY	A8	8	4	OFF
9	DVD AUDIO	MULTI-PIN	1	1	1
1 0	MULTI-ROOM	A2	8	4	OFF
1 1	CAMCORDER	A1	7	4	OFF
1 2	VIDEO GAME	D3	6	4	3
1 3	COMPUTER	D4	8	4	OFF
1 4	LASERDISC	O1	6	4	OFF
1 5	LASER AC3	D2	8	4	OFF
1 6	PHONOGRPH	A1	8	4	OFF
1 7	DSS RECORD	A2	2	2	2
1 8	DVR RECORD	A3	3	3	OFF
1 9	TV RECORD	A5	5	4	OFF
2 0	CD RECORD	A6	4	4	OFF

Appendix C - Resetting Factory Defaults

The Cinema Rhapsody has a Factory Default recall options which will reset all Cinema Rhapsody Mach II features to configurations programmed at the factory. **Please note, that resetting your unit to the Factory Default settings will void any changes that you may have made during the Cinema Rhapsody Mach II's setup.**

To recall the Factory Default settings:

- 1 Turn the Mode knob clockwise until the display's second line reads SETUP MENU and press the Mode knob.
- 2 Turn the Mode knob clockwise until the display's second line reads PRO SETUP and press the Mode knob.
- 3 Turn the Mode knob clockwise until the display's second line reads FACTORY DFLT and press the Mode knob.
- 4 The display's second line will now read PUSH TO SET. If you are certain that you wish to proceed with the resetting of the Factory Defaults, press the Mode knob now. The display's second line will now read SYSTEM RESET. After a moment, the unit will cycle its power off and then back on.

At this time you have reset the Cinema Rhapsody Mach II to the factory settings.

Appendix D - Master Reset Power Button (Vacation Switch)

The Cinema Rhapsody Mach II has a hidden front panel power button that permits you to remove power from the Cinema Rhapsody without unplugging the Cinema Rhapsody's power cord. Because the Cinema Rhapsody Mach II's rear panel power cord may be difficult to access, this front panel power button is ideal when you wish to make certain the unit remains off during lengthy periods of non-use (vacation switch), when you want to make certain the unit remains off (while performing sensitive connections), or when you need to reset the Cinema Rhapsody Mach II (explained below).

The Cinema Rhapsody Mach II operates on a microprocessor. Upon first getting power (plugging in the Cinema Rhapsody's AC cord), this microprocessor powers up and remains on, even if the Cinema Rhapsody is off. The Cinema Rhapsody's microprocessor will remain on until the Cinema Rhapsody's power cord is disconnected or the hidden power button is pressed. While having the microprocessor constantly on, does not pose a problem for the Cinema Rhapsody, outside events may require you to reset the microprocessor. These events might include electrical power outages or brownouts, power surges, lightning storms, etc. If you are experiencing problems operating your Cinema Rhapsody, problems that you did not experience before, try turning this button off, wait a few minutes, and then turn the switch on again. If this does not solve your operational problems, please contact your local ADA Dealer.

Please note, that if the Cinema Rhapsody's hidden front panel Master Power Button is in the (Out) off position, you will not be able to turn the Cinema Rhapsody on from the front panel Volume Knob, an IR remote control, an ADA keypad, or a touch screen system. When this button is set to the off position, you must first push it in to the on position, prior to using the Cinema Rhapsody.

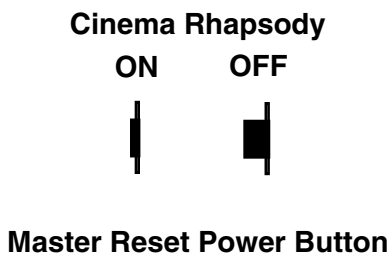

ADA strongly recommends leaving this button on during normal day-to-day use. Unless, you are planning to not use the system for a long period of time, you will most likely leave this button in the on position.



Appendix E - Cinema Rhapsody Mach II PC Program

The Cinema Rhapsody Mach II is capable of being controlled and setup from a special PC program provided by ADA, the Cinema Ref. II PCOS. You will need to communicate with the Cinema Rhapsody as outlined in this manual under PC Setup & Control. This section will assist you in understanding the software application.

When the application is running, the Main page permits you set your Com Port, the Address of the unit (typically address 00) and the Baud Rate (1200 Baud Out of the Box).

The lower portion of the window permits you to turn the unit off, mute, unmute/power on. You can also opt to raise and lower Volume in either .5dB or 1dB steps as well as Recall and Store volume presets. This page also permits you to recall both Balance and Tone presets.

The Red and Blue squares are update information requests and when pressed, will cause the Cinema Rhapsody Mach II to update data based on the buttons function. As you place your cursor over the Red button squares, the type of data that will be updated will display in a yellow text box. The Blue button squares update the information in the top portion of the window. This applies to all screens.

Under the Cinema Mode tab, the Input Control sub-tab permits selection of both the Main Input and the Record Input.

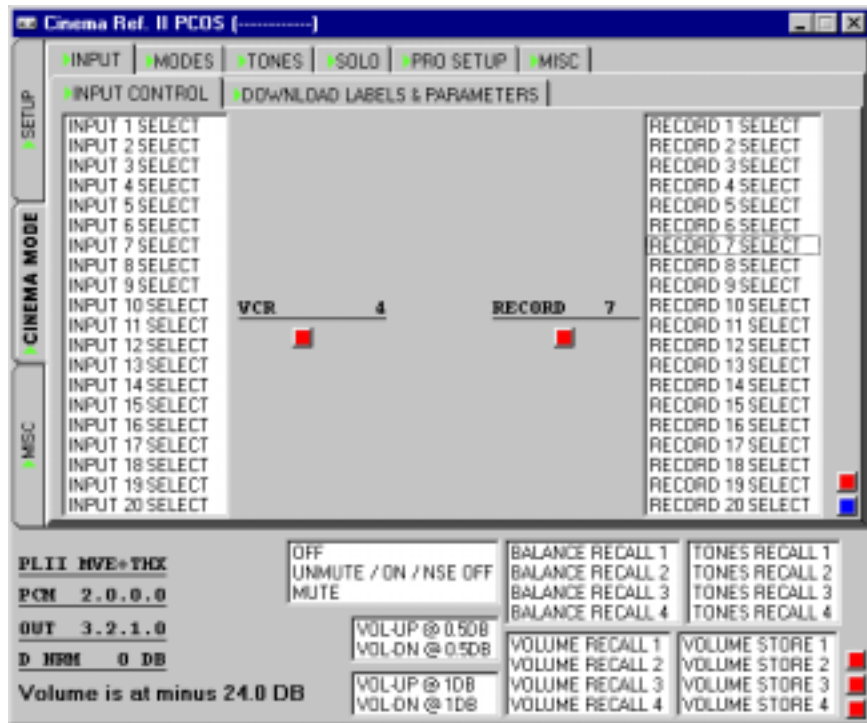
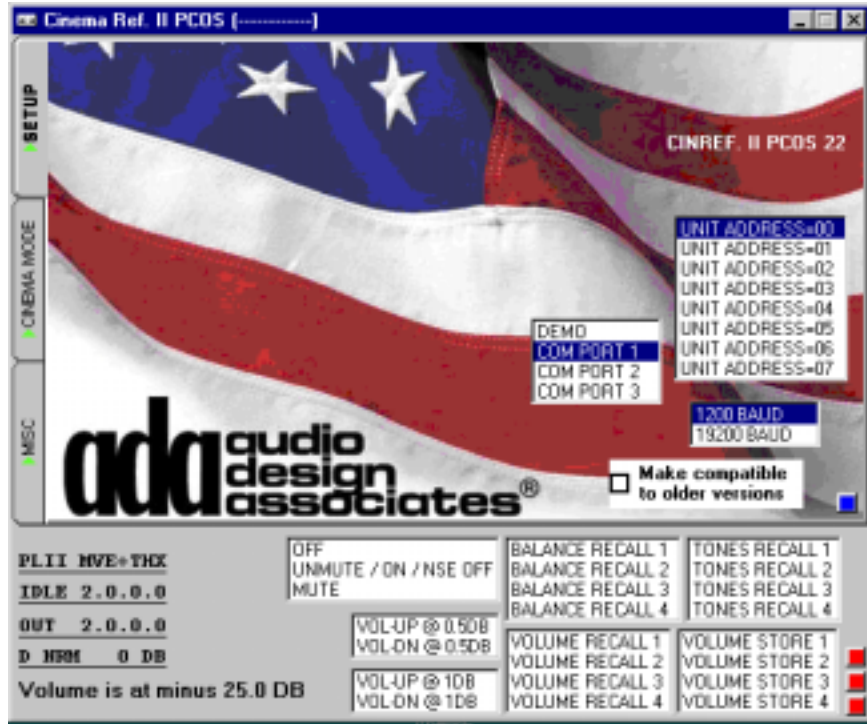

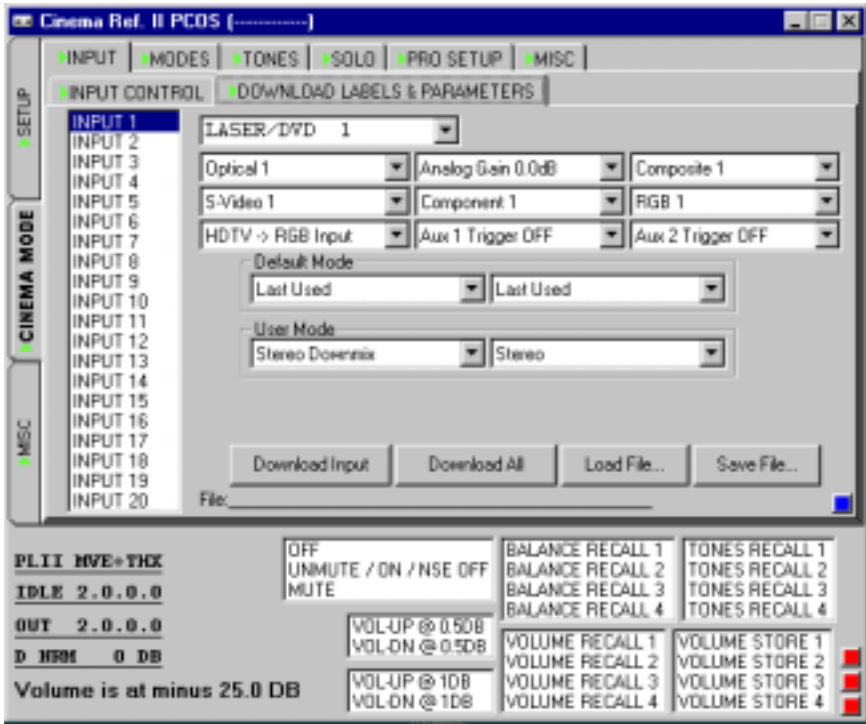

Under the Download Labels and Parameters sub-tab, you can proceed to alter the Input Labels to customize your Cinema Rhapsody Mach II.

To do so, select an input number from the column on the left. The Input Label will display and you can then highlight the name using your mouse and type in your own Input Label. ADA strongly suggests leaving the one or two digit numeric input number reference in place.

You may also select the audio and video jacks assigned to this Input Number/Label. Ignore the RGB-HDTV options here as they do not apply to the Cinema Rhapsody Mach II.

Low Voltage trigger assignment is also facilitated on this page individually for Triggers 1 and 2.

Lastly, you may also select the two Default Modes and the two User Modes for this Input Number/Label.

Once all these features are set, you may save them for future reference. To do so, press the Save File button and assign a file name to this setup.

To recall these saved settings, you will press the Load File button and then select the desired file you wish to open.

To download this setup to the Cinema Rhapsody Mach II, press the Download All button. Download Input will just download the selected input.

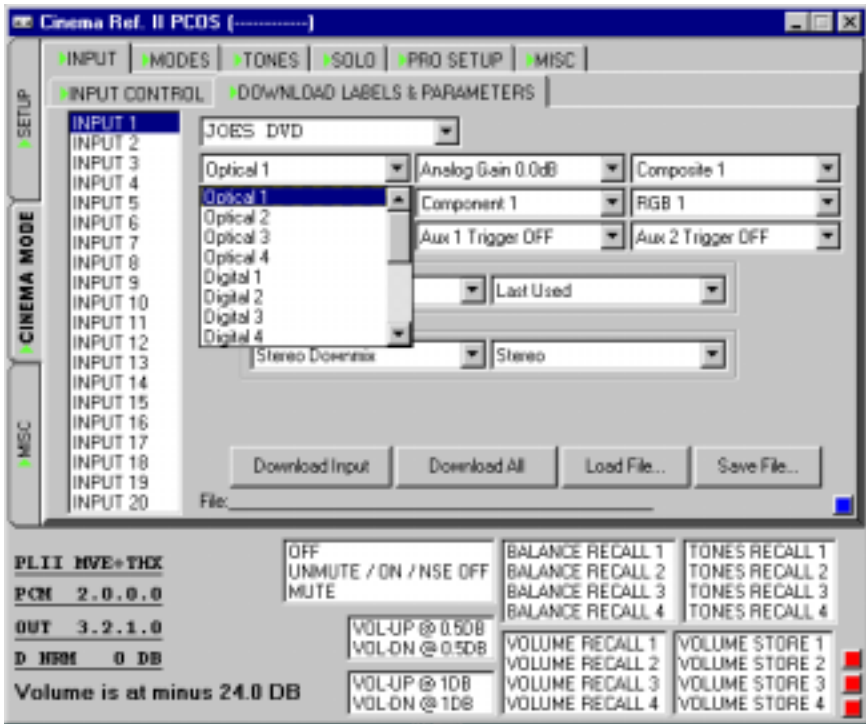

Under the Mode Selection sub-tab, you have the opportunity to select Modes directly.

If the Cinema Rhapsody Mach II is playing a non-Two Channel source (5.1), the Cinema Modes in the lower half of the window will be active.

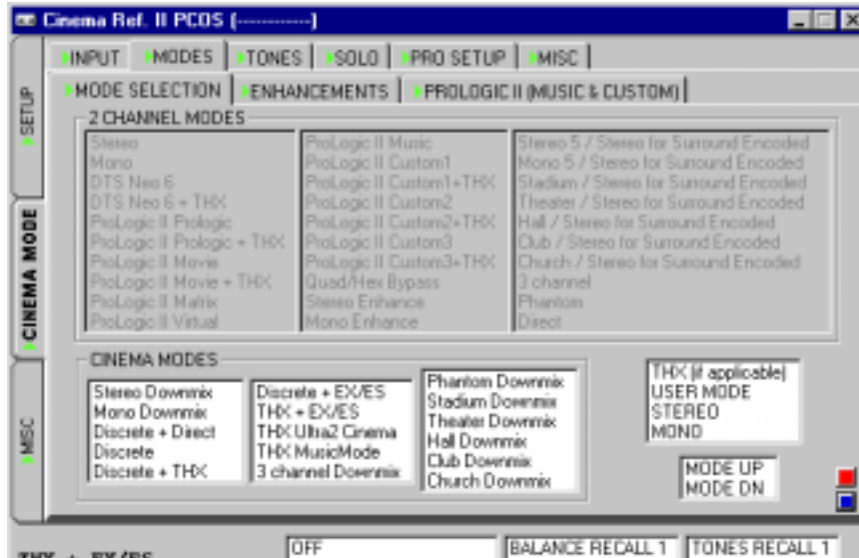

If the Cinema Rhapsody Mach II is playing a Two-Channel source (2.0), the 2 Channel Modes in the upper half of the window will be active.

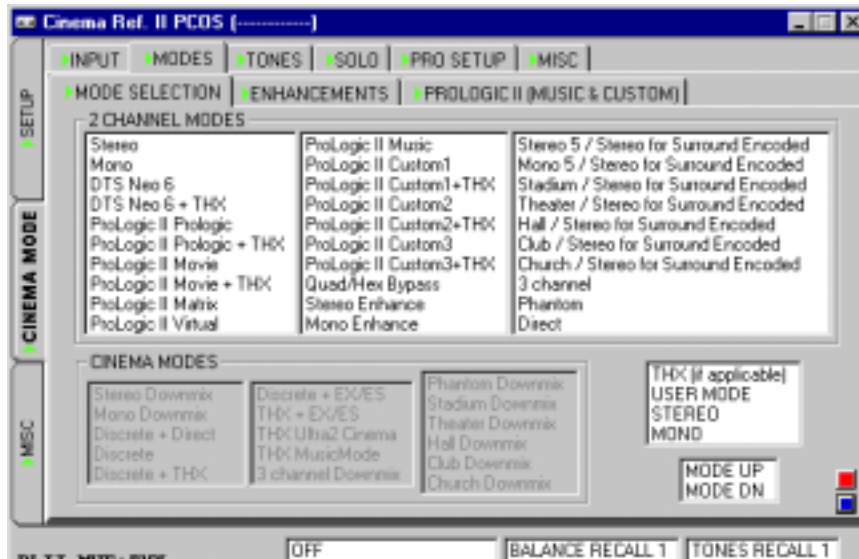

Under the Enhancement sub-tab, you can:

Turn Re-EQ, Timbre Match, and Decorrelation on or off providing that you are not in a THX mode.

Set the Dynamic Range.

Set the Stereo Enhancement Mode settings.

Set the Mono Enhancement Mode settings.

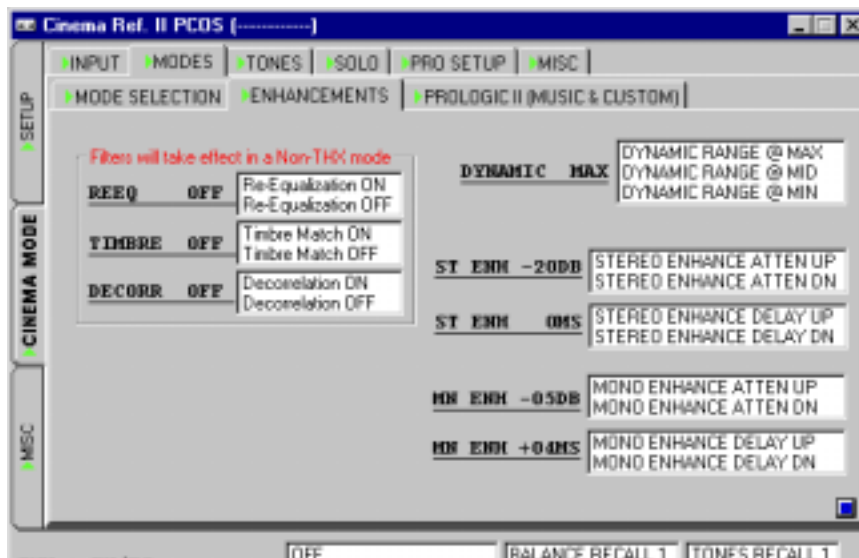

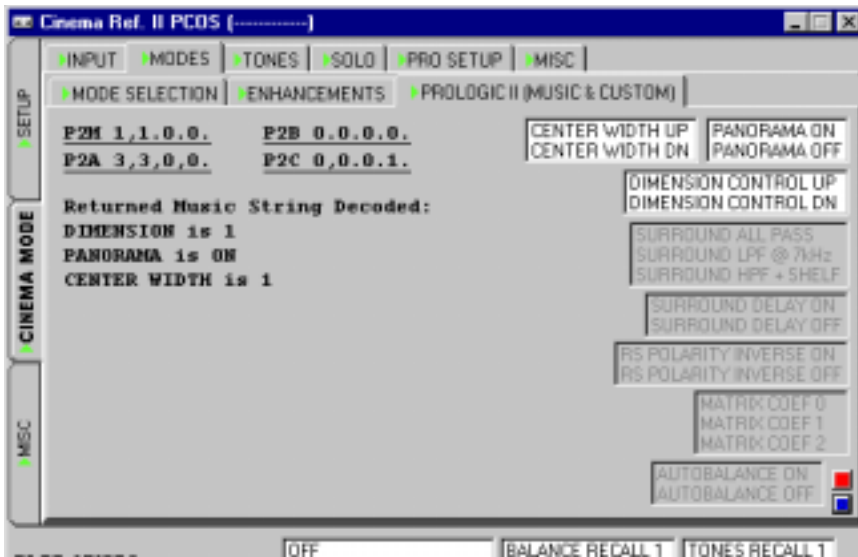

When playing Two-Channel source material in the Pro Logic II Music mode you adjust Center Width control, Dimension Control, and turn Panorama on or off.

These features will be unavailable in other Pro Logic modes (other than Custom PLII modes).

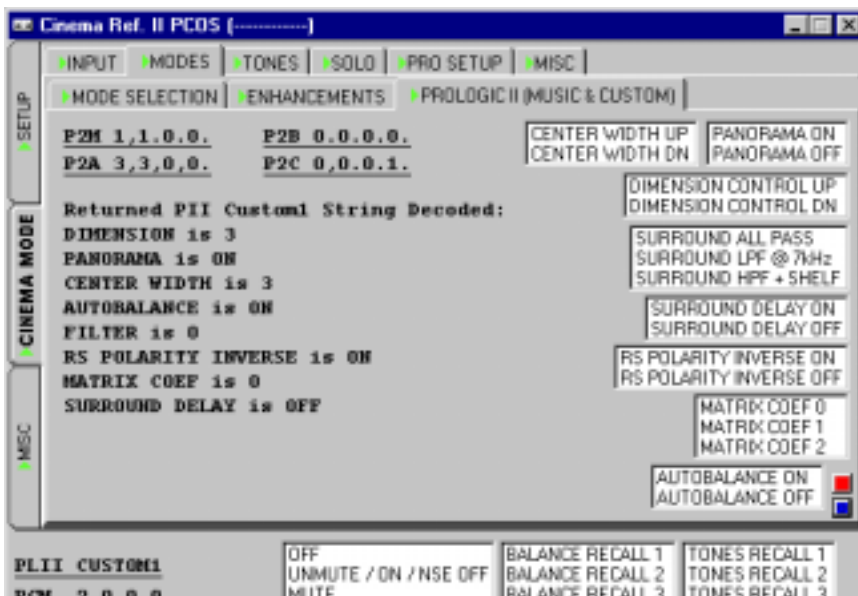

For Pro Logic II Custom I, II, or III (with or without THX), these additional features become active in addition to those just mentioned.

Here you set the Surround speakers filters, turn Surround Delay on or off, invert the Right Surround speaker's polarity, set the Matrix Coefficient, and turn Auto Balance on or off.

These features are not available on any modes other than the three Custom PL II modes.

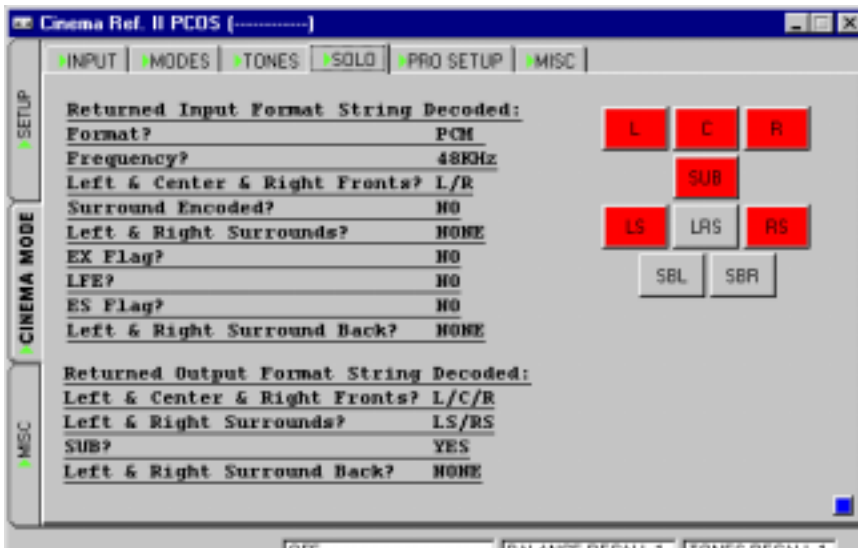

Under the Solo sub-tab, you can selectively engage on speaker at a time.

This tab also details system information including Input and Output formats.

Under the Tones sub-tab, there are two addition sub-sub tabs marked Group A and Group B.

Under the Group A tab, you can determine which speakers are active in Group A, the Frequency point for Treble and the Treble Level. You can do the same for Bass, setting both the Bass Frequency point and the Bass Level.

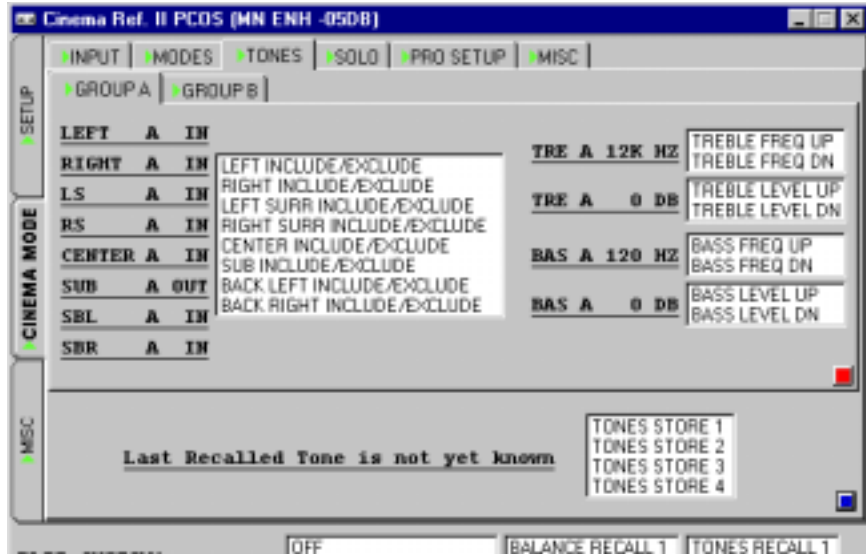

Under the Group B tab, you can determine which speakers are active in Group A, the Frequency point for Treble and the Treble Level. You can do the same for Bass, setting both the Bass Frequency point and the Bass Level.

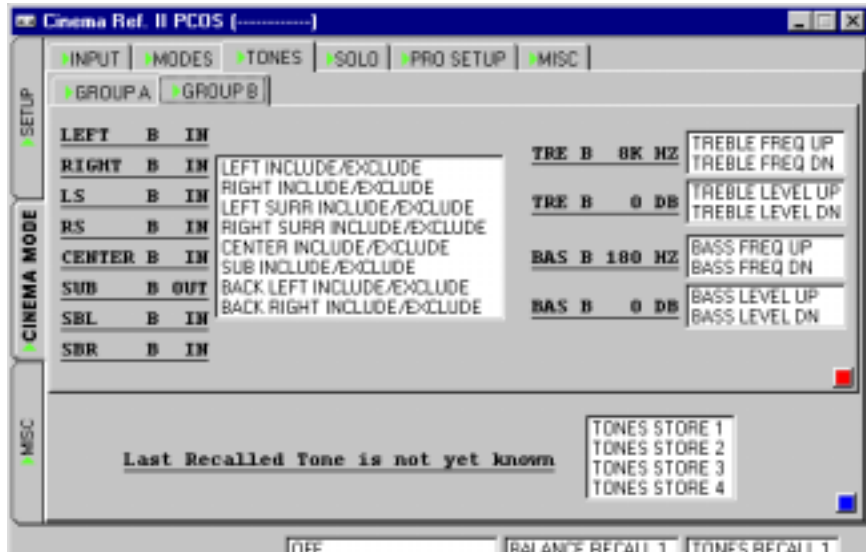

Once you have set speakers up in these two groups and adjusted their level, you can opt to Store these settings on one of the four Tone Presets by pressing the corresponding Tones Store number.

The Misc tab allows you to set the volume using a sliding control at the top of this window.

You can also set the Cinema Rhapsody Mach II's maximum volume level and select the Turn-On Volume Preset.

DTS LFE settings are also adjusted on this page.

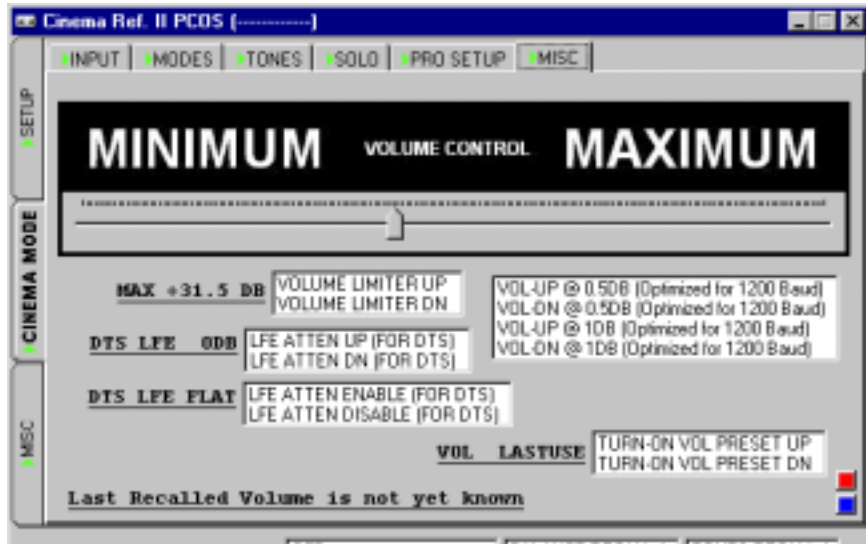

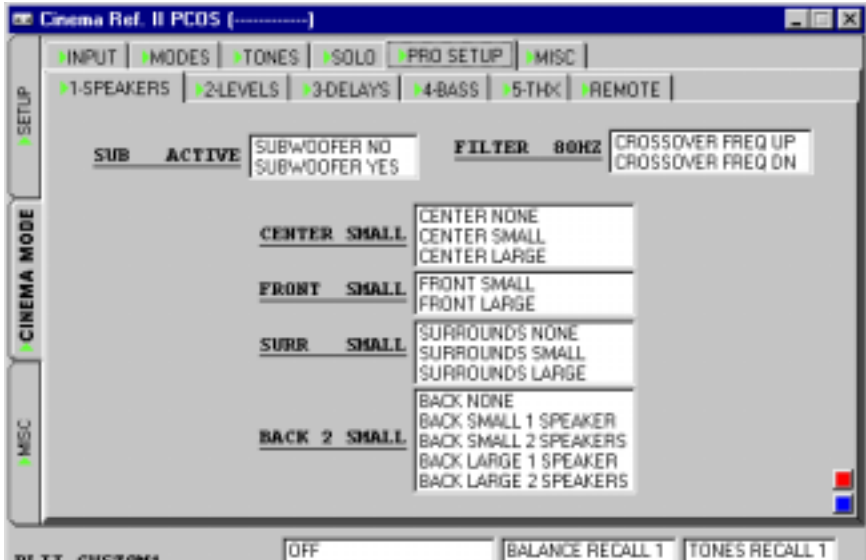

Under the Pro Setup tab, there are six sub-tabs which are in order according to THX setup suggestions.

The 1-Speaker tab permits you to determine the size of the speakers. For the subwoofer, you can determine if one exists in your system and also set the Crossover Frequency point.

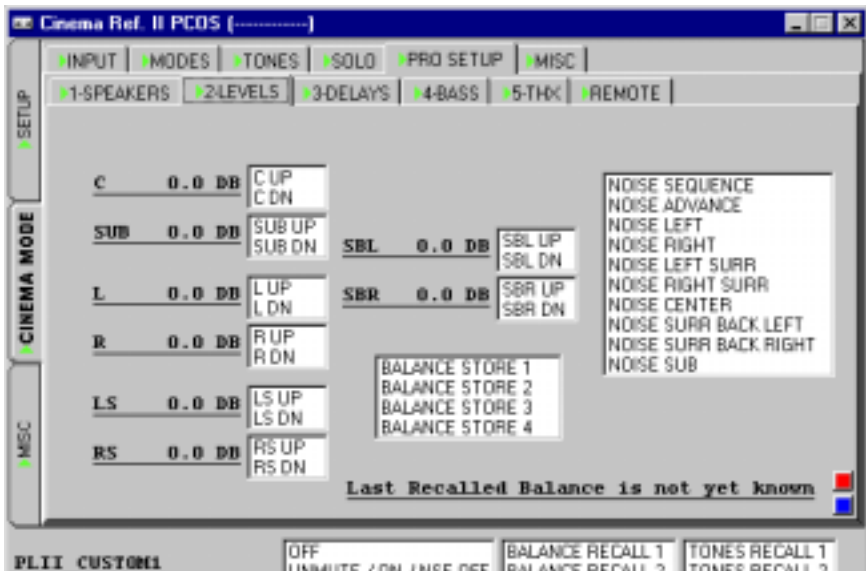

Under 2-Levels, you can set the balance levels using an SPL meter. Here you can engage the Cinema Rhapsody Mach II's internal pink-noise generator to facilitate this setup.

Once setup is completed, you can also Store the Balance Preset in one of the four Balance Presets by simply pressing the Balance Store number.

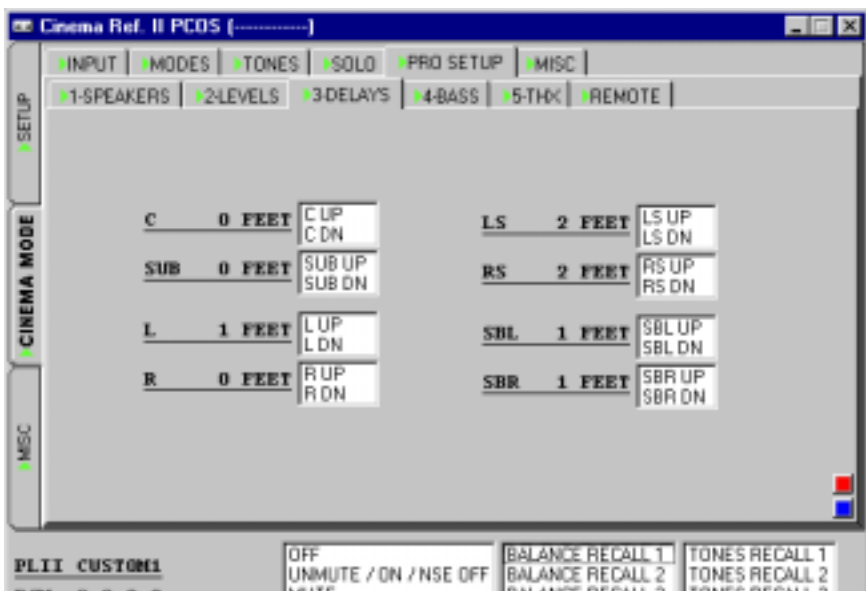

The 3-Delay sub-tab permits you to set the delays for each channel. ADA reminds you to keep at least one speaker set to 0 as this is the speaker that is the greatest distance from the seating area.

All speakers that are closer to the seating area should have their delays set accordingly.

Under the 4-Bass tab, you can set the Bass limiters level and even engage subwoofer pink noise.

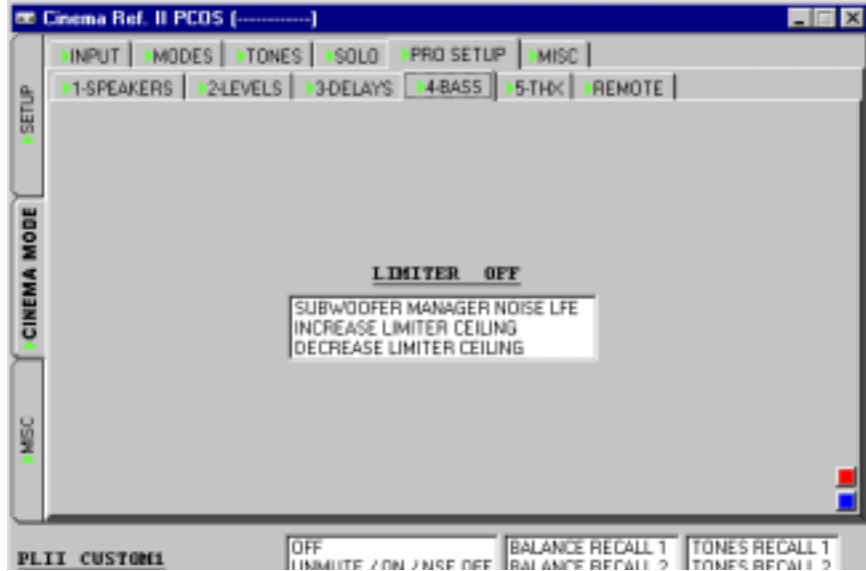

Under the 5-THX sub-tab, you can turn Boundary Gain on or off and also adjust the ASA setting.

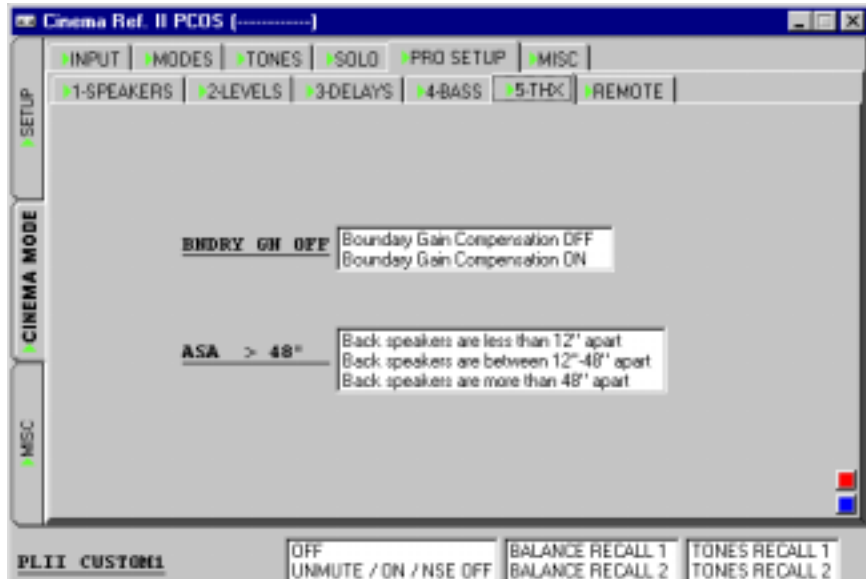

Under the Remote sub-tab, you can use single steps to proceed through all of the Cinema Rhapsody Mach II steps one by one, using a Execute, Previous, and Next step button.

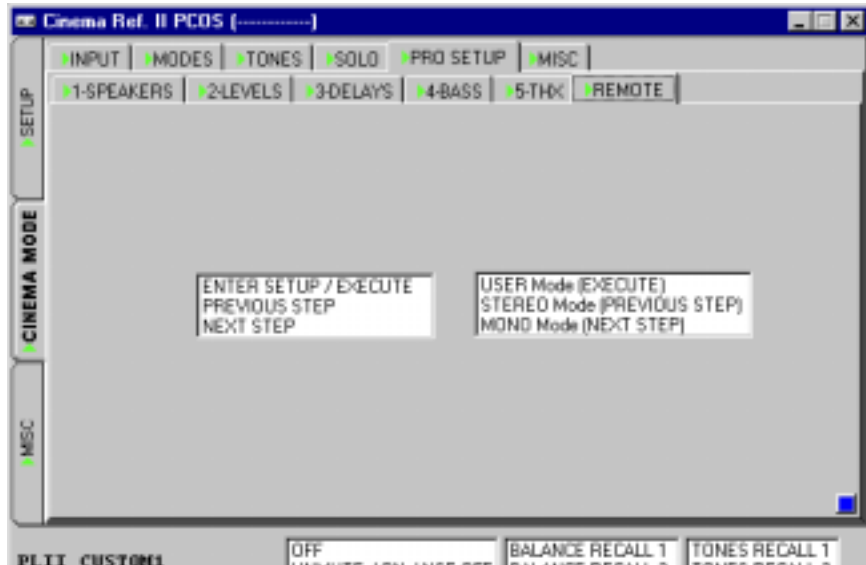

These features exist to permit the Cinema Rhapsody Mach II to be setup using the OSD output in conjunction with a hand-held IR remote control.

Appendix F - Cinema Rhapsody Mach II Hex Codes

AUDIO DESIGN ASSOCIATES DEVICE NAME:			
	CINEMA REF MACH II / CINEMA RAP II		
GENERAL COMPLEX FEEDBACK FORMAT			
	0F	*start byte	
	CHARACTER 1	ASCII Character	
	CHARACTER 2	ASCII Character	
	CHARACTER 3	ASCII Character	
	CHARACTER 4	ASCII Character	
	CHARACTER 5	ASCII Character	
	CHARACTER 6	ASCII Character	
	CHARACTER 7	ASCII Character	
	CHARACTER 8	ASCII Character	
	CHARACTER 9	ASCII Character	
	CHARACTER 10	ASCII Character	
	CHARACTER 11	ASCII Character	
	CHARACTER 12	ASCII Character	
	03	*system assigned number	
	ADDRESS	*most significant nibble is UNIT. Least significant nibble is CARD SLOT. Or has to match the CinRef programmed address.	
	F0	*stop byte	
GENERAL COMMAND FORMAT			
	FF	*start byte	
	03	*system assigned number	
	ADDRESS	*most significant nibble is UNIT. Least significant nibble is CARD SLOT. Or has to match the CinRef programmed address.	
	COMMAND HIGH BYTE		
	COMMAND LOW BYTE		
	FF	*stop byte	
DSP CINEMA MODE COMMANDS 1 (commands are ignored if system is in quad mode)			
	RESERVED	FF,03,00,01,00,04,FF	*reserved for this application
	RESERVED	FF,03,00,01,01,05,FF	*reserved for this application
	RESERVED	FF,03,00,01,02,06,FF	*reserved for this application
	RESERVED	FF,03,00,01,03,07,FF	*reserved for this application
	RESERVED	FF,03,00,01,04,08,FF	*reserved for this application
	RESERVED	FF,03,00,01,05,09,FF	*reserved for this application
	RESERVED	FF,03,00,01,06,0A,FF	*reserved for this application
	RESERVED	FF,03,00,01,07,0B,FF	*reserved for this application
	system off	FF,03,00,01,08,0C,FF	DC voltage is absent within this zone
	RESERVED	FF,03,00,01,09,0D,FF	*reserved for this application
	RESERVED	FF,03,00,01,0A,0E,FF	*reserved for this application
	RESERVED	FF,03,00,01,0B,0F,FF	*reserved for this application
	RESERVED	FF,03,00,01,0C,10,FF	*reserved for this application
	RESERVED	FF,03,00,01,0D,11,FF	*reserved for this application
	RESERVED	FF,03,00,01,0E,12,FF	*reserved for this application
	RESERVED	FF,03,00,01,0F,13,FF	*reserved for this application
	RESERVED	FF,03,00,01,10,14,FF	*reserved for this application
	RESERVED	FF,03,00,01,11,15,FF	*reserved for this application
	RESERVED	FF,03,00,01,12,16,FF	*reserved for this application
	RESERVED	FF,03,00,01,13,17,FF	*reserved for this application
	RESERVED	FF,03,00,01,14,18,FF	*reserved for this application
	RESERVED	FF,03,00,01,15,19,FF	*reserved for this application
	RESERVED	FF,03,00,01,16,1A,FF	*reserved for this application
	RESERVED	FF,03,00,01,17,1B,FF	*reserved for this application
	RESERVED	FF,03,00,01,18,1C,FF	*reserved for this application
	RESERVED	FF,03,00,01,19,1D,FF	*reserved for this application
	RESERVED	FF,03,00,01,1A,1E,FF	*reserved for this application
	RESERVED	FF,03,00,01,1B,1F,FF	*reserved for this application
	RESERVED	FF,03,00,01,1C,20,FF	*reserved for this application
	RESERVED	FF,03,00,01,1D,21,FF	*reserved for this application
	RESERVED	FF,03,00,01,1E,22,FF	*reserved for this application
	RESERVED	FF,03,00,01,1F,23,FF	*reserved for this application
	RESERVED	FF,03,00,01,20,24,FF	*reserved for this application
	vol - unmute & power on & noise off	FF,03,00,01,21,25,FF	DC voltage is present within this zone
	vol - soft mute	FF,03,00,01,22,26,FF	
	format - use auto(restart default)	FF,03,00,01,23,27,FF	
	format - force to pcm (defaults back to auto at restart)	FF,03,00,01,24,28,FF	not recommended for any application
	format - force to ac3 (defaults back to auto at restart)	FF,03,00,01,25,29,FF	not recommended for any application
	format - force to dts (defaults back to auto at restart)	FF,03,00,01,26,2A,FF	not recommended for any application
	vol - master-up @ 0.5db (feedback delayed, Optimized for 1200 Baud)	FF,03,00,01,27,2B,FF	
	vol - master-dn @ 0.5db (feedback delayed, Optimized for 1200 Baud)	FF,03,00,01,28,2C,FF	
	vol - master-up @ 1db (feedback delayed, Optimized for 1200 Baud)	FF,03,00,01,29,2D,FF	
	vol - master-dn @ 1db (feedback delayed, Optimized for 1200 Baud)	FF,03,00,01,2A,2E,FF	
	remote - setup enter/execute	FF,03,00,01,2B,2F,FF	
	remote - setup previous step	FF,03,00,01,2C,30,FF	
	remote - setup next step	FF,03,00,01,2D,31,FF	
	noise - sequence	FF,03,00,01,2E,32,FF	
	noise - advance	FF,03,00,01,2F,33,FF	
	noise - left	FF,03,00,01,30,34,FF	
	noise - right	FF,03,00,01,31,35,FF	
	noise - lsur	FF,03,00,01,32,36,FF	
	noise - rsur	FF,03,00,01,33,37,FF	
	noise - cntr	FF,03,00,01,34,38,FF	
	noise - lcs	FF,03,00,01,35,39,FF	
	noise - rcs	FF,03,00,01,36,3A,FF	

	vol - master-up @ 0.5db	FF,03,00,01,37,3B,FF	
	vol - master-dn @ 0.5db	FF,03,00,01,38,3C,FF	
	vol - left-up @ 0.5db	FF,03,00,01,39,3D,FF	
	vol - left-dn @ 0.5db	FF,03,00,01,3A,3E,FF	
	vol - center-up @ 0.5db	FF,03,00,01,3B,3F,FF	
	vol - center-dn @ 0.5db	FF,03,00,01,3C,40,FF	
	vol - right-up @ 0.5db	FF,03,00,01,3D,41,FF	
	vol - right-dn @ 0.5db	FF,03,00,01,3E,42,FF	
	vol - ls-up @ 0.5db	FF,03,00,01,3F,43,FF	
	vol - ls-dn @ 0.5db	FF,03,00,01,40,44,FF	
	vol - rs-up @ 0.5db	FF,03,00,01,41,45,FF	
	vol - rs-dn @ 0.5db	FF,03,00,01,42,46,FF	
	vol - sub-up @ 0.5db	FF,03,00,01,43,47,FF	
	vol - sub-dn @ 0.5db	FF,03,00,01,44,48,FF	
	vol - lcs-up @ 0.5db	FF,03,00,01,45,49,FF	
	vol - lcs-dn @ 0.5db	FF,03,00,01,46,4A,FF	
	vol - rcs-up @ 0.5db	FF,03,00,01,47,4B,FF	
	vol - rcs-dn @ 0.5db	FF,03,00,01,48,4C,FF	
	mode - dynamicrange-max	FF,03,00,01,49,4D,FF	
	mode - dynamicrange-mid	FF,03,00,01,4A,4E,FF	
	mode - dynamicrange-min	FF,03,00,01,4B,4F,FF	
	ASA - Boundary Gain Compensation OFF	FF,03,00,01,4C,50,FF	
	ASA - Boundary Gain Compensation ON	FF,03,00,01,4D,51,FF	
	update - ASA	FF,03,00,01,4E,52,FF	
	spk - lr-small	FF,03,00,01,4F,53,FF	
	spk - lr-big	FF,03,00,01,50,54,FF	
	spk - c-none	FF,03,00,01,51,55,FF	
	spk - c-small	FF,03,00,01,52,56,FF	
	spk - c-big	FF,03,00,01,53,57,FF	
	spk - lsrs-none	FF,03,00,01,54,58,FF	
	spk - lsrs-small	FF,03,00,01,55,59,FF	
	spk - lsrs-big	FF,03,00,01,56,5A,FF	
	spk - sub-no	FF,03,00,01,57,5B,FF	
	spk - sub-yes	FF,03,00,01,58,5C,FF	
	noise - sub	FF,03,00,01,59,5D,FF	
	vol - master-up @ 1db	FF,03,00,01,5A,5E,FF	
	vol - master-dn @ 1db	FF,03,00,01,5B,5F,FF	
	RESERVED	FF,03,00,01,5C,60,FF	*reserved for this application
	delay - left-up @ 1 foot	FF,03,00,01,5D,61,FF	
	delay - left-dn @ 1 foot	FF,03,00,01,5E,62,FF	
	delay - center-up @ 1 foot	FF,03,00,01,5F,63,FF	
	delay - center-dn @ 1 foot	FF,03,00,01,60,64,FF	
	delay - right-up @ 1 foot	FF,03,00,01,61,65,FF	
	delay - right-dn @ 1 foot	FF,03,00,01,62,66,FF	
	delay - ls-up @ 1 foot	FF,03,00,01,63,67,FF	
	delay - ls-dn @ 1 foot	FF,03,00,01,64,68,FF	
	delay - rs-up @ 1 foot	FF,03,00,01,65,69,FF	
	delay - rs-dn @ 1 foot	FF,03,00,01,66,6A,FF	
	delay - sub-up @ 1 foot	FF,03,00,01,67,6B,FF	
	delay - sub-dn @ 1 foot	FF,03,00,01,68,6C,FF	
	delay - lcs-up @ 1 foot	FF,03,00,01,69,6D,FF	
	delay - lcs-dn @ 1 foot	FF,03,00,01,6A,6E,FF	
	delay - rcs-up @ 1 foot	FF,03,00,01,6B,6F,FF	
	delay - rcs-dn @ 1 foot	FF,03,00,01,6C,70,FF	
	spk - cs-none	FF,03,00,01,6D,71,FF	
	spk - cs-small 1	FF,03,00,01,6E,72,FF	
	spk - cs-small 2	FF,03,00,01,6F,73,FF	
	spk - cs-large 1	FF,03,00,01,70,74,FF	
	spk - cs-large 2	FF,03,00,01,71,75,FF	
	RESERVED	FF,03,00,01,72,76,FF	
	RESERVED	FF,03,00,01,73,77,FF	
	RESERVED	FF,03,00,01,74,78,FF	
	RESERVED	FF,03,00,01,75,79,FF	
	update - re-eq - timbre - decorrelation	FF,03,00,01,76,7A,FF	
	mode - re-eq is forced on (active in a non-THX mode)	FF,03,00,01,77,7B,FF	
	mode - re-eq is forced off (active in a non-THX mode)	FF,03,00,01,78,7C,FF	
	mode - timbre match is forced on (active in a non-THX mode)	FF,03,00,01,79,7D,FF	
	mode - timbre match is forced off (active in a non-THX mode)	FF,03,00,01,7A,7E,FF	
	mode - decorrelation is forced on (active in a non-THX mode)	FF,03,00,01,7B,7F,FF	
	mode - decorrelation is forced off (active in a non-THX mode)	FF,03,00,01,7C,80,FF	
	spk - crossover-up	FF,03,00,01,7D,81,FF	
	spk - crossover-dn	FF,03,00,01,7E,82,FF	
	update - vol master	FF,03,00,01,7F,83,FF	
	update - format - mode - dynamicrange	FF,03,00,01,80,84,FF	
	update - format - mode - vol master	FF,03,00,01,81,85,FF	
	update - (vol) c - sub - l - r - ls - rs - lcs - rcs	FF,03,00,01,82,86,FF	
	update - (delay) c - sub - l - r - ls - rs - lcs - rcs	FF,03,00,01,83,87,FF	
	update - (spk setup) lr - c - surr - sub - cs - crossover	FF,03,00,01,84,88,FF	
	ASA - Back speakers are less than 12" apart	FF,03,00,01,85,89,FF	
	ASA - Back speakers are equal to or between 12"-48" apart	FF,03,00,01,86,8A,FF	
	ASA - Back speakers are greater than 48" apart	FF,03,00,01,87,8B,FF	
	RESERVED	FF,03,00,01,88,8C,FF	
	vol - master recall 1	FF,03,00,01,89,8D,FF	
	vol - master recall 2	FF,03,00,01,8A,8E,FF	
	vol - master recall 3	FF,03,00,01,8B,8F,FF	
	vol - master recall 4	FF,03,00,01,8C,90,FF	
	vol - master store 1	FF,03,00,01,8D,91,FF	
	vol - master store 2	FF,03,00,01,8E,92,FF	
	vol - master store 3	FF,03,00,01,8F,93,FF	
	vol - master store 4	FF,03,00,01,90,94,FF	

	vol - balance recall 1	FF,03,00,01,91,95,FF	
	vol - balance recall 2	FF,03,00,01,92,96,FF	
	vol - balance recall 3	FF,03,00,01,93,97,FF	
	vol - balance recall 4	FF,03,00,01,94,98,FF	
	vol - balance store 1	FF,03,00,01,95,99,FF	
	vol - balance store 2	FF,03,00,01,96,9A,FF	
	vol - balance store 3	FF,03,00,01,97,9B,FF	
	vol - balance store 4	FF,03,00,01,98,9C,FF	
	solo - center	FF,03,00,01,99,9D,FF	
	solo - sub	FF,03,00,01,9A,9E,FF	
	solo - left	FF,03,00,01,9B,9F,FF	
	solo - right	FF,03,00,01,9C,A0,FF	
	solo - leftsurr	FF,03,00,01,9D,A1,FF	
	solo - rightsurr	FF,03,00,01,9E,A2,FF	
	solo - leftsurr & rightsurr	FF,03,00,01,9F,A3,FF	
	solo - lcs	FF,03,00,01,A0,A4,FF	
	solo - rcs	FF,03,00,01,A1,A5,FF	
	tone - update include / exclude & freqs & levels in group a	FF,03,00,01,A2,A6,FF	
	tone - left include / exclude toggle in group a	FF,03,00,01,A3,A7,FF	
	tone - right include / exclude toggle in group a	FF,03,00,01,A4,A8,FF	
	tone - leftsurr include / exclude toggle in group a	FF,03,00,01,A5,A9,FF	
	tone - rightsurr include / exclude toggle in group a	FF,03,00,01,A6,AA,FF	
	tone - center include / exclude toggle in group a	FF,03,00,01,A7,AB,FF	
	tone - sub include / exclude toggle in group a	FF,03,00,01,A8,AC,FF	
	tone - lcs include / exclude toggle in group a	FF,03,00,01,A9,AD,FF	
	tone - rcs include / exclude toggle in group a	FF,03,00,01,AA,AE,FF	
	tone - treble freq up @ 1khz (range is 1khz to 30khz) in group a	FF,03,00,01,AB,AF,FF	
	tone - treble freq dn @ 1khz (range is 1khz to 30khz) in group a	FF,03,00,01,AC,B0,FF	
	tone - treble level up @ 1db (range is -20db to +20db) in group a	FF,03,00,01,AD,B1,FF	
	tone - treble level dn @ 1db (range is -20db to +20db) in group a	FF,03,00,01,AE,B2,FF	
	tone - bass freq up @ 20hz (range is 20hz to 980hz) in group a	FF,03,00,01,AF,B3,FF	
	tone - bass freq dn @ 20hz (range is 20hz to 980hz) in group a	FF,03,00,01,B0,B4,FF	
	tone - bass level up @ 1db (range is -20db to +20db) in group a	FF,03,00,01,B1,B5,FF	
	tone - bass level dn @ 1db (range is -20db to +20db) in group a	FF,03,00,01,B2,B6,FF	
	tone - update include / exclude & freqs & levels in group b	FF,03,00,01,B3,B7,FF	
	tone - left include / exclude toggle in group b	FF,03,00,01,B4,B8,FF	
	tone - right include / exclude toggle in group b	FF,03,00,01,B5,B9,FF	
	tone - leftsurr include / exclude toggle in group b	FF,03,00,01,B6,BA,FF	
	tone - rightsurr include / exclude toggle in group b	FF,03,00,01,B7,BB,FF	
	tone - center include / exclude toggle in group b	FF,03,00,01,B8,BC,FF	
	tone - sub include / exclude toggle in group b	FF,03,00,01,B9,BD,FF	
	tone - lcs include / exclude toggle in group b	FF,03,00,01,BA,BE,FF	
	tone - rcs include / exclude toggle in group b	FF,03,00,01,BB,BF,FF	
	tone - treble freq up @ 1khz (range is 1khz to 30khz) in group b	FF,03,00,01,BC,C0,FF	
	tone - treble freq dn @ 1khz (range is 1khz to 30khz) in group b	FF,03,00,01,BD,C1,FF	
	tone - treble level up @ 1db (range is -20db to +20db) in group b	FF,03,00,01,BE,C2,FF	
	tone - treble level dn @ 1db (range is -20db to +20db) in group b	FF,03,00,01,BF,C3,FF	
	tone - bass freq up @ 20hz (range is 20hz to 980hz) in group b	FF,03,00,01,C0,C4,FF	
	tone - bass freq dn @ 20hz (range is 20hz to 980hz) in group b	FF,03,00,01,C1,C5,FF	
	tone - bass level up @ 1db (range is -20db to +20db) in group b	FF,03,00,01,C2,C6,FF	
	tone - bass level dn @ 1db (range is -20db to +20db) in group b	FF,03,00,01,C3,C7,FF	
	RESERVED	FF,03,00,01,C4,C8,FF	
	RESERVED	FF,03,00,01,C5,C9,FF	
	RESERVED	FF,03,00,01,C6,CA,FF	*reserved for this application
	RESERVED	FF,03,00,01,C7,CB,FF	*reserved for this application
	RESERVED	FF,03,00,01,C8,CC,FF	*reserved for this application
	bass manager - noise bass	FF,03,00,01,C9,CD,FF	
	spk - enables attenuation for dts's LFE (defaults back to disable at restart)	FF,03,00,01,CA,CE,FF	
	spk - disables attenuation for dts's LFE (restart default)	FF,03,00,01,CB,CF,FF	
	bass manager - limiter ceiling up @ 0.5db	FF,03,00,01,CC,DD,FF	
	bass manager - limiter ceiling dn @ 0.5db	FF,03,00,01,CD,D1,FF	
	bass manager - limiter on	FF,03,00,01,CE,D2,FF	not recommended for any application
	RESERVED	FF,03,00,01,CF,D3,FF	
	tone - recall 1	FF,03,00,01,D0,D4,FF	
	tone - recall 2	FF,03,00,01,D1,D5,FF	
	tone - recall 3	FF,03,00,01,D2,D6,FF	
	tone - recall 4	FF,03,00,01,D3,D7,FF	
	tone - store 1	FF,03,00,01,D4,D8,FF	
	tone - store 2	FF,03,00,01,D5,D9,FF	
	tone - store 3	FF,03,00,01,D6,DA,FF	
	tone - store 4	FF,03,00,01,D7,DB,FF	
	vol - maximum volume up @ 0.5db	FF,03,00,01,D8,DC,FF	
	vol - maximum volume dn @ 0.5db	FF,03,00,01,D9,DD,FF	
	vol - turnon volume preset up	FF,03,00,01,DA,DE,FF	
	vol - turnon volume preset dn	FF,03,00,01,DB,DF,FF	
	update - maximum volume / turnon preset volume	FF,03,00,01,DC,E0,FF	
	analog - input gain increase	FF,03,00,01,DD,E1,FF	
	analog - input gain decrease	FF,03,00,01,DE,E2,FF	
	update - input gain	FF,03,00,01,DF,E3,FF	
	spk - increment attenuation for dts's LFE	FF,03,00,01,E0,E4,FF	
	spk - decrement attenuation for dts's LFE	FF,03,00,01,E1,E5,FF	
	mode - 5 channel enhanced stereo effect level-up @ 1db	FF,03,00,01,E2,E6,FF	
	mode - 5 channel enhanced stereo effect level-dn @ 1db	FF,03,00,01,E3,E7,FF	
	mode - 5 channel enhanced stereo effect delay-up @ 1ms	FF,03,00,01,E4,E8,FF	
	mode - 5 channel enhanced stereo effect delay-dn @ 1ms	FF,03,00,01,E5,E9,FF	
	mode - 5 channel enhanced mono effect level-up @ 1db	FF,03,00,01,E6,EA,FF	
	mode - 5 channel enhanced mono effect level-dn @ 1db	FF,03,00,01,E7,EB,FF	
	mode - 5 channel enhanced mono effect delay-up @ 1ms	FF,03,00,01,E8,EC,FF	
	mode - 5 channel enhanced mono effect delay-dn @ 1ms	FF,03,00,01,E9,ED,FF	
	RESERVED	FF,03,00,01,EA,EE,FF	*reserved for this application

	update - PII music and PII custom parameters	FF,03,00,01,EB,EF,FF	
	PII CUSTOM MODE/MUSIC MODE - DIMENSION CONTROL UP	FF,03,00,01,EC,F0,FF	
	PII CUSTOM MODE/MUSIC MODE - DIMENSION CONTROL DN	FF,03,00,01,ED,F1,FF	
	PII CUSTOM MODE/MUSIC MODE - PANORAMA ON	FF,03,00,01,EE,F2,FF	
	PII CUSTOM MODE/MUSIC MODE - PANORAMA OFF	FF,03,00,01,EF,F3,FF	
	PII CUSTOM MODE/MUSIC MODE - CENTER WIDTH UP	FF,03,00,01,F0,F4,FF	
	PII CUSTOM MODE/MUSIC MODE - CENTER WIDTH DN	FF,03,00,01,F1,F5,FF	
	PII CUSTOM MODE - AUTOBALANCE ON	FF,03,00,01,F2,F6,FF	
	PII CUSTOM MODE - AUTOBALANCE OFF	FF,03,00,01,F3,F7,FF	
	PII CUSTOM MODE - FILTER FULL SURROUND	FF,03,00,01,F4,F8,FF	
	PII CUSTOM MODE - FILTER 7kHz CUTOFF LPF	FF,03,00,01,F5,F9,FF	
	PII CUSTOM MODE - FILTER SHELF	FF,03,00,01,F6,FA,FF	
	PII CUSTOM MODE - RS POLARITY INVERSE ON	FF,03,00,01,F7,FB,FF	
	PII CUSTOM MODE - RS POLARITY INVERSE OFF	FF,03,00,01,F8,FC,FF	
	PII CUSTOM MODE - MATRIX COEF 1	FF,03,00,01,F9,FD,FF	
	PII CUSTOM MODE - MATRIX COEF 2	FF,03,00,01,FA,FE,FF	
	PII CUSTOM MODE - MATRIX COEF 3	FF,03,00,01,FB,FF,FF	
	PII CUSTOM MODE - SURROUND DELAY ON	FF,03,00,01,FC,00,FF	
	PII CUSTOM MODE - SURROUND DELAY OFF	FF,03,00,01,FD,01,FF	
	RESERVED	FF,03,00,01,FE,02,FF	*reserved for this application
	RESERVED	FF,03,00,01,FF,03,FF	*reserved for this application
DSP CINEMA MODE COMMANDS 2 (commands are ignored if system is in quad mode)			
	RESERVED		*all above are reserved for this application
	mode - scroll up (FOR ALL MATERIAL)	FF,03,00,10,2E,41,FF	
	mode - scroll down (FOR ALL MATERIAL)	FF,03,00,10,2F,42,FF	
	mode - Stereo Downmix (FOR NON 2.0 MATERIAL)	FF,03,00,10,30,43,FF	
	mode - Mono Downmix (FOR NON 2.0 MATERIAL)	FF,03,00,10,31,44,FF	
	mode - Discrete + Direct (FOR NON 2.0 MATERIAL)	FF,03,00,10,32,45,FF	
	mode - Discrete (FOR NON 2.0 MATERIAL)	FF,03,00,10,33,46,FF	
	mode - Discrete + THX (FOR NON 2.0 MATERIAL)	FF,03,00,10,34,47,FF	
	mode - Discrete + EX/ES (FOR NON 2.0 MATERIAL)	FF,03,00,10,35,48,FF	
	mode - THX + EX/ES (FOR NON 2.0 MATERIAL)	FF,03,00,10,36,49,FF	
	mode - THX Ultra2 Cinema (FOR NON 2.0 MATERIAL)	FF,03,00,10,37,4A,FF	
	mode - THX MusicMode (FOR NON 2.0 MATERIAL)	FF,03,00,10,38,4B,FF	
	RESERVED		*all in between are reserved for this application
	mode - Stereo (FOR 2.0 MATERIAL)	FF,03,00,10,50,63,FF	
	mode - Mono (FOR 2.0 MATERIAL)	FF,03,00,10,51,64,FF	
	mode - DTS Neo:6 (FOR 2.0 MATERIAL)	FF,03,00,10,52,65,FF	
	mode - DTS Neo:6 + THX (FOR 2.0 MATERIAL)	FF,03,00,10,53,66,FF	
	mode - ProLogic II Prologic (FOR 2.0 MATERIAL)	FF,03,00,10,54,67,FF	
	mode - ProLogic II Prologic + THX (FOR 2.0 MATERIAL)	FF,03,00,10,55,68,FF	
	mode - ProLogic II Movie (FOR 2.0 MATERIAL)	FF,03,00,10,56,69,FF	
	mode - ProLogic II Movie + THX (FOR 2.0 MATERIAL)	FF,03,00,10,57,6A,FF	
	mode - ProLogic II Matrix (FOR 2.0 MATERIAL)	FF,03,00,10,58,6B,FF	
	mode - ProLogic II Virtual (FOR 2.0 MATERIAL)	FF,03,00,10,59,6C,FF	
	mode - ProLogic II Music (FOR 2.0 MATERIAL)	FF,03,00,10,5A,6D,FF	
	mode - ProLogic II Custom1 (FOR 2.0 MATERIAL)	FF,03,00,10,5B,6E,FF	
	mode - ProLogic II Custom1+THX (FOR 2.0 MATERIAL)	FF,03,00,10,5C,6F,FF	
	mode - ProLogic II Custom2 (FOR 2.0 MATERIAL)	FF,03,00,10,5D,70,FF	
	mode - ProLogic II Custom2+THX (FOR 2.0 MATERIAL)	FF,03,00,10,5E,71,FF	
	mode - ProLogic II Custom3 (FOR 2.0 MATERIAL)	FF,03,00,10,5F,72,FF	
	mode - ProLogic II Custom3+THX (FOR 2.0 MATERIAL)	FF,03,00,10,60,73,FF	
	mode - Quad/Hex Bypass (FOR 2.0 MATERIAL)	FF,03,00,10,61,74,FF	
	mode - Stereo Enhance (FOR 2.0 MATERIAL)	FF,03,00,10,62,75,FF	
	mode - Mono Enhance (FOR 2.0 MATERIAL)	FF,03,00,10,63,76,FF	
	mode - Stereo 5 / Stereo for Surround Encoded (FOR 2.0 MATERIAL)	FF,03,00,10,64,77,FF	
	mode - Mono 5 / Stereo for Surround Encoded (FOR 2.0 MATERIAL)	FF,03,00,10,65,78,FF	
	mode - Stadium / Stereo for Surround Encoded (FOR 2.0 MATERIAL)	FF,03,00,10,66,79,FF	
	mode - Theater / Stereo for Surround Encoded (FOR 2.0 MATERIAL)	FF,03,00,10,67,7A,FF	
	mode - Hall / Stereo for Surround Encoded (FOR 2.0 MATERIAL)	FF,03,00,10,68,7B,FF	
	mode - Club / Stereo for Surround Encoded (FOR 2.0 MATERIAL)	FF,03,00,10,69,7C,FF	
	mode - Church / Stereo for Surround Encoded (FOR 2.0 MATERIAL)	FF,03,00,10,6A,7D,FF	
	mode - change mode to THX (if applicable) (FOR ANY MATERIAL)	FF,03,00,10,6B,7E,FF	
	mode - User Mode (FOR ANY MATERIAL) (setup execute)	FF,03,00,10,6C,7F,FF	
	mode - Stereo (FOR ANY MATERIAL) (setup previous step)	FF,03,00,10,6D,80,FF	
	mode - Mono (FOR ANY MATERIAL) (setup next step)	FF,03,00,10,6E,81,FF	
	RESERVED		*all in between are reserved for this application
	input - Select input 1	FF,03,00,10,70,83,FF	
	input - Select input 2	FF,03,00,10,71,84,FF	
	input - Select input 3	FF,03,00,10,72,85,FF	
	input - Select input 4	FF,03,00,10,73,86,FF	
	input - Select input 5	FF,03,00,10,74,87,FF	
	input - Select input 6	FF,03,00,10,75,88,FF	
	input - Select input 7	FF,03,00,10,76,89,FF	
	input - Select input 8	FF,03,00,10,77,8A,FF	
	input - Select input 9	FF,03,00,10,78,8B,FF	
	input - Select input 10	FF,03,00,10,79,8C,FF	
	input - Select input 11	FF,03,00,10,7A,8D,FF	
	input - Select input 12	FF,03,00,10,7B,8E,FF	
	input - Select input 13	FF,03,00,10,7C,8F,FF	
	input - Select input 14	FF,03,00,10,7D,90,FF	
	input - Select input 15	FF,03,00,10,7E,91,FF	
	input - Select input 16	FF,03,00,10,7F,92,FF	
	input - Select input 17	FF,03,00,10,80,93,FF	
	input - Select input 18	FF,03,00,10,81,94,FF	
	input - Select input 19	FF,03,00,10,82,95,FF	
	input - Select input 20	FF,03,00,10,83,96,FF	
	update - input	FF,03,00,10,84,97,FF	

RESERVED	FF,03,00,10,85,98,FF	*reserved for this application
RESERVED	FF,03,00,10,86,99,FF	*reserved for this application
RESERVED	FF,03,00,10,87,9A,FF	*reserved for this application
RESERVED	FF,03,00,10,88,9B,FF	*reserved for this application
RESERVED	FF,03,00,10,89,9C,FF	*reserved for this application
RESERVED	FF,03,00,10,8A,9D,FF	*reserved for this application
RESERVED	FF,03,00,10,8B,9E,FF	*reserved for this application
RESERVED	FF,03,00,10,8C,9F,FF	*reserved for this application
RESERVED	FF,03,00,10,8D,A0,FF	*reserved for this application
RESERVED	FF,03,00,10,8E,A1,FF	*reserved for this application
RESERVED	FF,03,00,10,8F,A2,FF	*reserved for this application
record - Select record 1	FF,03,00,10,90,A3,FF	
record - Select record 2	FF,03,00,10,91,A4,FF	
record - Select record 3	FF,03,00,10,92,A5,FF	
record - Select record 4	FF,03,00,10,93,A6,FF	
record - Select record 5	FF,03,00,10,94,A7,FF	
record - Select record 6	FF,03,00,10,95,A8,FF	
record - Select record 7	FF,03,00,10,96,A9,FF	
record - Select record 8	FF,03,00,10,97,AA,FF	
record - Select record 9	FF,03,00,10,98,AB,FF	
record - Select record 10	FF,03,00,10,99,AC,FF	
record - Select record 11	FF,03,00,10,9A,AD,FF	
record - Select record 12	FF,03,00,10,9B,AE,FF	
record - Select record 13	FF,03,00,10,9C,AF,FF	
record - Select record 14	FF,03,00,10,9D,B0,FF	
record - Select record 15	FF,03,00,10,9E,B1,FF	
record - Select record 16	FF,03,00,10,9F,B2,FF	
record - Select record 17	FF,03,00,10,A0,B3,FF	
record - Select record 18	FF,03,00,10,A1,B4,FF	
record - Select record 19	FF,03,00,10,A2,B5,FF	
record - Select record 20	FF,03,00,10,A3,B6,FF	
update - record	FF,03,00,10,A4,B7,FF	
RESERVED		*all below are reserved for this application
DSP CINEMA MODE COMMANDS 3 (commands are ignored if system is in quad mode)		
vol - master-up direct (step 1)	FF,03,ADDRESS,11,VOLUME,FF	If step 2 if not sent in less than 100ms command is cancelled
vol - master-dn direct (step 2)	FF,03,ADDRESS,12,VOLUME,FF	
GLOBAL COMMANDS 1 (card address is ignored. unit address is not ignored)		
RESERVED		*all above are reserved for this application
null	FF,03,ADDRESS,03,05,FF	
update - send all possible information	FF,03,ADDRESS,03,06,FF	
update - card version	FF,03,ADDRESS,03,07,FF	
all zones mute & off followed by a system power off	FF,03,ADDRESS,03,08,FF	DC voltage is absent within all zones
system power off	FF,03,ADDRESS,03,09,FF	DC voltage is absent within all zones
system power on	FF,03,ADDRESS,03,0A,FF	DC voltage is present within all zones
RESERVED		*all below are reserved for this application
GLOBAL COMMANDS 2 (card address is ignored. unit address is ignored)		
RESERVED		*all above are reserved for this application
null	FF,03,ADDRESS,04,05,FF	
update - send all possible information	FF,03,ADDRESS,04,06,FF	
update - card version	FF,03,ADDRESS,04,07,FF	
all zones mute followed by a system power off	FF,03,ADDRESS,04,08,FF	DC voltage is absent within all possible zones
system power off	FF,03,ADDRESS,04,09,FF	DC voltage is absent within all possible zones
system power on	FF,03,ADDRESS,04,0A,FF	DC voltage is present within all possible zones
RESERVED		*all below are reserved for this application

The chart below indicates all possible feedback in ASCII. The Cinema Rhapsody Mach II provides this feedback in Hex which then needs to be converted to ASCII.

GENERAL 12 CHARACTER COMPLEX FEEDBACK (all possibilities)		
"RELEASE ###"	### is subject to change	
DSP CINEMA 12 CHARACTER COMPLEX FEEDBACK (all possibilities)		
"SYSTEM OFF "		
"PNG ###"		
"PCM ###"		
"DD ###"		
"DTS ###"		
"OUT ###"		
"DIR 3.2.1.2"		
"STEREO DNMX "	"C ## FEET"	"LEFT A OUT"
"MONO DNMX "	"SUB ## FEET"	"LEFT A IN"
"DIRECT "	"L ## FEET"	"RIGHT A OUT"
"DISCRETE "	"R ## FEET"	"RIGHT A IN"
"DISCRETE+THX"	"LS ## FEET"	"LS A OUT"
"DISCRT+EX/ES"	"RS ## FEET"	"LS A IN"
"THX + EX/ES "	"LCS ## FEET"	"RS A OUT"
"THX ULTRA2 "	"RCS ## FEET"	"RS A IN"
"THX MUSIC "		"CENTER A OUT"
"STEREO "	"QUAD MODE "	"CENTER A IN"
"MONO "	"QUAD ?"	"SUB A OUT"
"DTS NEO 6 "	"QUAD ??"	"SUB A IN"
"DTS NEO6+THX"		"LCS A OUT"
"PROLOGIC "	"ALL -##.# DB"	"LCS A IN"
"PROLOGIC+THX"	"ALL +##.# DB"	"RCS A OUT"
"PLII MOVIE "	"ALL 0.0 DB"	"RCS A IN"
"PLII MVE+THX"	"ALL MUTED"	
"PLII MATRIX "		"LEFT B OUT"
"PLII VIRTUAL"	"C -##.# DB"	"LEFT B IN"
"PLII MUSIC "	"C +##.# DB"	"RIGHT B OUT"
"PLII CUSTOM1"	"C 0.0 DB"	"RIGHT B IN"
"PLII CM1+THX"	"C MUTED"	"LS B OUT"
"PLII CUSTOM2"		"LS B IN"
"PLII CM2+THX"	"SUB -##.# DB"	"RS B OUT"
"PLII CUSTOM3"	"SUB +##.# DB"	"RS B IN"
"PLII CM3+THX"	"SUB 0.0 DB"	"CENTER B OUT"
"QUAD BYPASS "	"SUB MUTED"	"CENTER B IN"
"STEREO ENH "		"SUB B OUT"
"MONO ENH "	"L -##.# DB"	"SUB B IN"
"STEREO 5 "	"L +##.# DB"	"LCS B OUT"
"MONO 5 "	"L 0.0 DB"	"LCS B IN"
"STADIUM "	"L MUTED"	"RCS B OUT"
"THEATER "		"RCS B IN"
"HALL "	"R -##.# DB"	
"CLUB "	"R +##.# DB"	"TRE B ##K HZ"
"CHURCH "	"R 0.0 DB"	"TRE B +## DB"
	"R MUTED"	"TRE B -## DB"
"NOISE SEQ"		"TRE B 0 DB"
"NOISE CENTER"	"LS -##.# DB"	
"NOISE SUB "	"LS +##.# DB"	"BAS B ### HZ"
"NOISE LEFT "	"LS 0.0 DB"	"BAS B +## DB"
"NOISE RIGHT "	"LS MUTED"	"BAS B -## DB"
"NOISE L SURR"		"BAS B 0 DB"
"NOISE R SURR"	"RS -##.# DB"	
"NOISE L BACK"	"RS +##.# DB"	"LIM -##.# DB"
"NOISE R BACK"	"RS 0.0 DB"	"LIMITER OFF"
	"RS MUTED"	
"MASTER STR"		"AC3 DR @ MAX"
	"LCS -##.# DB"	"AC3 DR @ MID"
"BALANCE STR"	"LCS +##.# DB"	"AC3 DR @ MIN"
	"LCS 0.0 DB"	
"FRONT LARGE"	"LCS MUTED"	"TONES STR "
"FRONT SMALL"		
"CENTER LARGE"	"RCS -##.# DB"	"VOL LASTUSE"
"CENTER SMALL"	"RCS +##.# DB"	"VOL RECALL1"
"CENTER NONE"	"RCS 0.0 DB"	"VOL RECALL2"
"SURR LARGE"	"RCS MUTED"	"VOL RECALL3"
"SURR SMALL"		"VOL RECALL4"
"SURR NONE"	"TRE A ##K HZ"	
"BACK 2 LARGE"	"TRE A +## DB"	"MAX -##.# DB"
"BACK 1 LARGE"	"TRE A -## DB"	"MAX +##.# DB"
"BACK 2 SMALL"	"TRE A 0 DB"	"MAX 0.0 DB"
"BACK 1 SMALL"		
"BACK NONE"	"BAS A ### HZ"	
"SUB ACTIVE"	"BAS A +## DB"	
"SUB INACTIVE"	"BAS A -## DB"	
"FILTER ###HZ"	"BAS A 0 DB"	
*Commands may be subject to change.		
*For Cinema Reference II, BAUD rate is assigned in the software of the system.		
*For Cinema Reference II, the ADDRESS is assigned in the software of the system.		
*If unit is off then all commands issued to this unit will get the response "SYSTEM OFF".		