



KP/KV/KVS Series

KVM Rear Kit for LCD Console Drawer

User Manual

KP/KV/KVS Series: Combo KVM Switch 8/16 port with
1/2 user console



14628 Central Ave,
Chino, CA 91710
tel:909.597.7588, fax:909.597.1939

© Copyright 2013 Acnodes, Inc.
All rights reserved. Product description and product specifications
are subject to change without notice. For latest product
information, please visit Acnodes' web site at www.acnodes.com.

Legal Information

First English printing, October 2002

Information in this document has been carefully checked for accuracy; however, no guarantee is given to the correctness of the contents. The information in this document is subject to change without notice. We are not liable for any injury or loss that results from the use of this equipment.

Safety Instructions

Please read all of these instructions carefully before you use the device. Save this manual for future reference.

- Unplug equipment before cleaning. Don't use liquid or spray detergent; use a moist cloth.
- Keep equipment away from excessive humidity and heat. Preferably, keep it in an air-conditioned environment with temperatures not exceeding 40° Celsius (104° Fahrenheit).
- When installing, place the equipment on a sturdy, level surface to prevent it from accidentally falling and causing damage to other equipment or injury to persons nearby.
- When the equipment is in an open position, do not cover, block or in any way obstruct the gap between it and the power supply. Proper air convection is necessary to keep it from overheating.
- Arrange the equipment's power cord in such a way that others won't trip or fall over it.
- If you are using a power cord that didn't ship with the equipment, ensure that it is rated for the voltage and current labeled on the equipment's electrical ratings label. The voltage rating on the cord should be higher than the one listed on the equipment's ratings label.
- Observe all precautions and warnings attached to the equipment.
- If you don't intend on using the equipment for a long time, disconnect it from the power outlet to prevent being damaged by transient over-voltage.
- Keep all liquids away from the equipment to minimize the risk of accidental spillage. Liquid spilled on to the power supply or on other hardware may cause damage, fire or electrical shock.
- Only qualified service personnel should open the chassis. Opening it yourself could damage the equipment and invalidate its warranty.
- If any part of the equipment becomes damaged or stops functioning, have it checked by qualified service personnel.

What the warranty does not cover

- Any product, on which the serial number has been defaced, modified or removed.
- Damage, deterioration or malfunction resulting from:
 - Accident, misuse, neglect, fire, water, lightning, or other acts of nature, unauthorized product modification, or failure to follow instructions supplied with the product.
 - Repair or attempted repair by anyone not authorized by us.
 - Any damage of the product due to shipment.
 - Removal or installation of the product.
 - Causes external to the product, such as electric power fluctuation or failure.
 - Use of supplies or parts not meeting our specifications.
 - Normal wear and tear.
 - Any other causes which does not relate to a product defect.
- Removal, installation, and set-up service charges.

Regulatory Notices Federal Communications Commission (FCC)

This equipment has been tested and found to comply with the limits for a Class B digital device, pursuant to Part 15 of the FCC rules. These limits are designed to provide reasonable protection against harmful interference in a residential installation.

Any changes or modifications made to this equipment may void the user's authority to operate this equipment. This equipment generates, uses, and can radiate radio frequency energy and, if not installed and used in accordance with the instructions, may cause harmful interference to radio communications.

However, there is no guarantee that interference will not occur in a particular installation. If this equipment does cause harmful interference to radio or television reception, which can be determined by turning the equipment off and on, the user is encouraged to try to correct the interference by one or more of the following measures:

- Re-position or relocate the receiving antenna.
- Increase the separation between the equipment and receiver.
- Connect the equipment into an outlet on a circuit different from that to which the receiver is connected.

Contents

< Part 1 > Combo DB-15 KVM Kit

KP802	KP1602
-------	--------

- | | | |
|-----|-----------------------|-----|
| 1.1 | Package contents | P.1 |
| 1.2 | KVM port connection | P.2 |
| 1.3 | IP console connection | P.2 |
| 1.4 | IP console setting | P.3 |
| 1.5 | KVM Cascade | P.4 |
| 1.6 | Specifications | P.5 |

< Part 2 > Combo DB-15 2-console KVM Kit

KV802	KV1602
-------	--------

- | | | |
|-----|---------------------------|---------|
| 2.1 | Package contents | P.6 |
| 2.2 | KVM port connection | P.7 |
| 2.3 | Remote console connection | P.7 - 8 |
| 2.4 | KVM Cascade | P.9 |
| 2.5 | Specifications | P.10 |

< Part 3 > Combo DB-15 KVM Kit

KVS801	KVS1601
--------	---------

- | | | |
|-----|---------------------|------|
| 3.1 | Package contents | P.11 |
| 3.2 | KVM port connection | P.12 |
| 3.3 | KVM Cascade | P.13 |
| 3.4 | Specifications | P.14 |

< Part 4 > Usage

- | | | |
|-----|------------------------------------|------|
| 4.1 | KVM Button | P.15 |
| 4.2 | Password | P.16 |
| 4.3 | KVM OSD | P.17 |
| 4.4 | KVM Hotkey & Remote Console Hotkey | P.18 |
| 4.5 | DC power 12V, 24V, 48V Input | P.19 |

< Part 1 > Combo DB-15 IP KVM

< 1.1 > Package Contents

KP802
KP1602

KVM Rear Kit

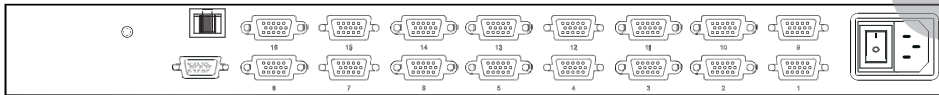

back



The power of the KVM rear kit may be changed to external power design based on the LCD console drawer series and model.

KP802

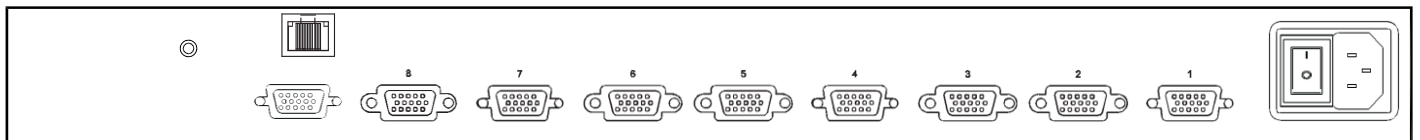

Cascade

Power

KP1602

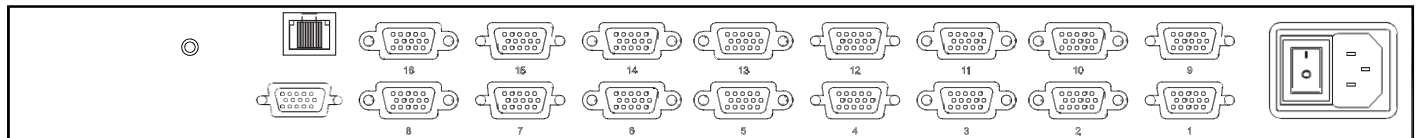

< 1.2 > KVM port connection

- 6 / 10 / 15 ft Combo KVM cable
- Support PS/2 or USB server



USB Servers

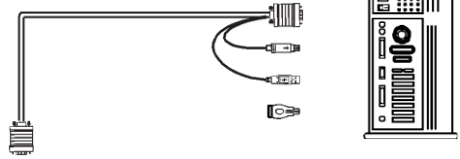

Combo KVM port

Drawer KVM Rear Kit

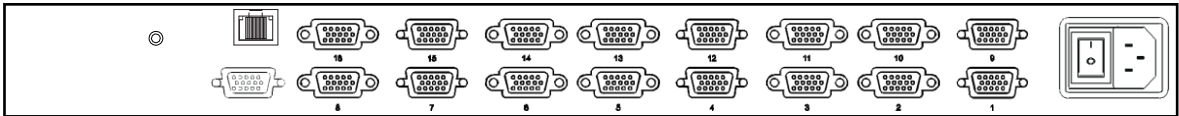

PS/2 Servers

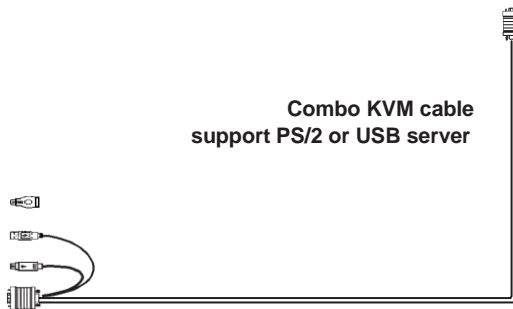

< 1.3 > IP console connection

CAT 5 / 6 cable
max. 100m

Network device
hub or router

Internet



Drawer KVM Rear Kit

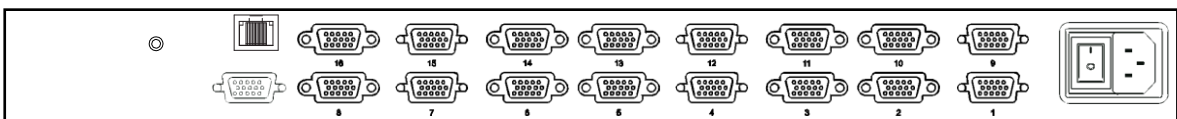

< 1.4 > IP console setting

After the cable connection, please take the following steps to configure the IP KVM :

1. Download [IPKVMsetup.exe](#)
2. Double click [IPKVMsetup.exe](#) to configure the IP KVM by device setup as below.

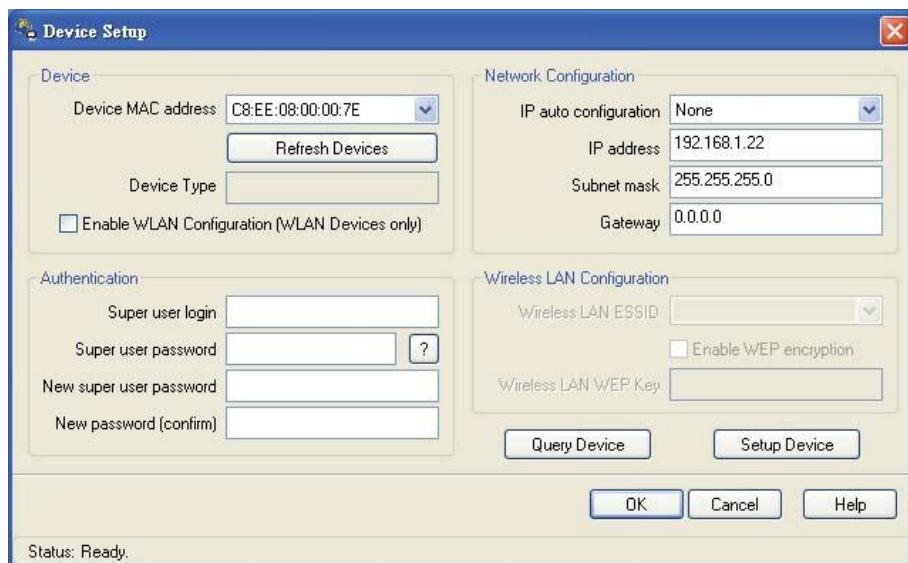

3. Click **Refresh Device** to search the connected IP KVM
4. Select the M.A.C. address, which you want to setup, then click **Query Device**
5. Enter Super user login. **The default is super**
6. Enter Super user password. **The default is pass**
7. Enter the new super user password
8. Re-enter the new password
9. Change the desired IP address / Subnet mask / Gateway, then click **Setup Device** to confirm the setting to IP KVM
10. The default address is as below:--
 - The single IP KVM model, such as KP-1602 - <http://192.168.1.22>

11. Open Internet Explorer (I.E.), version 6.0 or above

12. Enter the IP KVM address into the address bar
- For Single IP - <http://192.168.1.22>

13. Enter username (default is super)
Password (default is pass)

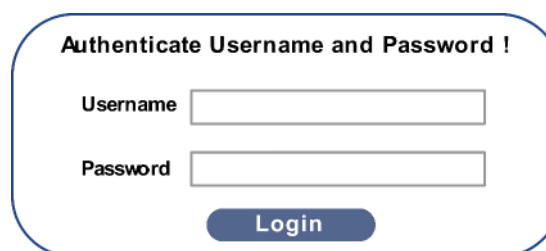

14. After successful login to IP KVM, the user will enter the main page of IP KVM

< 1.5 > KVM Cascade

- Cascade up to 8 levels, 128 servers
- Cascading multiple KVM with CBC-6 cascade cable.

! Cascaded KVMs from level 2 to 8 must be the models of KVS801 / KVS1601.

! When multiple combo DB-15 KVMs cascade together, the master KVM at level 1 will take all control of other slave KVM switches (e.g. level 2 to 8).

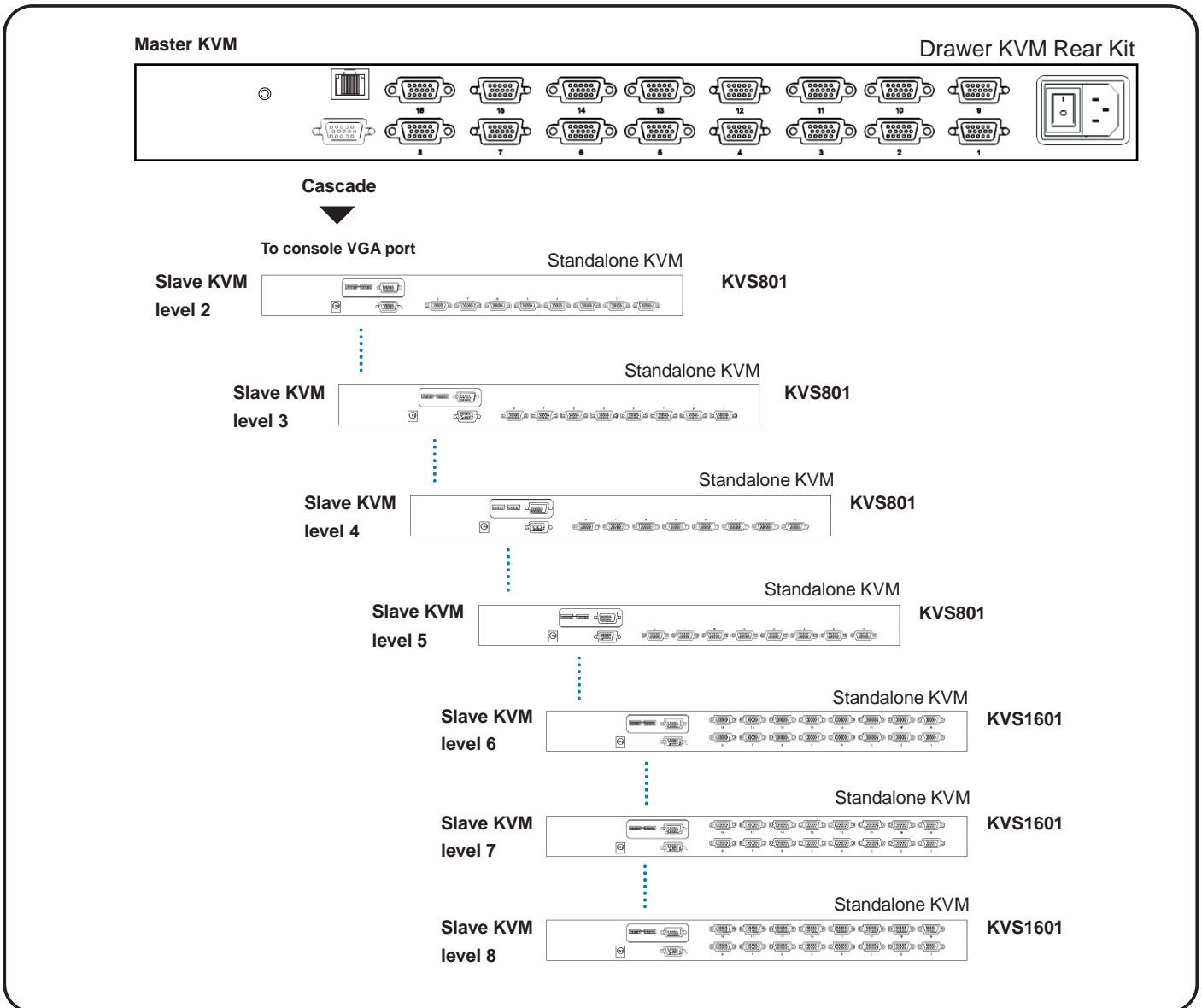

- 6ft Combo KVM cascade cable

< 1.6 > Specifications

	KP802	KP1602
■ KVM Port Number of ports: Connector: Connectivity:	8 or 16 Combo connector Combo 4-in-1 KVM cable, up to 6, 10 & 15 feet	
■ Local Console	Nil for LCD console drawer version	
■ IP Remote Console Connector: User management: Network protocol: Security: Resolution: Browser:	RJ45 Ethernet 15-user login, 1 x active user DHCP / BOOTP / DNS SSL v3, RSA, AES, HTTP / HTTPS, CSR Up to 1600 x 1200 IE, Firefox, Safari, Netscape	
■ Expansion:	Up to 128 servers by 8-level cascade	
■ Compatibility Multi-platform: Support:	Mix PCs, SUN and Mac G3 / G4 Mac / iMac Windows 7 / Vista / 2003 / XP, Linux, Unix	
■ Power Input: Option DC: Consumption:	100 or 240V AC at 50 or 60 Hz via IEC type cord 12V / 24V / 48V DC input Max. 24 Watt, Standby 5 Watt	
■ Regulatory Approval:	FCC, CE	
■ Environmental Operating: Storage: Relative humidity: Shock: Vibration:	0 to 50°C -5 to 60°C 90%, non-condensing 50G peak acceleration (11ms, half-sine wave) 58-100Hz / 0.98G (11ms / cycle)	

< Part 2 > Combo DB-15 2-console KVM

< 2.1 > Package Contents

KV802/1602

- Receiver box for remote console x 1
- Power adapter w/ power cord (for receiver) x 1
- 6ft Combo KVM cable for receiver box x 1

KVM Rear Kit

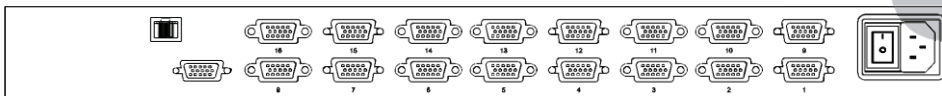

back



The power of the KVM rear kit may be changed to external power design based on the LCD console drawer series and model.

KV802

Remote

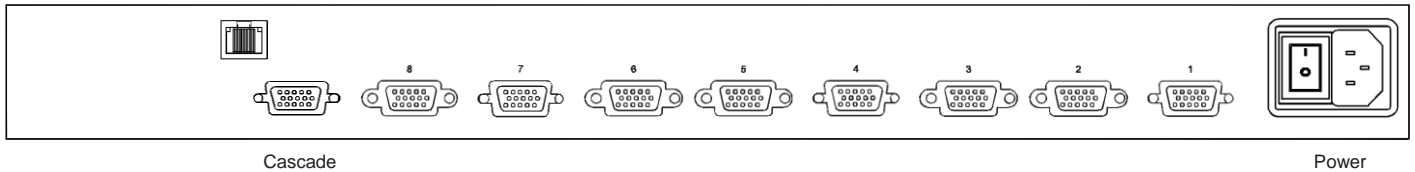

Cascade

Power

KV1602

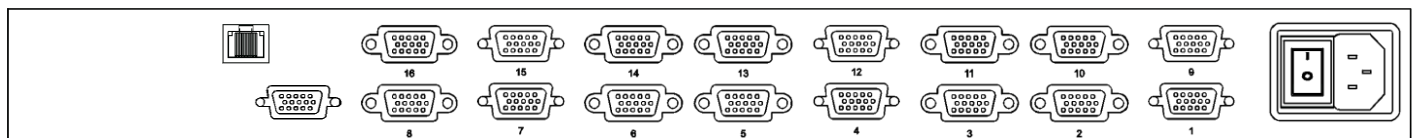

< 2.2 > KVM port connection

- 6 / 10 / 15 ft Combo KVM cable
- Support PS/2 or USB server



USB Servers

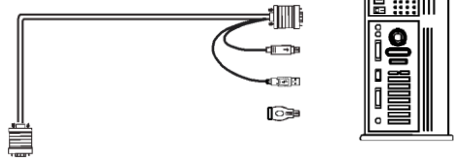

Combo KVM port

Drawer KVM Rear Kit

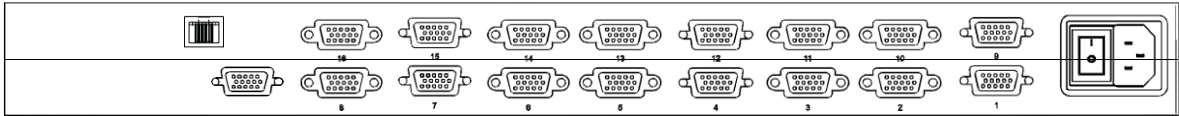

PS/2 Servers

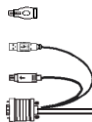
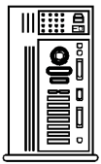

Combo KVM cable
support PS/2 or USB server



< 2.3 > Remote console connection

CAT 5 / 6 cable
max. 150m



Remote
Cat6
Console



Receiver



Remote
USB console

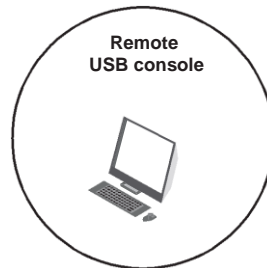

Drawer KVM Rear Kit

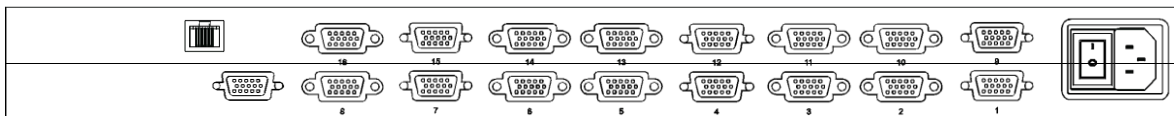

How to use a receiver to connect a remote console

Receiver

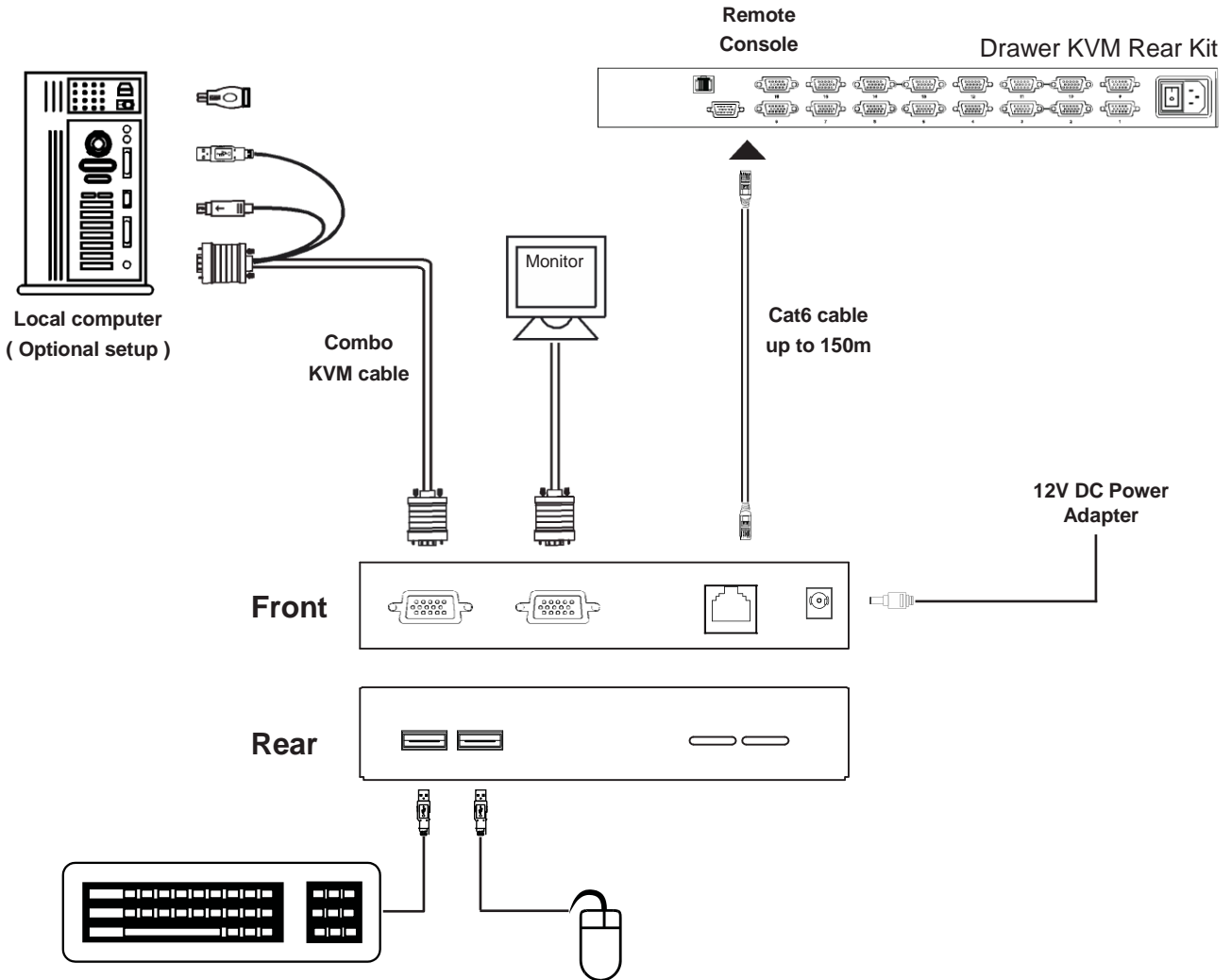
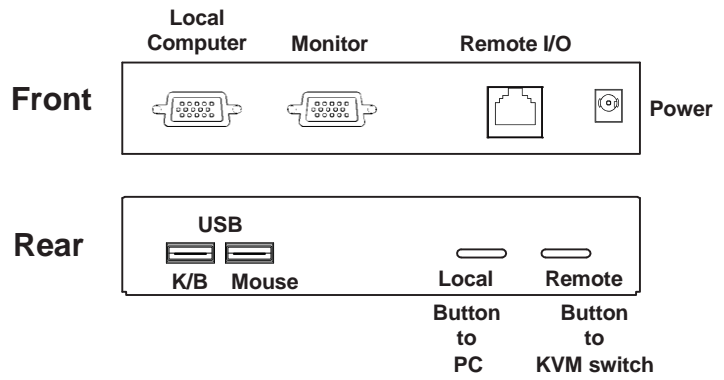

< 2.4 > KVM Cascade

- Cascade up to 8 levels, 128 servers
- Cascading multiple KVM with CBC-6 cascade cable.

! Cascaded KVMs from level 2 to 8 must be the models of KVS801 / KVS1601.

! When multiple combo DB-15 KVMs cascade together, the master KVM at level 1 will take all control of other slave KVM switches (e.g. level 2 to 8).

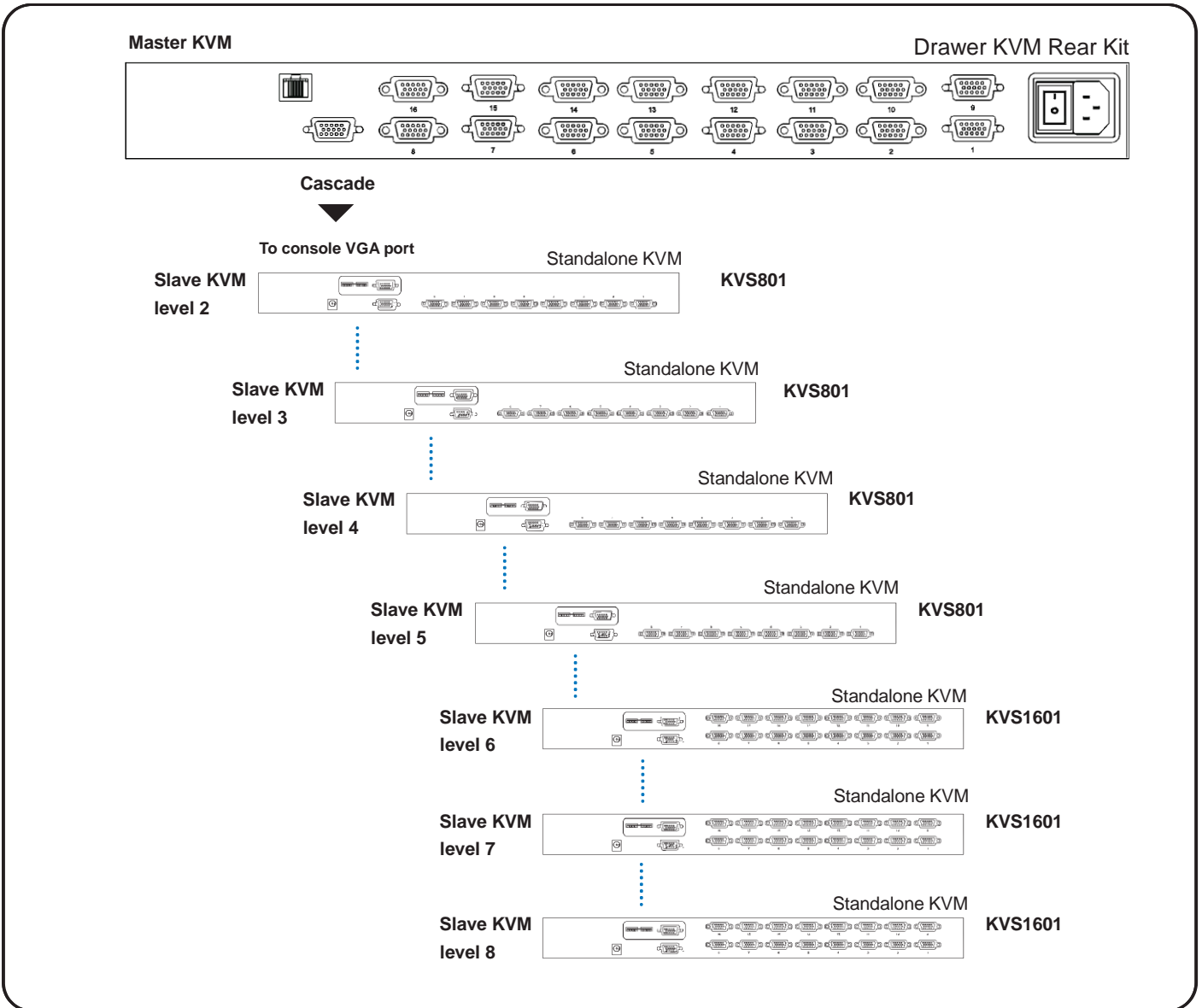

- 6ft Combo KVM cascade cable

< 2.5 > Specifications

	KV802	KV1602
■ KVM Port Number of ports: Connector: Connectivity:	8 or 16 Combo connector Combo 4-in-1 KVM cable, up to 6, 10 & 15 feet	
■ Local Console	Nil for LCD console drawer version	
■ Remote Console Connector: Resolution: Input device: Remote I/O: Compensation:	1 x DB 15-pin, VGA Up to 1600 x 1200 2 x USB type A for keyboard & mouse RJ45 via Cat5 / Cat5e / Cat6 cable up to 150m Auto adjust for cable length	
■ Expansion:	Up to 128 servers by 8-level cascade	
■ Compatibility Multi-platform: Support:	Mix PCs, SUN and Mac G3 / G4 Mac / iMac Windows 7 / Vista / 2003 / XP, Linux, Unix	
■ Power Input: Option DC: Consumption:	100 or 240V AC at 50 or 60 Hz via IEC type cord 12V / 24V / 48V DC input Max. 24 Watt, Standby 5 Watt	
■ Regulatory Approval:	FCC, CE	
■ Environmental Operating: Storage: Relative humidity: Shock: Vibration:	0 to 50°C -5 to 60°C 90%, non-condensing 50G peak acceleration (11ms, half-sine wave) 58~100Hz / 0.98G (11ms / cycle)	

< Part 3 > Combo DB-15 KVM

< 3.1 > Package Contents

KVS801
/1601

KVM Rear Kit

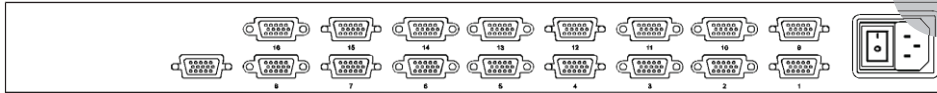

back



The power of the KVM rear kit may be changed to external power design based on the LCD console drawer series and model.

KVS801

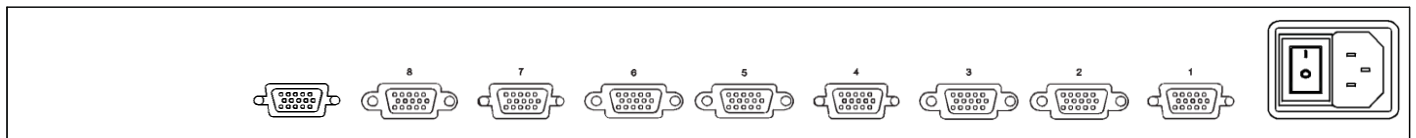

Cascade

Power

KVS1601

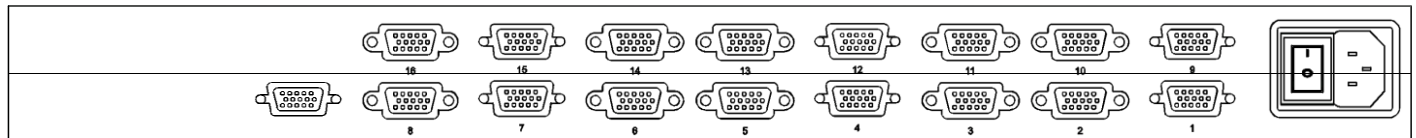

< 3.2 > KVM port connection

- 6 / 10 / 15 ft Combo KVM cable
- Support PS/2 or USB server



USB Servers

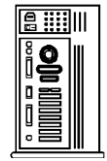

Combo KVM port

Drawer KVM Rear Kit

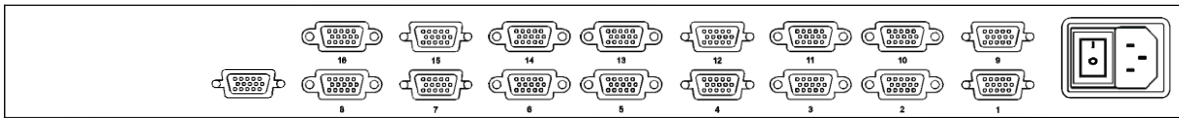

PS/2 Servers

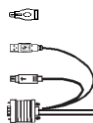
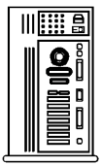

Combo KVM cable
support PS/2 or USB server



< 3.3 > KVM Cascade

- Cascade up to 8 levels, 128 servers
- Cascading multiple KVM with CBC-6 cascade cable.

! Cascaded KVMs from level 2 to 8 must be the models of **KVS801 / KVS1601**.

! When multiple combo DB-15 KVMs cascade together, the master KVM at level 1 will take all control of other slave KVM switches (e.g. level 2 to 8).

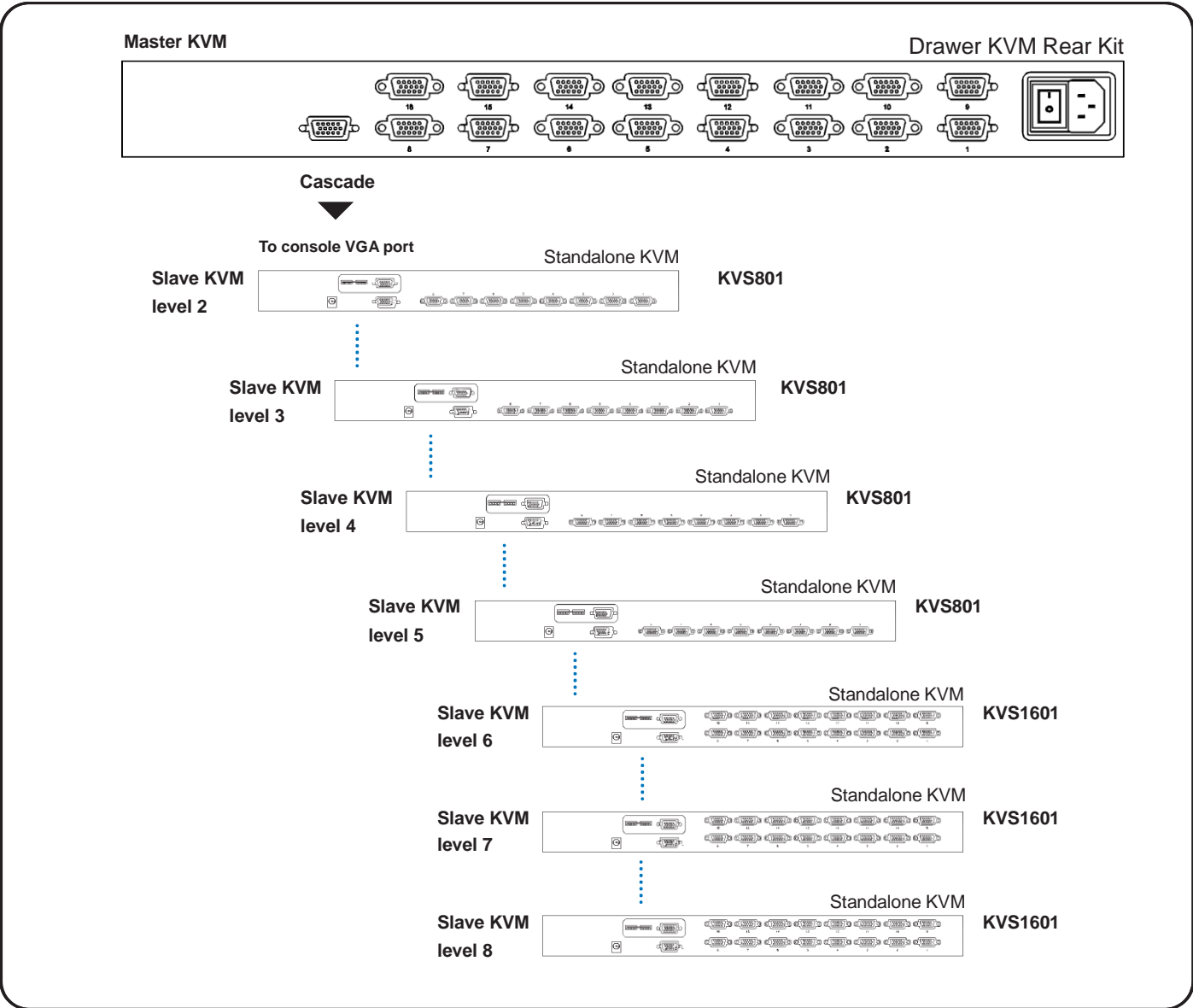

■ 6ft Combo KVM cascade cable

< 3.4 > Specifications

	KVS801	KVS1601
■ KVM Port Number of ports: Connector: Connectivity:	8 or 16 Combo connector Combo 4-in-1 KVM cable, up to 6, 10 & 15 feet	
■ Local Console	Nil for LCD console drawer version	
■ Management Multilingual OSD: Hotkey combination: Security: PC Selection:	English, France, German, Spanish, Italian, Russian, Simplified Chinese, Japanese Scroll-lock, Cap-lock, Num-lock, Alt, Ctrl & Win Password enable & disable, up to 8 users profile for port access Front button, OSD menu & hotkey	
■ Expansion:	Up to 128 servers by 8-level cascade	
■ Compatibility Multi-platform: Support:	Mix PCs, SUN and Mac G3 / G4 Mac / iMac Windows 7 / Vista / 2003 / XP, Linux, Unix	
■ Power Input: Option DC: Consumption:	100 or 240V AC at 50 or 60 Hz via IEC type cord 12V / 24V / 48V DC input Max. 24 Watt, Standby 5 Watt	
■ Regulatory Approval:	FCC, CE	
■ Environmental Operating: Storage: Relative humidity: Shock: Vibration:	0 to 50°C -5 to 60°C 90%, non-condensing 50G peak acceleration (11ms, half-sine wave) 58~100Hz / 0.98G (11ms / cycle)	

Part 4. Usage

4.1 KVM Button

Power ON

- Turn off all servers and KVM switches
- Make sure all cables / connectors are properly connected
- Recommend Power ON sequence is monitor, KVM switch finally computer

Front Panel - Port LED Indications

8 ports

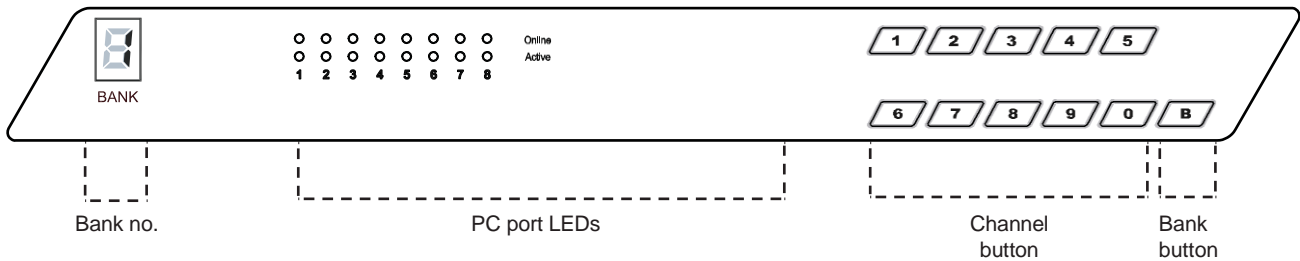

16 ports

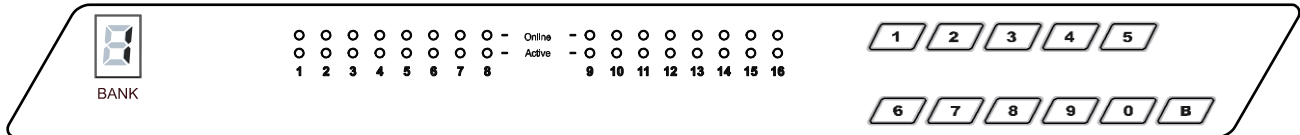

Bank no.	7-Segment BANK LED indication
PC port LEDs	Online : Blue LED on indicating a PC is connecting to the port Active : Green LED on indicating a selected channel
Channel button	Press to select channel from 01 to 16
Bank button	Select the bank from 1 to 8

< 4.2 > Password

The password is enabled by default, the default password is “00000000” eight zeros (**Do not use “0” on number pad**)

■ Enable password

1. Press the KVM hotkey **Scroll Lock + Scroll Lock + U**
2. Logout the KVM by pressing the hotkey **Scroll Lock + Scroll Lock + P**
3. In SUPERVISOR level, enter “00000000” eight zeros in user name & password field (**Do not use “0” on number pad**)
4. In USER level, press **Space bar + Enter** in user name & password field

Remark: Automatic logout after 10 minutes of inactivity

■ Set your own user name & password

1. Login the KVM in SUPERVISOR level by pressing “00000000” eight zeros in user name & password field
2. Call KVM OSD menu by pressing the KVM hotkey **Scroll Lock + Scroll Lock + Space Bar**
3. Press **F1** to the MAIN MENU
4. Select “USER SECURITY”
5. Set password in SUPERVISOR & USER level
 - a. In the left-top row “S” (SUPERVISOR), press **Enter** to set your own user name & password
 - b. In the row 1 to 8 (USER), press **Enter** to set your own user name & password
6. Press **Enter** to save the setting or press **Esc** to cancel the editing without any change

Remark: a. Blank has underscore, while SPACE doesn't have

- b. Press any alphanumeric key to move to next input item. SPACE is treated as a valid character

■ Change your password

1. Login the KVM in SUPERVISOR level by pressing your own user name & password
2. Call KVM OSD menu by pressing the KVM hotkey **Scroll Lock + Scroll Lock + Space Bar**
3. Press **F1** to the MAIN MENU
4. Select “USER SECURITY”
5. Change password in SUPERVISOR & USER level
 - a. In the left-top row “S” (SUPERVISOR), press **Enter** to change your user name & password
 - b. In the row 1 to 8 (USER), press **Enter** to change your user name & password
6. Press **Enter** to save the setting or press **Esc** to cancel the editing without any change

Remark: a. Blank has underscore, while SPACE doesn't have

- b. Press any alphanumeric key to move to next input item. SPACE is treated as a valid character

■ Disable your password

1. Press the KVM hotkey **Scroll Lock + Scroll Lock + U**
2. Logout the KVM by pressing the KVM hotkey **Scroll Lock + Scroll Lock + P**
3. You don't need user name & password to access the KVM OSD menu

■ Forget your password

Please contact your supplier for further support

Remark:



- You must press the KVM hotkey within 2 seconds
- A beep sound will be heard for successful entering KVM hotkey

< 4.3 > KVM OSD

OSD Menu

PORT NAME			
BANK : 1		F1 : MENU	
01	SYSTEM 01	F2 : LOGOUT	
02	SYSTEM 02	F3 : PREV	
03	SYSTEM 03	ESC : QUIT	
04	SYSTEM 04	ENTER : COMPLETE	
05	SYSTEM 05	↑/↓ : SELECT	
06	SYSTEM 06	PgUp/PgDn :	
07	SYSTEM 07	BANK SELECT	
08	SYSTEM 08		
		USER :	
		SUPERVISOR	
		SCAN TIME :	
		10 SEC FW1V3	

OSD operation

	next to the system name	The PC is powered on
	next to the system name	The PC is selected
F1		Access F1 MAIN MENU
F2		Logout the OSD menu
F3		Previous menu
Esc		Cancel / Quit
Enter		Complete / Switch to selected port
↑/↓		Switch to previous or next port
PgUp/PgDn		Switch to previous bank or next bank
1 / 2 / 3 / 4		Display port 01 ~ 08 / 09 ~ 16 / 17 ~ 24 / 25 ~ 32 Remark: Display port 17 ~ 32 for 32 port model only

F1 Main Menu

MAIN MENU		
SELECT OPTION :		
01	LANGUAGE	
02	PORT NAME EDIT	
03	PORT SEARCH	
04	USER SECURITY	
05	ACCESS LIST	
06	HOTKEY	
07	TIME SETTINGS	
08	OSD MOUSE	

01	LANGUAGE	OSD language change
02	PORT NAME EDIT	Define port name
03	PORT SEARCH	Quick searching by port name
04	USER SECURITY	Change password
05	ACCESS LIST	Define user access authority
06	HOTKEY	Change hotkey
07	TIME SETTINGS	Modify scan display time interval
08	OSD MOUSE	Modify OSD mouse speed

< 4.4 > KVM Hotkey & Remote Console Hotkey

Local Console Hotkey	Function
Scroll Lock + Scroll Lock + Space Bar	Calling OSD menu
Right-button mouse + Esc	Calling OSD menu
Scroll Lock + Scroll Lock + ↑	Switch to previous port
Scroll Lock + Scroll Lock + ↓	Switch to next port
Scroll Lock + Scroll Lock + PgUp / PgDn	Switch to previous bank or next bank
Scroll Lock + Scroll Lock + Bank no. + Port no.	Switch to specific port
Scroll Lock + Scroll Lock + B	Turn the buzzer ON and OFF * Default the buzzer is ON
Scroll Lock + Scroll Lock + P	Logout the KVM if password security is ON. Show up the status windows

Advance hotkeys (for Supervisor login only)

Scroll Lock + Scroll Lock + S	Activate auto-scan mode for connected servers *Press any key to exit the auto-scan mode
Scroll Lock + Scroll Lock + R	Reset all the KVM settings to factory default *Except User Security settings
Scroll Lock + Scroll Lock + U	Disable and enable password security *Default security is ON
Scroll Lock + Scroll Lock + L	To enable / disable the screen saving function and 10 minutes auto-logout *Default the screen saving is OFF

Remarks:

- Example of “**Scroll Lock + Scroll Lock + Bank no. + Port no.**”
 - Bank No. : 1 to 8
 - Port No. : 01 to 16
 - e.g. Bank 1 Port 4 : **Scroll Lock + Scroll Lock + 1 + 0 + 4**
 - e.g. Bank 2 Port 16 : **Scroll Lock + Scroll Lock + 2 + 1 + 6**
- You must press the hotkey within 2 seconds
- A beep sound will be heard for successful entering
- The numeric keypad is not supported, while in OSD screen, the arrow keys, PgUp, PgDn, and Enter keys are supports

Remote Console Hotkey	Function
Scroll Lock + Scroll Lock + C	Toggle switch between remote & local port
Scroll Lock + Scroll Lock + Q	Turn the buzzer ON & OFF *Default the buzzer is ON
Scroll Lock + Scroll Lock + S	Activate auto-scan mode for remote & local port *The scan time interval is 5 seconds
Scroll Lock + Scroll Lock + A	Auto-adjust the video signal

< 4.5 > DC Power 12V, 24V, 48V Input

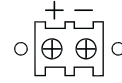
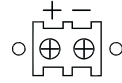
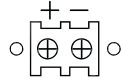

Model	12V	24V	48V
Input rating			
Input voltage:	12-Volt	24-Volt	48-Volt
Input range:	9 ~ 18V	18 ~ 36V	36 ~ 75V
Input current			
- No load	50 mA	50 mA	50 mA
- Full load	4950 mA	2450 mA	1220 mA
Output rating			
Output voltage:	12-Volt	12-Volt	12-Volt
Output current:	4.16A	4.16A	4.16A
Efficiency	84%	85%	85%

Remarks:

- Package does not include power cord