





**Home Theater Package
(Subwoofer Integrated Receiver + Speaker)**

YHT-S400
(SR-300 + NS-BR300)

Owner's Manual

English

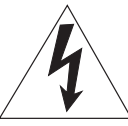
IMPORTANT SAFETY INSTRUCTIONS

| | | |
|--|---|---|
|  | CAUTION RISK OF ELECTRIC SHOCK DO NOT OPEN |  |
| CAUTION: TO REDUCE THE RISK OF ELECTRIC SHOCK, DO NOT REMOVE COVER (OR BACK). NO USER-SERVICEABLE PARTS INSIDE. REFER SERVICING TO QUALIFIED SERVICE PERSONNEL. | | |

- Explanation of Graphical Symbols

The lightning flash with arrowhead symbol, within an equilateral triangle, is intended to alert you to the presence of uninsulated “dangerous voltage” within the product’s enclosure that may be of sufficient magnitude to constitute a risk of electric shock to persons.

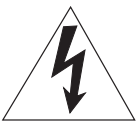

The exclamation point within an equilateral triangle is intended to alert you to the presence of important operating and maintenance (servicing) instructions in the literature accompanying the appliance.



IMPORTANT

Please record the serial number of this unit in the space below.

MODEL:

Serial No.:

The serial number is located on the rear of the unit. Retain this Owner’s Manual in a safe place for future reference.

- 1 Read these instructions.
- 2 Keep these instructions.
- 3 Heed all warnings.
- 4 Follow all instructions.
- 5 Do not use this apparatus near water.
- 6 Clean only with dry cloth.
- 7 Do not block any ventilation openings. Install in accordance with the manufacturer’s instructions.
- 8 Do not install near any heat sources such as radiators, heat registers, stoves, or other apparatus (including amplifiers) that produce heat.
- 9 Do not defeat the safety purpose of the polarized or grounding-type plug. A polarized plug has two blades with one wider than the other. A grounding type plug has two blades and a third grounding prong. The wide blade or the third prong are provided for your safety. If the provided plug does not fit into your outlet, consult an electrician for replacement of the obsolete outlet.
- 10 Protect the power cord from being walked on or pinched particularly at plugs, convenience receptacles, and the point where they exit from the apparatus.
- 11 Only use attachments/accessories specified by the manufacturer.
- 12 Use only with the cart, stand, tripod, bracket, or table specified by the manufacturer, or sold with the apparatus. When a cart is used, use caution when moving the cart/apparatus combination to avoid injury from tip-over.
- 13 Unplug this apparatus during lightning storms or when unused for long periods of time.
- 14 Refer all servicing to qualified service personnel. Servicing is required when the apparatus has been damaged in any way, such as power-supply cord or plug is damaged, liquid has been spilled or objects have fallen into the apparatus, the apparatus has been exposed to rain or moisture, does not operate normally, or has been dropped.



FOR CANADIAN CUSTOMERS

To prevent electric shock, match wide blade of plug to wide slot and fully insert.

This Class B digital apparatus complies with Canadian ICES-003.

FCC INFORMATION (for US customers)

1 **IMPORTANT NOTICE: DO NOT MODIFY THIS UNIT!**

This product, when installed as indicated in the instructions contained in this manual, meets FCC requirements. Modifications not expressly approved by Yamaha may void your authority, granted by the FCC, to use the product.

2 **IMPORTANT:** When connecting this product to accessories and/or another product use only high quality shielded cables. Cable/s supplied with this product **MUST** be used. Follow all installation instructions. Failure to follow instructions could void your FCC authorization to use this product in the USA.

3 **NOTE:** This product has been tested and found to comply with the requirements listed in FCC Regulations, Part 15 for Class "B" digital devices. Compliance with these requirements provides a reasonable level of assurance that your use of this product in a residential environment will not result in harmful interference with other electronic devices. This equipment generates/uses radio frequencies and, if not installed and used according to the instructions found in the users manual, may cause interference harmful to the operation of other electronic devices.

Compliance with FCC regulations does not guarantee that interference will not occur in all installations. If this product is found to be the source of interference, which can be determined by turning the unit "OFF" and "ON", please try to eliminate the problem by using one of the following measures:

Relocate either this product or the device that is being affected by the interference.

Utilize power outlets that are on different branch (circuit breaker or fuse) circuits or install AC line filter/s.

In the case of radio or TV interference, relocate/reorient the antenna. If the antenna lead-in is 300 ohm ribbon lead, change the lead-in to coaxial type cable.

If these corrective measures do not produce satisfactory results, please contact the local retailer authorized to distribute this type of product. If you can not locate the appropriate retailer, please contact Yamaha Electronics Corp., U.S.A. 6660 Orangethorpe Ave., Buena Park, CA 90620.

The above statements apply **ONLY** to those products distributed by Yamaha Corporation of America or its subsidiaries.

We Want You Listening For A Lifetime



Yamaha and the Electronic Industries Association's Consumer Electronics Group want you to get the most out of your equipment by playing it at a safe level. One that lets the sound come through loud and clear without annoying blaring or distortion – and, most importantly, without affecting your sensitive hearing. Since hearing damage from loud sounds is often undetectable until it is too late, Yamaha and the Electronic Industries Association's Consumer Electronics Group recommend you to avoid prolonged exposure from excessive volume levels.

Caution: Read this before operating your unit.

- 1 To assure the finest performance, please read this manual carefully. Keep it in a safe place for future reference.
- 2 Install this unit in a well ventilated, cool, dry, clean place - away from direct sunlight, heat sources, vibration, dust, moisture, and/or cold. For proper ventilation, allow the following minimum clearances.
Top: 5 cm (2 in)
Rear: 5 cm (2 in)
Sides: 5 cm (2 in)
- 3 Locate this unit away from other electrical appliances, motors, or transformers to avoid humming sounds.
- 4 Do not expose this unit to sudden temperature changes from cold to hot, and do not locate this unit in an environment with high humidity (i.e. a room with a humidifier) to prevent condensation inside this unit, which may cause an electrical shock, fire, damage to this unit, and/or personal injury.
- 5 Avoid installing this unit where foreign objects may fall onto this unit and/or this unit may be exposed to liquid dripping or splashing. On the top of this unit, do not place:
 - Other components, as they may cause damage and/or discoloration on the surface of this unit.
 - Burning objects (i.e. candles), as they may cause fire, damage to this unit, and/or personal injury.
 - Containers with liquid in them, as they may fall and liquid may cause electrical shock to the user and/or damage to this unit.
- 6 Do not cover this unit with a newspaper, tablecloth, curtain, etc. in order not to obstruct heat radiation. If the temperature inside this unit rises, it may cause fire, damage to this unit, and/or personal injury.
- 7 Do not plug in this unit to a wall outlet until all connections are complete.
- 8 Do not operate this unit upside-down. It may overheat, possibly causing damage.
- 9 Do not use force on switches, knobs and/or cords.
- 10 When disconnecting the power cable from the wall outlet, grasp the plug; do not pull the cable.
- 11 Do not clean this unit with chemical solvents; this might damage the finish. Use a clean, dry cloth.
- 12 Only voltage specified on this unit must be used. Using this unit with a higher voltage than specified is dangerous and may cause fire, damage to this unit, and/or personal injury. Yamaha will not be held responsible for any damage resulting from use of this unit with a voltage other than specified.
- 13 To prevent damage by lightning, keep the power cable and outdoor antennas disconnected from a wall outlet or the unit during a lightning storm.
- 14 Do not attempt to modify or fix this unit. Contact qualified Yamaha service personnel when any service is needed. The cabinet should never be opened for any reasons.
- 15 When not planning to use this unit for long periods of time (i.e. vacation), disconnect the AC power plug from the wall outlet.
- 16 Be sure to read the “Troubleshooting” section on common operating errors before concluding that this unit is faulty.
- 17 Before moving this unit, press \odot to set this unit in standby mode, and disconnect the power supply cable from the wall outlet.
- 18 Condensation will form when the surrounding temperature changes suddenly. Disconnect the power supply cable from the outlet, then leave the unit alone.
- 19 Install this unit near the wall outlet and where the AC power plug can be reached easily.
- 20 The batteries shall not be exposed to excessive heat such as sunshine, fire or like.
- 21 Secure placement or installation is the owner’s responsibility. Yamaha shall not be liable for any accident caused by improper placement or installation of speakers.

WARNING

TO REDUCE THE RISK OF FIRE OR ELECTRIC SHOCK, DO NOT EXPOSE THIS UNIT TO RAIN OR MOISTURE.

As long as this unit is connected to the AC wall outlet, it is not disconnected from the AC power source even if you turn off this unit by \odot . In this state, this unit is designed to consume a very small quantity of power.

■ For U.K. customers

If the socket outlets in the home are not suitable for the plug supplied with this appliance, it should be cut off and an appropriate 3 pin plug fitted. For details, refer to the instructions described below.

Note

The plug severed from the mains lead must be destroyed, as a plug with bared flexible cord is hazardous if engaged in a live socket outlet.

■ Special Instructions for U.K. Model

IMPORTANT

THE WIRES IN THE MAINS LEAD ARE COLOURED IN ACCORDANCE WITH THE FOLLOWING CODE:

Blue: NEUTRAL

Brown: LIVE

As the colours of the wires in the mains lead of this apparatus may not correspond with the coloured markings identifying the terminals in your plug, proceed as follows:

The wire which is coloured BLUE must be connected to the terminal which is marked with the letter N or coloured BLACK. The wire which is coloured BROWN must be connected to the terminal which is marked with the letter L or coloured RED.

Making sure that neither core is connected to the earth terminal of the three pin plug.

Contents

INTRODUCTION

| | |
|------------------------------|---|
| Getting started | 6 |
| Supplied parts | 6 |
| Controls and functions | 7 |

PREPARATION

| | |
|--|----|
| Placing | 10 |
| Placing the speaker | 10 |
| Connection | 12 |
| Overview | 12 |
| Connecting a TV | 13 |
| Connecting Blu-ray disc player or set-top box | 13 |

BASIC OPERATION

| | |
|-------------------------------------|----|
| Basic playback operation..... | 14 |
| Enjoying sound modes | 15 |
| Surround mode | 15 |
| Stereo mode | 15 |
| UniVolume™ | 15 |
| Listening to FM broadcasts..... | 16 |
| Basic tuning operation | 16 |
| Editing the preset FM station | 16 |
| Using optional equipment..... | 18 |
| Connecting dock | 18 |
| Using iPod™ | 18 |
| Using Bluetooth™ components | 19 |

USEFUL OPERATION

| | |
|---|----|
| Setup menu | 20 |
| Overview | 20 |
| Basic procedure | 20 |
| Adjusting the volume balance during playback | 21 |
| Adjusting high/low frequency sound (tone control)..... | 21 |
| Adjusting the audio delay..... | 21 |
| Setting the audio output | 21 |
| Switching on/off the HDMI™ control function | 21 |
| Changing the brightness of the front panel display | 22 |
| Changing the setting of the speaker type | 22 |
| Setting the distance between the speakers | 22 |
| Using the HDMI™ control function | 23 |

ADDITIONAL INFORMATION

| | |
|-----------------------------------|----|
| Additional information..... | 24 |
| Troubleshooting | 24 |
| Glossary..... | 27 |
| Specifications | 29 |
| Available signal information..... | 30 |

■ About this manual

- In this manual, operations that can be performed using either the front panel buttons or the remote control are explained using the remote control.
-  indicates a tip for your operation. Notes contain important information about safety and operating instructions.
- This manual is produced prior to production. Design and specifications are subject to change in part as a result of improvements, etc. In case of differences between the manual and the product, the product has priority.

INTRODUCTION

Getting started

Supplied parts

This product consists of the following items. Before making connections, make sure you have received all of the following items.

■ Units

Subwoofer Integrated Receiver (SR-300)

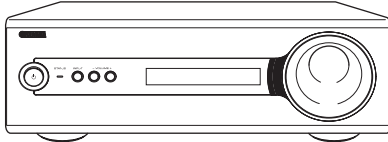

Speaker (NS-BR300)



■ Accessories

Speaker cable (3 m)



Remote control

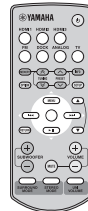

Indoor FM antenna

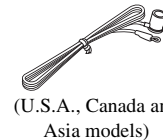

(U.S.A., Canada and Asia models)



(Europe, Russia and Australia models)

Stand × 2
(for speaker)

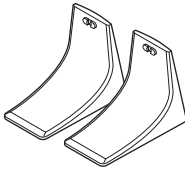

Battery × 2 (AAA, R03, UM4)

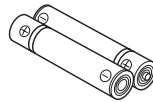

Mounting template

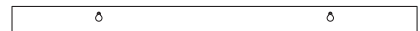

Non-skid pad
(4 pieces)

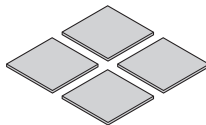

Screw × 2
(for stand)



Quick Reference
Guide



CD-ROM
(Owner's Manual)



■ Installing the batteries

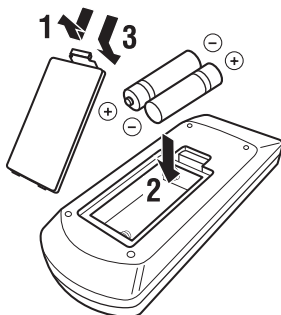

Notes

- If the effective operation distance of the remote control decreases considerably, replace the batteries with two new ones as soon as possible.
- Do not use an old battery together with new one.
- Do not use different types of batteries (for example, alkaline and manganese) together. Their performance will vary, even if they are similar in shape.
- If the batteries run out, immediately remove them from the remote control to prevent an explosion or acid leak.
- Dispose of batteries according to regional regulations.
- If a battery starts leaking, dispose of it immediately. Be careful not to let leaking battery acid come into contact with your skin or clothing. Before inserting new batteries, wipe the compartment clean.

Controls and functions

■ Front panel of the subwoofer integrated receiver

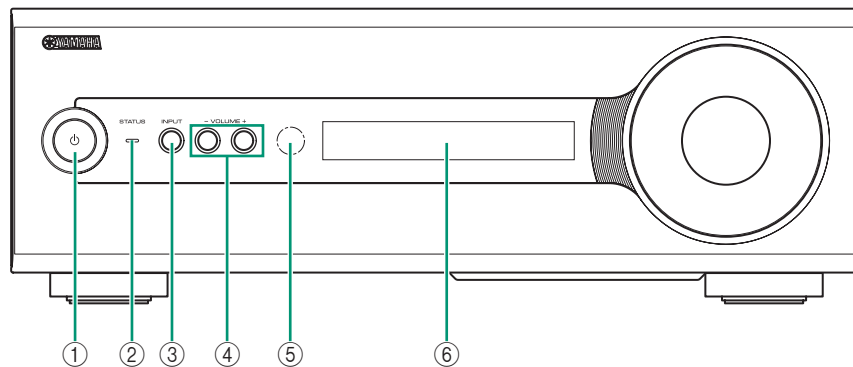

- ① **Power**
Turns on the system, or sets it to standby mode. (☞ P. 14)
- Note**
A small amount of electricity is consumed to receive the infrared signal from the remote control even when the system is in standby mode.
- ② **STATUS indicator**
Lights up to show the system condition. (☞ P. 14)
- ③ **INPUT**
Selects an input source you want to listen to. (☞ P. 14)
- ④ **VOLUME +/-**
Controls the volume of the system. (☞ P. 14)
- ⑤ **Remote control sensor**
Receives infrared signals from the remote control. (☞ P. 9, 12)
- ⑥ **Front panel display**
Shows information about the operational status of the system. (☞ P. 14)

■ Rear panel of the subwoofer integrated receiver

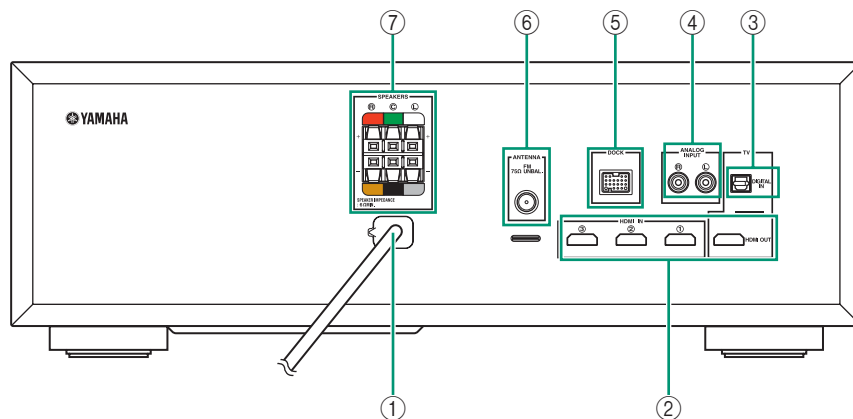

- ① **Power Cable**
For connecting an AC wall outlet. (☞ P. 12)
- ② **HDMI IN ① - ③/HDMI OUT**
- HDMI IN ① - ③ for connecting HDMI compatible external components. (☞ P. 13)
 - HDMI OUT for connecting an HDMI compatible TV. (☞ P. 13)
- ③ **DIGITAL IN jack**
For connecting optical digital cable to the TV. (☞ P. 13)
- ④ **ANALOG INPUT jack**
For connecting analog audio cable to external components. (☞ P. 12)
- ⑤ **DOCK terminal**
For connecting an optional Yamaha iPod universal dock (such as YDS-11, sold separately) or Bluetooth wireless audio receiver (such as YBA-10, sold separately). (☞ P. 18)
- ⑥ **ANTENNA terminal**
For connecting supplied FM antenna. (☞ P. 12)
- ⑦ **SPEAKERS terminal**
For connecting speakers. (☞ P. 12)

■ Front panel display of the subwoofer integrated receiver

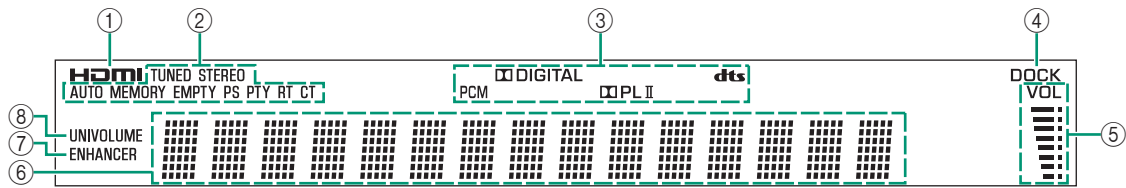

① HDMI indicator

Lights up during normal communication when HDMI is selected as an input source.

② Tuner indicators

TUNED indicator

Lights up when the system is receiving a station. (☞ P. 16)

STEREO indicator

Lights up when the system is receiving a strong signal from an FM stereo broadcast station in automatic tuning mode. (☞ P. 16)

AUTO indicator

Flashes when the system is tuning station automatically. (☞ P. 16)

MEMORY indicator

Flashes when the system is storing a station. (☞ P. 16, 17)

EMPTY indicator

Lights up when the storing preset number is empty. (☞ P. 17)

PS/PTY/RT/CT indicator (Europe and Russia models only)

Lights up according to the available Radio Data System information. (☞ P. 17)

③ Decoder indicators

The respective indicator lights up when any of the decoders of the system is activated.

④ DOCK indicator

- Lights up when the system is receiving a signal from an iPod stationed in the Yamaha iPod universal dock (such as YDS-11, sold separately) connected to the DOCK terminal of the subwoofer integrated receiver. (☞ P. 18)
- Lights up while the Yamaha Bluetooth wireless audio receiver (such as YBA-10, sold separately) is connected to the Bluetooth component. (☞ P. 19)
- Flashes while the connected Yamaha Bluetooth wireless audio receiver (such as YBA-10, sold separately) and the Bluetooth component are pairing (☞ P. 19) or while the Yamaha Bluetooth wireless audio receiver is searching for the Bluetooth component. (☞ P. 19)

⑤ VOLUME indicator

- Indicates the current volume level.
- Flashes while the mute function is activated. (☞ P. 14)

⑥ Multi information display

Shows the selected input source, current sound mode and other information.

⑦ ENHANCER indicator

Lights up when compressed music enhancer function is activated. (☞ P. 18)

⑧ UNIVOLUME indicator

Lights up when UniVolume mode is selected. (☞ P. 15)

Remote control

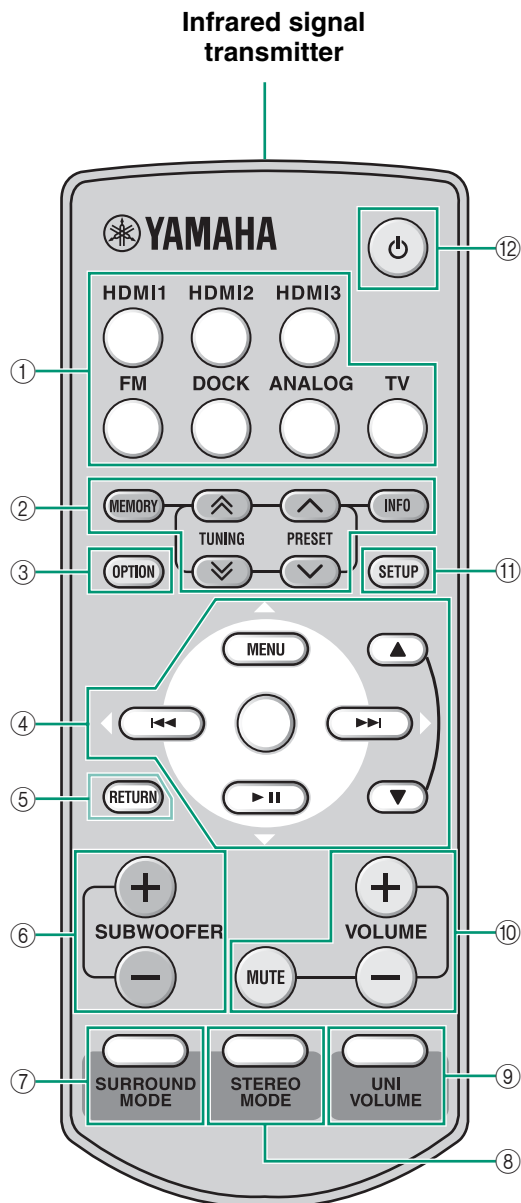

- ① **Input buttons**
Select an input source you want to listen to. (☞ P. 14)
- ② **MEMORY, TUNING \wedge/\vee , PRESET \wedge/\vee , INFO**
Control an FM tuner. (☞ P. 16)
- ③ **OPTION**
Enters OPTION menu when operating FM function or using Bluetooth component. (☞ P. 16, 19)
- ④ \triangle (MENU) / \triangleleft (◀) / \triangleright (▶) / ∇ (▶ ||) / \bigcirc (Center)
 - Change the setting.
 - Control an iPod. (☞ P. 18)
 - \blacktriangle / \blacktriangledown : Control the wheel of iPod.
- ⑤ **RETURN**
Returns to the previous menu or cancels preset registration/pairing operation.
- ⑥ **SUBWOOFER (+/-)**
Adjust the volume balance of subwoofer. (☞ P. 21)
- ⑦ **SURROUND MODE**
Selects the surround mode. (☞ P. 15)
- ⑧ **STEREO MODE**
Turns extended stereo mode on and off alternately. (☞ P. 15)
- ⑨ **UNIVOLUME**
Turns UniVolume mode on and off. (☞ P. 15)
- ⑩ **VOLUME (+/-)/MUTE**
Control the volume of the system. (☞ P. 14)
- ⑪ **SETUP**
Enters the setup menu. (☞ P. 20)
- ⑫ ⏻
Turns on the system, or sets it to standby mode. (☞ P. 14)

PREPARATION

Placing

To enjoy quality sound thoroughly, place this system in the appropriate positions, and install the components properly. The following illustrations are the setting images of this system.

Example 1: Placing the speaker beneath your TV

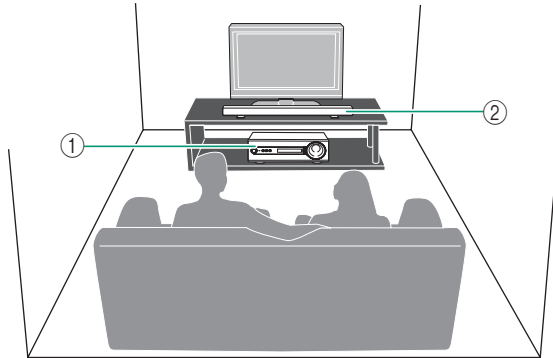

Example 2: Mounting the speaker on the wall

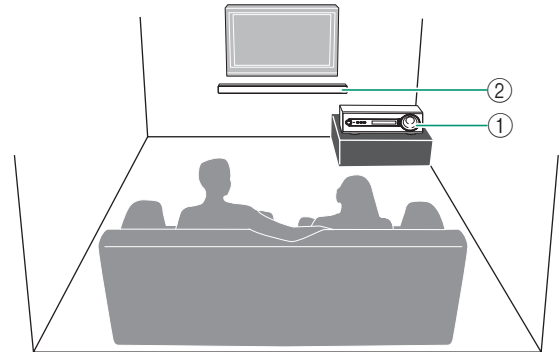

① Subwoofer integrated receiver (SR-300)

② Speaker (NS-BR300)

Notes

- Do not place this system on/under any other components such as Blu-ray disc player in a pile. The vibration of this system may cause system failure, etc. in other components.
- Keep enough ventilation space on the front, rear, and bottom side (that attached legs) of this system. Do not place this system on a thick carpet etc.
- If the picture on your CRT TV screen becomes blurred or distorted, we recommend moving the system away from your TV.
- Low frequency sound produced by the subwoofer integrated receiver may be heard differently depending on the listening position and subwoofer location. To enjoy desired sounds, try changing the location of the subwoofer integrated receiver.
- Depending on your installation environment, connections to external components can be done before installing this system. We recommend that you temporarily place and arrange all components in order to decide which procedure is best done first.

Placing the speaker

You can place the speaker on a rack or attach it to a wall. Select an installation method that suits your environment.

■ Placing the speaker beneath/under a TV

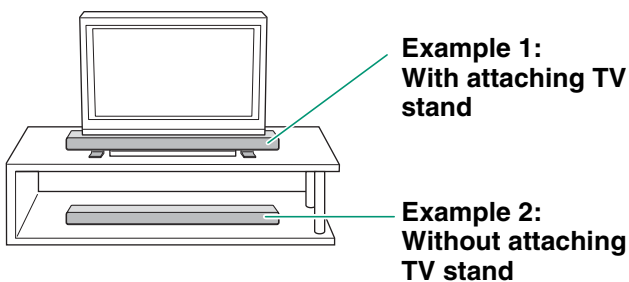

- If there is any obstacle (TV stand, etc.) under the speaker, use the supplied stands as shown in Example 1.
- If you are not using the supplied stands as shown in Example 2, attach the supplied non-skid pads to the bottom of the speaker.

Put the speaker on the stands and secure them with the supplied screws as shown in the illustration below.

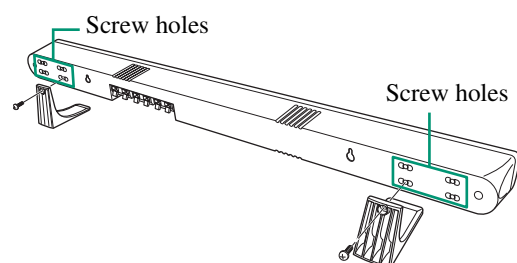

Note

You can adjust the height and width at which to attach the stands to the speaker horizontally by selecting screw holes in the back of the speaker. The above illustration shows attaching the stands using the lower and inner screw holes.

■ Attaching the speaker to a wall

Installing the speaker using the keyholes

You can attach the speaker to a wall using commercially available screws (#8, Diameter: 7 to 9 mm (1/4" to 3/8")).

When installing the speaker on a wall, all installation work must be performed by a qualified contractor or dealer. The customer must never attempt to perform this installation work. Improper or inadequate installation could cause the speaker to fall, resulting in personal injury.

- 1 Attach the supplied mounting template on a wall and mark the holes of the mounting template.**

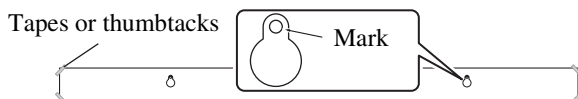

- 2 Remove the mounting template and then install the commercially available screws at the marks.**

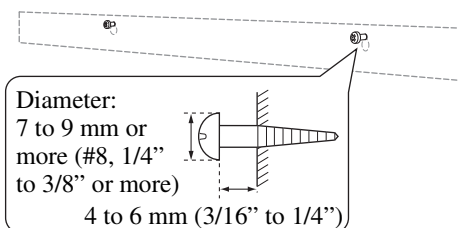

- 3 Hang the speaker on the screws using the keyholes on the back of the speaker.**

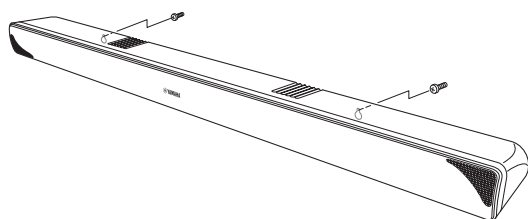

Installing the speaker using the screw holes

You can also use the screw holes on the rear of the speaker for installing the speaker using a commercially available rack etc.

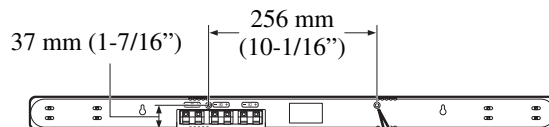

Screw holes
Hole depth: 14 mm (9/16")
Diameter: 6 mm (1/4")
Pitch: 256 mm (10-1/16")

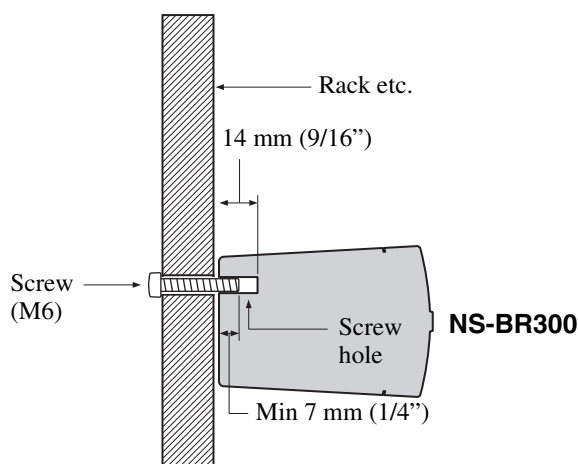

Notes

- Attach the speaker to a rack or wall. Do not attach the speaker to a wall that is made of weak materials such as plaster or veneered woods. Doing so may cause the speaker to fall.
- Use commercially available screws that can support the weight of the installation.
- Make sure you use specified screws to attach the speaker. Using clamps other than specified screws, such as short screws, nails, or two-sided tape, may cause the speaker to fall.
- When connecting the speaker, fix the speaker cables in place where they will not become loose. If your foot or hand accidentally gets caught on a loose speaker cable, the speaker may fall.
- After attaching the speaker, check that the speaker is fixed securely. Yamaha will bear no responsibility for any accidents caused by improper installations.

Connection

- Do not connect the power cable until all connections are completed.
- Do not use excessive force when inserting the cable plug. Doing so may damage the cable plug and/or terminal.

Overview

Follow the procedure below to connect the subwoofer integrated receiver and the external components.

Indoor FM antenna (supplied)

 If the radio wave reception is weak in your area or you want to improve the radio wave reception, we recommend that you use an outdoor antenna. For details, consult your nearest authorized Yamaha dealer or Service Center.

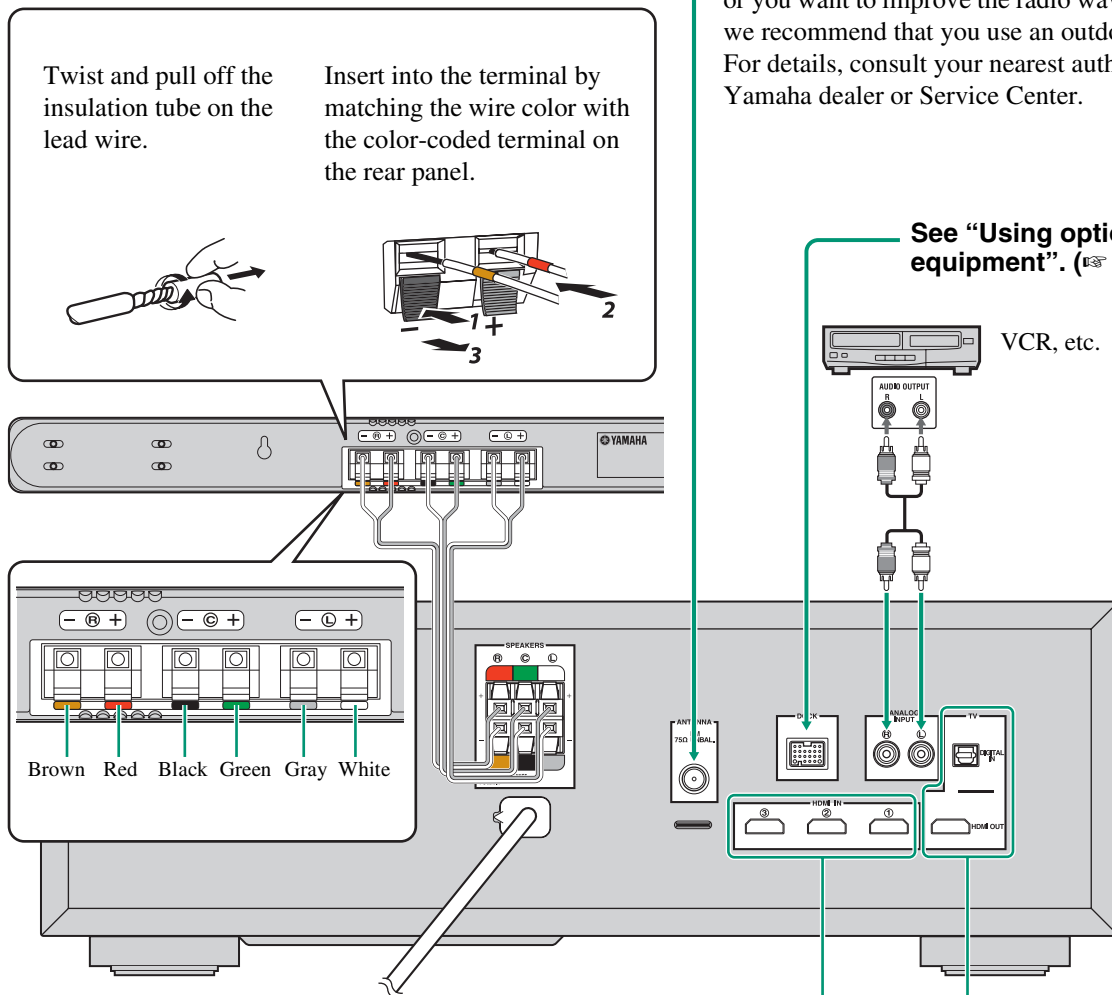

Twist and pull off the insulation tube on the lead wire.

Insert into the terminal by matching the wire color with the color-coded terminal on the rear panel.

Brown Red Black Green Gray White

See “Using optional equipment”. (P. 18)

VCR, etc.

To AC wall outlet



After you have made all connections, connect the power cable of the subwoofer integrated receiver.

See “Connecting Blu-ray disc player or set-top box”. (P. 13)

See “Connecting a TV”. (P. 13)

Connecting a TV

If a DVD player, etc., is connected to one of the HDMI IN jacks, connect your TV or video monitor (projector, etc.) to the HDMI OUT jack of the subwoofer integrated receiver.

To output the sound of a TV from this system, you can select optical digital input and connect to digital output jack.

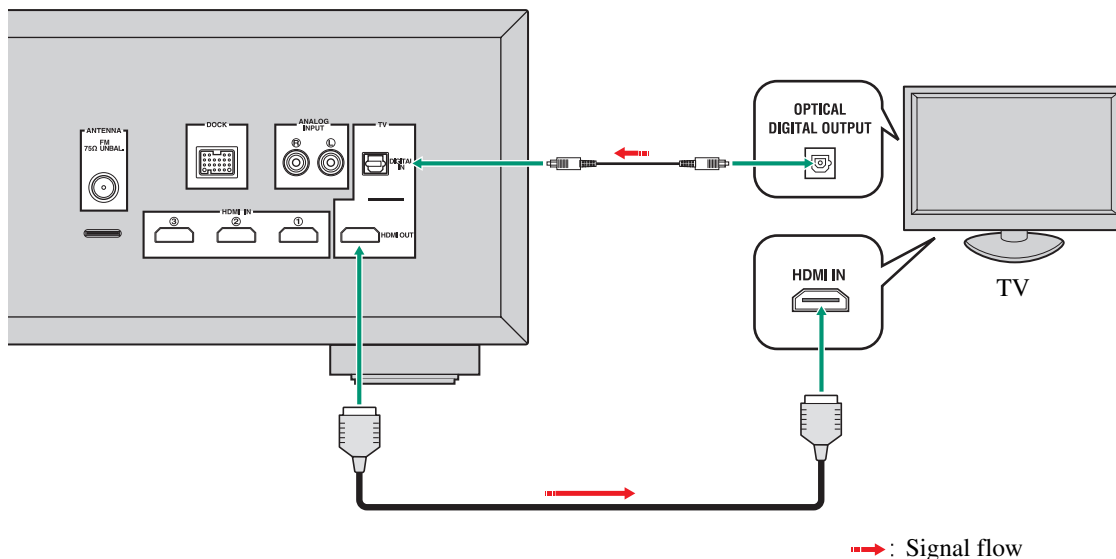

PREPARATION



For analog connection, you need to connect an audio cable to the analog input terminal.

Connecting Blu-ray disc player or set-top box

You can connect external components with HDMI output. You can select from HDMI IN ①, ②, or ③. These three jacks are identical.

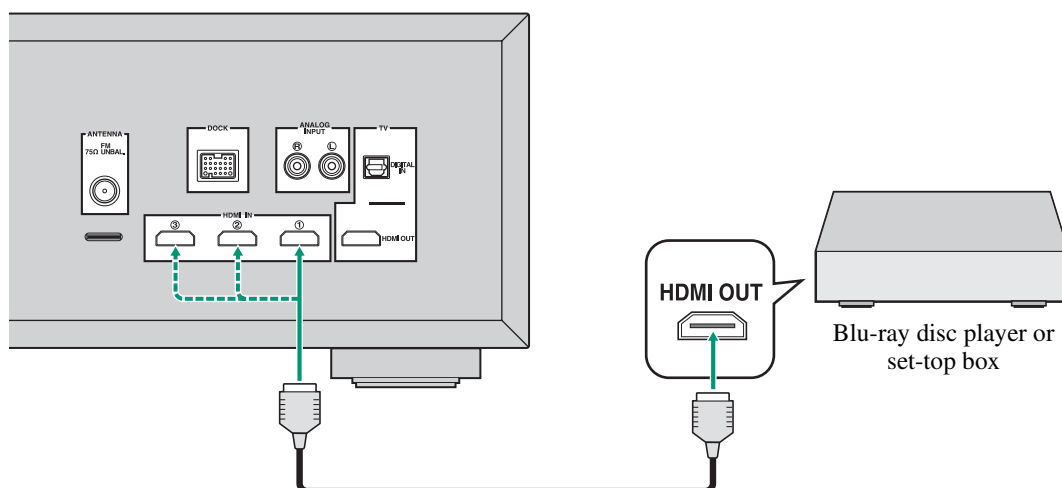

BASIC OPERATION

Basic playback operation

Once you have finished all cable connections and remote control operation, follow the procedure below to start basic playback operation.

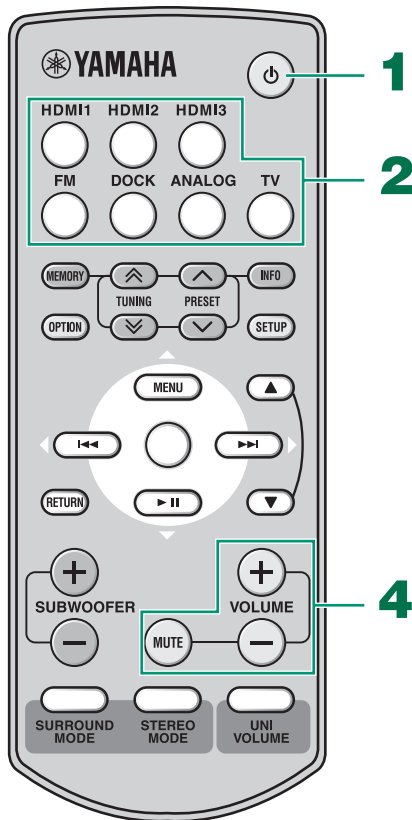

1 Press .

This system is turned on and the STATUS indicator lights green.



This system has the auto-sleep function, which will automatically switch the system to turn off if the system is left turned on for 24 hours without any operation being performed.

2 Press one of the input buttons to select an input source.

3 Start playback on the selected external component.

For information on the external component, refer to the instruction manual for the product.

4 Press **VOLUME +/-** to adjust the volume level.



To turn off the volume temporarily, press **MUTE**. While the mute function is activated, the **VOLUME** indicator flashes. To resume the volume, press **MUTE** again or press **VOLUME +/-**.

Note

When sound of HDMI is output from the TV, the volume level does not change if you press **VOLUME +/-**.

Press again to set the system to standby mode.

When the “HDMI CONTROL” is set to “ON”, the STATUS indicator lights red. When the “HDMI CONTROL” is set to “OFF”, the STATUS indicator turns off. (P. 21)

Using the remote control

Use the remote control within 6 m (20') of the subwoofer integrated receiver and point it toward the remote control sensor.

Notes

- Be careful not to spill liquid on the remote control.
- Be careful not to drop the remote control.
- Do not leave the remote control in a place that is:
 - hot or humid, such as near a heater or in a bathroom
 - extremely cold
 - dusty

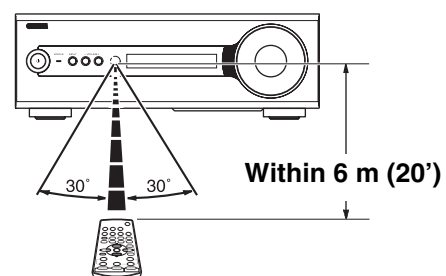

Enjoying sound modes

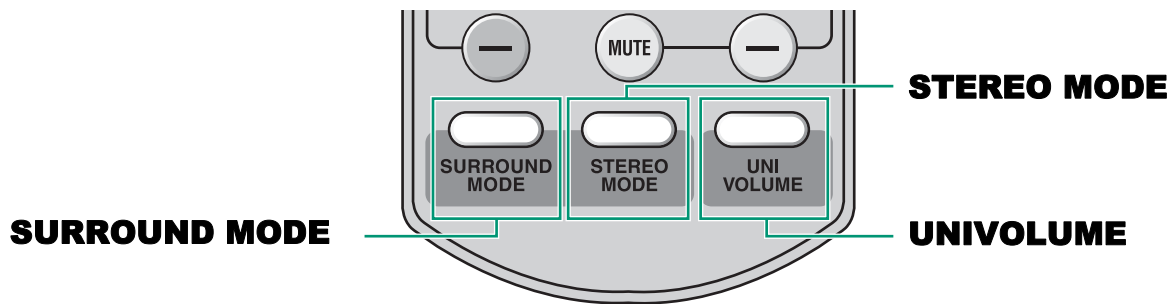

Surround mode

You can enjoy a realistic sound effect using Yamaha's exclusive AIR SURROUND XTREME.

Press **SURROUND MODE** to set surround mode.

Press **SURROUND MODE** repeatedly until desired mode appears in the front panel display.

Surround mode descriptions

| | |
|--------|---|
| MOVIE | This mode is useful when you enjoy movie contents on media such as Blu-ray disc, etc. |
| MUSIC | This mode is useful when you listen to music contents on media such as Blu-ray disc, etc. |
| SPORTS | This mode is useful when you enjoy sports programs or TV news. |
| GAME | This mode is useful when you enjoy video games. |



The system automatically memorizes the settings assigned to each input source. When you select another input, the system automatically recalls the last settings for the selected input.

Stereo mode

An extended sound is achieved for a 2 channel source such as a CD player.

Press **STEREO MODE** to enter extended stereo mode.

Each time you press **STEREO MODE**, the function is turned on (EXTENDED STEREO) and off (STEREO) alternately.

“STEREO”: Reproduces the sound without any effect.
 “EXTENDED STEREO”: Reproduces a wider stereo image.



- The default setting is “EXTENDED STEREO”.
- The system memorizes the settings assigned to each input source.

UniVolume™

While watching TV, use this function when you feel uncomfortable with the difference in volume between channels, TV programs, and commercials to keep the volume at an even level.

Press **UNIVOLUME** to activate or deactivate the function.

When UniVolume is activated, UNIVOLUME indicator is displayed and the sound volume of TV is uniformed.



- The system memorizes the setting assigned to each input source.
- When the input source is DOCK and UniVolume is activated, compressed music enhancer function is invalid (ENHANCER indicator disappears).

Listening to FM broadcasts

Basic tuning operation

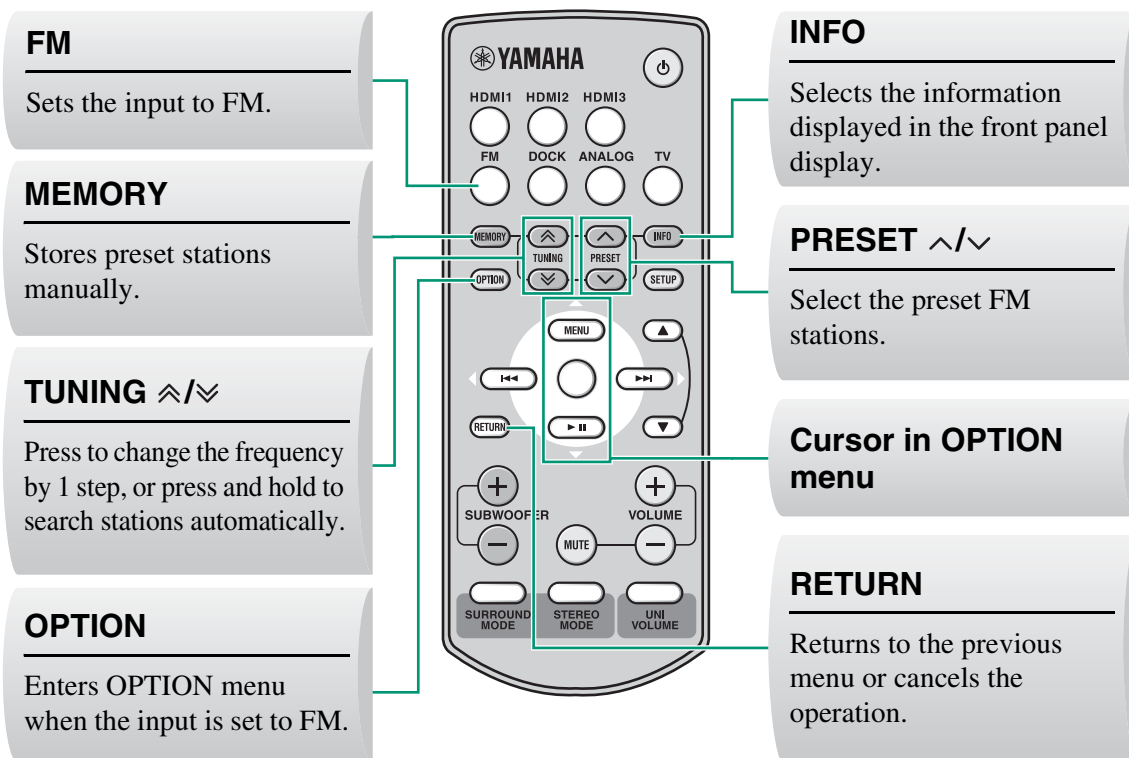

Editing the preset FM station

Automatic preset

You can store up to 40 FM stations (01 to 40).

1 Press **OPTION to enter **OPTION** menu.**
“AUTO PRESET” appears firstly in the front panel display.

2 Press \bigcirc (Center).



Press **PRESET \wedge/\vee** repeatedly to select a preset number to which the first station will be stored.

After approximately 5 seconds, automatic presetting starts from the lowest frequency and proceeds through higher frequencies. When the frequency is stored, the TUNED indicator lights up.

When automatic preset tuning is completed, the front panel display shows message “Preset Complete” for three seconds firstly and returns to OPTION menu secondly.



Press **RETURN** while searching automatically, automatic preset is stopped.

Notes

- Any stored station data existing under a preset number is cleared when you store a new station under the same preset number.
- If the number of received stations does not reach 40, automatic preset tuning automatically stops after searching for all the available stations.
- Only the station with strong signals can be stored. If the desired station is not stored, or a station is not stored to the desired preset number, preset the station manually. (P. 17)

Manual station preset

Use this feature to preset your desired station manually.

1 Tune into a radio station you want to preset.

2 Press MEMORY.

“MANUAL PRESET” appears in the front panel display, followed soon by the preset number to which the station will be registered.



By pressing down **MEMORY** for more than 2 seconds. The station is registered to the lowest empty preset number or a preset number one higher than the last preset number.

3 Press PRESET \wedge/\vee to select the preset number (01 to 40) to which the station will be registered.

When you select a preset number to which no station is registered, EMPTY indicator appears on the display. When you select a registered preset number, a registered frequency is displayed on the right of the preset number.



To cancel registration, press **RETURN** on the remote control or leave the tuner without any operations for about 30 seconds.

4 Press MEMORY again to register.

Clearing the preset station

1 Press OPTION to enter OPTION menu.

2 Display “CLEAR PRESET” using the cursor ∇ and press \bigcirc (Center).

Preset number and the frequency appears in the display.



You can cancel the operation and return to OPTION menu by pressing **RETURN** on the remote control.

3 Select the preset number of the registered station you want to clear using the cursor \triangle/∇ and press \bigcirc (Center).

The preset station registered to the selected preset number is cleared. To clear the registration of multiple preset numbers, repeat the above steps. To end the operation, press **OPTION**.

Using the monaural reception mode

When the signal of the desired FM station is too weak, set the reception mode to “MONO” to increase signal quality.

1 Press OPTION to enter OPTION menu.

2 Display “STEREO/MONO” by using the cursor ∇ and press \bigcirc (Center).

3 Select “MONO” to set the reception mode to monaural by using the cursor \triangle/∇ .

Switching the information display

Each time you press **INFO**, the information display changes as follows:

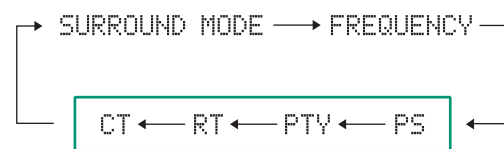

Europe and Russia models only

Information type

- **SURROUND MODE**
Displays the surround mode or stereo mode.
- **FREQUENCY**
Displays the frequency and preset number.
- **PROGRAM SERVICE (PS)**
Displays the currently received Radio Data System program.
- **PROGRAM TYPE (PTY)**
Displays the type of the currently received Radio Data System program.
- **RADIO TEXT (RT)**
Displays the information of the currently received Radio Data System program.
- **CLOCK TIME (CT)**
Displays the current time.

Using optional equipment

This system is equipped with a DOCK terminal, which allows you to connect a Yamaha iPod universal dock (such as YDS-11, sold separately) or a Yamaha Bluetooth wireless audio receiver (such as YBA-10, sold separately) to enjoy music contents stored in your Bluetooth component (such as a portable music player or computer equipped with Bluetooth transmitter, etc.). Connect this equipment to the DOCK terminal of the subwoofer integrated receiver using its dedicated cable.



When DOCK is selected as the input source, compressed music enhancer function is activated automatically and enhances your listening experience by regenerating the missing harmonics in a compressed music format such as MP3.

Connecting dock

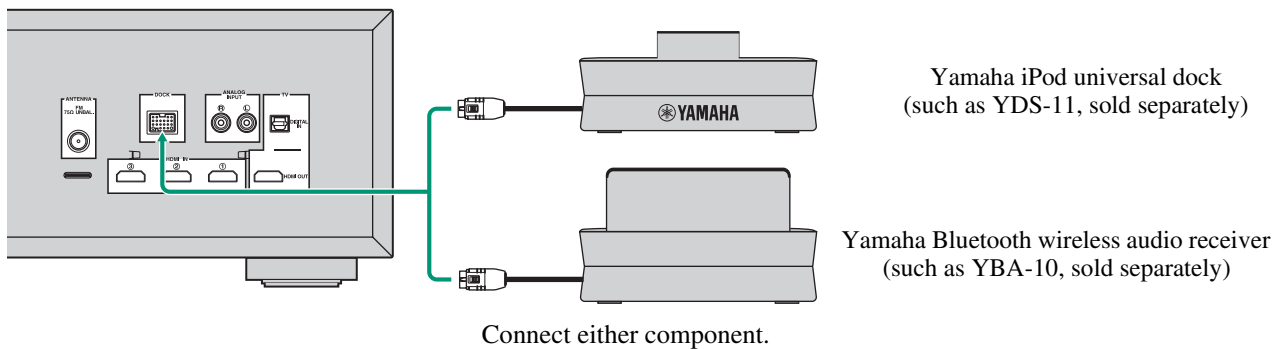

Using iPod™

Once you have stationed your iPod in the Yamaha iPod universal dock connected to the DOCK terminal of the subwoofer integrated receiver, you can enjoy playback of your iPod.

Supported iPod

iPod (Click and Wheel including iPod classic)
iPod nano
iPod mini
iPod touch

Battery charge feature

This system charges the battery of an iPod stationed in the Yamaha iPod universal dock connected to the DOCK terminal of the subwoofer integrated receiver, even when this system is turned off. “Charging” appears in the front panel display.

Notes

- Some features may not be available depending on the model or the software version of your iPod.
- For a complete list of status messages that appear in the front panel display, see the “iPod” section in “Troubleshooting” (P. 26).
- Be sure to set the volume to minimum before docking or removing your iPod.
- To playback an iPod, select DOCK for input source.
- Refer to the instruction manual of your Yamaha iPod universal dock for details.

Using Bluetooth™ components

■ Pairing

About “Pairing”

Pairing must be performed before using a Bluetooth component with the Yamaha Bluetooth wireless audio receiver connected to the system for the first time or if the registered pairing data has been deleted. “Pairing” refers to the operation of registering a Bluetooth component for Bluetooth communications.



To ensure security, a time limit of 8 minutes is set for the pairing operation. Please read and fully understand all the instructions before starting.

Note

For details, refer to the instruction manual of Yamaha Bluetooth wireless audio receiver.

- 1 Press DOCK to set the input to DOCK.**
- 2 Turn on the Bluetooth component you want to pair with, and then enter pairing mode.**
Refer to the instruction manual of your Bluetooth component for details.
- 3 Press OPTION.**
OPTION menu for DOCK input appears in the display.
- 4 Press the cursor ∇ to select “PAIRING” and press \bigcirc (Center).**
“Searching...” appears when the pairing starts. While the Yamaha Bluetooth wireless audio receiver is in pairing mode, the DOCK indicator flashes in the front panel display.

To cancel pairing, press RETURN.
- 5 Check that the Bluetooth component detects the Yamaha Bluetooth wireless audio receiver.**
If the Bluetooth component detects the Yamaha Bluetooth wireless audio receiver, the audio receiver name (“YBA-10 YAMAHA” for example) appears in the device list of the Bluetooth component.

- 6 Select the Yamaha Bluetooth wireless audio receiver in the device list of the Bluetooth component, and then enter the pass key “0000” on the Bluetooth component.**

■ Establishing a connection

After the pairing is completed, perform the connecting operation on the system or on the Bluetooth component to enable communication between them. The connecting operation on the system is only available for the most recently connected Bluetooth component.

- 1 Press DOCK to set the input to DOCK.**
- 2 Press OPTION to enter OPTION menu.**
“CONNECT” appears firstly in the front panel display.
- 3 Press \bigcirc (Center).**
“Searching...” appears firstly in the front panel display.
When the system finds the last connected Bluetooth component, “BT connected” appears in the front panel display for 3 seconds.

 - If the system cannot find the last connected Bluetooth component, “Not found” appears in the front panel display.
 - If you want to establish a connection with a Bluetooth component other than the one most recently connected to, connect from that Bluetooth component. Refer to the instruction manual of your Bluetooth component for details.

Note

To disconnect the Bluetooth wireless audio receiver from the Bluetooth component, display OPTION menu again, select “Disconnected,” and press \bigcirc (Center).

USEFUL OPERATION

Setup menu

Overview

■ Setup menu list

| Item | Description of function | Page |
|-----------------|--|-------|
| 1: SW LEVEL | Adjusting the volume balance during playback | P. 21 |
| 2: CENTER LEVEL | | |
| 3: SUR. LEVEL | | |
| 4: TONE BASS | Adjusting high/low frequency sound (tone control) | P. 21 |
| 5: TONE TREBLE | | |
| 6: AUDIO DELAY | Adjusting the audio delay | P. 21 |
| 7: HDMI AUDIO | Setting the audio output | P. 21 |
| 8: HDMI CONTROL | Switching on/off the HDMI control function | P. 21 |
| 9: DISPLAY MODE | Changing the brightness of the front panel display | P. 22 |
| 10: SP TYPE | Changing the setting of the speaker type | P. 22 |
| 11: SP DISTANCE | Setting the distance between the speakers | P. 22 |

Note

If the “SP TYPE” is set to the default setting (“BAR”), “SP DISTANCE” will not be displayed.

Basic procedure

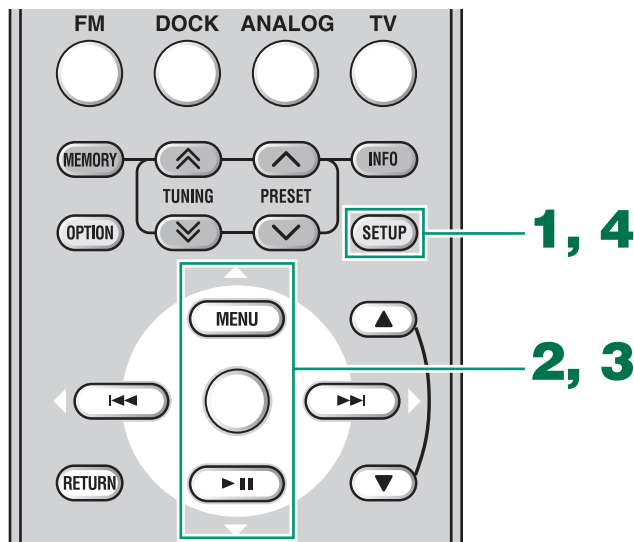

You can change various settings of this system using the setup menu.

- 1 Press **SETUP** to enter the setup menu.**
“SW LEVEL” is displayed in the front panel display.
- 2 Press the cursor \triangle/∇ to select menu and press \bigcirc (Center).**
The current setting is displayed.
- 3 Press the cursor \triangle/∇ to adjust the value of each menu.**
Press and hold the cursor \triangle/∇ to change the setting value faster.
- 4 Press **SETUP** again to exit the setup menu.**



Press **RETURN** to return to the previous menu.

Note

If you do not operate within 30 seconds after entering the setup menu, the system automatically exits the setup menu.

Adjusting the volume balance during playback

You can adjust the volume balance of the virtual speakers and subwoofer.

Parameter

“SW LEVEL”: Adjusts the output level of the subwoofer channel.

“CENTER LEVEL”: Adjusts the output level of the center speaker channel.

“SUR. LEVEL”: Adjusts the output level of the surround/surround back virtual speaker channels.

Adjustable range

–6 to +6 (Default setting: 0)



- You can also adjust the output level of the subwoofer by pressing **SUBWOOFER +/-**.
- If surround mode is off, the virtual center speaker and virtual surround effects become invalid.

Adjusting high/low frequency sound (tone control)

You can adjust the balance of the high frequency range (Treble) and low frequency range (Bass) of sounds output from the front speakers to obtain desired tone.

Parameter

“TONE BASS”: Adjusts the balance of the low frequency range (Bass) of sounds output from the speaker.

“TONE TREBLE”: Adjusts the balance of the high frequency range (Treble) of sounds output from the speaker.

Adjustable range

–6 to +6 (Default setting: 0)

Adjusting the audio delay

Flat panel display TV images sometimes lag behind the sound. You can use this function to delay the sound output to synchronize it with the video image.

Parameter

“AUDIO DELAY”

Adjustable range (Default setting: “AUTO”)

“AUTO”, 0 to 240 ms (You can adjust the delay time by the 10 ms.)

- * “AUTO”: If you operate HDMI connection to a TV with the function to automatically adjusting the audio delay, you can adjust the delay time automatically.

Note

The system memorizes the settings assigned to each input source.

Setting the audio output

You can select this system (or a TV connected to this system via the HDMI OUT jack of this system) for reproducing sound signals input from the HDMI IN jack in the setup menu.

Parameter

“HDMI AUDIO”

Adjustable option (Default setting: “AMP”)

“AMP”: Outputs HDMI sound signals from the speakers connected to this system.

“TV”: Outputs HDMI sound signals from the speakers of a TV connected to this system. Sound output from the speakers connected to this system is muted.

Notes

- The volume level will not change from pressing **VOLUME +/-** or **MUTE** while output from the TV.
- You cannot change the audio output when “HDMI CONTROL” is set to “ON”.

Switching on/off the HDMI™ control function

You can set whether to use the HDMI control function. Refer to P.23 for HDMI control function.

Parameter

“HDMI CONTROL”

Adjustable option (Default setting: “OFF”)

“ON”: Activates the HDMI control function.

“OFF”: Deactivates the HDMI control function.

Changing the brightness of the front panel display

You can change the brightness of the front panel display. You can also turn off the front panel display to view a movie in a darker environment.

The brightness of the front panel changes as follows.

Parameter

“DISPLAY MODE”

Adjustable range

(Default setting: “DIMMER 0”)

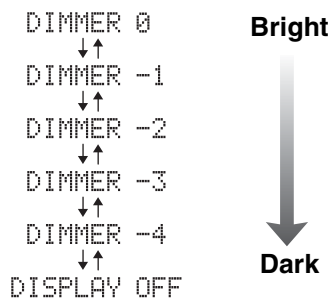

* Selecting DISPLAY OFF turns off the front panel display after exiting the setup menu.

Notes

- The front panel display lights up momentarily when any operation is performed with DISPLAY OFF mode selected.
- Only the STATUS indicator remains lit in DISPLAY OFF mode.

Changing the setting of the speaker type

You can set the speaker type if you want to add or change speakers. When you connect only the supplied speaker, you do not have to change the setting.

Parameter

“SP TYPE”

Adjustable range (Default setting: “BAR”)

“BAR”: When you connect a speaker with integrated front left/right/center channels (such as a bar-type speaker).

“2CH”: When you connect front left/right (2-channel) speakers.

“3CH”: When you connect front left/right (2-channel) speakers and a center speaker.

Notes

- To activate “SP TYPE”, set the system to standby mode and turn on again after setting the speaker type.
- “SP DISTANCE” is displayed when “2CH” or “3CH” is selected.

Setting the distance between the speakers

Select a parameter suited for the distance between the front left and right speakers, to obtain the most suitable surround effect.

Parameter

“SP DISTANCE”

Adjustable range

“WIDE”: When the distance between the front speakers is over 150 cm (59-1/16”).

“NORMAL”: When the distance between the front speakers is from 80 cm (31-1/2”) to 150 cm (59-1/16”).

“NARROW”: When the distance between the front speakers is within 80 cm (31-1/2”).

Note

When the surround mode is off, this function is invalid.

Using the HDMI™ control function

You can operate the following functions of this system with the remote control of your TV when the TV (HDMI control function supported) is connected to the HDMI OUT jack of this system.

- Turning this system on or to standby mode (conjunction with TV)
- Adjusting the volume
- Selecting a device to reproduce TV sounds (this unit or TV)



- Even if your TV supports the HDMI control function, some functions may not be available. For details, refer to the instruction manual supplied with your TV.
- If you connect this system and Blu-ray disc player or DVD player (HDMI control function supported) to HDMI, you can also control those devices with the HDMI control function. For details, refer to the instruction manual supplied with each device.
- We suggest that you use products (TV, Blu-ray disc/DVD player, etc.) from the same manufacturer.
- The HDMI control-compatible components include Panasonic VIERA Link compatible TV, DVD player/recorder and Blu-ray disc player.
- When “HDMI CONTROL” is set to “ON”, operations of the TV (for example, changing channels, etc.) may change the system settings, such as the surround mode.

(Steps 1 through 3 are required for the HDMI control function setup.)

1 Turn on all devices connected to this system with HDMI.

2 Enable the HDMI control function on each device.

For this system, set “HDMI CONTROL” to “ON” (P. 21).

For external devices, refer to the instruction manual supplied with each device.

3 Turn off the TV, and then turn it on again.

(Step 4 through 6 are required for making the TV learn linked devices. If the connections or devices are switched, you need to carry out these steps again.)

4 Select this system as the input source of the TV.

5 Turn on the HDMI control device (Blu-ray disc or DVD player) connected to this system.

6 Select the HDMI control device (Blu-ray disc or DVD player) as the input source of this system to check the video input.

7 Check if the HDMI control function works (turn on this system or adjust the volume level using the remote control of the TV).

Note

In case the HDMI control function does not work, check the followings. Also turning off (unplug) and turning on (plug) the TV may be effective.

- The TV is connected to the HDMI OUT jack of this system
- “HDMI CONTROL” is set to “ON” on this system.
- The HDMI control function is enabled on the TV.

When “HDMI CONTROL” is set to “ON”, even if you press , the system will not be completely turned off and the signal from HDMI input terminal to HDMI output terminal is output.



- The STATUS indicator in the front panel display lights red when “HDMI CONTROL” is set to “ON” and the system is in standby mode.
- Before pressing , select desired input sources connected to HDMI input (HDMI IN ① to ③).

ADDITIONAL INFORMATION

Additional information

Troubleshooting

If there is any problem with the system, check the following items. If you cannot solve a problem with the following remedies, or if the problem is not listed below, turn off and unplug the system, and then consult your nearest authorized Yamaha dealer or Service Center.



| Problem | Cause | Solution | See page |
|--|--|--|----------|
| Power turns on but immediately shuts off. | The power cable may be connected improperly. | Make sure the power cable is plugged into the outlet firmly. | 12 |
| | A speaker cable may be shorted. | Make sure all speaker cables are connected properly. | 12 |
| | This system may have received a strong electrical shock, such as from a lightning bolt or excessive static electricity. | Set this system to standby mode, and then disconnect the power cable. Wait for about 30 seconds, connect the power cable, and then turn the system on again. | 14 |
| The speakers make no sound. | The volume may be set to minimum level. | Adjust the volume level. | 14, 21 |
| | The mute function may be activated. | Cancel the mute function. | 14 |
| | The input source or input setting may be incorrect. | Select the correct input source or input setting. | 14 |
| | The cables may be connected improperly. | Make sure all cables are connected properly. | 12 |
| | “HDMI AUDIO” in the setup menu is set to “TV”. | Set “HDMI AUDIO” in the setup menu to “AMP”. | 21 |
| Sound is too low on one side. | The cables may be connected improperly. | Make sure all cables are connected properly. | 12 |
| Speaker channels other than the front ones make no sound. | You may be listening to stereo sounds without surround mode. | Press a surround mode button to enable the sound field effect. | 15 |
| | “SUR. LEVEL” in the setup menu is set to minimum level. | Adjust “SUR. LEVEL” in the setup menu. | 21 |
| The subwoofer makes no sound. | The volume of the subwoofer channel may be set to minimum level. | Adjust the volume level of the subwoofer. | 9, 21 |
| | The source does not contain low-frequency signals. | | |
| The volume level decreases without any operation. | You turned off the system when the volume level was over 70. | The volume level is automatically set to 70 the next time you turn on the system to protect the speakers. | — |
| Sound is poor (noisy). | A speaker cable may be shorted. | Make sure all cables are connected properly. | 12 |
| This system does not operate properly. | This system may receive a strong electrical shock, such as from a lightning bolt or excessive static electricity, or drop in power supply. | Set this system to standby mode, and then disconnect the power cable. Wait for about 30 seconds, connect the power cable, and then turn on this system. | 14 |
| A digital or high-frequency equipment produces noises. | The system may be placed close to digital equipment or high-frequency equipment. | Place this system farther away from such equipment. | — |

| Problem | Cause | Solution | See page |
|--|--|---|----------|
| The system settings change automatically. | When “HDMI CONTROL” is set to “ON”, operations of the TV (for example, changing channels, etc.) may change the system settings, such as the surround mode. | Set “HDMI CONTROL” to “OFF” or set the system again by using its remote control. | 23 |
| The remote control does not operate the system. | The system may be outside the remote control operation range. | For information on the remote control operation range, refer to “Using the remote control”. | 14 |
| | The remote control sensor of this system may be exposed to direct sunlight or lighting. | Change the lighting. | — |
| | The batteries may be worn out. | Replace the batteries. | 6 |

■ HDMI

| Problem | Cause | Solution | See page |
|---|---|--|----------|
| “AUTO” set in the setup menu “AUDIO DELAY” does not operate. | The TV does not support automatically adjusting the audio delay. | Adjust the delay time manually (0 to 240 ms). | 21 |
| The HDMI control function does not operate properly. | The number of the connected HDMI components is over the limit. | Disconnect some of the HDMI components. | — |
| No picture or sound | The connected HDMI component does not support high-bandwidth digital copyright protection (HDCP). | Connect the HDMI component that supports HDCP. | — |

■ Tuner

| Problem | Cause | Solution | See page |
|--|---|---|----------|
| FM stereo reception is noisy. | The characteristics of FM stereo broadcasts may cause this problem when the transmitter is too far away, or if the antenna quality is poor. | Check the antenna connections. | 12 |
| | | Try using a high-quality directional FM antenna. | — |
| | | Set the reception mode to “MONO”. | 17 |
| There is distortion, and clear reception cannot be obtained, even with a good FM antenna. | There is multi-path interference. | Adjust the antenna position to eliminate multi-path interference. | — |
| The desired station cannot be tuned into with the automatic tuning method. | The signal is too weak. | Use a high-quality directional FM antenna. | — |
| | | Set the reception mode to “MONO” and press TUNING   to change frequency by 1 step. | 16, 17 |

■ iPod

| Status message | Cause | Solution | See page |
|----------------|---|---|----------|
| Unknown iPod | The iPod being used is not supported by this system. | Only iPod (Click and Wheel including iPod classic), iPod nano, iPod mini, and iPod touch are supported. | — |
| iPod connected | Your iPod is properly stationed in the Yamaha iPod universal dock (such as YDS-11, sold separately) connected to the DOCK terminal of this system, and the connection between your iPod and this system is completed. | | |
| Disconnected | Your iPod was removed from the Yamaha iPod universal dock (such as YDS-11, sold separately) connected to the DOCK terminal of this system. | Station your iPod back in the Yamaha iPod universal dock (YDS-11, sold separately) connected to the DOCK terminal of this system. | 18 |
| Charging | Your iPod is charging. | | |

■ Bluetooth

| Status message | Cause | Solution | See page |
|----------------|---|--|----------|
| Searching... | The Yamaha Bluetooth wireless audio receiver (such as YBA-10, sold separately) and the Bluetooth component are in the process of the pairing. | | |
| | The Yamaha Bluetooth wireless audio receiver (such as YBA-10, sold separately) and the Bluetooth component are in the process of establishing the connection. | | |
| Completed | The pairing is completed. | | |
| Canceled | The pairing is canceled. | | |
| Not found | The system cannot find the Bluetooth component while performing the pairing or trying to connect to the Bluetooth component. | | |
| BT connected | The connection between the Yamaha Bluetooth wireless audio receiver (such as YBA-10, sold separately) and the Bluetooth component is established. | | |
| Disconnected | The Bluetooth component is disconnected from the Yamaha Bluetooth wireless audio receiver (such as YBA-10, sold separately). | | |
| Not Available | The pairing is performed when the Yamaha Bluetooth wireless audio receiver (such as YBA-10, sold separately) is connected to the Bluetooth component. | Perform the pairing when the Yamaha Bluetooth wireless audio receiver (such as YBA-10, sold separately) is not connected to the Bluetooth component. | 19 |

Glossary

■ AIR SURROUND XTREME

This system employs new technologies and algorithms that make it possible to achieve 7-channel surround sound with only front speakers, and without using wall reflections.

Ordinarily, two front speakers, a center speaker, two surround speakers, and a subwoofer are necessary for enjoying 5.1 channel surround sound.

Typical 5.1 channel speaker system

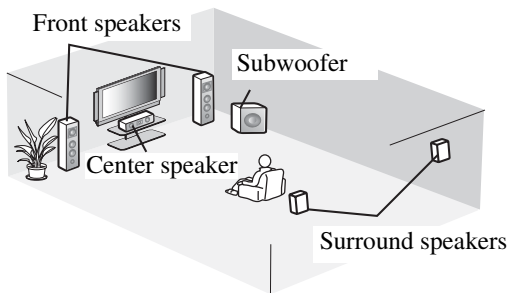

Virtual 7.1 channel

The AIR SURROUND XTREME technology, using only front speakers and subwoofer, enables you to enjoy a realistic 7.1 channel sound by simulating sound from virtual speakers at center, surround, and surround backs.

The sound image of the system

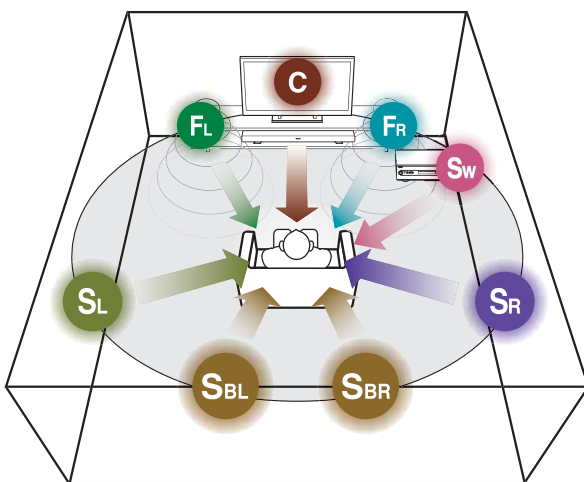

The system creates the virtual 7.1 channel surround sound with the subwoofer integrated receiver and the speaker.

C: Center speaker

FR, FL: Front speakers

SW: Subwoofer

SR, SL: Surround virtual speakers

SBR, SBL: Surround back virtual speakers

■ Channel (ch)

A channel is an audio type that has been divided based on range and other characteristics.

Ex. 7.1 channel

- Front speakers, Left (1ch), Right (1ch)
- Center speaker (1ch)
- Surround speakers, Left (1ch), Right (1ch)
- Surround back speakers, Left (1ch), Right (1ch)
- Subwoofer (1ch × 0.1* = 0.1ch)

* In contrast to a full 1-channel band, a component designed to enhance low frequency sound for added effect.

■ Deep Color

Deep Color refers to the use of various color depths in displays, up from the 24-bit depths in previous versions of the HDMI specification. This extra bit depth allows HDTVs and other displays go from millions of colors to billions of colors and eliminate on-screen color banding for smooth tonal transitions and subtle gradations between colors. The increased contrast ratio can represent many times more shades of gray between black and white. Also Deep Color increases the number of available colors within the boundaries defined by the RGB or YCbCr color space.

■ Dolby Digital

Digital surround sound system which is developed by Dolby Laboratories provides completely independent multi-channel audio. With 3 front channels (left, center, and right) and 2 surround stereo channels, Dolby Digital provides five full-range audio channels. With an additional channel especially for bass effects (called LFE, or low frequency effect), the system has a total of 5.1 channels (LFE is counted as 0.1 channel). By using 2 channel stereo for the surround speakers, more accurate moving sound effects and surround sound environment are possible than with Dolby Surround.

■ **Dolby Pro Logic II**

It is an improved matrix decoding technology that provides better spatiality and directionality on Dolby Surround programmed material; provides a convincing three-dimensional sound field on conventional stereo music recordings; and is ideally suited to bring the surround experience to automotive sound. While conventional surround programming is fully compatible with Dolby Pro Logic II decoders, soundtracks will be able to be encoded specifically to take full advantage of Pro Logic II playback, including separate left and right surround channels.

■ **DTS**

Digital surround sound system developed by DTS, Inc., which provides 5.1 channel audio. With an abundance of audio data, it is able to provide authentic-sounding effects.

■ **HDMI**

HDMI (High-Definition Multimedia Interface) is the first industry-supported, uncompressed, all-digital audio/video interface. Providing an interface between any source (such as a set-top box or AV receiver) and an audio/video monitor (such as a digital television), HDMI supports standard, enhanced or high-definition video as well as multichannel digital audio using a single cable. HDMI transmits all ATSC HDTV standards and supports 8 channel digital audio, with bandwidth to spare to accommodate future enhancements and requirements. When used in combination with HDCP (High-bandwidth Digital Content Protection), HDMI provides a secure audio/video interface that meets the security requirements of content providers and system operators. For further information on HDMI, visit the HDMI website at "<http://www.hdmi.org/>."

■ **PCM (Pulse Code Modulation)**

A signal that is changed to digital format without compression. A CD is recorded with 16-bit sound at 44.1 kHz, while DVD recording is anywhere from 16 bits at 48 kHz to 24 bits at 192 kHz, which makes it a higher quality sound than CD.

■ **Sampling frequency**

The number of sampling (process for digitalizing analog signals) per second. In principle, the higher the sampling rate, the wider the frequency range that can be played back, and the higher the quantized bit rate, the finer the sound that can be reproduced.

■ **x.v.Color**

A color space standard supported by HDMI version 1.3. It is a more extensive color space than sRGB, and allows the expression of colors that could not be expressed before. While remaining compatible with the color gamut of sRGB standards, "x.v.Color" expands the color space and can thus produce more vivid, natural images. It is particularly effective for still pictures and computer graphics.

Specifications

■ SR-300

AUDIO SECTION

- Minimum RMS Output Power
Front Left and Right (1 kHz, 1% THD, 6 Ω)
..... 45 W+45 W
Center (1 kHz, 1% THD, 6 Ω)..... 45 W
Subwoofer (100 Hz, 1% THD, 3 Ω)..... 90 W
- Maximum Power
Front Left and Right (1 kHz, 10% THD, 6 Ω)
..... 50 W+50 W
Center (1 kHz, 10% THD, 6 Ω)..... 50 W
Subwoofer (100 Hz, 10% THD, 3 Ω)..... 100 W

FM SECTION

- Tuning Range
[U.S.A. and Canada models]..... 87.5 to 107.9 MHz
[Other models] 87.50 to 108.00 MHz
- Frequency Step
[U.S.A. and Canada models]..... 200 kHz
[Other models] 50 kHz
Antenna Input (unbalanced)..... 75 Ω

SUBWOOFER SECTION

- Type Bass reflex type
Non-magnetic shielding type
- Driver 13 cm (5-1/4 in) cone
- Frequency Response 35 Hz to 150 Hz
- Impedance 3 Ω



This system employs new technologies and algorithms that make it possible to achieve 7-channel surround sound with only front speakers, and without using wall reflections.



Manufactured under license from Dolby Laboratories. "Dolby", "Pro Logic" and the double-D symbol are trademarks of Dolby Laboratories.



"DTS" and "DTS Digital Surround" are registered trademarks of DTS, Inc.

iPod™

"iPod" is a trademark of Apple Inc., registered in the U.S. and other countries.

GENERAL

- Power Supply
[U.S.A. and Canada models] AC120 V, 60 Hz
[Other models] AC220-240 V, 50/60 Hz
- Power Consumption..... 35 W
- Standby Power Consumption
[U.S.A. and Canada models] less than 0.4 W
[Other models] less than 0.5 W
- Dimensions (W × H × D) 435 × 151 × 361 mm
(17-1/8 × 6 × 14-1/4 in)
- Weight..... 8.6 kg

■ NS-BR300

- Type Acoustic suspension type
Non-magnetic shielding type
- Driver (Full range)
..... 4 × 10 cm (1-1/2 × 4 in) cone × 3
- Frequency Response 150 Hz to 20 kHz
- Impedance..... 6 Ω
- Dimensions (W × H × D)
NS-BR300..... 800 × 50 × 70 mm
(31-1/2 × 2 × 2-3/4 in)
Stand 45 × 70 × 88 mm
(1-3/4 × 2-3/4 × 3-1/2 in)
- Weight..... 1.5 kg

* Specifications are subject to change without notice.

Bluetooth™

Bluetooth is a registered trademark of Bluetooth SIG and is used by Yamaha in accordance with a license agreement.

HDMI

"HDMI," the "HDMI" logo and "High-Definition Multimedia Interface" are trademarks, or registered trademarks of HDMI Licensing LLC.

x.v.Color™

"x.v.Color" is a trademark of Sony Corporation.

UniVolume

"UniVolume" is a trademark of Yamaha Corporation.

Available signal information

■ HDMI signal compatibility

Audio signals

| Audio signal types | Audio signal formats | Compatible media |
|---------------------|------------------------------|---------------------------------------|
| 2ch Linear PCM | 2ch, 32-96 kHz, 16/20/24 bit | CD, DVD-Video, DVD-Audio, etc. |
| Multi-ch Linear PCM | 8ch, 32-96 kHz, 16/20/24 bit | DVD-Audio, Blu-ray disc, HD DVD, etc. |
| Bitstream | Dolby Digital, DTS | DVD-Video, etc. |



- Refer to the supplied instruction manuals of the input source component, and set the component appropriately.
- When CPPM copy-protected DVD-Audio is played back, video and audio signals may not be output depending on the type of the DVD player.
- This unit is not compatible with HDCP-incompatible HDMI or DVI components.
- To decode audio bitstream signals on this unit, set the input source component appropriately so that the component outputs the bitstream audio signals directly (does not decode the bitstream signals on the component). Refer to the supplied instruction manuals for details.

Video signals

This unit is compatible with the video signals of the following resolutions:

- 480i/60 Hz
- 576i/50 Hz
- 480p/60 Hz
- 576p/50 Hz
- 720p/60 Hz, 50 Hz
- 1080i/60 Hz, 50 Hz
- 1080p/60 Hz, 50 Hz, 24 Hz

