CENTRAL REMOTE CONTROLLER

MODELS

DCS302C71

Read these instructions carefully before installation.
Keep this manual in a handy place for future reference.
This manual should be left with the equipment owner.

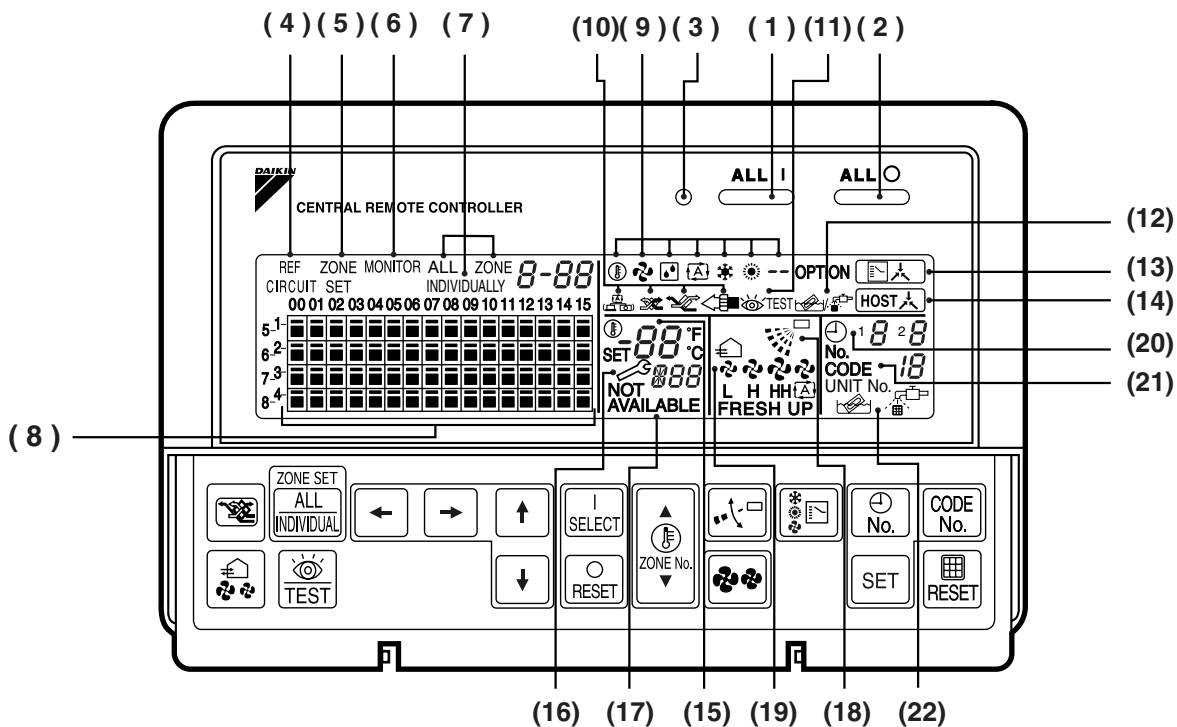

Fig. 1

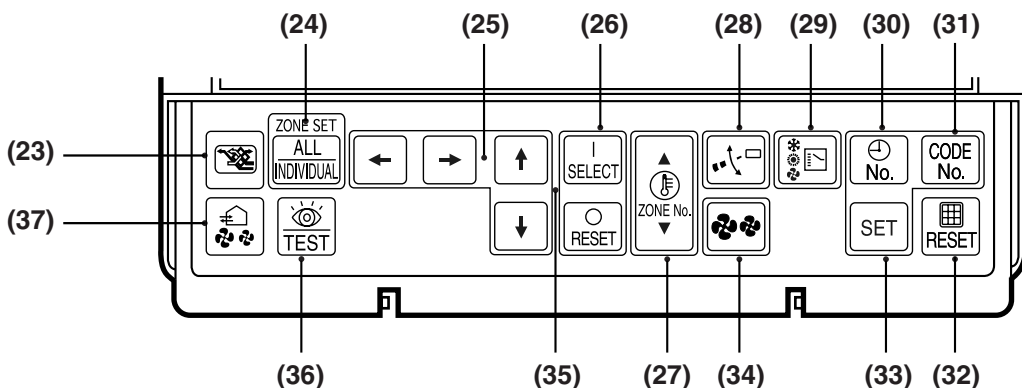

Fig. 2

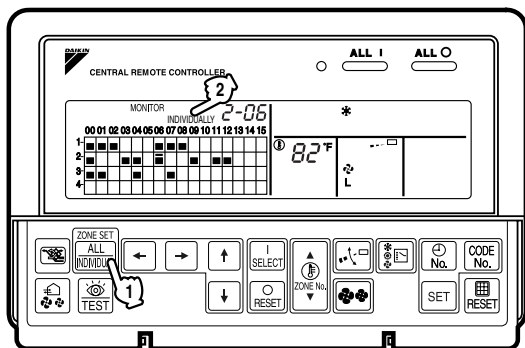

Fig. 3

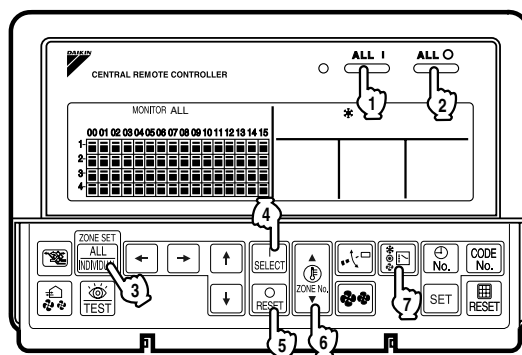

Fig. 4

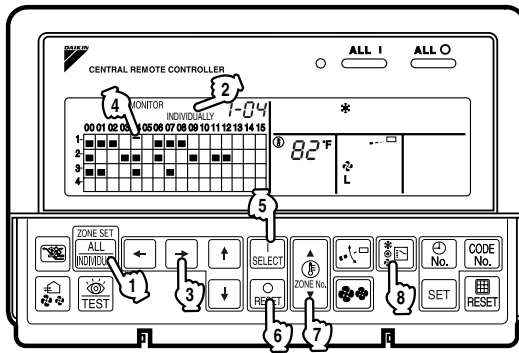

Fig. 5

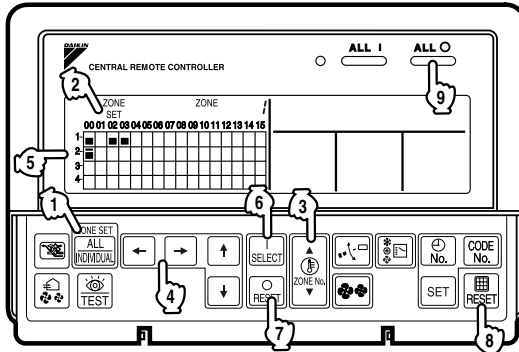

Fig. 6

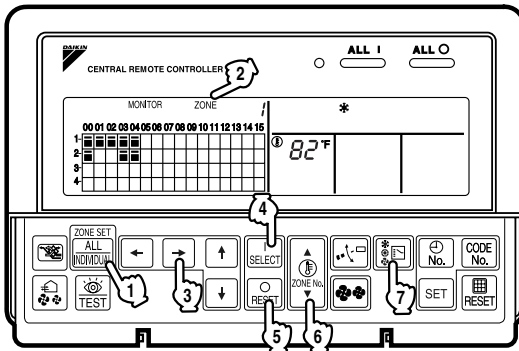

Fig. 7

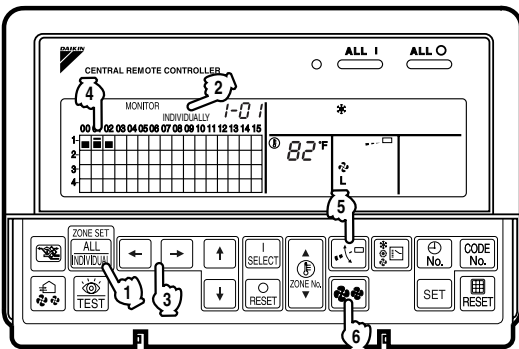

Fig. 8

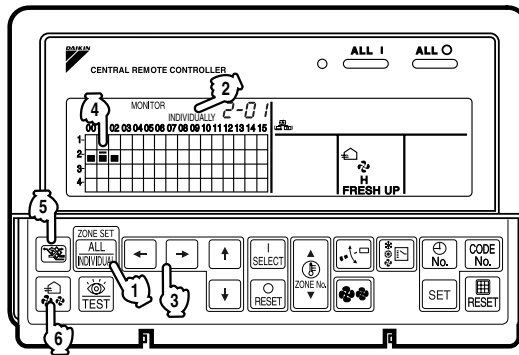

Fig. 9

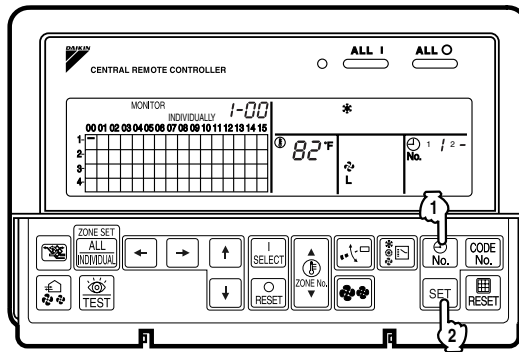

Fig. 10

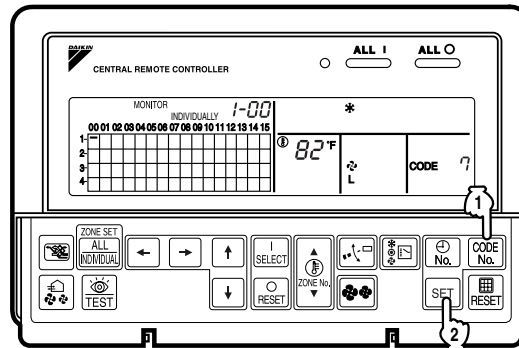

Fig. 11

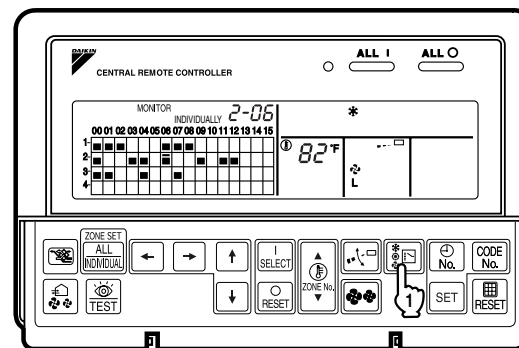

Fig. 12

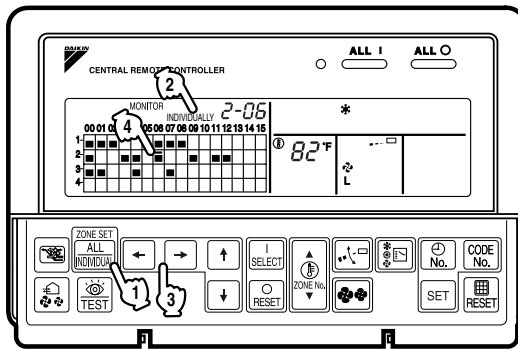

Fig. 13

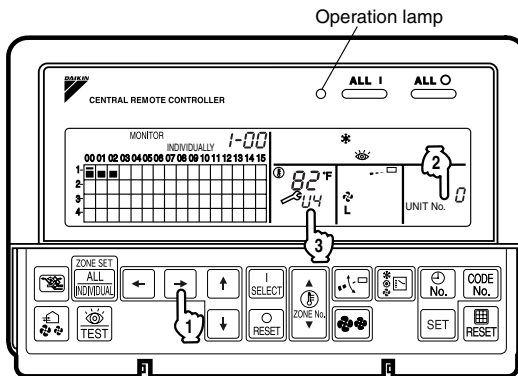

Fig. 14

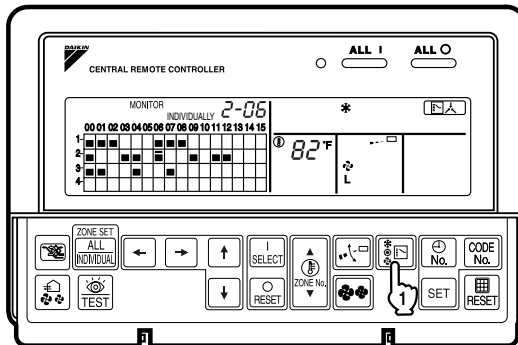

Fig. 15

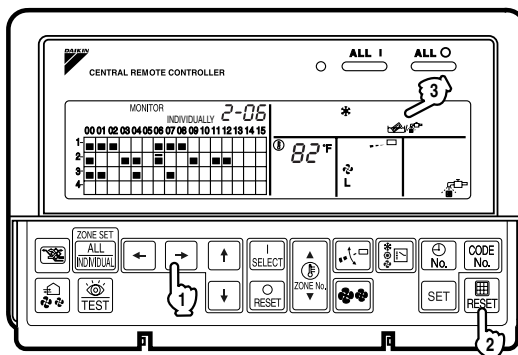

Fig. 16

BEFORE USE

■ GENERAL DESCRIPTION OF SYSTEM

This central remote controller can monitor and control up to 64 indoor unit groups.
Using two central remote controllers allows monitoring and controlling of up to 128 indoor unit groups.

Main Functions

1. Batch starting and stopping of indoor units connected to the central remote controller.
2. Handling of operation settings such as start/stop, timer operation, remote controller prohibition/permission, etc., and operation status settings such as temperature.
3. Operation status monitoring of operation mode, set temperature, etc.
4. Can be connected to an external central monitor panel and key system using the forced stop input (non-voltage a connector).

- When using 1 central remote controller

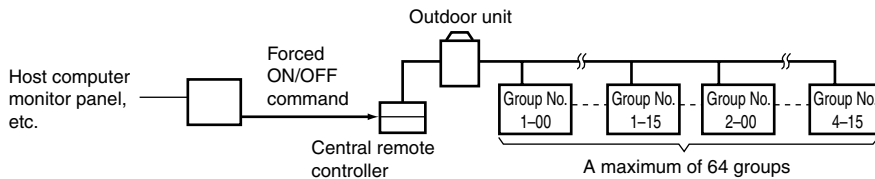

- When using 2 central remote controllers

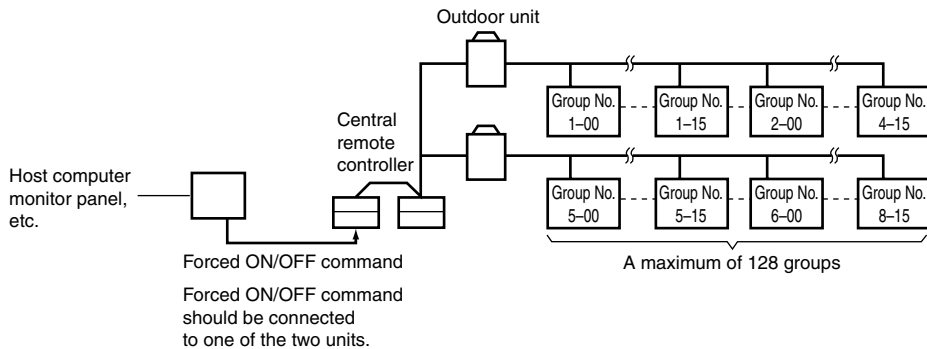

(The central remote controller and the separately sold remote control adapter circuit board or group remote control adapter cannot be used together.)

* GROUP OF INDOOR UNIT refers to the below.

1. A single indoor unit without remote controller

1. A single indoor unit without remote controller

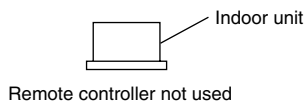

2. A single indoor unit controlled by one or two remote controllers

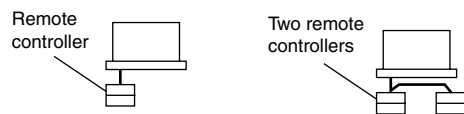

3. Maximum of 16 indoor units, group-controlled by one or two remote controllers

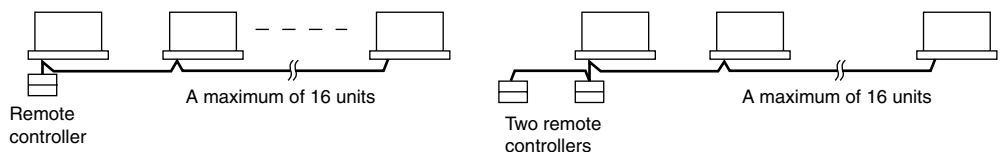

* Zone control from the central remote controller

Zone control is available from the central remote controller. With it, it is possible to make unified settings for multiple groups, so setting operations are greatly simplified.

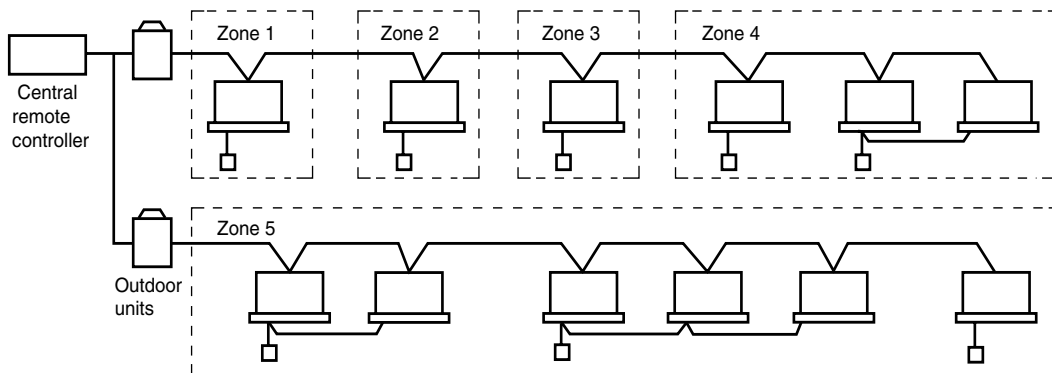

- Any setting you make within a given zone will apply to all groups in the said zone.
- A maximum of 64 zones can be set from a single central remote controller. (Each zone contains a maximum of 64 groups.)
- Zones can be set randomly from the central remote controller.

SAFETY CONSIDERATIONS

Please read these “SAFETY CONSIDERATIONS” carefully before installing air conditioning equipment and be sure to install it correctly.

After completing the installation, make sure that the unit operates properly during the start-up operation. Please instruct the customer on how to operate the unit and keep it maintained.

Also, inform customers that they should store this installation manual along with the operation manual for future reference. This air conditioner comes under the term “appliances not accessible to the general public”.

Meaning of warning, caution and note symbols.

⚠ WARNING Indicates a potentially hazardous situation which, if not avoided, could result in death or serious injury.

⚠ CAUTION Indicates a potentially hazardous situation which, if not avoided, may result in minor or moderate injury. It may also be used to alert against unsafe practices.

⚠ NOTE..... Indicates situation that may result in equipment or property-damage-only accidents.

Keep these warning sheets handy so that you can refer to them if needed.

Also, if this equipment is transferred to a new user, make sure to hand over this operation manual to the new user.

⚠ WARNING

In order to avoid electric shock, fire or injury, or if you detect any abnormality such as smell of fire, turn off power and call your dealer for instructions.

Ask your dealer for installation of the air conditioner. Incomplete installation performed by yourself may result in a water leakage, electric shock, and fire.

Ask your dealer for improvement, repair, and maintenance. Incomplete improvement, repair, and maintenance may result in a water leakage, electric shock, and fire.

Improper installation or attachment of equipment or accessories could result in electric shock, short-circuit, leaks, fire or other damage to the equipment. Be sure only to use accessories made by Daikin which are specifically designed for use with the equipment and have them installed by a professional.

Ask your dealer to move and reinstall the air conditioner or the remote controller.

Incomplete installation may result in a water leakage, electric shock, and fire.

Never let the indoor unit or the remote controller get wet. It may cause an electric shock or a fire.

Never use flammable spray such as hair spray, lacquer or paint near the unit. It may cause a fire.

Never replace a fuse with that of wrong ampere ratings or other wires when a fuse blows out. Use of wire or copper wire may cause the unit to break down or cause a fire.

Never inspect or service the unit by yourself. Ask a qualified service person to perform this work.

Cut off all electric waves before maintenance.

Do not wash the air conditioner or the remote controller with excessive water. Electric shock or fire may result.

Do not install the air conditioner or the remote controller at any place where flammable gas may leak out. If the gas leaks out and stays around the air conditioner, a fire may break out.

Do not touch the switch with wet fingers. Touching a switch with wet fingers can cause electric shock.



CAUTION

After a long use, check the unit stand and fitting for damage.

If they are left in a damaged condition, the unit may fall and result in injury.

Do not allow a child to mount on the unit or avoid placing any object on it.

Falling or tumbling may result in injury.

Do not let children play on and around the unit.

If they touch the unit carelessly, it may result in injury.

Do not place a flower vase and anything containing water.

Water may enter the unit, causing an electric shock or fire.

Never touch the internal parts of the controller.

Do not remove the front panel. Some parts inside are dangerous to touch, and a machine trouble may happen.

For checking and adjusting the internal parts, contact your dealer.

Avoid placing the controller in a spot splashed with water.

Water coming inside the machine may cause an electric leak or may damage the internal electronic parts.

Do not operate the air conditioner when using a room fumigation - type insecticide.

Failure to observe could cause the chemicals to become deposited in the unit, which could endanger the health of those who are hypersensitive to chemicals.

Safely dispose of the packing materials.

Packing materials, such as nails and other metal or wooden parts, may cause stabs or other injuries.

Tear apart and throw away plastic packaging bags so that children will not play with them. If children play with a plastic bag which was not torn apart, they face the risk of suffocation.

Do not turn off the power immediately after stopping operation.

Always wait at least five minutes before turning off the power. Otherwise, water leakage and trouble may occur.

The appliance is not intended for use by young children or infirm persons without supervision.

The remote controller should be installed in such away that children cannot play with it.



NOTE

Never press the button of the remote controller with a hard, pointed object.

The remote controller may be damaged.

Never pull or twist the electric wire of the remote controller.

It may cause the unit to malfunction.

Do not place the controller exposed to direct sunlight.

The LCD display may get discolored, failing to display the data.

Do not wipe the controller operation panel with benzene, thinner, chemical dustcloth, etc.

The panel may get discolored or the coating peeled off. If it is heavily dirty, soak a cloth in water-diluted neutral detergent, squeeze it well and wipe the panel clean. And wipe it with another dry cloth.

Dismantling of the unit, treatment of the refrigerant, oil and eventual other parts, should be done in accordance with the relevant local and national regulations.

CONTENTS

BEFORE USE	1	OPERATION MODE	13
GENERAL DESCRIPTION OF SYSTEM	1	Setting operation mode	16
SAFETY CONSIDERATIONS	2	Group monitoring	16
FEATURES AND FUNCTIONS	6	Error diagnosing function	17
NAMES AND FUNCTIONS OF THE		Setting master remote controller	20
OPERATING SECTION	7	Display of time to clean	21
OPERATION	8	INSTALLATION TABLE	22
Individual screen, all screen, zone screen	8	OPTIONAL ACCESSORIES	23
Batch operation and stop method	9	DOUBLE CENTRAL REMOTE	
Group operation and stop method	9	CONTROLLERS	23
Registering zones	9	SPECIFICATIONS	24
Zone operation and stop method	10	Specifications	24
Changing the fan direction and fan strength	11	Outline drawings	24
Changing the ventilation mode and		Fig. 1, 2, 3, 4	3
ventilation strength	11	Fig. 5, 6, 7, 8	4
Timer Number Setting	11	Fig. 9, 10, 11, 12	25
Setting the Operation Code	12	Fig. 13, 14, 15, 16	26

FEATURES AND FUNCTIONS

■ Operation menu

This central remote controller can operate and stop machines by either group or zone.
Batch operation and batch stop functions are also available. When used in combination with the schedule timer (optional accessory), timer operation and stop functions are available.



See page
8—12.

■ Various operation modes.

You can operate the system from both this unit and the remote controller, so to enable various operation control patterns. Twenty different operation modes are available including five operation patterns:

1. Start/stop: remote controller prohibition, remote controller stop-only permission, central priority, after-press priority, remote controller permission timer
2. Operation modes: remote controller prohibition, remote controller permission
3. Set temperature: remote controller prohibition, remote controller permission



See page
13—15.

■ Zone control for simpler setting procedures

You can control a maximum of 64 groups of indoor units by using this central remote controller. You don't have to repeat the same setting operations by group because you can make each of the following settings by zone.

A functions is available for setting all groups in one batch.

- Operation mode
- Control mode
- Setting temperature
- Programming time No. (Used in conjunction with the schedule timer)



See page
8—16.

■ Monitoring all indoor unit information

The following information can be displayed by group.

- Operation information such as operation mode, set temperature, etc., for indoor units
- Maintenance information such as cleaning signs for filters or elements
- Error codes and other malfunction diagnosis information



See page
16—21.

■ Function of refrigerant system display

This display helps you understand, at a glance, the indoor units sharing the same outdoor unit and the particular indoor unit among them that is set as the master remote controller.

























See page 20.



- Room air conditioners and multi-purpose air conditioners may also be connected by using separately-sold adapter boards.

This may limit functionality, so consult the manuals that come with each adapter board.

NAMES AND FUNCTIONS OF THE OPERATING SECTION (Fig. 1, 2)

1	UNIFIED OPERATION BUTTON
	Press to operate all indoor units.
2	UNIFIED STOP BUTTON
	Press to stop all indoor units.
3	OPERATION LAMP (RED)
	Lit white any of the indoor units under control is in operation.
4	“^{REF} CIRCUIT” DISPLAY (REFRIGERANT SYSTEM DISPLAY)
	This indication in the square is lit while the refrigerant system is being displayed.
5	“^{ZONE} SET” DISPLAY (ZONE SETTING)
	The lamp is lit while setting zones.
6	“MONITOR” DISPLAY (OPERATION MONITOR)
	The lamp is lit while operation is being monitored.
7	“ALL” “ZONE” “INDIVIDUALLY” DISPLAY
	The status displays indicates either batch functions or which zone or individual unit (or group) are being used.
8	OPERATION MONITOR
	Each square displays the state corresponding to each group.
9	“” “” “” “” “” “” “--”
	DISPLAY (OPERATION MODE) Displays operating state.
10	“” “” “” “” DISPLAY (VENTILATION CLEANING DISPLAY)
	This is displayed when a Ventiair total enthalpy heat exchanger unit or other such unit is connected.
11	“TEST” DISPLAY (INSPECTION/TEST)
	Pressing the maintenance/test run button (for service) displays this. This button should not normally be used.
12	“/” DISPLAY (TIME TO CLEAN)
	It lights up when any individual unit (group) has reached the time for the filter or element to be cleaned.

13	“” DISPLAY (COOLING/HEATING SELECTION PRIVILEGE NOT SHOWN)
	For zones or individual units (groups) for which this is displayed, cooling and heating cannot be selected.
14	“” DISPLAY (UNDER HOST COMPUTER INTEGRATED CONTROL)
	While this display is lit up, no settings can be made. It lights up when the upper central machines are present on the same air conditioning network.
15	“ 88°F” DISPLAY (PRESET TEMPERATURE)
	Displays the preset temperature.
16	“ U4” DISPLAY (MALFUNCTION CODE)
	This displays (flashes) the content of errors when an error failure has occurred. In maintenance mode, it displays the latest error content.
17	“NOT AVAILABLE” DISPLAY (NO FUNCTION DISPLAY)
	If a function is not available in the indoor unit even if the button is pressed, “NOT AVAILABLE” is may be displayed for a few seconds.
18	“” DISPLAY (FAN DIRECTION SWING DISPLAY)
	This displays whether the fan direction is fixed or set to swing.
19	“” “” “” “” “” “FRESH UP” DISPLAY (VENTILATION STRENGTH/SET FAN STRENGTH DISPLAY)
	This displays the set fan strength.
20	“ No.” DISPLAY (TIME NO.)
	Displays the operation timer No. when used in conjunction with the schedule timer.

21	“ CODE UNIT No. 18 ” DISPLAY (OPERATION CODE AND UNIT NUMBER DISPLAY)
	The method of operation (remote controller prohibited, central operation priority after-press operation priority, etc.) is displayed by the corresponding code. This displays the numbers of any indoor units which have stopped due to an error.
22	“  ” “  ” DISPLAY (TIME TO CLEAN AIR CLEANER ELEMENT/TIME TO CLEAN AIR FILTER)
	Displayed to notify the user it is time to clean the air filter or air cleaner element of the group displayed.
23	VENTILATION MODE BUTTON
	This is pressed to switch the ventilation mode of the total enthalpy heat exchanger.
24	ALL/INDIVIDUAL BUTTON
	Pressing this button scrolls through the “all screen”, “zone screen”, and “individual screen”.
25	ARROW KEY BUTTON
	This button is pressed when calling an individual indoor unit or a zone.
26	ON/OFF BUTTON
	Starts and stops ALL, ZONE, and INDIVIDUAL units.
27	TEMPERATURE ADJUSTMENT BUTTON (ZONE NUMBER BUTTON)
	This button is pressed when setting the temperature. Select the zone number if any zones have been registered.
28	FAN DIRECTION ADJUSTMENT BUTTON
	This button is pressed when setting the fan direction to “fixed” or “swing”.
29	OPERATION MODE SELECTOR BUTTON
	This sets the operation mode. The dry setting cannot be done.
30	TIME NO. BUTTON
	Selects time No. (Use in conjunction with the schedule timer only).
31	CONTROL MODE BUTTON
	Selects control mode.
32	FILTER SIGN RESET BUTTON
	This button is pressed to erase the “clean filter” display after cleaning or replacement.

33	SET BUTTON
	Sets control mode and time No.
34	FAN STRENGTH ADJUSTMENT BUTTON
	Pressing this button scrolls through “weak”, “strong”, and “fast”.
35	ZONE SETTING BUTTON
	Zone registration mode can be turned on and off by pressing the start and stop buttons simultaneously for at least four seconds.
36	INSPECTION/TEST RUN BUTTON (FOR SERVICE)
	Pressing this button scrolls through “inspection”, “test run”, and “system display”. This button is not normally used.
37	VENTILATION STRENGTH ADJUSTMENT BUTTON
	This button is pressed to switch the ventilation strength (“fresh up”) of the total enthalpy heat exchanger.
(Notes)	
1. Please note that all the displays in the figure appear for explanation purposes or when the cover is open.	
2. If the unit is used in conjunction with other optional central controllers, the OPERATION LAMP of the unit that is not under operation control may light up and go out a few minutes behind schedule. This shows that the signal is being exchanged, and does not indicate any failure.	

OPERATION

■ Individual screen, all screen, zone screen (Fig. 3)

This controller can perform operations in the individual screen, all screen, or zone screen.

- Individual screen The individual screen is used when performing group operations.
- All screen The all screen is used when performing operations for all units at once.
- Zone screen The zone screen is used when performing zone operations.

1. Select the screen by pressing the “ALL/INDIVIDUAL” button.

 Every time the “ALL/INDIVIDUAL” button is pressed, the selection scrolls through INDIVIDUAL → ALL → ZONE.

If nothing is done in the all or zone screens for one minute, it automatically goes to the individual screen.

- If the zone number in the zone screen is displayed as “--,” this indicates that no units are registered in a zone.
Please perform zone registration before proceeding in the zone screen. (See page 9)

■ Batch operation and stop method (Fig. 4)

This is for operating or stopping all connected units at once.

A. What to do when operating or stopping all connected units at once.

1. Press either “ALL |” or

 “ALL ○”.

- Operation can be performed from the individual screen, the all screen, or the zone screen.
- The “TEMPERATURE ADJUSTMENT” and “OPERATION MODE SELECTOR” buttons cannot be used.
To set the temperature and operation mode, use B. batch operation.

B. Batch Operation

1. Press the “ALL/INDIVIDUAL button” to enter the all screen.

The “” display lights up on all registered units.

2. Press the “SELECT” button.

The “” display lights up on all connected units.

 Press the “RESET” button.

The “” display goes off on all connected units. Operation and stop in the batch screen are done the same as with the batch operation and batch stop buttons.

3. Press the “TEMPERATURE ADJUSTMENT” button.

The temperature rises 1° every time the (▲) button is pressed.

The temperature drops 1° every time the (▼) button is pressed.

Set to “--” when you do not wish to use batch setting for the temperature setting.

Setting to 1° above or below the temperature setting range displays “--”.

4. Call up the desired mode by pressing the “OPERATION MODE SELECTOR” button.

Set to “--” when you do not wish to use batch setting for the operation setting.

■ Group operation and stop method (Fig. 5)

This is for operating or stopping connected units in groups.

[Group operation]

1. Press the “ALL/INDIVIDUAL button” to enter the individual screen.

The unit will enter the individual screen automatically if nothing is done for one minute.

2. Using the arrow keys, move the “” to select the units to operate or stop.

Keeping the button pressed down will move it rapidly.

The “” in this screen has selected unit 1-04.

3. Press the “SELECT” button.

The “” display lights up in the group.

 Press the “RESET” button.

The “” display goes off in the group.

4. Press the “TEMPERATURE ADJUSTMENT” button.

The temperature rises 1° every time the (▲) button is pressed.

The temperature drops 1° every time the (▼) button is pressed.

Temperature adjustment cannot be done if the selected group’s air conditioners are in fan mode.

5. Call up the desired mode by pressing the “OPERATION MODE SELECTOR” button.

■ Registering zones (Fig. 6)

It is possible to set multiple groups as one zone and control each zone separately.

No zones are registered when the unit is shipped from the factory.

Zone registration can be done in the individual screen, all screen, or zone screen.

[Registration]

1. Pressing the “ALL/INDIVIDUAL” button for four seconds. Displays ZONE SET.

Zone Number 1 will be displayed, and if there are any groups already registered in the displayed

zone, a “” will light up on the operation monitor.

2. Select the Zone Number to be registered using the “ZONE NUMBER” button. Keeping the button pressed down will move it rapidly.

3. “” to the group you wish to register using the arrow keys. Keeping the button pressed down will move it rapidly.

4. Press the “SELECT” button to register that group to the zone.

The “” display lights up on all the selected units.

Pressing the “RESET” button removes the group from that zone, and “” goes off.

Repeat steps 3 and 4 until all the units you wish to register to the zone have been added.

	ZONE SET															
	00	01	02	03	04	05	06	07	08	09	10	11	12	13	14	15
1-																
2-																
3-																
4-																

In this example, a screen is shown with units 1-00, 1-02, 1-03, and 2-00 registered to Zone Number 1.

5. Repeat steps 2 to 4 to register to the next zone.

6. Once zone registration is complete, press the “ALL/INDIVIDUAL” button to turn off “ZONE SET” display and return to the individual screen.

The display returns to the normal screen if nothing is done for one minute when in zone registration mode.

(NOTE)

- It is impossible to register one group to several different zones. If this is done, the last zone registered to will be valid.

[Batch deletion of zone registration]

1. Pressing the “ALL ○” for at least four seconds while pressing the “FILTER SIGN RESET” button when “ZONE SET” is displayed will delete all zone registrations.

The zone registrations for all units will be lost.

■ Zone operation and stop method (Fig. 7)

This is for operating or stopping connected units in zones.

[Zone operation]

1. Press the “ALL/INDIVIDUAL button” to enter the zone screen.

2. Using the arrow keys, select the zone number to operate or stop.

Pressing and reduces the zone number

while and raise the number.

Keeping the button pressed down will move it rapidly.

- If the zone number is displayed as “---,” this indicates that no units are registered in a zone. Please perform zone registration before using a zone. (See page 9)

3. Press the “SELECT” button.

The “” display lights up in the group.

Press the “RESET” button.

The “” display goes off in the group.

4. Press the “TEMPERATURE ADJUSTMENT” button.

The temperature rises 1° every time the (▲) button is pressed.

The temperature drops 1° every time the (▼) button is pressed.

Set to “--” when you do not wish to use zone setting for the temperature setting.

Setting to 1° above or below the temperature setting range displays “--”.

5. Call up the desired mode by pressing the “OPERATION MODE SELECTOR” button.

Set to “--” when you do not wish to use zone setting for the operation mode.

■ Changing the fan direction and fan strength (Fig. 8)

This changes the fan direction and strength settings in the air conditioner.

Changing the fan direction and strength is done in the individual screen.

[Registration]

1. Press the “ALL/INDIVIDUAL button” to enter the individual screen.
The unit will enter the individual screen automatically if nothing is done for one minute.
2. Using the arrow keys, move the “” to select the units to fan direction adjustment or fan strength adjustment.
Keeping the button pressed down will move it rapidly.
3. Press the “FAN DIRECTION ADJUSTMENT” button.
This sets “fixed” or “swing” for the fan direction.
 Press the “FAN STRENGTH ADJUSTMENT” button.
Pressing this button scrolls through “”, “”, and “”.
Depending on the indoor unit, only “” and “” may be available.

The functions included in the indoor units may vary. Pressing a button for a function which is not available will cause “NOT AVAILABLE” to be displayed.

■ Changing the ventilation mode and ventilation strength (Fig. 9)

This changes the ventilation mode and strength settings in the total enthalpy heat exchanger. Changing the ventilation mode and strength is done in the individual screen.

[Registration]

1. Press the “ALL/INDIVIDUAL button” to enter the individual screen.
The unit will enter the individual screen automatically if nothing is done for one minute.
2. Using the arrow keys, move the “” to select the units to ventilation mode or ventilation strength adjustment.
Keeping the button pressed down will move it rapidly.

3. Press the “VENTILATION MODE” button.

It will scroll through “” → “” → “” → “”.

Press the “VENTILATION STRENGTH ADJUSTMENT” button.

It will scroll through “” → “” → “” → “” → “”.

The fresh up function may not be available depending on the connected unit model.

The functions included in the indoor units may vary. Pressing a button for a function which is not available will cause “NOT AVAILABLE” to be displayed.

• Ventilation Mode and Amount

If these are changed using the remote controller depending on the unit model, they cannot be displayed on the central remote controller.

To monitor the ventilation mode and amount, check the values on the remote controller.

■ Timer Number Setting (Fig. 10)

(Only when used with the schedule timer)

Using this together with the schedule timer makes it possible to set on and off times four times a day.

[Registration]

1. Pressing the “TIMER NO.” button causes the number set for timer number 1 to blink.
If no timer setting has been made “-” will be displayed.
Select the desired timer number by pressing the “TIMER NO.” button.

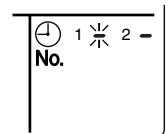

2. Once the desired timer number is displayed, press the “SET” button.

Press the “SET” button within 10 seconds after the timer number is displayed.

The display will return to how it was after 10 seconds.

The display for timer number 1 will stop blinking and then timer number 2 will start blinking.

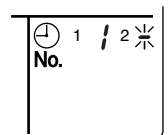

3. Select the desired timer number by pressing the “TIMER NO.” button.

Once the desired timer number is displayed,  press the “SET” button.

The display for timer number 2 will stop blinking.

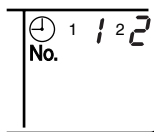

The “ No.” display will disappear after 3 seconds.

Select “-” in the timer number when you do not wish to set a timer number.

It is possible to set only one timer number.

(The times for turning the unit(s) on and off twice a day can be set with a single timer number.)

• **Timer Number Setting**

Group control: select the unit in the individual screen and set the timer number.

Batch control: set the timer numbers for all connected units.

Zone control: set the timer numbers for all zone-registered units.

Call up the zones which you wish to set in the zone screen and set the timer numbers.

- **Since the timer number will be set to after-press priority, the timer number in the last screen set will be valid for the connected units.**

Example 1

Setting timer number 1 for unit 1-00 to “1” and timer number 2 to “2” in the individual screen and then setting timer number 1 to “3” and timer number 2 to “4” in the batch screen causes the timer numbers for all units to be set, so timer number 1 for unit 1-00 will be “3” and timer number 2 will be “4”.

Example 2

To prevent leaving units on, timer number 1 is set to “5” in the batch screen.

Setting timer number 1 in zone number 1 to “-” in the zone screen after that will change the timer number for zone number 1, so the setting to prevent leaving the units on will be lost for zone number 1 only.

If a timer number is set incorrectly by accident, redo the setting in the desired screen.

- **What happens when the timer number on time and off time are set to the same time**

When the on time and off time are set to the same time for the same timer number, operation does not change.

When the on time and off time are set to the same time for different timer numbers, the off time is given priority.

When using timer operation, make sure the times do not overlap when setting the program of the schedule timer.

■ Setting the Operation Code (Fig. 11)

[Registration]

1.  Pressing the “CONTROL MODE” button causes the currently set operation code to blink.

Call up the desired code number by pressing the

 “CONTROL MODE” button.

Scroll through the code numbers.

2.  Once the code number is displayed, press the “SET” button.

The display will stop blinking.

The operation code display will disappear after 3 seconds.

[The Operation Code Setting]

Group control: select the unit in the individual screen and set the operation code.

Batch control: set the operation code for all connected units.

Zone control: set the operation code for all zone-registered units.

Call up the zones which you wish to set in the zone screen and set the operation code.

Since the operation code will be set for after-press priority, setting the operation code in the zone and individual screens after setting the operation code in the batch screen, will cause the operation codes set afterwards to be valid.

OPERATION MODE

The following five operation control modes can be selected along with the temperature setting and operation mode by remote controller, for a total of twenty different modes. These twenty modes are set and displayed with control modes of 0 to 19. (For further details, see **EXAMPLE OF OPERATION SCHEDULE** on the next page.)

- ON/OFF control impossible by remote controller..... Use this mode when operating and stopping from the central remote controller only. (ON/OFF control by the remote controller is disabled.)
- Only OFF control possible by remote controller Use this mode when executing the operation only by the central remote controller, and executing only the stop by remote controller.
- Centralized..... Use this mode when executing the operation only by the central remote controller, and executing start/stop freely by remote controller during the preset hours.
- Individual Use this mode when executing start/stop both by central remote controller and remote controller.
- Timer operation possible by remote controller..... Use this mode when executing start/stop by remote controller during the preset hours, and not starting operation by the central remote controller at the programmed time of system start.

[HOW TO SELECT THE CONTROL MODE]

- Select whether to accept or to reject the operation from the remote controller regarding the operation, stop, temperature setting and operation mode setting, respectively, and determine the particular control mode from the rightmost column of the table below.

Example

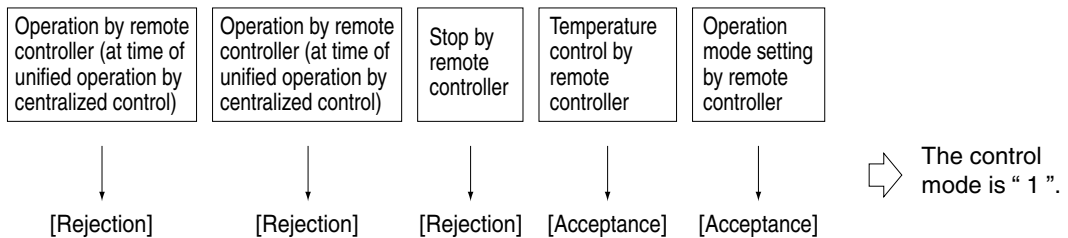

Operation mode	Control by remote controller					Control mode
	Operation		Stop	Temperature control	Operation mode setting	
	Unified operation, individual operation by central remote controller, or operation controlled by timer	Unified stop, individual stop by central remote controller, or timer stop				
ON/OFF control impossible by remote controller	<u>Rejection</u> (Example)	<u>Rejection</u> (Example)	<u>Rejection</u> (Example)	Rejection	Acceptance	0
Only OFF control possible by remote controller					Rejection	10
	Centralized	Acceptance	Acceptance	Acceptance	<u>Acceptance</u> (Example)	<u>1</u> (Example)
Rejection					11	
Individual	Acceptance	Acceptance	Acceptance	Acceptance	Rejection	2
					Rejection	12
Timer operation possible by remote controller	Acceptance (During timer at ON position only)	Rejection (During timer at OFF position)	Acceptance	Acceptance	Acceptance	3
					Rejection	13
	Acceptance	Acceptance	Acceptance	Acceptance	Rejection	4
					Rejection	14
	Acceptance	Acceptance	Acceptance	Acceptance	Acceptance	5
					Rejection	15
	Acceptance	Acceptance	Acceptance	Acceptance	Rejection	6
					Rejection	16
	Acceptance	Acceptance	Acceptance	Acceptance	Acceptance	7
					Rejection	17
	Acceptance	Acceptance	Acceptance	Acceptance	Rejection	8
					Rejection	18
	Acceptance	Acceptance	Acceptance	Acceptance	Acceptance	9
					Rejection	19

Note) Do not select the timer operation possible without the remote controller. In this case, timer operation is disabled.

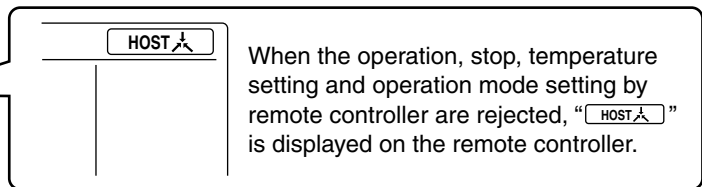
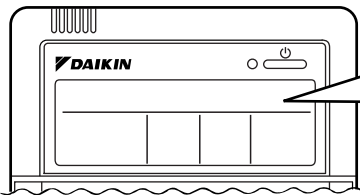

EXAMPLE OF OPERATION SCHEDULE

Operation schedule is possible only in conjunction with the schedule timer (optional accessory).

Liquid crystal display of schedule timer

ON/OFF control impossible by remote controller

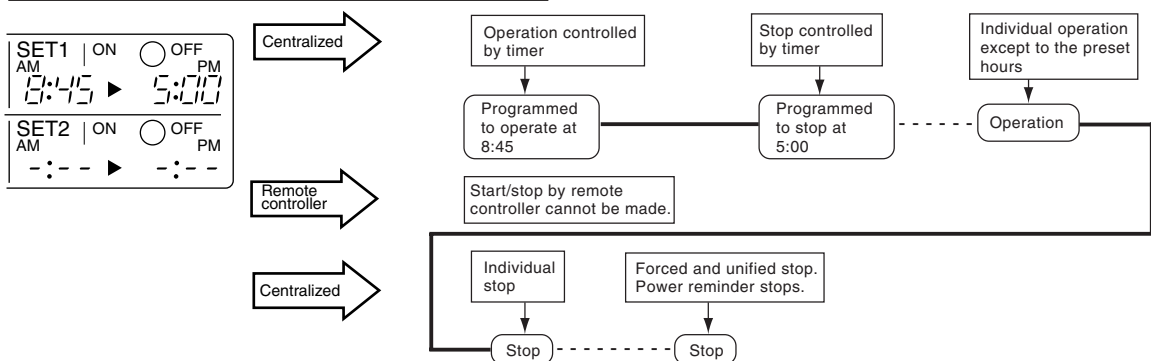

Only OFF control possible by remote controller

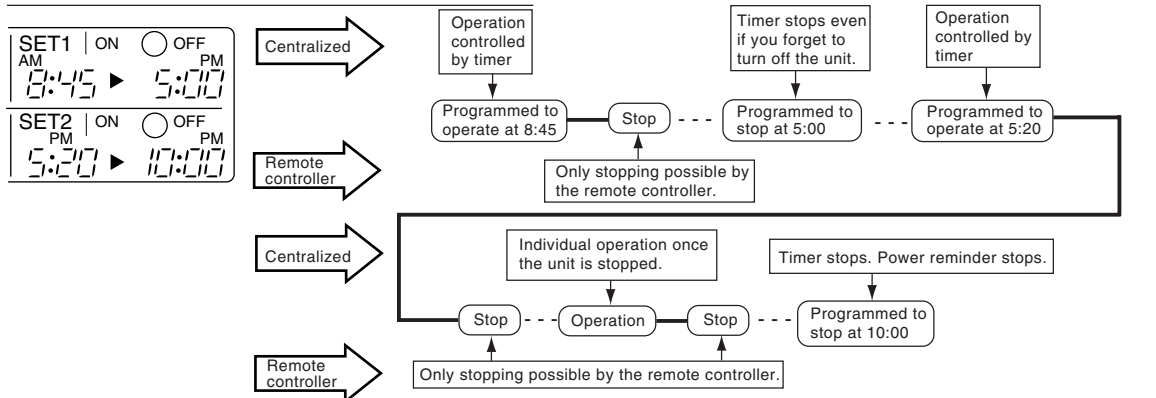

Centralized

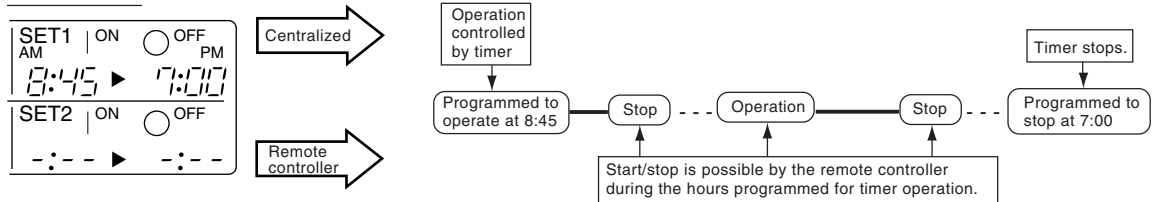

Individual

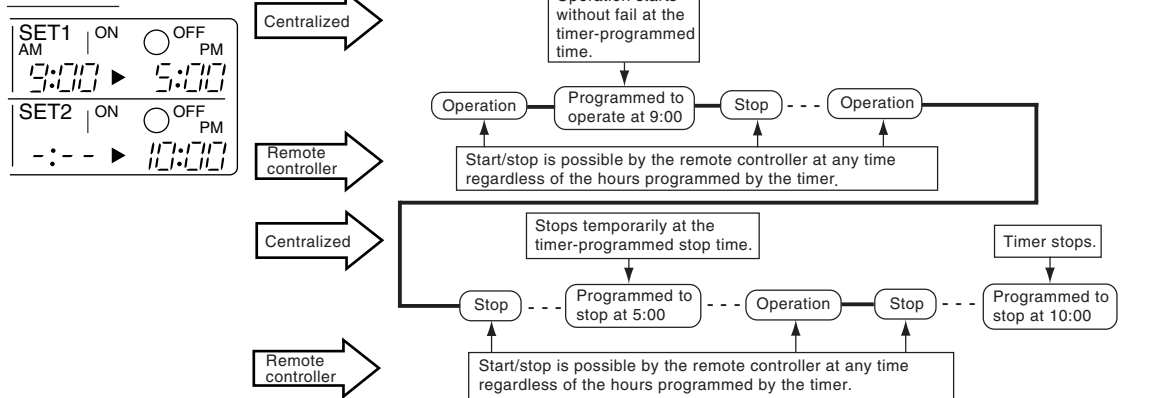

Timer operation possible by remote controller

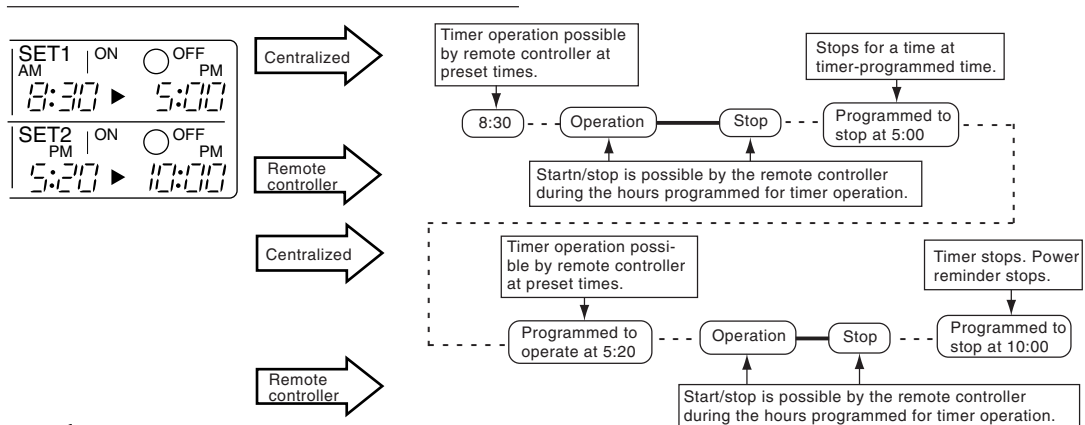

- Air conditioner now operating.
- - - Air conditioner now stopping.
- ▭ Command by central remote controller
- Command by remote controller

■ Setting operation mode (Fig. 12)

[Registration]

1. Press the **OPERATION MODE SELECTOR BUTTON**. Each time you press this button, the display rotates as shown on the below list.

• List of operations which can be set

In the below list, “○” refers to the acceptable setting, while “x” refers to the not acceptable setting.

Display	A: Zones and groups with no “ ” display.	
	Setting	Contents of setting
	x	
	○	Can be set in individual zones or groups
	○ * 1	Can be set in individual zones or groups
	○	Can be set in individual zones or groups
	○	Can be set in individual zones or groups
	○ * 1	Can be set in individual zones or groups * 3
	○ * 1	Can be set in individual zones or groups
	○	Select this display if you don't wish to set by zone.

Display	B: Zones and groups with a “ ” display.	
	Setting	Contents of setting
	○	To be set by zone * 2
	○	Can be set in individual zones or groups
	x	
	x	The displays are shown by group * 4
	x	The displays are shown by group * 4
	○ * 1	Can be set in individual zones or groups * 3
	○ * 1	Can be set in individual zones or groups
	○	Select this display if you don't wish to set by zone.

- *1: Setting may not be acceptable depending on the type of indoor unit with which this unit is connected.
- *2: In zone control, the units run in temperature adjustment mode (heating or cooling) for the outdoor system for the groups registered to those zones. Heating or cooling selection is not available.

*3: or or

Changing the ventilation mode cannot be done in the zone screen. Changing the ventilation mode should be done in the individual screen.

- *4: In group control, the units run in temperature adjustment mode (heating or cooling) for the group outdoor system. Heating or cooling selection is not available.

• The Zone consists of the following two cases.

A. Zone without display “ ”

The group with master remote controller setting exists in this zone.

Setting the master remote controller enables cool/heat selection.

Operations other than cool/heat operations can also be set for some operations. For further details, see the list on the left.

B. Zone with display “ ”

No group with master remote controller setting exists in this zone.

The cool/heat selection is not available because the master remote controller has not been set.

Some operations other than cool/heat operations can be set. For further details, see the list in the left.

See page 20 if the display “ ” is flashing.

- Fan operation can be performed for each zone using the central remote controller even if there is no cooling/heating selection right during cooling or heating. Also, if a VentiAir is connected in the zone, ventilation and ventilation cleaning operation is possible. See the included operating manuals for details.
- When the indoor unit is in heat operation, change the setting to FAN operation through the central remote controller; then, you can switch the fan speed to the extremely low fan speed. Warm air may blow if any other indoor unit belonging to the same system is in heat operation.
- The indoor fan stops during defrost/hot start.
- DRY cannot be set from the central remote controller.

■ Group monitoring (Fig. 13)

Utilize the group monitor function in each of the following cases:

1. Check the malfunction code. (See the next page.)
2. Check the group that requires cleaning of the air filter and air cleaner element. (See page 21.)
3. Change the setting of the master remote controller. (See page 20.)
4. Check the group(s) sharing the same outdoor unit. Or, check the particular group(s) with the master remote controller setting. (See page 20.)
5. Check the conditions of other individual groups.

When in zone screen

The zone screen will revert to the individual screen automatically if nothing is done in it for one minute.

[Registration]

1. Press the “ALL/INDIVIDUAL” button to switch to the “INDIVIDUAL” screen.

2. Using the arrow key, move the “” to select the unit to be monitored.

Keeping the button pressed down will move it rapidly.

The “” lights up and the status of that unit is displayed in the LCD. The cursor in the screen Fig. 13 has selected unit 2-06.

■ Error diagnosing function (Fig. 14)

This central remote controller is provided with a diagnosing function, for when an indoor unit stops due to malfunction. In case of actuation of a safety device, disconnection in transmission wiring for control or failure of some parts, the operation lamp, inspection display and unit No. start to flash; then, the malfunction

code is displayed. Check the contents of the display, and contact your DAIKIN dealer because the above signs can give you the idea on the trouble area.

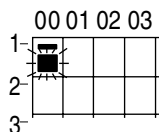

The display “” flashes under the group No. where the indoor unit that has stopped due to malfunction.

[Registration]

1. Press the ARROW KEY BUTTON to call up the group that has stopped due to malfunction.

The unit No. the malfunction code is flashing because of an error failure.

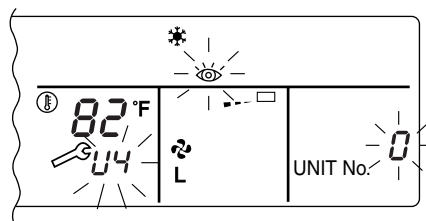

Operation lamp	Maintenance display	Unit No.	Malfunction code	Error content
	●		64	Indoor air thermistor error
	●		65	Outdoor air thermistor error
	●		68	HVU error (Ventiair dust-collecting unit)
	●		6A	Dumper system error
			6A	Dumper system error + Thermistor error
	●		6F	Simple remote controller error
	●		6H	Door switch (Ventiair dust-collecting unit), relay harness fault (Ventiair dust-collecting/humidifier unit)
			94	Ventiair internal transmission error (between total enthalpy – fan unit)
			A0	Indoor unit · external safety device error
			A1	Indoor unit · BEV unit (Sky-Air connection unit) PC board assembly fault
	●		A1	Indoor unit · PC board assembly fault
			A3	Indoor unit · Drain level error (33H)
			A6	Indoor unit · Fan motor (51F) lock, overload
	●		A7	Indoor unit · Fan direction adjustment motor (MA) error
			A9	Indoor unit · BEV unit, electric expansion valve motor (20E) error
	●		AF	Indoor unit · Malfunctioning drain
	●		AH	Indoor unit · Dust-collector error
			AJ	Indoor unit · Insufficient capacity setting, address setting fault

☀	☀	☀	C4	Indoor unit · Liquid piping thermistor (Th2) Error (faulty connection, cut wire, short circuit, fault)
☀	☀	☀	C5	Indoor unit · BEV unit, gas piping thermistor (Th3) Error (faulty connection, cut wire, short circuit, fault)
☀	☀	☀	C9	Indoor unit · Intake air thermistor (Th1) Error (faulty connection, cut wire, short circuit, fault)
☀	☀	☀	CA	Indoor unit · Outlet air thermistor (Th4) Error (faulty connection, cut wire, short circuit, fault)
☀	●	☀	CJ	Indoor unit · remote controller sensor error
☀	☀	☀	E0	Outdoor unit · Safety device operation
☀	☀	☀	E1	Outdoor unit · PC board assembly fault
☀	●	☀	E1	Outdoor unit · PC board assembly fault
☀	☀	☀	E3	Outdoor unit · High-pressure switch fault
☀	☀	☀	E4	Outdoor unit · Low-pressure switch fault
☀	☀	☀	E9	Outdoor unit · Electric expansion valve motor (20E) error
☀	●	☀	EC	Heat source unit · Intake water temperature inter-lock operation (fan operation)
☀	☀	☀	EF	Outdoor unit · Ice thermal storage unit error
☀	☀	☀	F3	Outdoor unit · Discharge piping temperature error
☀	●	☀	H3	Outdoor unit · High-pressure switch operation
☀	☀	☀	H4	Outdoor unit · Low-pressure switch operation
☀	☀	☀	H9	Outdoor unit · Outdoor air thermistor (Th1) Error (faulty connection, cut wire, short circuit, fault)
☀	●	☀	H9	Outdoor unit · Outdoor air thermistor (Th1) Error (faulty connection, cut wire, short circuit, fault)
☀	●	☀	HC	Outdoor unit · Water temperature sensor system error
☀	●	☀	HF	Ice thermal storage unit error, ice thermal storage controller error, error in outdoor unit during ice thermal storage operation
☀	☀	☀	HJ	Outdoor unit · water system fault
☀	☀	☀	J1	Outdoor unit · pressure sensor error
☀	☀	☀	J3	Outdoor unit · Discharge piping thermistor (Th3) Error (faulty connection, cut wire, short circuit, fault)
☀	●	☀	J3	Outdoor unit · Discharge piping thermistor (Th3) Error (faulty connection, cut wire, short circuit, fault)
☀	☀	☀	J5	Outdoor unit · Intake piping thermistor (Th4) Error (faulty connection, cut wire, short circuit, fault)
☀	☀	☀	J6	Outdoor unit · Heat exchange thermistor (Th2) error
☀	●	☀	J6	Outdoor unit · Heat exchange thermistor (Th2) error Error (faulty connection, cut wire, short circuit, fault)
☀	☀	☀	J7	Outdoor unit · Header thermistor (Th6) error
☀	☀	☀	JA	Outdoor unit · Discharge piping pressure sensor error
☀	☀	☀	JC	Outdoor unit · Intake piping pressure sensor error
☀	☀	☀	JF	Outdoor unit · Oil temperature sensor (Th5) system error
☀	●	☀	JH	Outdoor unit · Oil temperature sensor (Th5) system error
☀	☀	☀	L0	Outdoor unit · Inverter system fault
☀	☀	☀	L4	Outdoor unit · Inverter cooler fault
☀	☀	☀	L5	Outdoor unit · Ground circuit for compressor motor, short circuit, or power unit short circuit

☾	☾	☾	L6	Outdoor unit · Ground circuit for compressor motor, short circuit
☀	☾	☾	L8	Outdoor unit · Compressor overload, compressor motor wire disconnection
☾	☾	☾	L9	Outdoor unit · Compressor lock
☾	☾	☾	LA	Outdoor unit · Power unit error
☾	☾	☾	LC	Outdoor unit · Transmission error between inverter and outdoor control unit
☀ or ●	☾	☾	M1	Central controller: PC board fault
☀ or ●	☾	☾	M8	Transmission error between central controllers
☀ or ●	☾	☾	MA	Central controller: Incorrect combination
☀ or ●	☾	☾	MC	Central controller: Address setting fault
☾	●	☾	P0	Insufficient gas (thermal storage)
☾	☾	☾	P1	Outdoor unit · Power voltage imbalance, phase loss
☾	☾	☾	P4	Outdoor unit · Power unit temperature sensor error
☀	●	☾	U0	Pressure drop due to insufficient refrigerant, electric expansion valve fault, etc.
☾	☾	☾	U1	Reversed or lost phase
☾	☾	☾	U2	Power voltage error, momentary electrical stoppage
☾	☾	☾	U4	Transmission error between indoor unit/BEV unit and outdoor/BS unit, Transmission error between outdoor unit and BS unit
☾	☾	☾	U5	Transmission error between remote controller and indoor control unit
●	☀	●	U5	Remote controller board fault or remote controller setting fault
☾	☾	☾	U6	Transmission error between indoor units
☾	☾	☾	U7	Transmission error between outdoor units Transmission error between outdoor unit and ice thermal storage unit
☀	●	☾	U7	Transmission error between outdoor units (cooling/heating batch, low-noise operation)
☾	☾	●	U8	Transmission error between master remote controller and slave remote controller (slave remote controller error) Incorrect combination of indoor unit and remote controller within a single system (model)
☾	☾	☾	U9	Transmission error between indoor unit/BEV unit and outdoor unit within a single system Transmission error between BS unit and indoor unit/BEV unit and outdoor unit within a single system
☾	☾	☾	UA	Incorrect combination of indoor, BS, and outdoor units within a single system (model, number of units, etc.) Incorrect combination of indoor unit and remote controller (remote controller in question) BS unit connection position fault
☀	●	☀	UC	Central control group numbers overlap
☾	☾	☾	UE	Transmission error between indoor unit and central controller
☾	☾	☾	UF	Unset system, incorrect settings between BEV unit and indoor unit
☾	☾	☾	UH	System fault

■ error codes (in outline font) do not display “maintenance” and the system will run, but please check the content of the display and contact your dealer.

■ Setting master remote controller (Fig. 15)

You must set the master remote controller of the operation mode for one of the indoor units, if two or more such indoor units with the remote controller are connected with the outdoor unit where the operation modes such as cool/heat operation and FAN operation can be set by remote controller and central remote controller.

1. Preparations

When you want to fix settings

- Check the particular group with the master remote controller setting for the refrigerant system you wish to reset. (See the below.)

- Call up the group without the display

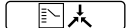
“” (See page 16.)

☞ Hold the OPERATION MODE SELECTOR BUTTON down for about four seconds while the above group is being called up.

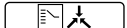
The display “” flashes on the liquid crystal display of the remote controller for all the groups sharing the same outdoor unit or BS unit.

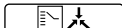
When you turn on the power switch for the first time, the display “” flashes.

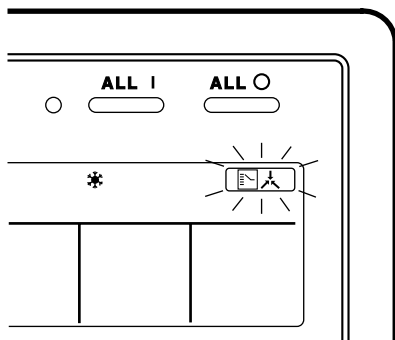

2. Setting selection right

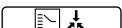
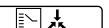
Pull up the desired group to set the master remote controller, and ☞ press the OPERATION MODE SELECTOR BUTTON. The master remote controller is set for this group, and the display “” goes out. The display “” appears for the other groups. Setting is finished now.



When switching operation

- In case of operation switch



Call up the zone including the group with the setting of master remote controller.

(Zone without the display “”)

☞ Press the OPERATION MODE SELECTOR BUTTON several times, and switch to the desired operation mode.

Each time you press it, the display is switched to “” “” “” and “--” in sequence.

NOTE

- However, the displays “” “” and “VENTILATION MODE” may appear in some zones, depending on the type on indoor unit with which they are connected.

(VENTILATION MODE)





[System Display]

1. Test run mode is necessary to display the system display.
2. In order to turn on test run mode, select the appropriate air conditioner on the individual screen with the cursor and then set its operation mode to either cooling or heating. (The air conditioner does not need to be running. It doesn't matter if it is, though.)
3. Press the “inspection/test run” button twice to put it into test run mode.
4. Pressing the “inspection/test run” button for four or more seconds in test run mode will display ☞ the “REF CIRCUIT.”

	00	01	02	03	04	05	06	07	08	09	10	11	12	13	14	15
1-	■			■		■	■	■								
2-			■	■												
3-																
4-																

Call the unit whose system you wish to look up using the arrow keys.

The “” on all groups in the same system as the displayed group will light up.

Of those, the “” display in all groups which have cooling/heating selection privilege will blink.

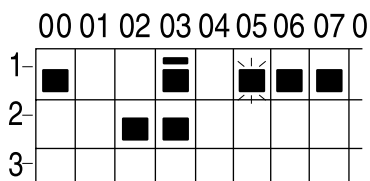

In this example, individual units 1-00, 1-03, 1-05, 1-06, 1-07, 2-02, and 2-03 are in the same system, and 1-05 has the cooling/heating selection privilege.

To look up other systems, call up all the units you wish to look up using the arrow keys.

Pressing the inspection/test run button one more time gets rid of the system display and ends it.

The unit will enter the individual screen automatically if nothing is done for one minute in the system display screen.



This function may not be available for all connected outdoor units, in which case “REF CIRCUIT” will blink. It will also not be correctly displayed if DIII-NET extension ADP is used.

■ Display of time to clean (Fig. 16)



This central remote controller displays the time to clean the air filter or air cleaner element for each group or any given group by utilizing two types of signs. The display “” tells the time to clean the air filter or the air cleaner element of some group.

If a cleaning sign is displayed

A filter or element in some group is ready to be cleaned.



1.  Press the **ARROW KEY BUTTON**, and search the groups displaying “” or “” (The group may be plural.)

Clean or change the air filter or air cleaner element.

For further details, see the operation manual attached to each indoor unit. (Clean or change the air filter or air cleaner element of all the groups displaying “” or “”.)

2.  Press the **FILTER SIGN RESET BUTTON**, and the display “” disappears. (Including all the groups where the air filter has been cleaned.)

NOTE

Be sure to check the display  “” has disappeared at this point. The appearance of the above display is a sign that the air filter or air cleaner element of some group still needs cleaning.







INSTALLATION TABLE

When installing the equipment, mark the zone No. of each group and installation location in the below table.

Setting group No.

(Setting is not possible unless power is activated to both the central remote controller and indoor unit.)

Operated by remote controller

1. Activate power to both the central remote controller and indoor unit.
2. While in the normal mode, hold down the “” button for a minimum of 4 seconds. The unified ON/OFF controller will enter the FIELD SET MODE.
3. Select the MODE No. “” with the “” button.
4. Use the “” button to select the group No. for each group. (Group No. increases in the order of 1-00, 1-01 ... 1-15, 2-00, ... 8-15.)
5. Press “” to set the selected group No.
6. Press “” to return to the NORMAL MODE.

Operated by simplified remote controller

1. Activate power to both the central remote controller and indoor unit.
2. Remove the upper part of the remote controller.
3. Press the **BS6** BUTTON (field set) on the PC board. The controller will enter the FIELD SET MODE.
4. Select the MODE No. “” with the **BS2** BUTTON and **BS3** BUTTON (temperature setting).
5. Use the **BS9** BUTTON (set A) and **BS10** BUTTON (set B) to select the group No. for each group. (Group No. increases in the order of 1-00, 1-01 ... 1-15, 2-00, ... 8-15.)
6. Press **BS7** BUTTON (set/cancel) to set the selected group No.
7. Press **BS6** BUTTON (field set) to return to the NORMAL MODE.

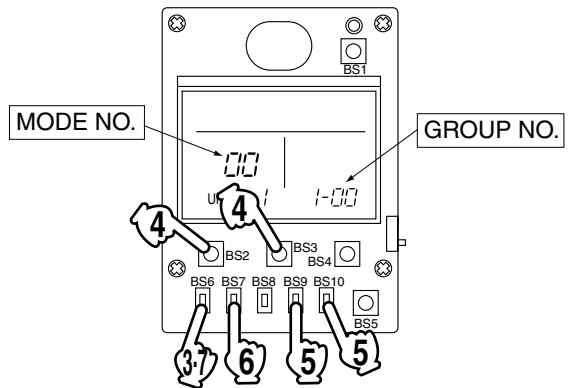
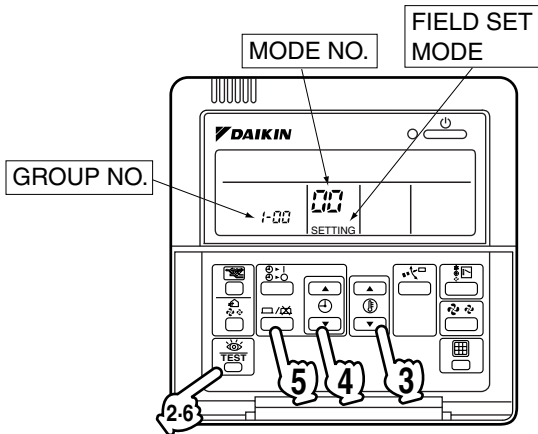

Zone No.																
Group No.	-00	-01	-02	-03	-04	-05	-06	-07	-08	-09	-10	-11	-12	-13	-14	-15
Indoor unit Quantity of units Controlled by																
Location																
Zone No.																
Group No.	-00	-01	-02	-03	-04	-05	-06	-07	-08	-09	-10	-11	-12	-13	-14	-15
Indoor unit Quantity of units Controlled by																
Location																

Zone No.																
Group No.	-00	-01	-02	-03	-04	-05	-06	-07	-08	-09	-10	-11	-12	-13	-14	-15
Indoor unit Quantity of units Controlled by																
Location																
Zone No.																
Group No.	-00	-01	-02	-03	-04	-05	-06	-07	-08	-09	-10	-11	-12	-13	-14	-15
Indoor unit Quantity of units Controlled by																
Location																

OPTIONAL ACCESSORIES

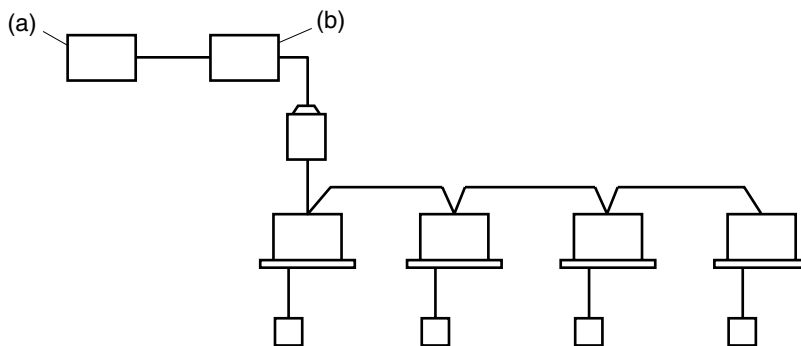

You can perform the normal operation, take off the malfunction contact point and unified start/stop by contact point, all by connecting this unit with the unification adaptor for computerized control. For further details, ask your DAIKIN dealer.

(a) Unification adaptor for computerized control (b) Central remote controller

DOUBLE CENTRAL REMOTE CONTROLLERS

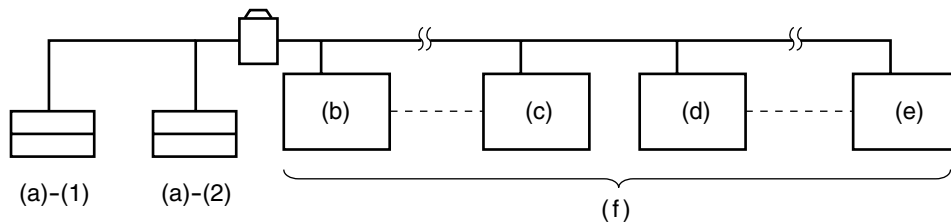

With two central remote controllers, centralized control (indoor units) is possible from different locations.

(a) Central remote controller (b) Group No. 1 - 00 (c) Group No. 1 - 15 (d) Group No. 2 - 00
(e) Group No. 4 - 15 (f) A maximum of 64 groups

Note)

- For control alignment and settings for double central remote controllers, contact your dealer.

SPECIFICATIONS

■ Specifications

Power supply	1 ~ 50/60Hz, 100V - 240V
Power consumption	Max. 8W
Forced ON/OFF input	Continuous "a" contact Contact current: approximately 10mA
Size	180 (W) × 120 (H) × 64.5 (D)
Weight	420g

■ Outline drawings

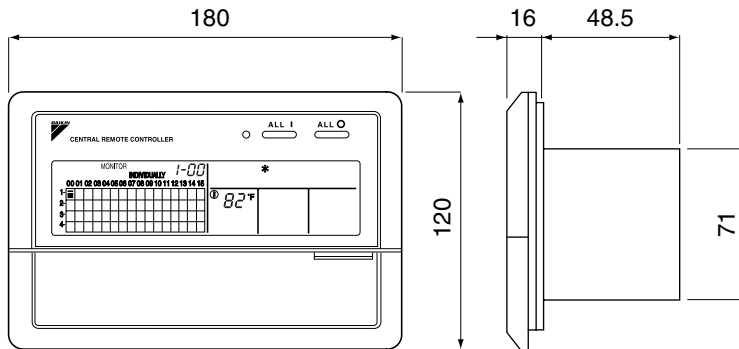

When using this unit an electric parts box of KJB311A is required.
For installation, a steel electric parts box to be embedded is mandatory.

DAIKIN INDUSTRIES, LTD.

Head office:
Umeda Center Bldg., 4-12, Nakazaki-Nishi 2 chome,
Kita-ku, Osaka, 530-8323 Japan

Tokyo office:
Shinjuku Sumitomo Bldg., 6-1 Nishi-Shinjuku
2-chome, Shinjuku-ku, Tokyo, 163-0235 Japan

DAIKIN EUROPE NV

Zandvoordestraat 300, B-8400 Oostende, Belgium