

METTLER TOLEDO

Xpress™

Operation and Service Manual

**METTLER TOLEDO
XRV Checkout Scale**

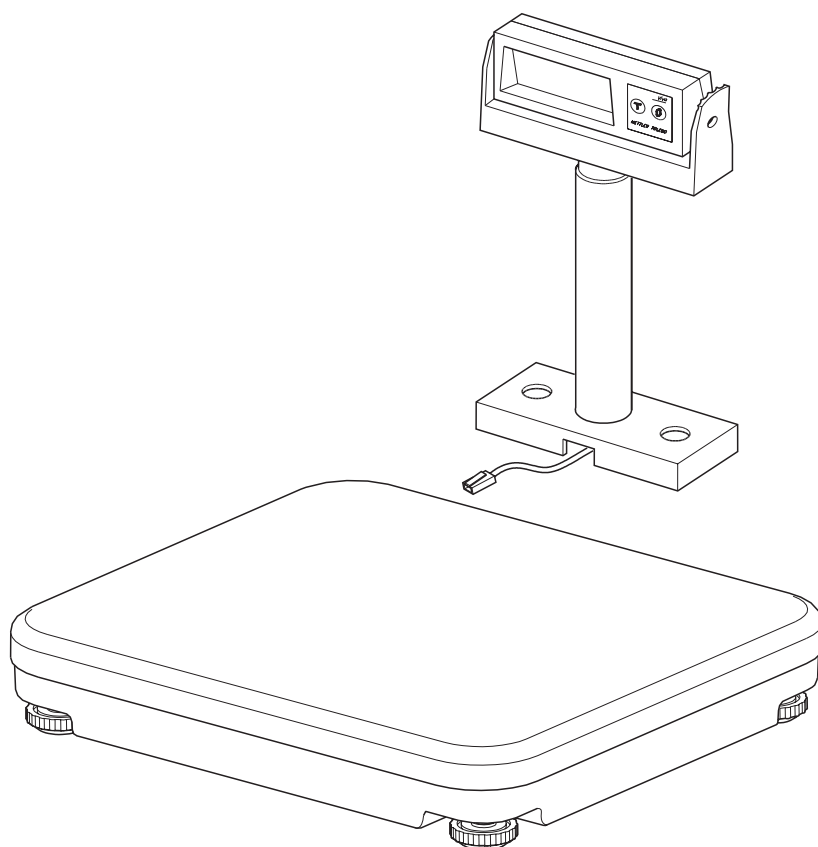

www.mt.com/xpress

About this manual and METTLER TOLEDO Xpress

Thank you for purchasing a METTLER TOLEDO Xpress product.

All of our equipment is assembled and packed with great care. If you should find any incorrect or missing item, please contact your METTLER TOLEDO Xpress dealer immediately.

The XRV Checkout Scale is a Weights & Measures approved precision weighing instrument. However, you may want to obtain official certification through your supplier or local Weights & Measures office.

This METTLER TOLEDO Xpress product was developed, produced, and tested in a METTLER TOLEDO facility that has been audited and registered according to international ISO 9001 quality standards and ISO 14000 environment control program. Properly used and maintained, this product will provide years of accurate weighing.

Handle it as you would do with any piece of fine electronic equipment. Please **read** this manual **before** operating or servicing this equipment. Follow the instructions carefully and save this manual for future reference. We at METTLER TOLEDO Xpress want to make sure you received the product you expected. It is important for us that you are satisfied with your purchase. If there is anything we can help you with, or if you are not satisfied with either your product or the services received from the METTLER TOLEDO Xpress representative, let us know.

How can you reach us?

Xpress Customer Care Center, USA

24/7 Information and Support www.mt.com/xpress
xpress@mt.com

8 AM to 8 PM EST Toll Free 1-866-MTXPRESS

Xpress
Mettler-Toledo, Inc.
1150 Dearborn Drive
Worthington, OH 43085

Contents		Page
1	Safety notice	5
2	Preparing your scale for use	6
2.1	Unpacking	6
2.2	Selecting or changing the location	6
2.3	Assembling	6
2.4	Power supply	8
2.5	Switching scale on and off	8
2.6	Sealing	9
3	The XRV scale at a glance	10
3.1	Display	10
3.2	Cursors	10
3.3	Keyboard	10
4	Operating your scale	11
4.1	Zeroing	11
4.2	Taring	11
4.3	Weighing	12
4.4	Remote commands	12
4.5	Backlight function	12
4.6	Cleaning	12
5	Setup mode	13
5.1	Operating the setup mode	13
5.2	Setup mode functions	13
6	Servicing your scale	15
6.1	Switching calibration switch to ON	15
6.2	Scale configuration service mode	16
6.3	Geo values	19
6.4	Calibration service mode	23
7	Communication protocols	25
7.1	8217 Mettler Toledo	25
7.2	Berkel	32
7.3	NCI Weightronix	34
7.4	Epelsa	38
7.5	CAS	40
7.6	ICL/Fujitsu	42

8	Appendix	44
8.1	Error messages	44
8.2	Technical data	45
8.3	Communication cable	47
8.4	ASCII table	47
8.5	FCC notice	48
8.6	Notes on Weights & Measures	48

1 Safety notice

- ▲ Read this manual before operating or servicing the scale. Save this manual for future reference.
- ▲ Do not allow untrained personnel to operate, clean, inspect, maintain, service or tamper with the scale.
- ▲ Observe safety warnings located throughout this manual.

**DANGER!**

Electric shock hazard!

- Always disconnect all power before commencing any work on the scale.

**CAUTION!**

The scale may only be opened by qualified personnel, otherwise the warranty is void.

- Exercise care when moving, testing or adjusting the scale.

**CAUTION!**

Handle the scale with care. It is a precision instrument.

- When the platform has been removed, never clean the area under the platform with a solid object!
- Do not put excessive loads on the scale.
- Avoid banging the platform.

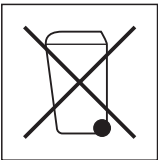
**Disposal**

- Observe the valid environmental regulations when disposing of the scale.
- Observe the local regulations for disposing of environmentally hazardous materials.

2 Preparing your scale for use

2.1 Unpacking

→ Ensure that all parts are accounted for:

Contents

- XRV scale base
- Platform
- AC-DC power adapter
- Display cables (a short and a long one)
- Tower and attachment equipment (the optional display may be packed separately)
- Base bracket (with round corner platform)
- Quick Start Guide
- Installation Instructions
- CD-ROM with Operation and Service Manual

2.2 Selecting or changing the location

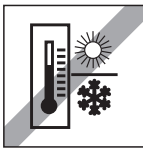
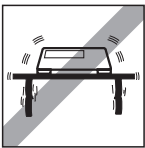

The correct location is crucial to the accuracy of the weighing results.

→ Select a stable, vibration-free and, if possible, a horizontal location.

The ground must be able to safely bear the weight of the fully loaded scale. Observe the following environmental conditions:

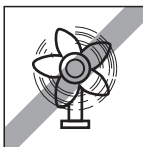
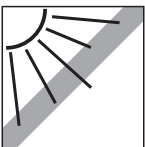

- No direct sunlight
- No strong drafts
- No excessive temperature fluctuations

2.3 Assembling

→ Open the box, carefully remove the packing material, and take all the items out of the carton.

→ Attach the display as described below.

Mounting options

There are two different options for mounting the display of the XRV scale.

→ Choose either the tower mount or the base mount display and follow the illustrations.

Tower mount display

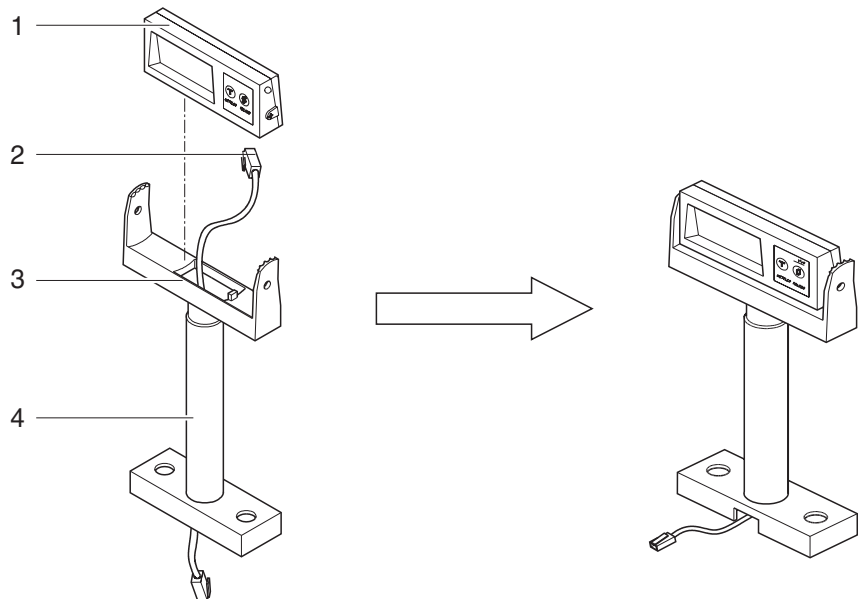

1. Connect the cable (2) to the display.
2. Put the display (1) on top of the display bracket (3) of the display tower (4).
3. Connect the other end of the tower display cable to the scale.
4. Put the platform on top of the XRV scale base.

Base mount display

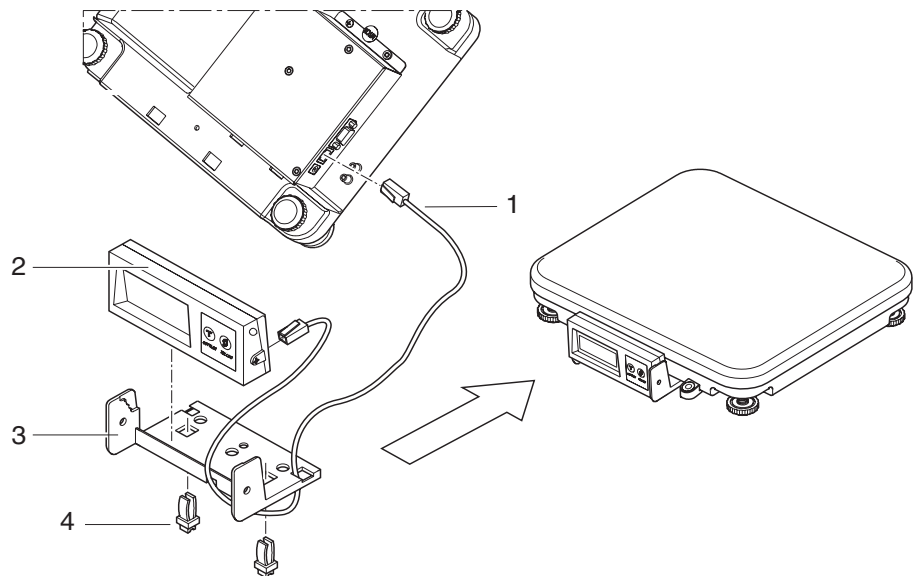

1. Lay the cable (1) through the cut-out of the display bracket (3).
2. Connect one end of the cable to the display (2) and the other end to the scale.
3. Put the display (2) on top of the display bracket (3).
4. Mount the display bracket on the scale with two clips (4).
5. Put the platform on top of the XRV scale base.

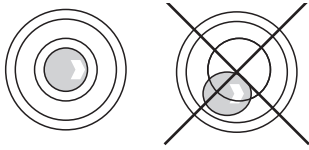

Aligning the scale

Only scales that have been aligned precisely horizontally provide accurate weighing results. The scales have a spirit level to simplify alignment.

→ Turn the adjustable feet of the scale until the spirit level’s air bubble is inside the inner circle.

Major geographical location changes

The manufacturer adjusts each scale to the local gravity conditions (Geo value). In the event of major geographical location changes, this setting must be readjusted. Certified scales must also be recertified observing the national certification regulations.

2.4 Power supply

The scale can be operated with the AC adapter provided.



CAUTION!

Damage to the scale.

→ Allow the scale to adjust to room temperature before connecting the power supply.

2.5 Switching scale on and off

2.5.1 Switching on

Prerequisite

Before switching on the scale always make sure that there is no weight on the platform.

→ Connect the scale to the power outlet using the external AC adapter provided.

The scale goes through a series of self-tests.

Power-up Sequence

- All segments of the display characters light up. This verifies the proper operation of all segments.
- The scale displays the country code, the Geo code, the software part number and the revision.
When the display shows 0 the scale is ready for operation.

Notes

- The scale should be running for about 15 minutes before operation.
- If the scale does not automatically zero upon power-up, ensure that the platform is properly aligned and/or recalibrate the scale, see page 21.

2.5.2 Switching off

→ Disconnect the scale from the power outlet.

2.6 Sealing

After installation is complete, most legal-for-trade applications require sealing the enclosure so settings cannot be changed. **Please contact your authorized METTLER TOLEDO Xpress dealer to seal your scale.**

There are 2 kinds of sealing: lead wire sealing and sticker sealing.

2.6.1 Lead wire sealing

1. Install 2 special through-hole sealing screws and tighten them.
2. Run a wire seal (1) through the holes in the heads of the screws.
3. Apply the seal.

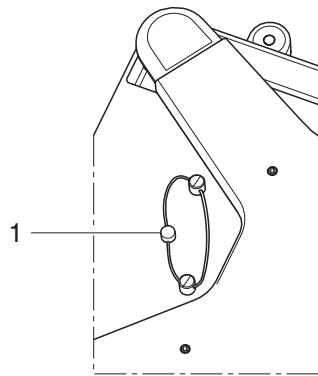

2.6.2 Sticker sealing

→ Apply the sealing stickers to the positions shown below

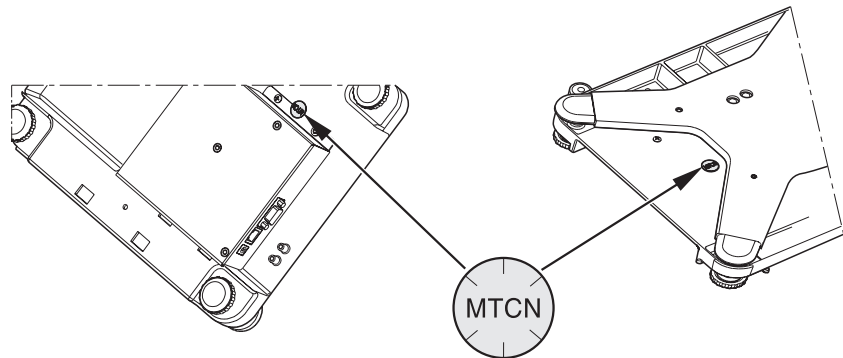

3 The XRV scale at a glance

3.1 Display



3.2 Cursors

Cursor	The cursor lights when...
Zero	the weight is gross zero
NET	tare exists

3.3 Keyboard

Key	Name	Function
	Zero key	Setting scale to gross zero
	Tare key	Taring the container weight

4 Operating your scale

4.1 Zeroing

For best weighing results set the empty scale to zero before weighing.

4.1.1 Zeroing when switching on

The scale is automatically set to zero when it is switched on.

The zero setting range is $\pm 10\%$ of the scale capacity.

If there is a weight on the scale more than $+10\%$ or less than -10% , the scale will not be set to zero and the weight display shows "-----".

→ Remove the weight and/or make sure that the platform is free.

The scale is zeroed.

4.1.2 Pushbutton zero

Setting to zero with  is only possible if:

- the displayed weight value is within $\pm 2\%$ of the scale capacity,
- the scale is in gross weighing mode, i.e. the NET cursor must be off,
- the scale is not in motion, i.e. the motion cursor must be off.

→ Press .

The weight display is set to zero.

4.2 Taring

Taring subtracts the weight of the container or wrapping material.

Pushbutton tare

1. Place the empty container or wrapping material on the platform.
2. Press .

The weight display is set to zero and the NET cursor is lit.

Remote tare

A remote tare command can be sent from a POS system through the serial connection of the XRV scale.

1. Place the empty container or wrapping material on the platform.
2. Wait until the display is set to zero before weighing.

Note

The pushbutton tare and the remote tare command do not work simultaneously.

4.3 Weighing

1. Place the item to be weighed on the platform.
The weight of the item is displayed.
2. Remove the item from the platform.
0 is shown.

4.4 Remote commands

Remote ASCII commands can control all functions including data transfer, zeroing and taring, depending on the protocol.

4.5 Backlight function

The scale is equipped with a backlight for the display when the light of the environment is not bright enough to read the display.

Enabling backlight function

- Press and hold  until a long beep is heard.

When the scale is not used for 1 minute, the backlight will automatically switch off. When a weight is placed on the platform or when a key is pressed, the backlight will switch on again.

Disabling backlight function

- Press and hold  until a long beep is heard.

2 more beeps will be heard to indicate the backlight has been switched off.

– or –

- Switch the scale off and on.

4.6 Cleaning



CAUTION!

Damage to the scale.

- Do not use any type of industrial solvents or chemicals.
- Do not attempt to remove the cover or to perform service or maintenance on the internal parts of the scale.

Cleaning

- Clean the keyboard and the display with a soft cloth that has been dampened with a mild window type cleaner or detergent.

5 Setup mode

In the setup mode you can modify parameters directly from the keyboard to suit your specific needs.

5.1 Operating the setup mode

5.1.1 Entering the setup mode

→ When switching on the scale, press and hold  until "grP 1" is displayed.

5.1.2 Keys and their function in the setup mode

 Confirm the choice and go to next step

 Step through the setup groups and select the parameter settings once a group is accepted

5.2 Setup mode functions

5.2.1 Setup parameters

The parameters of the setup mode are combined in groups. The groups and parameters are numbered.

No.	Function	Explanation
1.3	Beeper	ON Scale will beep when a key is pressed OFF No sound when a key is pressed
1.5	Decimal point	OFF Decimal point in all weight and price data, e.g. 3.54 ON Decimal comma in all weight and price data, e.g. 3,54
1.7	Automatic clearing of tare	ON Automatic clearing of tare weight when the weight is removed from the platform OFF Manual clearing of tare weight
2.4	Digital filter	The digital filter stabilizes the weight display when the load is moving or vibrating 0 Minimal filter 1 Low filter 2 Medium filter 3 High filter
3.1	Baud rate	0 1200 1 2400 2 4800 3 9600
3.2	Parity	0 None 1 Even 2 Odd

No.	Function	Explanation
3.3	Data	0 7 data bit 1 8 data bit
3.4	Bit stop	0 None 1 1 stop bit 2 2 stop bit
3.5	Choosing protocol	6 8217 Mettler Toledo refer to page 25 for customizing 7 Berkel refer to page 32 for further information 8 NCI Weightronix refer to page 34 for further information 9 Epelsa refer to page 38 for further information 10 CAS refer to page 40 for further information 11 ICL/Fujitsu refer to page 42 for further information Note When selecting the 8217 protocol, press  several times until "Save" appears
Save	Saving or aborting setting	Save Save all settings and return to weighing mode Abort Reject all changes and return to weighing mode

5.2.2 Country default settings

No.	Function	EN (USA)	DE (Germany)	FR (France)
1.3	Beeper	On	On	On
1.5	Decimal point	Off (.)	Off (.)	Off (.)
1.7	Automatic clearing of tare	On	On	On
2.4	Digital filter	1	1	1
3.1	Baud rate	3	3	3
3.2	Parity	1	2	1
3.3	Data	0	0	0
3.4	Bit stop	1	1	1
3.5	Choosing protocol	6	6	6

6 Servicing your scale



CAUTION!

The scale may only be serviced by qualified personnel, otherwise the warranty is void.

→ For the following services, please contact your METTLER TOLEDO Xpress dealer.

The scale has 2 different modes for service functions:

- Scale configuration service mode – to adjust the scale to each country's requirements
- Calibration service mode – to enter Geo value and to perform calibration

Notes

- These functions are directly related to the Weights & Measures regulations in each country. Therefore they are protected by the calibration switch, which is protected by a sealing sticker or sealing lead.
- Operation in the service mode is the same as in setup mode.



WARNING!

Damage to the scale or bodily harm!

→ Before connecting or disconnecting any internal electronic components or inter-connecting wiring between electronic equipment, always remove power and wait at least 30 seconds before any connections or disconnections are made.

6.1 Switching calibration switch to ON

1. Insert a thin rod through the calibration hole.
2. Press the switch on the main PCB.
3. Connect the scale to the power outlet.
The setup procedure is finished when GrP1 is displayed.
4. Press  to enter the service mode

6.2 Scale configuration service mode

6.2.1 Entering scale configuration service mode

→ With the calibration switch set to ON, press .

6.2.2 Scale configuration service mode functions

The parameters of the scale configuration service mode are numbered. Parameters in **bold** type are also accessible in the setup mode.

Step	Function	Settings / Explanation
1.1	Country selection	<p>With the country selection the following parameters are set automatically: Geo value, weight unit, zero cursor, chain tare, decimal point or decimal comma, baud rate, parity, data, bit stop, protocol.</p> <p>DE Germany FR France US United States AT Austria, Croatia, Slovenia ES Portugal, Spain BE Belgium, Netherlands, Great Britain, Poland IT Italy CH Kazachstan and Switzerland UA Ukraine RU Russia SK Slovakia HU Hungary SK Slovakia CZ Czechia Ejport Other countries CN China</p>
1.2	Resetting	<p>YES Reset scale configuration parameters to default settings. These settings meet the Weights & Measures requirements of the selected country. If other settings are made, the scale can no longer be used in commercial environments.</p> <p>NO Do not reset parameters</p>
1.3	Beeper	<p>ON Scale will beep when a key is pressed OFF No sound when a key is pressed</p>
1.4	Zero cursor	<p>ON Zero cursor enabled OFF Zero cursor disabled</p>
1.5	Decimal point	<p>OFF Decimal point in all weight and price data, e.g. 3.54 ON Decimal comma in all weight and price data, e.g. 3,54</p>
1.7	Automatic clearing of tare	<p>ON Automatic clearing of tare weight when the weight is removed from the platform OFF Manual clearing of tare weight</p>

Step	Function	Settings / Explanation
1.8	Weight unit	kg lb
1.9	Expanded weight display	ON Division quantity is displayed, maximum is 30,000 OFF Weight is displayed in normal display increments
2.1	Tare	ON Tare function enabled OFF Tare function disabled
2.2	Chain tare	ON Chain tare or multiple tares enabled OFF Only 1 tare per transaction allowed
2.4	Digital filter	The digital filter stabilizes the weight display when the load is moving or vibrating 0 Minimal filter 1 Low filter 2 Medium filter 3 High filter
2.5	Geo value	To adjust the scale to your geographical location Possible settings: 0 ...31 see page 19 and following for Geo value tables
2.6	Calibration	YES Calibrate scale, see page 23 No Do not enter calibration mode
3.1	Baud rate	0 1200 1 2400 2 4800 3 9600
3.2	Parity	0 None 1 Even 2 Odd
3.3	Data	0 7 data bits 1 8 data bits
3.4	Bit stop	0 None 1 1 stop bit 2 2 stop bits
3.5	Choosing protocol	6 8217 Mettler Toledo refer to page 25 for customizing 7 Berkel refer to page 32 for further information 8 NCI Weightronix refer to page 34 for further information 9 Epelsa refer to page 38 for further information 10 CAS refer to page 40 for further information 11 ICL/Fujitsu refer to page 42 for further information Note When selecting the 8217 protocol, press  several times until "Save" appears
Save	Saving or aborting setting	Save Save all settings and return to weighing mode Abort Reject all changes and return to weighing mode

6.2.3 Country default settings

No.	Function	DE (Germany)	FR (France)	EN (USA)
1.2	Reset	No	No	No
1.3	Beeper	On	On	On
1.4	Zero cursor	Off	Off	Off
1.5	Decimal point	On (,)	On (,)	Off (.)
1.6	Decimal places for price	N/A	N/A	N/A
1.7	Automatic clearing of tare	On	On	On
1.8	Weight unit	kg	kg	lb
1.9	Expanded weight display	Off	Off	Off
2.1	Tare	On	On	On
2.2	Chain tare	On	On	Off
2.3	Round total price	Off	Off	Off
2.4	Digital filter	1	1	1
2.5	Geo value	20	19	15
2.6	Calibration	No	No	No
3.1	Baud rate	3	3	3
3.2	Parity	2	1	1
3.3	Data	0	0	0
3.4	Bit stop	1	1	1
3.5	Choosing protocol	6	6	6

6.3 Geo values

6.3.1 GeoCal® country codes

Country	Geo value	Country	Geo value	Country	Geo value
Austria	18	Ireland	22	Romania	18
Belgium	21	Iceland	26	Russia	23
Bulgaria	16	Italy	17	Sweden	24* / 26
Croatia	18	Kazakhstan	18	Switzerland	18
Czechia	20	Latvia	23	Slovakia	19
Denmark	23	Luxemburg	20	Slovenia	18
Estonia	24	Liechtenstein	18	Spain	15
Finland	25* / 26	Lithuania	22	Turkey	16
France	17 / 19*	Netherlands	21	United Kingdom	21* / 23
Germany	20	Norway	24* / 26	Ukraine	21
Greece	15	Poland	21		
Hungary	19	Portugal	15		

* factory default

6.3.2 GeoCal® USA state locations codes

State	Geo value	State	Geo value	State	Geo value
Alabama Birmingham & North South of Birmingham	13	Kansas	14	North Dakota	18
	12	Kentucky	14	Ohio Akron & North South of Akron	16
		Lousiana	12		15
Alaska	See map	Maine	18	Oklahoma	13
Arizona Phoenix & North South of Phoenix	12	Maryland	15	Oregon Salem & North Between Oakridge & Salem South of Oakridge	18
	11	Massachusetts	17		17
Arkansas	13	Michigan Northwest of Lake Southeast of Lake	18 17		16
California	See map	Minnesota	18	Pennsylvania	16
Colorado Denver & North South of Denver	13	Mississippi Kosciusko & North South of Kosciusko	13 12	Rhode Island	16
	12			South Carolina	13
Connecticut	16	Missouri North of Springfield Springfield & South	15 14	South Dakota	17
Delaware	15			Tennessee	13
Florida West Palm Beach & North South of West Palm Beach	11			Montana Helena & North South of Helena	18 17
	10	Utah	13		
Georgia	12	Nebraska	15 13	Vermont	17
Hawaii	9			Virginia	14
Idaho North of Salmon River Mtns South of Salmon River Mtns	17			Nevada	13
	16	New Hampshire	17	Washington State	18
Illinois Bloomington & North South of Bloomington	16	New Jersey	16	West Virginia	15
	15	New Mexico	11	Wisconsin Green Bay & North South of Green Bay	18 17
Indiana North of Indianapolis Indianapolis & South	16	New York Albany & North South of Albany	17 16		Wyoming North of Casper Casper & South
	15		North Carolina Raleigh & North South of Raleigh	14 13	
Iowa North of Des Moines Des Moines & South	17				
	16				

6.3.3 Maps for residents of Alaska and California

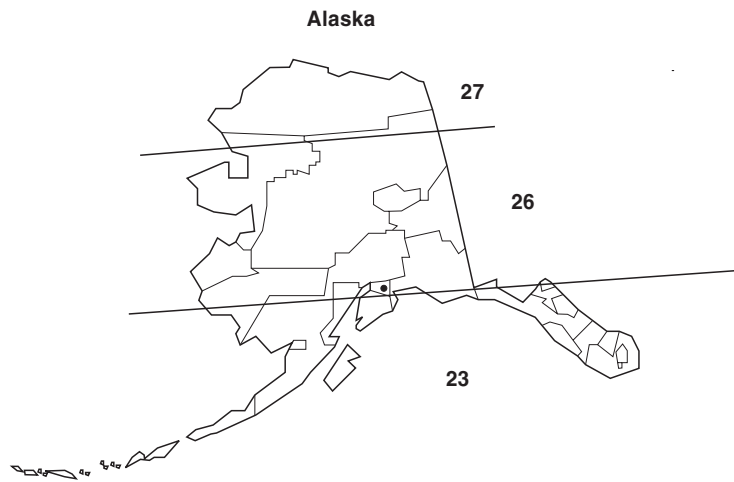

Note
Locations near a boundary may enter either code.

6.3.4 Global Geo value table

Note

Geo values on this chart are accurate up to an altitude of 2000 m.













Northern and southern latitude in degrees and minutes	Height above sea-level in meters										
	0 325	325 650	650 975	975 1300	1300 1625	1625 1950	1950 2275	2275 2600	2600 2925	2925 3250	3250 3575
	Height above sea-level in feet										
	0 1060	1060 2130	2130 3200	3200 4260	4260 5330	5330 6400	6400 7460	7460 8530	8530 9600	9600 10660	10660 11730
0° 0' – 5° 46'	5	4	4	3	3	2	2	1	1	0	0
5° 46' – 9° 52'	5	5	4	4	3	3	2	2	1	1	0
9° 52' – 12° 44'	6	5	5	4	4	3	3	2	2	1	1
12° 44' – 15° 6'	6	6	5	5	4	4	3	3	2	2	1
15° 6' – 17° 10'	7	6	6	5	5	4	4	3	3	2	2
17° 10' – 19° 2'	7	7	6	6	5	5	4	4	3	3	2
19° 2' – 20° 45'	8	7	7	6	6	5	5	4	4	3	3
20° 45' – 22° 22'	8	8	7	7	6	6	5	5	4	4	3
22° 22' – 23° 54'	9	8	8	7	7	6	6	5	5	4	4
23° 54' – 25° 21'	9	9	8	8	7	7	6	6	5	5	4
25° 21' – 26° 45'	10	9	9	8	8	7	7	6	6	5	5
26° 45' – 28° 6'	10	10	9	9	8	8	7	7	6	6	5
28° 6' – 29° 25'	11	10	10	9	9	8	8	7	7	6	6
29° 25' – 30° 41'	11	11	10	10	9	9	8	8	7	7	6
30° 41' – 31° 56'	12	11	11	10	10	9	9	8	8	7	7
31° 56' – 33° 9'	12	12	11	11	10	10	9	9	8	8	7
33° 9' – 34° 21'	13	12	12	11	11	10	10	9	9	8	8
34° 21' – 35° 31'	13	13	12	12	11	11	10	10	9	9	8
35° 31' – 36° 41'	14	13	13	12	12	11	11	10	10	9	9
36° 41' – 37° 50'	14	14	13	13	12	12	11	11	10	10	9
37° 50' – 38° 58'	15	14	14	13	13	12	12	11	11	10	10
38° 58' – 40° 5'	15	15	14	14	13	13	12	12	11	11	10
40° 5' – 41° 12'	16	15	15	14	14	13	13	12	12	11	11
41° 12' – 42° 19'	16	16	15	15	14	14	13	13	12	12	11
42° 19' – 43° 26'	17	16	16	15	15	14	14	13	13	12	12
43° 26' – 44° 32'	17	17	16	16	15	15	14	14	13	13	12
44° 32' – 45° 38'	18	17	17	16	16	15	15	14	14	13	13
45° 38' – 46° 45'	18	18	17	17	16	16	15	15	14	14	13
46° 45' – 47° 51'	19	18	18	17	17	16	16	15	15	14	14
47° 51' – 48° 58'	19	19	18	18	17	17	16	16	15	15	14
48° 58' – 50° 6'	20	19	19	18	18	17	17	16	16	15	15
50° 6' – 51° 13'	20	20	19	19	18	18	17	17	16	16	15
51° 13' – 52° 22'	21	20	20	19	19	18	18	17	17	16	16
52° 22' – 53° 31'	21	21	20	20	19	19	18	18	17	17	16
53° 31' – 54° 41'	22	21	21	20	20	19	19	18	18	17	17
54° 41' – 55° 52'	22	22	21	21	20	20	19	19	18	18	17
55° 52' – 57° 4'	23	22	22	21	21	20	20	19	19	18	18
57° 4' – 58° 17'	23	23	22	22	21	21	20	20	19	19	18
58° 17' – 59° 32'	24	23	23	22	22	21	21	20	20	19	19
59° 32' – 60° 49'	24	24	23	23	22	22	21	21	20	20	19
60° 49' – 62° 9'	25	24	24	23	23	22	22	21	21	20	20
62° 9' – 63° 30'	25	25	24	24	23	23	22	22	21	21	20
63° 30' – 64° 55'	26	25	25	24	24	23	23	22	22	21	21
64° 55' – 66° 24'	26	26	25	25	24	24	23	23	22	22	21
66° 24' – 67° 57'	27	26	26	25	25	24	24	23	23	22	22
67° 57' – 69° 35'	27	27	26	26	25	25	24	24	23	23	22
69° 35' – 71° 21'	28	27	27	26	26	25	25	24	24	23	23
71° 21' – 73° 16'	28	28	27	27	26	26	25	25	24	24	23
73° 16' – 75° 24'	29	28	28	27	27	26	26	25	25	24	24
75° 24' – 77° 52'	29	29	28	28	27	27	26	26	25	25	24
77° 52' – 80° 56'	30	29	29	28	28	27	27	26	26	25	25
80° 56' – 85° 45'	30	30	29	29	28	28	27	27	26	26	25
85° 45' – 90° 00'	31	30	30	29	29	28	28	27	27	26	26

6.4 Calibration service mode

6.4.1 Entering calibration service mode

- With the calibration switch set to ON, press . YES is shown in the weight display.

6.4.2 Calibration procedure

Display	Press key	Description
YES		Confirm calibration mode
CAL, then kg – or – lb		Select kg – or – lb
kg – or – lb		Confirm selection
CAP, then number		Select weight capacity, e.g. CAP 6 for 6 kg
Number		Confirm calibration
----		Make sure that the platform is empty
		Confirm that the platform is empty
5 ... 0		Zero reading is being taken If motion is detected, the count resets to 5 and resumes counting until a stable weight value is found
2/3 load value		Select calibration value
Number		Confirm calibration value
		Load the appropriate test weight
		Confirm the appropriate test weight
5 ... 0		If motion is detected, the count resets to 5 and resumes counting until a stable weight value is found
GrP 3		Confirm calibration
SAVE		SAVE – or – ABORT selection
		Confirm selection and leave calibration service mode
		Verify calibration in normal weighing mode If applicable, remove power from scale and apply appropriate calibration seal

Calibration quick reference guide

1. Break the calibration seal.
2. Press the calibration button on the main PCB.
3. Select YES.
4. Select kg or lb.
5. Select the capacity.
6. Make sure that the platform is empty and take the zero reading.
7. Place desired weight on scale and take the reading.
8. Save the settings and verify calibration in normal weighing mode.

7 Communication protocols

7.1 8217 Mettler Toledo

7.1.1 Host communications

The 8217 scale acts as a peripheral device when connected to a host computer. When the host requests weight data by sending an uppercase **W**, the scale will respond with the weight data or a status byte if the scale is in motion or an invalid state. The host can also request a scale zero operation. In this case the scale will respond with the scale status, so the host can determine if the scale is in zeroing range and/or if the scale is at zero. A scale confidence test can also be initiated by the host to cause the scale to perform RAM, ROM, and NOVRAM tests and put the results in a status byte for later interrogation by the host.

Data is transmitted and received by the scale using an RS-232 voltage level interface in the following ASCII format: 7 bit even parity and one stop bit. Data transmission rates are 1200, 2400, 9600, or 19200 baud asynchronous. The host computer must send requests to the scale as specified single uppercase ASCII characters to have it perform various functions. The scale will send a response back to the host computer as a string of ASCII numeric digits or as an ASCII **?** followed by a status byte. There must be at least a 200 ms delay between commands to allow for response time at the scale for processing data.

The following table shows the standard commands and responses between the scale and the host. If a confidence test results in an error, the scale will not respond to the **W** or **Z** commands until the error condition is corrected. An error will also cause the scale to halt any weighing operation until cleared.

7.1.2 Command descriptions

ASCII Command from Host	Scale response	Description
W	STX WW.WW ^{c_R} STX WW.WWW ^{c_R} STX WW.WWN ^{c_R} STX WW.WWWN ^{c_R} STX?status byte ^{c_R}	Instructs scale to send weight data (W=Weight Digit 0-9). SW1-1 in setup mode determines whether the decimal point is transmitted or not. The scale will respond as follows according to setup and status: Gross Weight Pounds. Gross Weight KG. Net Weight Pounds. ASCII N added after weight. Net Weight KG. ASCII N added after weight. Status byte is sent if scale is in motion, or if net/gross weight is negative or over capacity. See page 27 to determine status byte results.
Z	STX?status byte ^{c_R}	Zero scale command. On the next A/D reading, zero will be captured if the weight is stable, within capture range, and no tare is taken (gross weight mode.)
T ^{c_R}	STX?status byte ^{c_R}	Tare item on platform command. The scale must be at gross zero before placing the item on the platform. Tare will be taken if weight is stable and non-zero. After 150 ms delay, the scale will respond with a status byte. Note Tare must be enabled in calibration mode or scale will not respond.
TWWWWW ^{c_R}	STX?status byte ^{c_R}	Digital Tare Command. Known tare value can be sent to scale and must be transmitted as five digits. The scale assumes a decimal point of WWW.WW LB, or WW.WWW KG. Note Tare must be enabled in calibration mode or scale will not respond.)
C	STX?status byte ^{c_R}	Clear Tare Command (ignored if weight is not stable.) Scale status byte is sent after 150 ms delay.
A	STX ^{c_R}	Initiate Confidence Test Command. STX ^{c_R} is sent indicating command was received.
B	STX?status byte ^{c_R}	Send Confidence Test Results Command. A must be sent prior to the Send Result command B . Results of the test are contained in a status byte. See page 27 to determine the scale confidence test byte bit definitions. If all tests have passed, the ASCII @ character will be returned.
E	STXE ^{c_R}	Start Echo Mode Serial Port Test Command. Scale will respond with an E indicating command received. Characters except F will be echoed back to the host.
F	STXF	End Echo Mode Command. The scale will respond with an ASCII F indicating the command was received.

Note

ASCII commands must be uppercase characters only.

7.1.3 Scale Status Byte Bit Definitions

When the scale responds with STX?status byte^{C_R}, this indicates a status byte. The status byte contains scale status information, which can include net/gross mode, zero status, etc.

The actual status byte sent will be an ASCII character which must be converted to binary to decode the bits. The scale status bit definitions are shown in the following table.

Bit number	Bit description
7	7 Parity bit (even)
6	1 = Bad command from host 0 = Normal
5	1 = Net weight 0 = Gross weight
4	1 = Center of zero 0 = Not at center of zero
3	1 = Outside zero capture range 0 = Within range
2	1 = Under zero 0 = Within weighing range
1	1 = Over capacity 0 = Within weighing range
0	1 = Scale in motion 0 = Stable weight data

7.1.4 Scale Confidence Test Byte Bit definitions

When the scale responds with STX? status byte^{C_R} after requesting a confidence test (B), a confidence test status byte will be sent. The status byte contains scale status information, which can include net/gross mode, zero status, etc. The actual status byte sent will be an ASCII character which must be converted to binary to decode the bits. The confidence test status bits are shown in the following table. Bit 6 is set to 1 after a confidence test is performed and reset to 0 after the host reads the confidence test status byte.

Note

The ASCII @ (decimal 64) indicates all tests were passed. Repeated reads of the confidence byte for all test passed without initiating a new confidence test will result in an ASCII NULL (hex 00).

Bit number	Bit description
7	Parity bit (even)
6	1 = New status data available 0 = Host has read data
5	Bit is always a 0
4	1 = ROM test failed 0 = ROM test passed
3	1 = Processor RAM test failed 0 = Processor RAM test passed
2	1 = RAM test passed 0 = RAM test failed
1	1 = NOVRAM test failed 0 = NOVRAM test passed
0	Always 0

7.1.5 Taring

The tare of an item can be taken either automatically or digitally.

Remote tare The unknown weight of an object can be tared off automatically:

Prerequisite

The display is not in motion and the weight is above zero.

1. Place the object on the platform.
2. The host sends an uppercase ASCII **T** followed by C_R .

The weight is subtracted.

The tare function must be enabled. Chain tare is not permitted. A display triangle, located under the least significant weight digit on the scale display, will illuminate to indicate net weight is displayed. An underload will cause dashes to be displayed and a status byte will be sent to the host instead of the weight data.

Digital tare The keyboard tare is set when an uppercase ASCII **T**, followed by five ASCII digits and a C_R is sent to the scale. The scale weight display must be positive and stable. The tare value input is limited to the scale capacity. In metric mode, the tare value must always end in 0 or 5.

Clearing tare If auto tare clear is enabled, tare is automatically cleared whenever the scale returns to gross zero after having indicated a stable net weight at least one increment above net zero. If auto tare clear is disabled, tare can be cleared by sending an uppercase ASCII **C**.

7.1.6 I/O connector wiring

The 8217 provides a female, DB-9 connector for connecting to a host computer. The serial port wiring is shown in the table below.

8217 serial interface connector DB9-F

Pin#	Function	Description
2	RxD	Receiving Data
3	TxD	Transmitting Data
5	SGnd	Signal Ground

→ Verify the pin configuration on the host serial connector, since certain computers may not use the standard pin locations.

A shielded 20 gauge, stranded cable is recommended. The maximum recommended RS-232 cable length is 50 ft. (15 m). If cable lengths greater than 50 ft. (15 m) are required, consult your local METTLER TOLEDO Xpress representative.

Note

Do not connect the DTR line unless the software specifically controls the line. The DTR line on the scale does not require connection in order to use the interface. Certain programs such as dBASE@ and FOXPRO@ may require the PC's handshaking lines to be jumpered as follows:

Handshaking

PC DB25 serial port connector:
Jumper 4 to 5, and 6, 8 & 20 together

PC DB9 serial port connector:
Jumper 4 to 6, and 7 to 8 together



Standard PC connectors

Standard PC compatible computers use either a female DB-25 or a female DB-9 connector for RS-232 serial ports. Cables to PC compatible computers are available from your local authorized METTLER TOLEDO Xpress representative.

DB25-F RS-232		XRV DB9-M	
Pin#	Function	Pin#	Function
2	Transmitting	2	Receiving
3	Receiving	3	Transmitting
7	Signal Ground	5	Signal Ground
4	RTS		
5	CTS		

PC DB9-F RS-232		XRV DB9-M	
Pin#	Function	Pin#	Function
2	Receiving	3	Transmitting
3	Transmitting	2	Receiving
5	Signal Ground	5	Signal Ground
7	RTS		
8	CTS		

7.1.7 Flexible import and export command

1. Select 6 in step 3 of group 3.
2. Press .
3. Select YES to reset the protocol to default 8217 protocol
- or-
4. Select NO to leave the protocol as it is.
If NO is selected you can edit the import and export command as described below. NO is the default setting.
5. If 8217 is required, press  until SAVE is displayed.
6. If you want to change the command or data format, select NO and follow the procedures below.
7. Set the command from the ECR to the scale, then set the command from the scale to the ECR.

One command contains up to 6 parameters and must only contain 2 digits (0-F). Characters use the ASCII table, see Appendix

ECR to scale

Parameter	Command	Description
P	STX	
Q	ETX	
R	CR	
L	LF	
T		Stops editing process
0-F	HEX	Two HEX stand for one character*

*The priority of this character is the highest one. If another command uses the same character, this command will be disabled. The characters Z, T, C, A, B, E and F are used in the existing 8217 protocol and should not be used for other commands.

Scale to ECR









Parameter	Command	Description
P	STX	
Q	ETX	
R	CR	
L	LF	
E	WW.WWW	
F	WW.WW	
T		Stops editing process

Example

	Command	Parameters
ECR to scale	STX W ETX CR LF	p57qrL
Scale to ECR	STX WW.WWW ETX CR LF	pEqrL

7.1.8 Setting commands between ECR and scale

1. Select 6 in step 3 of group 3.
2. Set the commands between ECR and scale using the following steps.

Display	Key operation	Remark
3.6 d	Press  to select	d = default, y = 8217 protocol
3.6 d	Press  to accept	d = default, n = enable edit command and data format
3.6 C 0	Press  until desired digit is displayed	CO is the first digit of the command
3.6 C 0	Press  to accept	P is the first digit of the command p57qrL Repeat the steps until all digits of the command are entered.
p57qrL	Press  to accept and save setting	Show the command parameter p57qrL
3.6 r 0	Press  to select	Begin to set data format from scale to ECR
3.6 r 0	Press  to accept	Proceed as described above until all digits of the command pEqrL are entered
pEqrL	Press  to accept	Show the command parameter pEqrL
SAVE	Press  to accept	Save all settings and go to normal weighing mode

7.2 Berkel

7.2.1 Data format

- 9600 Baud (select 2400, 4800 or 9600)
- Even parity (select Even, None or Odd parity)
- 7 data bits (select 7 or 8)
- 1 stop bit (select 1 or 2 stop bits)

7.2.2 Command descriptions

ECR	Time out	Scale	Comments
STX (02h)	250 ms	ACK (06h)	ECR sends STX. Scale answers ACK. If there is no answer, ACR can be sent 15 times. Error if more than 15 retransmissions are sent. Time out between STX and ACK is 250 ms. Error if no response is sent after 250 ms.
	3.2 ms		
4 (34h) 0 (30h) CR (0Dh) LF (0Ah)	680-5400 ms	STX (02h)	ECR sends request for weight from scale if no notion. 3.2 ms delay before each character. STX is sent again if NAK is received. Error if another character is received. Error if another character is received. Scale answers STX. Time out between LF and STX is 680-5400 ms.
ACK (06h)	680-5400 ms	W4 (30h to 39h) W3 " " W2 " " W2 " " W1 " " W0 " " CR (0Dh) LF (0Ah)	ECR sends ACK. Scale sends weight in gram. Time out between ACK and first digit of weight is 680-5400 ms.
			Time out between each character is 250 ms. Error if the 7th character is not LF. Scale sends NAK if it is unloaded, in motion or if the weight has not changed since the previous retransmission.
STX (02h)	250 ms	ACK (06h)	Error if there is no response after 250 ms. If no ACK is received, STX is sent again. Error if more than 15 transmissions are sent incl. previous ones.

ECR	Time out	Scale	Comments
	3.2 ms		
5 (34h) 0 (30h) CR (0Dh) LF (0Ah)	680-5400 ms	STX (02h)	ECR sends request for price. 3.2 ms delay before each character. STX is sent again if NAK is received. Error if another character is received. Error if no STX is received after 6 s (minus 0.4 s for every previous retransmission). Error if another character than STX or digit is received. If a digit is received, no ACK is sent and P5 is assumed.
ACK (06h)	680-5400 ms	P5 (30h to 39h) P4 " " P3 " " P2 " " P2" " P1 " " CR (0Dh) LF (0Ah)	Scale sends total price to ECR. P5 is most significant digit. Error if more than 6 s (minus 0.4 s for every previous retransmission) pass before P5 is received. Error if the time between the other characters is more than 250 ms. Error if the 7th character is not CR.
			Time out between each character is 250 ms. Error if the 7th character is not LF. Scale sends NAK if it is unloaded, in motion or if the weight has not changed since the previous retransmission.

7.3 NCI Weightronix

7.3.1 General information

The serial communications protocol is used to interface Weigh-Tronix/NCI POS (Point-of-Sale) scales to ECR (Electronic Cash Registers), or other computing equipment (e.g. personal computers).

Responses to serial commands will be immediate, or within one weight meter cycle of the scale. The time-out value used by the remote (controlling) device should be 1 second.

- There are two types of serial commands: **mandatory** and **optional**. Mandatory commands must be supported by all products.
- Status bytes are prefaced by the letter **S**.
- Units of measure abbreviations are always upper case.
- The weight is always positive, therefore there is no polarity byte.

The following symbols are used:

- <ETX> End of Text character (03 hexadecimal)
- <LF> Line Feed character (0A hex)
- <CR> Carriage Return character (0D hex)
- <SP> Space (20 hex)
- x Weight characters from display including minus sign and out-of-range characters
- hh Two status bytes
- UU Units of measure (LB, KG, OZ, G, etc., all upper case)

7.3.2 Data format

- 1200, 2400, 4800, 9600, and 19200 Baud, adjustable
- 7 data bits
- Parity, adjustable
- 1 stop bit
- 1 start bit

7.3.3 Mandatory commands

Name	Command	Response
Request weight	W<CR>	Returns decimal weight, units and status. <LF>xx.xxxUU<CR><LF>Shh<CR><ETX> Returns lb-oz weight with units plus scale status. <LF>xLB<SP>xx.xOZ<CR><LF>Shh<CR><ETX> Scale status only if wt < 0, initial zero error, in motion or out of capacity. <LF>Shh<CR><ETX> Note The weight field is always six characters (5 for weight, 1 for decimal point), regardless of the display size. Leading zeroes are not suppressed.
Request status	S<CR>	Returns scale status. <LF>Shh<CR><ETX>
Zero the scale	Z<CR>	Scale is zeroed, returns scale status (see note 4). <LF>Shh<CR><ETX> Note If the scale is outside zero range or in motion, the Z command is ignored and the scale status is returned without zero status flag set, i.e., the scale is not at zero.

7.3.4 Optional commands

Name	Command	Response
Request high-resolution weight	H<CR>	Returns decimal wt in 10x with units plus scale status. <LF>xxx.xxxUU<CR><LF>Shh<CR><ETX> Returns lb-oz wt in 10x with units plus scale status. <LF>xLB<SP>xx.xxOZ<CR><LF>Shh<CR><ETX> Scale status only if wt < 0, initial zero error, in motion or out of capacity. <LF>Shh<CR><ETX> Note The high resolution weight field is seven characters (6 for weight, 1 for decimal point), regardless of display size. Leading zeroes are not suppressed.
Change units of measure	U<CR>	Changes units of measure, returns new units and scale status. <LF>uu<CR><LF>Shh<CR><ETX>
Request metrology raw counts	M<CR>	Returns normalized raw counts and scale status. <LF>xxxxxxMM<CR><LF>Shh<CR><ETX>
Unrecognized command	all others	Unrecognized command <LF>?<CR><ETX>

7.3.5 Command description

- Weight Command: W** This command causes the scale to return the displayed weight string in ECR format. The scale will usually return the displayed weight with leading zeroes, i.e. no leading zero suppression. If the weight is negative, in motion, over capacity or under capacity, or if a zero error exists, the ECR protocol causes only the scale's status to be returned in response to a weight (**W**) command. The returned weight string will include decimal point plus units of measure. The length of the weight field will be equal to the length of the scale's display plus three (one for the decimal point, and two for the units, e.g., "LB"). For pounds-ounce weight, the length of the weight field will be equal to the length of the scale's display plus five (one for the decimal point, two for the "LB" and two for the "OZ"). Units of measure will appear in their ANSI standard abbreviated form ("LB" for pounds, "KG" for kilograms, etc.) in uppercase characters.
- Zero Command: Z** If zeroing criteria are met, the scale is zeroed. In any case, scale status is returned.
- High-Resolution Command: H** This is the same as the **W** command, except that the weight is returned with ten times the scale's displayed resolution.
- Change Units Command: U** This command causes the scale to change its units of measure. In response, the scale will return the new units of measure and the scale status.
- Metro Command: M** This command is optional. It will cause the scale to return the normalized raw counts used for metrology verification. The count value is the same number which is displayed in the scale's division test in its diagnostics mode. For example, this number can range up to 120,000 for the 67xx, 100,000 for the 78xx and 1,000,000 for QDT scales.
- Scale Status Command: S** There will be at least two status bytes. If bit 6 of the second status byte is set, there will be a third byte. Bit 6 of each successive byte indicates whether another status byte follows. The bit will be clear (0) in the last status byte. At this time only the first three bytes are defined. Others may be added later. Bit 0 is the least significant bit in the byte while bit 7 is the most significant bit.

7.3.6 Definition of status bits

Bit	Status Byte 1	Status Byte 2	Status Byte 3 (opt)
0	1 = scale in motion 0 = stable	1 = under capacity 0 = not under capacity	00 = low range 01 = undefined 10 = undefined
1	1 = scale at zero 0 = not at zero	1 = over capacity 0 = not over capacity	11 = high range
2	1 = RAM error 0 = RAM okay	1 = ROM error 0 = ROM okay	1 = net weight 0 = gross weight
3	1 = EEPROM error 0 = EEPROM okay	1 = faulty calibration 0 = calibration okay	Initial zero error
4	Always 1	Always 1	Always 1
5	Always 1	Always 1	Always 1
6	Always 0	1 = byte follows 0 = last byte	1 = byte follows 0 = last byte
7	Parity	Parity	Parity

7.4 Epelsa

7.4.1 Data format

2400 Baud, adjustable
 7 data bits, adjustable
 Even parity, adjustable
 2 stop bits
 1 start bit
 Asynchronous transmission
 Data in ASCII code

7.4.2 Command descriptions

The functions of the protocol are implemented by using a single character for each command.

ASCII character	Decimal	HEX	Function	Comments
#	35	23	Resetting scale	The reset command can be sent at any moment. This function cancels the cyclic test status. When the scale is stable and at 0, it will send "0000000<CR>"
\$	36	24	Demand weight	External weight demand
%	37	25	Zeroing	When the scale answers "AAAAAA<CR>" it is out of range or not in weighing mode. After sending this character when the scale has recovered a centered zero, the "O"s string is sent. If the scale is not in weighing mode or if the zero is not centered, the "A"s string is sent. Waiting time between transmission and reception must be less than 10 seconds, otherwise more "\$" characters will be sent until the scale sends back the "O"s string.
&	38	26	Opening cash drawer	No response from the scale
'	39	27	Activating beep	Turned off by default. Sending this character activates the beeper. The beeper stays ON until the command is sent again.

The scale always responds with an ASCII 8 byte string, consisting of 7 data bytes + 1 "carriage return" byte (13 Decimal = 0D HEX).

Scale response	Comments
<Data><CR> <xxx.xxx><CR>	7 bytes of data + 1 byte "CR" (13 decimal, OD hex)
Example: 001.000<CR>	Weight reading, meaning 001.000 kg
Example: 0000000 <CR>	Weight is zero
AAAAAAA<CR>	Weight out of range, scale in motion, scale in initial test, or no response between 2 consecutive demands ["\$"]
TTTTTT<CR>	<p>Scale is in a cyclic test.</p> <p>The scale enters the cyclic test after it is switched on. The display goes through 99999 and sends a string of "T"s indicating the scale is in the cyclic test status.</p> <p>To exit this status, send two consecutive "#" characters with 1s interval.</p> <p>When the scale recovers the zero weight, it will send a "0"s string. The response time of the scale is aprox. 25 s.</p>

7.5 CAS

7.5.1 Data format

- 9600 Baud (select 2400, 4800 or 9600)
- Even parity (select Even, None or Odd parity)
- 7 data bits (select 7 or 8)
- 1 stop bit (select 1 or 2 stop bits)

7.5.2 Handshaking

PC DB25 serial port connector:
Jumper 4 to 5, and 6, 8 & 20 together

PC DB9 serial port connector:
Jumper 4 to 6, and 7 to 8 together

7.5.3 Command descriptions

Command	Comments
ENQ (05h)	Starts the communication sequence
ACK (06h)	Data available
NAK (15h)	No acknowledgement
DC1 (11h)	Data request format 1: weight only
DC2 (12h)	Data request format 2: total price, weight and unit price
STX (02h)	Start of text
STA	Status: S – stable, U – unstable
Sign	Space (20h) – zero or positive - (2dh) – negative F (46h) – overflow
Weight	6 bytes with MSD first and including decimal: W4W3.W2W1W0
Weight units	2 bytes for weight units (i.e. kg) following weight data
Price	8 bytes with MSD first and including decimal: P6P5P4P3P2.P1P0 Spaces are used for leading non-significant digits, i.e. a price of 15.00 would be transmitted as " 15.00" with 4 leading spaces
Unit price	8 bytes with MSD first and including decimal: U6U5U4U3U2.U1U0 Spaces are used for leading non-significant digits, i.e. a price of 15.00 would be transmitted as " 15.00" with 4 leading spaces
BCC	Block Check Character calculated as the even column parity (Longitudinal Redundancy Check) of all characters except the STX and ETX.
ETX (03h)	End of text
EOT (04h)	End of transmission

7.5.4 Command flow

Format 1

ECR	Scale	Comments	Possible errors
ENQ (05h)			
	ACK (06h)	Data available	NAK - no acknowledgement
DC1 (11h)		Data request	NAK - no acknowledgement
	SOH STX STA SIGN W4W3.W2W1W0 kg BCC ETX EOT	Transmitted data	

Format 2

ECR	Scale	Comments	Possible errors
ENQ (05h)			
	ACK (06h)	Data available	NAK - no acknowledgement
DC2 (11h)		Data request	NAK - no acknowledgement
	SOH STX P6P5P4P3P2.P1P0 BCC ETX STX STA SIGN W4W3.W2W1W0 kg BCC ETX STX U6U5U4U3U2.U1U0 BCC ETX EOT	Transmitted data	

Note

Spaces depicted in the descriptions above are only used for ease of reading.

7.6 ICL/Fujitsu

7.6.1 Data format

- 9600 Baud (select 2400, 4800, 9600)
- 7 data bits (select 7 or 8)
- Even parity (select Even, None or Odd parity)
- 1 stop bit (select 1 or 2 stop bit)

7.6.2 Handshaking

PC DB25 serial port connector:
 Jumper 4 to 5, and 6, 8 & 20 together

PC DB9 serial port connector:
 Jumper 4 to 6, and 7 to 8 together

7.6.3 Command descriptions

Command	Comments																				
ENQ (05h)	Starts the communication sequence																				
ACK (06h)	Data available																				
CAN (18h)	Repeat weighing																				
NAK (15h)	No acknowledgement																				
NUL (00h)	No data available																				
DC1 (11h)	Data request																				
STX (02h)	Start of text																				
ID	Information byte, broken into the following bits <table border="1" style="margin-left: 20px;"> <thead> <tr> <th colspan="3">Bit</th> <th>Capacity</th> </tr> <tr> <th>2</th> <th>1</th> <th>0</th> <th></th> </tr> </thead> <tbody> <tr> <td>0</td> <td>0</td> <td>1</td> <td>15 kg x 0.005 kg</td> </tr> <tr> <td>0</td> <td>1</td> <td>0</td> <td>30 lb x 0.01 kg</td> </tr> <tr> <td>0</td> <td>1</td> <td>1</td> <td>6 kg x 0.002 kg</td> </tr> </tbody> </table> <p>Bit 3 - Logic 1 Bit 4 - Logic 1 means under/over range Bit 5 - Logic 1 Bit 6 - Logic 1 indicates non-AVR capacities</p>	Bit			Capacity	2	1	0		0	0	1	15 kg x 0.005 kg	0	1	0	30 lb x 0.01 kg	0	1	1	6 kg x 0.002 kg
Bit			Capacity																		
2	1	0																			
0	0	1	15 kg x 0.005 kg																		
0	1	0	30 lb x 0.01 kg																		
0	1	1	6 kg x 0.002 kg																		
Weight	5 bytes with MSD first. If the scale registers underweight or overweight, a data string with data of zero (00) will be transmitted with bit 4 (X) of the ID bit set to 1. In cases where MSD or LSD are not required, a "Nul" character will be transmitted in the unused position.																				

Command	Comments
BCC	Block Check Character calculated as the even column parity (Longitudinal Redundancy Check) of all characters except the STX and ETX.
ETX (03h)	End of text
CR (0dh)	Data received and compared correctly

7.6.4 Command flow



ECR	Scale	Comments	Possible errors
ENQ (05h)	ACK (06h)	Data available	CAN - repeat weighing NAK - no acknowledgement NUL - no data available
DC1 (00h)		Data Request	NAK - no acknowledgement
	STX ID W5W4W3W2W1 BCC ETX	Transmitted Data	
STX ID W5W4W3W2W1 BCC ETX		Confirm Data	ACK - Data not confirmed NAK - receive error or scale error detected
	CR (0dh)	Data confirmed CAN response to ENQ is activated until current transaction is cleared	

Notes

- The POS can request and receive additional weight data from the scale before returning the verification weight. However, the verification weight must equal the last weight sent by the scale.
- Spaces depicted in the table above are only used for ease of reading. No space characters are used unless the BCC result yields the space character.

8 Appendix

8.1 Error messages

Error Code	Fault	Remedy
E10	Transmission error	→ Reset scale
E11	RAM error	→ Call METTLER TOLEDO Xpress service
E16	ROM error	→ Call METTLER TOLEDO Xpress service
E18	EEPROM error	→ Call METTLER TOLEDO Xpress service
Weight display: 	Underload, i.e. weight below zero limit	<ul style="list-style-type: none"> → Set the scale to zero → Load scale → Switch scale off and then on again → If message is still on, call METTLER TOLEDO Xpress service
Weight display: 	Overload	<ul style="list-style-type: none"> → Decrease load → Switch scale off and then on again → If message is still on, call METTLER TOLEDO Xpress service
Price display: 	Price > 9999.99	<ul style="list-style-type: none"> → Decrease load → Switch scale off and then on again → If message is still on, call METTLER TOLEDO Xpress service

8.2 Technical data

8.2.1 General technical data

Basic functions	<ul style="list-style-type: none"> • Tare, Zero
Communication	<ul style="list-style-type: none"> • RS-232 interface
Display	<ul style="list-style-type: none"> • LCD with 13.5 mm high characters and backlighting • 5 characters for weight • Base mount display (with rounded platform)
Keyboard	<ul style="list-style-type: none"> • 2 keys • Tactile and tone feedback upon pressing the key
Enclosure	<ul style="list-style-type: none"> • Plastic top and bottom covers • Die-casting spiders
Platform	<ul style="list-style-type: none"> • Stainless steel
Power consumption	<ul style="list-style-type: none"> • Approx. 18 mA without backlighting • Approx. 50 mA with backlighting
Power supply	<ul style="list-style-type: none"> • External 9 VDC / 500 mA power supply (120 VAC, 60 Hz, 23 W)
Operating conditions	<ul style="list-style-type: none"> • -10 °C ... +40 °C / 14 °F ... 104 °F • Relative humidity 10 % ... 85 %, non-condensing
Options	<ul style="list-style-type: none"> • Remote display bracket • Dual display
Setup function	<ul style="list-style-type: none"> • 1 sealable setup and calibration software switch
Storage temperature	<ul style="list-style-type: none"> • -25 °C ... +50 °C / -13 °F ... 122 °F • Relative humidity 10 % ... 85 %, non-condensing
(Shipping) weight	<ul style="list-style-type: none"> • Gross weight: 5.6 kg (12.3 lb) • Net weight: 4.5 kg (9.9 lb)
Weights & measures approvals	<ul style="list-style-type: none"> • OIML 3000e: Certificate N°R76/1992-NL 1-03.21 • T6294 EC Type approval certificate • NTEP 3000: Certificate of Conformance Number 04-037

Dimensions

Dimensions in mm

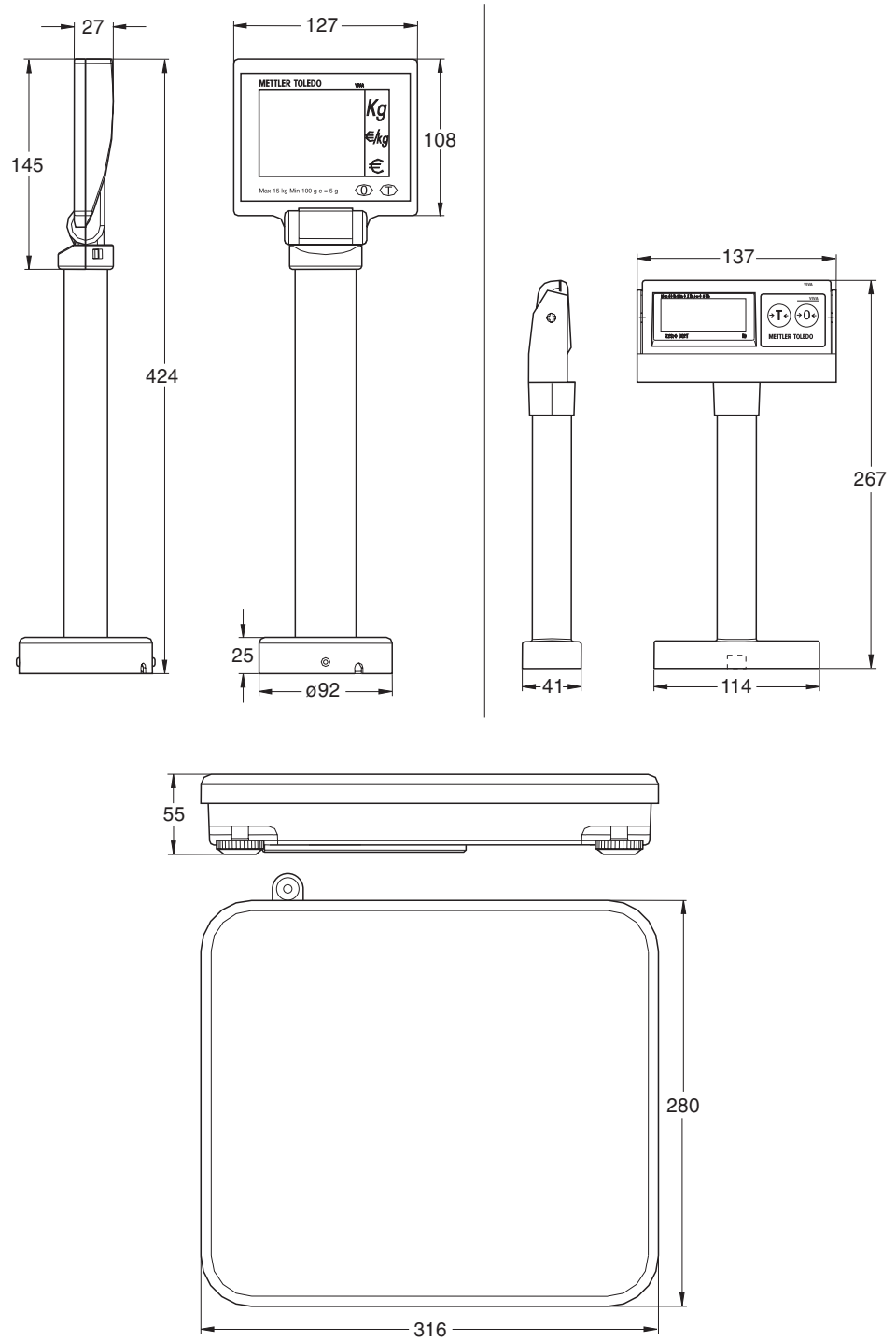

8.2.2 Weighing data

Capacity	6 kg	15 lb	15 kg	30 lb
Verified resolution	0.002 kg	0.005 lb	0.005 kg	0.01 lb
Display resolution	0.002 kg	0.005 lb	0.005 kg	0.01 lb

8.3 Communication cable

A null modem cable is required when connecting the XRV scale to a PC or a standard RS-232 port.

PC DB9-M			XRV DB9-F		
Pin#	Function	Description	Pin#	Function	Description
2	RxD	Receive Data	2	TxD	Transmit Data
3	TxD	Transmit Data	3	RxD	Receive Data
5	SGnd	Signal Ground	5	SGnd	Signal Ground

8.4 ASCII table

hex	dec	ASCII US	hex	dec	ASCII US	hex	dec	ASCII US	hex	dec	ASCII US	hex	dec	ASCII US
20	32	SP	33	51	3	46	70	F	59	89	Y	6C	108	l
21	33	!	34	52	4	47	71	G	5A	90	Z	6D	109	m
22	34	"	35	53	5	48	72	H	5B	91	[6E	110	n
23	35	#	36	54	6	49	73	I	5C	92	\	6F	111	o
24	36	\$	37	55	7	4A	74	J	5D	93]	70	112	p
25	37	%	38	56	8	4B	75	K	5E	94	^	71	113	q
26	38	&	39	57	9	4C	76	L	5F	95	_	72	114	r
27	39	'	3A	58	:	4D	77	M	60	96	`	73	115	s
28	40	(3B	59	;	4E	78	N	61	97	a	74	116	t
29	41)	3C	60	<	4F	79	O	62	98	b	75	117	u
2A	42	*	3D	61	=	50	80	P	63	99	c	76	118	v
2B	43	+	3E	62	>	51	81	Q	64	100	d	77	119	w
2C	44	,	3F	63	?	52	82	R	65	101	e	78	120	x
2D	45	-	40	64	@	53	83	S	66	102	f	79	121	y
2E	46	.	41	65	A	54	84	T	67	103	g	7A	122	z
2F	47	/	42	66	B	55	85	U	68	104	h	7B	123	{
30	48	0	43	67	C	56	86	V	69	105	i	7C	124	
31	49	1	44	68	D	57	87	W	6A	106	j	7D	125	}
32	50	2	45	69	E	58	88	X	6B	107	k	7E	126	~

8.5 FCC notice

This device complies with Part 15 of the FCC Rules and the Radio Interference Requirements of the Canadian Department of Communications. Operation is subject to the following conditions:

- This device may not cause harmful interference, and
- This device must accept any interference received, including interference that may cause undesired operation.

WARNING

This equipment generates, uses and can radiate radio frequency energy and if not installed and used properly, i.e., in accordance with the user manual, may cause harmful interference to radio communications. It has been tested and found to comply with the limits for a Class A digital device, pursuant to Part 15 of the FCC Rules. These limits are designed to provide reasonable protection against harmful interference when the equipment is operated in a commercial environment. Operation of this equipment in a residential area is likely to cause harmful interference to radio communications in which case the user will be required to correct the interference at his or her own expense.

8.6 Notes on Weights & Measures

The METTLER TOLEDO Xpress XRV checkout scale meets the requirements of the National Institute of Standards and Technology, Handbook 44.

Local Weights and Measures authorities may have regulations regarding the use of weighing devices in commercial applications. In all cases, Weights and Measures require that a scale be approved and sealed prior to commercial use.

Contact your local Weights and Measures authorities prior to use.



MTX06-OM072.0E

Subject to technical changes © Mettler Toledo (Chang Zhou) Scale and Systems Ltd. April 2006 Printed in China MTX06-OM072.0E

Xpress

Mettler-Toledo, Inc.
1150 Dearborn Drive
Worthington, OH 43085

<http://www.mt.com/xpress>
xpress@mt.com