



Owner's Manual

DVD+VCR HOME THEATER SYSTEM



Model : DR-C92D1N



- ◆ In the initial settings, exclusive channel for DVD/Video is set to CH 3. Set the TV channel to CH3 before using it.
- ◆ Region code of DVD/Video player for home is 4 or ALL. In inserting a disc with other region code, it does not operate. Please only use a disc with region code 4 or ALL.
- ◆  is a 'Prohibition' mark. If this mark is displayed in operating the product, please wait for a while, then use it. If  Prohibition mark continues to be displayed in pressing a button after that, it means the button does not function in the currently played disc.
- ◆ Press a product button on the remote control then use the product.
 - DVD operation : [DVD] button
 - Video operation : [VCR] button

DAEWOO

Important Safeguards

	CAUTION RISK OF ELECTRIC SHOCK DO NOT OPEN	
CAUTION: TO REDUCE THE RISK OF ELECTRIC SHOCK, DO NOT REMOVE COVER (OR BACK). NO USER-SERVICEABLE PARTS INSIDE. REFER SERVICING TO QUALIFIED SERVICE PERSONNEL.		



The lightning flash with arrowhead symbol, within an equilateral triangle, is intended to alert the user to the presence of uninsulated "dangerous voltage" within the product's enclosure that may be of sufficient magnitude to constitute a risk of electric shock.



The exclamation point within an equilateral triangle is intended to alert the user to the presence of important operating and servicing instructions in the literature accompanying the appliance.

WARNING TO REDUCE THE RISK OF FIRE OR ELECTRIC SHOCK, DO NOT EXPOSE THIS APPLIANCE TO RAIN OR MOISTURE.

CAUTION TO PREVENT ELECTRIC SHOCK, MATCH WIDE BLADE OF PLUG TO WIDE SLOT, FULLY INSERT.

IMPORTANT FOR LASER PRODUCTS

LASER This Digital Video Disc Player employs a Laser System. To ensure proper use of this product please read this owner's manual carefully and retain for future reference. Should the unit require maintenance, contact an authorized service location - see service procedure.

Use of control adjustments or the performance of procedures other than those specified may result in hazardous radiation exposure.

To prevent direct exposure to the laser beam, do not try to open the enclosure. Visible laser radiation when open and interlocks defeated.
DO NOT STARE INTO THE BEAM.

DANGER Visible laser radiation when open and interlock failed or defeated.
Avoid direct exposure to beam.

CAUTION Do not open the top cover. There are no user serviceable parts inside the Unit; leave all servicing to qualified service personnel.

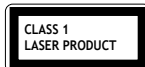

FCC NOTICE This equipment has been tested and found to comply with the limits for a Class B digital device, pursuant to part 15 of the FCC Rule. These limits are designed to provide reasonable protection against harmful interference in a residential installation. This equipment generates, uses and can radiate radio frequency energy and if not installed and used in accordance with the instructions, may cause harmful interference to radio communications. However, there is no guarantee that interference will not occur in a particular installation. If this equipment does cause harmful interference to radio or television reception; which can be determined by turning the equipment off and on, the user is encouraged to try to correct the interference by one or more of the following measures:

- Reorient or relocate the receiving antenna.
- Increase the separation between the equipment and receiver.
- Connect the equipment to an outlet on a circuit different from that to which the receiver is connected.
- Consult the dealer or an experienced radio/TV technical for help.

This device complies with part 15 of the FCC Rules. Operation is subject to the following two conditions: (1) This device may not cause harmful interference, and (2) This device must accept any interference received, including interference that may cause undesired operation.

CAUTION Any changes or modification in construction of this device which are not expressly approved by the party responsible for compliance could void the user's authority to operate the equipment.

Important Safeguards

This set has been designed and manufactured to assure personal safety. Improper use can result in electric shock or fire hazard. The safeguards incorporated in this unit will protect you if you observe the following procedures for installation, use and servicing. This unit is fully transistorized and does not contain any parts that can be repaired by the user.

1 Read Instructions

All the safety and operating instructions should be read before the unit is operated.

2 Retain Instructions

The safety and operating instructions should be retained for future reference.

3 Heed Warnings

All warnings on the unit and in the operating instructions should be adhered to.

4 Follow Instructions

All operating and use instructions should be followed.

5 Cleaning

Unplug this unit from the wall outlet before cleaning. Do not use liquid cleaners or aerosol cleaners. Use a damp cloth for cleaning.

6 Attachments

Do not use attachments unless recommended by the unit's manufacturer as they may cause hazards.

7 Water and Moisture

Do not use this unit near water- for example, near a bath tub, wash bowl, kitchen sink or laundry tub, in a wet basement, or near a swimming pool and the like. Caution : Maintain electrical safety. Powerline operated equipment or accessories connected to this unit should bear the UL listing mark or CSA certification mark on the accessory itself and should not be modified so as to defeat the safety features. This will help avoid any potential hazard from electrical shock or fire. If in doubt, contact qualified service personnel.

8 Accessories

Do not place this unit on an unstable cart, stand, tripod, bracket, or table. The unit may fall, causing serious injury to a child or adult as well as serious damage to the unit. Use this unit only with a cart, stand, tripod, bracket, or table recommended by the manufacturer.

8A A unit and cart combination should be moved with care. Quick stops, excessive force, and uneven surfaces may cause the unit and cart combination to overturn.

PORTABLE CART WARNING
(symbol provided by RETAC)



9 Ventilation

Slots and openings in the case are provided for ventilation to ensure reliable operation of the unit and to protect it from overheating. These openings must not be blocked or covered. These openings must not be blocked by placing the unit on a bed, sofa, rug, or other similar surface. This unit should never be placed near or over a radiator or heat radiator. This unit should not be placed in a built-in installation such as a bookcase or rack unless proper ventilation is provided or the manufacturer's instructions have been adhered to.

10 Power Sources

This unit should be operated only from the type of power source indicated on the marking label. If you are not sure of the type of power supply to your home, consult your dealer or local power company. For units intended to operate from battery power, or other sources, refer to the operating instructions.

11 Grounding or Polarization

This unit is equipped with a polarized alternating-current line plug (a plug having one blade wider than the other). This plug will fit into the power outlet only one way. This is a safety feature. If you are unable to insert the plug fully into the outlet, try reversing the plug. If the plug still fails to fit, contact your electrician to replace your obsolete outlet. To prevent electric shock, do not use this polarized plug with an extension cord, receptacle, or other outlet unless the blades can be fully inserted without blade exposure. If you need an extension cord, use a polarized cord.

12 Power-Cord Protection

Power-supply cords should be routed so that they are not likely to be walked on or pinched by items placed upon or against them, paying particular attention to cords at plugs, convenience receptacles, and the point where they exit from the unit.

Note to CATV system installer

This reminder is provided to call the CATV system installer's attention to Section 820-40 of the NEC which provides guidelines for proper grounding and, in particular, specifies that the cable ground shall be connected to the grounding system of the building, as close to the point of cable entry as practical.

13 Outdoor Antenna Grounding

If an outside antenna or cable system is connected to the product, be sure the antenna or cable system is grounded so as to provide some protection against voltage surges and built-up static charges. Section 810 of the National Electrical Code, ANSI/NFPA No. 70-1984 (Section 54 of Canadian Electrical Code, Part 1) provides

information with respect to proper grounding of the mast and supporting structure, grounding of the lead-in wire to an antenna-discharge unit, connection to grounding electrodes, and requirements for the grounding electrode. See example as shown.

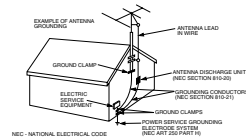

14 Power Lines

An outside antenna system should not be located in the vicinity of overhead power lines, other electric light or power circuits, or where it can fall into such power lines or circuits. When installing an outside antenna system, extreme care should be taken to keep from touching or approaching such power lines or circuits as contact with them might be fatal. Installing an outdoor antenna can be hazardous and should be left to a professional antenna installer.

15 Lightning

For added protection for this unit during a lightning storm, or when it is left unattended and unused for long periods of time, unplug it from the wall outlet and disconnect the antenna or cable system. This will prevent damage to the unit due to lightning and power line surges.

16 Disc Tray

Keep your fingers well clear of the disc as it is closing. It may cause serious personal injury.

17 Overloading

Do not overload wall outlets of extension cords as this can result in a risk of fire or electric shock.

18 Object and Liquid Entry

Never push objects of any kind into this unit through openings as they may touch dangerous voltage points or "short-out" parts that could result in a fire or electric shock. Never spill liquid of any kind on the unit.

19 BURDEN

Do not place a heavy object on or step on the product. The object may fall, causing serious personal injury and serious damage to the product.

20 DISC

Do not use a cracked, deformed or repaired disc. These discs are easily broken and may cause serious personal injury and product malfunction.

Important Safeguards

21 Servicing

Do not attempt to service this unit yourself as opening or removing covers may expose you to dangerous voltage or other hazards. Refer all servicing to qualified service personnel.

22 Damage Requiring Service

Unplug this unit from the wall outlet and refer servicing to qualified service personnel under the following conditions.

- A When the power-supply cord or plug is damaged.
- B If liquid has been spilled, or objects have fallen into the unit.
- C If the unit has been exposed to rain or water.
- D If the unit does not operate normally by following the operating instructions. Adjust only those controls that are covered by the operating instructions. Improper adjustment of other controls may result in damage and will often require extensive work by a qualified technician to restore the unit to its normal operation.
- E If the unit has been dropped or the cabinet has been damaged.
- F When the unit exhibits a distinct change in performance-this indicates a need for service.

23 Replacement Parts

When replacement parts are required, have the service technician verify that the replacements he uses have the same safety characteristics as the original parts. Use of replacements specified by the unit manufacturer can prevent fire, electric shock, or other hazards.

24 Safety Check

Upon completion of any service or repairs to this unit, ask the service technician to perform safety checks recommended by the manufacturer to determine that the unit is in safe operating condition.

25 Wall or Ceiling Mounting

The product should be mounted to a wall or ceiling only as recommended by the manufacturer.

26 Heat

The product should be situated away from heat sources such as radiators, heat registers, stoves, or other products (including amplifiers) that produce heat.

Advantages of This Product Are

- DVD, VCD, CD, CD-R(MP3), CD-RW, VHS playback function
- Watching DVD for recording broadcast
- Integrated remote control (VCR, DVD)
- VISS function
- Multiplex sound playback/record
- High Sound Quality of 6 head Hi-Fi
- One Touch timer Recording (OTR)
- MP3 file playback function (CD-R disc having records of MP3 files)
- GUI (Graphical User Interface) OSD (On Screen Display)
By using the [DISPLAY] button on the remote control, information on the DVD/VCD/CD player and disc, can be displayed on the TV screen.
- Screensaver function (DVD)
- Built-in Dolby Digital decoder (DVD)
- Analog audio 2-channels output for DOWNMIX (x1)
- Composite video out (x1)
- Slow Forward / Reverse (DVD) playback
- Fast Forward / Reverse playback
- Search of title, chapter, and time in DVD disc, and search of track and time in VCD and CD
- Various TV aspect (DVD)
4:3 for Pan and Scan, 4:3 for Letter Box, and 16:9 for Wide
- Repeat playback (title and chapter for DVD, track and disc for VCD/CD)
- Repeat a defined period from A to B (DVD)
- Selective Play (VCD/CD/MP3)
You can select and play the desired track of VCD/CD/MP3 in STOP mode.
- Various languages OSD (On Screen Display) function (DVD)
You can select and display OSD among various languages. (English, French, Spanish)

- Parental Lock function (DVD)
This function can prevent playback of software that may be unsuitable for children.
- Multi Audio function (DVD)
The audio soundtrack can be heard in up to 8 languages. (The number of audio languages depends on the disc.)
- Multi Subtitle function (DVD)
The subtitle can be seen in up to 32 languages. It depends on the disc. (The number of subtitle languages depends on the disc.)
- Multi Angle function (DVD)
This function allows you to choose the viewing angle of scenes which were shot from a number of different angles. (The number of angles depends on the disc.)
- Screen zoom function (DVD/VCD)

Read Carefully before Using

Cautions in use of DVD-Video player are described below. Please read carefully before using a DVD-Video player.

Installation place and handling

- When you place this player near other devices, they may affect poorly together.
- When you place DVD-Video player and TV in the upper and lower sides, it may cause flickering of pictures or failure (tape is not ejected).
- When you place this player near strong magnetic materials, it may affect image or voice poorly or damage recording.
- Do not spill volatile liquids like insect spray over the player. Do not leave rubber or plastic products in contact with the player for a long time. They will cause deterioration or paint peel-off.

Not in use

- When the unit is not in use, be sure to remove the disc or tape and turn off the power.
- If you do not use the unit for a long period, remove batteries in remote control to prevent leakage.
- In case you don't use the unit for a long time, the unit may not function properly in the future. Turn on and use the player occasionally.

Moving

- Repack the unit as it was originally packed at the factory. Alternatively, pack this product with towel not to be damaged.
- Eject any videotape.

Cleaning

- Dust off dirt in cabinet or control panel part smoothly with a soft cloth.
- For heavy dirt, soak the cloth in a weak detergent solution, wring it well and wipe. Use a dry cloth to wipe it out.
- Follow instructions in using chemical cleaners.
- Do not use any type of solvent such as gasoline or benzene, as they may cause deterioration or paint peel-off.

Checking

- Video is a high precision device. To obtain a clear screen, we recommend regular inspection and maintenance every 1,000 hours of use by technical engineers.
- For checking, contact your dealer or your nearest service center.

Checking and Replacement of Antenna

- Antenna is subject to change in its direction or damage by wind and rain. For clean screen, contact and consult your nearest service center about checking and replacement.

In recording important screen

- Be sure to record the screen and check whether recording is performed properly. We beg you to understand compensation of recording if recording is not performed by badness of used tape or video.

Copyright

- Do not use your recordings without permission of a copyrighter except personal usage.

Tape and Disc Handling

- Do not use any tape and disc below. Damage of video head or cut/coiling of tape may cause failure.
 - Tape with mold
 - Tape or disc stained with juice or attachments
 - Tape having breakage connection
 - Disassembled tape
 - Disc with severe scratch
- Moisture condensation may occur in tape. Moisture condensation damages the tape. Please use the tape after the moisture condensation is disappeared.
- After use, store tape vertically in a case to prevent loose.
- Do not store the following places.
 - High temperature and humidity
 - Subject generation of mold
 - Subject to direct sunlight
 - Much dirt or dust
 - Near strong magnetic materials such as speaker

Contents

Product Information

Important Safeguards	1
Advantages of This Product Are	4
Read Carefully before Using	5
Contents	6
Identification of Controls	7
Remote Control	10

Installation

Connecting with TV	12
FM/AM Antenna connection	14
Speaker system connection	15
Connecting with Other Equipment	16
Output Select	18
Clock Set	19

VCR Operation

VCR Playback	20
Memorizing TV Channels	21
Using advanced features	23
Hi-Fi Stereo Playback	26

DVD Setup

DVD initial setting	
LANGUAGE Setup	27
DISPLAY Setup	28
AUDIO Setup	29
RATINGS Setup	30

DVD Operation

DVD Playback	32
Playing a desired scene	34
Confirming the current PLAY mode on screen ..	38
AUDIO, SUBTITLE language and Sound Fields ..	40
ZOOM and Multi Angle	41
About MP3 discs	42
Displaying menu in a disc	43

Recording

Recording	44
Timer Recordings	46
Watching and Recording Cable TV	49

Radio Operation

Presetting the radio stations	50
Listening to the radio	51

Speaker Setup

Speaker Setup for enjoying the surround sound effect	52
Delay Time Setting	54
Setting the sound level	56

The others

About DVD	58
Basic information about VCR and Videotape	60
Before doubting about troubles (DVD)	61
Before doubting about troubles (VCR)	62
Specifications	64

Identification of Controls

Front panel

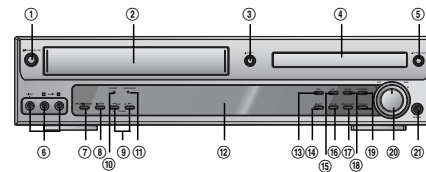

- ① **Power (STANDBY/ON) button**
Use to power the device on/off if AC power supply is connected.
- ② **Place to insert videotape**
Insert the desired tape.
- ③ **Eject button**
Use to eject the tape.
- ④ **Disc tray**
- ⑤ **Open/Close Tray button**
Open or close tray by pressing [OPEN/CLOSE] button. Place a disc on the disc tray, label side up.
- ⑥ **Video / Audio input 3 jack**
Connect a cable coming from the video/audio out jacks of a camcorder, another VCR, or an audio visual source here.
- ⑦ **Playback/PAUSE button**
Playback videotape or disc.
Press this button to pause a screen.
- ⑧ **Stop/MEMORY button**
Use to stop playing a tape or disc. Use to memory radio stations.
- ⑨ **Tuning & Search +/-**
Search- (◀◀): Use to rewind currently being played videotape or disc; or to playback back rapidly.
Search+ (▶▶): Use to wind currently being played videotape or disc; or to playback rapidly.
Tuning +/-: Scan all available radio stations.
- ⑩ **VHS/REC indicator**
The indicator lights in yellow-green in VHS mode.
The indicator lights in red in Recording mode.
- ⑪ **DVD/P.SCAN indicator**
The indicator lights in yellow-green in DVD mode.
The indicator lights in red in Progressive Scan mode.
- ⑫ **Operation Display Window**
Display operation of device. For more information, see "Operation Display Window" in the next page.
- ⑬ **VCR button**
Use to change into VCR or external Input mode.
- ⑭ **Record button**
Record a program from TV or other sources (except DVD).
- ⑮ **DVD button**
Use to change into DVD mode.
- ⑯ **P.SCAN button**
Use to enter into Progressive Scan mode.
- ⑰ **SOUND FIELD button**
Use to adjust the Sound Fields.
- ⑱ **AM/FM button**
Use to change into RADIO mode.
- ⑲ **Channel & Preset +/-**
Use to select the memorized TV broadcasting channel or radio stations.
- ⑳ **Volume control**
Change the loudness of the sound from the speakers connected to the unit.
- ㉑ **Headphone jack**

Identification of Controls

Operation Display Window

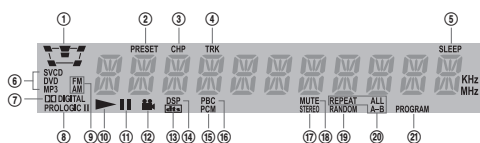

- | | |
|----------------------------|------------------------------------|
| ① Speaker setup indicator | ⑫ Multi Angle indicator |
| ② Memorized radio stations | ⑬ DTS indicator |
| ③ Chapter indicator | ⑭ DSP indicator |
| ④ Track indicator | ⑮ PCM indicator |
| ⑤ Sleep time indicator | ⑯ PBC (PlayBack Control) indicator |
| ⑥ Playback disc indicator | ⑰ FM Stereo indicator |
| ⑦ Dolby Digital indicator | ⑱ Mute indicator |
| ⑧ Prologic II indicator | ⑲ Random playback indicator |
| ⑨ FM/AM indicator | ⑳ Repeat playback indicator |
| ⑩ Playback indicator | ㉑ Program indicator |
| ⑪ Pause indicator | |

Identification of Controls

Rear Panel

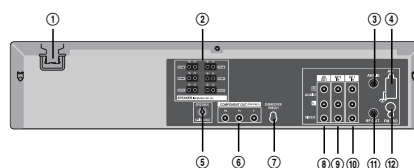

- | | |
|--|--|
| ① Power Cord
Jack for supplying power to the unit. Connect to a wall outlet. | ⑦ Subwoofer Pre-Output Jack
Connect an active subwoofer to improve bass performance especially in a large room. |
| ② 5.1 Speaker Out Jack
Connect each of the speaker wires to the satellite speakers. Speaker cords, 1 for each speaker, are needed for connection. When connecting the speakers, make sure the polarities ("+" side of the speaker wire to "+" on the receiver) of speaker wires and terminals are matched. | ⑧ A/V Output Jack |
| ③ Connection to Antenna Cable
Connect a coaxial cable from your cable wall outlet or antenna to the ANT IN jack on the back of your DVD/VCR unit. | ⑨ A/V Input 2 Jack |
| ④ AM Antenna Jack | ⑩ A/V Input 1 Jack |
| ⑤ S-Video Output Jack (DVD only) | ⑪ Connection to TV
Required connection for VCR operation. Connect one end of the RF cable to the RF Out Jack on the back of the unit and the other end to the ANT IN jack on the back of your TV. |
| ⑥ COMPONENT (Progressive) Out Jack (DVD only)
To obtain better screen quality, connect the unit to a TV or monitor with a COMPONENT(480i or 480p) input.
<i>Note: VCR signal is only available from Composite Video Out jack and RF Out. You must always connect these to the TV in order to set up and use your unit.</i> | ⑫ FM Antenna Jack |

Remote Control

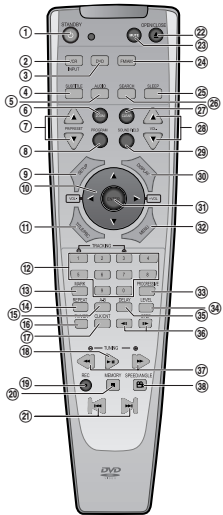

- ① POWER button
- ② VCR/INPUT SELECT button
- ③ DVD SELECT button
- ④ [DVD] SUBTITLE Select button
- ⑤ [DVD] AUDIO LANGUAGE Select, [VCR] AUDIO Select button, [RADIO] Set FM Mode to Stereo or Mono sound
- ⑥ [DVD] ZOOM button
- ⑦ [VCR] Channel Up/Down button, [RADIO] Tune to the presetted stations
- ⑧ [VCR] TIMER RECORDING button, [DVD] PROGRAM button
- ⑨ SETUP button
- ⑩ [DVD, VCR] Use to highlight selections on a menu and adjust certain settings, [RADIO] Adjust the volume
- ⑪ [DVD] TITLE/PBC button
- ⑫ [DVD, VCR] NUMBER button, [VCR] TRACKING +/- button
- ⑬ BOOKMARK button
- ⑭ [DVD] REPEAT Playback button
- ⑮ [DVD] REPEAT a defined period from A to B button
- ⑯ TV/VCR Select
- ⑰ [DVD, VCR] CLOCK/COUNTER button
- ⑱ PLAY/PAUSE button
- ⑲ [VCR] Record button
- ⑳ STOP/MEMORY (Enter the number of a selected chapter, track, station or channel) button
- ㉑ [DVD] PREVIOUS (move into a previous chapter or track) / NEXT (Move into a next chapter or track) button
- ㉒ [DVD] OPEN/CLOSE button, [VCR] EJECT button
- ㉓ SOUND MUTE button
- ㉔ [RADIO] FM/AM Select button
- ㉕ SLEEP button
- ㉖ [DVD] Chapter/Title/Time SEARCH button
- ㉗ CLEAR button
- ㉘ Adjust the volume
- ㉙ SOUND FIELD button
- ㉚ [DVD, VCR] OSD DISPLAY button
- ㉛ ENTER (Confirm selections on a menu screen) button
- ㉜ [DVD] MENU button
- ㉝ [DVD] Progressive Scan button
- ㉞ [DVD] Sound LEVEL adjust button
- ㉟ [DVD] DELAY adjust button
- ㊱ SLOW FORWARD/REVERSE button, [VCR] Frame Advance button in pause mode
- ㊲ [DVD, VCR] FORWARD / REVERSE SEARCH button, [RADIO] Scan all available radio stations
- ㊳ [DVD] ANGLE, [VCR] Record SPEED button

Child Lock!!! (VCR mode)

Press the power [⏻] button of the remote control for about 8 seconds. No buttons of front panel and remote control can be operated now and Lock indicator (LOCK) will be displayed on window display. To release child lock, press the power [⏻] button of the remote control for about 8 seconds.

Remote Control

Instructions in using remote control

- Operate remote control within 7m from the unit.
- Do not press 2 (two) buttons at the same time.
- Do not light up sending part of remote control.
- Do not keep in the place with much dust and humidity.

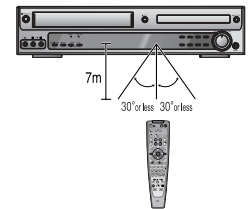

Accessories

Remote Control	2 Batteries	RF cable	Connecting cable to Audio/Video jack	Owner's Manual/Warranty
AM antenna 	FM antenna 	<ul style="list-style-type: none"> To purchase accessories or not supplied parts additionally, contact your nearest dealer or service center. But, owner's manual and warranty are not sold additionally. 		

Connecting with TV

- In the initial SET, exclusive channel for video is set to CH 3. To change this setting, set again in "CHANNEL SET" screen in VCR operation.
- In connecting RF cable to TV, set TV channel to CH3.

Various methods in connecting with TV

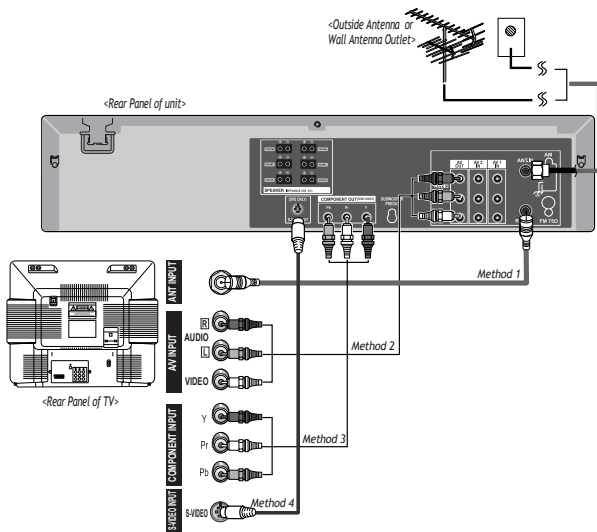

Method 1

Remove circular cable (RF cable) (surplus cable) plugged in "ANT.IN" Jack in rear panel of TV. Connect the cable to "ANT.IN" jack in rear panel of DVD-Video. Connect TV to DVD-Video. Connect "RF OUT" jack in DVD-Video with "ANT.IN" jack in TV with RF cable.

Method 2 : Connecting to a TV that has a audio/video in jacks

Connect VIDEO OUT jack in DVD-Video to VIDEO IN jack in TV, and AUDIO OUT jack in DVD-Video to AUDIO IN jack in TV with connecting cable of Audio/Video jack. Select VCR mode by pressing [TV/INPUT] button in TV, you can view more clear screen and sound than connection with RF cable only.

Method 3 : Connecting to a TV that has a component video in jacks

Use a component video cable (commercially available) in place of the yellow video cable to enjoy higher quality pictures. The component video connection only supplies video (picture) in the DVD mode of the DVD-Video. Therefore, in order to use the VCR features or view TV channels at the DVD-Video, you still need to either connect the RF coaxial cable between the ANT-OUT jack of the DVD-Video and the TV's Antenna In jack, or connect the video cable.

Method 4 : Connecting to a TV that has a S-Video in jacks

Use a S-Video cable (not supplied) to enjoy higher quality pictures.

- VHF: 2 -13 channels of TV, UHF: 14-69 channels of TV, CATV: Broadcasting is transmitted with cable from broadcasting station by contract with the station and consumers. It does not need any antenna.
- In/Out jack in Audio/Video terminal: - In: A jack used to receive signal required in this unit from other units. - Out: A jack used to send signal of this unit to other units.
- Connect with Audio/Video terminal, you can enjoy more clear video and audio. (Use [INPUT] button in this remote control to select video mode.)
- If screen is broken in connecting COMPONENT Out to Pr, Pb, Y of TV COMPONENT In jack, connect to Cr, Cb, Y.

FM/AM Antenna connection

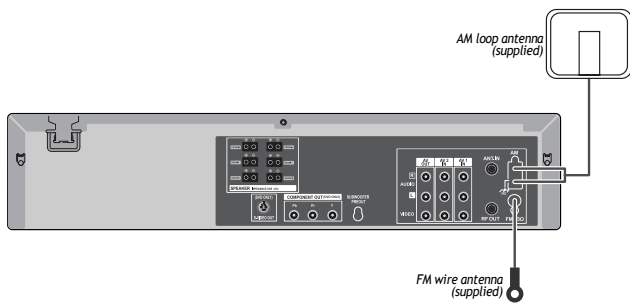

Connect the supplied FM/AM antennas for listening to the radio.

- Connect the AM loop antenna to the AM antenna connector.
- Connector the FM wire antenna to the FM antenna connector.



- To prevent noise pickup, keep the AM loop antenna away from the DVD Receiver and other component.
- Be sure to fully extend the FM wire antenna.
- After connecting the FM wire antenna, keep it as horizontal as possible.

Speaker system connection

Connect the speakers using the supplied speaker cords by matching the colors of the terminals and those of the cords. To obtain the best possible surround sound, adjust the speaker parameters (distance, level, etc.)

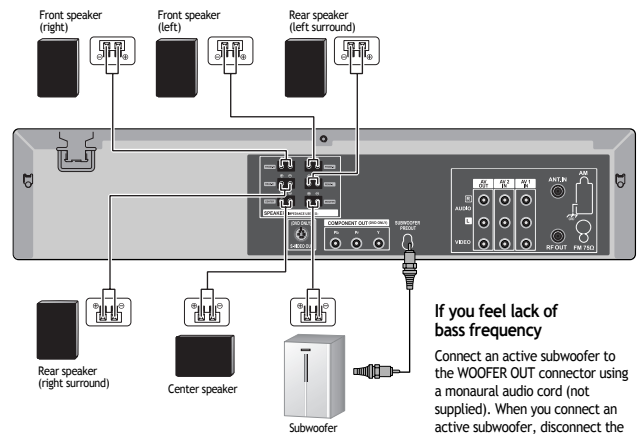

If you feel lack of bass frequency

Connect an active subwoofer to the WOOFER OUT connector using a monaural audio cord (not supplied). When you connect an active subwoofer, disconnect the woofer from the WOOFER speaker connector.



- Be sure to match the speaker cord to the appropriate terminal on the components: + to + and - to -. If the cords are reversed, the sound will be distorted and will lack base.
- If you use front speakers with low maximum input ratings, adjust the volume carefully to avoid excessive output on the speakers.
- Do not disassemble the front cover of supplied speaker.

Connecting with Other Equipment

Connecting with Other Equipment

You can connect a wide variety of audio/video equipment to your DVD-Video, including : an additional VCR, Laser Disc Player, DVD Player, Camcorder, Satellite Receiver, Video Game. Since all of these devices use essentially the same connections, they will be described together.

Connection with other video equipment

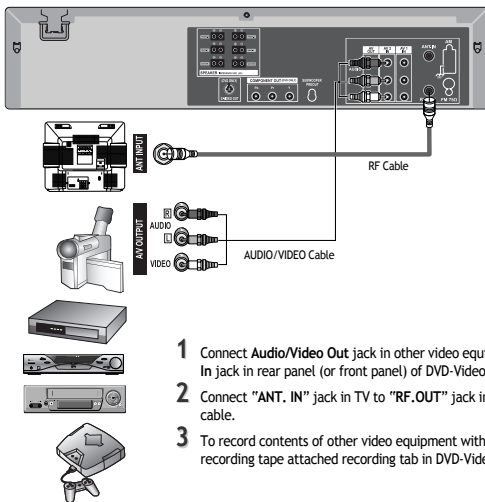

- 1 Connect Audio/Video Out jack in other video equipment to Audio/Video In jack in rear panel (or front panel) of DVD-Video with connecting cable.
- 2 Connect "ANT. IN" jack in TV to "RF.OUT" jack in DVD-Video with RF cable.
- 3 To record contents of other video equipment with DVD-Video, insert recording tape attached recording tab in DVD-Video.

How to Copy(Edit) Tape with Other Video Equipment

- 1 Turn on DVD-Video.
 - 2 Press [VCR/INPUT] button of remote control and adjust DVD-Video to display "Video1", "Video2" or "Video3" in TV screen.
 - 3 Press [PLAY] button in other video equipment.
 - 4 Press [REC] button in DVD-Video if you want to record contents of other video equipment.
 - 5 Press [Pause] button in DVD-Video when unnecessary or undesired scene is displayed in recording.
- (Caution) Recording is released automatically after 5 minutes since pressing [PAUSE] button. Press [REC] button if you want to record again.

Connection with an Analog Audio

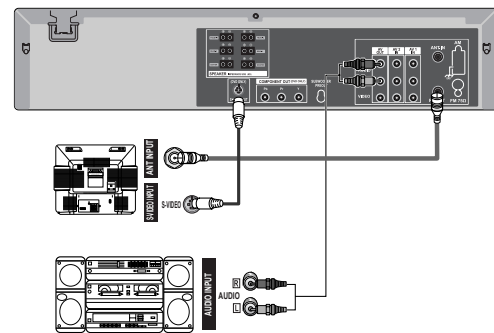

- 1 Connect Audio jack. Connect AUDIO OUT in rear panel of DVD-Video to In jack of stereo sound unit.
- 2 For Input Select in stereo unit, select "External Input" connected with DVD-Video.
- 3 Playback DVD disc or Hi-Fi videotape, you can hear sound in speaker of stereo unit.

Installation

Output Select

To Select DVD

Press [DVD] button.

If DVD mode is correctly selected, DVD indicator on the front panel is lighted. Then, remote control button works as DVD function. Press the [DVD] button, then the mode of DVD-Video Player becomes to the DVD OPERATION mode.

To Select VCR

Press [VCR] button.

If VCR mode is correctly selected, VCR indicator on the front panel is lighted. Then, remote control button works as VCR function. Press the [VCR] button, then it becomes to the VCR OPERATION mode.

To Select Watch Modes or External Input

Press [VCR] button.

To toggle and select VCR PLAYBACK, BROADCASTING RECEPTION or EXTERNAL INPUT, press [VCR] button repeatedly.

Clock Set



- Set TV to CH 4 (or 3).
- Press [VCR] button on remote control to change into VCR mode and follow the procedures below.

1 Press [SETUP] button.

Press [ENTER] button to select CLOCK SET.
Select "Time and Date Set" with [ENTER] button in CLOCKSET screen.

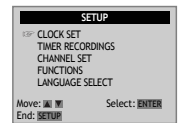

2 Set the current date and time with [▲▼◀▶] button or [NUMBER] button.

For DATE SET, follow the order of Month / Day / Year ; for TIME SET, follow the order of Hour / Minute in CLOCK SET screen.

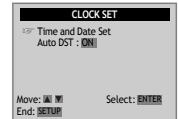

3 If CLOCK SET is completed, press [SETUP] button.

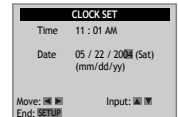

VCR Playback



- 1** Press [⏻] button to power on.
Press [VCR] button of remote control to change into VCR mode.
- 2** Insert the desired tape.
- 3** If you want to playback it, press [PLAY] button.
When the operational status is flickering or poor, adjust it with [TRACKING +/-] button.
- 4** To stop it, press [■] button.
For pause, press [PLAY/PAUSE] button in playback mode.
If you press this button once more, it starts playback again.
- 5** Press [EJECT] button in the front part or [OPEN/CLOSE] button on remote control to remove the tape.

Various Playback Methods

- If you want fast forward (or reverse) playback, press [▶▶] or [◀◀] button in Playback mode. You can watch fast playing (rewinding) screen.
 - If you want Still picture, press [PLAY] in Playback mode. You can watch the desired screen in pause status.
 - If you want slow-motion playback, press [▮▶] button in Play mode. You can watch the desired screen in the slow forward playback.
- * NOTE: VCR doesn't have Slow Reverse Playback function.*
- If you want to watch a series of screens one by one (FRAME ADVANCE), press [▮▶] button in Pause mode. Each time you press this button, the picture advances one frame.

To Adjust Display

This product includes automatic Tracking function and enables users to enjoy clear picture without an additional operation. Provided that the following problems can be solved by the manual adjustment, which improves display quality. (During automatic display adjustment, "Adjusting Display" are displayed on TV screen.)

- If the screen is poor in Playback mode,
- If noises occur in the upper or lower part of screen in slow playback mode,
- If paused picture vibrates up and down.

Use [TRACKING +/-] buttons of remote control to adjust the display suitable for watching.



If the product, which has an auto-detector, detects a contaminated head(s), it shows the conditions to notice the contamination on screen.

In case of the notice on screen, please rub the heads with a head-cleaner followed by "How to use a head-cleaner".

Memorizing TV Channels

To Memorize Channels Automatically

- 1** Press [SETUP] button.
Press [▼] button to move [CH] into CHANNEL SET, and then select CHANNEL SET with [ENTER] button.
- 2** Select "Auto Channel Search".
Press [ENTER] button in CHANNEL SET window to select AUTO CHANNEL SEARCH.

Select "Detect Automatically".

Press [ENTER] button in AUTO CHANNEL SEARCH window to detect the channel automatically.

Channel number changes successively from 01 to 125, while only broadcasting channels are memorized automatically. When memory process is completed, the lowest number's one of memorized channels is displayed.

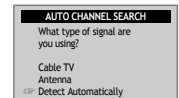
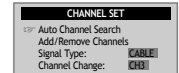
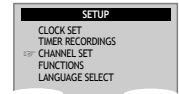

- 3** Please, check the memorized channels.
To check the memorized channels, press [CH up/down] button on remote control.

To Memorize Channels Manually

- To add additional channels without affecting your existing stored channels, follow the steps below:

- 1** Press [SETUP] button and select "CHANNEL SET".
Select "Add/Remove Channels".
- 2** Select the desired channel and memorize it.
Press [NUMBER] button of remote control to select the desired channel to memorize.
When [▶] button is pressed, "REMOVED" under channel number converts into "ADDED".



- 3** Check the memorized channel.
To check the memorized channel, press [CH up/down] button on remote control.

Memorizing TV Channels

To Delete Channels Manually

- Follow the procedures below to delete stored channels.

- Press [SETUP] button and select "CHANNEL SET". Select "Add/Remove Channels".
- Select the desired channel and delete it.
Press [NUMBER] button of remote control to select the desired channel to delete. When [▶] button is pressed, "ADDED" under the channel number converts into "REMOVED".
- To check the deleted channel, press [CH up/down] button on remote control.



Selecting cable or antenna viewing

- You must set the viewing mode for your VCR, choosing either CABLE (cable system connection) or ANTENNA (antenna connection).

To set the viewing mode:

From the CHANNEL SET menu, press [▼] to move the cursor down to SIGNAL TYPE. Press [ENTER] to toggle between CABLE and ANTENNA.

When the desired viewing mode is displayed, press [SETUP] twice to exit.

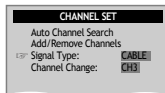

To Set Output Channel

Press [SETUP] button and select "CHANNEL SET". Select "Channel Change".

By pressing [ENTER] button, set the exclusive channel for video on the desired one of CH3 or CH4.

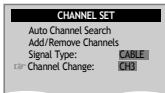

Using advanced features

Play the tape automatically

- This feature allows the VCR to automatically start playing when you insert a tape with the safety tab removed.

- Press [SETUP] button and select "FUNCTIONS".
Move [▶] into "FUNCTIONS" with [▼] and then, select the desired one with [ENTER] button.

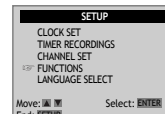

- Move the cursor to "Auto Play" and press [ENTER] to select between ON and OFF.

- Select ON if you want a tape with its safety tab removed to start playing automatically when the tape is inserted.
- Select OFF if you do not want a tape with its safety tab removed to start playing automatically.

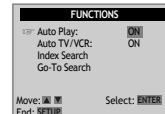

Switch the VCR to TV or VCR mode automatically

- This feature controls whether the TV/VCR switch changes automatically to the VCR mode when the VCR is turned on.

- Press [SETUP] button and select "FUNCTIONS".
Move [▶] into "FUNCTIONS" with [▼] and then, select the desired one with [ENTER] button.

- Move the cursor to "Auto TV/VCR" and press [ENTER] to select between ON and OFF.

- Select ON if you want the VCR to switch to the VCR mode when the VCR is turned on or a cassette is inserted. This only applies if you connect the ANT.IN and RF OUT jacks of your VCR and TV and watch your VCR on channel 3 of your TV.
- Select OFF if you want the VCR to remain in the TV mode. This is useful if you watch your VCR on the TV's video input and you don't want your antenna/cable signal interrupted by the VCR.

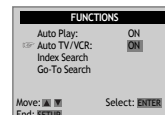

Searching a cassette tape for programs (indexing)

- When you record a program, the VCR places an index mark at the start of the recording. To search for an index mark:

• If two recordings overlap, the index mark for the second program will be erased. Therefore, when you use the index feature to find the second program, the VCR will skip over it.

• If you record multiple programs in one recording session, the VCR will only find the index mark that was placed on the video cassette tape when the recording session began.

- Press [SETUP] button and select "FUNCTIONS".

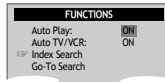

- If you want to search through a certain number of index marks, press two number buttons to enter the number of marks you want to search. Press [CLEAR] on the remote to correct an entry.
or
Press [REW] to search backward or [FF] to search forward. The VCR will locate your index mark and begin playback. If you did not enter a specific index number, the VCR will locate the next index mark and begin playback. Press [STOP] to stop index searching.



Searching with the tape counter (go-to search)

- You can mark a segment of the video cassette with the tape counter that will help you easily locate the segment later.

• Some index marks that may be missed by the VCR:

- A mark too close to your location on the tape.
- The mark at the beginning of a recorded segment of five minutes or less.
- The first index mark on the tape when you start at the beginning of the tape.

- Press [SETUP] button and select "FUNCTIONS".

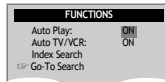

- The tape counter is displayed on the screen. Input the tape counter you want to go and press [REW] or [FF], the VCR will search for the time counter you want.



Marking a tape for zero search

- Use [PLAY], [REW] or [FF] to reach the point on the tape that you would like to mark as 0:00:00.
- Press [DISPLAY] button to display the tape counter on the screen.
- Press [CLEAR] button to reset the tape counter to 0:00:00.
- You can continue to play the tape or perform other functions with the VCR.

Display (O.S.D)

- Press [DISPLAY] button to display the tape counter, clock and status mode on the TV screen for a short time.
- And, by one more pressing [DISPLAY] button before disappearing the OSD from the screen, only the tape counter will remain on the screen.
- Press [DISPLAY] button the third time and the tape counter also disappears from the screen and to return to the original display.

Daylight-Saving Time

- Press [SETUP] button and select "CLOCK SET".

Move \leftarrow into "Auto DST" with \leftarrow .

- Press [ENTER] to switch between ON and OFF.

- Select ON if you want the VCR's clock to automatically adjust for daylight-saving time.
- Select OFF if you do not want the VCR's clock to adjust for daylight-saving time.

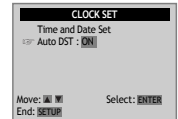

SPRING Forward ; Fall Backward

In the Spring, daylight-saving time begins on the first Sunday in April. Because the clock automatically changes from 2:00 AM to 3:00 AM (forward one hour), remember to include the extra hour for timer recording falling within this time frame.

In the Autumn, daylight-saving time ends on the last Sunday in October.

The VCR clock automatically changes from 2:00 AM to 1:00 AM (back one hour). Therefore, it can affect your recording length.

Changing the on-screen menu language

- You may select the language in which you would like the VCR's menu to be displayed: English, Spanish, or French.

- Press [SETUP] button and select "LANGUAGE SELECT".

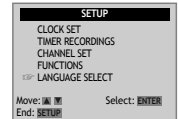

- Select the language among English, Spanish or French by pressing \leftarrow or \rightarrow buttons. Press [ENTER] to confirm your selection.



Hi-Fi Stereo Playback

Playing a tape in Hi-Fi high-quality

- Press the [AUDIO] button repeatedly to select among playback qualities.

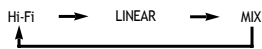

- "Hi-Fi" signal lights up at the top of a screen.
- If the Hi-Fi sound on the tape is not stable (background noise), select LINEAR to reduce them.

Forced Mono

- Programs are broadcasted in mono or stereo sound, or with a SAP.
- Press [AUDIO] repeatedly to select among STEREO, MONO and SAP.

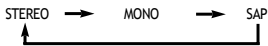

- In some cases, the receiving conditions may be poor when receiving stereo or SAP (Secondary Audio Programs) broadcasting. This may cause frequent interference or the volume may become uncontrollable.
- Press [AUDIO] in stereo or SAP mode to select mono sound. To return to stereo sound, either press the [AUDIO] button again or reselect the channel.

Recording Stereo or Secondary Audio Programs (SAP)

- When recording a stereo signal, the recording is in Hi-Fi mode.
- SAP is only available for areas with such station services.



- The following guidelines will help you decide on the best method for recording programs. Choose:
 - Select Stereo reception for normal recordings and for recording stereo broadcasting television.
 - Select Mono reception if the stereo signal is weak or when there is interference.
 - Select SAP reception to record a second audio program. An example of a SAP is a program that is broadcasted in English, but has a Spanish SAP.
- You can only record stereo and SAPs if the program is broadcasted in stereo or has SAP. Consult a television guide for program broadcasting information.

DVD initial setting

LANGUAGE Setup

- A user can set OSD language, Audio, Subtitle and Disc Menu.

- In STOP or RESUME STOP mode, press the [SETUP] button to display the DVD "SETUP" menu.

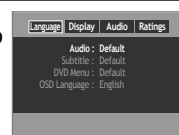

"OSD" means "On Screen Display".

- Select "Audio" by pressing [▲/▼] button.

Set it as the preferred audio language. In case the audio language is set and recorded in the DISC, it is automatically played in the set language in every playing.

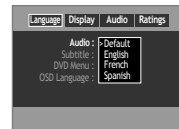

- Select "Subtitle" by pressing [▲/▼] button.

Please set it as the preferred language. In case the subtitle language is set and recorded in the DISC, it is automatically played in the set language in every playing.

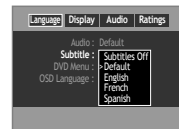

- Select "DVD Menu" by pressing [▲/▼] button.

Please set it as the preferred DISC MENU language. In case the DISC MENU language is set and recorded in the DISC, it is automatically played in the set language in every playing.



- Select "OSD Language" by pressing [▲/▼] button.

Please select a language to be displayed on DVD screen.



DISPLAY Setup

- A user can set up a connected TV condition and screen.

1 In STOP or RESUME STOP mode, press the [SETUP] button to display the DVD "SETUP" menu.

Press the [◀] or [▶] buttons to select "Display" from the top menu bar.



2 Select "Aspect Ratio" by pressing [▲/▼] button.

Press [ENTER] button to select the desired setting.

- If a user selects "Pan&Scan (4:3)", the user can watch only a center of the original scene of "16:9".
- If a user selects "LetterBox (4:3)", the user can watch the original scene of "16:9", but the top and bottom of the screen look black color.
- If a disc size is originally recorded in 4:3, a user cannot watch it in a wide screen though a user sets a size as "Widescreen (16:9)".



3 Select "Screen Saver" by pressing [▲/▼] button.

Press [ENTER] button to select the desired setting.

If bright scenes continue to be displayed in screen, TV can be damaged. Set the screensaver to "On", the screensaver functions automatically and DVD logo moves continuously if the resume stop, stop, open status is maintained for about 5 minutes.

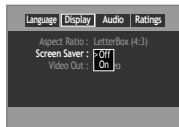

4 Select "Video Out" by pressing [▲/▼] button.

A user may select a "Video Out" among Progressive, Component and S-Video.



 The change of "Video Out" for Component or S-Video need user to change the TV Format fitly.

CONSUMERS SHOULD NOTE THAT NOT ALL HIGH DEFINITION TELEVISION SETS ARE FULLY COMPATIBLE WITH THIS PRODUCT AND MAY CAUSE ARTIFACTS TO BE DISPLAYED IN THE PICTURE. IN CASE OF 525 PROGRESSIVE SCAN PICTURE PROBLEMS, IT IS RECOMMENDED THAT THE USER SWITCH THE CONNECTION TO THE "STANDARD DEFINITION" OUTPUT. IF THERE ARE QUESTIONS REGARDING OUR TV SET COMPATIBILITY WITH THIS MODEL 525p DVD PLAYER, PLEASE CONTACT OUR CUSTOMER SERVICE CENTER.

AUDIO Setup

- A user may select audio menu according to a user's speaker set.

1 In STOP or RESUME STOP mode, press the [SETUP] button to display the DVD "SETUP" menu.

Press the [◀] or [▶] buttons to select "Audio" from the top menu bar.

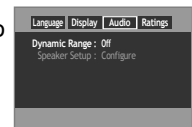

2 To adjust volume range, select "Dynamic Range" from the "Audio" menu using the [▲] or [▼] buttons.

Press [ENTER] to display Dynamic Range options.

- Off : The volume range is the same as what is recorded on the disc (default).
- On : The volume range is compressed to make loud sound softer and soft sound louder.

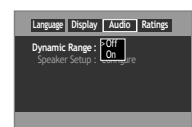

3 Select "Speaker Setup" by pressing [▲/▼] button.

Press [ENTER] button to enter into Speaker Setup screen.

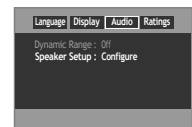

4 To select among the speakers (LEFT, CENTER, RIGHT, L.SURR., SUB.W and R.SURR), press the [▲], [▼], [◀], or [▶] buttons.



5 To adjust the Level setting for the speaker you have selected above, press the [◀◀] or [▶▶] buttons.

To adjust the Delay setting for the speaker you have selected above, press the [◀◀◀] or [▶▶▶] buttons.

Note: For additional speaker setting information, refer to "Speaker Setup" on page 56.



 Do not adjust Speaker Type settings if you are using the speakers provided with this unit. Adjust the speaker settings only if you have upgraded your speakers.

RATINGS Setup

- Parental Control restricts the type of discs that can be played on the DVD/VCR according to their ratings. Discs that do not fall within the rating limits can not be played unless the rating password is entered.

1 In STOP or RESUME STOP mode, press the [SETUP] button to display the DVD "SETUP" menu.

Press the [◀] or [▶] buttons to select "Ratings" from the top menu bar. The Ratings menu is displayed.

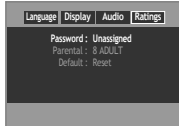

2 To enter a password for ratings setup, press the [▲] or [▼] buttons to select "Password" from the Ratings menu and press [ENTER].

Enter a NEW password screen appears. Enter a 4 digit password with the number buttons on the remote control. You will be prompted to enter your new password again for confirmation.



3 To setup rating limits, select "Parental" from the Ratings menu by pressing the [▲] or [▼] buttons.

Press the [ENTER] button. You will be asked to enter the password if a password has been assigned.

The rating list appears on the screen. There are 8 rating levels: from 1 (suitable for general audience) to 8 (for mature audience only).

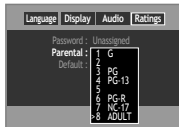
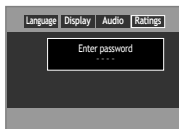

4 Press [▲] or [▼] buttons to move the cursor to the rating level where you find is acceptable. A password is required to play discs with ratings higher then the level selected.

5 To return to DVD settings, select Default from the Ratings menu by pressing the [▲] or [▼] buttons and select Reset.

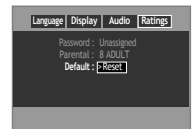

The initial password is 3308. In case you forget newly-input password, you can use 3308 as a password.

"Parental Lock" can only be activated if:

- A password has been set and the unit is in Lock mode.
- the disc has a rating assigned.

DVD Playback



1 Press [⏻] button to power on.
Press [DVD] button to select DVD mode.

2 Press [OPEN/CLOSE] button to open the disc tray.
Place a disc firmly on the disc tray, making its label look upward.
Insert the disc and press [OPEN/CLOSE] button to close the tray.
The disc tray is closed and after checking the disc's condition, Playback or Stop function starts to operate.

3 To playback it, press [PLAY/PAUSE] button.

- In the case of DVD,
DVD menus and titles are displayed on TV screen.
- In the case of S-VCD and VCD2.0,
the menus are displayed on TV screen and it is converted into PBC (Playback Back Control) mode.
- In the case of CD, VCD1.1 and MP3,
the disc plays in order of its track numbers.



4 To stop it, press [■] button.
For pause, press [PLAY/PAUSE] button in playback mode.
If you press this button once more, it starts playback again.

5 Press [OPEN/CLOSE] button to remove the disc.

Various Playback Methods

- If you want fast (or reverse) playback, press [▶▶] or [◀◀] button in Playback mode. You can watch fast playing (reverse) screen.
** This reverse playback can be unavailable for certain DVD. Unavailable for MP3.*
- If you want slow (or reverse) playback, press [▶▶] or [◀◀] button in Playback mode. You can watch the desired screen in the slow forward (reverse) playback.
** For the case of Video CD, this reverse slow playback function is unavailable. The Ⓞ mark will appear.*
- If you want forward step playback, press [▶▶] button in Pause mode.
** The reverse step playback function is unavailable.*
- If you want still picture, press [PAUSE] button in Playback mode. You can watch the desired screen in Pause status.

Playing a desired scene

Playing a desired scene

To skip scenes in a disc

DVD, VCD, VCD2.0, CD, MP3

To move to next chapter (or track), press [NEXT▶▶▶] button.
The current chapter (or track) moves to the next chapter (or track).

Press [◀◀PREV] button.

The current scene moves to the previous chapter (or track) or first scene of current chapter (or track).

Directly moving to a desired title

DVD

- Some movie discs may contain multiple titles. If the disc has a movie title menu recorded on it, the [TITLE] button can be used to select the movie title. Details of operation may differ depending on the disc used.

* Selecting a title may not be available on certain DVD discs.

1 Press the [TITLE/PBC] or [MENU] button.

A list of the titles on the disc is displayed.
For the case of VCD disc, menu screen will appear only when the disc has PBC function and PBC ON is activated.



2 Press the [ENTER] button or [PLAY] button after pressing the [▲▼◀▶] button to select the desired title.



The selected title now starts playing.



Playing a programmed order

DVD, VCD, CD

1 In stop mode, press the [PROGRAM] button.

The CD Playlist screen appears. Use the [▲] or [▼] buttons to move the cursor to the track you want to add to the playlist.

Press the [ENTER] button to add it to the Playlist. The track will be displayed on the bottom right box.

Press the [◀] or [▶] buttons to select "Play" and press [ENTER] to begin program playback. Press the [◀] or [▶] buttons to select "Clear All" and press [ENTER] to clear CD Playlist.



2 After completing setting, press [PLAY] button.

Then, titles and chapters (track) are played in the above-programmed order.
To exit from Program Play mode, press the [SETUP] button in Program menu screen.

Repeating a defined period

DVD, VCD, CD

Press the [REPEAT] button in playback mode and select the repeat period by using the [▲▼] buttons.

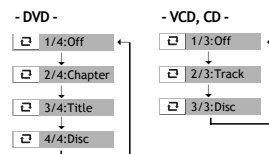

- Chapter : Current chapter will be repeatedly playback.
- Title : Current title will be repeatedly playback.
- Track : Current track will be repeatedly playback.
- Disc : Current disc will be repeatedly playback.
- Off : Repeat playback will be cancelled.

Playing a desired scene

Repeating a defined period from A to B

DVD, VCD, CD

- You may repeat a defined period from A to B.

- At the point where you want to start the repeat playback, press [A-B] button.

The right figure appears and repeat playback start position (A) is set.



- At the point where you want to end the repeat playback, press [A-B] button again.

The repeat playback end position (B) is set and a defined period from A to B is playback repeatedly.



- To exit from repeat playback mode, press [A-B] button. It enters into Normal Playback mode.

A MP3 disc may not be repeated from A to B.

Searching DVD with a title number, a chapter number or a time

DVD

- Press [SEARCH] button.

It shows the title numbers, chapter numbers and the duration of the DISC.

If you want to search with a title number,

please enter the new title number to be searched using the [NUMBER] or [▲/▼] buttons.

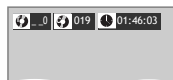

- If you want to search with a chapter number,

please select the "Chapter window" with [◀/▶] buttons and enter the new chapter number to be searched using the [NUMBER] or [▲/▼] buttons.



- If you want to search with a time,

please select the "Time window" with [◀/▶] buttons and enter the new time number to be searched using the [NUMBER] buttons.



- In completing entering, please press [ENTER] button. PLAY starts from the selected position.

Playing a desired scene

Searching VCD and CD with a track number or time

VCD, CD

- Press [SEARCH] button.

It shows the track numbers and times.

If you want to search with a track number,

please enter the new track number to be searched using the [NUMBER] or [▲/▼] button.



- If you want to search with a time,

please select the "Time window" with [◀/▶] buttons and enter the new time number to be searched using the [NUMBER] buttons.



- In completing entering, please press [SEARCH] button. PLAY starts from the selected position.

Selecting Video Output

Press the [PROGRESSIVE] button on the remote control for 3 seconds to select "Video Output" format.

S-Video → Component → Progressive → ..

Confirming the current PLAY mode on screen

Confirming the current PLAY mode on screen

Confirming the current DVD disc mode

DVD

1 During playback, press [DISPLAY] button.
It shows the current title, current chapter and time elapsed.



2 Press [DISPLAY] button again.
It shows the audio selected.



3 Press [DISPLAY] button again.
It shows the subtitle selected and repeat playback mode.
To exit from Display mode, press [DISPLAY] button again.



Confirming the current MP3 disc mode

MP3

The track list appears automatically in Playback mode.

It shows the MP3 File information in disc, the directory, MP3 File name and directory list.

With [▲▼▶◀] buttons, you can move the cursor to MP3 Music File. To playback MP3 File, press [ENTER] key.



Confirming the current VCD, CD disc mode

VCD, CD

During playback, press [DISPLAY] button.
It shows the current track, audio selected, repeat playback mode and time elapsed.
To exit from Display mode, press [DISPLAY] button again.



AUDIO, SUBTITLE language and Sound Fields

- The user may select an audio language and subtitle language if a disc includes Multi-language.

Selecting an audio language

DVD

 A certain disc may not support audio select or subtitle select.

Press the [AUDIO] button. It shows the audio information DVD disc includes.

The user can select each audio information by using [▲▼] buttons. In completing selecting, please press [AUDIO] button one more.

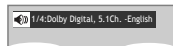

Selecting a subtitle language

DVD

Press [SUBTITLE] button. It shows the subtitle information DVD disc includes.

The user can select each subtitle information by using [▲▼] buttons. In completing selecting, please press [SUBTITLE] button one more.

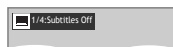

Selecting Sound Fields

- Sound Fields and Graphics Equalizer can be set.

Each time you press [SOUND FIELD] button in playback mode, sound fields can be set as below.

DVD mode/VCR mode/RADIO mode

OFF → MOVIE → MUSIC → PROLOGIC II → MATRIX → CLASSIC → HALL → THEATER → OFF..

This function is not available to a DVD disc supporting 5.1 Audio channel & DTS.

This function may be unavailable to some VCD or CD.

ZOOM and Multi Angle

Using a zoom function

DVD, VCD

- A picture can be magnified by about 2, 4 or 8 times the actual size.

While playback or still mode, press [ZOOM] button till the right figure appears.

Every time the user presses [ZOOM] button, a zoom magnification changes 2 times (X2) → 4 times (X4) → 8 times (X8) → OFF → 2 times (X2) ... one by one.

A base point to be enlarged is center and the point can be changed with the operation of [▲▼◀▶] button.



Multiple Angle

DVD

- If a disc includes multi angle information, the user can watch a screen in multi-angles. The function is limited to a DVD disc supporting multi-angle information.

Press [ANGLE] button. It shows multi angle information DVD disc includes.

The user can select each angle information by using [▲▼] buttons. In completing selecting, please press [ANGLE] button one more.

If this feature is not available on the DVD disc, "Not available" is displayed.

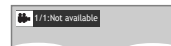

About MP3 discs

Playing a disc containing MP3 files

MP3

This unit will play MP3 files recorded on CD-R and CD-RW discs.

- 1 Turn on your television and select the channel assigned to this DVD player.
- 2 Press the DVD open [OPEN/CLOSE] button, the disc tray opens.
- 3 Put a disc containing MP3 files on the disc tray with the label side up.
- 4 Press the DVD open [OPEN/CLOSE] button, the disc tray closes.
- 5 The unit will take a short while to load the disc and display the directory structure.
- 6 Press the [▲▼] navigation buttons of the remote control to select the file you want to listen to, then press the [ENTER] button and this selected file is located and played back.

■ Play and Pause

Press the [PLAY/PAUSE] button to switch between play and pause.

■ Search for a track

The [SEARCH] button works on MP3 discs as well as CD audio.

■ To stop playback

Press the [STOP ■] button.

■ To skip to the next or previous file

- Press the [NEXT ►►] button of the remote control briefly while playing, to skip ahead to the beginning of the next file. Each time you press the button consecutively, the beginning of the next file is located and played back.
- Press the [PREV ◀◀] button of the remote control briefly while playing, to skip back to the beginning of the previous file. Each time you press the button consecutively, the beginning of the previous file is located and played back.



The ability of this unit to read MP3 discs is dependent on the followings:

- The Bit Rate must be within 8-352 kbps and VBR.
- File names must incorporate the "MP3" file extension. EXAMPLE: *****.MP3 where each * is a letter or number.
- Use only alphabet and (/ or) numbers in file names. If you use special characters, the file and / or folder names may not be displayed correctly on the on-screen display.
- This unit can read the maximum 999 files and folder.
- The sampling frequency must be within 4kHz-48kHz.

The ability of this unit to read JPG discs is dependent on the followings:

- File names must incorporate the "JPG" file extension. EXAMPLE: *****.JPG where each * is a letter or number.
- Use only alphabet and (/ or) numbers in file names. If you use special characters, the file and / or folder names may not be displayed correctly on the on-screen display.
- This unit can read the maximum 999 images in a disc.
- This unit can't read the file formed Progressive JPG format.

Displaying menu in a disc

To display menu in a disc

DVD, VCD2.0

- If a disc includes menu, the user may use it.

1

Press [TITLE/PBC] or [MENU] button.

- It shows menus in the disc. Also they are different according to discs.
- If it is a VCD2.0, select PBC ON mode by pressing [TITLE/PBC] button.

* This function is not available for CD and VCD1.1.

2

Move the cursor to the desired item with arrow buttons of [▲▼▶◀] and select one with [ENTER] button or [PLAY] button.

Recording

Recording

To Record With VCR



- 1 Press [⏻] button to power on.**
 - Press [VCR] button of remote control to change into VCR mode.
 - Power on TV and select Ch 3, or press [INPUT] button of TV set to select External Input mode.
- 2 Insert a recordable tape.**

Insert a tape with safety tab.
- 3 With [CHANNEL], [NUMBER] and [INPUT] buttons, select the desired broadcasting channel or external input unit to record.**
- 4 Select the desired speed (SP or SLP) with [SPEED] button.**
- 5 Press [REC] button.**

Then, it starts recording.
- 6 If you want to pause recording, press [PAUSE] button.**

After pressing [PAUSE] button, if the pause status continues for five minutes, the recording is released automatically.
- 7 To exit recording, press [STOP] button.**

To Enjoy Another TV Channel or DVD during recording

- 1 If you want to watch another TV channel during recording with video, press [TV/VCR] button.**

It is available of changing into and watching another TV channel by pressing TV [CHANNEL] buttons.
- 2 If you want to playback DVD during recording with video, insert a DVD disc.**

Place the desired DVD disc on DVD tray, press [DVD] button to convert OUTPUT into DVD mode and press [PLAY] button. Then, you can watch DVD.

To Record From DVD To Videotape during DVD playback

- 1 Press [DVD] button of remote control to change into DVD mode.**

Insert the desired DVD disc.
When it is a DVD disc with copy protect function, you can't copy it.
Insert a recordable tape.
- 2 Play the DVD disc and press [REC] button.**

DVD plays and VCR starts recording.
- 3 To exit copy, press [■] button.**

Also it stops automatically when DVD playback is finished or recorded tape is reached to the end.

 You can't copy in case of DTS audio mode of disc. Change it to "Dolby Digital" or "ZCH" mode if you want to copy.

This product incorporates copyright protection technology that is protected by method claims of certain U.S. patents and other intellectual property rights owned by Macrovision Corporation and other rights owners. Use of this copyright protection technology must be authorized by Macrovision Corporation, and is intended for home and other limited viewing uses only unless otherwise authorized by Macrovision Corporation. Reverse engineering or disassembly is prohibited.

One Touch timer Recording (OTR)

- When your urgent business happens suddenly in watching TV or you want to record the current TV program for the desired time, follow the procedures below.
- 1** First, follow the steps 1 to 4 in "Recording With VCR".
 - 2** Press [REC] button as much as you want. See the "Recording Times Table" below.

Once	continuous recording until you press [STOP] button
Twice	recording for 30 mins from current time
3 (times)	recording for 1 hour
.
9	recording for 4 hours
10	returning to the status of Once Press
 - 3** To stop Recording mode, press [STOP] button more than 5 seconds.

Recording

Timer Recordings

TIMER RECORDINGS

- Turn on the TV.
- Make sure that current time is set correctly.
- Insert a recordable tape with safety tab.
- Prior to the setting, press [VCR] button to change to VCR mode.

1 Press [SETUP] button and select "TIMER RECORDINGS".
Move into "TIMER RECORDINGS" with [▼] and then, select the desired one with [ENTER] button.

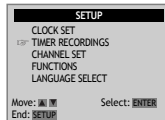

2 Select "Make a New Program".
Press [ENTER] button to select "Make a new Program".



3 Select "Timer Recording method".
Move into desired recording type with [▼] and then, select the desired one with [ENTER] button.

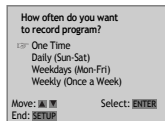

For Timer Recording method details, see "Various TIMER REC" in the page 48.

4 Select "a broadcasting to record".
Select the desired broadcasting channel with [NUMBER] buttons.

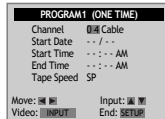

**If Converter Box and video are connected to Video/Audio terminal, set "EXTERNAL INPUT" on TIMER REC CH by using [INPUT] button.

When moves into "Cable", select one of "Cable"/"Antenna" with [▼] or [▲] button.

5 Set "the date and time to record".
Select the date, start time and end time to record with [NUMBER] buttons.

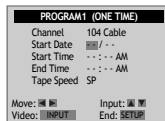

For correct operation of TIMER RECORDING, the unit should be turned off or turned on DVD mode.

6 Set proper "RECORDING SPEED".
Select one of SP/SLP with [▼] or [▲] button.
For more information on recording speed, see "Using video cassette" in the page 48.

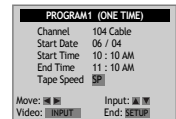

7 Press [SETUP] button to complete the setting.

"Program # has been saved. For program recording, insert a cassette...." message is displayed.

On the reserved time, TIMER RECORDINGS starts to operate.

Stopping a Timer Recording

To stop or cancel a timer recording in progress (even an One Touch Recording) : Press and hold the button for several seconds until STOP appears in the on-screen display.

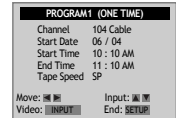

PROGRAM 1 has been saved.
For program recording, insert a cassette.

End: [SETUP]

To Confirm or Cancel TIMER RECORDINGS

1 Select "Review/Cancel Programs".



2 Confirm reservation-recording details in turn with [▼] or [▲] button and then, press [CLEAR] button on the position of the details to delete.

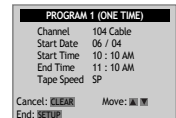

Timer Program Setting

Press [PROGRAM] button in VCR mode.

You can set the Timer Program.

Before timer program setting, clock should be set correctly and video mode should be selected.

Various TIMER RECORDINGS

One Time: It is available of TIMER RECORDINGS at the desired specified time.

Daily: Once you set TIMER RECORDINGS of the desired program telecasted at the same time day after day, it is available of daily recordings. It is available of TIMER RECORDINGS from Sunday to Saturday.

Weekday: It is similar to Daily TIMER RECORDINGS, but this TIMER RECORDINGS is available from Monday to Friday.

Weekly: Once you select one day of the week, it is available of TIMER RECORDINGS in the same day weekly.

Using video cassettes

Before you play or record on a video cassette tape, be certain to read this information on the proper care and use of video cassettes.

Only use video cassettes that bear the VHS mark: .

There are four types of video cassettes: T-60, T-90, T-120 and T-160. The amount you can record on a tape is dependent upon the tape speed at which you record. The table below lists the recording time (hours:minutes) for each tape type according to recording speed.

Tape Type	SP Mode (Standard Play)	SLP Mode (Extended Play)
T-60	1:00	3:00
T-90	1:30	4:30
T-120	2:00	6:00
T-160	2:40	8:00



Protecting video cassettes from accidental erasure

Cassettes have a safety tab to prevent erasure. Break off the safety tab with a screw driver. If you wish to record on a cassette without a safety tab, cover the hole with cellophane tape.

Inserting video cassettes

Firmly insert the cassette into the cassette compartment with the label up. An inverted cassette cannot be inserted.

Removing video cassettes

Press [EJECT] on the front panel and the VCR will eject the tape. Pull the cassette out gently.



- Audio-visual material may include works of copyright which must not be recorded without authorization of the copyright owner.
- After setting the timer recording program, if you insert a video cassette without a safety tab into the unit: In power on mode, the unit will playback automatically. ("REC IN ADV" will be scrolled on the display panel 3 times per 2 minutes.) In power off mode, the unit will automatically eject the cassette.
- After setting the timer recording program, if you insert a video cassette with a safety tab into the unit: In power on mode, "REC IN ADV" will be scrolled on the display panel 3 times per 2 minutes. In power off mode, the unit will enter stand-by mode.
- Do not attempt to pull out the video cassette once the unit begins to load the video cassette.
- Do not insert fingers or any foreign object beyond the door flaps of the cassette compartment; this could lead to injury or equipment damage.
- Do not attempt to insert a video cassette if the unit is unplugged.

Watching and Recording Cable TV

To Watch and Record Promptly Cable TV

- 1 **Power on converter and then**, set a channel to watch or to record.
Power on DVD-video and then, set the channel of DVD-video to the converter-connected channel (one of CH03/04/EXTERNAL INPUT).
Power on TV and then, set the video-connected channel (one of CH03/04/VCR).

- 2 **Simultaneous Recording and Watching**
At this time, CH selected by the converter is displayed on TV screen. Simultaneously, press [REC] button of DVD-Video to record the CH selected by the converter, and press [REC] button more than two times to set on One Touch timer Recording (OTR).

TIMER RECORDINGS of Cable TV

- 1 **Reserve VCR.**
According to TIMER REC procedures, select TIMER RECORDINGS SET window and complete the settings. At this time, the video channel should be input in CH3 (or CH4, EXTERNAL INPUT) of the converter-connected channel. Enter date and time of the cable program for TIMER RECORDINGS.

- 2 **Adjust Converter.**
Set converter to the cable TV channel to record.
e.g.) To record CH48,
Display CH48 with CONVERTER CHANNEL SELECT button.
If there is TIMER REC function of converter, it is available of reservation.

- 3 **Complete Reservation.**
If you power on converter, video powers on automatically and starts recording at the reserved time.
**Home watching cable TV is unavailable of simultaneous recording function (while recording NBC program, watching CNN program). (Owing to mechanical features of converter, it is unavailable of simultaneous reception of two channels.)

Presetting the radio stations

- You can preset 50 stations for FM and AM. Before tuning, make sure that you have turned down the volume to the minimum.

- 1** Press [FM/AM] button until the FM or AM appears in the display window.
And then every time you press [FM/AM] button, FM and AM changes alternately.
- 2** Press and hold [TUNING -/+] button for about two seconds until the frequency indication starts to change, then release.
Scanning stops when the DVD Receiver tunes in a station.
- 3** Press [MEMORY] button.
A preset number will display in the display window.
- 4** Press [PRESET -/+] button to select the preset number you want.
- 5** Press [MEMORY] button again.
The station is stored.

.....

To tune in a station with a weak signal

Press [TUNING -/+] button repeatedly in step 2 to tune in the station manually.

To clear all the memorized stations

Press and hold [MEMORY] button for about three seconds and "CLEAR ALL" appears in the display window and then press [MEMORY] button again, the preset stations will be cleared.

Listening to the radio

- Preset radio stations in the DVD receiver's memory first (see "Presetting radio stations" on the previous page).

- 1** Press [FM/AM] button until AM or FM appears in the display window.
The last received station is tuned in.
- 2** Press [PRESET - or +] button repeatedly to select the preset station you want.
Each time you press the button, the DVD receiver tunes in one preset station at a time.
- 3** Adjust the volume by rotating VOLUME on the front panel or pressing [VOL-] or [VOL +] button repeatedly.

.....

To turn off the radio

Press [POWER] to turn the unit off or select another function mode (DVD, VCR, VIDEO 1 or VIDEO 2).

To listen to non-preset radio stations

- Use manual or automatic tuning in step 2.
- For manual tuning, press [TUNING] button repeatedly.
- For automatic tuning, press and hold [TUNING] button for about two seconds.

Speaker Setup for enjoying the surround sound effect

Surround Sound Audio Components

DTS Digital Surround, Dolby Digital and Dolby Pro Logic technologies can be used to enjoy 3-dimensional sound effects with video image. We recommend you use the following devices.

- Hi-Fi Stereo VCR to play the program sources.
- Large screen TV monitor for a high-quality video image.
- Use the program sources (e.g. LD, DVD, VIDEO TAPE etc.) labeled with DTS Digital Surround or Dolby Digital Surround or Dolby Pro Logic Surround.

Manufactured under license from Dolby Laboratories. "Dolby", "Pro Logic", and the double-D symbol are trademarks of Dolby Laboratories. Confidential Unpublished works. Copyright 1992-1997 Dolby Laboratories. All rights reserved.

Manufactured under license from Digital Theater Systems, Inc. US Pat. No. 5,451,942 and other worldwide patents issued and pending. "DTS" and "DTS Digital Surround" are trademarks of Digital Theater Systems, Inc. Copyright 1996 Digital Theater Systems, Inc. All rights reserved.

Room features affecting sound

If the room is made of concrete and hard materials like wood walls, you will not hear the ultimate surround effects. The walls of the room must have the appropriate absorption factor and be able to "reflect" the sound for the proper effect. If the room has too much sound reflection, try repositioning the furniture. You may also need to hang curtains etc. to absorb more of the sound - experiment with the room's acoustics.

Speaker Setup for enjoying the surround sound effect

Speaker Positioning

A typical speaker setup uses 6 speakers: 2 front speakers, a center speaker, 2 rear speakers, and a subwoofer. Add a sub-woofer to hear excellent bass sound, DTS digital surround or Dolby Digital surround. Set up a listening position; a couch or chairs, etc. as shown in the speaker positioning example.

- **Front speakers**
We recommend that the height of the tweeters of the front speakers be at the same height as the listener's ears, to the left and right of the TV. See speaker positioning example for speaker placement.
- **Center speaker**
Ideally, the center speaker and front speakers would be positioned at the same height. Place the center speaker above or below the television.
- **Rear speakers (Surround)**
Place left and right surround speakers behind the listening area. These speakers help recreate sound motion and atmosphere; required for surround playback. For optimum sound effects, do not place the rear speakers too far behind the listening position. Install them at or above the height of the listener's ears. It is also effective to point the rear speakers toward a wall or ceiling, to further disperse the sound.
If the room is small and the listeners area is near the rear wall, set the rear speakers opposite each other about 2 - 3 feet higher than the listeners' ears.
- **Subwoofer**
Place it an appropriate position. (See speaker positioning example.)

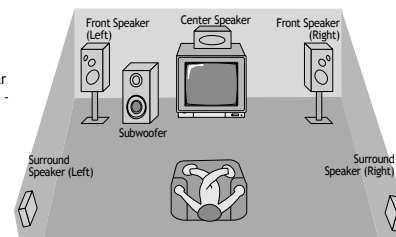

Speaker Positioning Example

Notes

- We recommend that you use magnetic shielded speakers for the front left/right speakers and center speaker to prevent video noise from appearing on the TV picture.
- Use speakers in your setup that have similar tonal characteristics.

Delay Time Setting

- In Dolby Digital or Dolby Pro Logic mode it is assumed that the time it takes the sound from each speaker to reach the listener, is the same. But if the time interval from the center or rear left and right speakers to the listener is closer than the time interval from the listener to the front left and right speaker, the sound of center or rear left and right speaker will reach the listener first; instead of the sound of the front speakers. (It is desirable that the sound from the front speakers reach the listener first.)

Dolby Digital and Dolby Pro Logic modes provide speaker time delay adjustments to resolve this problem; you can manually set the delay time of the center or rear left and right speakers so that the sound from all speakers will arrive simultaneously to the listener.

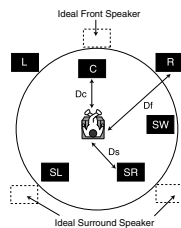

Delay Time Setting

The interval from the speakers to the listener. If the distance from the listener to each speaker is the same in the Dolby Digital and Dolby Pro Logic mode, the delay time of each speaker is as follows.

In Dolby Digital mode

Center delay time : 0ms, Rear delay time: 5ms

In Dolby Pro Logic mode

Center delay time : (no setting), Rear delay time : 15-30ms

If the rear delay time is set in Dolby Digital mode, in the Dolby Pro Logic mode the delay time will be set automatically. The delay time is 1 msec per foot.

If the center and rear speakers are further than the front speakers from the listener, the delay time will be set at minimum.

Surround delay time setting

If the distance of DS is equal to or longer than the DF in the left figure, set the Surround Delay Time as 0ms. Otherwise, change the setting according to the specifications below.

- Ex) If the distance from front speakers to the listener is 10 ft. and from rear speakers from the listener is 5 ft., in the Dolby Digital mode the rear delay time is 5 msec.
- 10 ft. (DF) - 5 ft. (DS) = 5 ft. (B)
 - 5 ft. (B) = 5 ft. / 1 ft. = 5msec

Center delay time setting (Dolby Digital mode only)

If the distance of DF is equal to the distance of DC in the left figure, set the Center Delay Time as 0ms. Otherwise, change the setting according to the specifications below.

- Ex) If the distance from the front speakers to the listener is 10 ft. and from the center speaker to the listener is 8 ft., the center delay time is 2msec.
- 10 ft. (DF) - 8 ft. (DC) = 2 ft. (A)
 - 2 ft. (A) / 1 ft. = 2msec

Setting the delay time in the Dolby Digital and Dolby Pro Logic modes

- 1 Press [DELAY] button.
The current surround delay time appears in the display window.
- 2 Press the [DELAY] button to select the desired speaker to set.
Each time you press the [DELAY] button, it changes in the following order:
FL (Front Left) → CT (Center) → FR (Front Right) → SL (Surround Left) → SR (Surround Right)
- 3 Press the [▲ or ▼] buttons to change the delay time.
- 4 Repeat steps 2-3 to adjust the sound Delay of the other channels.

Setting the sound level

Setting the sound level

Setting the sound level of the desired channel

To adjust the volume of all the speakers at one time :
Use the **VOLUME** control.

- 1** Press [LEVEL] button.
The LEVEL indicator will appear in the display window.
- 2** Press [LEVEL] button to select a desired speaker to set.
Each time you press the [LEVEL] button, it changes in the following order;
FL (Front Left) → CT (Center) → FR (Front Right) → SL (Surround Left) → SR (Surround Right) → WF (Subwoofer) → FL (Front Left)...
- 3** Press [▲ / ▼] button to adjust the sound level of the selected channel.
- 4** Repeat step 2-3 and adjust the sound level of the other channels.
- 5** If setting is complete, press [LEVEL] button.
According to adjustment the sound level, the maximum sound volume varies as below.

LEVEL	Sound Volume
7.5	42
6.5-7.0	43
5.5-6.0	44
4.5-5.0	45
3.5-4.0	46

LEVEL	Sound Volume
2.5-3.0	47
1.5-2.0	48
0.5-1.0	49
-7.5-0	50

In case of Configure 2 or 3, it is impossible to adjust the Level setting for the Woofer (WF).

Speaker Setup	Default	Configure1	Configure2	Configure3
CT (Center)	Small	Large	Small	Small
FL (Front Left)	Small	Large	Large	Large
FR (Front Right)	Small	Large	Large	Large
SL (Surround Left)	Small	Large	Small	Large
SR (Surround Right)	Small	Large	Small	Large
WF (SubWoofer)	Provided	---	Off	Off

- Small : Speaker applied with high-pass filter
- Large : Speaker applied without high-pass filter

The provided speakers are "small" type. Under the condition of the "Large" type speaker setup, the "small" speakers will be exposed to damage.

Setting the Balance between each channel by using the test tone

This Test Tone function is unavailable in a state of No Disc.

- In Dolby Digital and Dolby Pro Logic mode by using the test tone function you can easily adjust the sound balance of the speakers from the listener's position in DVD initial setup mode. (speaker setup)

- 1** Select the test tone mode by pressing [▶/||] button.
A hiss noise comes out for 2 seconds from each speakers in the following order;
FL (Front Left) → CT (Center) → FR (Front Right) → SL (Surround Left) → WF (Subwoofer) → SR (Surround Right) → ...



- 2** Adjust the sound level the same way as described in "Setting the sound level of the desired channel" above, so that all the speaker's sound level is same from the listener's position.
During operating the test tone, if you adjust the sound level, it will be paused in the current speaker channel.

About DVD

Playable Disc

• DVD, Video CD (Version 1.1, 2.0), S-VCD and Audio CD

Disc type	Playable	Restriction
DVD	Possible	Region number 4 or Region number All (DVD-5, DVD-9, DVD-10, DVD-18)
Video CD	Possible	Version 1.0/1.1/2.0, SVCD/CVD
CD	Possible	PCM /SACD
CD-G	Possible	Only Audio playback
CD-ROM	Possible	MP3 File, JPG File
CD-R	Possible	Video-CD/CD/CD-ROM (MP3 File)
CD-RW	Possible	Video-CD/CD/CD-ROM (MP3 File)
DVD-R	Possible	DVD Video
DVD-RW	Possible	DVD Video
DVD+RW	Possible	DVD Video
DVD-ROM	Impossible	
DVD-RAM	Impossible	

REGION MANAGEMENT INFORMATION

This unit is designed and manufactured to respond to the Region Management information that is recorded on a DVD disc. The region number of this player is "4". If the region number described on the DVD discs does not correspond to the Region number of this player, the player will not play this disc. This player will play DVD discs made for "ALL" regions. Therefore, this player will play DVD discs marked with labels containing the region number "4" or "ALL".



(Region 4)



(Region ALL)

Terms related with DVD

DVD	A DVD (abbreviation of Digital Versatile Disc or Digital Video Disc) can include 135 minutes of video information. And for audio, it can hold up to 8 kinds of languages and 32 kinds of subtitle languages. By using MPEG-2 video compression and digital 3D surround sound, DVD realizes high-defined screen and quality sound like a movie theater.
CDDA	A CDDA (abbreviation of Compact disc digital audio) is a music disc that is currently used.
MP3	Audio compression format that enables audio files to be stored and transferred on a computer with a relatively small file size. It enables you to enjoy CD quality music. (Short for MPEG-1 Layer 3)
PBC	This is recorded on a Video CD 2.0, Video CD 3.0, SVCD and CVD. The scenes or information to be viewed (or listened to) can be selected interactively with the TV monitor by looking at the menu shown on the TV monitor. It stands for PlayBack Control.

58

CHAPTER	It means the information recorded in a DVD. A title in a DVD is divided into many tracks, of which a track is called as a chapter. A certain scene of a screen can be quickly searched with the chapter number.
TITLE	It means the information recorded in a DVD. A DVD can be divided into may titles.
TRACK	It means the information recorded in a video CD and audio CD. A disc consists of many a track, for which a user can search a certain position.
dts	Digital Theater System is a 5.1 -channel surround sound system, which is widely used in movie theaters around the world. It enables the bit rate to be increased to provide good sound quality. "DTS" and "DTS Digital Out" are trademarks of Digital Theater Systems, Inc.
Multi Angle	Some DVD discs contain the various scenes that have been simultaneously shot from a number of different angles.
PCM	Linear PCM is a signal-recording format used in a CD, while CD is recorded in 44.1kHz/16bit, a DVD is recorded in 48kHz/16bit up to 96kHz/24bit.
Dolby Digital	Dolby Digital enables the delivery of mono through 5.1-channel audio at data rates from 32 kbps to 640 kbps, thus offering flexibility and economical performance as well as uncompromised sound quality.
Bitstream	Digital audio data that is decoded into an analog signal for subsequent output to speakers.
L/Rt	It indicates L/R of Dolby Digital 2CH Downmix output.
Downmix	DOWNMIX is reproducing the proper audio when audio format recorded on a disc differs from the output audio channel configuration. For example, with just one stereo speaker system you can hear full 5.1 channel audio.
S-VIDEO	The S-VIDEO output separates the color (C) and luminance (Y) signals before transmitting them to the TV set in order to achieve a sharper picture. So this must be selected from the menu to enable the S-VIDEO output to function.
COMPONENT	It is called color difference signal and is a technology to divide and transmit a color signal (C) into B-Y (Pb) and R-Y (Pr) color difference signal. This technology supplies clearer and more vivid picture than composite video type .

Handling Disc

- To keep a disc clean condition, please do not touch a side containing play information.
- Do not attach a bit of paper or sticky tape on it.
- Do not expose a disc to a direct sunlight or electric heating systems.
- After using it, please keep a disc in a case.



Cleaning Disc

- Before using it, please rub it from center toward outside with clean clothes.
- Do not use any type of solvent such as thinner, benzol (benzene), commercial cleaning goods or antistatic sprays.



59

Basic information about VCR and Videotape

Terms related with VCR

AFT	Automatic fine tuning, a circuit that automatically adjusts TV reception to optimum condition.
CABLE	Cable television.
Index Search	A feature of this VCR that automatically records an index each time recording begins. It helps you locate a particular segment of the tape quickly and easily.
SLP	Super Long Play, an intermediate tape recording speed that combines most of the picture/audio quality obtainable at the standard recording speed with some of the tape economy of Extended Play.
OSD	On-screen display of information pertinent to the features of the VCR.
OTR	One-touch recording, a feature that allows you to record the program you're watching by pressing the REC key. Each press of the key increases the recording time by 30 minutes, up to four hours.
RF	Radio frequency, the composite audio/video signal supplied to a TV receiver (or other video component) by an antenna or cable system.
Safety tab	The plastic tab at the back of a video tape cassette which, when removed, prevents accidental erasure of a recording.
SP	Standard play, the recording speed to use when the best picture quality is of prime importance (and when total recording time is not).

What is dew condensation symptom?

- If a VCR is moved from a cool place to a warm and damp place or a place facing a direct cool wind from air-conditioner...and others, temperature varies sharply, which makes dew on head drums of VCR.

If dew condensation occurs,

- First, turn it on for one or two hours before using it.
- Do not use it because it may develop troubles of a VCR or videotape.

How to use a head cleaner

- In case of a old or contaminated videotape, screen may not be clean from the contamination of VCR heads. Please remove contaminants using a head-cleaner like below order.

- Insert a head-cleaner into VCR.
- Press [PLAY] for 5 seconds, and then press [FF] for about 10 seconds.



- Eject a head-cleaner from VCR.
 - If the screen is not clean yet, please repeat the above 2 or 3 times more.
 - A head-cleaner is not for sale. Please ask it for the nearest agent.
 - In case a user ask the removal of contaminants of us, the user should pay extra charges.

Before doubting about troubles (DVD)

Symptom	Checks
• The player does not play.	<ul style="list-style-type: none"> If a DVD is from overseas, it may not be played. Please check a DVD's region code whether it has the relative region code 4 or All. Please check whether a DVD is inserted in a right direction. If it is a CD-ROM for PC or DVD-ROM, it does not work.
• No sound comes through.	<ul style="list-style-type: none"> Play mode may be "SLOW" or "PAUSE"(In abnormal speed play, no sound comes through) Did you connect the parts in right way? Please check the operative condition of TV or amplifier. From SETUP, please check "AUDIO" items. When DTS audio disc is output by RCA jack, low sound can be heard.
• A disc is playing but screen does not appear or poor screen appears.	<ul style="list-style-type: none"> Did you turn on your TV sets? Did you connect the parts in right way? The play may be in "PAUSE". A disc may have some contaminants or be damaged. A disc may be bad one.
• Sound is irregular.	<ul style="list-style-type: none"> Please check the connection with Dolby Digital amplifier. Please check the plugs are connected with one another tightly. Some contaminants may be remained in connection terminal.
• Remote control does not work.	<ul style="list-style-type: none"> Please check the degree of remote control, distance or any interruption. Battery may be weak or exhausted. When you operate DVD, use it by pressing [DVD] button. Unplug the power plug and plug it again.
• Dolby Digital sound does not work.	<ul style="list-style-type: none"> Dolby Digital sound can be worked in the Dolby Digital amplifier only. Please check "Dolby Digital" mark on your DVD. Please check the connection is correct.
• [AUDIO] or [SUBTITLE] button does not work.	<ul style="list-style-type: none"> If a DVD does not include language information, it does not support the function.
• [ANGLE] button does not work while a DVD is playing.	<ul style="list-style-type: none"> "ANGLE" is supported only in a DVD contains multi angle scenes. Also a user can confirm the support with the "ANGLE" mark on screen.
• "MENU" does not appear while a DVD is playing.	<ul style="list-style-type: none"> Please check the degree of remote control, distance or any interruption. Please check a battery in remote control whether it is exhausted or not. A DVD may not contain menu information.
• Screen shakes or appears only in black and white. (or Subtitle shakes)	<ul style="list-style-type: none"> A disc may have some contaminants or be damaged. If you playback a DVD disc of PAL system whose region code is "ALL", the playback screen may shake.
• The file name of MP3 (CD-R) appears with strange letters.	<ul style="list-style-type: none"> The file names of MP3 recognize only the Alphabet (A-Z, a-z), numbers (0-9) can be displayed. The letters except above case will not be displayed normally.
• Any MP3 (CD-R) file isn't displayed.	<ul style="list-style-type: none"> If the surface of disk is injured, the file display and playback can be impossible.

Before doubting about troubles (VCR)

Before doubting about troubles (VCR)

Symptom	Checks
• "Power On" does not work.	▶ Please check whether a power plug is inserted in an electric outlet.
• It does not work even in "Power On".	▶ Please check whether a videotape is inserted in. ▶ Try to insert a plug again.
• A videotape is not inputted in.	▶ Please check whether a power plug is inserted in an electric outlet. ▶ Please check whether a videotape is in. ▶ Please check whether a videotape is inserted in a right direction (a side of transparent window should be on the upside) ▶ Have you inputted a videotape again just after the tape was ejected? Please try it again after fully ejecting it. ▶ When a videotape forces to be ejected, the tape may not be inputted. In the case, please pull out an outlet, and then push the tape smoothly.
• On inputting a videotape, the tape is re-ejected.	▶ That's why a safe mode to protect a videotape is operated automatically. Please pull out the tape and input it again.
• A videotape is not ejected.	▶ In case the product is used for a long time, a videotape may not be ejected for a film inside may be stretched. In the case, please pull out a power plug for about 10mins and then press [EJECT] button.
• A channel on video and a play screen does not appear.	▶ Please check your antenna's connection. ▶ TV channel should be fixed on video channel (3 or 4). ▶ Please check your antenna's signal whether it may be weak. In case of its weakness, please use a frequency amplifier connected with the device. ▶ Press [TV/VCR] and then let "VCR" is displayed on the display panel.
• Noise (screen noise) appears on screen.	▶ While in no use of VCR, was it turned on? ▶ While in recording a program, do you watch another channel? ▶ Select TV by pressing [TV/VCR] button on remote control.
• Noise appears on screen after recording.	▶ While in playing a videotape, there may happen some noise or blot in the part of the beginning of a videotape or resuming "PAUSE", which are not breakdown.
• While in playing, noise appears.	▶ Please press [TRACKING] for better screen. Videotape may be poor. Try to change it to another one.
• Sound and screen are irregular. • Sound comes out but screen does not appear. • Screen is irregular and stripes appears. • "Screen Error" message is displayed in a screen.	▶ Please use a head-cleaner to clean VCR heads. VCR heads may be contaminated.
• While recording and playing, the top of screen extremely waves.	▶ Since VCR Play signals are not stable like a TV signals, screen may be unstable or curved while in playing. To fix the problem, please horizontal adjustment.
• A screen is not clear.	▶ In case videotape is the one recorded by other products or old one, stripe may appear on the screen. ▶ Try to adjust the screen by [TRACKING+/-] button. ▶ Try to use a head-cleaner.
• A screen at pause is trembling or slow screen is not clear.	▶ Try to use a head-cleaner. ▶ Try to adjust the screen by [TRACKING+/-] button.

Symptom	Checks
• Recording a TV program is impossible.	▶ Please check whether a channel is fixed on video. If not, you have to turn it into "TV" by pressing [INPUT] button. ▶ Please check whether the timer recording info is right. ▶ Are RF cables inputted antenna connection terminal correctly? ▶ Does a CH number selected in display section appear? ▶ Please check a tab on a tape whether it is broken or not. (If it was broken, please scotch-tape it) ▶ Check whether the screen is displayed in VCR Only Channel. Press [OUTPUT] button in this remote controller to adjust in "General Broadcast" condition. ▶ Is the rounded line (RF cable) connected in "ANT.IN" terminal?
• Once pressing [REC], a videotape is ejected automatically.	▶ Please check whether the clock is right. ▶ Please check whether the timer recording info is right. ▶ Please check a tab on a tape whether it is broke or not. (If it was broken, please scotch-tape it)
• Timer recording of Cable TV does not work.	▶ Was a cable data output code connected correctly? ▶ Were a converter manufacturer setup and output channel right? ▶ Did you enter a password? (Please cancel it.) ▶ Did you turn off your player? (Please turn it on.)
• In spite of pressing [CHANNEL], a channel can not be set.	▶ You may not memorize channels. ▶ Please check your channel setting or press a number button.
• While duplicating, screen is not clean and distorted.	▶ Some tapes or discs distributed in the market for lending is set to prevent copy in manufacturing. These tapes cannot be duplicated in a good condition.
• Remote control does not work.	▶ Battery may be weak or exhausted. ▶ A receiver of remote control may be different with a sender.
• Buttons on remote control do not work.	▶ In case a videotape is positioned in the beginning, "VISS REW" and "REW" do not work. ▶ In case a videotape is positioned in the end, "FF", "VISS FF", "PLAY" and "REC" do not work. ▶ Please check whether another button is pressed.
• VISS index search does not work.	▶ Are you playing a tape that is not recorded in this recorder? (Try to record it with the recorder.) ▶ You may start recording it in "REC-PAUSE". Please start recording it from stop condition.
• Cable broadcasting can not be selected.	▶ Please select "CABLE" not "NETWORK" from the "CHANNEL SETTING".

Specifications

Power	AC 120V, 60Hz	
Consumed electricity	95W	
Weight	6.45kg	
Dimension (WxHxD)	430mm x 91mm x 370mm	
Operative temperature	+5°C - 35°C	
Installation condition	Horizontal / Relative humidity under 80%	
Received channels	VHF: 2-13 CH / UHF: 14-69 CH / Cable: 1-125	
Signal type	NTSC COLOR	
Antenna input/output	U/V-mixed: 75Ω unbalanced	
VIDEO input	1.0 Vp-p unbalanced, RCA JACK	
AUDIO input	-8.8dBm, RCA JACK	
VHF output	3 or 4 CH	
VIDEO output (common use of DVD and VCR)	VIDEO output terminal, 1.0 Vp-p unbalanced, RCA JACK	
VIDEO output (DVD only)	S-VIDEO output (75Ω In load Y: 1.0Vp-p, C:0.286Vp-p) COMPONENT/Progressive output (75Ω In load Y: 1.0Vp-p, Pb:0.7Vp-p, Pr:0.7Vp-p)	
AUDIO output (common use of DVD and VCR)	Audio output terminal (2 kinds): -8.8dBm(VCR), 2.0Vrms(DVD), RCA JACK	
AUDIO output (DVD only)	Analogue AUDIO output (2 CH): 2.0Vrms	
Playable tape	Very high dense tapes with VHS marks	
Playable disc	DVD, VIDEO-CD, CD (12mm), CD (8mm), MP3, CD-R, CD-RW	
Tape speed	SP: 33.35mm/s, SLP: 11.12mm/s	
Playtime	SP: 2hrs, SLP: 6hrs (use of T-120 tape)	
Clock display	12 hrs AM/PM	
Time Recording	8 programs a year	
VIDEO S/N (VCR)	Over 45dB (Standard recording)	
Resolution	VCR	Over 220 lines (Standard recording)
	DVD	Over 500 lines (DVD Disc PLAY)
AUDIO (VCR)	Over 65dB (Hi-Fi), over 40dB (Mono)	
AUDIO (DVD)	90dB	
AUDIO dynamic range	90dB	
Speaker Output (Impedance) & (Size)	Center	50W (6Ω)
	Front L/R	50W x 2 (6Ω)
	Rear L/R	50W x 2 (6Ω)
	Subwoofer	50W (6Ω)
Amp Frequency Band Width	20Hz - 20KHz	
Radio Tuning Range	FM : 87.5 - 108.0 MHz, AM : 520 - 1710 KHz	
Radio Intermediate Freq.	FM : 10.7 MHz, AM : 450 KHz	
FM Antenna Impedance	75 Ω (unbalanced)	
AM Loop Antenna Inductance	12.5 uH (1KHz)	