

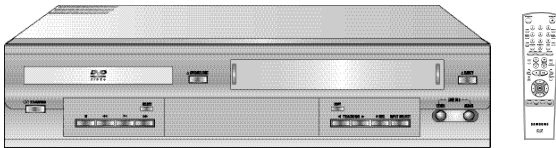

DVD-VCR

DVD-V52

Instruction Manual



www.samsungvcr.com



Contents





- ◆ FOREWORD
 - Safety Instructions..... 4
 - Disc Type and Characteristics..... 5
- ◆ DVD-VCR OVERVIEWS
 - Front View of the DVD-VCR..... 6
 - Rear View of the DVD-VCR..... 6
 - Infrared Remote Control..... 7
 - Display Indicators..... 8
 - Accessories..... 8
- ◆ CONNECTING YOUR DVD-VCR
 - Deciding How to Connect DVD-VCR..... 9
 - Connecting DVD-VCR to the TV using the RCA Cable..... 10
 - Connecting Other Equipment to Your DVD-VCR..... 10
 - Deck Control Keys..... 11
 - Copying from DVD to VCR..... 12
 - Inserting Batteries in the Remote Control..... 13
 - Setting the Date and Time..... 13
 - Menu Language..... 14
- ◆ SETTING UP YOUR DVD-VCR
 - Selecting the Colour Mode..... 15
 - Intelligent Picture Control..... 16
 - Auto Power off..... 16
 - Selecting the Cassette Type..... 17
 - Auto Repeat Play..... 17
 - Displaying/Hiding On-Screen Information..... 18
 - Selecting the Recording Speed..... 18
 - Protecting a Recorded Cassette..... 19
 - Connecting an RCA Audio/Video Input Cable..... 19
 - Recording from Another VCR or Camcorder..... 20
 - Recording a Programme with Automatic Stop..... 21
- ◆ PLAYING BACK
 - Playing a Cassette..... 22
 - Adjusting Picture Alignment Automatically..... 22
 - Adjusting Picture Alignment Manually..... 22
 - Playing a Cassette in Slow Motion..... 23
 - Playing a Sequence Frame by Frame..... 24
 - Playing a Sequence at Variable Speeds..... 24
 - Searching for a Specific Sequence..... 25
 - Picture Search, Fast Forward/Rewind..... 26
 - Using the Tape Counter..... 26
 - SQPB (Super VHS Quasi Playback)..... 27

Contents (cont.)

- ◆ DVD FUNCTIONS
 - Choosing a Connection..... 28
 - Using the DVD SETUP..... 29
 - Using the Disc Menu Language..... 30
 - Setting Up the Language Features..... 31
 - Setting Up the Parental Control..... 32
 - Setting Up the Audio Options..... 33
 - Setting Up the Display Options..... 34
 - A/V Receiver Connections..... 35
 - Special Playback Features..... 36
 - Using the Display Function (DVD)..... 37
 - Using the Display Function (CD/VCD)..... 37
 - Repeat Play..... 38
 - Program Play (DVD/VCD/CD)..... 39
 - Random Play (DVD/VCD/CD)..... 39
 - SCREEN FIT Play..... 40
 - Digest Play..... 41
 - Using the Disc View Function..... 42
 - Selecting the Audio Language..... 43
 - Selecting the Subtitle Language..... 43
 - Changing the Camera Angle..... 44
 - Using the Bookmark Function..... 45
 - Using the Zoom & 3D Sound Functions..... 46
 - MP3 Play..... 47
 - CD-R MP3 Disc Requirements..... 48
- ◆ SOLVING PROBLEMS
 - Technical Specifications..... 49
 - Problems and Solutions (VCR)..... 50
 - Troubleshooting Guide (DVD)..... 51

This product incorporates copyright protection technology that is protected by method claims of certain U.S. patents and other intellectual property rights owned by Macrovision Corporation and other rights owners. Use of this copyright protection technology must be authorized by Macrovision Corporation by Macrovision Corporation, and is intended for home and other limited viewing uses only unless otherwise authorized by Macrovision Corporation. Reverse engineering or disassembly is prohibited.

Symbols

- 
 Press/push
 - 
 Hold down
 - 
 Important
 - 
 Note
- ① = Step number

Safety Instructions

The following illustrations represent precautions.



The lightning bolt is a warning sign alerting you to dangerous voltage inside the product. DO NOT OPEN THE DVD-VCR. Refer to service personnel.

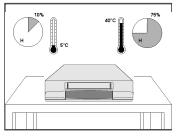

Do NOT expose the DVD-VCR to extreme temperature conditions (below 5°C and above 40°C) or to extreme humidity conditions (less than 10% and more than 75%).

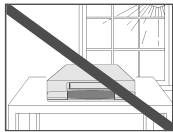

Do NOT expose the DVD-VCR to direct sunlight.

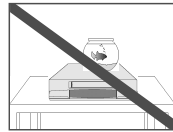

Do NOT expose the DVD-VCR to any liquids.

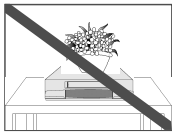

Do NOT place any objects on the DVD-VCR or remote control.

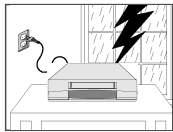

During a storm and/or lightning, unplug the DVD-VCR from the mains socket and aerial.

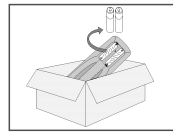

If the remote control is not used for a long period of time, remove the batteries and store it in a cool, dry place.

THIS DEVICE IS NOT FOR USE IN INDUSTRIAL ENVIRONMENTS

Disc Type and Characteristics

This DVD player is capable of playing the following types of discs with the corresponding logos :

Disc Types (Logos)	Recording Types	Disc Size	Max. Playing Time	Characteristics
	Audio + Video	12 Cm	Single-sided 240 min. Double-sided 480 min.	<ul style="list-style-type: none"> DVD contains excellent sound and video due to Dolby Digital and MPEG-2 system. Various screen and audio functions can be easily selected through the on-screen menu.
		8 Cm	Single-sided 80 min. Double-sided 160 min.	
	Audio + Video	12 Cm	74 min.	<ul style="list-style-type: none"> Video with CD sound, VHS quality & MPEG-1 compression technology.
		8 Cm	20 min.	
	Audio	12 Cm	74 min.	<ul style="list-style-type: none"> An LP is recorded as an analog signal with more distortion, CD is recorded as a Digital Signal with better audio quality, less distortion and less deterioration of audio quality over time.
		8 Cm	20 min.	

* DO NOT play CD-ROM, CD-I and DVD-ROM in this player! (CDGs play audio only, not graphics.)

Disc Markings



• Playback Region Number

• PAL colour system in U.K, France, Germany, Canada, Japan, China etc.

• NTSC broadcast system in USA, Canada, Japan, South Korea, etc.

• Dolby Digital disc

• Stereo disc

• Digital Audio disc

• DTS disc

Playback Region Number

Both the DVD player and the discs are coded by region. These regional codes must match in order for the disc to play. If the codes do not match, the disc will not play.

The Region Number for this player is described on the rear panel of the player.

Front View of the DVD-VCR

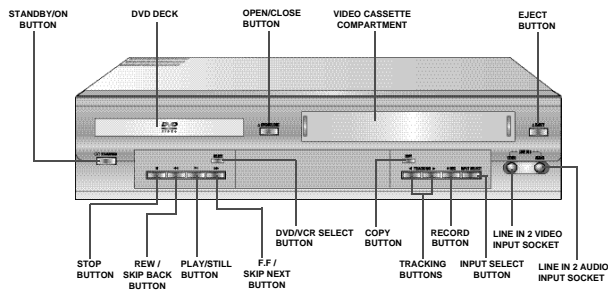

Rear View of the DVD-VCR

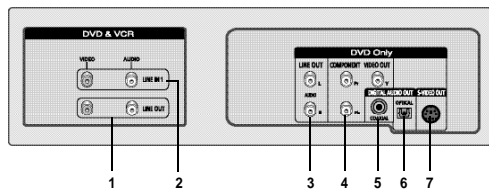

- | | |
|---|-------------------------------|
| 1 LINE OUT TO TV (COMPOSITE) | 5 DIGITAL AUDIO OUT (COAXIAL) |
| 2 LINE IN 1 | 6 DIGITAL AUDIO OUT (OPTICAL) |
| 3 AUDIO LINE OUT (S-VIDEO OR COMPONENT) | 7 S-VIDEO OUT |
| 4 COMPONENT VIDEO OUT | |

Infrared Remote Control

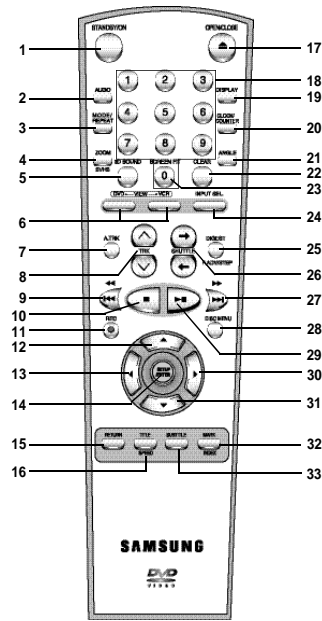

- 1 STANDBY/ON
- 2 AUDIO
- 3 MODE, REPEAT
- 4 ZOOM, SV/HS
- 5 3D SOUND
- 6 DVD, VCR
- 7 AUTO TRACKING
- 8 TRACKING
- 9 REWIND, SKIP BACK
- 10 STOP
- 11 RECORD
- 12 UP
- 13 LEFT
- 14 SETUP/ENTER
- 15 RETURN
- 16 TITLE, SPEED
- 17 OPEN/CLOSE
- 18 0-9
- 19 DISPLAY
- 20 CLOCK/COUNTER
- 21 ANGLE
- 22 CLEAR
- 23 SCREEN FIT
- 24 INPUT SEL.
- 25 DIGEST, F.ADV/STEP
- 26 SHUTTLE
- 27 FAST-FORWARD
- 28 SKIP NEXT
- 29 DISC MENU
- 30 PLAY/STILL
- 31 RIGHT
- 32 DOWN
- 33 MARK, INDEX
- 34 SUBTITLE

Display Indicators

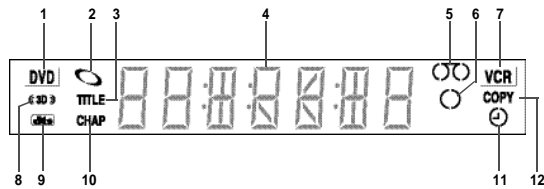

- | | |
|--|---|
| <p>1 The DVD Deck is active</p> <p>2 A DVD, CD, VCD, or SVCD is loaded</p> <p>3 The number to the right of the "TITLE" symbol is the current title number</p> <p>4 The time, counter position, time remaining or current deck status is displayed</p> <p>5 VHS tape is inserted</p> <p>6 Recording is in progress (normal and timer)</p> | <p>7 The VCR Deck is active</p> <p>8 3D Sound is active</p> <p>9 A DVD with a DTS soundtrack is loaded</p> <p>10 The number to the right of the "CHAP" symbol is the current chapter number</p> <p>11 A Timer Recording is programmed or in progress. If blinking there is an error.</p> <p>12 DVD to VHS copy is in progress</p> |
|--|---|

Accessories

You have just purchased a SAMSUNG Video Cassette Recorder (DVD-VCR). Together with your DVD-VCR, you will find the following accessories in the box.

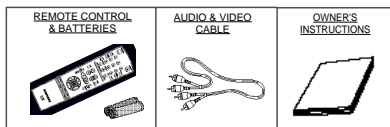

Deciding How to Connect DVD-VCR

You must take into account various factors when connecting audio or video systems:

- ◆ Types of connectors available on your systems
- ◆ Systems connected permanently to the DVD-VCR (satellite receiver for example) or temporarily (camcorder for example)

Your DVD-VCR is equipped with the following connectors.

Connector	Location	Type	Direction	Recommended Use
LINE1	Rear	Audio/Video RCA	In/Out ←→	◆ Television ◆ Other VCR
LINE2	Front	Audio/Video RCA	In →	◆ Other VCR
Audio output	Rear	Audio RCA	Out →	◆ LINE Audio out (DVD only)
COMPONENT output	Rear	RCA	Out →	◆ COMPONENT out (DVD only)
S-VIDEO output	Rear	S-JACK	Out →	◆ S-Video out (DVD only)
Digital AUDIO output	Rear	Optical coaxial	Out →	◆ Digital Audio out (DVD only)



Whenever you connect an audio or video system to your DVD-VCR, ensure that all elements are switched off.

Refer to the documentation supplied with your equipment for detailed connection instructions and associated safety precautions.

Connecting DVD-VCR to the TV using the RCA Cable

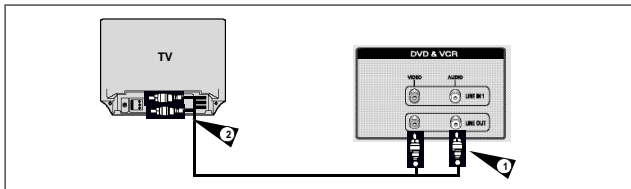

You can connect your DVD-VCR to the television using the RCA cable if the appropriate input is available on the television. You thus:

- ◆ Obtain better quality sound and pictures
 - ◆ Simplify the setting up procedure of your DVD-VCR
- ☞ Make sure that both the television and the DVD-VCR are switched off before connecting the cables.

- 1 Connect one end of the RCA Audio/Video cable to the Video output and Audio output socket on the rear of the DVD-VCR.
- 2 Plug the other end into the appropriate connector on the television.

Connecting Other Equipment to Your DVD-VCR

You can connect other audio and/or video equipment to your DVD-VCR in different ways. The following illustrations give a few examples of the connection possibilities.

- The RCA input/output connectors on the rear of the DVD-VCR are used for equipment, such as camcorders, VCRs or sound systems.

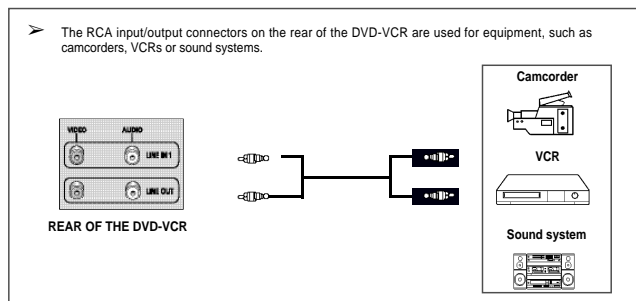

Deck Control Keys

The DVD-VCR uses one set of controls to operate both decks. The following keys are helpful in successfully controlling each deck.

- 1 **STANDBY/ON Button**
Press the STANDBY/ON button on the remote control or front panel to turn on the DVD-VCR.
- 2 **DVD Button**
Press the DVD button on the remote control when you want to control the DVD deck.
 - ◆ The DVD indicator will light on the Front Panel Display to show that the DVD deck is selected.
- 3 **VCR Button**
Press the VCR button on remote control when you want to control the VCR deck.
 - ◆ The VCR indicator will light on the Front Panel Display to show that VHS deck is selected.
- 4 **DVD-VCR Toggle**
Press the SELECT button on the front panel to toggle control between the DVD deck and the VCR deck.

- Before using the VCR operation of 13-27 pages, press the VCR button on the remote control to select VCR mode.

Before using the DVD operation of 28-48 pages, press the DVD button on the remote control to select and watch DVD.

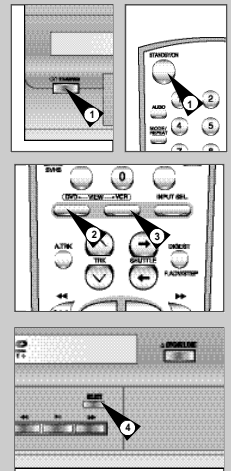

Copying from DVD to VCR

GB

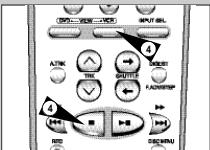
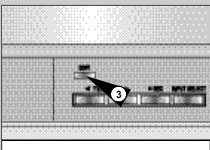
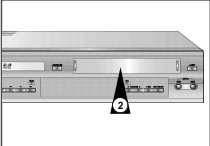
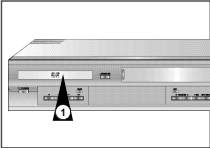

12

The DVD-VCR allows you to copy the contents of a DVD to a VHS tape with a press of the COPY button.



If the DVD you are attempting to copy is copy protected, you will not be able to copy the disc. It is not permitted to copy Macrovision® encoded DVDs.

- 1 **Insert Disc**
Insert the disc you wish to copy in the DVD deck and close the drawer.
- 2 **Insert VHS Tape**
Insert a blank VHS videotape into the VCR deck.
- 3 **Copy the DVD to VHS Tape**
Press the COPY button on the DVD-VCR front panel.
 - ◆ The DVD will go into Play mode and the VCR will go into Record mode.
- 4 **Stop the Copy Process**
When the DVD is finished playing, press the VCR button on the remote control and then press the STOP button to end the copy.
 - ◆ You must stop the Copy process manually when the DVD movie ends or the DVD may replay and record over and over again.



For NTSC DVD or VCD copy

- ◆ Before starting the copy process, set the Quasi PAL to Off in Display options of DVD SETUP (see page 34).
- ◆ If Quasi PAL is On, the copy process can not active.
- ◆ The copy is only active PAL tape system.

Inserting Batteries in the Remote Control

GB

You must insert or replace the batteries in the remote control when you:

- ◆ Purchase the DVD-VCR
- ◆ Find that the remote control is no longer working correctly

- 1 Push the tab in the direction of the arrow to release the battery compartment cover on the rear of the remote control.
- 2 Insert two AA, R6 or equivalent batteries, taking care to respect the polarities:
 - ◆ + on the battery with + on the remote control
 - ◆ - on the battery with - on the remote control
- 3 Replace the cover by aligning it with the base of the remote control and pushing it back into place.



Do not mix different battery types (manganese and alkaline for example).

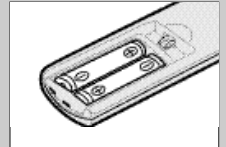
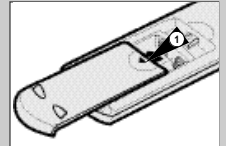

Setting the Date and Time

You must set the date and time when:

- ◆ You purchase the DVD-VCR
- ◆ Do not forget to reset the time when you change clocks from winter to summer time and vice versa.

- 1 Press SETUP on the remote control.
Result: The MAIN MENU is displayed.
- 2 Press the corresponding ▲, ▼ or ◀, ▶ buttons to select the CLOCK option.
- 3 Press the ENTER button to select this option.
Result: The CLOCK SET menu is displayed.
- 4 Press ◀ or ▶ to select the hour, minutes, day, month and year.
Result: The option selected flashes.
- 5 Press the ▲ or ▼ buttons to increase or decrease the value.
Result: The day of the week is displayed automatically.
 - You can hold the ▲ or ▼ buttons down to scroll more quickly through the values.
- 6 On completion, press RETURN to exit the menu.

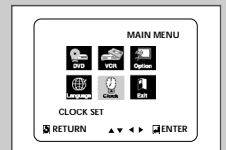

13

Menu Language

GB

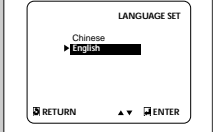
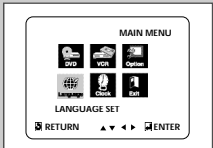
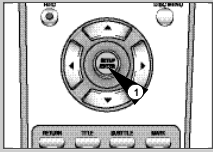

Follow these steps to change the on-screen menu language to Chinese , English.

- 1 Open "MAIN MENU"**
With the DVD in stop mode, press the SETUP button.
- 2 Set "Language"**
Using the ▲, ▼ or ◀, ▶ buttons, move the selection arrow to Language set then press ENTERbutton.
- 3 Set menu Language**
Move the selection bar to your desired Language, then press ENTER button.

Selecting the Colour Mode

VCR

GB

Before recording or playing back a cassette, you can select the required system standard.
 Otherwise, the system automatically selects the reception standard when you select **AUTO**.

- ◆ When playing back a cassette, the standard is automatically selected by the DVD-VCR.
- ◆ When you playback an NTSC-recorded tape on this DVD-VCR make a setting on the colour system according to your TV. If your TV is a PAL system only TV, set NTPB. If your TV is Multi System TV (NTSC 4.43 compatible), set NT4.43 and you can record NT4.43.

- 1 Press **SETUP** on the remote control.
Result: The **MAIN MENU** is displayed.
- 2 Press the corresponding **▲**, **▼** or **◀**, **▶** buttons to select the **Option** option.
- 3 Press the **ENTER** button to select this option.
Result: The **USER SET** menu is displayed.
- 4 Press the corresponding **▲** or **▼** buttons, until the cursor is placed on the **COLOUR SYSTEM** option.
- 5 Press the **▶** button to select **AUTO** → **PAL** → **MESECAM** → **B/W**.

AUTO	When playing back a cassette, the system standard is automatically selected by the DVD-VCR.
B/W	Black and White

- 6 On completion, press **RETURN** twice to exit the menu.

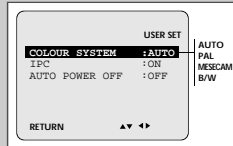
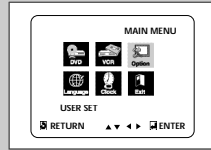

VCR Intelligent Picture Control

GB

The Intelligent Picture Control Feature allows you to adjust the sharpness of the image automatically, according to your own preferences.

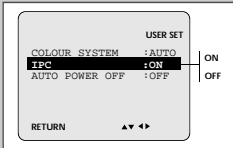
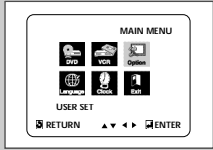

- 1 During playback, press the SETUP button on the remote control.
Result: The MAIN MENU is displayed.
- 2 Press the corresponding ▲, ▼ or ◀, ▶ buttons to select the **Option** option.
- 3 Press the ENTER button to select this option.
Result: The **USER SET** menu is displayed.
- 4 Press the corresponding ▲ or ▼ buttons, until the cursor is placed on the **IPC** option.
- 5 Press the ◀ or ▶ button to select the IPC (intelligent picture control) option.
 - When intelligent picture control mode is **ON**, the sharpness of the image is adjusted automatically.
- 6 To adjust the sharpness manually, press the ▼ button to turn the IPC mode **OFF**.
- 7 Press the ◀ or ▶ buttons until the picture is displayed according to your preferences.
 - If you do not press a button within ten seconds, the **PICTURE** menu disappears automatically.
- 8 On completion, press the RETURN button again.

VCR Auto Power Off

The Auto Power Off feature automatically turns off your DVD-VCR if no signal is received and you do not press any button for the selected time.

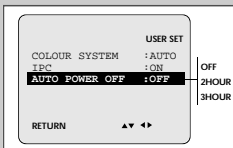
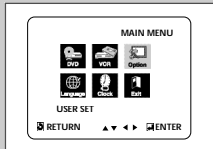

- 1 Press SETUP on the remote control.
Result: The MAIN MENU is displayed.
- 2 Press the corresponding ▲, ▼ or ◀, ▶ buttons to select the **Option** option.
- 3 Press the ENTER button to select this option.
Result: The **USER SET** menu is displayed.
- 4 Press the corresponding ▲ or ▼ buttons, until the cursor is placed on the **AUTO POWER OFF** option.
- 5 Press the ▶ button, until you select the time of Auto Power off interval.
 - OFF → 2HOUR → 3HOUR
- 6 On completion, press RETURN twice to exit the menu.

16

Selecting the Cassette Type

VCR

GB

If you wish to use the tape counter to display the time remaining on a cassette, you must indicate the type of cassette inserted.

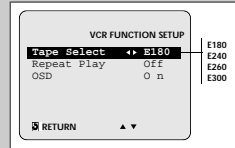
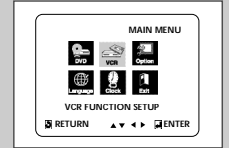

- 1 Press SETUP on the remote control.
Result: The MAIN MENU is displayed.
- 2 Press the corresponding ▲, ▼ or ◀, ▶ buttons to select the **VCR** option.
- 3 Press the ENTER button to select this option.
Result: The **VCR FUNCTION SETUP** menu is displayed.
- 4 Press the corresponding ▲ or ▼ buttons, until the cursor is placed on the **Tape Select** option.
- 5 Press the ◀ or ▶ buttons as many times as required, until the correct cassette length is displayed.
 - E180 → E240
 - E300 ← E260
- 6 Press RETURN twice to exit the menu.

Auto Repeat Play

VCR

You can set repeat play to repeat the tape continuously from beginning to end.

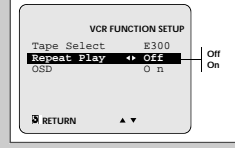
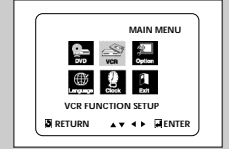

- 1 Press SETUP on the remote control.
Result: The MAIN MENU is displayed.
- 2 Press the corresponding ▲, ▼ or ◀, ▶ buttons to select the **VCR** option.
- 3 Press the ENTER button to select this option.
Result: The **VCR FUNCTION SETUP** menu is displayed.
- 4 Press the corresponding ▲ or ▼ buttons, until the cursor is placed on the **Repeat Play** option.
- 5 **To...** Press ◀ or ▶, until...
 - Repeat play **ON** is displayed.
 - Do not wish to repeat play **OFF** is displayed.
- 6 On completion, press RETURN twice to exit the menu.

17

VCR Displaying/Hiding On-Screen Information

GB

Your DVD-VCR displays most information both on the DVD-VCR and the television.

You can choose to display or hide this information on the television screen (except for the Index, MAIN MENU, which cannot be hidden).

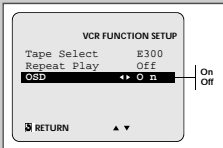
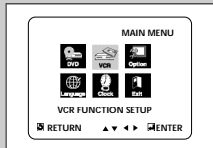

- 1 Press SETUP on the remote control.
Result: The MAIN MENU is displayed.
- 2 Press the corresponding ▲, ▼, ◀, ▶ buttons to select the VCR option.
- 3 Press the ENTER button to select this option.
Result: The VCR FUNCTION SETUP menu is displayed.
- 4 Press the corresponding ▲ or ▼ buttons, until the cursor is placed on the OSD option.
- 5 To... Press ◀ or ▶, until...
Display on-screen information ON is displayed.
Hide on-screen information OFF is displayed.
- 6 On completion, press RETURN twice to exit the menu.

VCR Selecting the Recording Speed

You can record a cassette at two different speeds:

- ◆ SP (Standard Play)
- ◆ LP (Long Play)

In Long Play modes:

- ◆ Each cassette lasts twice as long
- ◆ The recording is of a slightly lower quality

To record a cassette... Press the SPEED button on the remote control, until...

- | | |
|-----------------------|------------------|
| In standard play mode | SP is displayed. |
| In long play mode | LP is displayed. |

Type	Recording Time (in SP)
E-180	180 mins. or 3 hours
E-240	240 mins. or 4 hours
E-260	260 mins. or 4 hours and 20 mins.
E-300	300 mins. or 5 hours

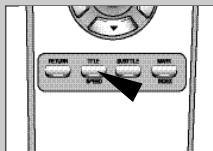

18

Protecting a Recorded Cassette

VCR

GB

Video cassettes have a safety tab to prevent accidental erasure. When this tab has been removed, you cannot record on the tape.

- 1 If you wish to protect a cassette, break off the tab using a small screwdriver.
- 2 To re-record over a protected cassette (safety tab broken), cover the hole with adhesive tape.

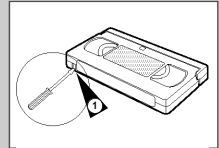

Connecting an RCA Audio/Video Input Cable

VCR

You can connect other audio/video equipment to your DVD-VCR using audio/video cables if the appropriate outputs are available on the equipment chosen.

- Examples:**
- ◆ You wish to copy a video cassette with the help of a second VCR (see page 20).
 - ◆ You wish to play back and/or copy pictures taken with a camcorder (see page 20).
- ☞ Make sure that both the television and the DVD-VCR are switched off before connecting the cables.

- 1 Connect one end of the RCA audio/video cable into the VIDEO socket on the Front of the DVD-VCR.
- 2 Plug the other end of the audio/video cable into the appropriate output connector on the other system (VCR or camcorder).
- 3 Connect one end of the RCA audio cable into the AUDIO sockets on the Front of the DVD-VCR.
- 4 Plug the other end of the audio cable into the appropriate output connectors on the other system (VCR, camcorder or sound system).

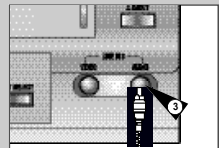
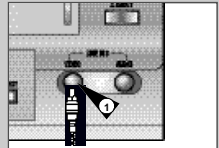

19

VCR Recording from Another VCR or Camcorder

GB

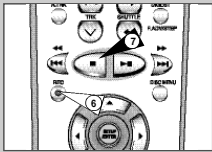
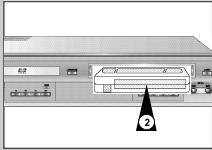

You can copy a cassette to your DVD-VCR from another video source, such as another VCR or a camcorder.

It is an infringement of copyright laws to copy prerecorded cassettes or to re-record them in any form without the permission of the owners of the corresponding copyright.

- 1 Connect the DVD-VCR, from which the cassette is to be copied, to the appropriate RCA audio and video input connectors on the rear of your DVD-VCR, as indicated on page 10.
- 2 Insert a blank cassette in your DVD-VCR.
- 3 Insert the pre-recorded cassette in the other video source (VCR or camcorder).
- 4 Select the LINE IN source (LINE IN 1 or LINE IN 2) using the INPUT SEL. button.
- 5 Start playing back the cassette to be copied.
- 6 Hold REC (●) down for a while to start recording on your DVD-VCR.
- 7 When you have finished recording, press ■ on both VCR and DVD-VCR.

20

Recording a Programme with Automatic Stop

VCR

GB

This function enables you to record up to nine hours (LP) of programmes.

Your DVD-VCR stops automatically after the requested length of time.

- 1 Switch on the television.
- 2 Insert the cassette on which the programme is to be recorded, with the window visible and the safety tab intact or the opening covered with adhesive tape.
Result: The DVD-VCR is switched on automatically.
- 3 Select the recording speed by pressing the SPEED button as many times as required (see page 18).
- 4 Hold the REC button (●) down for a while to start recording.
Result: The record indicator appears on the television screen and DVD-VCR display. An index is recorded on the tape (see page 25).
- 5 Press the REC button (●) several times to increase the recording time in:
 - ◆ 30-minute intervals up to four hours
 - ◆ 1-hour intervals up to nine hours (LP)**Result:** The length is displayed on the television displays. The selected programme is recorded for the length of time requested. At the end of that time, the DVD-VCR stops recording automatically.
- 6 If you wish to cancel the recording before the end, press STANDBY/ON.

If the end of the tape is reached while recording:

- ◆ The recording stops and power off

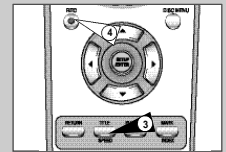
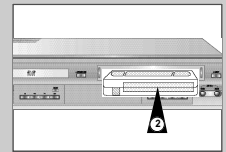

21

VCR **Playing a Cassette**

GB

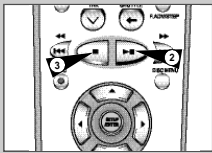

This function allows you to play back any pre-recorded cassette.

- 1 Switch on both the television and your DVD-VCR.
- 2 Insert the video cassette to be played. If the safety tab on the cassette is intact, press **▶II**. Otherwise, the cassette is played automatically.
 - When a cassette is loaded, the tape position is optimized automatically to reduce disturbance (Digital Auto Tracking). When playing a cassette, if the end of the tape is reached, the cassette is rewind automatically. NTSC tapes can be played back but cannot be recorded with this DVD-VCR.
- 3 To... Then press...

Stop the playback	■ (STOP).
Eject the cassette	▲ (EJECT).

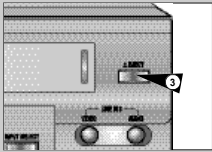

VCR **Adjusting Picture Alignment Automatically**

The Picture Alignment feature enables you to optimize the tape position automatically to obtain the best possible picture.

When noise bars or streaks appear during playback, adjust picture alignment by pressing the A.TRK button.

- Result:**
- ◆ The tracking bar appears.
 - ◆ The picture is automatically adjusted.
 - ◆ The tracking bar disappears when digital auto tracking has been completed.

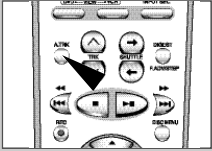

VCR **Adjusting Picture Alignment Manually**

The Picture Adjustment feature allows you to adjust the alignment manually to obtain the best possible picture.

When noise bars or streaks appear during playback, adjust alignment manually by pressing the TRK (↔) buttons until the picture is clear and stable.

- Result:**
- ◆ The tracking bar appears.
 - ◆ The image is adjusted.
 - ◆ The tracking bar disappears when you release the button.



Playing a Cassette in Slow Motion

VCR

GB

You can play a cassette in slow motion.

➤ No sound is heard when playing back a cassette in slow motion.

- 1 Press:
 - ◆ **▶II** to start playing the cassette
 - ◆ **▶II** button one more time to make STILL mode.
 - ◆ **▶II** to start SLOW mode.
 - ◆ **▶II** or **◀◀** button as many times as required to increase or decrease the speed respectively
 - ◆ To return to the normal speed, press the **▶II** button twice.
- 2 When playing back in slow motion, picture interference may occur. Press the TRK (↔) buttons to minimize this effect.

✎ When you have been using the Slow Motion function for more than about five minutes, the DVD-VCR will automatically play to protect the:

- ◆ Cassette
- ◆ Video heads

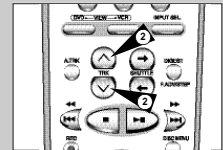
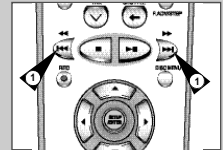

VCR Playing a Sequence Frame by Frame

GB

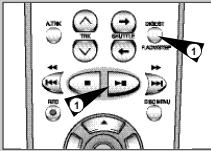

You can:

- ◆ Stop the cassette at a given frame (image)
- ◆ Advance one frame at a time

➤ No sound is heard when playing back frame by frame.

- 1 Press:
 - ◆ ►II to start playing the cassette
 - ◆ ►II to still the tape at a given frame
 - ◆ Press F.ADV/STEP () to advance frame by frame
- 2 To return to normal playback, press ►II.

➤ When you have been using the still function for more than about five minutes, the DVD-VCR will automatically play to protect the cassette and video heads.

➤ Vertical stability: When playing back frame by frame, interference may be seen on the screen. Press the TRK () buttons to minimize this effect.

VCR Playing a Sequence at Variable Speeds

You can vary the playback speed using the Shuttle function (up to nine times the normal speed).

Example: You wish to analyze a sports person's technique, movement by movement.

The Shuttle function is available on the Remote control

➤ No sound is heard when playing a sequence at variable speeds.

- 1 Press:
 - ◆ ►II during playback
 - ◆ SHUTTLE (◀) to play the cassette backwards
 - ◆ SHUTTLE (▶) to play the cassette forwards
- 2 Each time you press a SHUTTLE button, the speed is changed as shown in the following illustration.

REVERSE PLAY X9	REVERSE PLAY X5	REVERSE PLAY X3	STILL	SLOW MOTION X1/10	SLOW MOTION X1/6	PLAY X3	PLAY X5	PLAY X9
-----------------	-----------------	-----------------	-------	-------------------	------------------	---------	---------	---------

Searching for a Specific Sequence

VCR

GB

Each time you record a cassette on this DVD-VCR, an "index" is automatically marked on the tape when recording starts. The Search function allows you to fast-forward or rewind to a specific index and start playback from that point. Depending on the direction selected, the indexes are numbered as follows:

		↓		
etc.	Prev Seq.	Seq. being played	Next Seq.	etc.
	2	1	1	2

➤ This VCR uses a standard indexing system (VISS). As a result, it will recognize any indexes marked by other VCRs using the same system and vice versa.

INTRO SCAN

- 1 To search for a specific index, press INDEX.
- 2 Press the ◀ or ▶ buttons depending on the direction where your desired programme is located.
- 3 When an Index mark is found the VCR will playback the tape for 5 seconds, after which it will continue searching for the next Index mark.
- 4 If you want to watch the tape from a particular Index, simply press ►II.

Index Skip Search:

This feature will enable you to fast forward/rewind to a specific point on a tape: E.g. if you have recorded 3 different programmes on a tape and you have rewound the tape to the beginning, by using this feature you can go directly to the start of programme 2 simply by pressing the INDEX button.

- 1 Press the INDEX to start the Index search.
- 2 Press the ◀ or ▶ buttons twice more. This will take you directly to the start of the desired programme is located.
- 3 These Index searches can be made forwards: (press ▶) or backwards: (press ◀).
- 4 To cancel an Index search simply press the ►II or ■ button.

➤ You can set an index number up to ±20.

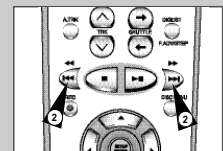
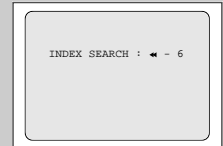
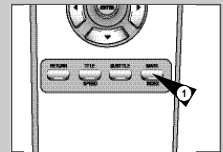

VCR Picture Search, Fast Forward/Rewind

GB

Picture Search enables you to Fast Forward or Rewind and look for a particular part of a tape.

- 1 Press PLAY, the VCR will enter normal play mode. While in play, press and release the **▶▶** (or **◀◀**) button. The VCR will search at 5 times the normal playback speed.
- 2 To return to normal playback mode, press the **▶||** button.
- 3 If you press and HOLD down the **▶▶** (or **◀◀**) button the VCR will search at 9 times the normal speed. Releasing the **▶▶** button will return the VCR to search at 5 times the normal speed. To return to normal playback mode, press the **▶||** button.
- 4 Whilst in Picture Search mode, if you press the **▶▶** button again, the VCR will enter normal Fast Forward mode.
- 5 Likewise, whilst in Picture Search **◀◀** mode, if you press the **◀◀** button again, the VCR will enter normal Rewind mode.
- 6 If, when Rewinding (**◀◀**) or Fast Forwarding (**▶▶**), you press the **◀◀** (or **▶▶**) button, the VCR will enter the Picture Search mode.

VCR Using the Tape Counter

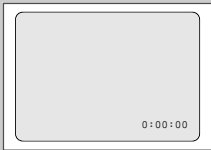

26

The tape counter:

- ◆ Indicates the elapsed time in the play and record modes (hours, minutes and seconds)
- ◆ Is reset when a cassette is inserted in the DVD-VCR
- ◆ Allows you to find the beginning of a sequence easily

▶ If the remaining time is to be calculated correctly, you must indicate the type of cassette being used.

- 1 Insert a cassette in your DVD-VCR.
- 2 To set the tape counter to zero at the beginning of a sequence:
 - ◆ Press DISPLAY twice to display the counter
 - ◆ Press CLEAR when you want to set the tape counter to zero
- 3 To fast-forward or rewind to the sequence at which the counter was set to zero, simply press **◀◀** or **▶▶**.
Result: The DVD-VCR stops automatically when the counter reaches zero.

➤ Some DVD-VCR information, such as the counter, can be displayed on the television screen (unless you have deactivated the OSD mode: refer to page 18).

Press DISPLAY:

- ◆ Once to display the current function, recording speed, date, time and counter
- ◆ Twice to display the counter only
- ◆ Three times to display the time remaining on the cassette
- ◆ Four times to clear the display

SQPB (Super VHS Quasi Playback)

VCR

GB

This function is for playback of Super VHS format tapes only, not for recording.

- 1 Insert the SVHS format tape that you want to see.
- 2 Press PLAY (**▶||**) to start playing the cassette.
- 3 Press SVHS (**SVHS**) button to start SQPB.

▶ If the SQPB is on during normal playback, the video output is distorted.



27

Choosing a Connection

DVD



The following show examples of connections commonly used to connect the DVD-VCR player with a TV and other components. It is only available for DVD. The VCR out can not watch by this connection.

Connection to an Audio System

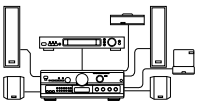

Dolby Digital Decoder

Dolby Digital Audio Input Jack

Analog Audio Input Jack

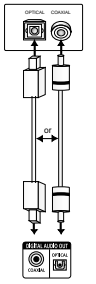

Digital Audio out Jack

or

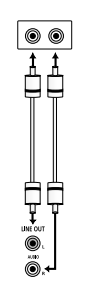

LINE Audio out Jack

Connection Component Video Jack

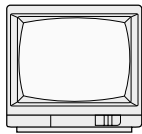

TV

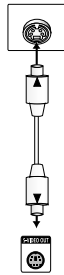

S-Video Jack

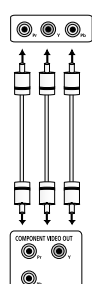

RCA Jack

DVD Using the DVD SETUP

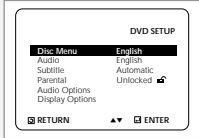
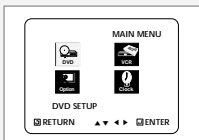

The DVD SETUP menu lets you customize your DVD player by allowing you to select various language preferences, set up a parental level, even adjust the player to the type of television screen you have.

- 1 With the unit in Stop mode, press the SETUP button on the remote.
Result: The MAIN MENU is displayed.
- 2 Press the corresponding ▲, ▼ or ◀, ▶ buttons to select the DVD option.
- 3 Press the ENTER button to select this option.
Result: The DVD SETUP menu is displayed.

- **Disc Menu :** Setup of the Menu Language
Use the Menu preference menu to select the language you want a DVD's disc menu to be displayed in.
- **Audio :** Setup of the Audio Language
Use the Audio preference menu to select the soundtrack language.
- **Subtitle :** Setup of the Subtitle Language
Use the Subtitle preference menu to select the language the disc's subtitles are to be displayed in.
- **Parental :** Setup of the Parental Level
Allows users to set the level necessary to prevent children from viewing unsuitable movies such as those with violence, adult subject matter, etc.
- **Audio Options :** Setup of the Audio Options
- **Display Options :** Setup of the Display Options use to select which type of screen you want to watch and several display options.

- 4 Use the ▲ or ▼ buttons on the remote to access the different features.
- 5 Press the ENTER button to access the sub features.
 - To make the setup screen disappear after setting up, press the RETURN button.

➤ Depending on the disc, some Setup Menu selections may not work.

Using the Disc Menu Language

This function changes the text language only on the disc menu screens.

- 1 With the unit in Stop mode, press the SETUP button on the remote.
Result: The MAIN MENU is displayed.
- 2 Press the corresponding ▲, ▼ or ◀, ▶ buttons to select the DVD option.
- 3 Press the ENTER button to select this option.
Result: The DVD SETUP menu is displayed.
- 4 Use the ▲ or ▼ buttons to select Disc Menu.
- 5 Press the ENTER button.
- 6 Use the ▲ or ▼ buttons to select 'English'.
- Select "Others" if the language you want is not listed.
- 7 Press the ENTER button.
- English is selected and the screen returns to DVD SETUP.

➤ How to make the SETUP MENU disappear or return to menu screen during setup ; Press RETURN button.

DVD

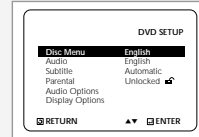
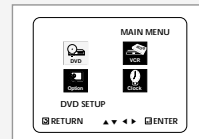

DVD Setting Up the Language Features

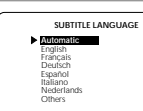
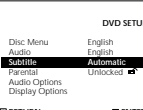
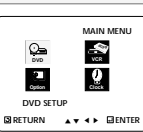
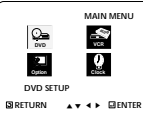

Using the Audio Language

- With the unit in Stop mode, press the SETUP button on the remote.
Result: The MAIN MENU is displayed.
- Press the corresponding ▲, ▼ or ◀, ▶ buttons to select the DVD option.
- Press the ENTER button to select this option.
Result: The DVD SETUP menu is displayed.
- Press the ▲ or ▼ buttons to move to Audio.
- Press the ENTER button.
- Press the ▲ or ▼ buttons to select 'English'.
- Select "Original" if you want the default soundtrack language to be the original language the disc is recorded in.
- Select "Others" if the language you want is not listed.
- Press the ENTER button.
- English is selected and the screen returns to DVD SETUP.

Using the Subtitle Language

- With the unit in Stop mode, press the SETUP button on the remote.
Result: The MAIN MENU is displayed.
- Press the corresponding ▲, ▼ or ◀, ▶ buttons to select the DVD option.
- Press the ENTER button to select this option.
Result: The DVD SETUP menu is displayed.
- Use the ▲ or ▼ buttons to select Subtitle.
- Press the ENTER button.
- Use the ▲ or ▼ buttons to select 'English'.
- Select "Automatic" if you want the subtitle language to be the same as the language selected as the audio preference.
- Select "Others" if the language you want is not listed. Some discs may not contain the language you select as your initial language; in that case the disc will use its original language setting.
- Press the ENTER button.
- English is selected and the screen returns to DVD SETUP.

- If the selected language is not recorded on the disc, the original pre-recorded language is selected.
- How to make the SETUP MENU disappear or return to menu screen during set up; Press RETURN button.

30

DVD Setting Up the Parental Control

The Parental Control function works in conjunction with DVDs that have been assigned a rating - which helps you control the types of DVDs that your family watches. There are up to 8 rating levels on a disc.

- With the unit in Stop mode, press the SETUP button on the remote.
Result: The MAIN MENU is displayed.
- Press the corresponding ▲, ▼ or ◀, ▶ buttons to select the DVD option.
- Press the ENTER button to select this option.
Result: The DVD SETUP menu is displayed.
- Use the ▲ or ▼ to select Parental. Press ENTER. The Parental Control screen appears.
- Use ◀ or ▶ to select Yes if you want to use a password. The create Password screen appears.
- Enter your password. The Re-enter Password screen appears to confirm the password. Enter your password again. The Parental Control screen appears.
- About the Rating Level :
- The Rating Level will work only when Use Password is set to Yes. To unlock the player, use ◀ or ▶ to select No. Use ▲ or ▼ to select Rating level. Press ENTER.
- Use ▲ or ▼ to select the level (e.g. Level 6) and press ENTER. Discs that contain Level 7 will now not play.
- To cancel the rating level, use ◀ or ▶ to select No in Use Password.
- About the Change Password:
- Use ▲ or ▼ to select Change Password. The Change Password screen appears.
- Enter your new password. Re-enter the new password again.

- How to make the SETUP MENU disappear or return to menu screen during set up; Press RETURN button.
- If you have forgotten your password, see Forget Password in the Troubleshooting Guide. (see page 50)

DVD

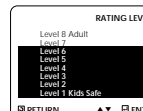
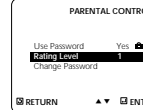
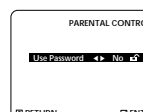
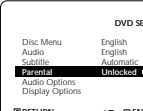

31

DVD Setting Up the Audio Options

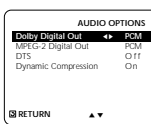

- 1 With the unit in Stop mode, press the SETUP button on the remote.
Result: The MAIN MENU is displayed.
- 2 Press the corresponding ▲, ▼ or ◀, ▶ buttons to select the DVD option.
- 3 Press the ENTER button to select this option.
Result: The DVD SETUP menu is displayed.
- 4 Use the ▲ or ▼ buttons to select Audio Options. Then press the ENTER button.
- 5 Use the ▲ or ▼ buttons to select the desired item. Then press the ◀ or ▶ buttons.

• Dolby Digital Out

PCM : Converts to PCM(2CH) audio. Select PCM when using the Analog Audio Outputs.
Bitstream : Converts to Dolby Digital Bitstream (5.1CH). Select Bitstream when using the Digital Audio Output.

➤ *Be sure to select the correct Digital Output or no audio will be heard.*

• MPEG-2 Digital Out

PCM : Converts to PCM(2CH) audio. Select PCM when using the Analog Audio Outputs.
Bitstream : Converts to MPEG-2 Digital Bitstream (5.1CH or 7.1CH). Select Bitstream when using the Digital Audio Output.

• DTS

Off : Doesn't output digital signal.
On : Outputs DTS Bitstream via digital output only. Select DTS when connecting to a DTS Decoder.

• Dynamic Compression

On : To select dynamic compression..
Off : To select the standard range.

-
- How to make the SETUP MENU disappear or return to menu screen during set up: Press RETURN button.
 - Manufactured under license from Dolby Laboratories. "Dolby" and the double-D symbol are trademarks of Dolby Laboratories.
 - "DTS" and "DTS Digital Out" are trademarks of Digital Theater Systems, Inc.

Setting Up the Display Options

DVD



- 1 With the unit in Stop mode, press the SETUP button on the remote.
Result: The MAIN MENU is displayed.
- 2 Press the corresponding ▲, ▼ or ◀, ▶ buttons to select the DVD option.
- 3 Press the ENTER button to select this option.
Result: The DVD SETUP menu is displayed.
- 4 Use the ▲ or ▼ buttons to select Display Options. Then press the ENTER button.
- 5 Use the ▲ or ▼ buttons to select the desired item. Then press the ◀ or ▶ buttons or then press the ENTER button. Use the ▲ or ▼ buttons to select the desired item. Then press the ENTER button.

• TV Aspect

Depending on the type of television you have, you may want to adjust the screen setting (aspect ratio).

4:3 Letter Box : Select when you want to see the total 16:9 ratio screen DVD supplies, even though you have a TV with a 4:3 ratio screen. Black bars will appear at the top and bottom of the screen.

4:3 Pan-Scan : Select this for conventional size TVs when you want to see the central portion of the 16:9 screen. (Extreme left and right side of movie picture will be cut off.)

16:9 Wide : You can view the full 16:9 picture on your widescreen TV.

• Black Level

Adjusts the brightness of the screen.

• Quasi-PAL

Depending on a disc, you can play a NTSC DVD disc by Quasi-PAL mode.

• DVD Out

Component : Sends COMPONENT signal (Y, Pb, Pr) to the component video out JACK.
S-Video : Sends S-VIDEO signal to the S-VIDEO OUT JACK.

-
- How to make the SETUP MENU disappear or return to menu screen during set up: Press the RETURN button.

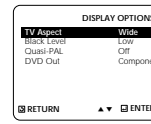
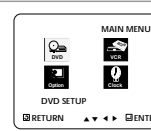

DVD A/V Receiver Connections

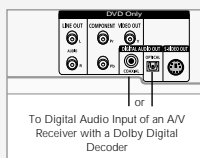

To Digital Audio Input of an A/V Receiver with a Dolby Digital Decoder

To take full advantage of the movie theater experience that DVD offers, you may want to connect your DVD-VCR to a complete Surround Sound system, including an A/V Receiver and six Surround Sound speakers.

Before You Begin...

- If your A/V receiver is equipped with a Dolby Digital Decoder, you have the option to bypass the DVD-VCR's built-in Dolby Digital Decoder. Use the DIGITAL AUDIO OUT connection below.

1 Digital Audio Out

Connect EITHER an optical cable OR a digital coaxial cable from the DIGITAL AUDIO OUT jacks on the back panel of the DVD-VCR to their corresponding Digital Audio Input jacks on your A/V Receiver:

- Optical
- Coaxial
- Use whichever connection is available on your A/V Receiver.

34

Special Playback Features

During DVD/CD playback you can select from the following special playback options. To resume normal playback, press the ►II (Play/Still) button.

1 Still

Press the ►II (Play/Still) button on the remote control during playback.

- The picture will still and the audio will mute.
- To resume playback, press the ►II (Play/Still) button.
- If the player is left in still mode for 5 minutes, it will stop automatically.

2 Frame Advance (Step)

While in Still mode, press the F.ADV/STEP button on the remote control to advance one frame at a time.

- Audio is muted during Frame Advance mode.
 - Press ►II (Play/Still) to resume normal playback.
- NOTE: Frame Advance operates only in the forward direction.

3 Skip Forward/Back

While a CD or DVD disc is in Play mode, press the Skip Forward/Back (► / ◀) buttons on the remote control or front panel to jump forward and backward through disc chapters/tracks.

- Skip Forward will jump to the next chapter/track.
- Skip Back will jump to the beginning of the current chapter/track.
- Press Skip Back again to jump to the beginning of the previous chapter/track.

Search Forward/Back

While a disc is in Play mode, press and hold the Forward/Back (►► / ◀◀) buttons on the remote control or front panel to visually search forward/backward at 2X - 4X - 8X - 16X - 32X - 128X speed. Press ►II (Play/Still) button to resume normal speed.

4 Slow Motion

During playback, press the ►II (Play/Still) button to Still the image. Then use the Search Forward (►►) to play in slow motion at variable speeds.

- Each press increases the slow motion speed playback to 1/8, 1/4 or 1/2 normal speed.
- Audio is muted during slow motion playback.
- Press the ►II (Play/Still) button to resume normal playback.

5 Stop/Resume

- Press the Stop button once to stop playback. To resume the DVD/CD from the point where the disc stopped, press the ►II (Play/Still) button.
- Press the ■ (Stop) button twice to completely stop playback. The next time you press ►II (Play/Still), the disc will start over from the beginning.

DVD

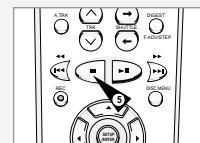
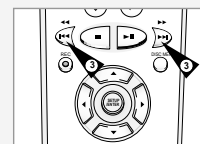
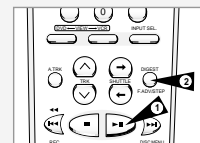

35

DVD Using the Display Function (DVD)

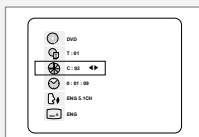

- 1 During play, press the DISPLAY button on the remote.

- Current title, chapter number, elapsed time, audio, and subtitle will be displayed.
- Use the ◀ or ▶ or NUMBER buttons to enter a different title, then press the ENTER button.
- Use the ◀ or ▶ or NUMBER buttons to enter a chapter number, then press the ENTER button.
- To enter the time from which you want to start, use the ▲ or ▼ buttons to select, then use the NUMBER buttons to enter the time. Then press the ENTER button.
- Use the ◀ or ▶ buttons to change the values of the current audio, and subtitle.
- To make the screen disappear, press the DISPLAY button again.

DVD Using the Display Function (CD/VCD)

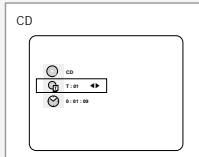
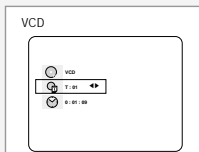

- 1 During play, press the DISPLAY button on the remote.

- Current track NUMBER, and elapsed time control will be displayed.
- Use the ▲ or ▼ buttons to select a track. Use the ◀ or ▶ buttons or NUMBER buttons to enter a different track number, then press the ENTER button.
- To enter the time from which you want to start, use the ◀ or ▶ buttons to select, then use the NUMBER buttons to enter the time. Press the ENTER button.

➤ **What is a Chapter?**
Each Title on a DVD is usually divided into chapters (similar to tracks on an audio CD).

What is a Title?
A DVD may contain several different titles. For example, if a disc contains four different movies, each might be considered a title.

36

Repeat Play

DVD



Repeat the current track, chapter, title, a chosen section (A-B), or all of the disc.

- 1 During play, press the REPEAT button on the remote. Repeat screen appears.
- 2 Select Chapter, Title or A-B using the ◀ or ▶ buttons.
 - Repeat A-B
 - Press the REPEAT button. Select A-B on screen with the ◀ or ▶ buttons.
 - Press ENTER at the point where you want the repeat play to start (A). The B is automatically highlighted.
 - Press ENTER at the point where you want the repeat play to stop (B).
- 3 To return to normal play, press REPEAT again, then press the ◀ or ▶ buttons to select Off and press ENTER.

-
- DVD repeats play by chapter or title, CD and VCD repeat play by disc or track. See page 46 to MP3 disc repeat play.
 - Depending on the disc, the Repeat function may not work.
 - If the title or track is completed before marking the end (B), the end of title or track becomes B automatically.
 - When in VCD 2.0 mode (MENU ON mode), this function does not work.

DVD



VCD/CD



37

DVD Program Play (DVD/VCD/CD)

PROGRAM ◀▶ RANDOM

RETURN ENTER

- 1 With the stop mode, press the MODE button.
- 2 Use the ◀ or ▶ buttons to select PROGRAM. Press the ENTER button.
- 3 Use the ◀ or ▶ buttons to select the first chapter (or track) to add to the program. Press the ENTER button. The selection numbers appear in the Program Order box.
- 4 Press the PLAY/STILL button. The disc will be played in programmed order.

Chap. (T:01) Program Order

01	02	03	04
05	06	07	08
09	10	11	12
13	14	15	16▶

RETURN CLEAR ENTER PLAY

Chap. (T:01) Program Order

01	02	03	04
05	06	07	08
09	10	11	12
13	14	15	16▶

RETURN CLEAR ENTER PLAY

DVD Random Play (DVD/VCD/CD)

PROGRAM ◀▶ RANDOM

RETURN ENTER

- 1 With the stop mode, press the MODE button.
- 2 Use the ◀ or ▶ buttons to select RANDOM. Press the ENTER button. The disc will be played in random order.

-
- Depending on the disc, the Program and Random Play function may not work.
 - When in VCD 2.0 mode (MENU ON mode), these functions do not work.
 - To resume normal play, press the CLEAR button.

38

SCREEN FIT Play

DVD



- 1 During play, press SCREEN FIT button on remote control.

- Allows you to eliminate the black bars in the top and bottom of the screen when a movie is playing in the Widescreen format(16:9).
- Screen Fit will not work when the Zoom mode is active. (you can not remove the black bars on the screen) However, Zoom mode will work when Screen Fit is active.

-
- Various aspect ratios are available only in multiple screen format discs.
 - This function does not work when a DVD has been recorded with a multi-camera angle format.
 - On some DVDs, the black bars cannot be eliminated due to their aspect ratio.



39

DVD Digest Play



1 During play, press the DIGEST button.

- You'll see the 9 individual windows representing each of the chapters on the TV screen.
- When each window is displayed, the first 3 seconds of the chapter will be played.

2 Press \blacktriangle , \blacktriangledown , \blacktriangleleft , \blacktriangleright buttons or NUMBER buttons to select the window you'd like to see, and press the ENTER button.

- Up to 9 windows(chapters) can be displayed on the screen at a time.
- Press the \blacktriangleright button for the next 9 chapters if the movie has more than 9.

- You can play the DVD player starting with the desired chapter after directly moving to the scene you want.
- 'DIGEST' may not operate depending on the disc in use.

Using the Disc View Function

DVD

Track View (VCD)

Displays the beginning view of each track and the track number.

- 1 During play, press the TITLE button.
- 2 Press the \blacktriangle or \blacktriangledown buttons to select Track View. Press the ENTER button.
- 3 Select the desired view by pressing \blacktriangle , \blacktriangledown , \blacktriangleleft , \blacktriangleright buttons.
 - Press the \blacktriangleright button for the next 9 tracks if the movie has more than 9.
- 4 Press the ENTER button.

Index View (VCD)

Displays the equally divided 9 views of the current playing track.

- 1 During play, press the TITLE button.
- 2 Press \blacktriangle or \blacktriangledown buttons to select Index View. Press the ENTER button.
- 3 Select the desired view by pressing \blacktriangle , \blacktriangledown , \blacktriangleleft , \blacktriangleright buttons.
- 4 Press the ENTER button.

- When pressing the TITLE button with a DVD: the disc's TITLE MENU function comes up. A disc must have at least two titles for the TITLE MENU function to work.
- When pressing the TITLE button with a CD: the unit enters the INTRO mode. INTRO lets you listen to the beginning of each track for about 10 seconds.
- You can also operate it using the DIGEST button.

Disc View \blacktriangle \blacktriangledown ENTER

1 Track View

2 Index View

TRACK VIEW



INDEX VIEW

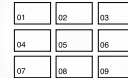

DVD Selecting the Audio Language

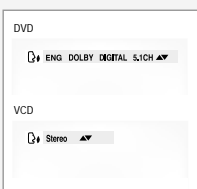

You can select a desired language quickly and easily with the AUDIO button.

- 1 During play, press the AUDIO button.
- 2 Use the ▲ or ▼ buttons to select the desired language on a DVD.
- The audio languages are represented by abbreviations.
- 3 Use the ▲ or ▼ buttons to select Stereo, Right or Left.
(On VCD/CD)

-
- This function depends on what languages are encoded on the disc and may not work with all DVDs.
 - A DVD disc can contain up to 8 audio languages.
 - How to have the same audio language come up whenever you play a DVD; Refer to "Setting Up the Language Features" on page 30.

DVD Selecting the Subtitle Language

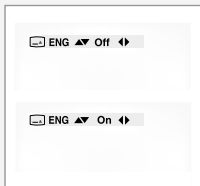

You can select a desired subtitle quickly and easily with the subtitle button.

- 1 During play, press the SUBTITLE button.
- 2 Use the ▲ or ▼ buttons to select the desired subtitle language.
- 3 Use the ◀ or ▶ buttons to determine whether or not the subtitle will be displayed.

- Initially, the subtitling will not appear on screen.
- The subtitle languages are represented by abbreviations.

-
- This function depends on what languages are encoded on the disc and may not work with all DVDs.
 - A DVD disc can contain up to 32 subtitle languages.
 - How to have the same subtitle language come up whenever you play a DVD; Refer to "Setting Up the Language Features" on page 30.

Changing the Camera Angle

DVD

GB

When a DVD contains multiple angles of a particular scene, you can select the Angle function.

Press the ANGLE button to see if an ANGLE (ANGLE) mark is present at the upper right hand corner of the screen.

- 1 When an ANGLE mark is shown, press the ANGLE button, then an ANGLE select icon will appear at the upper left hand corner of the screen.
- 2 Use the ▲ or ▼ buttons to select the desired screen angle.
- 3 To turn off the display, press the ANGLE button again.



DVD Using the Bookmark Function

The Bookmark function lets you select parts of a DVD or VCD (MENU OFF mode) so that you can quickly find the section at a later time.



Using the Bookmark Function (DVD/VCD)

- 1 During play, press the MARK button on the remote. The Bookmark icons will be displayed.
- 2 Use the ◀ or ▶ buttons to move to the desired bookmark icon.
- 3 When you reach the scene you want to mark, press the ENTER button. The icon will change to a number (1, 2, or 3).
- 4 Press the MARK button to turn off the display.

Recalling a Marked Scene

- 1 During play, press the MARK button on the remote.
- 2 Use the ◀ or ▶ buttons to select a marked scene.
- 3 Press the PLAY/STILL button to skip to the marked scene.

Clearing a Bookmark

- 1 During play, press the MARK button on the remote.
- 2 Use the ◀ or ▶ buttons to select the bookmark number you want to delete.
- 3 Press the CLEAR button to delete a bookmark number. Press the MARK button to turn off display.

- Up to three scenes may be marked at a time.
- When in VCD 2.0 mode (MENU ON mode), this function does not work.
- Depending on the disc, the Bookmark function may not work.

44

Using the Zoom

DVD

GB

- 1 During play or still mode, press the ZOOM button on the remote. A square will be displayed on screen.
- 2 Use the ▲, ▼ or ◀, ▶ button to select the part of the screen you want to zoom in on.
- 3 Press the ENTER button.
 - During DVD play : press ENTER to zoom in 2X/4X/2X/Normal in order.
 - During VCD play, press ENTER to zoom in 2X/normal in order.

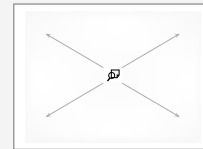

3D Sound Functions

DVD

The simulated surround effect depends on the disc contents. If you connect the unit to your stereo system, you can enhance sound quality and produce a greater surround effect. This feature is useful when you are using the DVD player with a two channel stereo through the analog outputs.

(Discs which are recorded with LPCM or DTS will not work. When the DIGITAL OUTPUT or MPEG-2 is set to BITSTREAM in the DVD SETUP, the 3D Sound function will not work.)

- 1 During play, press the 3D SOUND button. The 3D SOUND mark will be displayed on screen. (Be sure the DIGITAL OUTPUT is set to PCM.)
- 2 Press the ▲ or ▼ buttons to turn the 3D Sound feature on or off.

- 3D Sound is possible only on discs recorded using DOLBY SURROUND or DOLBY DIGITAL. However, some of these discs do not contain rear channel sound signals.
- Depending on the disc, the Zoom and 3D Sound function may not work.



45

When an MP3 Disc is inserted into the DVD PLAYER, the first song file of the first folder plays.

When playing CD-R MP3 discs, please follow the recommendations below:

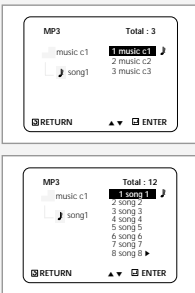

- 1 Press STOP to stop playback of the first song file, then press RETURN to display the music folder menu on the right side of the screen. Up to 8 music folders can be displayed at a time. If you have more than 8 folders on a disc, press the ◀ or ▶ buttons to bring them up on the screen.
- 2 Use the ▲ or ▼ buttons to select the desired music folder, the press ENTER. Use the ▲ or ▼ buttons again to select a song file. Press ENTER to begin playback of the song file.

- When the REPEAT button is pressed during playback, the current song will be played back repeatedly.

- **Your MP3 files should be ISO 9660 or JOLIET format.**
ISO 9660 format and Joliet MP3 files are compatible with Microsoft's DOS and Windows, and with Apple's Mac. These two formats are the most widely used.
- **When naming your MP3 files do not exceed 8 characters, and place ".mp3" as the file extension.** General name format of: Title.mp3. When composing your title, make sure that you use 8 characters or less, have no spaces in the name, and avoid the use of special characters including: (.,\,/,=,+).
- **Use a decompression transfer rate of at least 128 Kbps when recording MP3 files.**
Sound quality with MP3 files basically depends on the rate of compression/decompression you choose. Getting audio CD quality sound requires an analog/digital sampling rate (conversion to MP3 format) of at least 128 Kbps and up to 160 Kbps. However, choosing higher rates, like 192 Kbps or more, only rarely give better sound quality. Conversely, files with sampling rates below 128 Kbps will not be played properly.
- **Do not try recording copyright protected MP3 files.**
Certain "secured" files are encrypted and code protected to prevent illegal copying. These files are of the following types: Windows Media™ (registered trade mark of Microsoft Inc) and SDMITM (registered trade mark of The SDMI Foundation). You cannot copy such files.
- **Your DVD player only accepts one level of file directory. Consequently you must choose:**
 - either to save all your MP3 recording files at the root of the disc;
 - and/or create folders in the directory for each artist or music type (e.g.classical, rock, jazz, etc)
- **Important:** The above recommendations cannot be taken as a guarantee that the DVD player will play MP3 recordings, or as an assurance of sound quality. You should note that certain technologies and methods for MP3 file recording on CD-Rs prevent optimal playback of these files on your DVD player (degraded sound quality and in some cases, inability of the player to read the files).

Technical Specifications

General	Rated voltage	110 - 240V~, 50/60Hz
	Power consumption	25 Watts
	Weight	4.5 Kg
	Size	430mm X 330mm X 100mm
	Operating ambient temperature	+5°C ~ +35°C
	Installation conditions	Operation position : Horizontal, Relative humidity : Below 75%
Input	Video input (Rear)	RCA jack : 1.0Vp-p (unbalanced) 75Ω
	Audio input (Rear)	RCA jack : -8dBm, 47Kohm unbalanced
Output	Audio (DVD, VCR)	RCA jack
	Audio (DVD only)	Digital audio out (OPTICAL, COAXIAL) Analog audio out (RCA)
	Video (DVD, VCR)	RCA jack
	Video (DVD only)	S-Video out Component out
VCR	Tape format	VHS type video tape, S-VHS type video tape (Playback only)
	Color system	PAL, MESECAM, NTSC3.58, NTSC4.43, NTSC playback on PAL TV
	Video S/N	Above 43dB (standard recording)
	Resolution	Above 240 lines (standard recording)
	Audio S/N	39dB
	Audio frequency characteristics	100Hz - 8KHz
DVD	Disc	DVD, CD (12cm), CD (8cm), VIDEO-CD (12cm)
	Audio S/N	95dB
	Audio dynamic range	105dB

Problems and Solutions (VCR)

Before contacting the Samsung after-sales service, perform the following simple checks.

Problem	Explanation/Solution
No power	<ul style="list-style-type: none"> ◆ Check that the power plug is connected to a wall outlet. ◆ Have you pressed the STANDBY/ON button?
You cannot insert a video cassette	◆ A video cassette can only be inserted with the window side up and the safety tab facing you.
No playback picture or the picture is distorted	◆ Check to see if you are using a prerecorded tape.
Noise bars or streaks on playback	◆ Press the TRK (↵ or ↘) buttons to minimize this effect.
When the ► button is pressed during playback, the still picture has severe "noise bars" streaks	◆ A still picture may have "noise bars", depending on the condition of the tape. Press the TRK (↵ or ↘) buttons during SLOW motion to minimize this effect.
Video Head Cleaning	◆ If poor pictures appear on a variety of cassettes, the video heads may need cleaning. This is not a common problem and unless it appears, the heads should not be cleaned. When cleaning the video heads, read all instructions provided with the head cleaning cassette. Incorrect head cleaning can permanently damage the video heads.









If you are unable to solve the problem after reading the above instructions, note:

- ◆ The model and serial number on the rear of your DVD-VCR
- ◆ The warranty information
- ◆ A clear description of the problem

Then contact your nearest SAMSUNG after-sales service.

Troubleshooting Guide (DVD)

Before requesting service (troubleshooting)

Problem	Action	Page
Disc does not play.	<ul style="list-style-type: none"> ◆ Ensure that the disc is installed with the label side facing up. ◆ Check the region number of the DVD. ◆ This player cannot play CD-ROMs, DVD-ROMs, etc. Insert a DVD, a VIDEO-CD or a CD. 	P5
5.1 channel sound is not being reproduced.	<ul style="list-style-type: none"> ◆ 5.1 channel sound is reproduced only when the following conditions are met. : <ol style="list-style-type: none"> 1) The DVD-VCR player is connected with the proper amplifier 2) The disc is recorded with 5.1 channel sound. ◆ Check whether the disc being played has the "Dolby 5.1 ch" mark on the outside. ◆ Check if your audio system is connected and working properly. 	P32
The  icon appears on screen.	<ul style="list-style-type: none"> ◆ The features or action cannot be completed at this time because: <ol style="list-style-type: none"> 1. The DVD's software restricts it. 2. The DVD's software doesn't support the feature (e.g., angles). 3. The feature is not available at the moment. 4. You've requested a title or chapter number or search time that is out of range. 	P35-45
Playback mode differs from the Setup Menu selection.	<ul style="list-style-type: none"> ◆ Some of the functions selected in the Setup Menu may not work properly if the disc is not encoded with the corresponding function. 	P28-33
The screen ratio cannot be changed.	<ul style="list-style-type: none"> ◆ The Screen Ratio is fixed on your DVDs. 	P33
No audio.	<ul style="list-style-type: none"> ◆ Make sure you have selected the correct Digital Output in the Audio Options Menu. 	P32
Forgot password	<ul style="list-style-type: none"> ◆ Press power on from a cold start with no disc in the unit. Press the  and  buttons simultaneously on the front panel for five seconds. ◆ Turn off the power, and then back on. Press the SETUP button. Use the  or  buttons to select DVD option. Press the ENTER button. Use the  or  buttons to select parental mode. Press the ENTER button. ◆ The Parental Mode is now unlocked as indicated on the display. Press the  or  button to select Parental. The Create Password display will appear. You can now set your rating level and change your password to a new number. 	P31
If you experience other problems.	<ul style="list-style-type: none"> ◆ Go to the contents and find the section of the instruction book that contains the explanations regarding the current problem, and follow the procedure once again. ◆ If the problem still cannot be solved, please contact your nearest authorized service center. 	

THIS APPLIANCE IS DISTRIBUTED BY



www.samsung.com

AK68-00067E