



User Guide

BT FREELANCE XA 2000



**Please open this page for an 'at a glance'
guide to your BT Freelance XA 2000**



At a glance

Volume buttons

Use to adjust the handset earpiece speech volume (see page 15) and handset and base ringer volume, see pages 21 and 24.

Also used to access the redial and calls list and scroll through the directory, menu options, redial and calls list.

Secrecy button

During a call press to mute the call so your caller cannot hear you talk to someone close by, see page 17.

Also used as a delete, edit and exit button.

Talk button

Use to make, receive and end calls, see pages 14-15.

Keypad

Recall/Power button

For use with a switchboard/ PBX and BT Calling Features, see page 38.

Also used to switch off the handset, see page 14.

Handset

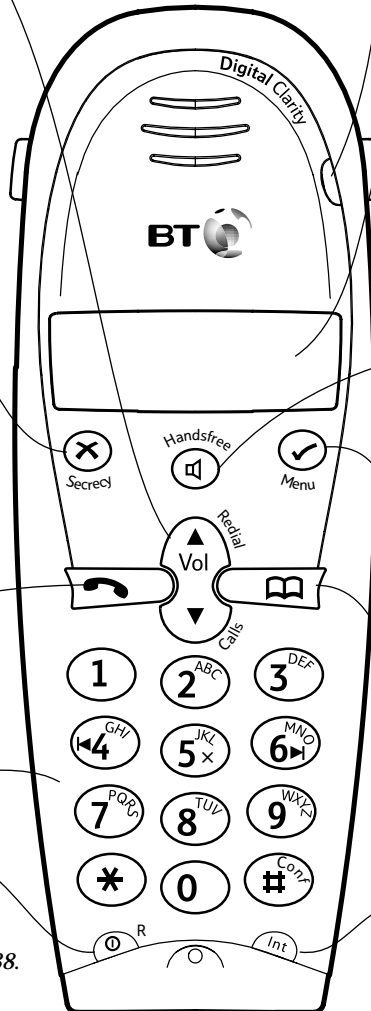

Red light

To indicate that the phone is ringing or in use.

Liquid Crystal Display

Display shows you incoming caller's details, the name and/or number you have dialled, and the status of the handset.

Handsfree button

Use to answer calls or make a call using the handsfree mode, see page 16.

Menu button

Use to access and select the options in the menu, see pages 4-5.

Phonebook button

Use to access the 50 names and numbers stored in the phonebook, see page 18.

Internal button

To make internal calls between handsets registered to the base, see page 33.

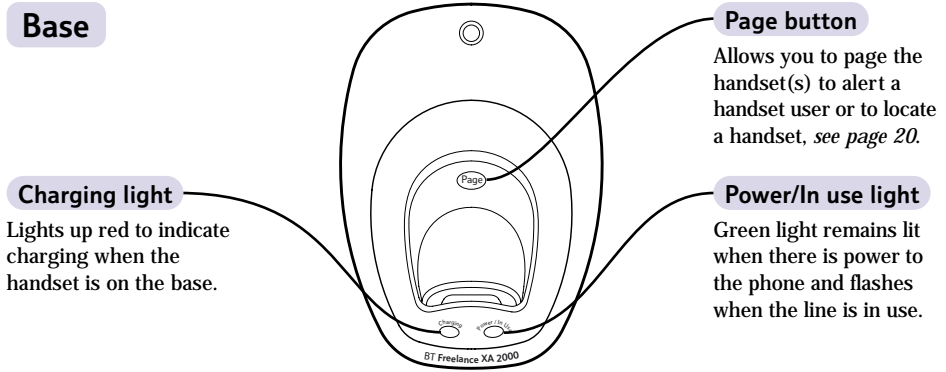



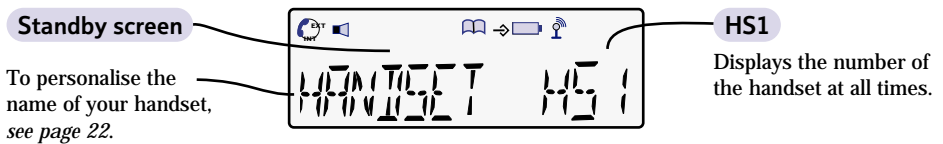





































Explanation of the display icons



Icon	Steady	Flashing
EXT	External line in use	Incoming call
INT	Internal call	Internal call from another handset
	In calls list	New call received in calls list
	3 way conversation in progress	
		Battery exhausted
	Battery weak	
	Battery half-full	
	Battery full	
	Phonebook	
	Menu in use	
	Handset linked to base station	Out of range or searching for base station
	In handsfree mode	

Quick Guide

Information for the handset settings

Function	Key combination
Answer a call/End a call	
Make a call	 
Redial a number	 
Store a number in the memory	   enter the name  enter the telephone number 
Dial a number in the memory	  
Adjust the earpiece volume	During a call, press the   during a call until the required level is reached.
Secrecy on/off	During a call, press  to switch on and again to switch off.
Transfer call to another handset	 enter handset number 
Three way conversation	 enter handset number  
Access to redial list	  – keep pressing to scroll.
Access to calls list	  – keep pressing to scroll.
Set handset ringer volume	   HANDSET   RING VOL    to select volume 
Set base unit ringer volume	  SETUP  BASE VOL    to select volume 

Important

*If the handset is sitting in the base when a call comes in, you can pick it up and answer it automatically without pressing the  button.

Menu Structure

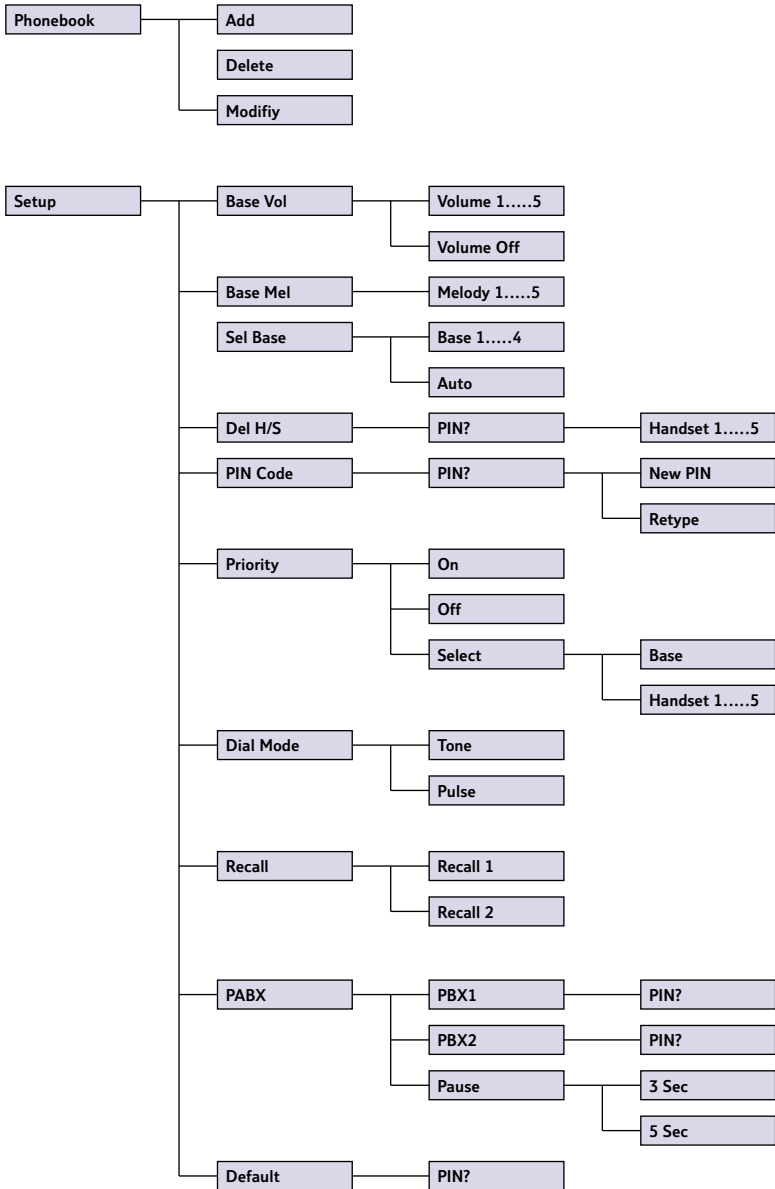

Cont.....

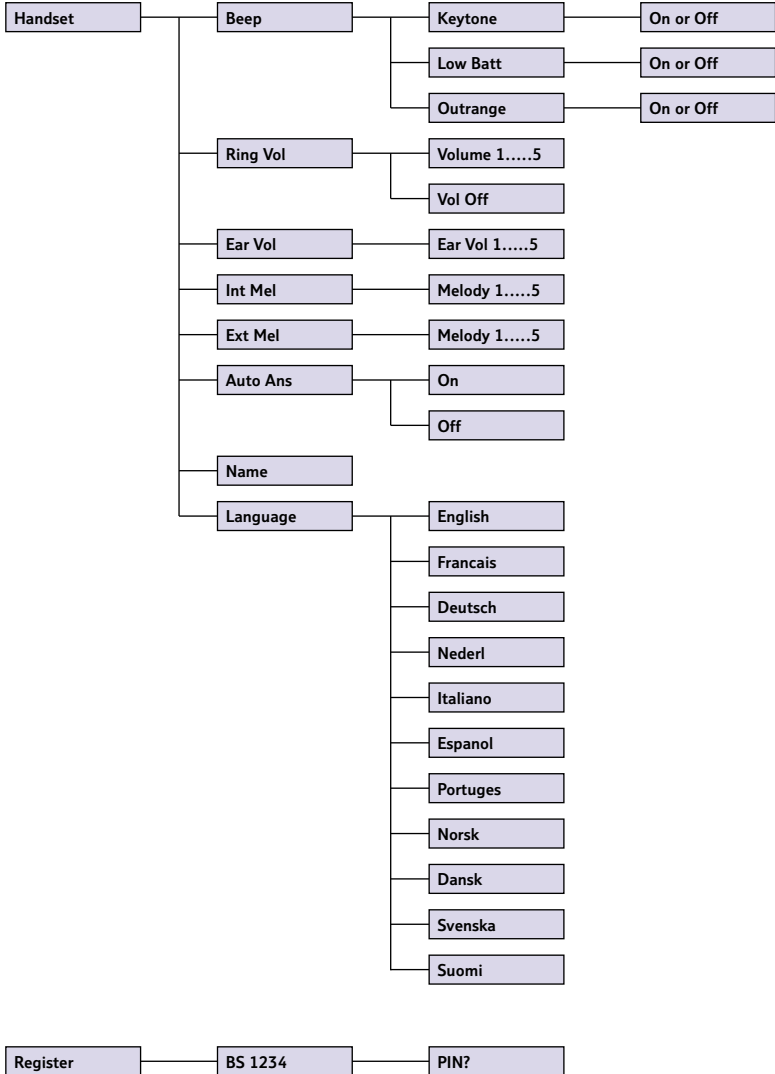

Important. If you make a mistake you can return to the previous menu heading by pressing the **X** button. If you press and hold the **X** button at any time you will return to the standby screen. After 30 seconds if no buttons are pressed the handset will automatically return to the standby screen.

In this guide

Note

There is a detailed INDEX at the end of this guide, see page 40.

At a glance

Handset	1
Display icons	2
Quick Guide	3
Menu structure	4

Introduction

Unpacking your BT Freelance XA 2000	7
For your records	8
Safety information	9

Setting up

Plan the location	10
-------------------	----

Using the telephone

Making and receiving calls	14
Call timer	14
Handsfree	16
Redial	16
Secrecy	17
Name and number Phonebook	17
Paging handsets	20

Handset settings

21

Base settings

24

Caller Display and Call Waiting

Using Caller Display	27
Calls list	27
Call Waiting	29

Using BT Freelance XA 2000 additional handsets

Internal calls	31
Transferring calls	33
Three-way conversation	33

Help

35

General information

Guarantee	37
Technical information	38
Switchboard compatibility	38
Switchboard external line access code	38
Recall	38

Index

40

Note

In this user guide, we've included helpful tips and useful notes. They are shown in a white box like this.

Introduction

Your BT Freelance XA 2000 has been designed for ease of use and made to the high standards set by BT

Please read the instructions carefully before use and keep this user guide for future reference.

DECT

By purchasing the BT Freelance XA 2000 you now own a product which combines the advantages of cordless operation with the performance of a high quality corded telephone. It complies with the Digitally Enhanced Cordless Telecommunications (DECT) standard and offers unparalleled quality and features.

You can use up to 5 handsets with your BT Freelance XA 2000 base station without the need for additional wiring.

This user guide applies to both single and multiple handset packs. The internal call functions described in this guide apply only to BT Freelance XA 2000 base stations with more than one handset connected.

Important

If you wear a hearing aid, please note that the BT Freelance XA 2000 works by sending radio signals between the base station and the handset. These signals may interfere with some hearing aids, causing a humming noise.

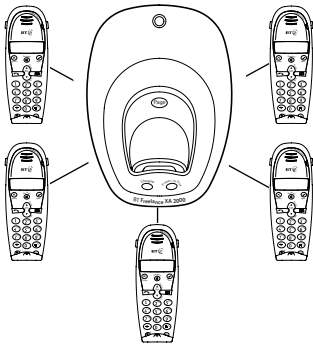

Unpacking your BT Freelance XA 2000

If anything is missing, please contact your place of purchase immediately.

One BT Freelance XA 2000 base station



One BT Freelance XA 2000 handset



2 x AAA rechargeable batteries (Ni-MH)



One battery cover



One power supply for base station
(Item code: 872260)



One telephone line cord



One belt clip



In addition:

If you have purchased a BT Freelance XA 2000 multiple pack you will receive the following for each additional handset:

One BT Freelance XA 2000 handset



One BT Freelance XA 2000 charger



2 x AAA rechargeable batteries (Ni-MH)



One battery cover



One power supply for charger
(Item code: 021299)



One belt clip



For your records

Date of purchase:

Place of purchase:

Serial number:

For guarantee purposes proof of purchase is required so please keep your receipt.

If you change your PIN, keep a record of the new number here:
(original setting 0000)

--	--	--	--

See page 25 for more information.

Safety information

General

Only use the power supply included with the product. Using an unauthorised power supply will invalidate your guarantee and may damage the telephone. The item number for the power supply used with the base station is 872260. The item number for the power supply used with the charger is 021299 (only applicable when you have purchased a BT Freelance XA 2000 multiple pack).

Only use the approved rechargeable batteries supplied. Spare rechargeable batteries are available from the BT Freelance Helpline **0870 605 8047**.

Do not open the handset or base station. This could expose you to high voltages or other risks. Contact the Helpline for all repairs.

Radio signals transmitted between the handset and base may cause interference to hearing aids.

It is recommended that advice from a qualified expert be sought before using this product in the vicinity of emergency/intensive care medical equipment.

It is recommended that if you have a pacemaker fitted you check with a medical expert before using this product.

Your product may interfere with other electrical equipment, e.g. TV and radio sets, clock/alarms and computers if placed too close. It is recommended that you place your product at least one metre

away from such appliances to minimise any risk of interference.

Never dispose of the batteries in a fire. There is a serious risk of explosion and/or the release of highly toxic chemicals.

Cleaning

Simply clean the handset and base station with a damp (not wet) cloth, or an anti-static wipe. Never use household polish as this will damage the product. Never use a dry cloth as this may cause a static shock.

Environmental

Do not expose to direct sunlight.

The product may heat up when the batteries are being recharged. This is normal. However, we recommend that you do not place the product on antique/veneered wood to avoid damage.

Do not stand your product on carpets or other surfaces which generate fibres, or place it in locations preventing the free flow of air over its surfaces.

Do not submerge any part of your product in water and do not use it in damp conditions, such as bathrooms.

Do not expose your product to fire, explosive or other hazardous conditions.

There is a slight chance that your phone could be damaged by an electrical storm. We recommend that you unplug the power and telephone line cord for the duration of the storm.

Setting up

Follow these steps to set up your BT Frealence XA 2000 ready for use

Plan the location

Position your BT Frealence XA 2000 within 2 metres of a power socket and phone socket otherwise extension cables will be required.

Make sure it is at least 1 metre away from other electrical products to avoid interference.

Do not place your BT Frealence XA 2000 product in the bathroom or other humid areas.

Note

The BT Frealence XA 2000 has a range of 300 metres outdoors when there is a clear line of sight between the base and handset. When there is no clear line of sight between the base and handset, e.g. base indoors and handset either indoors or outdoors, the range could be reduced to 50 metres. Thick stone walls will severely affect the range.

1 Connect the power supply to the base

Plug the power adaptor into the mains power socket and switch on. The green Power/In Use light comes on.

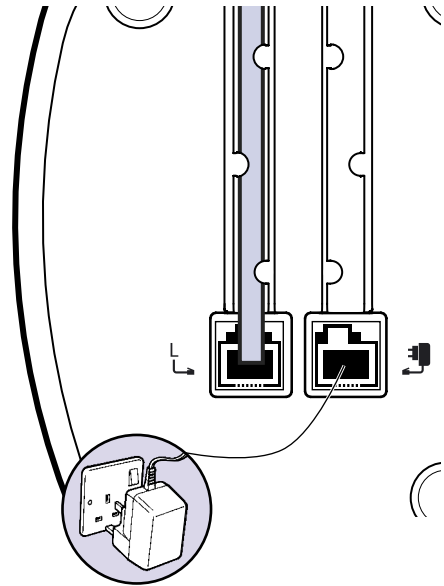

Note

The base station must be plugged into the mains power socket at all times.

2 Install the rechargeable batteries in the handset

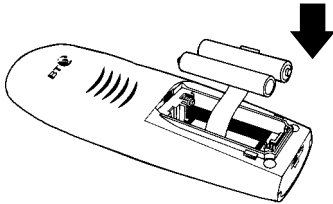

The handset uses two rechargeable Nickel Metal Hydride (Ni-MH) AAA batteries which are supplied. Take care to insert the batteries as shown and then fit the battery cover (the battery cover may be found in the packaging with the batteries).

3 Charge the handset batteries for at least 16 hours

Before you use your BT Freulance XA 2000 for the first time, it is important to have the handset batteries fully charged. The batteries need to charge continuously for at least 16 hours to reach full charge.

Place the handset on the base. The red charging light will come on. The handset comes pre-registered to the base station as HANDSET HS1. This is shown on the display. The  icon and the battery icon are shown on the display. Once the handset is fully charged, the display shows a full battery symbol.

Please note that the red charging light will remain on even when the batteries are fully charged.

BATTERY LEVELS



Battery low warning

If the handset battery symbol is empty and flashing, and you hear a warning beep every 10 seconds, you will need to recharge your handset before you can use it.

Note

The  symbol on your handset display indicates when you are in range of the base station. If the symbol flashes and you hear a warning beep, you are out of range and will need to move closer to the base station.

Battery performance

Under no circumstances should non-rechargeable batteries be used. Only use the approved batteries, type: rechargeable Nickel Metal Hydride (Ni-MH); size AAA; capacity 550mAh 1.2v. Using unapproved batteries will invalidate your guarantee and may damage the telephone.

To keep your batteries in the best condition, leave the handset off the base station for a few hours at a time. (after the initial 16 hour charge).

Please note, however, that new Nickel Metal Hydride (Ni-MH) batteries do not reach their full capacity until they have been in normal use for several days.

*Fully discharging the batteries at least once a week will help them last as long as possible. However, the charge capacity of rechargeable batteries will reduce with time as they wear out, so reducing the talk/standby time of the handset. Eventually they will need to be replaced. New batteries can be obtained from the BT Freelance Helpline **0870 605 8047**.*

Note: *Under ideal conditions, the handset batteries should give about 12 hours talktime or 200 hours standby on a single charge. Optimum times for talk and standby are only achieved when the handset batteries are fully charged.*

- 4** Connect the telephone line cord to the BT Freelance XA 2000 base station

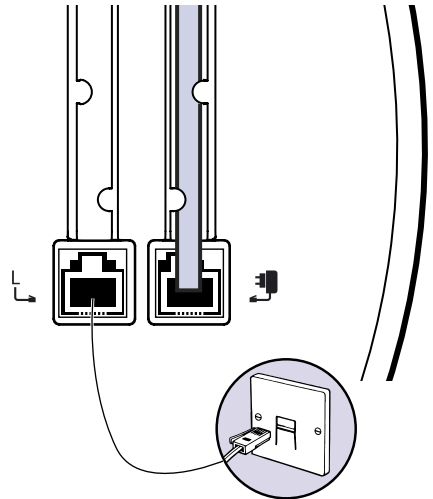

- 5** Connect the telephone line cord

Note

It is recommended that you do not connect the telephone line cord to the phone socket until your handset is fully charged. This will prevent the risk of the batteries discharging during a conversation, which could cause you to lose a call.

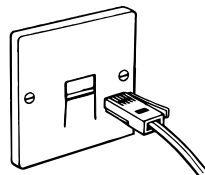

6 Attach the belt clip (optional)

Fit the belt clip onto the back of the handset if required.

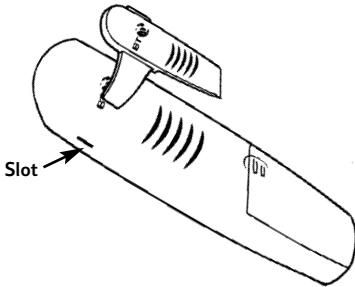
**Customer Helpline**

If you have any difficulties setting up your BT Freeland XA 2000 please call the Helpline on 0870 605 8047.

Your BT Freeland XA 2000 is now ready for use.

Additionally, if you have purchased a BT Freeland XA 2000 multiple pack you will need to do the following for each additional handset:

1. Connect the power supply to the charger.

Plug the power adaptor into the mains power socket on the underside of the charger.

The item code for the power supply used with the charger is 021299.

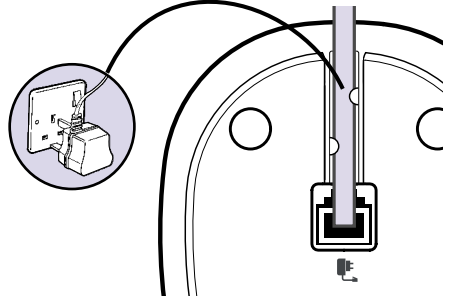

Plug the adaptor into the mains power supply and switch on.

Note

The charger must be plugged into the mains power socket at all times.

2. Install the rechargeable batteries in the handset.



3. Charge the handset batteries for at least 16 hours.

Your BT Freeland XA 2000 additional handset(s) comes pre-registered to the main base station as HANDSET HS2 (HS3, HS4, HS5). This will be shown on the display.

Your BT Freeland XA 2000 multiple pack is now ready for use.

Using the telephone

Note

To exit and return to the previous menu at any time, press the  button. If you press and hold the  button you will return to the standby screen.

To switch the handset on and off



Press *and hold* the **POWER** button to switch the handset off.



To switch the handset on, press *and hold* the **POWER** button again.

Making and receiving calls

To make an external call



Press the **TALK** button. You will hear the dial tone and the display will show the  symbol.



Enter the number you want. The number is dialled automatically.

Preparatory dialling

Preparatory dialling allows you to enter the number before pressing the **TALK** button. This enables you to correct any mistakes before you actually make the call.



Enter the number to be dialled.

The number is shown in the display.



(If you make a mistake, press the  button to delete the incorrect digit).

When you have entered the number correctly, press the  **TALK** button to dial the number.

Call timer

Your handset will automatically time the duration of all external calls.

The handset display shows the call duration both during your call and for a few seconds after it is complete.

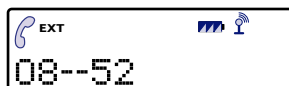

To end a call



Press the **TALK** button.

Or

Place the handset back on the base.

To receive a call

When the phone rings the display will show **CALL** and the **EXT** symbol will flash.

If you have subscribed to a Caller Display Service, the number (and name if stored in the phonebook) will be displayed.



Press the **TALK** button.

Or

If the handset is on the base, simply lift it up and speak.

Note

You can switch the Auto-Talk feature on or off. Please see page 22.

To adjust the speech volume during a call

During a call:

You can adjust the earpiece volume. There are 5 levels to choose from.



Press the **UP** or **DOWN** button until you reach the required level. This will be shown on the display.
eg: EAR VOL 3.

In standby mode:



Press the **✓** button.



Press the **DOWN** button until **HANDESET** is displayed.



Press the **✓** button.



Press the **DOWN** button until **EAR VOL** is displayed.



Press the **✓** button.



Press the **UP** or **DOWN** button until you reach the required level.



Press the **✓** button to confirm the selected level.



Press *and hold* the **✕** button to return to the standby screen.



Handsfree

Handsfree allows you to talk to your caller without holding the handset and enables other people in the room to listen to your conversation.

To make a handsfree call



Dial the number.

Press the **HANDSFREE** button.

The display will show the  icon to indicate handsfree is active. You will hear the number being dialled out.

To switch back to using the handset at any time, press the **HANDSFREE** button.

To end the call, press the **TALK** button.



To answer a call in handsfree

When the phone rings:



Press the **HANDSFREE** button. The call is transferred to the loudspeaker.

To switch to handsfree during a call

During a call you can switch to handsfree mode.



Press the **HANDSFREE** button. The call is transferred to the loudspeaker.



Press the **HANDSFREE** button to switch back to using the handset.

To adjust the handsfree volume

Whilst in handsfree mode you can increase or decrease the handsfree volume. There are 5 volume levels to choose from.



Press the **UP** or **DOWN** button to adjust the volume.

The volume will be adjusted accordingly.

Redial

You can redial up to 5 of the last numbers called. They are stored in the redial list. If you have stored a name to go with a number in the phonebook, the name will be displayed instead. See *"Name and number Phonebook"*, page 17.

Dial from the redial list



Press the **UP** button to enter the redial list.



Continue pressing the **UP** button to view the next number in order of most recent first.



Press the **TALK** button when the number (or name) you want to call is displayed. The number is dialled automatically.

Secrecy

When on a call you can talk to someone in the same room, without your caller hearing.

To switch secrecy on / off



During a call, press the **X** button. The display will show **MUTE**. Your caller cannot hear you.



Press the **X** button again to resume your call.

Name and number Phonebook

You can store up to 50 of your most frequently used names and numbers in the Phonebook. Stored numbers can be no longer than 20 digits and a maximum of 8 characters can be stored.

To store a name and number in the Phonebook



Press the **✓** button to enter the menu.



The display will show **PHONEBK**, press the **✓** button.



The display will show **ADD**, press the **✓** button.



The display shows **NAME ?**

Enter the name using the letters on the keypad. Names can be no longer than 8 characters.

Entering names:



Use the keypad letters to enter names, e.g. if you wish to store the name **TOM**:



To enter the letter **T**, press the **8** button once.



To enter **O**, press the **6** button *three times* and wait for the cursor to move across.



To enter M, press the **6** button once.



If you enter a digit incorrectly, press the **X** button to delete it.



Press **✓** to confirm the name. You will hear a confirmation beep.

The display shows NUMBER?



Enter the telephone number you want to store.



Press the **✓** button. You will hear a confirmation beep.



Alternatively, press the **✓** button to continue storing entries in the phonebook.



Press *and hold* the **X** button to return to the standby screen.

Note

*Press the **1** button once to insert a space, press twice for a - (hyphen), press 3 times for the number 1.*

Note

If you subscribe to a Caller Display Service (see page 27) and want directory names to be displayed when a call is received from one of your directory numbers, you must ensure that you always enter the full telephone number, including the national code.

To enter a pause in a stored number

You may want to enter a pause when storing international numbers, charge card numbers or if you connect your telephone to a switchboard. (For more information on switchboard use *see page 38.*)



When storing the number, press *and hold* the **UP** button, until a P is displayed, at the point where you want to enter the pause.

You may enter as many pauses as required.

To dial a name and number in the phonebook



Press the **PHONEBOOK** button to enter the phonebook.



Use the **UP** or **DOWN** button to scroll through.

Or



Enter the first letter of the name you want, e.g. for Tom, press the **8** button to search for names beginning with T.



Press the **TALK** button to dial the number of the name displayed. The number is dialled automatically.

Note

You can scroll in either direction to search through the list.

To edit an entry in the Phonebook



Press the button to enter the menu.



The display will show PHONEBK, press the button.



Use the **DOWN** button to scroll to MODIFY and press the button.



Use the **UP** or **DOWN** button to find the name you want to edit.



Press the button.



Use the button to delete unwanted letters. You can enter new letters as shown in 'Entering names' on page 17.



Press to store the new name. You will hear a confirmation beep.



The number will be displayed. Use the button to delete unwanted digits and re-enter the correct ones.



Press the button to store the new number. You will hear a confirmation beep.



Press *and hold* the button to return to the standby screen.

To delete a Phonebook entry



Press the button to enter the menu.



The display will show PHONEBK, press the button.



Use the **DOWN** button to scroll to DELETE and press the button.



Use the **UP** and **DOWN** buttons to scroll through to the entry you want to delete.



When you have found the name to delete, press the button.



The number will be displayed, press the button.



The display will show CONFIRM?, press the button.

You will hear a confirmation beep. The number is now deleted.



Press *and hold* the button to return to the standby screen.

Paging handsets

You can page your handset(s) from the base station to alert a handset user that they are wanted or to locate a missing handset.

Note

Paging calls cannot be answered by a handset.

To page a handset from the base

Page

Press the **PAGE** button on the base.

The handset(s) will ring.
The display will show
INT 0000 flashing.

Page

To stop paging, press the **PAGE** button again.

Or



To stop paging, press any button on the handset.

Handset settings

To switch keypad beeps on and off



Press the button to enter the menu.



Use the **DOWN** button to scroll to **HANDSET** and press the button.



The display will show **BEEP**, press the button.



The display will show **KEYTONE**, press the button.



Use the **UP** or **DOWN** button to select either **ON** or **OFF**.



Press the button. You will hear a confirmation beep.



Press *and hold* the button to return to the standby screen.

Important

Press and hold the button at any time to exit the menu and return to the standby screen.

To adjust the handset ringer volume

There are 5 levels to choose from (**1-5**), or you can turn the ringer off altogether.



Press the button to enter the menu.



Use the **DOWN** button to scroll to **HANDSET** and press the button.



Use the **DOWN** button to scroll to **RING VOL** and press the button.



You will hear the current volume setting and it will be shown on the display.



Use the **UP** or **DOWN** button to select the required volume (**VOLUME 1-5** or **VOL OFF**). You will hear a sample ring.



Press the button to confirm the new setting. You will hear a confirmation tone.



Press *and hold* the button to return to the standby screen.

To set the external or internal ringer melody

There are 5 melodies to choose from and you have the option to choose a different melody for external and internal calls. (Internal calls for when you have more than one handset).



Press the **✓** button to enter the menu.



Use the **DOWN** button to scroll to **HANDSET** and press the **✓** button.



Use the **DOWN** button to scroll to either **INT MEL** or **EXT MEL**.



Press the **✓** button.



You will hear the current melody setting and it will be shown on the display. e.g. **MELODY 4**.



Use the **UP** or **DOWN** button to select the required melody. You will hear a sample melody.



Press the **✓** button to confirm the new melody. You will hear a confirmation tone.



Press *and hold* the **✕** button to return to the standby screen.

To switch auto-talk on/off

When the handset is on the base or the charging unit you can answer the call by picking it up from the base. This will automatically answer the call without having to press the **TALK** button.



Press the **✓** button.



Use the **DOWN** button to scroll to **HANDSET** and press the **✓** button.



Use the **DOWN** button to scroll to **AUTO ANS**.



Press the **✓** button.



Use the **UP** or **DOWN** button to turn **AUTO-TALK ON** or **OFF**.



Press the **✓** button to confirm.



Press *and hold* the **✕** button to return to the standby screen.



To name a handset

The handset name is pre-set as **HANDSET**, however, you can personalise each handset by giving it a name. A maximum of 8 characters can be stored.



Press the button to enter the menu.



Use the **DOWN** button to scroll to **HANDSET** and press the button.



Use the **DOWN** button to scroll to **NAME** and press the button.



Press the **X** button to delete the name already set.



Enter the name you want using the keypad and press the button, correct any mistakes by pressing the **X** button.



You will hear a confirmation beep.



Press *and hold* the **X** button to return to the standby screen.

To set the handset language

If you wish, you can change the language used on the handset display. You can choose from English, Francais, Deutsch, Nederl, Italiano, Espanol, Portuges, Norsk, Dansk, Svenska and Suomi.



Press the button to enter the menu.



Use the **DOWN** button to scroll to **HANDSET** and press the button.



Use the **DOWN** button to scroll to **LANGUAGE** and press the button.



Use the **UP** or **DOWN** button to scroll through the language options.



Press the button to confirm your choice. You will hear a confirmation beep.



Press *and hold* the **X** button to return to the standby screen.

Note

To default back to the English language follow:



Press the **MENU** button.



Press the **DOWN** button *twice*.



Press the **MENU** button.



Press the **DOWN** button *seven times*.



Press the **MENU** button.



Press the **UP** or **DOWN** button until **ENGLISH** is displayed.



Press the **MENU** button *once*.

Base settings

To adjust the base ringer volume

There are 5 levels to choose from (1-5), or you can turn the ringer off altogether.



Press the  button to enter the menu.



Use the **DOWN** button to scroll to **SETUP** and press the  button.



The display will show **BASE VOL**. Press the  button.



Use the **UP** or **DOWN** button to select the required volume (**VOLUME 1-5** or **VOL OFF**). You will hear a sample ring.



Press the  button to confirm the new setting. You will hear a confirmation beep.



Press *and hold* the  button to return to the standby screen.

To adjust the base ringer melody

There are 5 melodies to choose from (1-5)



Press the  button to enter the menu.



Use the **DOWN** button to scroll to **SETUP** and press the  button.



Use the **DOWN** button to scroll to **BASE MEL** and press the  button.



Use the **UP** or **DOWN** button to select the required melody (**MELODY 1-5**). You will hear a sample melody.



Press the  button to confirm the new setting. You will hear a confirmation beep.



Press *and hold* the  button to return to the standby screen.

To select a base station

If a handset is registered to more than one base station, you can select which base your handset will use.

For more information on registering your handset to another base, *see page 31*.



Press the button to enter the menu.



Use the **DOWN** button to scroll to **SETUP** and press the button.



Use the **DOWN** button to scroll to **SEL BASE** and press the button.



Use the **UP** or **DOWN** button to select the base you want (BASE 1-4).



Press the button. You will hear a confirmation beep.



Press *and hold* the button to return to the standby screen.

To change the base station PIN code

If you change the base station PIN, keep a record of the new number by writing it in the space provided on *page 8*. You will need to use your base station PIN for registering handsets and for some other optional settings.



Press the button to enter the menu.



Use the **DOWN** button to scroll to **SETUP** and press the button.



Use the **DOWN** button to scroll to **PIN CODE** and press the button.



The display will show **PIN?**



Enter your 4-digit PIN (original setting 0000).



Press the button.

The display will show **NEW PIN**.



Enter your new 4-digit PIN.



Press the button.

The display will show **RETYPE**.



Re-enter your new 4-digit PIN.



Press the button. You will hear a confirmation beep.



Press *and hold* the button to return to the standby screen.

To default/reset the handset and base to their original/default factory settings

Please note that if you reset your BT Freelance XA 2000 the Phonebook, Redial and Calls list will be deleted.



Press the button to enter the menu.



Use the **DOWN** button to scroll to **SETUP** and press the button.



Use the **DOWN** button to scroll to **DEFAULT** and press the button.



The display will show **PIN?**



Enter the base PIN (original setting 0000)



Press the button.

You will hear a confirmation tone at the base and handset. The handset display will flash **BASE 1** and then **HANDSET HS1**.

Your BT Freelance XA 2000 is now reset to the factory settings.

The default settings are:

Earpiece volume	3
Handset & Base ringer volume	5
Handset & Base melody	1
PIN code	0000
Handset name	HANDSET
Handset language	ENGLISH
Button beeps	ON
Battery low indicator beeps	ON
Out of range warning beeps	ON
Auto answer	ON
Dialling mode	DTMF
Pause after picking up line / dial-out code	3 seconds
Phonebook	Empty
Redial list	Empty
Calls list	Empty

Caller Display and Call Waiting

Important

To use Caller Display or Call Waiting you must first subscribe to your network provider's Caller Display or Call Waiting Service. A quarterly fee is payable.

For more information on BT's Calling Features, call BT free on 0800 800 150.

Using Caller Display

If you subscribe to a Caller Display Service you can see your caller's number (provided it is not withheld) on your handset display, as well as the time and date of their call. If you have your caller's name and number stored in your handset phonebook, you will see the name of your caller displayed instead of the number.

Please ensure that you have stored the full telephone number, including the area code, otherwise the name will not match the number stored in the phonebook.

Whether you take a call or not, the caller's details are stored in the Calls list. You can display, scroll through and dial numbers on the list and copy them into the phonebook.

Caller information not available

With some incoming calls the telephone number of the caller is not available and cannot therefore be displayed.

In this case, your BT Freelance XA 2000 provides you with some explanatory information about the type of call received. This will be one of the following.

UNAVAILA

The number is unavailable.

WITHHELD

The caller has withheld their number.

RINGBACK

Ringback call.

OPERATOR

The call has been made via the operator.

PAYPHONE

The caller is ringing from a payphone.

INTERNAT

International call.

Calls list

The Calls list contains the telephone numbers of your last 20 callers.

New calls in the Calls list are indicated by the flashing  symbol on the display.

If a call is received when the Calls list is full then the oldest entry will be deleted automatically.

To enter and view the Calls list



Press the **DOWN** button to enter the Calls list. The  symbol is displayed.



Use the **UP** or **DOWN** button to scroll backwards and forwards through the Calls list.

If the 'name' of your caller has been stored in the phonebook, this will be displayed. Press the  button and the number will be displayed.



Press the  button and the time and date of the call will be displayed.



Keep pressing the  button to return to the Calls list entry.



Note

Press and hold the  button to return to the standby screen.

To dial a number from the Calls list



Press the **DOWN** button to enter the Calls list.



Use the **UP** or **DOWN** button to scroll to the number you want to dial.



Press the **TALK** button. The number will be dialled automatically.

To store a number from the Calls list into the Phonebook



Press the **DOWN** button to enter the Calls list.



Use the **UP** or **DOWN** button to scroll to the number you want to store in the phonebook.



Press the  button.

The display shows the date and time of the call.



Press the  button again, the display shows **ADD**.



Press the  button, the display shows **NAME ?**.



Press keypad buttons to enter name as described before under the "Entering names" section.

Note

You can enter names up to 8 characters long. If necessary, you can edit the entry, when the entry is correct, press the  button. The number is now stored in the phonebook.



Press the  button.

The name and number are now stored in the phonebook.

Important

Once stored in the phonebook the number will be deleted from the Calls list.

To delete a number from the Calls list



Press the **DOWN** button to enter the Calls list.



Use the **UP** or **DOWN** button to scroll to the number you want to delete.



Press the **✓** button *twice*, **ADD** will be displayed.



Use the **UP** or **DOWN** button to scroll to **DELETE ?** and press the **✓** button.



The number is deleted from the Calls list.

To delete all numbers from the Calls list



Press the **DOWN** button to enter the Calls list.



Press the **X** button. The display will show **DEL ALL**.



Press the **✓** button. The display will show **EMPTY** for 2 seconds.

*Call Waiting

If an incoming call arrives while you are already engaged on a telephone call, you will hear a soft beep every 5 seconds (this beep is not audible to the person you are speaking to). The second caller's number (and name if stored in the directory) will appear on the handset display.

Instead of the engaged tone, the second caller will hear an announcement to hold on as you are aware that there is a second call.

*You must subscribe to your network provider's Call Waiting Service before this feature will work. A quarterly fee is payable.

To accept a Call Waiting call

If you hear the tone that tells you there is another caller, whilst you are on a call:



Press the **Recall** button. The first caller will be put on hold and you can now speak to your second caller.



To return to the first caller press the **Recall** button again.

Note

You can switch back and forth between the two calls without disconnecting either if you wish.



If you wish to disconnect the first call press the **TALK** button after speaking to the first caller.



The handset will then ring. Press the **TALK** button again and continue with the second caller.

Note

The second caller will only be charged for their call from the moment you answer and not while they are waiting for your initial contact.

Using BT Freelance XA 2000 additional handsets and bases

Up to 5 handsets can be registered and operated from any one BT Freelance XA 2000 base. This allows you to make internal calls between two handsets while a third is making an external call.

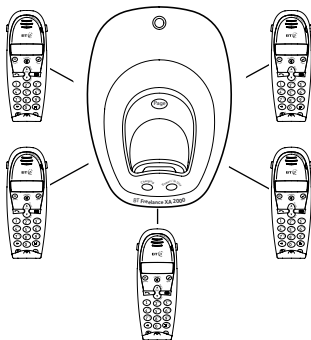

Each handset can be registered on up to 4 bases.

Each additional handset you purchase must be registered with the base.

Your handset supplied is pre-registered as Handset 1 to its base (**Base 1**).

If you have purchased a multiple pack the handsets are already pre-registered to the base supplied (Base 1).

Note

Remember to charge the battery pack of new handsets for at least 16 hours before use.

If the display shows NOT REG and the  symbol is flashing, your handset is not yet registered with the base.

To register a BT Freelance XA 2000 handset to another base

At the base:

Page

Press and hold the base **PAGE** button for at least 10 seconds, until you hear the validation tone (two beeps), then release the button.

At the handset:



Press the  button to enter the menu.



Use the **DOWN** button to scroll to **REGISTER** and press the  button.



The display will show BS 1 2 3 4. (The numbers

that are flashing indicate other bases that the handset is already registered to).

Enter the base number (BS 1-4) that you want to register the handset to.

Enter your 4-digit PIN (original factory setting 0000) and press the  button.

The display will show SEARCH 1, 2, 3, 4 and the  symbol will flash as the handset tries to locate the base. When the handset locates the base, the handset will be automatically selected and shown on the display.

Note

If the handset does not locate the base, the handset will return to the previous menu. Try to register again by using a different available base number. Ensure that you are in close vicinity of the base).

Note

Your 4 digit PIN number is 0000 unless you have previously allocated a new PIN number as explained on page 25.

To de-register a BT Freelance XA 2000 additional handset from the base

Note

Handsets can only be de-registered via another handset.



Press the  button to enter the menu.



Use the **DOWN** button to scroll to **SETUP** and press the  button.



Use the **DOWN** button to scroll to **DEL HS** and press the  button.



The display will show **PIN?**



Enter your 4-digit PIN.



Press the  button.



Use the **UP** or **DOWN** button to select the handset you want to de-register (**HANDSET 1-5**).



Press the  button. Display shows **CONFIRM?**.



Press . You will hear a confirmation beep.

Once de-registered, the handset will display **NOT REG.**

Internal calls

If you have multiple handsets registered to the base you can make internal calls between handsets.

To make an internal call to another handset



Press the **INT** button.



Enter the number of the handset you wish to call, (1-5). The called handset will ring

The display will show INT.



To end the call, press the **TALK** button.

The number of the handset calling will be displayed on the called handset. For example, if handset 2 calls handset 1, H32 will be displayed on handset 1.

Transferring calls

You can transfer an external call to another handset registered to the base.

To transfer an external call between handsets

During an external call:



Press the **INT** button.



Enter the number of the handset that you want to transfer the call to (1-5).

Your caller will be put on hold.

When the internal handset is answered, (if you want you can talk to the handset user first), press the **TALK** button. The call will be transferred.

If the call to the second handset is not answered you can revert/speak to the caller again by pressing the **INT** button.



Three-way conversation

You can talk to one external caller and another internal caller at the same time on your handset.

During a call with an external caller:



Press the **INT** button. Your caller is put on hold and you hear a tone.



Enter the number of the handset you want to transfer the call to.



When the handset is answered, press and hold the **#** button for about 3 seconds. You can now start your three-way conversation. (If the internal handset user does not answer your call, press the **INT** button to return to your external caller).



Press the **TALK** button to end the call.

Note

When on a three-way call the call can only be cleared by the handset which set it up.

Press the  button to exit the call.

Handset Priority

If you have more than one handset registered to the base you can select the handset you want to ring first. You can also set the number of rings the handset will have before an incoming call reverts to all available handsets.



Press the  button to enter the menu.



Use the **DOWN** button to scroll to **SETUP** and press the  button.



Use the **DOWN** button to scroll to **PRIORITY** and press the  button.



Use the **DOWN** button to scroll to **SELECT**.



Press the  button.



Use the **DOWN** button to display the option you want, either **BASE** or the handset number you require, eg **HANDSET 3**.



Press the  button. The display shows **RINGS** followed by a number between 1 and 9.



Use the **DOWN** button to scroll to the number of rings you require.



Press the  button. **PRIORITY** is displayed, denoting that handset priority is on.



Press the  button to confirm. The display shows **ON**.

Help

Replacing the handset batteries.

After a time, you may find that the handset batteries are running out of charge more quickly. This is a standard sign of wear and the batteries will need replacing.

For spare 2 x AAA rechargeable batteries please contact the BT Frealance Helpline **0870 605 8047**.

Replacing the batteries

In the event that you should need to change or replace the batteries: Remove the battery compartment cover and take out the batteries. Insert new 2 x AAA re-chargeable batteries and replace the battery compartment cover.

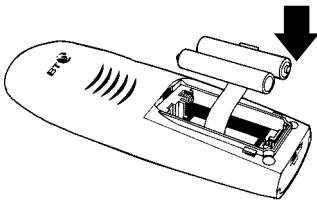

Do not immerse the batteries in water or throw into a fire, or dispose of with ordinary domestic refuse.

BT accepts no responsibility for damage caused to your BT Frealance handset by using any other type of batteries.

No display appears.

The batteries may be flat or dead. Recharge or replace the batteries.

The handset may be switched off.

No dial tone.

Is the telephone line cord plugged into the phone socket?

Check that: The base station is connected to the mains power and switched on.

You cannot link up with the base station.

Is the display flashing  ?

The mains power cable may not be connected at the base or switched on.

Are you in range of the base station?

The batteries could be low or flat.

If using more than one base station, check that you are connected to the correct base. *See page 25.*

Handset does not ring.

The ringer volume may be switched to off. To adjust the ringer volume on the handset. *See page 21.*

Check that: The base station is plugged into the phone socket.

Check that: The base station is plugged into the mains power and switched on.

Buzzing noise on my radio, TV, computer or hearing aid.

Sometimes, your BT Freelance XA 2000 can interfere with other electrical equipment if it is placed too close.

It is recommended that you place your BT Freelance XA 2000 and other BT Freelance/DECT GAP compatible handsets at least one metre away from such appliances to avoid any risk of interference.

The charger does not appear to be working.

Check that: The power adaptor is properly plugged into the charger.

Check that: Your handset has slotted correctly into the charger.

Check that: The batteries are correctly fitted into the handset.

Check that: The base is plugged in to a working socket and that the socket is switched on.

Are you using the correct power adaptor?

BT Freelance XA 2000 base station power supply is Item Code 872260.

BT Freelance XA 2000 charger power supply is item code 021299.

Cannot adjust an option in the base station.

Is someone else making changes via another handset?

Have you pressed the  button to confirm your selection?

Customer Helpline

If you are still experiencing difficulty, call the BT Freelance XA 2000 Helpline on 0870 605 8047.

General information

Guarantee

Your BT Freelance XA 2000 is guaranteed for a period of 12 months from the date of purchase.

Subject to the terms listed below the guarantee will provide for the repair of, or at BT's or its agent's discretion, the option to replace the BT Freelance XA 2000, or any component thereof, (other than the batteries), which is identified as faulty or below standard, or as a result of inferior workmanship or materials. Products over 28 days old from the date of purchase may be replaced with a refurbished or repaired product.

The conditions of this guarantee are:

- The guarantee shall only apply to defects that occur within the 12 month guarantee period.
- Proof of purchase is provided.
- The equipment is returned to BT or its agent as instructed.
- This guarantee does not cover the battery pack and any faults or defects caused by accidents, misuse, fair wear and tear, neglect, storm damage, tampering with the equipment, or any attempt at adjustment or repair other than through approved agents.
- This guarantee does not affect your statutory rights.

Within the 12 month guarantee period:

If you experience difficulty using the product, prior to returning your product, please read the Help section beginning on *page 35*, or contact the BT Freelance XA 2000 Helpline for assistance:

Helpline **0870 605 8047**, 9am to 5.30pm Monday to Friday.

In the unlikely event of a defect occurring, please follow the Helpline's instructions for replacement or repair.

Outside of the 12 month guarantee period:

If your product needs repair after the guarantee period has ended, the repair must meet the approval requirements for connection to the telephone network. We recommend that you contact BT's approved repair agent, TecLogic on 08702 405029 or a local qualified repairer.

Instructions for returning the product:

If the Helpline is unable to remedy your problem they will ask you to return the product. Where possible, pack the product in its original packaging. Please remember to include all parts, including line cords, power supply units, and the original

batteries. (Please note that we cannot take responsibility for goods damaged in transit.) Please obtain and keep proof of posting from the Post Office.

Technical information

How many telephones can you have?

All items of telephone equipment have a Ringer Equivalence Number (REN), which is used to calculate the number of items which may be connected to any one telephone line. Your BT Freelance XA 2000 has a REN of 1. A total REN of 4 is allowed, if the total REN of 4 is exceeded, the telephones may not ring.

With different telephone types there is no guarantee of ringing, even when the REN is less than 4.

Only use approved power supply, item code 872260 for base station or 021299 for charger (only applicable if you have purchased a BT Freelance XA 2000 multiple pack).

Use only approved (Ni-MH) rechargeable batteries.

Switchboard compatibility

This product is intended for use within the UK for connection to the public telephone network and compatible switchboards, which support tone dialling and timed break recall. If in doubt please consult your service provider.

Switchboard external line access code

You may need to enter an access code (e.g. 9) in order to get an outside line. So that the switchboard has time to pick up an outside line, you may also need to add a Pause after the access code.

Recall

To use the recall button



This is used when connected to certain switchboards and for some BT Calling Features or those services available via your network provider.

To set the dialling mode



Press the  button to enter the menu.



Use the **DOWN** button to scroll to **SETUP** and press the  button.



Use the **DOWN** button to scroll to **DIALMODE** and press the  button.



Use the **UP** or **DOWN** button to select either **TONE** or **PULSE**.



Press the  button. You will hear a confirmation beep.

To automatically insert a pause after an access code

With some switchboards it may be helpful to dial a pause after entering the switchboard access code, e.g. 9, 11 etc. to enable you to get an outside line.

This feature automatically inserts a pause between the access code and the telephone number that you have entered in the Phonebook. However for this feature to work you must still enter the access code at the front of the telephone number when storing in the Phonebook.



Press the button to enter the menu.



Use the **DOWN** button to scroll to **SETUP**.



Press the button.



Use the **DOWN** button to scroll to **PAEX**.



Press the button.



Use the **DOWN** button to scroll to **PEX 1**.



Press the button. Display shows **PIN?**. Enter PIN number.



Press the button. Enter the access code.



Press the button.

You can also adjust the length of the pause to be inserted. There are two options available, 3 or 5 seconds to be set to suit the switchboard:



Press the button.



Use the **DOWN** button to scroll to **SETUP**.



Press the button.



Use the **DOWN** button to scroll to **PAEX**.



Press the button.



Use the **DOWN** button to scroll to **PAUSE**.

Display shows **3 SEC**.



Use the **DOWN** button to scroll to **5 SEC**.



Press the button. You will hear a confirmation tone.

Index

Additional handsets	31	Calls list	27
Auto talk on/off	22	delete	29
Base ringer volume	24	delete all	29
Base settings		dial number	28
default/reset	26	enter	28
diagram	2	store in phonebook	28
melody	24	view	28
PIN number	25	Call timer	14
ringer volume	24	Call Waiting	29
select which base station	25	Cleaning	9
Batteries		Delete	
charging	11	calls list	29
install	11	phonebook numbers	19
low warning	11	De-register	32
performance	12	Dialling mode	38
replacing	35	Display icons	2
Belt clip	13	Earpiece volume	15
Button beeps on/off	21	End a call	15
Caller Display	27	Guarantee	37
Calls		Handset settings	
end	15	default/reset	26
handsfree	16	keypad beeps on/off	21
internal	33	language setting	23
make	14	name handset	22
preparatory dialling	14	on/off	14
receive	15	register to another base	31
redial	16	ringer melody	22
secrecy	17	ringer priority	34
three-way conversation	33	ringer volume	21
transfer	33		

Handsfree	16	Recall	38
Help	35	Receive a call	15
Helpline	13	Redial	16
Internal calls	33	Register handset to another base	31
Keypad beeps on/off	21	REN (Ringer Equivalence Number)	38
Language	23	Reset handset/base	26
Location of product	10	Returning your BT Freelance XA 2000	37
Make a call	14	Ring priority	34
Melody		Ringer melody	
base	24	base	24
handset	22	handset	22
Menu structure	4	Ringer volume	
Name a handset	22	base	24
On/off		handset	21
auto-talk	22	Safety information	9
handset	14	Secrecy	17
keypad beeps	21	Setting up	10
secrecy	17	Speech volume	15
Pause – insert	18, 39	Storing a number	17
Paging handsets	20	Switchboard access code	38
Phonebook	17	Switchboard compatibility	38
delete	19	Technical information	38
dial	18	Telephone line cord	12
edit	19	Three-way conversation	33
enter a pause	18	Tone dialling	38
store	17	Transfer calls	33
PIN base	25	Unpacking	8
Power supply	10	Volume	
Preparatory dialling	14	base ringer	24
Pulse dialling	38	earpiece	15
Quick guide – handset settings	3	handset ringer	21
		handsfree	16

R&TTE

This product is intended for use within the UK for connection to the public telephone network and compatible switchboards.

This equipment complies with the essential requirements for the Radio Equipment and Telecommunications Terminal Equipment Directive 1999/5/EC.

Declaration of Conformance.

Hereby, Suncorp Technologies, declares that this BT Freelance XA 2000 is in compliance with the essential requirements and other relevant provisions of Directive 1999/5/EC.

The Declaration of Conformance for the BT Freelance XA 2000 is published on the web site <http://www.suncorpotech.com/bt>

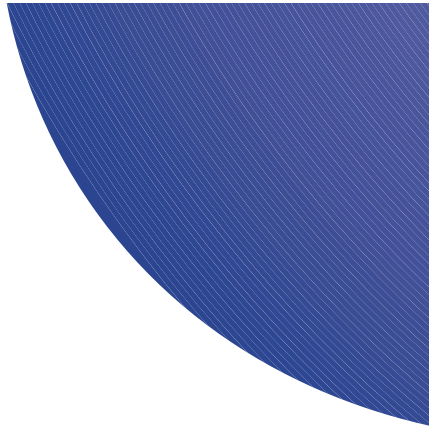

Visit us at www.bt.com



Offices worldwide

The telecommunications services described in this publication are subject to availability and may be modified from time to time. Services and equipment are provided subject to British Telecommunications plc's respective standard conditions of contract. Nothing in this publication forms any part of any contract.

© British Telecommunications plc 2004.
Registered Office: 81 Newgate Street, London EC1A 7AJ.
Registered in England No. 1800000.
BT Freelance XA 2000 (10/04) 2
Designed and produced by The Art & Design Partnership Ltd.
Printed in China

