

FREE STANDING
GAS RANGE
USE AND CARE MANUAL

**Copy Your Model and Serial Numbers
IN THE BOX BELOW**

Model and Serial numbers are on a tag, behind the broiler drawer panel, on the range front frame. If you call for service, or with a question, have this information ready.

Keep this book, your installation guide, your warranty and the sales slip together.

Model No.:	_____
Serial No.:	_____
Purchase Date:	_____

SAFETY RULES.....	2-4
BURNER IGNITION.....	4,5
HOW TO USE YOUR RANGE.....	5-6
• Energy Saving Tips.....	5
• To Use Cooktop Burners.....	5
• To Use The Oven.....	6
• To Set Clock And Timer.....	6
• Oven Light.....	6
• Oven Vent.....	6
COOKING HINTS.....	6-10
• Rack and Pan Arrangement.....	6
• Preheating.....	7
• Using Foil.....	7
• Broiling Tips.....	7
• Positioning Broiler Pan.....	8
• Roasting Tips.....	8
• Using a Meat Thermometer.....	8
• Adjusting Oven Temp Knob.....	9
• Choosing Cookware.....	9
• Common Baking Problems and Causes.....	10
CLEANING AND CARE.....	10-14
• Oven Cleaning.....	10,11
• Cleaning Instructions.....	11,12
• Removable Cooktop Burners.....	12
• Removable Roll-Out Broiler.....	13
• Removable Oven Racks.....	13
• Removable Oven Bottom.....	13
• Removable Oven Door.....	14
• Lift Up/Off Cooktop.....	14
PREVENTING SERVICE CALLS.....	15
FIND PROBLEMS DURING THE WARRANTY PERIOD	
Warranties Are Based On Time, Not Usage. You should try each feature and control on your new range soon after installation.	

FOR YOUR SAFETY

If you smell gas:

1. Open windows
2. Don't touch electrical switches.
3. Extinguish any open flame.
4. Call your gas supplier immediately.

FOR YOUR SAFETY

Do not store or use gasoline or other flammable vapors and liquids in the vicinity of this or any other appliance.

L.P. Burner Adjustments

The adjustments in your Installation Guide must be made before you try to use your range.

If you are using Liquefied Petroleum Gas (bottled gas) all L.P. adjustments in your installation guide must be made before use.

If your range is not properly adjusted, flames may be too high, or the range may use too much fuel, release toxic fumes or cook poorly.

Model and Serial Numbers

Put the Model and Serial Numbers of your new range in the box on the front of this book.

Find these numbers on a metal plate under the lift-up cooktop.

IMPORTANT INSTRUCTIONS

ONLY YOU CAN PREVENT ACCIDENTS! Read the Safety Rules below and all operating instructions before using this appliance.

GENERAL

Keep this book for later use.

Be sure your range is put in and grounded by a skilled technician.

Never try to fix or replace any part of the range unless the book tells you to. All other work should be done by a skilled technician.

Never block free air flow thru the oven vent (see page 6) or to the cooktop burners.

Only some kinds of glass and ceramic pans can be used for cooktop cooking. Be sure that the pan you use will not break when heated on the cooktop burner. See page 9 for tips on cookware.

CHILD SAFETY

Teach your children not to play with range knobs or any other part of the range.

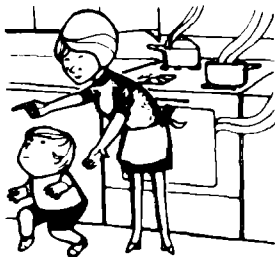

Never leave children alone or unwatched where a range is in use.

Never let children sit or stand on the cooktop or open oven door. The child's weight may make the range tip over.

Never leave the oven door open when you are not watching the range.

Caution — Do not store things children might want above a range. Never let children climb on any part of the range.



NO!

SAFETY

Never use your range to heat a room. Doing so can be dangerous and hurt range parts.

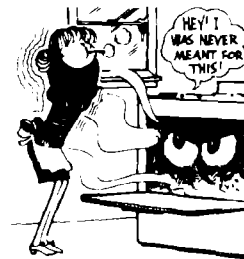

NO!

Never wear loose or hanging clothes while using your range. Such clothes could catch fire.

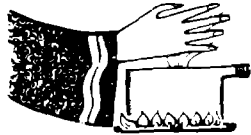

NO!

Never heat unopened food containers. Pressure build-up may make container burst and cause injury.

Never let pot handles stick out over the front of the range. Turn handles in, over the cooktop, so that they cannot be bumped into. Be sure not to turn handles over another burner. They may get hot and burn you.



NO!

Always use care when opening the oven door. Let hot air or steam out before moving food.

Always move oven racks while oven is cool.

Always use dry potholders when removing pans from the oven or cooktop. Moist or damp potholders can cause steam burns. Do not use a towel or other bulky cloth.



NO!

GREASE FIRES

Never leave cooktop burners unwatched at high heat settings. Boilovers cause smoking and greasy spillovers may catch fire.



NO!

Always keep the range area clear and free from things that could catch fire, gasoline and other flammable vapors and liquids. Never store things in an oven or near cooktop burners. These things may catch fire and plastic items may melt and burn.

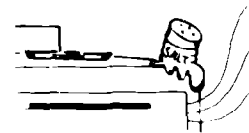

NO!

Never use aluminum foil to line drip bowls (under burner grate) or oven bottoms. Only use foil as shown on page 7 of this book. Improper use of foil can start a fire or keep all the gas from burning.

Never leave jars or cans of fat or drippings on or near the range. Never let grease build up on your range. You can keep grease fire from starting if you clean up grease and spillovers after each range use.

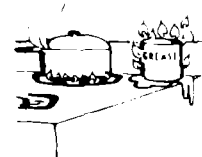

NO!

PUTTING OUT A GREASE FIRE

A dry chemical, foam or Halon type fire extinguisher should be near the range where you can easily reach it in case of a cooking fire. A Halon extinguisher will not spoil the food and makes no mess.

Never use water on a grease fire — it will only spread the flames. Never pick up a flaming pan. Instead:

1. Turn off the burner.
2. Smother the fire with a tightly fitting pan lid, baking soda or an extinguisher.

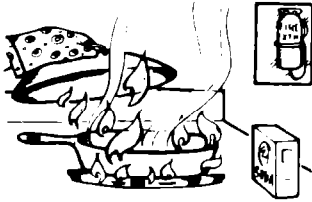

How to put out a liquid grease fire with a fire extinguisher:

1. Stand back 5 or 6 feet.
2. Open the extinguisher.
3. Starting at the flames closest to you, move the extinguisher side to side and work back until all flames are out.

CAUTION: If you bring the extinguisher too close you may blow burning grease all over the cooking area.

FOR RANGES WITH STANDING PILOTS

To Light Gas Cooktop Pilots:

1. Turn the burner controls to OFF and wait one minute before lighting pilots.
2. Remove the burner grates and drip bowl liners (some models),

then lift up the cooktop. The cooktop pilots are located between the front and rear burner on each side of the cooktop (see illustration).

3. Light pilot(s) with a match.

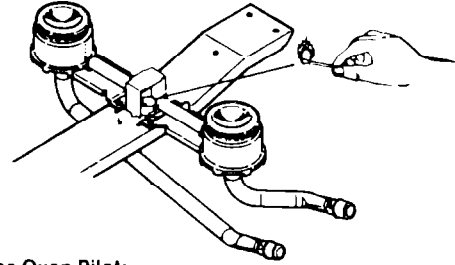

To Light Gas Oven Pilot:

1. Turn the OVEN CONTROL knob to OFF and wait one minute before lighting pilot.
2. Open the broiler, lift up on the handle slightly, and pull the broiler door down flat. Put the broiler pan in the lowest position and slide the drawer back into the range so you can reach inside the broiler easier.
3. Find the oven pilot at the back of the broiler compartment. The long tube at the top of the compartment, running from front to back, is the oven burner. The pilot is at the back, about 1 inch below the burner. See illustration below.
4. Light the pilot with a match.

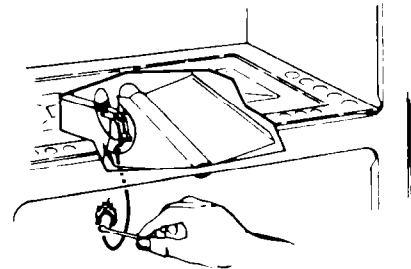

FOR RANGES WITH SPARK IGNITION To Manually Light Cooktop Burners With Spark Ignition

CAUTION

Lighting gas burners with a match is dangerous. The flames can burn you or a buildup of gas can explode. You should match light the cooktop burners only in an emergency. NEVER match light spark ignition oven burners.

During a power failure the burners will not light automatically. In an emergency, a cooktop burner may be lit with a match by following the steps below.

1. Light a match and hold the match flame near the burner you want to light. Wooden matches work the best.
2. Push in and turn the control knob slowly. Be sure you are turning the knob for the burner you are lighting.

Note: If burner does not light within five seconds, turn the knob off and wait one minute before trying again.

Do Not Manually Light Oven Burners With Spark Ignition

TO USE COOKTOP BURNERS

A sign near each cooktop control knob shows which burner is turned on by that knob. For example, when you turn the knob nearest to : : , the right front burner will light.

You should always light the burners before putting a pan on the burner grate.

Some models have a cone-shaped cooktop burner, with a circular opening through the center of the burner, at the right front cooktop position. This "All-Purpose Burner" can provide one third again as much heat as the other three. Use the "All-Purpose Burner" for cooking large amounts of food in a big pan, canning, etc. See additional information on page 12.

CAUTION

Set controls so flame heats pan bottom only and does not lick pan sides. Flames licking pan sides are unsafe and waste gas.

Gas Pilot Models

When you turn a control knob on, the burner is lit by a constantly burning pilot.

To light a burner:

1. Push the control knob in and turn it left to LITE.
2. When the burner lights, turn the knob to set flame size.

Spark Ignition Models

When you turn a control knob to LITE, the burner is lit by a series of electric sparks (ticking sound) from the igniter.

To light a burner:

1. Push the control knob in and turn it left to LITE.
2. When the burner lights, turn the knob to set flame size.

IMPORTANT: Do not leave the control knob on LITE after the burner is lit, or the life of the spark igniter may be shortened.

IF A BURNER DOES NOT LIGHT

If a burner fails to light within five seconds, turn the knob to OFF and wait one minute before trying again.

If the burner still will not light, check Preventing Service Calls on page 15.

ENERGY SAVING TIPS

- Be sure the burners (and pilots, if applicable) are properly adjusted when your range is installed. Adjustment information is in your Installation Guide.
- Clean all burners often (see pages 11 and 12). Dirty burners reduce efficiency.
- When possible, thaw frozen foods before cooking, cook with the minimum amount of water and use a pan with a tightly fitting lid.
- Adjust the flame to fit the size of the pan.
- Be sure to watch foods when heating them quickly on HI. As soon as the food reaches the cooking temperature, turn down the heat to the lowest setting that will keep it cooking.

TO USE THE OVEN

Baking and Broiling

1. Set OVEN CONTROL knob to BROIL or needed temperature.
2. When finished turn knob to OFF.

TO SET THE CLOCK (Some Models)

1. Turn the clock/timer knob in the counterclockwise direction until the words "SET TIME" are displayed.
2. Turn the Clock/Timer knob in either direction to set the time of day. Clock is now set.

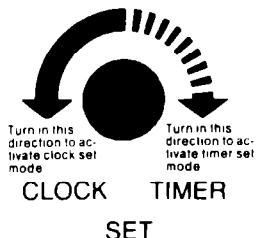

TO SET THE TIMER (Some Models)

1. Turn the Clock/Timer knob in the clockwise direction until the words "SET TIMER" are displayed.
2. Turn the Clock/Timer knob in any direction to set amount of time. The timer will automatically start counting down.
3. When time is up, 3 beeps will sound.

NOTE: To cancel timer, turn the Clock/Timer knob until the display reads :00.

While the timer is being used, the time of day will be shown in the display about every 10 seconds.

NEW OVEN ODOR

During the first baking and broiling cycles in your new oven, there may be some odor. This is normal and is caused by the heating of new parts and insulation. The odor will go away within a short time. A vent fan or other ventilation will help to clear the air.

OVEN LIGHT (Some Models)

Some models have an interior oven light. To turn the oven light on and off, push the Oven Light switch on the control panel. Should you ever need a new bulb, use a 40 watt appliance bulb.

OVEN VENT

When the oven is on, heated air moves through a vent in or below the backguard. On the cooktop, this hot air may make pot handles hot or melt plastic things left too near the vent.

The vent is needed for proper air flow in the oven and good baking results. Do not block this vent. Doing so may cause cooking failure, fire or damage to the range.

MOISTURE

As your oven heats up, water droplets may form on the door or door glass. To prevent this, open the oven door for the first minute of oven heat up to let the moist air out.

RACK AND PAN ARRANGEMENT

Put oven rack(s) in place before turning on the oven. Rack positions are numbered 1 to 4, starting at the bottom with number 1. In general, when using only one rack, position No. 2 should be used. When using two racks, positions No. 2 and 4 work best.

When using cookie sheets place them with the long side of the cookie sheet toward the front of the oven and centered on the rack. When using two cookie sheets at the same time use rack positions No. 2 and 4. The cookies on the lower rack may be done 1-2 minutes before the ones on the higher rack. You may want to switch rack positions when baking is halfway finished.

Pans too close to each other, to oven walls, or to the oven bottom block the free movement of air. Improper air movement causes uneven browning and cooking.

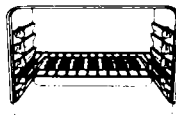

Sheet Cake, Cookies, Biscuits

When using a large flat pan that covers most of the rack, center on one rack

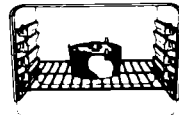

Angel Food or Sponge Cake

When baking a sponge or angel food cake, center on one rack in the lowest position



Cake Layers, Pies, Casseroles, 3 Pans

The pan or pans using the least rack area should be placed on the lower of the two racks



Cake Layers, Pies, 4 Pans (staggered)

When using two racks and several pans, stagger them so no pan is directly above another

PREHEATING

Preheating lets the oven heat evenly before the food is put in. Allow 10 minutes at temperatures less than 350°F and 15 minutes at 350° F or more.

With recipes that call for an oven preheated to a certain temperature, it is very important that you follow those instructions. It is not likely that you will get good baking results every time without preheating to the needed temperature, unless the recipe says to start in a cold oven.

After the oven is preheated and you are ready to put the food in, try to have everything handy so that you will not have to leave the oven door open for an extended period of time.

Opening the door often to check the food during baking makes it impossible for the oven to stay at the temperature you have selected. Try to time your baking and check only when close to being finished.

NOTE: When using cookware made of ovenproof glass or pottery, Teflon® coated cookware and dull or darkened pans in the oven, be sure to reduce recipe temperature by 25°F (see Choosing Cookware, page 9).

USING FOIL

For Baking

To catch spillovers, cut a piece of foil slightly larger than the pan and turn up the edges. Use two oven racks and put the foil on the lower oven rack below the pan. Do not use aluminum foil directly under a pan on the same oven rack. The foil will reflect heat away from the pan.

CAUTION

Do not cover the oven bottom or an entire oven rack with foil. The foil can block normal heat flow, cause cooking failures, and damage the oven interior.

For Roasting

For slow browning, place a foil "tent" loosely over the meat. This is especially good on a large turkey. Do not seal the foil. Sealing the foil will tend to steam the meat.

To reduce spattering, lightly crush foil and put it in the bottom of the pan under the food.

For Broiling

CAUTION

Do not cover the broiler grid with foil. Hot fat on the foil may cause a broiler fire. If a fire starts, close the oven door and turn controls off. If fire does not go out, throw baking soda on the fire. Do not put water on the fire.

BROILING TIPS

Your oven and broiler doors should be completely closed while broiling.

Use only the broiler pan and grid that came with your range for broiling. They are made for proper drainage of fat and liquids and help prevent spatter, smoke or fire.

Do not preheat when broiling. For even broiling on both sides, start the food on a cold pan. Allow slightly more than half the cooking time for the first side then turn the food using tongs. If you pierce the meat with a fork, the juices will escape.

When broiling frozen meat, use one rack position lower than shown in the chart and up to 1½ times the broiling time.

Trim the outer layer of fat from steaks and chops. Slit the fatty edges to keep the meat from curling.

Always put the food being broiled on the proper rack (see chart at right). Food placed too close to the broiler may spatter, smoke or catch fire.

For maximum juiciness, salt the first side just before turning the meat. Salt the second side just before serving.

Brush chicken and fish with butter several times as they broil. When broiling fish, grease the grid to prevent sticking.

Never leave a soiled broiler pan in the range. Grease in the pan may smoke or burn the next time the oven is used. See page 11 for tips on cleaning the broiler pan and grid.

Be sure you know how to put out a grease fire. See page 4.

POSITIONING BROILER PAN

To open the broiler compartment, grasp the handle and pull the door toward you. After placing food on the broiler pan, slide the pan into the proper rack position.

Be sure the sump (grease well) in the pan is to the front of the range.

See the chart below for recommended rack position and cooking time.

The closer the food is to the broiler burner the faster the meat browns on the outside, yet stays red to pink in the center. Moving the meat farther away from the burner lets the meat cook to the center while browning outside.

Food	Rack Position 3 = Highest 1 = Lowest	Total Time (Minutes)
Steak - 1" Thick		
Rare	3	10-12
Medium	3	14-16
Well Done	2	20-22
Ground Beef Patties		
Medium	3	11-13
Well Done	3	13-15
Lamb Chops - 1" Thick	2	16-20
Pork Chops - 1" Thick	2	20-25
Pork Shoulder Steaks	2	15-20
Ham Slice - 1" Thick	3	14-16
Fish (Fillets)	2	10-15
Chicken (Halves)	1	40-60
Frankfurters	2	10-15
Bacon	2	5-7
Open-face Sandwiches	2	6-10

This chart is a general guide. The size, weight, thickness and starting temperature of the food, as well as your own personal preference, will affect cooking time.

ROASTING TIPS

Roasting time will depend on the oven temperature, meat temperature, size, shape and type of the meat, the proportion of bone and fat, and the degree of doneness (internal temperature) you desire.

- Add extra time (15 to 25 minutes per pound) when roasting frozen meats.
- For even cooking, put the meat in the pan with the fat side up.
- Use a roasting pan that fits the size of the roast. Too small a pan will let the melted fat drip over the edge and too large a pan will cause spattering.
- Reduce spattering by putting lightly crushed foil in the pan under the food.
- To best measure doneness, always use a meat thermometer.
- For easier carving, let the roast stand 10 to 20 minutes after removing it from the oven. Always carve across the grain of meat.

MEAT	OVEN TEMP	INTERNAL TEMP	MEAT	OVEN TEMP	INTERNAL TEMP
Beef, Lamb	325° F	140° F	Veal	325° F	175° F
rare			Pork (fresh)	325° F	170° F
medium		160° F	Chicken	375° F	190° F
well		170° F	Turkey	325° F	185° F

USING A MEAT THERMOMETER

Stick the thermometer into the center of the largest muscle of meat, or in the inner thigh, or breast of poultry. For an accurate reading, the tip of the thermometer should not touch bone or gristle or rest in a pocket of fat.

As the meat cooks, the thermometer may slip from its position. If the reading on the thermometer seems unusually high for the length of time the meat has cooked, check the thermometer and reposition it if necessary.

If you let a roast stand 10 to 20 minutes after you remove it from the oven, it will be easier to carve and the internal temperature will raise as it stands. Remove the roast from the oven when the thermometer reads 5°F to 10°F less than the internal temperature you desire. If you do not plan to let the roast stand, leave the meat in the oven until the full temperature is reached.

ADJUSTING OVEN CONTROL KNOB

The temperature in your new oven has been set at the factory, so be sure to follow the recipe temperatures and times the first few times you bake in your new oven.

If you think the oven should be hotter or cooler, you can adjust it yourself. To find out how much to change the temperature, set the oven control knob 25°F higher or lower than the temperature in your recipe, then bake. This "test" should give you an idea of how much the temperature should be changed.

To adjust knob:

1. Turn OVEN CONTROL knob to OFF and remove the knob by pulling straight off.
2. Look at the back of the knob. The arrow pointing to the center of the upper screw shows the original factory setting. The knob can be set for up to 75°F hotter or 75°F cooler, in 15°F increments.
3. Use a screwdriver to loosen the two screws about 1 turn each.
4. Hold the knob handle (A on illustration) while turning the knob skirt (B on illustration) to Hotter or Cooler. As you turn, you should be able to hear clicks and feel notches or teeth. Each click or notch is 15°F. You can turn up to 5 clicks or notches in either direction.
5. Retighten both screws.

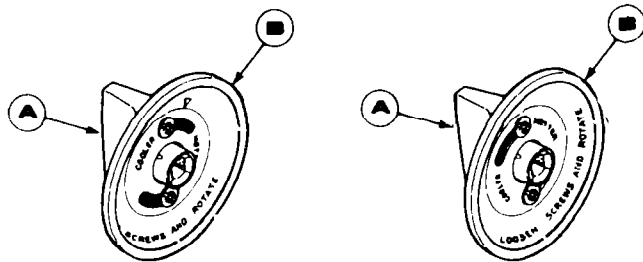

CHOOSING COOKWARE

COOKTOP COOKWARE

ALUMINUM: Spreads heat quickly and evenly. Best for frying, braising and pot roasts.

CAST IRON: Slow to change temperature and holds heat. Good for browning, frying and stewing.

COPPER (Tin-Lined): Quick to change temperature. Great for gourmet cooking, wine sauces and egg cookery. Tinlining will wear thin with use. Cookware must be retinned to avoid a poisonous reaction between the copper, the heat and the food.

GLASS CERAMIC: Slow to change temperature. Best for long, low heat cooking with a liquid.

PORCELAIN ENAMEL: Porcelain enamel over steel is long lasting, stain and scratch resistant. How well it heats depends upon the type of steel used. Best for cooking soups and other liquids.

STAINLESS STEEL: Usually combined with other metals such as aluminum, copper or carbon steel. These other metals make the cookware heat more quickly while the stainless steel makes it strong and long lasting. Best for frying, sauces, soups, vegetables and egg cooking.

OVEN COOKWARE

ALUMINUM: Absorbs heat faster than glass or steel and conducts heat well. Gives delicate browning, tender crusts, and reduces spattering of roasts. Best for cakes, muffins, quick breads, cookies and roasting.

OVENPROOF GLASS/POTTERY: Because this cookware absorbs and holds heat well, you should should lower your oven temperature 25° F. Gives food a deep, crusty brown top. Best for casseroles.

TEFLON® , DULL OR DARKENED COOKWARE: Absorbs heat quicker than shiny cookware. Lower your oven temperature 25 F° (except for pastry). Good for pies and other foods baked in pastry shells.

Q. Can I use special cookware, like an oriental wok, on my cooktop burners?

A. Some oriental woks have support rings that block free air flow that is needed for proper operation of burner. Also, the trapping of high heat around burner may damage cooktop. You should not use utensils which go below the top of the cooktop burner grate.

COMMON BAKING PROBLEMS AND CAUSES

CAKE RISES UNEVENLY

- Range or oven rack not level
- Pan warped
- Batter spread unevenly in pan
- Pans too close to oven wall or rack to crowded

CAKE HIGH IN MIDDLE

- Too much flour
- Oven temperature too high

CAKE NOT DONE IN CENTER

- Wrong pan size
- Oven too hot
- Pan not centered in oven

CAKE FALLS

- Too much shortening, liquid or sugar
- Temperature too low
- Pan too small
- Oven door opened too often
- Too much leavening or stale leavening
- Overmixing after adding flour

BOTTOM PIE CRUST SOGGY

- Filling too juicy
- Filling allowed to stand in pie shell before baking
- Used shiny pans
- Temperature too low at start of baking
- Crust and/or filling not allowed to cool before filling crust

BURNING AROUND EDGES OF PIE CRUST

- Oven temperature too high
- Edges of crust too thin or too high
- Oven too full or pans too close together

COOKIES AND BISCUITS BURN ON BOTTOM

- Oven preheat time too short
- Pan too deep or too large
- Used dark pans
- Used wrong rack position

FOOD NOT DONE AT END OF COOKING TIME

- Oven temperature set too low
- Oven too crowded
- Oven door opened too often
- Aluminum foil blocking air movement

OVEN CLEANING

Some models have a standard porcelain oven finish and some models have a continuous clean finish on the oven top, back and sidewalls. Standard porcelain is smooth. The continuous clean finish has a rougher texture.

See the cleaning instructions on page 12 to find out how to best clean the standard porcelain finish. If your oven has the continuous clean finish, read below how this special porcelain enamel works and how to care for it.

On a smooth standard porcelain surface, a fat spatter beads up, then chars and turns black. On the rougher continuous-cleaning surface, a fat spatter spreads out forming a larger area and then gradually burns away at medium to high baking temperatures.

You do not have to wipe up heavy spatters, but it may speed the cleaning action. If you wish to wipe up heavy spatters, follow the tips below so you do not damage the continuous-cleaning finish.

- Use clear water or detergents such as Fantastik, Liquid Ajax, Top Job, Liquid Lysol or Mr. Clean, mixed in water, and a soft cloth or nylon brush to clean any heavy spatters
- Do not use paper towels or sponges because these materials will rub off and clog the pores of the finish.
- After cleaning the surface, rinse it well, using three tablespoons of vinegar, mixed with a quart of cold water. Blot up excess liquid.
- Never scrape or use abrasive materials such as scouring powders, commercial oven cleaners or steel scouring pads for cleaning up heavy spatters. These materials will scratch and damage the finish.

The higher the oven temperature, the faster the cleaning action. The length of cleaning time will depend on the type and amount of soil, oven temperature and the length of time the oven is used.

Soil will slowly go away with normal oven use. Cleaning occurs whenever the oven is turned on for baking or roasting. The oven will look presentably clean, even though some spatters may be present. No cleaning takes place when the oven is off.

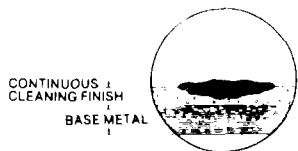

A heavy spatter has filled the pores and formed a mound of soil.

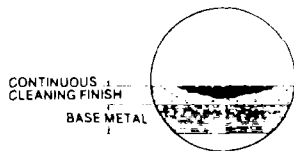

The heavy spatter has been wiped up. The continuous-cleaning action will begin the next time the oven is used.

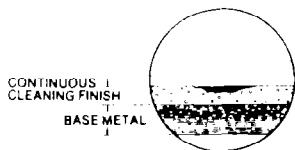

This shows the amount of soil remaining after a few hours of oven use. The soiled area is smaller and lighter in color.

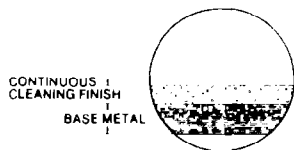

After more oven use, the soil has been removed.

NOTE: If any stubborn stains remain after normal oven use, you may run the oven empty at 400° F for additional continuous-cleaning action.

Some foods may leave a light discoloration even when the surface is clean.

You can protect the oven bottom from heavy spills and your cleaning time by using a piece of aluminum foil under your cooking utensil. See page 7 for tips on using foil correctly.

CLEANING INSTRUCTIONS

CONTROL PANEL AND KNOBS: Pull knobs off and wash at sink in soap and water. Wash control panel with soap and water, rinse with vinegar and water and dry with a paper towel.

COOKTOP BURNERS: Wash with soap and water and a non-metal scouring pad. To clean stubborn soil, remove burners (see instructions on page 12). Fill a non-aluminum pan with water to cover the burner head. Boil water, then slowly add 2 tbsp. of dry Dip-it granules per quart. Add burner with head down and boil for 20 minutes. Remove burner and rinse. Wipe any remaining soil off with a cloth or soft brush. Drain out water and heat burners in a warm oven (200° F) for about ½ hour to dry completely. After cleaning or a spillover, light the burners and make sure no ports are clogged (see page 12). Do not use all-purpose cleaners, ammonia, powder cleansers or commercial oven cleaners. They can scratch or discolor aluminum.

BURNER BOX (Under Cooktop): Raise or remove cooktop as shown on page 14. Wash with soap and water, then dry.

OUTSIDE FINISHES

CHROME (Some Cooktop): Wash with soap and water. For heavy soil, cover with a damp cloth and let soak for 30 minutes. A chrome cleaner may be used. To remove fingerprints on brushed chrome, apply a little baby oil or cooking oil with a cloth or paper towel. Rub in the same direction as the brush marks on the chrome.

GLASS (Clock Cover, Some Oven Doors): Wash with a soapy cloth, well wrung out. Remove stubborn soil with a paste of baking soda or ammonia and water. Do not use abrasive materials. Before using an all-purpose cleaner, check the label to be sure it is recommended for glass—some will permanently damage glass. To help prevent a brown film from forming on the window the next time the oven is heated, rinse the inside of the window with vinegar and water, then dry with a paper towel.

PAINT (Range Sides, Broiler Door Backguard): Wash with soap and water then rinse with vinegar and water and dry with a paper towel. Avoid cleaning powders or abrasives which may scratch the surface.

PORCELAIN (Some Cooktops): Porcelain enamel can crack or chip with misuse. It can stain if acid spills are not cleaned up quickly. Wash with soap and water. For heavy soil, cover with a damp cloth and let soak 30 minutes or use a scouring pad. Rinse with vinegar and water and dry with a paper towel. If you are not sure if a surface is paint or porcelain, follow the instructions in the

paint section on page 11.

VINYL (Some Oven Handles): Wash with soap and water then dry. Do not use abrasive or caustic cleaners.

OVEN FINISHES

STANDARD PORCELAIN: Soak stubborn stains with an ammonia soaked paper towel or set a dish of ammonia water in oven overnight to loosen soil, then scour. Rinse with a mixture of vinegar and water. When using oven cleaners, follow package directions. For smooth standard porcelain areas of continuous cleaning ovens you can use a non-aerosol oven cleaner. Be sure that no oven cleaner touches the rougher continuous cleaning finish. You can remove the oven bottom for cleaning (see page 13). Be sure that no trace of the oven cleaner stays in the oven. Traces of oven cleaner could put stains on the finish when heated. To make sure this does not happen give a final rinse with vinegar and water. **CAUTION:** Do not coat thermostat bulb (wire in upper part of oven) with oven cleaner. Never use oven cleaners on outside range surfaces, aluminum, chrome or baked enamel.

CONTINUOUS CLEANING: Follow special instructions for continuous cleaning ovens on pages 10 and 11. Never use any oven cleaners or abrasive cleaners.

OVEN RACKS: Remove from oven (see instructions on page 13) and wash at sink with soap, water and a scouring pad.

BROILER PAN AND GRID: Do not leave in range to cool. If you clean right away, the soil will steam loose while you are eating. Remove pan from broiler and remove fat and drippings. Sprinkle pan with detergent then cover with a wet cloth or paper towel and let soak. Later wash in soap and water using a scouring pad as necessary. Both the pan and the grid are dishwasher safe.

BROILER COMPARTMENT: Wash with soap and water. For heavy soil, use a scouring pad or a brush on oven cleaner. Rinse with vinegar and water and dry with a paper towel.

REMOVABLE COOKTOP BURNERS

The cooktop burners on your range may be removed for cleaning. Be sure all cooktop knobs are turned to OFF and burners are cool, then remove or raise the cooktop.

If shipping screws were not removed from the burners when the range was installed, do so now (see your Installation Guide for instructions). These screws may be discarded.

To remove burners:

1. Grasp the burner head and tilt it to the right to release the two tabs from the burner support (A in Fig. A).
2. Lift the end of the burner assembly, then pull away from the front of the range to free the air shutter from the gas valve orifice (B in Fig. A).

Check lighter and burner ports (Fig. B). If they are clogged, use a wire or needle to clear them.

See the Cleaning Instructions on pages 11 and 12. Be careful not to disturb the air shutter setting while cleaning. If you need to readjust the air shutter, see your Installation Guide.

Some models have an "All-Purpose Burner". Be sure that the cone-shaped "All-Purpose Burner" is returned to the right front cooktop position. Damage to your range may result if smaller burners are used in this position.

To replace burners:

1. Slip the air shutter over the gas valve orifice (Fig. A).
2. Lower the burner assembly and hook the tab in the slots in the burner support (Fig. A).
3. Be sure both tabs are in their slots, that the burner sits level and straight and that the flash tube forms a straight line from the pilot or igniter to the burner (Fig. B).

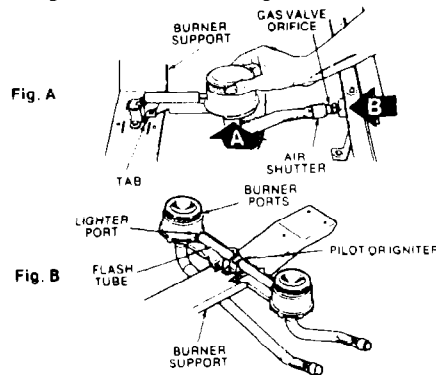

REMOVABLE ROLL-OUT BROILER

To remove the roll-out broiler for easier cleaning:

1. Pull broiler out until it stops.
2. Grasp handle, lift front of broiler and pull broiler out.

See the Cleaning Instructions on pages 11 and 12.

To replace broiler:

1. Put the slide blocks under the broiler behind the broiler stops in the range.
2. Hold broiler in the raised position as you slide it part way into the range, then lower broiler and push completely closed.

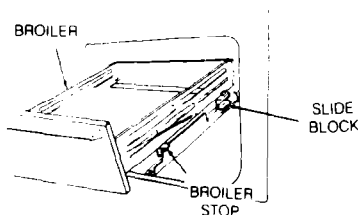

REMOVABLE OVEN RACKS

If your oven has a continuous-cleaning oven finish, be careful not to scratch the finish when installing or removing oven racks.

To install:

1. Set the raised back edge of the rack between a pair of rack guides.
2. Push the rack in until you reach the bump in the rack guide, then lift the front of the rack a bit and push the rack all the way in.

See the Cleaning instructions on pages 11 and 12.

To remove:

Pull the rack out, then up.

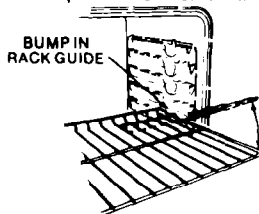

REMOVABLE OVEN BOTTOM

The oven bottom in your range can be removed for easier cleaning.

If your oven has a continuous-cleaning oven finish, be careful not to scratch the finish when removing or replacing the oven bottom.

To remove:

1. Grasp at finger slots in each side of the oven bottom.
2. Lift the front edge of the oven bottom enough to raise the tabs from the slots in the front frame.

Push the oven bottom back about 1/4" to release the flange from the front frame, then pull out.

See the Cleaning Instructions on pages 11 and 12.

To replace:

1. Slide the oven bottom into the oven so the back tabs fit into the slots in the oven back.
2. Grasp at finger slots and push the oven bottom back and then down to hook the flange under the front frame.
3. Fit the front tabs into the slots in the front frame.

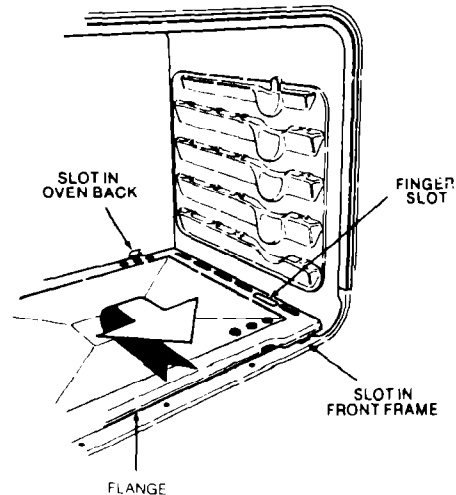

REMOVABLE OVEN DOOR

To remove:

1. Open the door to the stop position (see the illustration).
2. Grasp the door at each side and lift up and off the hinges.

See the Cleaning Instructions on pages 11 and 12.

NOTE: When the door is removed and hinge arms are at stop position, do not bump or try to move the hinge arms. The hinges could snap back causing an injury to the hands or damage to the porcelain on the front of the range. You may wish to cover the hinges with toweling or empty towel rolls while working in the oven area.

To replace:

1. Hold the door over the hinges with the slots at the bottom edge of the door lined up with the hinges. **The hinge arms must still be in the stop position.**
2. Slide the door down onto the hinges as far as it will go and close the door.

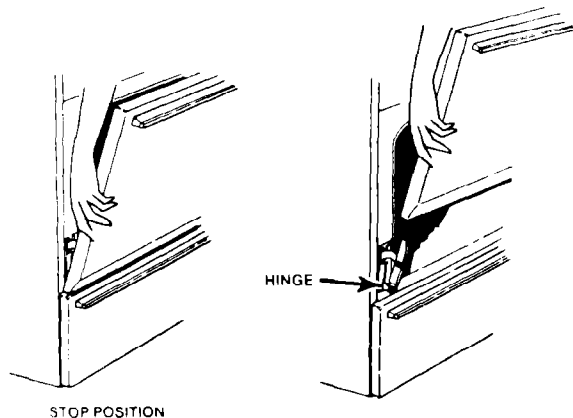

LIFT UP/OFF COOKTOP

The cooktop can be raised or removed so the area under it can be cleaned.

To raise cooktop:

1. Remove the burner grates.
2. Grasp the front of the cooktop and lift up.

For ranges with a support raise the cooktop until support rods snap into position.

To remove cooktop:

1. Remove the burner grates.
2. Grasp the cooktop and lift the front a little.
3. Grasping the cooktop at the sides, hold it nearly flat while you lift up and off.

For ranges with a support unhook the bottoms of the supports from the range sides.

To keep from chipping or damaging the porcelain finish, be careful not to drop the cooktop.

See the Cleaning Instructions on pages 11 and 12. When finished cleaning carefully lower the cooktop into place.

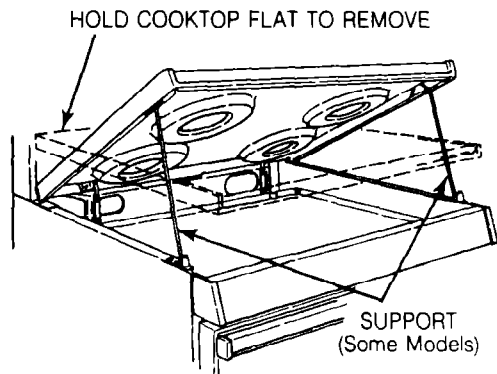

IF YOU HAVE A PROBLEM

Problems are often caused by little things that you can fix yourself without any tools. Make sure you are following instructions in this book and read the list of common problems and solutions on this page.

If you have a problem you can not fix yourself, call your authorized dealer for help.

CLOCK/TIMER DOES NOT WORK

- Check to be sure range cord is plugged into outlet completely. Check for a blown fuse or tripped circuit breaker.
- Check for power outage.
- Check step by step operating instructions on page 6.

OVEN LIGHT WILL NOT WORK

- Check for a blown fuse or tripped circuit breaker.
- Bulb loose or burned out. Use a 40 Watt appliance bulb to replace.
- Power outage—check by trying household lights.

COOKTOP BURNER DOES NOT LIGHT

- Check to be sure range cord is plugged into outlet completely. Check for blown fuse or tripped circuit breaker.
- Range not properly grounded or polarized. This can affect ignition on spark ignition models. See your Installation Guide.
- Check for power outage.
- Gas supply not connected or not turned on.
- Pilot light out (pilot models only). See page 4 to relight pilots.
- A pan is sitting on the burner grate. This may partially block the free air flow needed for combustion. Remove the pan and try again.
- Burners not adjusted properly. See your Installation Guide for adjustment information.
- Food clogging burners or burner assembly misaligned. See page 12 on removing burner assemblies and also the cleaning instructions on page 11.

COOKTOP KNOBS WILL NOT TURN

- To turn from Off position, push the knob in and then turn.

OVEN/BROILER BURNER DOES NOT WORK

- Check to be sure the range cord is plugged into the household outlet completely (spark ignition models only). Check for blown fuse or tripped circuit breaker.
- Range not properly grounded or polarized. This can affect ignition on spark ignition models. See your Installation Guide.
- Pilot light out (pilot models only). See page 4 to relight pilot.
- Check for power outage.
- Is the Oven Control knob turned on?
- Burners not adjusted properly. See your Installation Guide for adjustment information.

OVEN TEMPERATURE SEEMS INACCURATE

- Check to be sure the thermostat sensing bulb (wire in upper part of oven) is in clips, straight, and not touching oven sides.
- Is proper airflow blocked by aluminum foil? See page 7 for tips on correct use of foil.
- Is the oven vent blocked? See page 6.
- Check the section on baking problems and causes on page 10.
- The oven thermostat on your new range may be more accurate than the one on your old range. See page 9 for information on adjusting the Oven Control knob.

BROILING PROBLEMS

- Oven Control knob not set to Broil.
- Using wrong rack position. See chart on page 8.
- Aluminum foil not used properly and grease can't drain correctly. See page 7.

BROILER IS SMOKING

- Broiler pan full of grease left in range from the last time you broiled food. Dirty broiler pan must not be left in the range or smoking and a broiler fire can result the next time the oven is used.
- The broiler pan was put into the broiler compartment with the sump (grease well) in the broiler pan to the back. This is the hottest area and may cause smoking. Always place pan in the compartment with the sump at the front.

CONTINUOUS—CLEANING OVEN FINISH LOOKS SOILED

- The continuous-cleaning finish will gradually reduce soil during normal baking temperatures. It will not keep your oven spotless—only presentably clean.