



RF-350

PROFESSIONAL VEHICLE SECURITY SYSTEM
WITH KEYLESS ENTRY

INSTALLATION & USERS MANUAL
(For Authorized Dealers Only)



Please register your product at www.autopageusa.com

THIS PRODUCT IS DESIGNED FOR PROFESSIONAL INSTALLATION ONLY

WIRING DIAGRAM

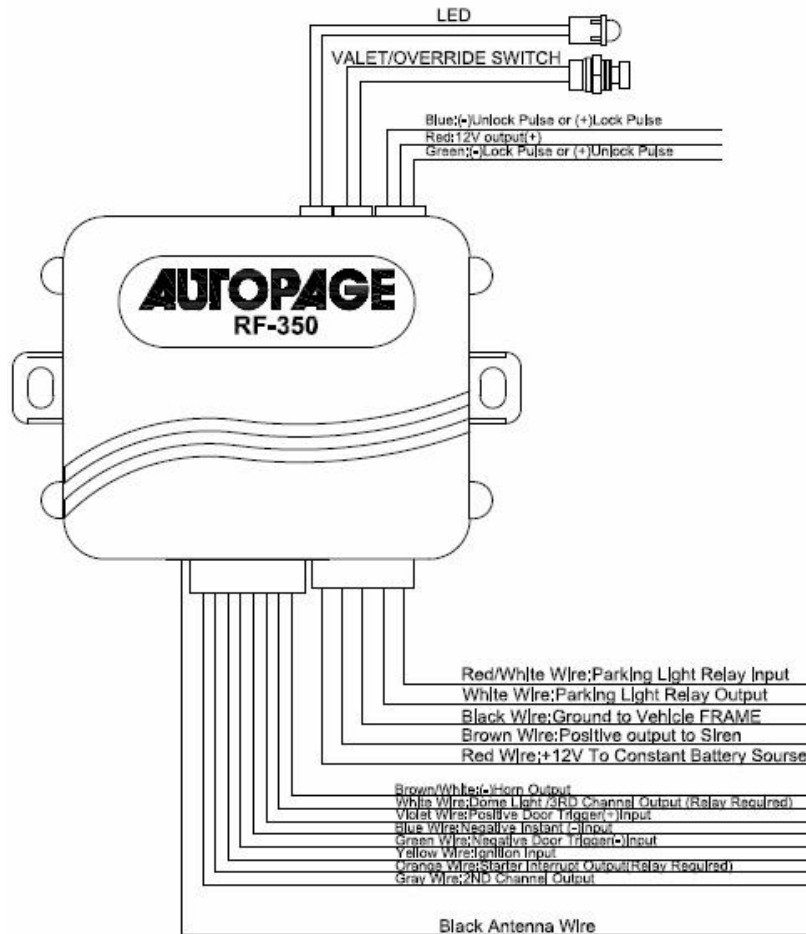

H1: MAIN 5 PIN WIRE HARNESS:

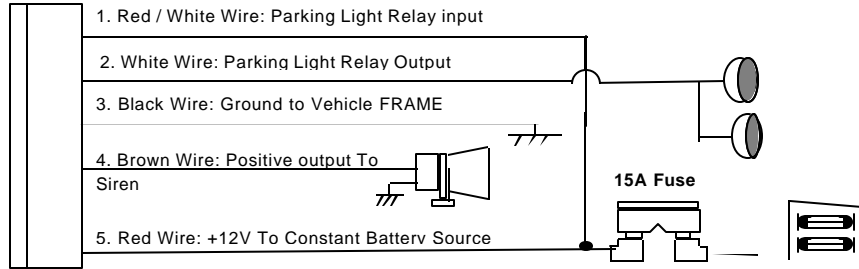

H2: 8 PIN MINI CONNECTOR WIRE HARNESS:

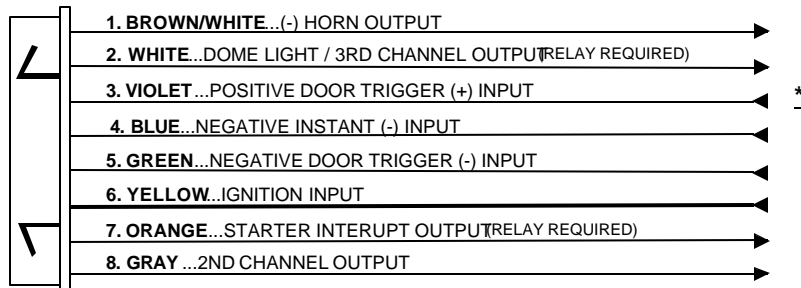

Siren and Starter Kill relay optional

DOOR LOCK DIAGRAMS

5-WIRE ALTERNATING DOOR LOCK

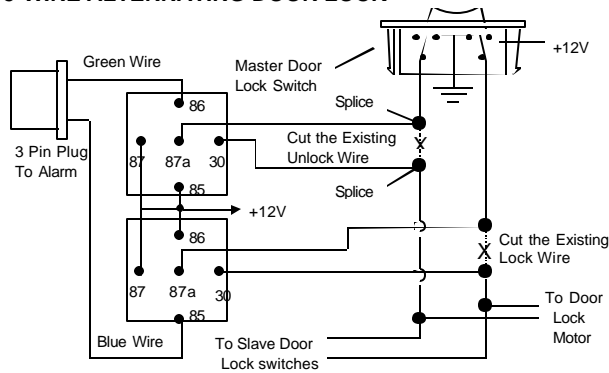

VACUUM OPERATED CENTRAL LOCKING

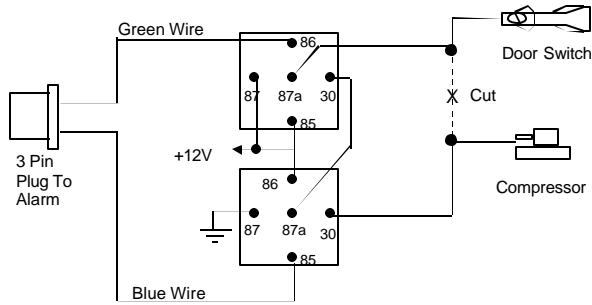

VACUUM OPERATED DOOR LOCKING SYSTEM:

TYPICAL OF MERCEDES BENZ AND AUDI.
 Locate the wire under the driver's kick panel. Use the voltmeter connecting to ground, verify that you have the correct wire with the doors unlocked, the voltmeter will receive "12 volts". Lock the doors and the voltmeter will read "0 volt". Move the alligator clip to +12V and the voltmeter will receive "12 volts". Cut this wire and make connections. Be sure to program door lock timer to 3.5 seconds.(See Feature II – 3 Programming.)

2 STEP DOOR UNLOCK WIRE CONNECTION FOR GROUND SWITCHED DOOR LOCKS

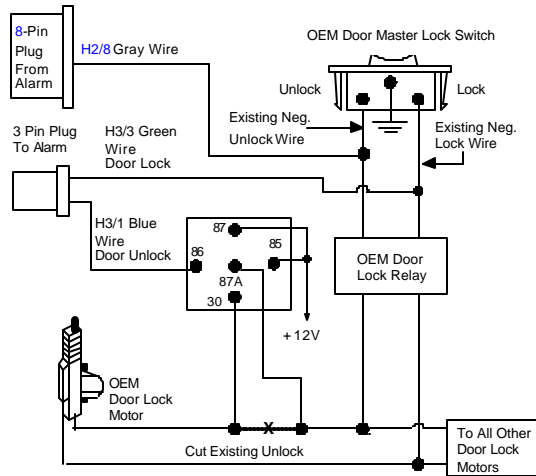

2 STEP DOOR UNLOCK WIRE CONNECTION FOR POSITIVE SWITCHED DOOR LOCKS

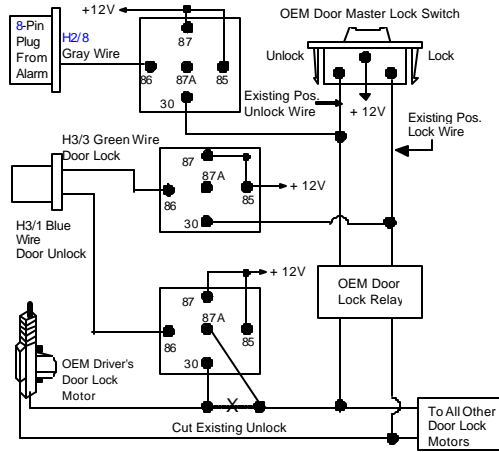

STARTER DISABLE (Optional)

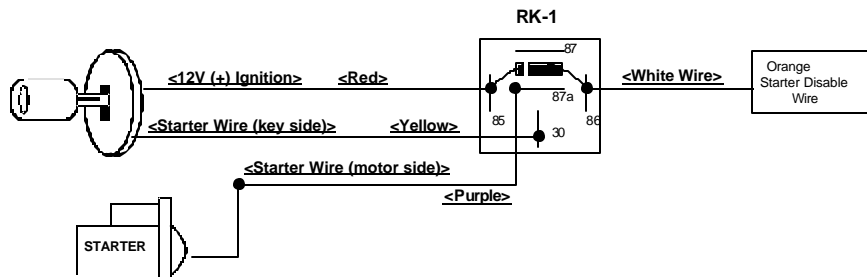

PROGRAMMING

PROGRAMMING TRANSMITTERS:

Enter:

1. Turn the Ignition 'switch 'OFF/ON' 3 TIMES and stay in **ON** position. Within 15 seconds,
2. Push the Valet switch 2 times and hold in on the **2nd push**. When a long chirp is heard release the valet switch. You are now in the Transmitter programming mode.

Program:

1. Press any button on the first transmitter until the siren responds with a confirming chirp. The first transmitter is now programmed.
2. Press any button on the second transmitter until the siren responds with a confirming chirp. The second transmitter is now programmed.
3. Apply the same procedure to program any 3rd or 4th transmitter.













Exit: Turn Ignition to the 'OFF' position, or leave it for 15 seconds. 3 long chirps will confirm exit.

Note: If more than 4 transmitters are programmed, the system will only keep the last 4 transmitters and delete the others.

ALARM FEATURE “A” PROGRAMMING:









1. Turn the Ignition 'switch 'ON/OFF' 3 TIMES and stay in **OFF** position.
2. Push the Valet switch 3 times and hold in on the 3rd push. When a long chirp is heard, release the valet switch. You are now in the Alarm feature 'I' programming mode.
3. Press the transmitter button corresponding to the feature you want to program.
 - a. *The factory default settings is always [1] LED flash, [1] chirp.*
4. Depress the transmitter button again to change the feature. Simply keep pressing the transmitter button again until the module advances to your desired setting.

Exit: Turn Ignition to 'ON' position, or leave it for 15 seconds. 3 long chirps will confirm exit.

Press Transmitter Button	One Chirp / LED one pulse Factory Default Setting	Two Chirps / LED two pulses	Three Chirps / LED three pulses	Four Chirps / LED four pulses
1 	Active arming	Passive arming without passive door locking	Passive arming with passive door locking.	
2 	Automatic Rearm off	Automatic Rearm on		
3 	Instant Door Ajar error chirp	45 seconds delay Door Ajar error chirp.		
4 * 	Siren Confirmation chirp on only	All Confirmation chirps On	Horn Confirmation chirp on only	All Confirmation chirps off
5  + 	H2/2 White wire= Dome Light Output	H2/2 White wire= 3 rd Channel Momentary	H2/2 White = 3 rd channel Latched	
6  + * 	Lock/Arm & Unlock/Disarm Confirmation Chirps	Lock/Arm Confirmation Chirp Only		
7.  + 	ALARM with Keyless Entry	Keyless Entry ONLY		
8. *  + 	Car Jacking feature Off	Car Jacking feature On		

ALARM FEATURE “B” PROGRAMMING:

- 1 Turn the Ignition 'switch 'ON/OFF' **3 TIMES** and stay in **OFF** position.
- 2 Push the Valet switch **5 times** and hold in on the **5th** push. When a long chirp is heard, release the valet switch. You are now in the Alarm feature ‘**B**’ programming mode.
- 3 Press the transmitter button corresponding to the feature you want to program.

Press Transmitter Button	One Chirp / LED one pulse Factory Default Setting	Two Chirps / LED two pulses	Three Chirps / LED three pulses	Four Chirps / LED four pulses
1 	Pathway illumination feature “off”	Parking light turns “on” for 30- second upon an unlock signal	Parking light turns “on” for 30- second upon an unlock signal & 10- second upon a lock signal.	
2 	Ignition controlled door locks & unlocks	Ignition controlled door locks only	Ignition controlled door unlocks only	Without ignition controlled door locks & unlocks
3 	0.8-second Door lock pulses.	3.5-second Door lock pulse.	Double pulse unlock	Comfort feature
4 * 	2 nd Channel Pulsed	2 nd Channel Momentary		
5 	*  Button = Silent Arm/Disarm	*  Button = 3 rd Channel Aux.		
6 	H2/8 Gray Wire = Trunk (Channel 2) Output	H2/8 Gray Wire = Two Step Door Unlock Output		
7. 	Horn chirp Duration Standard	Horn chirp Duration 50 mS	Horn chirp Duration 30 mS	Horn chirp duration 10 mS





Exit: Turn Ignition to 'ON' position, or leave it for 15 seconds. 3 long chirps will confirm exit.

ALARM FEATURE “C” PROGRAMMING:

1. Turn the Ignition 'switch 'ON/OFF' 3 TIMES and stay in **OFF** position.
2. Push the Valet switch **7** times and hold on the **7th** push until Three chirps with a long chirp is heard then release the valet switch. You are now in the Alarm feature 'C' programming mode.
3. Press and hold the transmitter  button for two seconds to enter shock sensor program mode.

Press Transmitter	One Chirp / LED one pulse	Two Chirps / LED two pulse
Button	Factory Default Setting	
1 		Shock Sensor Program Mode













ADJUST AND TEST THE SENSITIVITY LEVEL OF THE SHOCK SENSOR

1. Turn the Ignition switch 'ON/OFF' 3 TIMES and stay in **OFF** position.
2. Push the Valet switch 7 times holding in on the 7th push. Three chirps with a long chirp will be heard. Release the valet switch. You are now in the Alarm feature 'Shock Sensor' programming mode.
3. Press and hold  button for 2 seconds. One long siren chirp will indicate the unit is ready to accept adjustments of the shock sensor.
4. Press  button on the transmitter once. This will **decrease** sensitivity level by one. Each time the button is pushed and a decrease is made the siren/horn chirp will respond with [1] chirp. Two chirps indicate the minimum sensitivity. Warn away & full trigger will be **deleted** when minimum sensitivity is selected. **Shock sensor OFF**
5. Press  button on the transmitter once. This will increase sensitivity level by one. Each time an increase is made the siren/horn chirp will respond with [1] chirp. Two chirps indicate the maximum sensitivity.
6. Hit the bumper or strong metal part of the vehicle to test the threshold level of the sensor.
 - a). Activate the warn-away (first stage the shock sensor), the siren will emit a short chirp.
 - b). Activate the full alarm (second stage the shock sensor), the siren will emit a long chirp.
7. When you are satisfied with the setting, press the  button to lock in the adjustment. One long siren chirp will indicate the unit has locked in the adjustment.

Note: If 30 seconds of inactivity expires or you turn ON the ignition during of above steps, the unit will exit the program mode and return to the disarmed mode. Three long chirps will confirm exit.

Operation Manual

TRANSMITTER OPERATION:

Transmitter Button	System Function	Remark
	Lock Doors & Arm System	
	Panic function	Press and Hold for 3 seconds
	Car Locator	Under armed mode
 - 	Arm and Delete The 2 Stage Shock Sensor	Press twice within 3 seconds
 + 	Silent Arming / Disarming	Ignition in "off" position.
	Unlock Doors & Disarm System	
 - 	Two Steps Door Unlock & Disarm System	Press twice within 3 seconds.
	Trunk Release (Channel 2)	Press and Hold for 2 seconds
 - 	Passive Arming By-pass	While the system Disarmed.
*	Silent Arming / Disarming or 3 rd ch	
II	Switching code For 2nd Car Operation.	For regular remote transmitter Only

ACTIVE ARMING – LOCK & ARM:

1. Press  button on transmitter.
2. The siren will chirp once and parking light will flash once indicating that the system is now armed. The vehicle doors will lock upon arming when interfaced with the security system.

Note: **Defective sensor reminder:** If the siren sounds 3 chirps, then you have left a door, trunk, or hood lid ajar.

SILENT ARMING / DISARMING: Press the * button on the transmitter to arm or disarm your security system with no chirp sound heard; arm / disarm confirmation will be through the vehicles parking lights only.

SHOCK SENSOR / OPTIONAL SENSOR BY-PASS: Press the  button on the transmitter twice within 3 seconds will arm the security system, by-pass the shock sensor or the optional sensor connected to 4 pin plug. The system will chirp one additional time to confirm the sensor bypass mode was activated. The sensor bypass feature is programmed to activate for one arming cycle only. The security system will return to normal operation during the next arming cycle.

PASSIVE ARMING:

Active arming / disarming is controlling your security system via the remote transmitter. This security system is equipped with an optional Passive Arming feature, which allows the security system to arm 30 seconds after the last door is closed. Operation is as follows.

1. Turn the ignition to the "OFF" position and exit the vehicle. After all entrances are closed, the security system LED will flash fast for 30 seconds. If you reopen any door

- / hood / trunk, the security system LED will stop flashing. It will begin flashing again once all vehicle entrances are closed.
2. After 30-second timer has elapsed, the security system will automatically "ARM". The siren will chirp [1] time and the parking lights will flash [1] time.

PASSIVE DOOR LOCKING:

The vehicle doors will automatically lock after passive arming cycle has been completed.

ACTIVE DISARMING – UNLOCK & DISARM:

1. Press the  button on the transmitter.
2. The siren will chirp twice and parking lights will flash twice to indicate that the security system is now disarmed. The vehicle doors will unlock and disarm when interfaced with the security system.

TAMPER DISARMING: If the alarm is triggered; upon disarm the system, the siren will chirp 4 times and parking lights will flash 3 times.

TWO STEP DOOR UNLOCK: This feature will independently unlock the driver's door only when disarming the security system. Pushing the  button on the transmitter a second time within 3 seconds will unlock the entire vehicle.

AUTOMATIC RE-ARM: If this feature is selected, the security system will automatically re-arm itself 60 seconds after disarming with remote transmitter. Automatic rearm will cancel if any door is opened before the 60 seconds timer has elapsed.

DISARMING WITHOUT A TRANSMITTER

The Override function may be used if the remote transmitter is lost or inoperative.

1. Enter the vehicle and turn the ignition switch to 'ON' position. (Alarm will sound.)
2. Within 10 seconds push and release the valet switch. The alarm will stop sounding and enter the disarm mode. You can now start and operate the vehicle normally.

VALET MODE:

The valet switch allows you to temporarily bypass all alarm function, eliminating the need to hand your transmitter to parking attendants or garage mechanics. When the system is in valet mode, all alarm functions are bypassed, however, the remote panic feature and remote door locks will remain operational.

Enter Valet Mode:



1. Turn the ignition to "ON" position.
2. Push and hold valet switch for 2 seconds or until the LED turns on. The LED will remain on as long as the system is in 'valet mode'.

Exit Valet Mode:

1. Return to normal operation, turn ignition 'ON'.
2. Push and hold valet switch for 2 seconds; the LED will turn off indicating the system is exiting the valet mode.

PANIC FUNCTION:



The transmitter can be used as a remote panic switch to manually trigger the alarm in case of emergency.

1. Press and hold the  button on the transmitter for 3 seconds. The alarm will immediately sound.
2. To stop the alarm, press and hold the  or  button on the transmitter, the panic mode will be turned off immediately.
3. If the button is not pressed, the alarm will automatically stop after 30 seconds.

ANTI CAR-JACKING: (OPTIONAL) If alarm option is installed.

Warning: If you don't need the carjacking function in this alarm system, be sure to set carjacking feature "OFF". This system is default setting Car-jacking "OFF".

1. TRANSMITTER ACTIVATES THE CAR JACKING:

Press and hold  +  button on the transmitter for 1 second while the vehicle's ignition is ON. The parking light will turn on for 1.5" seconds to indicate car jacking activated.

2. DOOR SWITCH ACTIVATES CAR JACKING:

1. Turn the ignition switch to "ON" position, the system is armed.
2. Once the system is armed, if you are forced from the vehicle, the system will activate the carjacking trigger when the door is opened and closed while the ignition is "ON".

TRIGGER THE CAR JACK MODE:

3-timer circuits will function as follows:

First timer:

- a. 50 seconds after the system has been triggered. The siren or horn will start chirping for 15 seconds.
- b. During this 15 seconds period of chirping, you will be alerted to push the **valet switch** once to turn off the car-jacking feature.
- c. If not, it will enter second timer carjacking.
- d.

Second timer:

65 seconds after the system has been triggered. The siren or horn starts alarming and the parking light starts flashing.

Third timer:

90 seconds after the system has been triggered

- a. The siren or horn will still be alarming and the parking light flashing.
- b. The starter disable will activate to prevent the vehicle from starting.
- c. It will remain active until the vehicle's battery power is exhausted.

OVERRIDE THE SYSTEM TO TURN OFF CAR JACKING:

Turn the ignition switch from OFF to ON, and within 10 seconds push **valet switch**. The siren or horn will stop and the system will be disarmed.

TRIGGER THE SYSTEM

When armed, your vehicle is protected as follows:

1. Light impacts will trigger the warn-away signal. A long chirp from siren/horn.
2. Heavy impacts / Doors open / Hood open / Trunk open / Turning on the ignition switch- All will trigger the programmed sequence.

The starter disable relay (if installed) prevents the vehicle's starter from cranking. The siren and parking lights will turn on to alert of an intrusion for 30 seconds. Then the siren will stop and automatically reset and re-arm. If any the sensors or detectors are still active, the alarm system will sound a maximum of three-30 second cycles.

IGNITION CONTROL DOOR LOCKS.

If the vehicle's door locks have been interfaced to the security system, the system will automatically lock the vehicle's doors when the ignition is turned "ON" and /or unlock the vehicle's doors when the ignition is turned "OFF".

TRUNK RELEASE.

Press and hold  button on transmitter for two seconds to remote control the trunk release or other electric devices.

CAR LOCATOR

Press the  button on the transmitter to active car locator function. The siren will chirp 6 times. The parking light will flash 12 times, allowing you to easily locate your car.

P. PATHWAY ILLUMINATION

When disarming the security system, the vehicle's parking lights will stay on, illuminating a pathway to the vehicle. The vehicles parking lights will stay on for 30 seconds or until the vehicle's ignition is turned to the "ON" position.

ALARM INDICATORS

Function	Siren	Parking Lights	LED	Doors	Starter Disable
1. Arm	1 Chirp	1 Flash	Slow flash	Locking	On
2. Disarm	2or4 Chirps	2 or 3 Flashes	Off or Fast flash	Unlocking	Off
3. Trigger	Alarming	Flashing	Slow flash		On
4. Panic	Alarming	Flashing	Slow flash	Locking	On

CHIRP INDICATORS:

<u>Chirp</u>	<u>Function</u>
1 chirp	Arm
2 chirps	Disarm
3 chirps	Defective reminder
4 chirps	Disarm/ Intrusion
6 chirps	Car Locator

PARKING LIGHTS:

<u>Parking Light</u>	<u>Function</u>
1 flash	Arm
2 flashes	Disarm
3 flashes	Disarm/ Intrusion
12 flashes	Car Locator

LED INDICATORS:

<u>LED</u>	<u>Function</u>
Off	Disarmed
Slow flash	Armed
Fast flash	Passive arming
On (solid)	Valet mode

<u>LED</u>	<u>Function</u>
2 flashes... pause	Trigger on trunk/hood
3 flashes... pause	Trigger on door switch
4 flashes... pause	Trigger on Dual Zone Shock Sensor
5 flashes... pause	Trigger on Ignition switch

CHANGING THE BATTERY IN YOUR TRANSMITTERS

XT-33: The XT-33 transmitter uses two (2) 3-volt lithium ion batteries (#CR2016) that are sandwiched together with the (+) side facing upward. To replace the battery, you will need to use a small flat blade screwdriver. Locate the small notch on the lower right side of the transmitter case next to the key ring. Using the flat blade screwdriver, carefully pry the top case from the bottom case. It should snap apart after breaking the seal. Before removing the batteries note the direction of the positive (+) terminal. Place the new batteries in exactly the same manner, being careful not to bend or damage the contact terminal. Snap the cases back together and then test the transmitter to insure it arms and disarms the alarm.

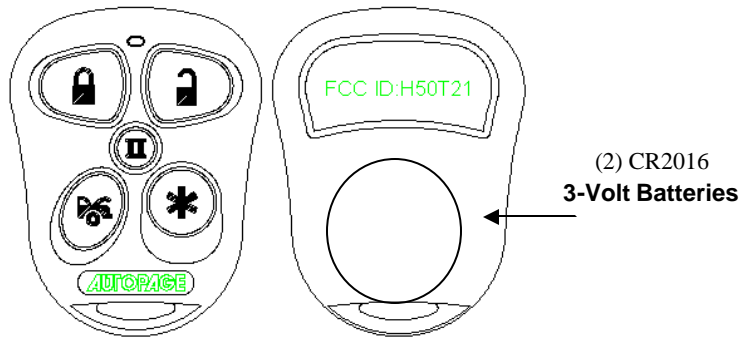

Additional remotes can be purchased at:

www.autopageusa.com

This device complies with part 15 of the FCC rules. Operation is subject to the following two conditions.

- (1) This device may not cause harmful interference, and
- (2) This device must accept any interference received, including interference that may cause undesired operation.

LIMITED LIFETIME WARRANTY PROVISIONS
(U.S. ,Continental U.S. and Canada Only)

1. Auto Page, Inc. WARRANTS that this new unit has been thoroughly inspected and tested at the factory prior to delivery. Your Auto Page equipment is guaranteed for "life" to the original purchaser/user of the equipment and the original vehicle in which it was installed by an authorized installer under the following conditions: If the product proves defective (according to Auto Page's testing) within the first year, the defective unit may be exchanged or repaired free of charge. "Proof of Purchase" (dated sales receipt) must accompany all warranty returns; **otherwise, your return will be rejected and sent back.** After one (1) year, the purchaser should ship the unit prepaid to Auto Page with a money order in the amount of \$30.00 to cover shipping and handling charges. **Note:** The product needs to be registered online at time of installation. www.autopageusa.com
2. Exclusion to the Limited Lifetime Warranty Provision: All two-way LCD and twoway OLED remote transceivers are excluded from the Limited Lifetime Warranty noted in paragraph no.1. All remote transceivers are guaranteed to the original purchaser for a period of one year from date of purchase. If the product proves to be defective within the first year, the defective unit may be exchanged or repaired free of charge. All other provisions stated on this card apply.
3. This WARRANTY will be considered void if the equipment has been misused, neglected, improperly serviced or installed, altered, dropped or damaged by water, contrary to the Auto Page OPERATIONS MANUAL. Or, if used with accessories not approved by Auto Page, which may have contributed to the defect. **See note below regarding product installation**.**
4. The purchaser's remedies under this WARRANTY shall be limited to the repair or replacement of electronic components only. **THE FOLLOWING IS NOT COVERED:** Damages or deterioration to cases, batteries, covers and cabinets; the cost of repairs, replacement and labor of which shall be borne by the purchaser even if occurring during the WARRANTY period.
5. Any equipment or parts which are claimed to be defective under this WARRANTY must be sent to the Auto Page Service center with "proof of purchase" at the purchaser's expense prior to such return, a Return Authorization Number should be obtained. Auto Page will return the equipment, charges prepaid. Warranty Service can be provided through the dealer where the equipment is originally purchased.
6. Any unexpired WARRANTY shall be applicable to equipment and parts in the possession of the original purchaser only.
7. THIS WARRANTY IS IN LIEU OF ANY AND ALL OTHER WARRANTIES, EXPRESSED OR IMPLIED, INCLUDING BUT NOT LIMITED TO ANY WARRANTY OF MERCHANTABILITY OR FITNESS FOR A PARTICULAR PURPOSE.
8. Auto Page shall not be liable, under the foregoing WARRANTIES or otherwise, for: Any personal injury of any kind to the purchaser, its employees or agents or anyone else whomsoever resulting directly or indirectly from the use or presence of the equipment or parts; Consequential damages of any kind; any inability of the purchaser to use the equipment.

****IMPORTANT NOTE:** Any damages to the Auto Page system resulting from an installation performed by anyone other than a professional installation technician authorized by a dealer of Auto Page will void the product's Limited Lifetime Warranty.

You must register your product online at <http://www.autopageusa.com> to receive any warranty service.

Please go to the *customer service* tab and select *product registration*.

It is the purchaser's responsibility to register this product for any future warranty service.

Warning: Some batteries may contain Perchlorate

What is Perchlorate? Perchlorate is both a naturally occurring and manmade contaminant increasingly found in groundwater, surface water and soil. Most perchlorate manufactured in the U.S. is used as an ingredient in solid fuel for rockets and missiles. In addition, perchlorate-based chemicals are also used in the construction of highway safety flares, fireworks, pyrotechnics, explosives, **common batteries**, and automobile restraint systems. Perchlorate contamination has been reported in at least 20 states. Perchlorate greatly impacts human health by interfering with iodide uptake into the thyroid gland. In adults, the thyroid gland helps regulate the metabolism by releasing hormones, while in children; the thyroid helps in proper development. Perchlorate is becoming a serious threat to human health and water resources. **“Perchlorate Material – Special handling may apply.”** For more information, go to <http://www.dtsc.ca.gov/hazardouswaste/perchlorate/>



960 Knox Street Unit B, Torrance, CA 90502

Tel: (310) 323-1800 or (800) 262-2527

www.autopageusa.com

Technical Support:

800-945-2527

(For Authorized Dealers Only)