



# access control

2013  
protect people, information, assets

## company introduction

TDSi protect people, assets and information by providing high quality, cost effective and well supported integrated access control and security systems.

As a **British manufacturer** with thirty years experience in access control technologies, our passion and dedication is reflected in every aspect of our business. At the heart of this lies a single minded commitment to quality and we have built an enviable reputation for the **reliability and durability** of our products, ensuring that we deliver excellent value on your investment. Our development programme also ensures the continued protection of that investment; all new software systems are backwards compatible with our existing hardware, providing future proof technology that reduces the cost of ownership and maximises your return on investment.

Our systems are of the **highest quality**, but they are also extremely cost effective. At a price that delivers outstanding value for money, each system provides the perfect combination of great functionality and high reliability together with ease of use and ease of installation. As specialists focused on the design, manufacture and support of access control systems, you can also be confident in our unrivalled technical knowledge and **outstanding support services**.

Our security solutions are not only competitive with regard to functionality and price, but also reflect the growing technological convergence between organisations' IT and security systems. **Designed to integrate** with a wide range of complementary technologies including biometrics, CCTV, fire and intruder alarms as well as building management systems, our systems enhance the effectiveness of your security as well as energy efficiency and sustainability programmes.

The comprehensive, scalable range has been developed to meet all your requirements. From stand alone networked solutions to fully integrated, advanced access control systems, you can seamlessly expand your system to meet the changing needs of your organisation.

Working with partners across the globe, we forge long term relationships with customers who require not only assured products and solutions, but also support services that enhance value – such as commissioning, remote and onsite technical support and software upgrades.

Our products and systems are supplied through a **global network** of authorised resellers, each of whom has been carefully selected to ensure they have the necessary skills to design, install and maintain your access control system to the standards that are rightly demanded of such a business critical investment.



*John Davies*

John Davies  
MANAGING DIRECTOR

## Warranty

TDSi offers up to **3 years** warranty across its entire range of products providing you piece of mind.

Additionally we offer a return to stock service so in case that you have ordered too many items or an incorrect item and as long as it is unused and in its original packaging, TDSi will take it back within 30 days.

## Customer Support

Our pre sales and post sales technical support is driven by our commitment to provide you with the very best service. Independent surveys give us high scores in customer support and give you the confidence you have chosen a supplier that can be trusted.

Offering a UK-based telephone support and on-site technical engineering service, we are available to support our customers during the installation, commissioning and use of the full range of our products.

For those customers wishing to expand their knowledge of the TDSi product portfolio we are pleased to offer our newly developed training programme: Gateway - Access to Knowledge. For more details on Gateway please refer to page 21 of this catalogue..

## Channel Partner Programme

Following a high level of demand, we are proud to announce the launch of our Channel Partner Programme. This is geared towards installers throughout the UK and Ireland who are actively promoting, specifying and installing TDSi products.

The programme has many benefits including free training sessions, demonstration equipment, project leads and contracts.

For more detailed information on the Channel Partner Programme please contact our Customer Care team at the Poole office. We will be more than happy to answer any questions that you may have.

## Contact us:

**TDSi UK** Unit 10 Concept Park, Innovation Close, Poole, Dorset BH12 4QT United Kingdom  
t: +44 (0)1202 723535 f: +44 (0)1202 724975  
e: sales@tdsi.co.uk support: +44 (0)1202 724998

**TDSi France** Immeuble ATRIA, 2 rue du Centre, 93160 NOISY LE GRAND France  
t: +33 (0)1 58 84 20 90 f: +33 (0)1 58 84 20 91  
e: tdsif@wanadoo.fr

**TDSi China** Rm 103, 1 Bld, Shangsha Innovation Science & Technology Park, 9283 Binhai Road, Futian District Shenzhen 518048, P.R.China  
t: 86-755-82535725, 82535720 f: 86-755-82535770  
e: tdsiinfo@microgarde.com.cn

[www.tdsi.co.uk](http://www.tdsi.co.uk)

## How to find us...

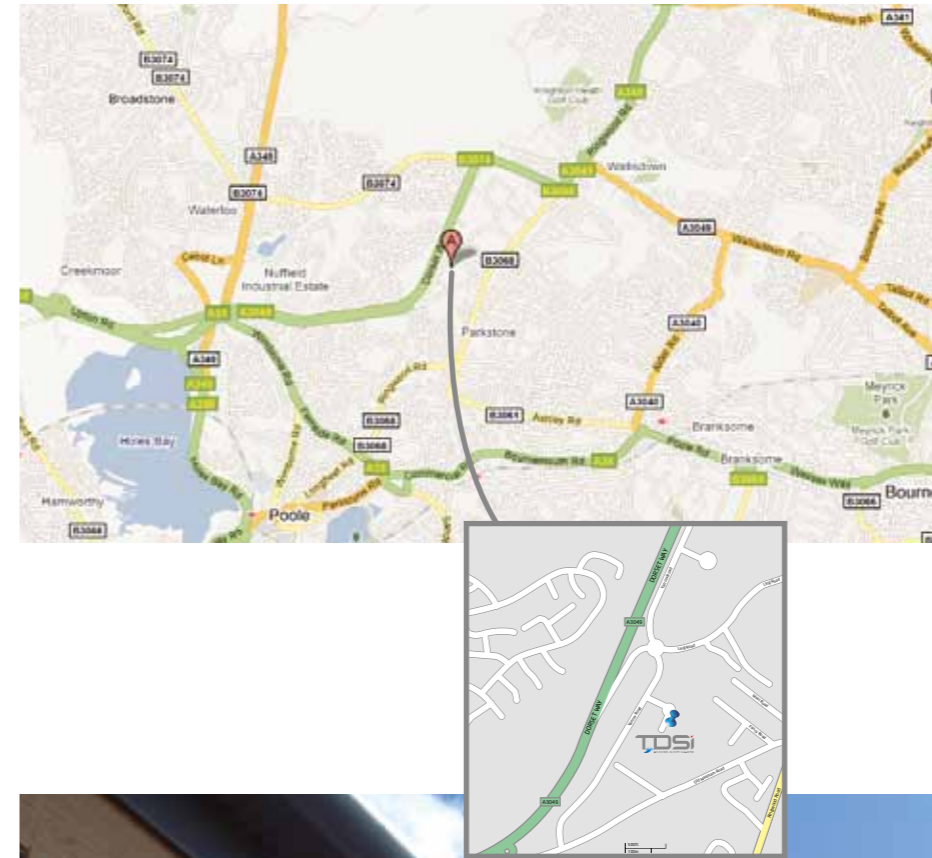

## Contents

SOLOgarde Stand alone access control system	04-05
MICROgarde® Network controller	06-07
EXcel Network controllers	08-09
EXpert Network controllers	10-13
Readers	14-15
Biometrics	16
EXgarde® Access Control Software	17-18
EXgarde® Powerful Integration Capabilities	19-20
Gateway Training Programme	21
Product List	22-26



# SOLOGARDE

## stand alone access control system

SOLOGARDE, the latest innovative stand alone access control solution from TDSi combines convenience and ease to both installer and user. Controlling a single door and up to 1,000 users, SOLOGARDE is ideally suited for small to medium-sized installations.

Replacing traditional locks and keys, stand alone systems win where it is not possible to install a network and the cost of the access control system is a prime consideration. Choosing SOLOGARDE means that you don't have to compromise on the features and advantages that can be gained from an electronic access control system.

Based on the MIFARE® contactless smart card platform, SOLOGARDE offers a significantly increased level of security when compared to standard proximity products. Since MIFARE® is an open platform, the card is also suitable for use in other applications such as library, cashless vending and POS offering the user a truly one-card solution.

When designing the SOLOGARDE system, we thought very hard about the problems that installers typically encounter. Nice touches such as the spring-loaded cable terminals mean that reliable connections can be made in a matter of seconds. And the controller can be mounted in a standard MK style electrical back-box meaning that you do not have to purchase a special enclosure for the product.

It is also very quick to install and commission the system thereby saving time and money. Simply install the controller and reader, apply power and then present the master card from the card pack and issue the cards to the users. That is it. SOLOGARDE is then ready to be used. For your convenience, SOLOGARDE card packs are available in convenient denominations and as few or as many cards as you like can be added to the controller memory.

Unlike offerings from other access control manufacturers the SOLOGARDE system features a simple hand-held programming tool and negates the need for shadow cards to be retained, making administration and management of the system simplicity in itself. Connected to the bottom of the SOLOGARDE reader, the programmer links to the very heart of the controller thus giving the user access to some very useful features indeed. After successfully logging into the controller, you are presented with an intuitive menu system complete with shortcuts allowing you to quickly access the areas of the menu that you need.

To help you comply with the Disability Discrimination Act (DDA), selected users can be placed in the DDA access group and an extended lock time is automatically applied to those users.

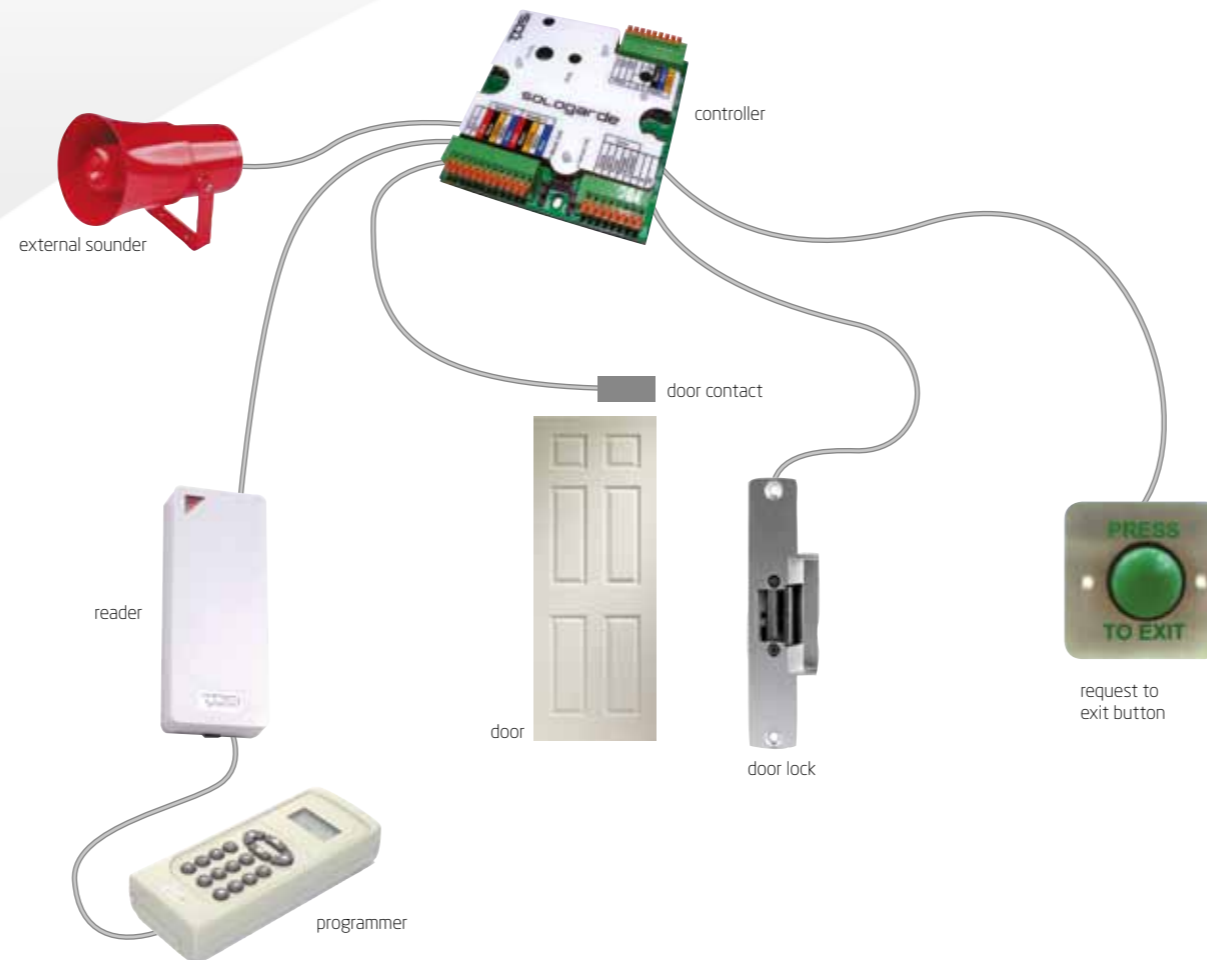

The controller can be used to set or unset an intruder alarm through use of the controller's Toggle Mode providing an integration capability. This mode allows dedicated users to change the state of the relay upon presentation of their card. However this mode could easily find uses in other applications such as the unlocking of lecture theatres or meeting rooms.

An integral sounder is fitted as standard which can audibly signal alarm conditions (such as the door being forced open or the tamper input being activated). In addition to this, the controller has a solid-state alarm output that can be connected to an external warning device such as a siren or flash unit. This relays the alarm condition providing a very visual or audible deterrent indeed.

SOLOGARDE offers a simple time grouping feature. By connection of a central heating style timer, the controller can allow or disallow groups of users through the door during certain hours of the day, thus enhancing security of the system further.

But the benefits of the programmer do not end there. For the installer or Facilities Managers, the hand-held programmer features some extremely useful fault-finding aids that can be used to quickly pin-point problems associated with the inputs, outputs, supply voltage, and internal faults. This minimises down-time should a problem develop.

You also have a choice of how to exit the door. Either connect an egress button to the controller or connect a second reader to the controller to give you true read-in/read-out capability.

The flash upgradeable processor allows you to keep the product up-to-date with all of the latest improvements that we make to the product.

TDSi also recognise that you will probably want your access control system to grow as your business does. In this respect SOLOGARDE has a very clear upgrade path to our range of network access control units without having to replace the readers or card population.

SOLOGARDE is also offered as a convenient starter kit including controller, reader and 25 cards. Simply add the number of hand-held programmers that you require. And don't forget that you do not need a programmer for each controller. Just order as many or as few programmers that you need to serve your requirements.

**In summary SOLOGARDE offers simple and straightforward stand alone access control without compromise!**

### Benefits

- Increased card security through use of a trusted smart card platform
- Quick and easy commissioning
- No shadow cards to manage
- Simple to install
- Interface to an intruder system
- Temporarily unlock a door upon single presentation of a card.

### Key Features

- Access management for a single door
- Up to 1,000 users
- Highly secure MIFARE platform
- Perform initial programming through a card pack
- Hand-held programmer for additional programming
- Extended lock strike time for selected users
- Mount in a standard electrical surface box

### Typical Applications

- Small-scale access control solution
- Remote locations to which it is not possible to install a network
- Small commercial
- Education
- Healthcare

### Options & Extras

**SOLOGARDE Card Packs.** Supplied in convenient denominations of 10, 25 and 50 cards per pack. Allows cards to be easily added to the system.



**SOLOGARDE fobs.** Supplied in packs of 25.



**Hand-held Programmer.** Provides the facility to add, delete and edit cards together with access to a raft of features of the controller.



**SOLOGARDE Reader,** can also be used as a second reader that can be connected to the SOLOGARDE controller providing true read-in/read-out capability



# MICROgarde

## network controller

MICROgarde®, TDSi's entry level range of networkable products allows you to enjoy many of the benefits of much bigger systems, without the need for a big budget.

Whether you're a distributor, installer or end-user, TDSi's MICROgarde® platform can offer something to satisfy your security or business needs.

For those exploring the world of access control for the first time, MICROgarde's ease of installation, reduced cost of ownership and competitive pricing make it simply the best value and most practical access control solution available.

The free EXgarde Express PC software provides support for a network of up to 50 doors. It features some very handy tools, such as automatic detection of the connected controllers, unlimited user definable holidays, full context-sensitive help system, automatic fire door release and timesheet reports. What's more you can even customise your own reports. And because it's intuitive it means that there's no need for special training.

If you want to discover the benefits of more advanced integration, such as CCTV, biometrics, Photo ID badge design and the like then you can migrate to TDSi's EXgarde® PRO or EXgarde Enterprise access management software, which supports the MICROgarde® controllers.

Available in 1 or 2 door versions, with or without TCP/IP or power supply unit, MICROgarde® offers unrivalled flexibility. All controllers feature distributed intelligence (which is battery backed) meaning that the controller operates and makes decisions even when communication to the host PC is lost. In this situation, events are stored within the controller until such time as communication is restored. Stored events will be uploaded to the host PC with no loss of transaction data.

If you need more inputs and outputs for interfacing to, for example intruder panels or building management systems, then an optional I/O module is available which is fitted within the case.

For installers there are many useful features that have been designed into MICROgarde® that significantly reduce effort and time and hence cost. Firstly a colour coded label shows all of the connections to MICROgarde®. So if you are using a TDSi eXprox reader, connection could not be simpler. The controller features flash memory allowing for simple software upgrades using a PC meaning that you can always keep up to date with the latest improvements and enhancements that we have to offer. A built-in RS-485 converter means that you no longer have to stock or fit a separate device. MICROgarde® is also clever

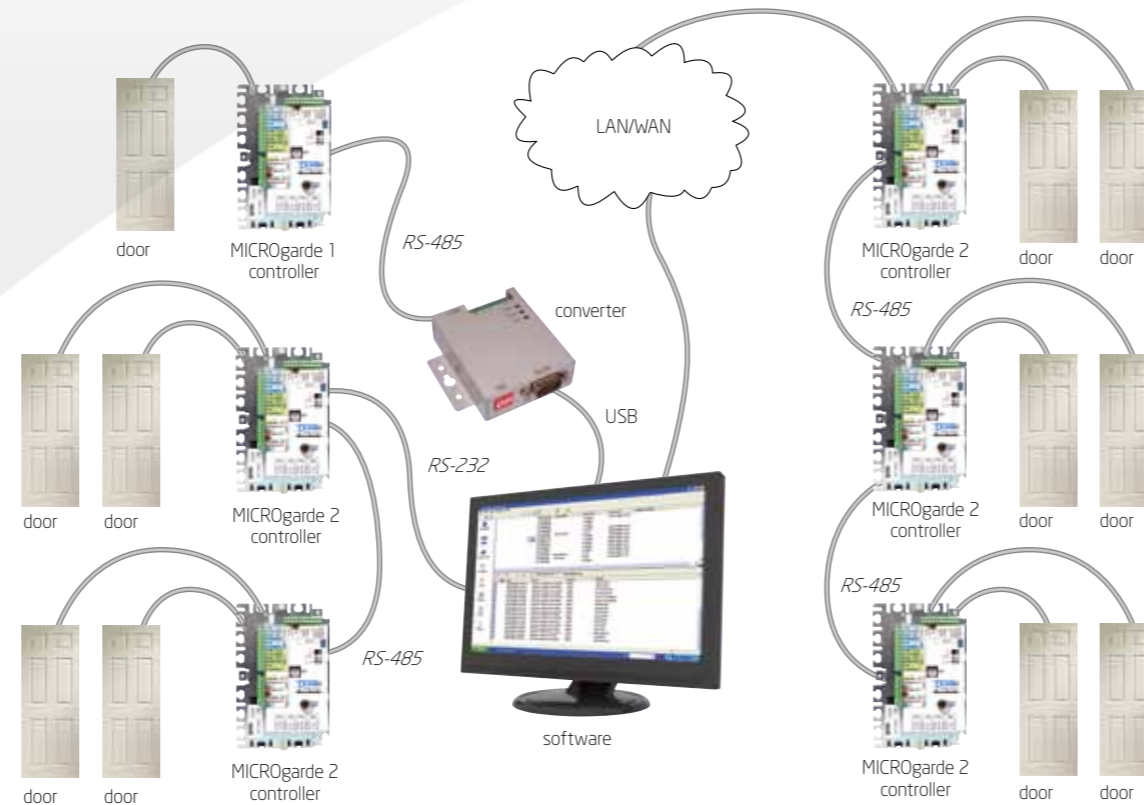

enough to resolve issues with the cables of the RS-485 network being incorrectly wired.

Put quite simply, even if your application is a single door with a handful of card users there will be a MICROgarde® based solution that is suited to you - one that delivers security, protection, low cost of ownership and a high return on your investment.

MICROgarde IP is able to be connected directly to any local area network (LAN) or wide area network (WAN). Based on the proven and successful range of MICROgarde door controllers, MICROgarde IP offers all of the benefits that you find with MICROgarde plus a convenient network option.

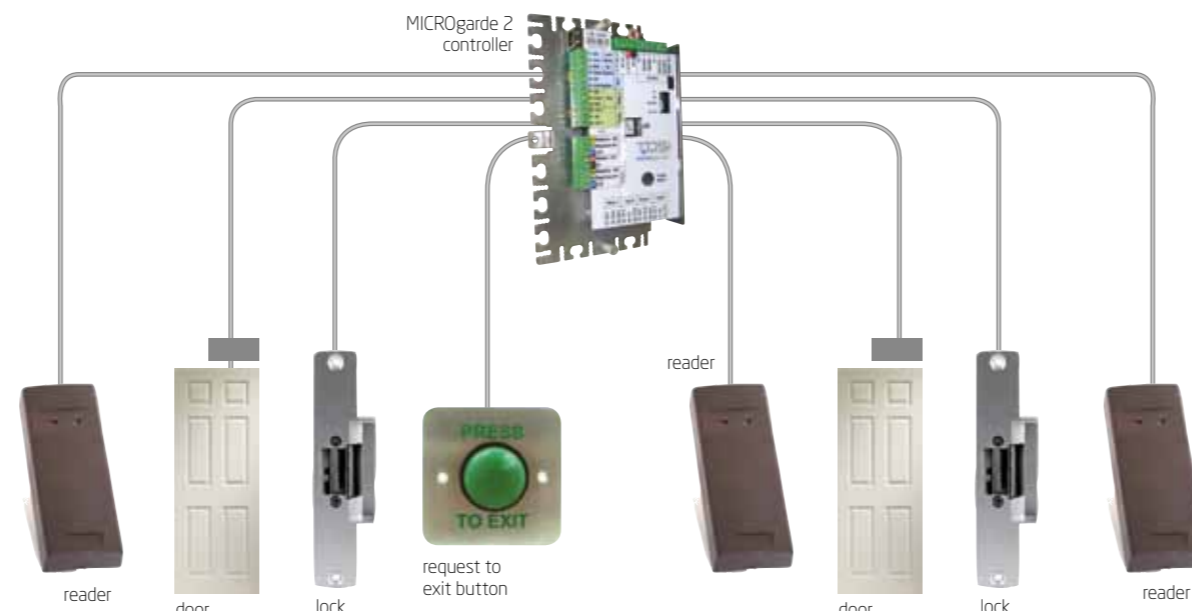

### Options & Extras



Input & Output module provides a means of connecting the controller to other systems such as building management systems, fire and intruder panels. It features 4 supervised inputs and 2 relay outputs and like the TCP/IP module it fits into the controller housing or enclosure.



TCP/IP Module allowing direct connection of the controller to an IT network. The module fits conveniently into the controller housing or enclosure



EXgarde® PRO advanced access management PC software unlocks many more features and integration possibilities including site plans, photo ID badge printing, CCTV and biometrics integration. EXgarde® PRO can also be connected to third party databases for interfacing to other T&A, Payroll or HR systems.



Communications lead connects the serial port of the PC to the controller when using the in-built RS-232 to RS-485 converter



Protocol Converter - USB to RS-232/RS-485. Converter needed if distance from PC to first MICROgarde controller exceeds 15m.

### Benefits

- Flexible system design through 1 or 2-door controllers
- Read-in/read-out on all doors
- Capable of being used with either TDSi or other third-party readers
- Link to the fire system for automatic release of selected doors
- Simple installation
- IP version allows direct connection to an IT network
- Monitor users' movements through configurable reports
- Minimal training required for operation
- Clear upgrade path using EXgarde PRO software

### Typical Applications

- Small to medium-scale access control solution
- Access control where real-time event monitoring and reporting is needed
- Commercial
- Education
- Healthcare
- Banking & Finance

### Controllers



MICROgarde® 1 or 2 Door Controller



MICROgarde® 1 or 2 Door Controller with 3A PSU

### Key Features

- Straightforward networked access control solution
- **Free of charge** EXgarde Express software included for management of up to 50 doors, 10,000 users
- Power supply and IP versions available
- Input/Output module allows monitoring and control of third-party systems
- Built-in protocol converter



# EXseries

## network controllers

TDSi's EX Series controllers are the building blocks for mid to large size, single or multi-site networked access control and integrated security system networks.

Whatever your point of view - distributor, installer, systems integrator or end-user, TDSi's EX Series platform can offer something to satisfy your security or business needs.

# EXCEL

The EXcel<sup>2</sup> and EXcel<sup>4</sup> are versatile access control units serving 2 and 4 readers respectively, they provide an extremely cost-effective solution to the access control and integrated security requirements of today. They feature on-board supervised inputs and output relays making them suitable for monitoring and signalling alarm conditions or for integration with intruder alarm, fire, lighting, heating and building management systems.

TDSi EXcel controllers operate on a distributed intelligence principle in that all of the system parameters are retained within the controller. So even if the network connection is lost, the controller will continue to operate and make access decisions providing maximum security and giving you piece of mind.

EXcel<sup>4</sup> also has an in-built TCP/IP port as standard to allow connection directly to a modern IT network, simplifying installation and commissioning.

Housed in a metal enclosure, EXcel controllers feature a high capacity on-board database of up to 24,000 users making them particularly suited to applications that have a large number of users and providing ample scope for future expansion. The enclosure also features a high-quality power supply that is suitable for providing power to controllers, readers and locks.

EXcel access control units can be used in conjunction with EXgarde<sup>®</sup> PRO access management PC software application, providing a complete fully configurable networked access control system.

In summary EXcel access control units are an excellent choice for those seeking a flexible and solid base for their access control needs.

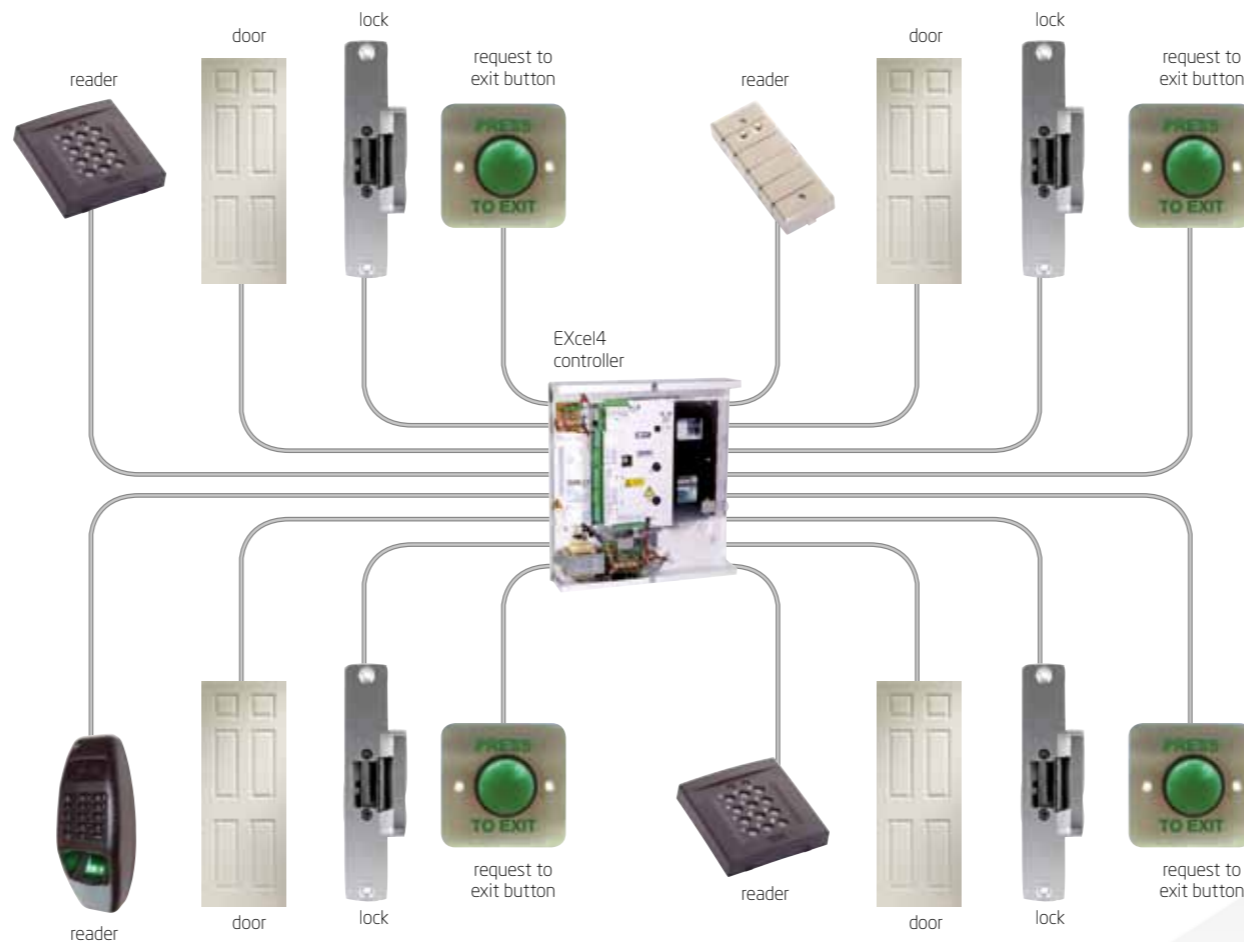
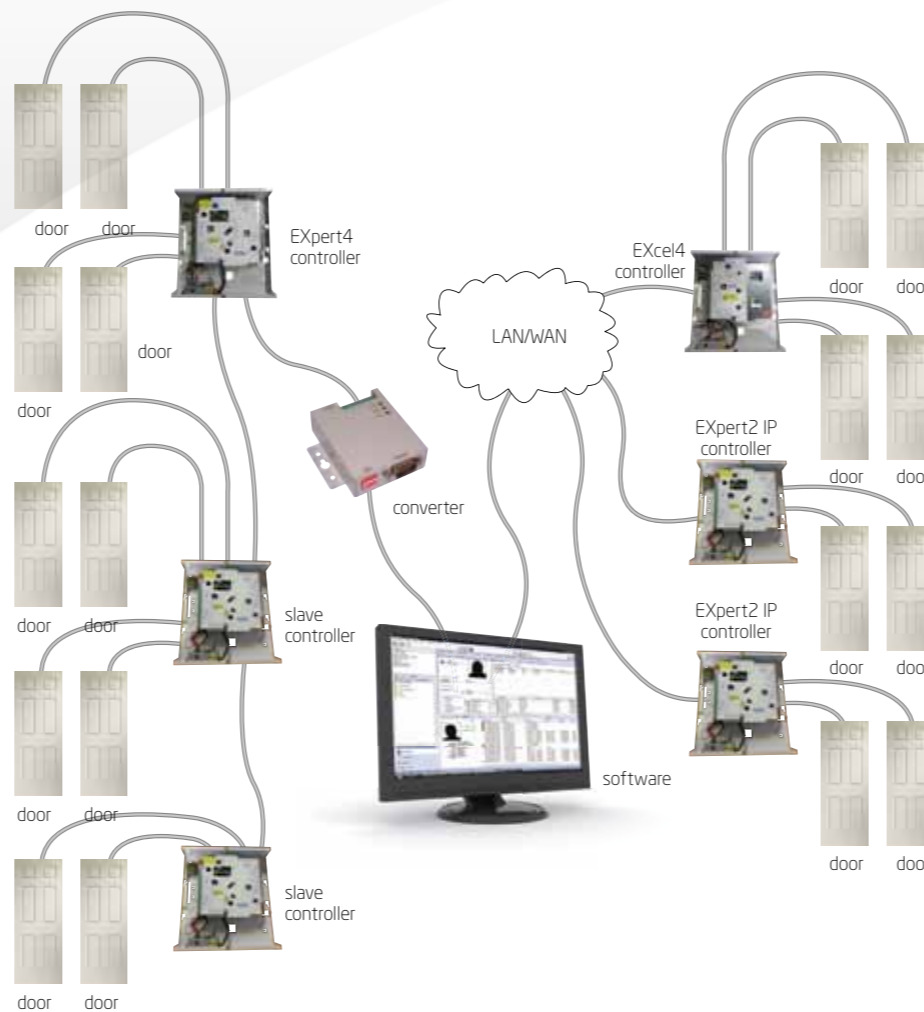

## Options & Extras



Protocol Converter - USB to RS-232/RS-485.



Protocol Converter - Ethernet To RS-485

## Controllers



EXcel2 - 2 Reader, 1 or 2 Door Controller with 4A PSU



EXcel4 - 4 Reader, 1 to 4 Door Controller with 4A PSU & TCP/IP

## Universal Decode Feature

TDSi recognises that it is not always possible to use a TDSi reader. For example, a particular reader may have already been specified or it may be that it is necessary to replace the controllers whilst retaining the existing reader and card population. This is where the Universal Decode feature of TDSi EX-Series controllers and EXgarde PRO software really comes into its own.

Universal Decode allows you to take the Wiegand output from any reader and manipulate it so that the card number reported by the system matches that on the card.

The whole process is handled through the EXgarde PRO PC software and with all of the popular decode formats already pre-defined, the set up of this invaluable feature is straightforward.

## EX-Series Typical Applications

The range of EX-Series door controllers are suitable where control of a larger number of card holders is required.

EXpert adds the ability to serve a large amount of I/O making it particularly suited to alarm monitoring, interfacing to a building management system or lift control.

Typical applications include

- hospitals
- utility sector applications
- large-scale transportation
- industrial.



# EXpert

A fully featured networkable access control unit, the EXpert<sup>2</sup> boasts a high specification with supervised inputs and relays making it suitable for monitoring and signalling alarm conditions.

The expansion capability of this versatile controller enables the access control system to be expanded upon at a later date. EXpert is the ideal platform for those who demand the most from an access control system.

With a capacity for up to 48,000 cards, this product is suitable for those applications that need to control large numbers of people through access points such as educational and large corporate establishments.

EXpert controllers can be connected in a master/slave configuration. Up to 7 slave units can be connected to each master controller allowing complete autonomous control of up to 16 doors in one sub-system, this being programmable either through use of EXgarde<sup>®</sup> PRO access management PC software or the optional EXkeypad which allows the controller to be operated in a true stand-alone mode.

EXpert master controllers are available with a TCP/IP port allowing direct connection to modern network infrastructures offering maximum convenience during installation and commissioning.



## EXkeypad

Experience TDSi innovation at work. The EXkeypad is a hand-held programmer for EXpert2 and EXpert4, that can be used instead of a computer to set up a system and greatly aid system diagnostics. The EXkeypad allows a system of up to 16 doors and readers to be set up and managed from one location entirely without the need for a computer. Its intuitive menu system together with audible feedback make this extremely quick and easy to use.



## EXpert expansion options - Flexibility is the key

Each EXpert<sup>2</sup> is expandable in 2 ways: -

It can be fitted with 1 of 2 types of expansion card: -

- **EXpander<sup>2</sup>** which adds 2 doors, readers, inputs and relays
- **EXin/out** which adds 16 relays and 32 inputs

It can also be linked via RS-485 to EXpert<sup>2</sup> Slave controllers: -

- Creating a sub-system of up to 16 doors and readers.
- Reducing the cost per door in large systems and providing antipassback across 16 readers.

## Lift Control

An EXpert<sup>2</sup> fitted with an EX in/out or EXout can be used for controlling up to 36 floors for elevator/lift control.

## EXpert Building Blocks

- 5002-3002 EXpert<sup>2</sup> - Master controller complete with power supply and RS-485 connectivity housed in a metal enclosure. Space available for optional EXpander<sup>2</sup> slave or I/O boards.
- 5002-3022 EXpert<sup>4</sup> - Master controller complete with power supply and RS-485 connectivity housed in a metal enclosure. Complete with one Expander<sup>2</sup> slave PCB pre-fitted for convenience.
- 5002-3042 EXpert<sup>2</sup> Slave - Slave controller complete with power supply housed in a metal enclosure. Space available for optional EXpander<sup>2</sup> slave or I/O boards. Use in conjunction with EXpert<sup>2</sup> master controllers.
- 5002-3063 Expander<sup>2</sup> slave PCB. Additional slave PCB that fits in EXpert<sup>2</sup> master or slave enclosure.
- 5002 3012 EXpert<sup>2</sup> IP - Master controller similar to 5002-3002 but with TCP/IP connectivity.
- 5002-3032 EXpert<sup>4</sup> IP - Master controller similar to 5002-3022 but with TCP/IP connectivity.

### Options & Extras



Protocol Converter - USB to RS-232/RS-485.



Protocol Converter - Ethernet To RS-485



EX in/out I/O expansion board.  
Provides an additional 32 supervised inputs and 16 relay outputs.



EXpander<sup>2</sup> - 2 Reader, 1 or 2 Door Expansion Module for EXpert Controllers.

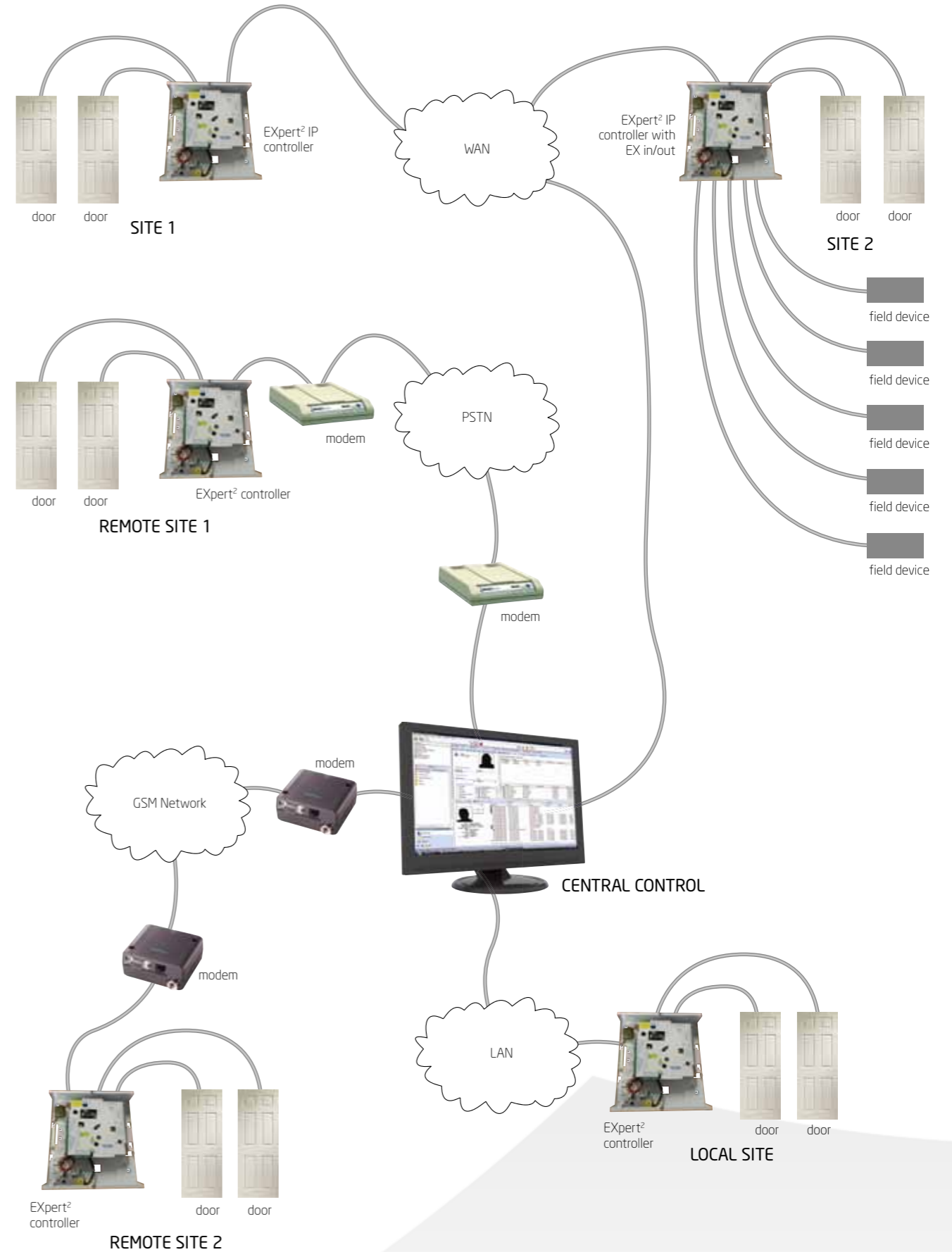

# EXpert

## using EXpert for lift control

The EXpert controller when used to control a lift can provide you with many features and enhances your access control system significantly.

The system works on the principle that each of the floor selection buttons in the lift cab are controlled using the relays on the EXpert fitted with the EXin/out or EXout expansion modules. When a user presents their card to the reader within the lift car the EXpert controller makes the decision as to which floor selection buttons to enable. This means that the lift user can only access those floors to which they are allowed. The advantages of this are very clear. If the user cannot request the lift to stop at floors to which they do not have access then security is maintained.

EXpert controllers together with the EX in/out expansion module can serve a building with up to 20 floors making this suitable for the majority of applications. However we can supply an EXout32 card on request which increases this capability to an impressive 36 floors. Additionally floor selection buttons with 'common' access restrictions can be served by the same relay in effect increasing the number of floors controlled yet further.

Use of the inputs on the EXpert and EX in/out expansion module can also be used to monitor the actuation of the floor selection buttons, thereby providing real-time feedback and monitoring of which buttons are pressed and when. This information is also logged to the EXgarde PRO database providing you with an event trail for auditing purposes.

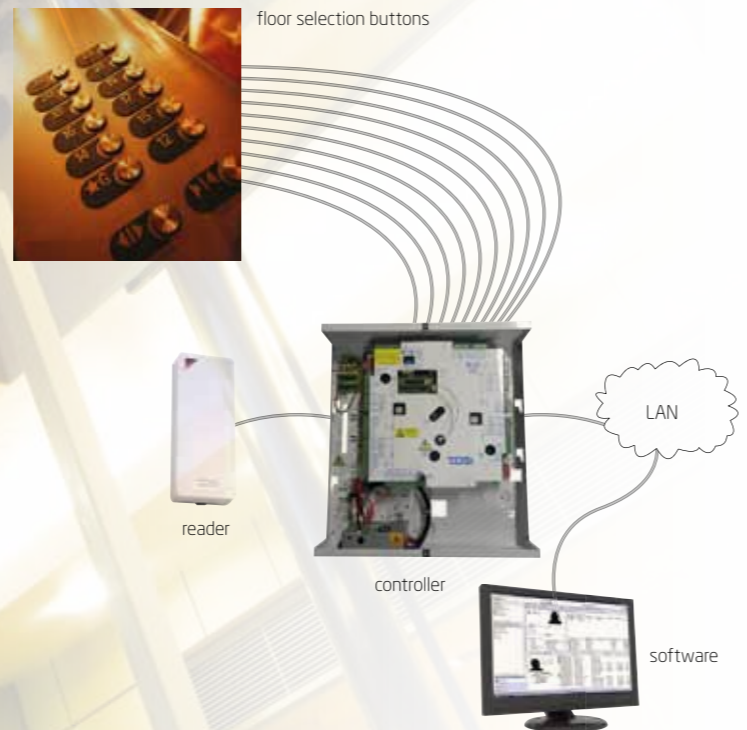

## TDSi Controllers

All of our network access control units are feature-rich and provide you with a raft of business benefits.

For the system specifier, our easy-to-understand philosophy makes it much simpler for you to learn the architecture of our systems. Any of our controllers can exist without issues on the same network meaning that you can mix and match controllers to suit the differing requirements for various parts of the installation. For example, you could specify MICROgarde® controllers for door control and use an EXpert controller fitted with an input/output card controlling a lift. Additionally the industry standard reader interface on our range of controllers allows you to retro-fit them to existing installations without having to change the readers and card population.

For the installer, we have thought long and hard about how to make life easier. All of our controller enclosures feature multiple cable entry options, including knock-outs for trunking and conduit. Colour coded terminal labels match the cable colours of our readers making wiring up extremely intuitive. And the additional modules available for our MICROgarde® range of controllers fit within the controller enclosure making for a very neat and tidy install indeed.

Facilities Managers and those responsible for ongoing maintenance of the system will find features such as the power supply monitoring and diagnostic LEDs invaluable for keeping the system in check and quickly finding faults.



Feature List

	Stand alone	Networked	Maximum doors	Maximum readers	Power Supply with Battery Back Up Facility	Event Buffering	Monitoring of Power Supply	Maximum Spare Inputs*	Lock Relays*	Maximum Spare Output Relays*	Time Zones	RS-232 / RS-485 Connectivity	RS-485 Phase Reversal	Ethernet Connectivity
MICROgarde I	-	•	1	2	◦	•	•	2	1	1	64	•	•	◦
MICROgarde II	-	•	2	4*	◦	•	•	0	2	0	64	•	•	◦
EXCEL <sup>2</sup>	-	•	2	2	•	•	•	4	2	2	64	•	-	-
EXCEL <sup>4</sup>	-	•	4	4	•	•	•	0	4	0	64	•	-	•
EXpert <sup>2</sup>	•	•	2	2	•	•	•	4	2	2	64	•	-	◦
EXpert <sup>4</sup>	•	•	4	4	•	•	•	8	4	4	64	•	-	◦

- Not Available  
 • Standard  
 ◦ Optional  
 + In full door mode  
 \*When using TDSi EXprox, Exprox<sup>2</sup>, Optica, EXsmart<sup>2</sup> or Digital IR readers only

This matrix provides you with a list of all of the key features of our range of network access control units allowing you to quickly compare and make the right choice for your particular application.



## Readers

A range of **high quality** readers and keypads that deliver maximum choice to suit all project requirements. With options from proven technologies (including biometrics, MIFARE and proximity) together with a number of **unique**, innovative products, customers are able to make key choices to meet their design, operational, performance and budgetary objectives.

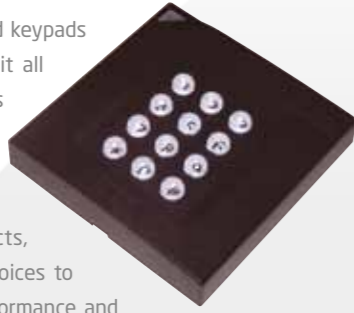

## Optica Keypad

The unique and innovative designed keypad has no moving parts to wear out or sabotage and is subtly backlit with blue LEDs. Optica® is available with either tough ABS plastic covers or as a vandal resistant (VR) version in a contemporary stainless steel housing. All versions feature industry standard clock & data and Wiegand outputs making them suitable for use with all standard access control units.



## EXprox Reader



EXprox and EXprox<sup>2</sup> are a range of high quality high performance contactless card readers. The mullion mount EXprox reader is available in a robust ABS plastic or vandal resistant stainless steel housings and all readers have an excellent read range. EXprox<sup>2</sup> can be ordered with or without a blue backlit keypad and is supplied in a tough plastic housing.

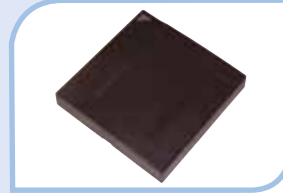

Each of the plastic housed readers are supplied with two clip-on covers in a choice of two colours. This simplifies the ordering of readers and ensures that they complement or contrast the wall colour for the desired look. All readers are fully encapsulated and can be installed in internal and external applications.

When using the readers an audible and visual indication of card reads together with access status are provided at the reader.

## Panel Reader

PANELgarde from TDSi is a versatile panel mount reader offering a wide range of output formats. PANELgarde is fully encapsulated which is suited to harsh environments such as condensation and fluctuations in temperature which can be experienced inside a door audio/video entry panel.

Audible and visible indication is provided by an integral sounder and a bi-coloured LED which is controllable. PANELgarde can also be mounted inside a standard MK-style UK electrical back box making it ideal for concealed installations.



## MIFARE® Based Solutions

TDSi has much experience in the field of smart card technology and has seen its comprehensive range of readers and cards supplied into many installations.

Based around the well proven MIFARE® platform that TDSi has adopted as it's smart card technology of choice, TDSi has been continually refining and expanding its product range to cater for the ever-changing requirements of it's customers. Now TDSi are able to provide readers in various formats to meet the needs of a range of applications all being suitable for external mounting.

**EXsmart<sup>2</sup>** is a range of readers that offer a choice of mounting methods – fit the reader either on the mounting surface or into a standard electrical pattress box saving significant installation time.

Available in a combined reader and keypad product, EXsmart<sup>2</sup> allows added security by requiring both the card and a PIN to be presented before access is allowed.

**TDSi mullion mount MIFARE reader is available in two variants.**

The first is able to read the unique chip serial number (CSN) from any MIFARE card. This reader is particularly useful in applications where it is not possible to utilise any of the sectors on the MIFARE card for access control (for example they may be being used by other applications) or if an already-existing system uses the CSN for identification.

The second is a sector reader that is programmed to read the number from TDSi's pre-programmed sector 4 cards. However the versatility of this reader allows it to read any sector through user-defined keys for the ultimate in security. Furthermore the reader can also be used in existing installations that operate on a user-defined sector and keys.



TDSi Proximity Card 4262-0245  
TDSi Proximity Card With HICO Magnetic Stripe (Not Encoded) 4262-0247  
TDSi Proximity Keyfob 4262-0246

TDSi also offer a MIFARE® programming station that can be used to program a number into MIFARE® cards for use with the sector reader. This can be ordered with the added feature that allows a set of configuration cards to be produced to allow the custom configuration of the sector reader.

**The result is a complete product range that offers a complete solution for any smart card-based system.**

## Dual Technology Desktop Enrolment Reader

The keyboard MIFARE® smart card serial number wedge reader connects locally to the PC through the keyboard which in turn inputs data into the EXgarde® software application. The reader reads the unique 32-bit code from any MIFARE® smart card when it is presented. The benefit to the operator is to capture quickly this information without having to move away from the PC. The reader can be connected directly to the PC via a USB connection.



## MIFARE® Card Programming Station

The TDSi MIFARE Card Programming Station provides a simple method of programming a number into the chosen sector of a MIFARE card. The application also features other useful tools such as a card check that allows you to see at a glance if any of the sectors on the MIFARE card have been programmed already. The station comes complete with software and a USB MIFARE reader/writer on which the cards are programmed.



Plain White MIFARE® Card (1k) 2920-3000 (4k) 2920-3001  
White MIFARE® Card With Serial Number Printed (1k) 2920-3002 (4k) 2920-3003  
White TDSi MIFARE® Sector 4 Card With Number Printed (1k) 2920-3004 (4k) 2920-3005  
Plain White TDSi MIFARE® Sector 9 Card - Clock & Data Format 2920-0182  
TDSi MIFARE® Reader Custom Configuration Pack 2920-3010

## Energy Saving Switch

Our new Energy Saving Switches give commercial and public building operators the ability to make significant energy and cost savings. Drawing on proven technology, the intelligent Energy Saving Switches incorporate either a Proximity or a MIFARE® reader. Only when a specific card has been recognised, does the unit allow the electrical circuit to be completed, thereby allowing lights and other equipment to operate. The product also features a 30 second time delay, so that once the card is removed, lights remain on for a period, allowing occupants to comfortably vacate the room.



## Long Range Readers

TDSi offers an extremely cost-effective RF long-range reader solution that delivers exceptional read-ranges.

Using 2-button key fobs which transmit a unique and highly-secure encrypted code to a receiving unit, this solution is ideally suited to vehicular control (such as a car park) where it is required to remotely open a barrier or hands-free operation of doors. The system allows the connection of the 2 channels of the receiver to a TDSi access control unit, providing the ability to control 2 access control points through one 2-button keyfob.

The fob can be used at a distance of up to 100 m from the receiving unit allowing the receiving unit to be mounted neatly in a roof space or other area.

Programming of the system is very straightforward. Simply press the button on the fob that you wish the receiving unit to 'learn' twice and when one of the buttons is then pressed the number of the fob will then be output on the relevant channel of the receiving unit.

The fob can be ordered either with or without an in-built proximity tag allowing the fob to be not only used for long-range control of access points but also for regular access control around a building using TDSi Proximity readers or keypad readers providing a complete solution.

Each fob features a robust and stylish blue housing with LED indication to show when one of the buttons has been pressed.



## IR Reader

TDSi's unique IR reader is available in either analogue or digital output formats and so is compatible with new or legacy TDSi systems. The reader is housed in an elegant metal enclosure and mounted on a matching back plate. Simple two hole fixing allows for straightforward installation.

The IR reader is based on the use of infra-red light passing directly through the card within which a security code, unique to every Microcard using visually black but infra-red transparent material. Each code is unique and fixed at the point of manufacture, thus its identity can never be altered.

The inherent nature of Microcard® technology means that it is completely reliable – cards are read first time, every time and are waterproof to IP65. In addition they are extremely resistant to vandalism. The digital readers can also be interfaced to most access control units available.



Microcard - Plain White 4801-0008  
Microcard - Plain White + HICO Magnetic Stripe (Not Encoded) 4801-0009  
Microcard - Plain White Card Plus Laminate Overlay 4262-0218  
Infra Red Key Card 4062-0080

## Infra-red





# Time and Attendance

In 1982, TDSi started out as a manufacturer of Time and Attendance products. Thirty years on this tradition continues and alongside our award winning access control products, TDSi still offers time and attendance readers as part of our diverse portfolio. Where required, TDSi's time and attendance systems can be easily integrated into other HR and payroll systems as well as TDSi's own access control management software suite, EXgarde. This close integration provides a system that enables the system components to be shared and then utilised to the maximum effect.

## Biometrics

Quite rightly, biometric reading technologies are viewed as being at the cutting edge of security technology.

From the very first commercial application for a fingerprint reader in 1984 the market has regularly seen the introduction of new products and applications. Some are clearly concepts where manufacturers 'test the water' whilst others quickly gain acceptance and find their place in real-life applications.

A large number of sites are already using biometric technologies to great success. These include financial institutions, school libraries, prisoner identification and airport frequent flyer programmes to name but a few.

Today there is large degree of choice in the products that are available allowing you to effectively balance accuracy, quality, reliability, performance and cost.

TDSi's Facial Recognition reader is a stand-alone or networkable unit that offers secure access, free of tokens or cards.

Utilising the unique shape of the human face, the reader provides a highly secure, rapid, reliable and convenient method of controlling access to sensitive or restricted areas. It can easily be added to existing or planned security and surveillance systems to maximise return on investment - storing up to 500 users and verifying identity in less than one second. The reader also operates in virtually all light conditions with an impressive False Acceptance Rate (FAR) of less than 0.0001%.



## DIGIgarde PLUS

DIGIgarde PLUS combines all authentication modes - something you know (PIN), something you have (card) and something you are (finger) in one attractive and cost-effective unit.



Featuring a high-resolution optical sensor and an extremely quick matching algorithm, DIGIgarde PLUS gives maximum usability and is suitable for control of access points that require a control of a large number of users and are subject to high a throughput of traffic.

The backlit tactile keypad, white-on-black display and dual-colour LED give user of the product excellent feedback and an easy to operate local programming interface.

The reader can be fully integrated into our EXgarde PRO advanced access management software when connected to any of our access control units, providing seamless enrolment and distribution of templates.

# EXgarde

## TDSi's Access Management and Integrated Security Systems Management Software

TDSi's mission and stated goal is to help its customers deliver integrated security solutions that add value to their business. A key driver for us is to make this easy to accomplish.

TDSi's EXgarde® PRO platform is a key component in delivering this mission.

EXgarde® PRO is a fully featured Access Management PC software application that combines the latest in TDSi innovation in a single package with a user friendly interface. It can be used to control 1 door at 1 site with a few users to thousands of doors at multiple sites with thousands of users.

EXgarde® PRO can be used to seamlessly integrate the many aspects of a security and building management system using a single database and a single user interface. All EXgarde® application modules can be set up, administered and managed from a single or multiple workstations.

Ease of integration and ease of expansion are key attributes of EXgarde® PRO providing numerous possibilities to integrate to the latest CCTV, Fire, Intrusion, Building Automation and Management, Active Directory and Biometric technologies.

EXgarde® PRO's integration pack provides the ability to enable integration with existing business systems. Using simple yet sophisticated tools, EXgarde® can exchange cardholder and event data and information in real time on a read/ write basis with any ODBC compliant human resource, Time and Attendance and/or ERP system. EXgarde® PRO can therefore provide and receive event and personnel information with building management, network management, third party security systems and Information Management systems such as Capita and Gladstone education systems.



	Express <sup>3</sup>	PRO	Enterprise
TDSi Part No.	4420-2110	4420-2090	4420-2111
Doors	50	128	Unlimited
workstations	1	2	4
Tenant	1	2	2
Event Log	Fixed 45 days	User def	User def
Keyholders	10,000	Unlimited	Unlimited
Site Plans	3	Unlimited	Unlimited
Badge Designs	2	Unlimited	Unlimited
Alarm Zones	Master Zone Only	Unlimited	Unlimited
Alarm Procedures	X	✓	✓
Counters	X	✓	✓
Netcams	X	✓	✓
Intruder	X	Option	✓
Lift Control	X	Option	✓
Biometrics	TDSi	TDSi	TDSi
Exporter	X	✓	✓
Exnotify	X	Option	✓
Control Keys	X	✓	✓
MultiCard	X	✓	✓
Guard Tour	X	Option	Option
Visitors	X	Option	✓
Integration	X	Option	✓
DVR Integration	X	Option	✓
Vugarde Integration	X	✓	✓
Zonal Anti-Passback	X	Option	✓
Active Directory	X	Option	Option
Compatible TDSi Controllers	EXcel, MICROgarde®	EXcel, EXpert, MICROgarde®	

**NOTE: S-Series controllers are not compatible with EXgarde V.4**



## EXgarde® PRO offers the following standard features and capabilities

- Intuitive windows based software
- SQL database
- Scalable solution
- Multiple workstation capable (subject to license)
- Distributed network capability
- Multi language support
- Custom reports and integration to Crystal Reports
- Central Control – all doors can be controlled from 1 place (if required)
- Event reporting – card and alarm events and basic Time and Attendance reports
- Automated and event triggered fire reporting
- Alarm management – advanced prioritised alarm handling with alarm response instructions
- Cardholder data import and export via a dedicated tool
- OPC integration facility
- Customisable Site Plan & Dynamic Graphics
- Multisite capable with PSTN, GSM, GPRS modem support
- Time scheduling – Areas, Card holder, Groups, Readers, Relays etc.
- Visual verification feature
- Programmable holidays
- Group cardholder access rights
- Manual override of doors etc
- Real-time event monitoring and logging
- Full audit trail of events, alarms and operator use
- Client/Server architecture
- Landlord/Tenant structure
- Online context sensitive help
- Automated database backup facility



### Homepage

A fully configurable Home Page allowing the user to place any commonly used items on it. This may include shortcuts to specific parts of the software, wizards or tutorials. The background of the Home Page can also be customised offering the possibility of branding it for the client.

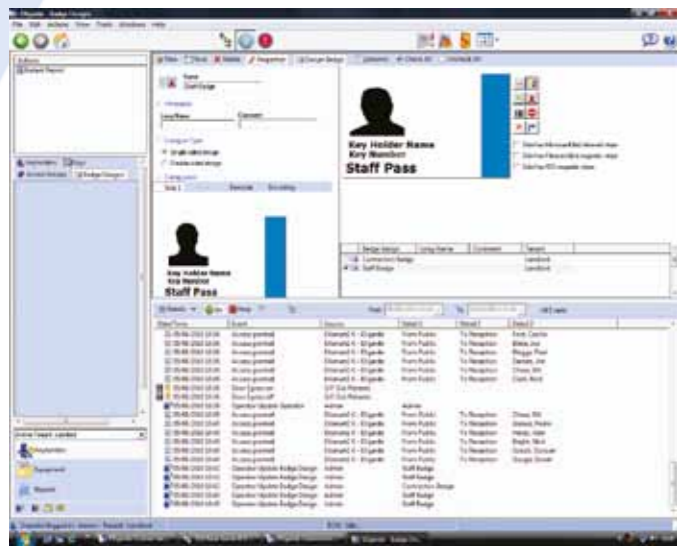

### Photo ID and Card Encoding

Design single or double-sided cards and print them directly from the software. Include graphics, database objects (such as the card holders name and photo) for a fully comprehensive solution. If required the software can also be used to encode the magnetic stripe of the card at the same time using a compatible printer with card encoding capabilities.



### Site Plans

EXgarde PRO features fully interactive site plans. Include a visual of the site, add to it any items of equipment (for example doors, cameras, inputs and relays) and operate them directly from the site plan. Check the status of items through the easy-to-understand graphics.

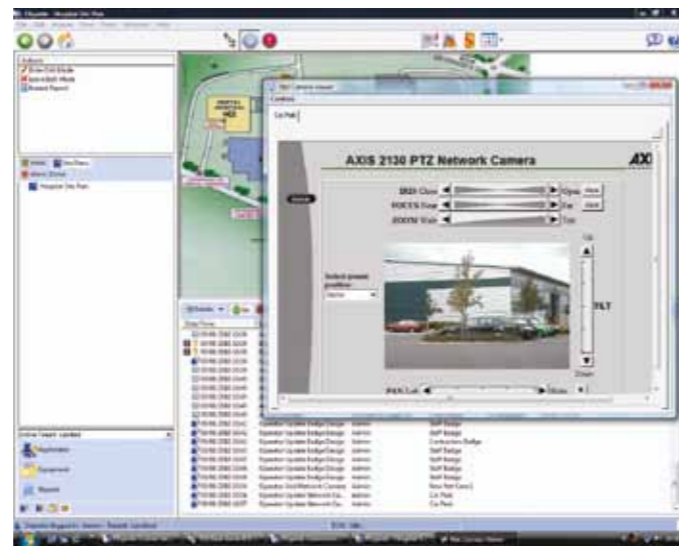

### Network Camera View

Display live camera feeds from a network camera within EXgarde PRO. Operate any PTZ features that the camera may have through the interface. Ideal for simple video identification to compare the live video to the image stored in the database.

# EXgarde

## Powerful Integration Capabilities

We are continuously improving the ability of our access control systems to integrate with complementary technologies such as biometrics, CCTV, intruder alarms, Active Directory and building management systems. This enhances the overall effectiveness of your security system and adds value to your energy efficiency and sustainability programmes.

### Flexible hardware control options for building and facilities managers

### IMMEDIATE RETURN ON INVESTMENT

EXgarde® PRO provides building and facilities managers with a wide range of hardware control functions, helping to improve the performance, and the environmental and cost efficiency of a building.

Hugely versatile, EXgarde® PRO's IO functionality is capable of full integration with most third party applications and delivering tailored solutions for individual building areas, entire buildings or across multiple-sites.



Operating on pre-set inputs, the software can control a wide range of userdefined operations, for example:

- Lighting could be activated when the first person enters, or last person leaves the building, within defined time windows, saving energy and money
  - Air conditioning - such that the system becomes operational when a given number of people are in the building or a particular part of it - again reducing wasted energy
  - CCTV - all cameras, or those in specified areas, could be initiated when certain cardholders enter defined areas, or when intruder alarms are activated
  - Car park - once a given number of vehicles are in a car park, direction signs may be initiated to divert vehicles to alternative areas
  - Fire alarm - all fire doors could be automatically opened in the event of a fire alarm being triggered
  - Biometrics - enrol and distribute users' fingerprint templates to our DIGgarde readers. Integration with other biometric readers is possible through additional modules.
- Many proprietary building management systems require a high initial cost outlay for a complete systems package, the majority of which may never be required. However, EXgarde® PRO gives complete flexibility, allowing IO functionality to be added only as and when needed.

The latest version of EXgarde software provides truly intuitive operation and powerful integration capabilities.

### Comprehensive Database Integration Pack

#### Integration Module

- Read only access to the database.
- Fusion – Script tooling enables EXgarde® to respond to changes in a third party system.
- OPC industry standard interface
- Generic API for third party applications
- SDK
- Microsoft Active Directory
  - Input users from Active Directory
  - Sync users from Active Directory
  - Lock/unlock AD account on exit/entry
  - Suspend access card on Active Directory lock

### EXtour®

EXgarde® PRO's Guard Tour module. This application provides confirmation that a tour is completed in the allotted time. It utilises the readers within the existing TDSi access control system to manage the tours of security guards.

- Use existing readers to monitor a tour
- Real time indication of early/late arrival
- Any number of tours and guards may be defined

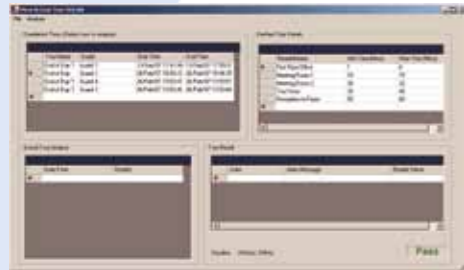

### EXnotify® - Remote notification

Provides a means of viewing selected access events and alarms while mobile.

- Notification on PDA via wireless network infrastructure
- Any events may be configured to be notified
- Can dispatch message to multiple PDA's



### Visitor management

A simple to operate application, TDSi EXvisitor provides everything you need for the management and tracking of visitors across your whole site.

With a range of innovative software features, such as the ability to disable a user's card should they enter a predefined area, site security is further enhanced, whilst a suite of reporting tools allows the movement of visitors to be fully audited.

- Assign a host to each visitor
- Real-time tracking of both the visitor and the host
- Prevents visitors from leaving the site and passing their card to another person
- Automatic check-out of visitors at a pre-defined time helps with good system management
- Visitors may be 'grouped' to allow them to be managed more effectively
- Report on visitors' movements for auditing purposes



### Lift Control

- Enable lift buttons depending upon access rights
- Control independent relays by grouping

### DVR Integration

Support for leading DVR systems from Dedicated Micros, Panasonic and Vista provide the ability to display Live Views on EXgarde® PRO Site Plans or the tagging of access, alarm and other events.

Configurable event conditions drive this capability. Override preset, PTZ on event, auto display of image on event, record on event, allows easier monitoring and playback of events. Search for access video events by card holder name for example. All the DVR integration modules are Event and Live view driven.



### SIMS Integration

The comprehensive EXgarde Database Integration Pack allows the access control system to be interfaced directly to the Capita SIMS School Information Management System.

This realises a number of distinct user benefits:

- Staff and student information need only be entered once, saving time and increasing operational efficiency
- Significantly reduce the risk of data errors that could occur when duplicating data
- Ensure that all information is consistent in both systems
- Automatically assign access rights to students or staff members



### Integrated Biometric Enrollment

TDSi DIGIgarde PLUS fingerprint, Bioscrypt and Suprema fingerprint enrollment and template distribution can be managed through these modules. All enrollment and distribution is managed through EXgarde® PRO providing a single point of enrollment for card and biometric credentials.

### Intruder Control

- Control intruder system from access cards
- Define authorized intruder operators
- Indicate occupancy status to the intruder system
- Reset occupancy when the intruder panel is reset

### Additional features of selected IP intruder panels:

- View intruder events in EXgarde® PRO
- Set/unset intruder panel from Access Events
- Set/unset by operator from EXgarde® PRO
- Enhance event action functionality (e.g. live CCTV views)



TDSi  
ACCESS EVERYWHERE

# gateway

## access to knowledge













TDSi's training programme, Gateway has been carefully designed to ensure our Authorised, Gold and Platinum installers are equipped with the knowledge and expertise they need to efficiently install, maintain and upgrade TDSi products.









	Authorised	Gold Access	CCTV	Platinum
<b>Requirements:</b>				
Length of course (days)	1	2.5	3	5
Trained Engineers Required	1	2	2	4
Minimum installs per year	1	2	2	4
<b>Course Content:</b>				
MICROgarde controllers	✓	✓		✓
EXcel controllers	✓	✓		✓
EXpert controllers	✓	✓		✓
Readers (card)	✓	✓		✓
Readers (biometrics)		✓		✓
Software toolkit	✓	✓		✓
EXgarde PRO software	✓	✓		✓
EXgarde PRO Integration		✓		✓
People Counting and Tailgating		✓		✓
VUgarde			✓	✓

Part No.	Description	Location	Cost
TRAIN-AUTH	Authorised 1 day training course	On-site	£250
TRAIN-AUTH2	Authorised 1 day training course	TDSi	FOC
TRAIN-GOLDA	Gold - Access 2.5 day training course	TDSi / on-site	FOC
TRAIN-GOLDC	Gold - CCTV 3 day training course	TDSi	FOC
TRAIN-PLAT	Platinum 5-day training course	TDSi only	FOC
TRAIN-INT	Integration training at TDSi	TDSi only	£550
TRAIN-END	End user training	TDSi / on-site	£850
TRAIN-SPEC	Specialised/modular training course	TDSi / on-site	£550



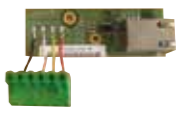



























# product list

Description	Part Number		Page
<b>EXGARDE PC BASED ACCESS CONTROL SOFTWARE</b>			
<b>EXgarde Software</b> EXgarde Express EXgarde PRO EXgarde Enterprise EXgarde Version Upgrade	4420-2110 4420-2090 4420-2111 4420-2092		p.18
<b>EXgarde PRO Options</b> Add 1 PC Workstations to EXgarde PRO Software Add 2 PC Workstations to EXgarde PRO Software Add 4 PC Workstations to EXgarde PRO Software Unlimited Doors - Unlimited Door Support for EXgarde PRO Additional Tenant - Adds an Extra Tenant to EXgarde PRO	4420-2104 4420-2100 4420-2101 4420-2102 4420-2103		p.18
<b>DVR Support</b> Exgarde PRO Integration for Baxall MDR/Vista Triplex2 Columbus DVRs Exgarde PRO Integration for Panasonic HDR 300 DVR Exgarde PRO Integration for Bosch DVR (Matrix Functionality Only) Exgarde PRO Integration for Dedicated Micros Digital Sprite 2 - NetVu connected	4420-2200 4420-2201 4420-2202 4420-2203		p.21
<b>Biometrics</b> Panasonic BM ET 200/300/330 Reader Integration Bioscrypt V-Series Reader Integration Suprema BioEntry Plus/BioLite Net/BioStation Reader Integration	4420-2300 4420-2301 4420-2304		p.21
<b>Additional Applications</b> EXtour® - Scheduled Guard Tour Module Using TDSi Readers EXvisitor Visitor Management Module Software Integration Module - Fusion / OPC / API (Includes 0.5 Days Telephone Support) EXnotify® - Alarm and Event Forwarding to PDA, SMS and E-mail	4420-2400 4420-2401 4420-2402 4420-2403		p.21
<b>External Control</b> Lift Control - Advanced Lift Control Module Intruder Control Module	4420-2500 4420-2501		p.21
<b>STARTER KITS</b>			
SOLogarde Starter Kit - Controller, Reader and 25 cards	5002-4002		p.4
MICROgarde® I Starter Kit - 1 EXprox Reader, 10 Cards, Comms lead and PC Software	5002-1910		p.6
EXpack <sup>2</sup> Starter Kit - EXcel <sup>2</sup> , 2 EXprox Readers and 50 Cards	5002-1476		p.8
EXpack <sup>4</sup> Starter Kit - EXcel <sup>4</sup> , 4 EXprox Readers and 50 Cards	5002-1480		p.8

Description	Part Number		Page
<b>CONTROLLERS</b>			
SOLogarde Controller SOLogarde Programmer	5002-4000 5002-4001		p.4
MICROgarde® I Controller, 1 Door Controller MICROgarde® II Controller, 2 Door Controller	5002-1900 5002-1800		p.6
MICROgarde® I IP, 1 Door Controller with LAN/WAN Connectivity MICROgarde® II IP, 2 Door Controller with LAN/WAN Connectivity	5002-1901 5002-1801		p.6
MICROgarde® I Controller with 3A PSU MICROgarde® II Controller with 3A PSU MICROgarde I IP, 1 Door Controller with 3A PSU MICROgarde II IP, 2 Door Controller with 3A PSU	5002-1906 5002-1806 5002-1907 5002-1807		p.6
MICROgarde® Input/Output Module	5002-1811		p.6
MICROgarde® TCP/IP Module	5002-1812		p.7
MICROgarde® RS-232 Comms Lead	5002-1813		p.7
<b>EX SERIES - MID/HIGH END SYSTEM</b>			
EXcel <sup>2</sup> - 2 Reader, 1 or 2 Door Controller with 4A PSU EXcel <sup>4</sup> - 4 Reader, 1 to 4 Door Controller with 4A PSU & TCP/IP	5002-3082 5002-3092		p.8
EXpert <sup>2</sup> - 2 Reader, 1 or 2 Door Master Controller with 4A PSU EXpert <sup>2</sup> IP - 2 Reader, 1 or 2 Door Master Controller with 4A PSU and TCP/IP EXpert <sup>4</sup> - 4 Reader, 1 to 4 Door Master Controller with 4A PSU EXpert <sup>4</sup> IP - 4 Reader, 1 to 4 Door Master Controller with 4A PSU and TCP/IP	5002-3002 5002-3012 5002-3022 5002-3032		p.10
EXpert <sup>2</sup> Slave - 2 Reader, 1 or 2 Door Slave Controller with 4A PSU	5002-3042		p.10



Description	Part Number		Page
<b>EXpert Additions</b>			
EXpander <sup>2</sup> - 2 Reader, 1 or 2 Door Expansion Module for EXpert Controllers	5002-3063		p.10
EX in/out - 32 Input / 16 Output Expansion Module for EXpert Controllers EXout - 32 Kit	5002-3060 5002-3062		p.10
EXkeypad - Stand Alone Programmer for EXpert Master Controllers	5002-2070		p.10
<b>READERS</b>			
<b>Proximity</b>			
EXprox Proximity Mullion Reader Ivory and Graphite Covers Included	5002-0354		p.14
EXprox VR Proximity Mullion Reader in Stainless Steel Housing	5002-0355		p.14
EXprox <sup>2</sup>	5002-0395		p.14
EXprox <sup>2</sup> K	5002-0396		p.14
Optica Proximity Reader with Keypad	5002-0390		p.14
Optica VR Stainless Steel Proximity Reader with Keypad	5002-0391		p.14
Dual Technology Desktop Enrolment Reader with USB Connection	5002-0449		p.15
Panel Mount Proximity Reader for Entry Panel or Electrical Box Mounting	5002-0430		p.14
<b>MIFARE®</b>			
TDSi MIFARE® Serial Number Reader TDSi MIFARE® Sector 4 Reader SOLOgarde Reader	5002-0440 5002-0441 5002-4003		p.14
EXsmart <sup>2</sup> MIFARE® Serial Number Reader Pattress Box Mounting EXsmart <sup>2</sup> MIFARE® Sector 4 Reader Pattress Box Mounting EXsmart <sup>2</sup> MIFARE® Sector 9 Reader Pattress Box Mounting EXsmart <sup>2</sup> K MIFARE® Serial Number Reader with Keypad Pattress Box Mounting EXsmart <sup>2</sup> K MIFARE® Sector 4 Reader with keypad Pattress Box Mounting EXsmart <sup>2</sup> K MIFARE® Sector 9 Reader Keypad with Keypad Pattress Box Mounting	5002-0435 5002-0437 5002-0433 5002-0436 5002-0438 5002-0434		p.14
Dual Technology Desktop Enrolment Reader with USB Connection	5002-0449		p.15
MIFARE® Card Programming Station MIFARE® Card and Reader Programming Station (use with 5002-0441 readers) Desktop reader/writer unit	5002-5010 5002-5011 2920-0232		p.15
Energy Saving Switch - MIFARE Energy Saving Switch - Proximity	5002-0421 5002-0420		p.15

Description	Part Number		Page
<b>Infra Red (Microcard)</b>			
Infra Red Swipe Reader (not compatible with EXcel <sup>4</sup> or MICROgarde)	5002-0035		p.15
Long Range RF Fob Long Range RF Fob with Proximity Tag Long Range RF Receiver - Compatible with RF Fobs	5012-0210 5012-0211 5012-0200		p.15
Infra Red Swipe Reader with Keypad (not compatible with EXcel <sup>4</sup> or MICROgarde®)	5002-0258		p.15
Digital Infra Red Reader	5002-1781		p.15
Digital Infra Red Reader with Keypad	5002-0315		p.15
<b>Biometric</b>			
DIGIgarde PLUS Fingerprint Reader (Fingerprint, MIFARE Card and PIN)	5002-0455		p.16
Desktop USB Fingerprint Enrolment Reader - compatible with EXgarde	2920-4030		p.16
Desktop Reader/Writer Unit	2920-0232		p.16
Facial Recognition Reader	5012-0080		p.16
<b>CARDS/TOKENS</b>			
<b>Proximity</b>			
TDSi Proximity Card	4262-0245		p.14
TDSi Proximity Card with HICO Magnetic Stripe (Not Encoded)	4262-0247		p.14
TDSi Proximity Keyfob	4262-0246		p.14





### TDSi UK

Unit 10 Concept Park  
Innovation Close  
Poole  
Dorset  
BH12 4QT  
United Kingdom

t: +44 (0)1202 723535  
support: +44 (0)1202 724998  
f: +44 (0)1202 724975  
e: sales@tdsi.co.uk

### TDSi France

Immeuble ATRIA  
2 rue du Centre  
93160 NOISY LE GRAND  
France

t: +33 (0)1 58 84 20 90  
f: +33 (0)1 58 84 20 91  
e: tdsif@wanadoo.fr

### TDSi China

Rm 103, 1 Bld  
Shangsha Innovation Science & Technology Park  
9283 Binhai Road, Futian District  
Shenzhen 518048, P.R.China

t: 86-755-82535725, 82535720  
f: 86-755-82535770  
e: tdsiinfo@microgarde.com.cn

For further information on our  
products and services visit:

[www.tdsi.co.uk](http://www.tdsi.co.uk)

