

# EIKI

MULTIMEDIA PROJECTOR

## MODEL LC-VC1

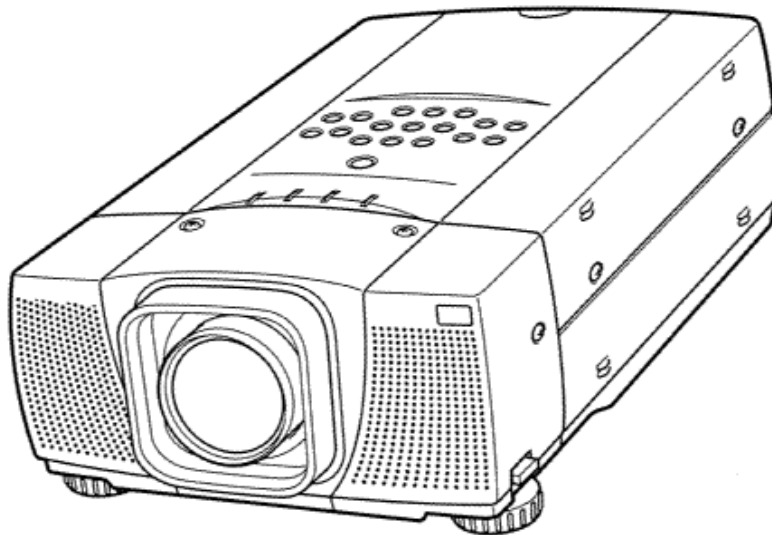

## OWNER'S MANUAL

## TO THE OWNER

Before operating this projector, read this manual thoroughly and operate the projector properly.

This projector provides many convenient features and functions. Operating the projector properly enables you to manage those features and maintains it in better condition for a considerable time.

Improper operation may result in not only shortening the product-life, but also malfunctions, fire hazard, or other accidents. If your projector seems to operate improperly, read this manual again, check operations and cable connections and try the solutions in the "Trouble-shooting" section of the end of this booklet. If the problem still persists, contact the sales dealer where you purchased the projector or the service center.



### SAFETY PRECAUTIONS

**WARNING: TO REDUCE THE RISK OF FIRE OR ELECTRIC SHOCK, DO NOT EXPOSE THIS APPLIANCE TO RAIN OR MOISTURE.**

- This projector produces intense light from the projection lens. Do not stare directly into the lens as possible.

Eye damage could result. Be especially careful that children do not stare directly into the beam.

- This projector should be set in the way indicated. If not, it may result in a fire hazard.

- Take appropriate space on the top, sides and rear of the projector cabinet for allowing air circulation and cooling the projector. Minimum distance should be taken. If the projector is to be built into a compartment or similarly enclosed, the minimum distances must be maintained. Do not cover the ventilation slot on the projector. Heat build-up can reduce the service life of your projector, and can also be dangerous.

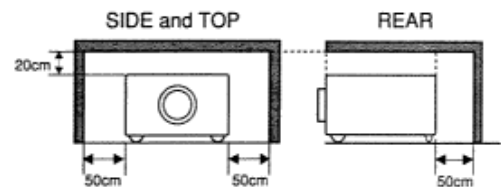

- Do not put any flammable object or spray can near the projector, hot air is exhausted from the ventilation holes.
- If the projector is not to be used for an extended time, unplug the projector from the power outlet.

**READ AND KEEP THIS OWNER'S MANUAL FOR LATER USE.**

	<b>CAUTION</b> <b>RISK OF ELECTRIC SHOCK</b> <b>DO NOT OPEN</b>	
<b>CAUTION : TO REDUCE THE RISK OF ELECTRIC SHOCK, DO NOT REMOVE COVER (OR BACK). NO USER-SERVICEABLE PARTS INSIDE EXCEPT LAMP REPLACEMENT. REFER SERVICING TO QUALIFIED SERVICE PERSONNEL.</b>		
	THIS SYMBOL INDICATES THAT DANGEROUS VOLTAGE CONSTITUTING A RISK OF ELECTRIC SHOCK IS PRESENT WITHIN THIS UNIT.	
		THIS SYMBOL INDICATES THAT THERE ARE IMPORTANT OPERATING AND MAINTENANCE INSTRUCTIONS IN THE OWNER'S MANUAL WITH THIS UNIT.

# SAFETY INSTRUCTIONS

All the safety and operating instructions should be read before the product is operated.

Read all of the instructions given here and retain them for later use. Unplug this projector from AC power supply before cleaning. Do not use liquid or aerosol cleaners. Use a damp cloth for cleaning.

Follow all warnings and instructions marked on the projector.

For added protection to the projector during a lightning storm, or when it is left unattended and unused for long periods of time, unplug it from the wall outlet. This will prevent damage due to lightning and power line surges.

---

Do not expose this unit to rain or use near water... for example, in a wet basement, near a swimming pool, etc...

Do not use attachments not recommended by the manufacturer as they may cause hazards.

Do not place this projector on an unstable cart, stand, or table. The projector may fall, causing serious injury to a child or adult, and serious damage to the projector. Use only with a cart or stand recommended by the manufacturer, or sold with the projector. Wall or shelf mounting should follow the manufacturer's instructions, and should use a mounting kit approved by the manufacturers.

An appliance and cart combination should be moved with care. Quick stops, excessive force, and uneven surfaces may cause the appliance and cart combination to overturn.



---

Slots and openings in the back and bottom of the cabinet are provided for ventilation, to insure reliable operation of the equipment and to protect it from overheating.

The openings should never be covered with cloth or other materials, and the bottom opening should not be blocked by placing the projector on a bed, sofa, rug, or other similar surface. This projector should never be placed near or over a radiator or heat register.

This projector should not be placed in a built-in installation such as a book case unless proper ventilation is provided.

Never push objects of any kind into this projector through

cabinet slots as they may touch dangerous voltage points or short out parts that could result in a fire or electric shock. Never spill liquid of any kind on the projector.

This projector should be operated only from the type of power source indicated on the marking label. If you are not sure of the type of power supplied, consult your authorized dealer or local power company.

Do not overload wall outlets and extension cords as this can result in fire or electric shock. Do not allow anything to rest on the power cord. Do not locate this projector where the cord may be damaged by persons walking on it.

Do not attempt to service this projector yourself as opening or removing covers may expose you to dangerous voltage or other hazards. Refer all servicing to qualified service personnel.

Unplug this projector from wall outlet and refer servicing to qualified service personnel under the following conditions:

- a. When the power cord or plug is damaged or frayed.
- b. If liquid has been spilled into the projector.
- c. If the projector has been exposed to rain or water.
- d. If the projector does not operate normally by following the operating instructions. Adjust only those controls that are covered by the operating instructions as improper adjustment of other controls may result in damage and will often require extensive work by a qualified technician to restore the projector to normal operation.
- e. If the projector has been dropped or the cabinet has been damaged.
- f. When the projector exhibits a distinct change in performance-this indicates a need for service.

When replacement parts are required, be sure the service technician has used replacement parts specified by the manufacturer that have the same characteristics as the original part. Unauthorized substitutions may result in fire, electric shock, or injury to persons.

Upon completion of any service or repairs to this projector, ask the service technician to perform routine safety checks to determine that the projector is in safe operating condition.

## Voor de klanten in Nederland



Bij dit product zijn batterijen geleverd. Wanneer deze leeg zijn, moet u ze niet weggooien maar inleveren als KCA.

# COMPLIANCES

## **Federal Communication Commission Notice**

This equipment has been tested and found to comply with the limits for a Class A digital device, pursuant to Part 15 of FCC Rules. These limits are designed to provide reasonable protection against harmful interference when the equipment is operated in a commercial environment. This equipment generates, uses, and can radiate radio frequency energy and, if not installed and used in accordance with the instruction manual, may cause harmful interference to radio communications. Operation of this equipment in a residential area is likely to cause harmful interference in which case the user will be required to correct the interference at his own expense.

## **AC POWER CORD REQUIREMENT**

The AC Power Cord supplied with this projector meets the requirement for use in the country you purchased it.

### **AC Power Cord for the United States and Canada:**

AC Power Cord used in the United States and Canada is listed by the Underwriters Laboratories (UL) and certified by the Canadian Standard Association (CSA).  
AC Power Cord has a grounding-type AC line plug. This is a safety feature to be sure that the plug will fit into the power outlet. Do not try to defeat this safety feature.  
Should you be unable to insert the plug into the outlet, contact your electrician.

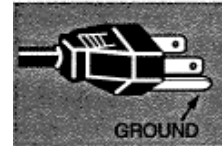

---

THE SOCKET-OUTLET SHOULD BE INSTALLED NEAR THE EQUIPMENT AND EASILY ACCESSIBLE.

# TABLE OF CONTENTS

<b>FEATURES AND DESIGN</b>	<b>6</b>	SOUND ADJUSTMENT	22
		VOLUME ADJUSTMENT	22
		MUTE SETTING	22
<b>PREPARATION</b>	<b>7</b>	<b>COMPUTER MODE</b>	<b>23</b>
NAME OF EACH PART OF PROJECTOR	7	SELECTING INPUT SOURCE	23
SETTING-UP PROJECTOR	8	SELECTING COMPUTER SYSTEM	23
CONNECTING AC POWER CORD	8	PC ADJUSTMENT	24
POSITIONING PROJECTOR	9	AUTO PC ADJUSTMENT	24
ADJUSTABLE FEET	10	MANUAL PC ADJUSTMENT	25
MOVING PROJECTOR	10	COMPATIBLE COMPUTER SPECIFICATIONS	27
		PICTURE IMAGE ADJUSTMENT	28
		IMAGE LEVEL SELECT	28
		IMAGE LEVEL ADJUSTMENT	29
		PICTURE SCREEN ADJUSTMENT	30
<b>CONNECTING PROJECTOR</b>	<b>11</b>	<b>VIDEO MODE</b>	<b>31</b>
TERMINALS OF PROJECTOR	11	SELECTING INPUT SOURCE	31
CONNECTING TO VIDEO EQUIPMENT	12	SELECTING VIDEO SYSTEM	32
CONNECTING TO COMPUTER	13	PICTURE IMAGE ADJUSTMENT	33
		IMAGE LEVEL SELECT	33
		IMAGE LEVEL ADJUSTMENT	34
		PICTURE SCREEN ADJUSTMENT	35
<b>BEFORE OPERATION</b>	<b>14</b>	<b>SETTING</b>	<b>36</b>
TOP CONTROLS AND INDICATORS	14	SETTING MENU	36
OPERATION OF REMOTE CONTROL	16		
OPERATING RANGE	16		
WIRED REMOTE CONTROL OPERATION	17		
REMOTE CONTROL BATTERIES INSTALLATION	17		
OPERATING ON-SCREEN MENU	18		
HOW TO OPERATE ON-SCREEN MENU	18		
FLOW OF ON-SCREEN MENU OPERATION	18		
MENU BAR	19		
<b>BASIC OPERATION</b>	<b>20</b>	<b>APPENDIX</b>	<b>38</b>
TURNING ON / OFF PROJECTOR	20	MAINTENANCE	38
ADJUSTING SCREEN	21	WARNING TEMP. INDICATOR	38
ZOOM ADJUSTMENT	21	AIR FILTER CARE AND CLEANING	38
FOCUS ADJUSTMENT	21	CLEANING THE PROJECTION LENS	38
LENS SHIFT ADJUSTMENT	21	LAMP REPLACEMENT	39
KEystone ADJUSTMENT	21	LAMP REPLACE COUNTER	39
NO SHOW FUNCTION	22	TROUBLESHOOTING	40
PICTURE FREEZE FUNCTION	22	TECHNICAL SPECIFICATIONS	42

## TRADEMARKS

- Apple, Macintosh, and PowerBook are trademarks or registered trademarks of Apple Computer, Inc.
- IBM and PS/2 are trademarks or registered trademarks of International Business Machines, Inc.
- Windows and PowerPoint are registered trademarks of Microsoft Corporation.
- Each name of corporations or products in the owner's manual is a trademark or a registered trademark of its respective corporation.

# FEATURES AND DESIGN

This Multimedia Projector is designed with the most advanced technology for portability, durability, and ease of use. The projector utilizes built-in multimedia features, a palette of 16.77 million colors, and matrix liquid crystal display (LCD) technology.

## • **Compatibility**

---

This projector widely accepts various video and computer input signals including;

- **6 Color Systems**  
NTSC, PAL, SECAM, NTSC 4.43, PAL-M or PAL-N color system can be connected.
- **Component Video**  
Component video signals, such as a DVD player output high definition TV signals including 480i, 480p, 575i, 575p, 720p, 1080i, 1080i-50 or 1080i-60, can be connected.
- **S-Video**  
S-Video signals, such as a S-VHS VCR output signals, can be connected.
- **Computers**  
IBM-compatible and Macintosh computers up to 1280 x 1024 resolution.

## • **High Resolution Image**

---

This projector provides 1366 x 768 dots resolution for computer input and 800 horizontal TV lines. The resolution from computer between XGA (1024 x 768) and SXGA (1280 x 1024) is compressed into 1024 x 768 dots. This projector cannot display image of over 1280 x 1024 dots. When the resolution of your computer is over than 1280 x 1024, reset computer output for lower resolution.

## • **Multi-Scan System**

---

This projector has Multi-Scan System to conform to almost all computer output signals quickly. There is no need for complicated manual adjustment of frequency and other settings.

## • **One-Touch Auto PC Adjustment**

---

Incoming computer video signals are recognized and the best adjustment is automatically set by Auto PC Adjustment. No complicated setup is necessary and projection is always precise.

## • **Progressive Scan (for Video)**

---

Progressive Scan function converts interlace video signals into progressive scan signals and provide fine picture quality.

## • **Digital Zoom (for Computer)**

---

Digital Zoom function magnifies the image up to 16 times, allowing you to focus on crucial information at a presentation.

## • **Motor-driven Lens Shift**

---

Projection Lens can be moved up and down with Motor-driven Lens Shift function. This function makes it easy to provide projected image where you want. Zoom and Focus can be also adjusted with Motor-driven operation.

## • **Keystone Correction**

---

Positioning height of projector may result in distorted images being displayed in a trapezoid shape. Keystone Correction solves this problem by digitally altering projection to produce undistorted images.

## • **Power Management**

---

Power Management function is provided to reduce power consumption while the projector is not in use. This Power Management function operates to turn Projection Lamp off when the projector detects signal interruption and any button is not pressed over 5 minutes. Projection Lamp is automatically turned on again when the projector detects the signal or any operation button is pressed. This projector is shipped with this function ON.

## • **Multilanguage Menu Display**

---

Operation menu is displayed in; English, German, French, Italian, Spanish, Portuguese, Dutch, Swedish or Japanese.

# NAME OF EACH PART OF PROJECTOR

## FRONT

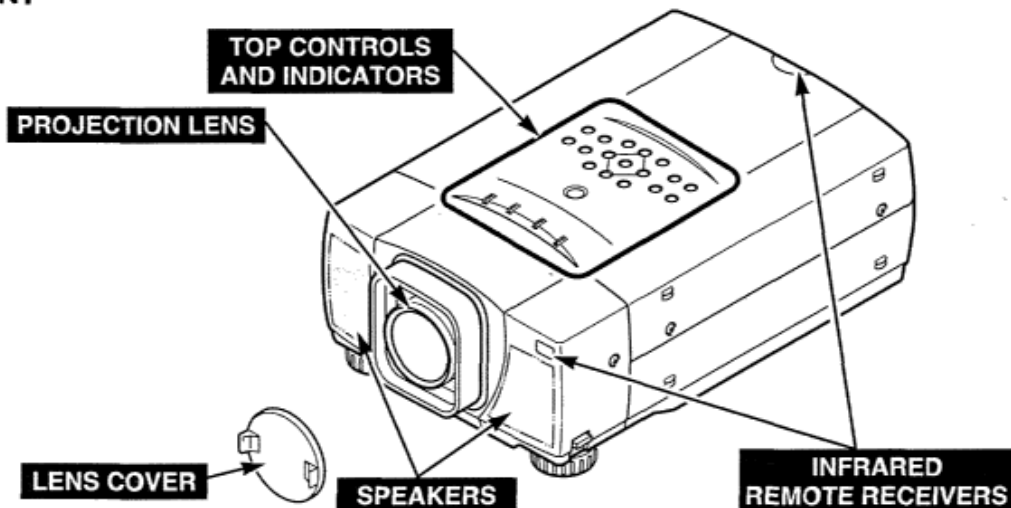

## BACK

### EXHAUST VENTS



### HOT AIR EXHAUSTED !

Air blown from Exhaust Vents is hot. When using or installing projector, the following precautions should be taken.

- Do not put any flammable object near these vents.
- Keep the rear grills at least 3'(1m) away from any object, especially heat-sensitive object.
- Do not touch this area, especially screws and metallic parts. This area will become hot while projector is used.

This projector detects internal temperature and automatically controls operating power of Cooling Fans.

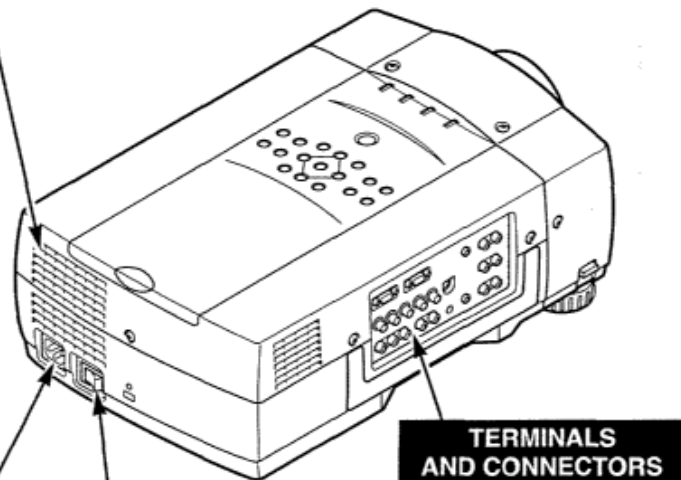

## BOTTOM

### AIR INTAKE VENTS (Side and Bottom)

This projector is equipped with Cooling Fans for protection from overheating. Pay attention to the following to ensure proper ventilation and avoid a possible risk of fire and malfunction.

- Do not cover vent slots.
- Keep bottom clear of any object. Obstructions may block cooling air.

### LAMP COVER

### ADJUSTABLE FEET AND FEET LOCK LATCHES

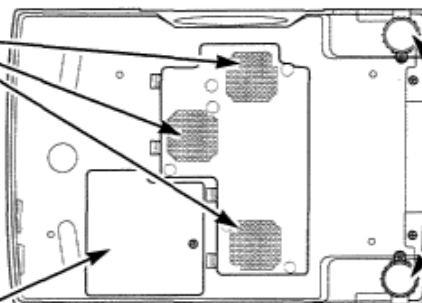

# SETTING-UP PROJECTOR

## PREPARATION

This projector uses nominal input voltages of 100-120 V or 200-240 V AC. The projector automatically selects the correct input voltage. It is designed to work with single-phase power systems having a grounded neutral conductor. To reduce the risk of electrical shock, do not plug into any other type of power system. Consult your authorized dealer or service station if you are not sure of the type of power supply being in use. Connect projector with the peripheral equipment before turning projector on. (Refer to pages 11 - 13 for connection.)

## CONNECTING AC POWER CORD

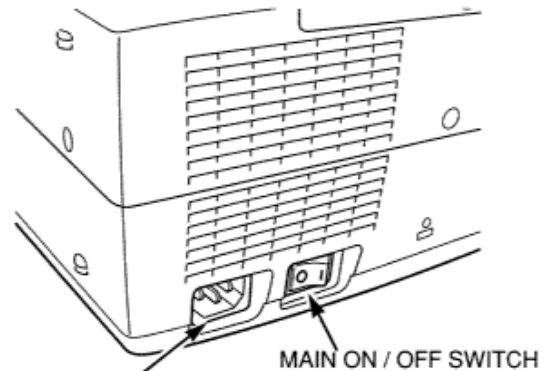

Connect AC Power Cord (supplied) to projector.  
The AC outlet must be near this equipment and must be easily accessible.



### CAUTION

For safety, unplug the AC Power Cord when the appliance is not used.

### NOTE ON THE POWER CORD

The AC Power Cord must meet the requirement of the country where you use the projector. Confirm the AC plug type with the chart below. The proper AC power cord must be used. If the supplied AC Power Cord does not match the AC outlet, contact your sales dealer.

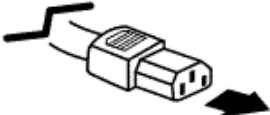
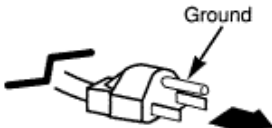
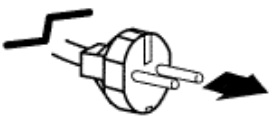
Projector side	AC Outlet side	
 <p data-bbox="375 1377 581 1444">To the POWER CORD CONNECTOR on the projector.</p>	<p data-bbox="651 1188 938 1213">For the U.S.A. and Canada</p>  <p data-bbox="773 1381 932 1432">To the AC Outlet. (120 V AC)</p>	<p data-bbox="1008 1188 1295 1213">For Continental Europe</p>  <p data-bbox="1130 1402 1305 1453">To the AC Outlet. (200 - 240 V AC)</p>



## ADJUSTABLE FEET

### POSITIONING THE PROJECTOR

This projector is designed to project on a flat projection surface and it can be focused from 4.43' (1.35m) 45.9' (14.0m). Refer to the figure below to adjust the screen size.

#### RECOMMENDATION

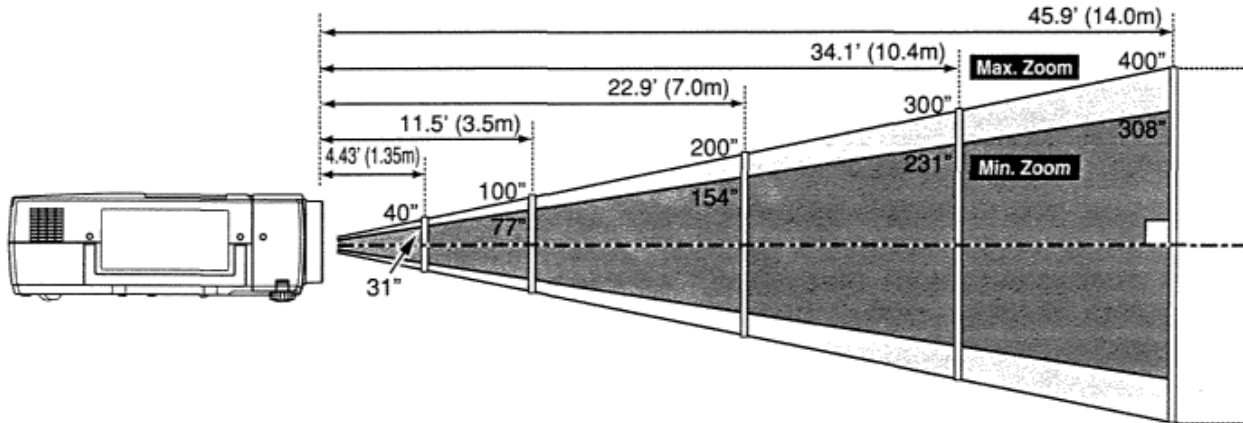

Screen Size	40"	100"	200"	300"	400"
Width x Height	886 x 498 mm	2215 x 1245 mm	4430 x 2490 mm	6644 x 3736 mm	8860 x 4980 mm

Brightness in the room has a great influence on picture quality. It is recommended to limit ambient lighting in order to provide the best image.

#### LENS SHIFT ADJUSTMENT

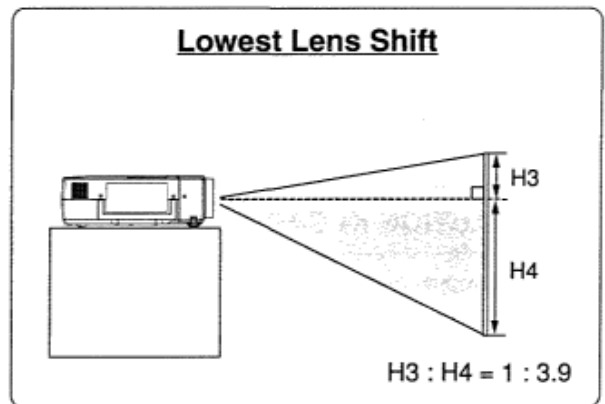
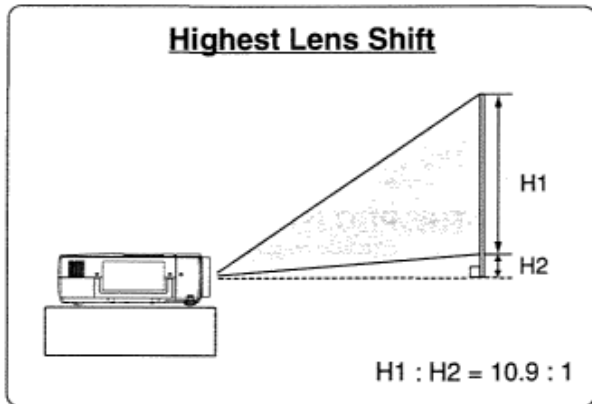

Projection Lens can be moved up and down with Motor-driven Lens Shift function. This function makes it easy to provide the projected image where you want. Refer to P 21 for operation

#### **NOTE**

Screen size and lens shift ratio on the above charts are standard values and they may change by positioning conditions.

## ADJUSTABLE FEET

Picture tilt and projection angle can be adjusted by rotating Adjustable Feet. Projection angle can be adjusted to 9.0 degrees.

- 1** Lift the front of projector and pull Feet Lock Latches on both sides of projector.
- 2** Release Feet Lock Latches to lock Adjustable Feet and rotate Adjustable Feet to fine tune position and tilt.
- 3** To shorten Adjustable Feet, lift the front of projector and pull and undo Feet Lock Latches.

Position and keystone distortion of the image can be adjusted using Menu Operation. (Refer to P 21 and 36.)

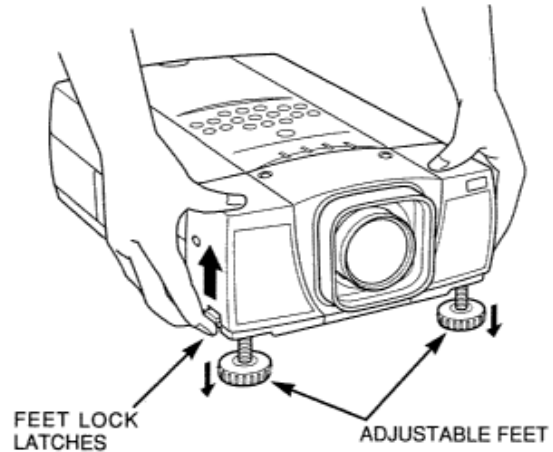

## MOVING PROJECTOR

Use Carry Handle when moving projector. When moving projector, replace Lens Cover and retract Adjustable Feet to prevent damage to Projection Lens and cabinet. When this projector is not in use for an extended period, put it into the case (Dust Cover) supplied with this projector.



### CAUTION IN CARRYING OR TRANSPORTING THE PROJECTOR

- Do not bump projector, otherwise damages or malfunctions may result
- When carrying projector, use a suitable carrying case
- Do not transport projector by using a courier or transport service in an unsuitable transport case. This may cause damage to projector. To transport projector through a courier or transport service, consult your dealer for best way.

# TERMINALS OF PROJECTOR

This projector has INPUT TERMINALS and OUTPUT TERMINALS on its side for connecting computers and video equipment. Refer to the figure on pages 11 to 13 and connect properly.

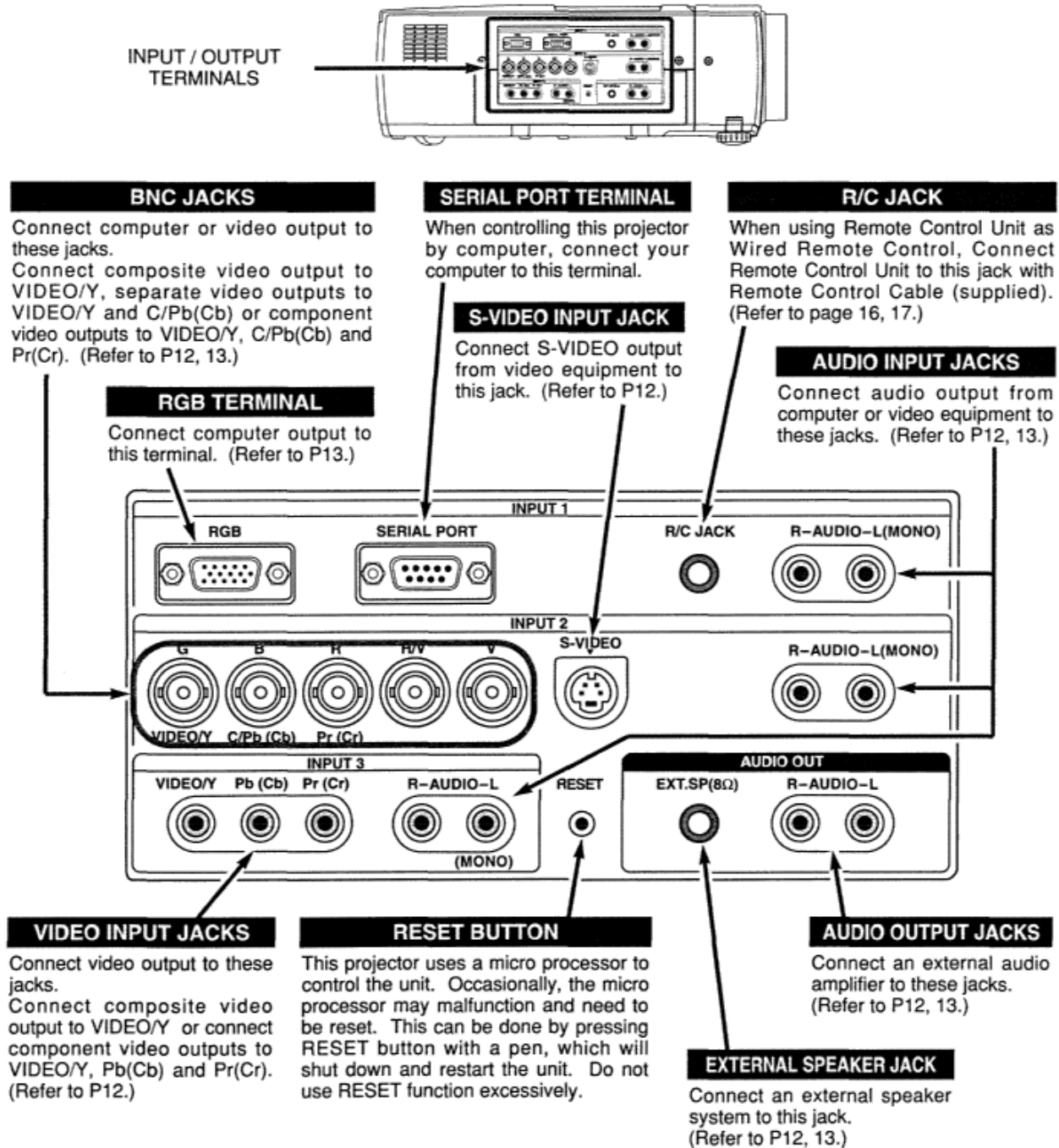

# CONNECTING TO VIDEO EQUIPMENT

**Cables used for connection** (\* -Cables are not supplied with this projector.)

- Video Cable (RCA x 1)
- Video Cable (RCA x 3)\*, (BNC x 1)\*, (BNC x 2)\* or (BNC x 3)\*
- S-VIDEO Cable
- Audio Cable (RCA x 2)
- Speaker Cable (Mini x 1 (stereo))\*



**NOTE :**  
When connecting projector, AC Power Cords of both projector and external equipment should be disconnected from AC outlet.

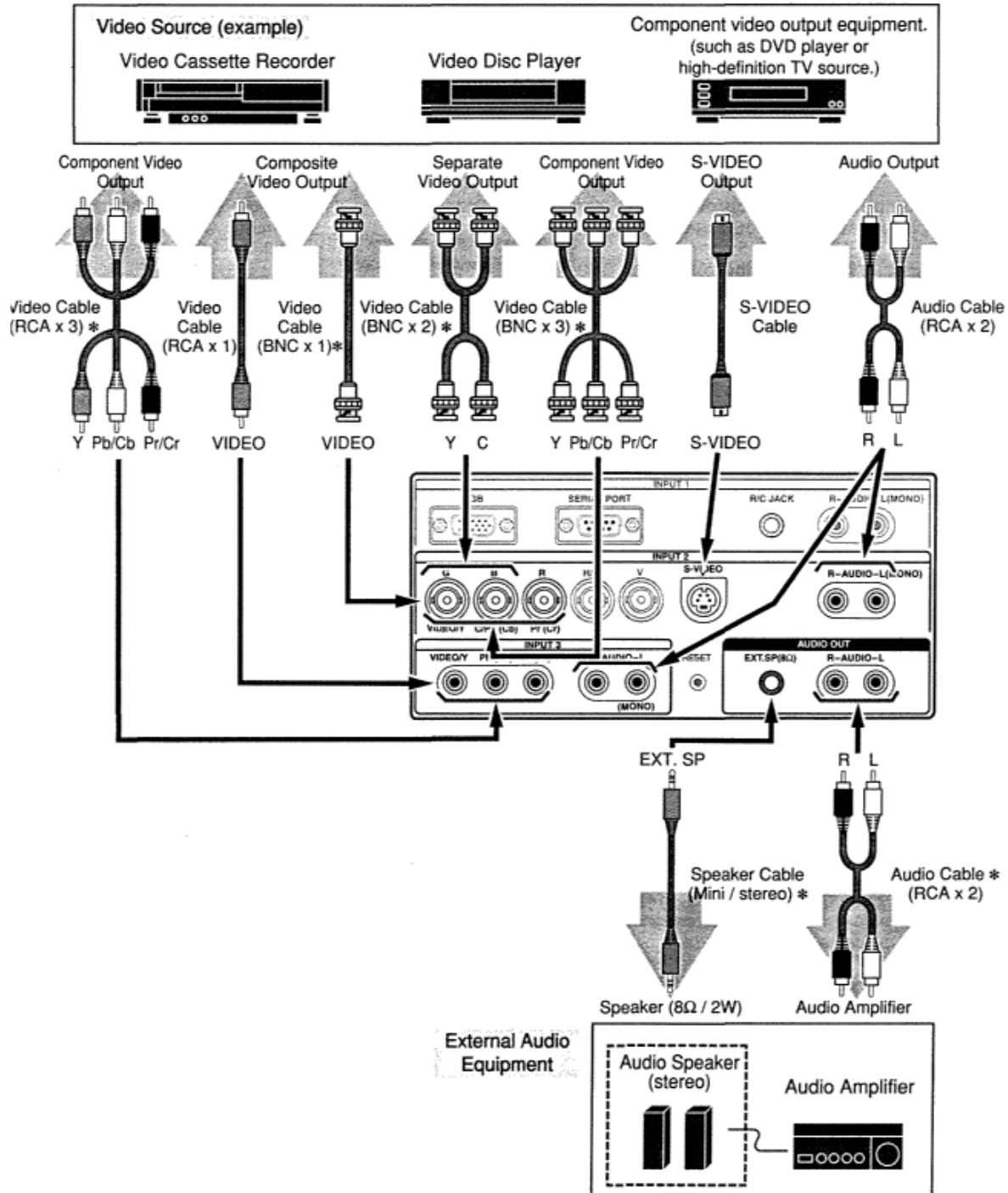

# CONNECTING TO COMPUTER

**Cables used for connection** (\* - Cables are not supplied with this projector.)

- VGA Cable (HDB 15 pin) \*
- Video Cable (BNC x 5) \*
- MAC Adapter (in the case of connecting Macintosh computer) \*
- Audio Cables (RCA x 2) or (RCA x 1 - Mini Plug (mono)) \*
- Speaker Cable (Mini Plug (stereo)) \*



**NOTE :**

When connecting the cable, AC Power Cords of both projector and external equipment should be disconnected from AC outlet. Turn projector and peripheral equipment on before your computer is switched on.

**IBM-compatible computers or Macintosh computers (VGA / SVGA / XGA / SXGA)**



Desktop type



Laptop type

**Monitor Output**

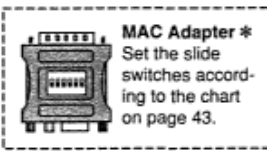

VGA Cable

Use either RGB Terminal or G, B, R, H/V and V jacks.

**Monitor Output**

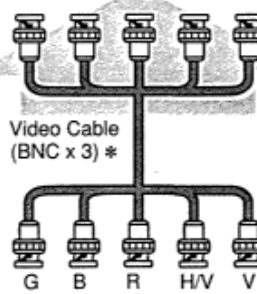

Video Cable (BNC x 3) \*

**Audio Output**

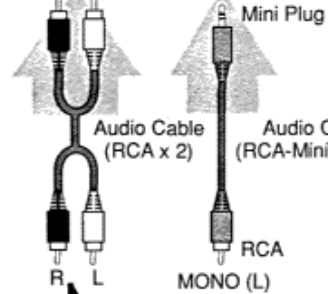

Audio Cable (RCA x 2)

Audio Cable (RCA-Mini Plug) \*

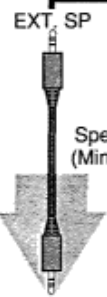
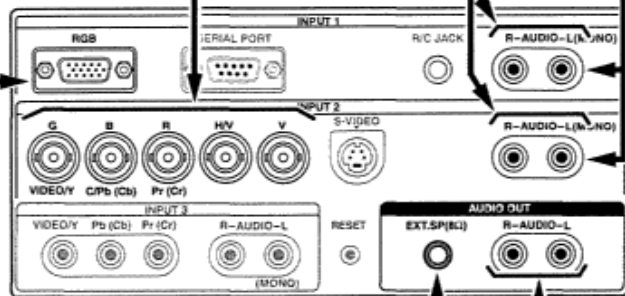

Speaker Cable (Mini / stereo) \*

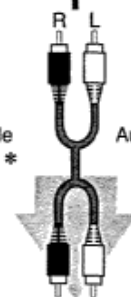

Audio Cable \* (RCA x 2)

**External Audio Equipment**

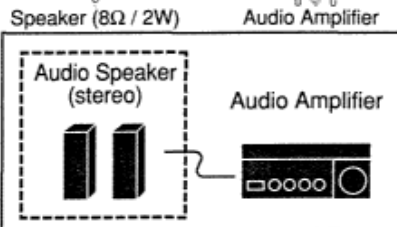

Speaker (8Ω / 2W)

Audio Amplifier

# TOP CONTROLS AND INDICATORS

This projector has CONTROL BUTTONS (TOP CONTROLS) and INDICATORS on its top.

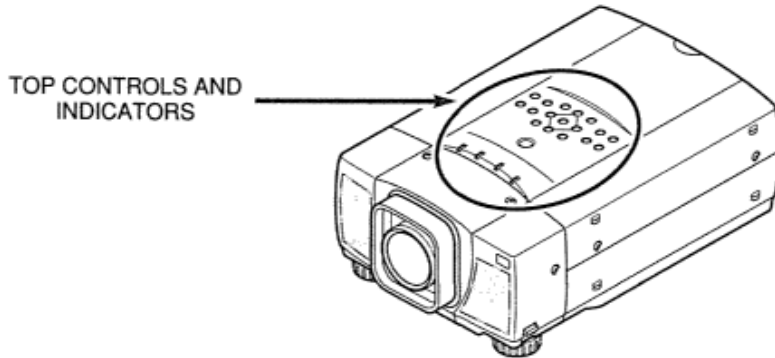

## LAMP REPLACE INDICATOR

This indicator turns to yellow when the life of Projection Lamp draws to an end. (P39)

## WARNING TEMP. INDICATOR

This indicator flashes red when internal projector temperature is too high. (P38)

## READY INDICATOR

This indicator lights green when projector is ready to be turned on. And it flashes green in Power Management mode. (P37)

## LAMP INDICATOR

This indicator is dim when projector is turned on. And bright when projector is in stand-by mode.

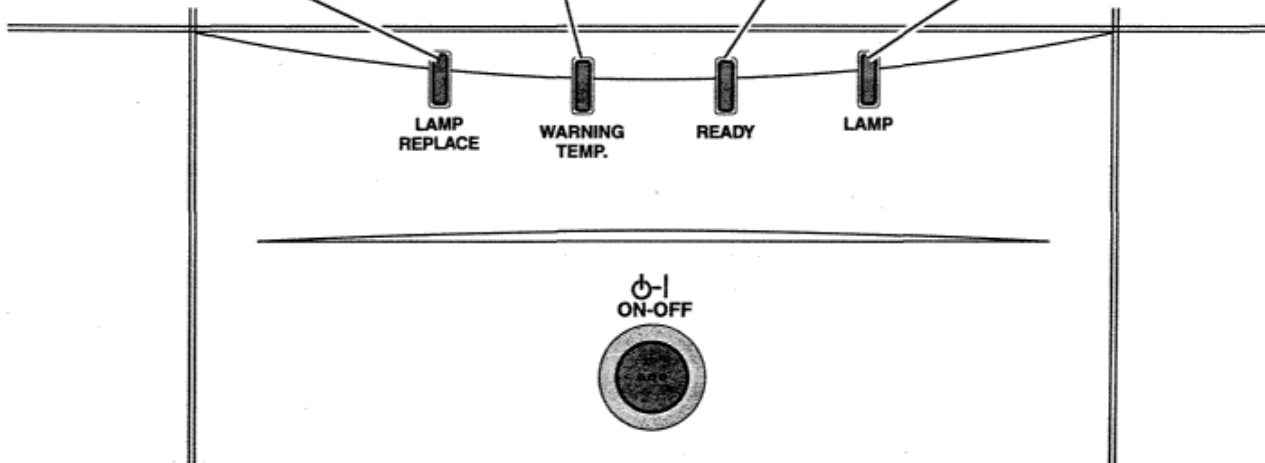

# TOP CONTROL

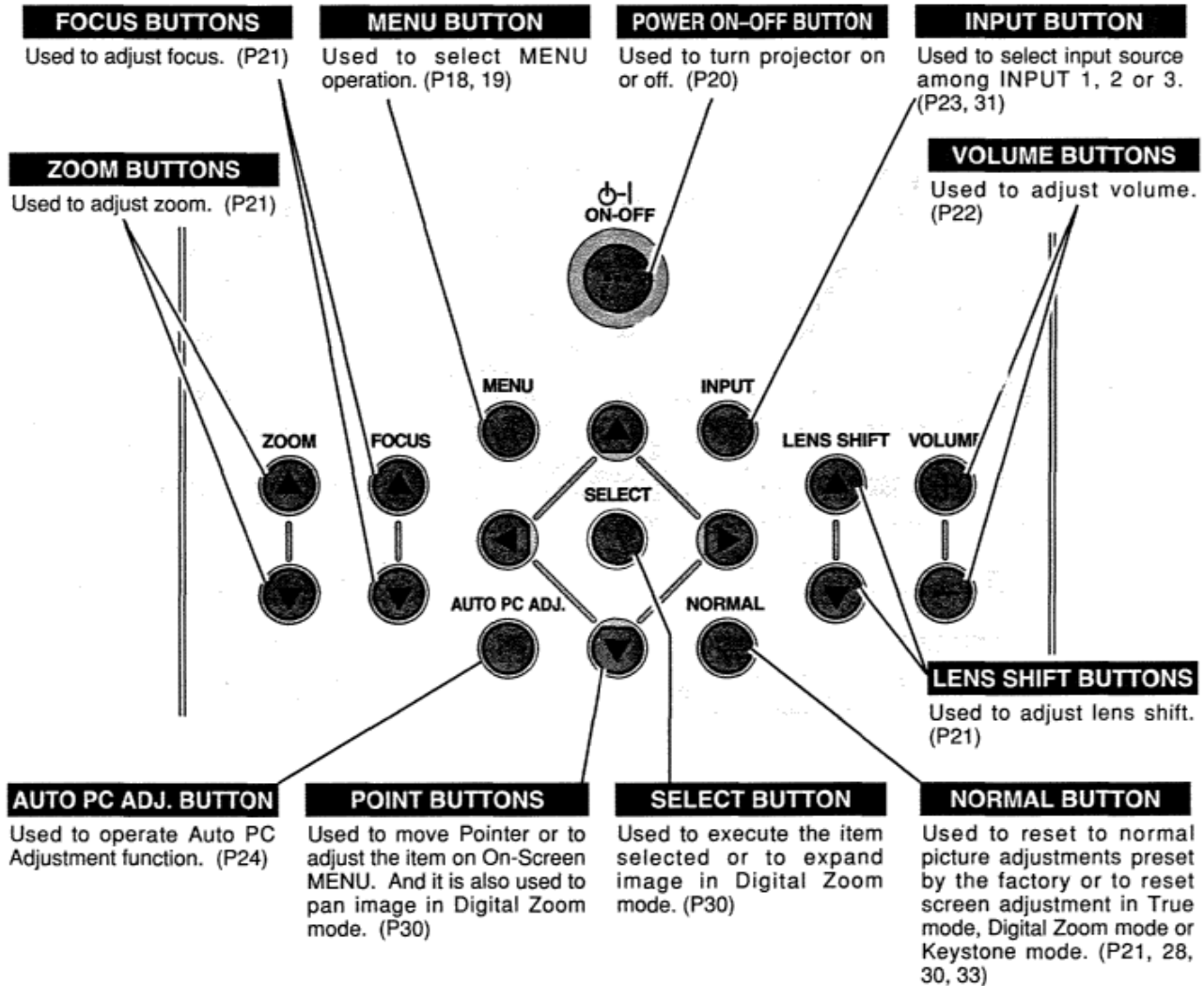

# OPERATION OF REMOTE CONTROL

Remote Control Unit can be used as either Wired or Wireless.

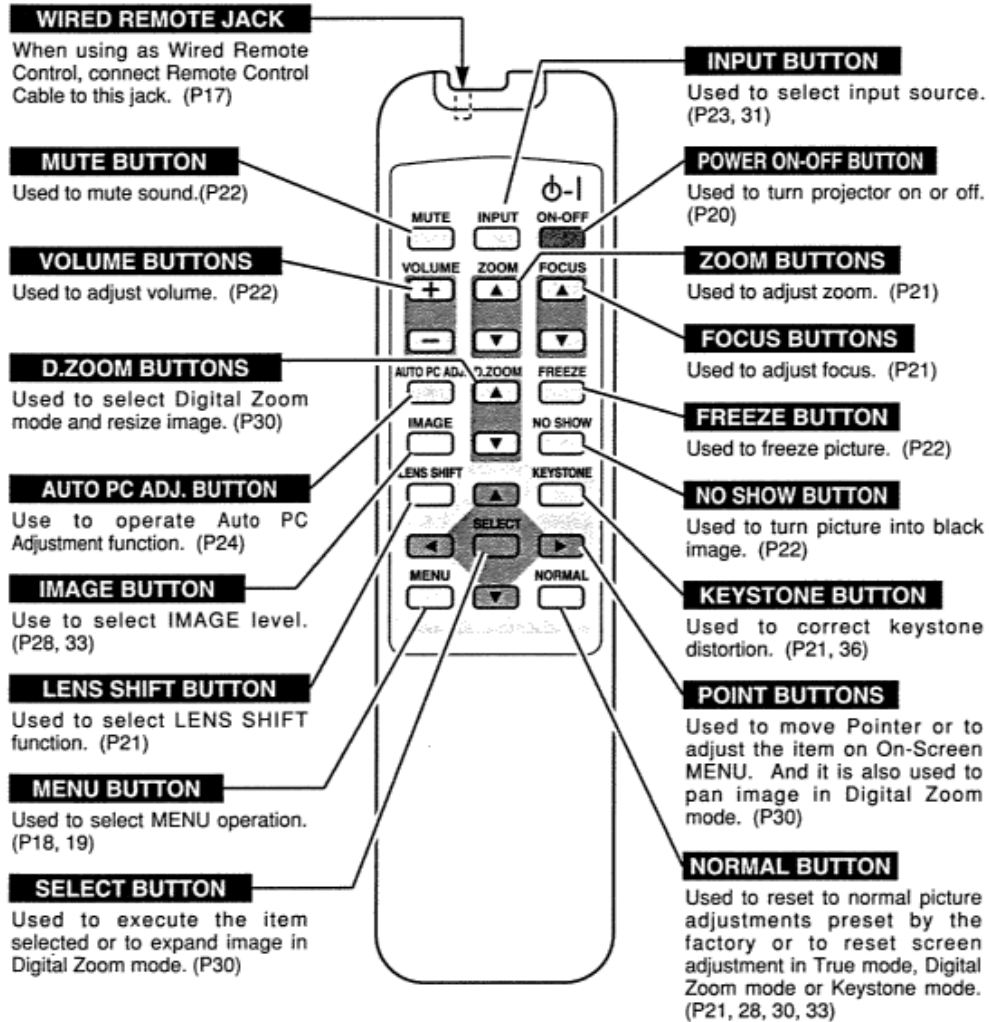

## OPERATING RANGE

Point Remote Control toward projector (Remote Receiver) whenever pressing the buttons. Maximum operating range for Remote Control is about 16.4' (5m) and 60° in front and rear of projector.

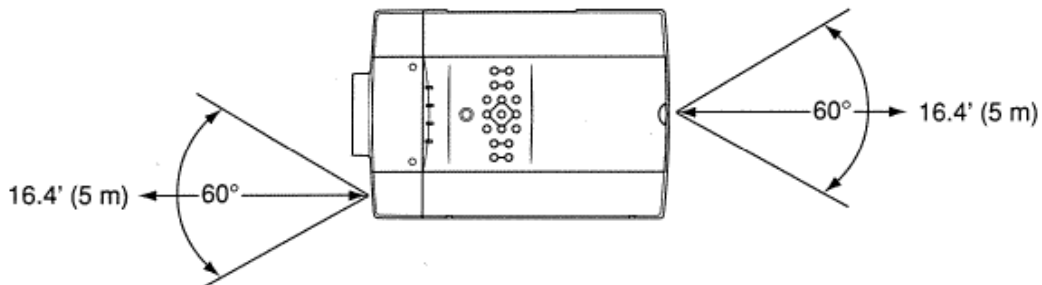



# WIRED REMOTE CONTROL

# OPERATIONS

When using this Remote Control Unit as Wired Remote Control, Connect Remote Control Unit to R/C JACK with Remote Control Cable (supplied). Batteries installation is required when using as Wired Remote Control Unit.

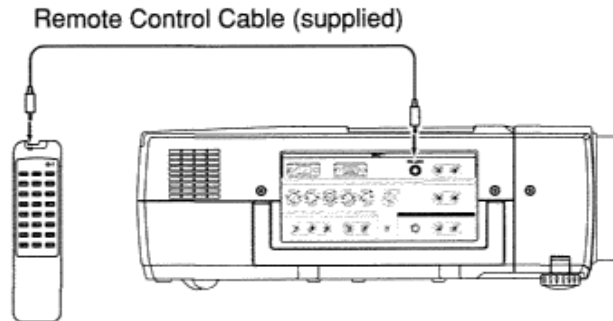

## REMOTE CONTROL BATTERIES INSTALLATION

1. Remove the battery compartment lid
- 2 Slide 2 batteries into the compartment.
- 3 Replace the compartment lid.

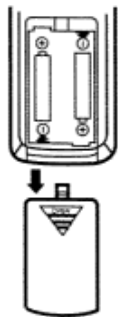

Press the lid downward and slide it.

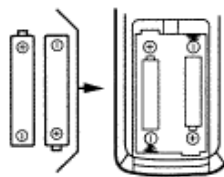

**Two AA size batteries**  
For correct polarity (+ and -), be sure the battery terminals are in contact with pins in the compartment.



Slide the lid upward.



**To insure safe operation, please observe the following precautions:**

- Use (2) AA, UM3 or R06 type alkaline batteries.
- Replace two batteries at the same time.
- Do not use a new battery with a used battery.
- Avoid contact with water or liquid.
- Do not expose Remote Control Unit to moisture, or heat
- Do not drop Remote Control Unit.
- If batteries have leaked on Remote Control Unit, carefully wipe the case clean and load new batteries..

# OPERATING ON-SCREEN MENU

## HOW TO OPERATE ON-SCREEN MENU

You can control and adjust this projector through ON-SCREEN MENU. Refer to the following pages to operate each adjustment on ON-SCREEN MENU.

**1 DISPLAY MENU** Press MENU button to display ON-SCREEN MENU.

### 2 MOVING POINTER

Move the pointer (\* see below) or adjust the value of item by pressing POINT button(s) on Top Control or on Remote Control Unit.

\* Pointer is the icon on ON-SCREEN MENU to select the item. See the figures on the section "FLOW OF ON-SCREEN MENU OPERATION" below.

### 3 SELECT ITEM

Select the item by pressing SELECT button.

#### REMOTE CONTROL

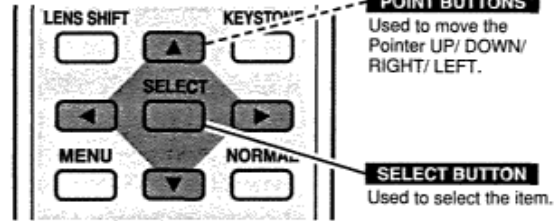

#### TOP CONTROL

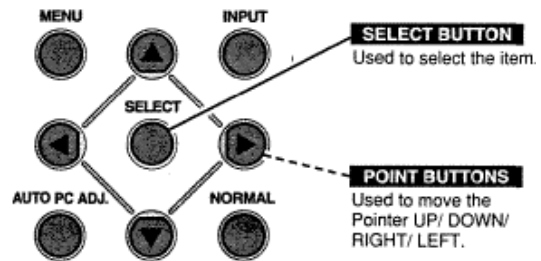

## FLOW OF ON-SCREEN MENU OPERATION

### Display ON-SCREEN MENU

**1** Press MENU button to display ON-SCREEN MENU (MENU BAR). A red frame is POINTER

### Select item to be adjusted

**2** Move POINTER (red frame) to MENU ICON that you want to select by pressing POINT RIGHT / LEFT buttons.

### Control and adjust through ON-SCREEN MENU

**3** Press POINT DOWN button and move POINTER (red frame or red arrow) to ITEM that you want to adjust, and then press SELECT button to show Item Data.

**4** Adjust ITEM DATA by pressing POINT buttons. Refer to the following pages for details of respective adjustments.

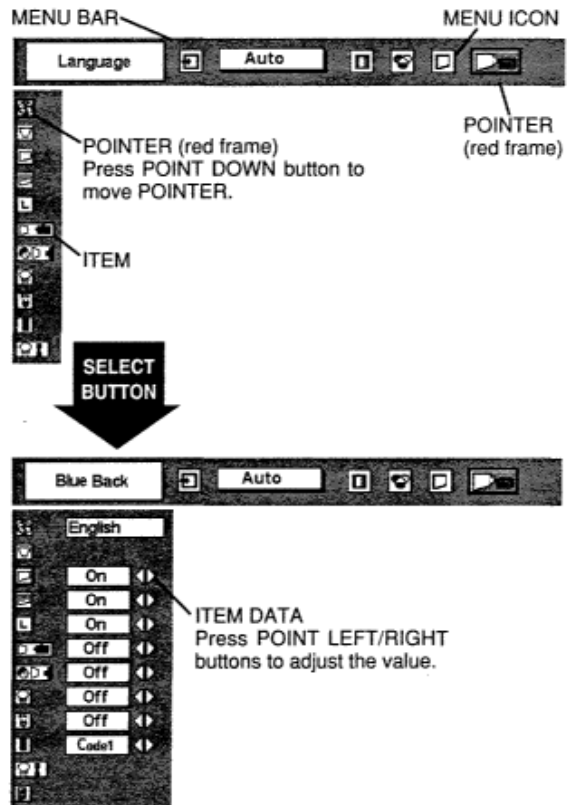

# MENU BAR

## FOR PC SOURCE

Press MENU BUTTON for PC input source.

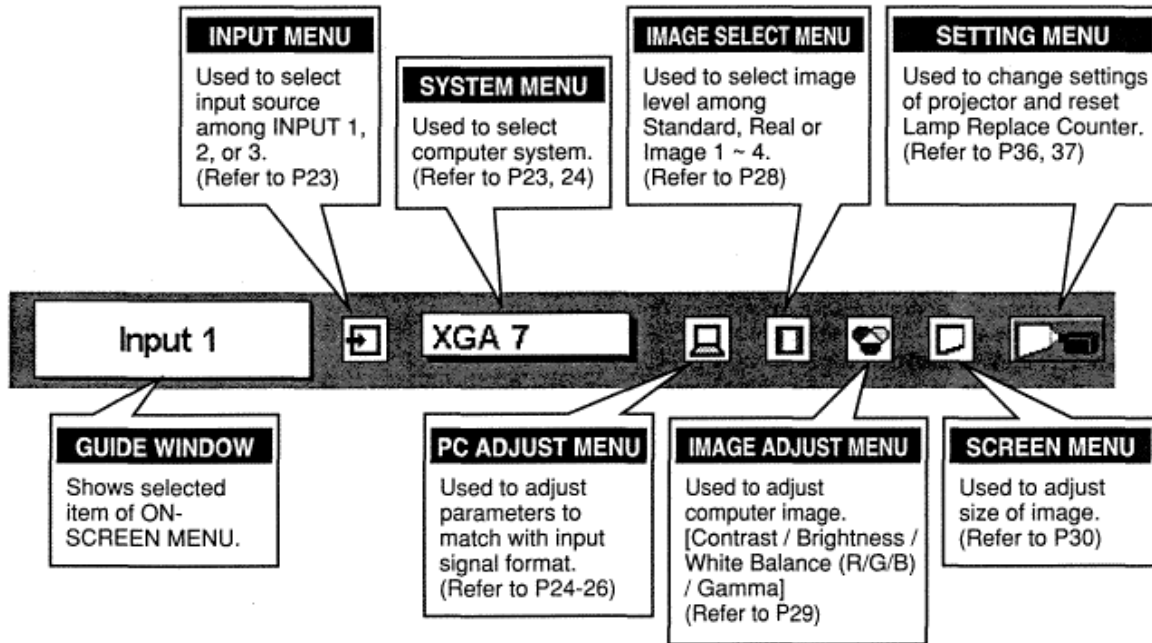

## FOR VIDEO SOURCE

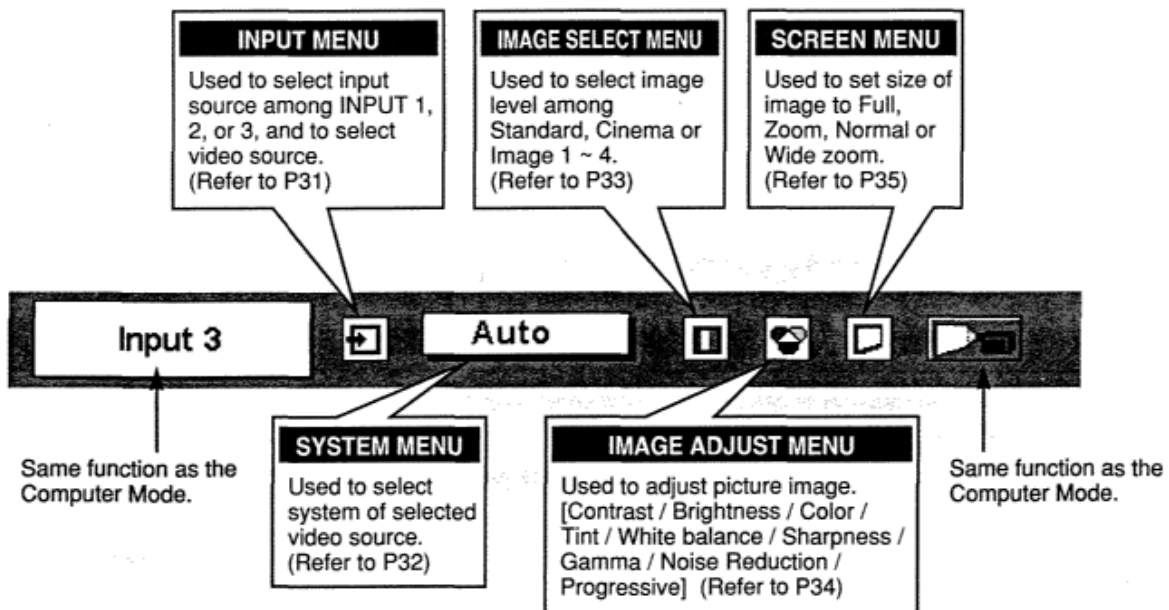

# TURNING ON / OFF PROJECTOR

## TURNING ON PROJECTOR

**1** Complete the peripheral connections (with Computer, VCR, etc.) before turning on projector. (Refer to "CONNECTING TO PROJECTOR" on Pages 11~13 for connecting that equipment.)

**2** Connect the projector's AC Power Cord into an AC outlet and turn MAIN ON / OFF SWITCH to ON. LAMP Indicator lights RED, and READY Indicator lights GREEN.

NOTE : When "On start" function is ON, this projector is turned on automatically by switching MAIN ON / OFF SWITCH on. (Refer to page 37.)

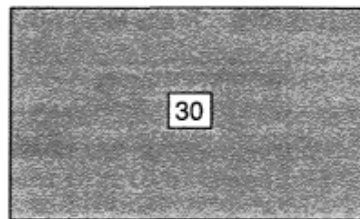

Preparation Display disappears after 30 seconds.

**3** Press POWER ON-OFF button on Top Control or on Remote Control Unit to ON. LAMP Indicator dims, and Cooling Fans start to operate. Preparation Display appears on a screen and the count-down starts. The signal from the PC or Video source appears after 30 seconds.

## TURNING OFF THE PROJECTOR

**1.** Press POWER ON-OFF button on Top Control or on Remote Control Unit, and the message "Power off?" appears on a screen.

**2** Press POWER ON-OFF button again to turn off projector. LAMP Indicator lights bright and READY Indicator turns off. After projector is turned off, Cooling Fans operate (for 90 seconds). During this "Cooling Down" period, this appliance cannot be turned on.

**3** When projector has cooled down, READY Indicator turns to green again and you can turn projector on. After cooling down completely, turn MAIN ON / OFF SWITCH to OFF and disconnect AC Power Cord.

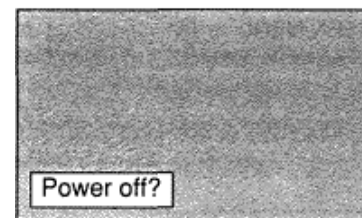

Message disappears after 4 seconds.



TO MAINTAIN THE LIFE OF LAMP, ONCE YOU TURN PROJECTOR ON, WAIT AT LEAST 5 MINUTES BEFORE TURNING IT OFF.

When "Power Management" function is ON, projector detects signal interruption and turns off Projection Lamp automatically. Refer to "Power Management" on page 37.

When WARNING TEMP. Indicator flashes red, projector is automatically turned off. Wait at least 5 minutes before turning on projector again.

When WARNING TEMP. Indicator continues to flash, follow procedures below:

1. Turn MAIN ON / OFF SWITCH to OFF and disconnect the AC Power Cord from a AC outlet.
2. Check Air Filters for dust accumulation.
3. Clean Air Filters. (See "AIR FILTER CARE AND CLEANING" section on page 38.)
4. Turn projector on again.

If WARNING TEMP. Indicator should still continue to flash, contact the sales dealer where you purchased this projector or service center.

# ADJUSTING SCREEN

## ZOOM ADJUSTMENT

- 1 Press ZOOM **AV** button(s) on Top Control or on Remote Control Unit. The message "Zoom" is displayed.
- 2 Press ZOOM A button or POINT UP button to make image larger, and press ZOOM V button or POINT DOWN button to make image smaller.

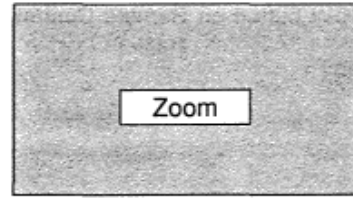

Message disappears after 4 seconds.

## FOCUS ADJUSTMENT

- 1 Press FOCUS **AV** button(s) on Top Control or on Remote Control Unit. The message "Focus" is displayed.
- 2 Adjust focus of the image by pressing FOCUS **AV** button(s) or POINT UP/DOWN button(s).

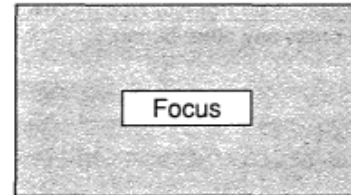

Message disappears after 4 seconds.

## LENS SHIFT ADJUSTMENT

- 1 Press LENS SHIFT **AV** button(s) on Top Control or LENS SHIFT button on Remote Control Unit. The message "Lens shift" is displayed.
- 2 Press LENS SHIFT A button or POINT UP button to move image up, and press LENS SHIFT V button or POINT DOWN button to move image down. Refer to P9 for operating range.

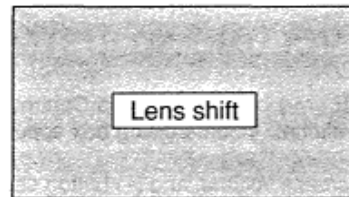

Message disappears after 4 seconds.

## KEYSTONE ADJUSTMENT

If image has keystone distortion, correct image with KEYSTONE adjustment

- 1 Press KEYSTONE button on Remote Control Unit or select Keystone on SETTING Menu (P36). The message "Keystone" is displayed.
- 2 Correct keystone distortion by pressing POINT UP/DOWN button(s). Press POINT UP button to reduce upper part of the image, and press POINT DOWN button to reduce lower part of the image. To reset Keystone adjustment, press NORMAL button.

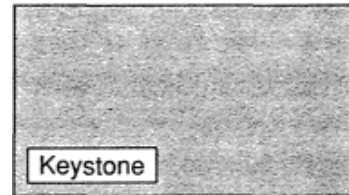

Message disappears after 4 seconds.

Reduce the upper width with POINT UP button.

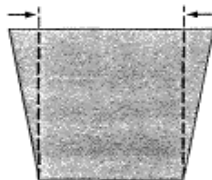

Reduce the lower width with POINT DOWN button.

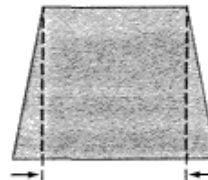

## NO SHOW FUNCTION

Press NO SHOW button on Remote Control Unit to black out the image. To restore to normal, press NO SHOW button again or press any other button.

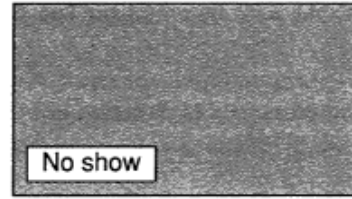

Message disappears after 4 seconds.

## PICTURE FREEZE FUNCTION

Press FREEZE button on Remote Control Unit to freeze the picture on-screen. To cancel FREEZE function, press FREEZE button again or press any other button.

Press VOLUME (+/—) button(s) on Top Control or on Remote Control Unit to adjust volume. Volume dialog box appears on the screen for a few seconds.

(+) button to increase volume, and (—) button decreasing.

## MUTE SETTING

Press MUTE button on Remote Control Unit to cut off sound. To restore sound to its previous level, press MUTE button again or press Volume (+/—) button(s).

# SELECTING INPUT SOURCE

## DIRECT OPERATION

Choose either Input 1 or Input 2 by pressing INPUT button on Top Control or on Remote Control Unit.

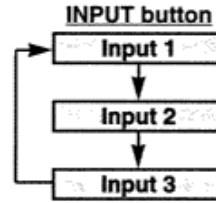

## MENU OPERATION

Press MENU button and ON-SCREEN MENU will appear. Press POINT LEFT/RIGHT button to move a red frame pointer to INPUT Menu icon.

- Press POINT DOWN button to move a red arrow pointer to either Input 1 or Input 2 that you want to choose and then press SELECT button. When choosing Input 2, Source Select Menu will appear. Move POINTER to RGB and then press SELECT button. (Input 2 accepts R, G, B, HN and V computer signals (P 13).)

This projector automatically tunes to most different types of computers based on VGA, SVGA, XGA or SXGA (refer to "COMPATIBLE COMPUTER SPECIFICATION" on page 27). When selecting Computer, this projector automatically tunes to incoming signal and projects proper image without any special setting. (Some computers need setting manually.)

Note: Projector may display one of the followin~ messanes.

When projector cannot recognize connected signal as PC system provided in this projector, Auto PC Adjustment

### INPUT MENU

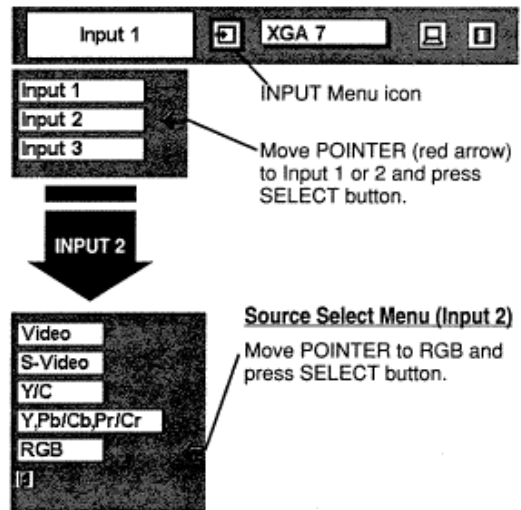

# SELECTING COMPUTER SYSTEM

function operates to adjust projector and the message "AUTO PC Adj." is displayed on SYSTEM icon. When image is not provided properly, manual adjustment is required. (Refer to P25 and 26.)

There is no signal input from computer. Make sure the connection of computer and projector is set correctly. (Refer to TROUBLESHOOTING on page 40.)

**AUTO PC Adj.** When projector cannot recognize connected signal as PC system provided in this projector, Auto PC Adjustment function operates to adjust projector and the message "AUTO PC Adj." Is displayed on SYSTEM icon. When image is not provided properly, manual adjustment is required (Refer to P25 and 26).

**No signal**

There is no signal input from computer. Make sure the connection of computer and projector is set correctly, (Refer to TROUBLESHOOTING on page 40.)

### SYSTEM MENU

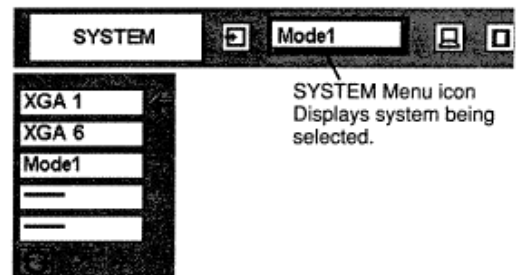

## SELECT COMPUTER SYSTEM MANUALLY

This projector automatically selects PC system among those provided

in this projector and PC system can be also selected manually.

- 1 Press MENU button and ON-SCREEN MENU will appear. Press POINT LEFT/RIGHT buttons to move a red frame pointer to SYSTEM icon.
- 2 Press POINT DOWN button to move a red arrow pointer to the system that you want to set, and then press SELECT button. Auto PC Adjustment function is provided to automatically adjust Fine sync., Total dots, and Picture Position to conform to your computer. Auto PC Adjustment function can be operated as follows.

### SYSTEM MENU

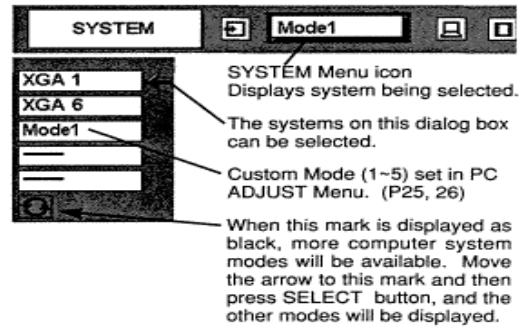

## PC ADJUSTMENT

### AUTO PC ADJUSTMENT



- 1 Press MENU button and ON-SCREEN MENU will appear. Press POINT LEFT/RIGHT button to move a red frame pointer to PC ADJUST Menu icon.
- 2 Press POINT DOWN button to move a red frame pointer to AUTO PC Adj. icon and then press SELECT button. This Auto PC Adjustment can be executed by pressing AUTO PC ADJ. button on Top Control or on Remote Control Unit.

Fine sync, Total dots and Picture Position of some computers may not be fully adjusted with Auto PC Adjustment function. When the image is not provided properly through this function, manual adjustment is required. (Refer to page 25, 26.)

### PC ADJUST MENU

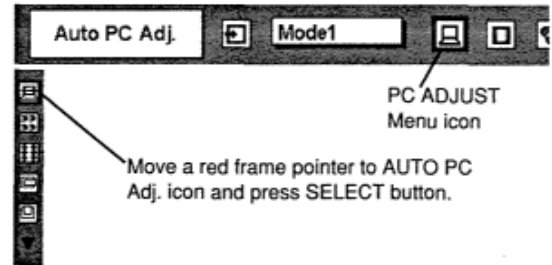

Store adjustment parameters. Adjustment parameters from Auto PC Adjustment can be memorized in this projector. Once parameters are memorized, setting can be done just by selecting Mode in SYSTEM Menu (above). Refer to step 3 of MANUAL PC ADJUSTMENT section (P26).

NOTE: Auto PC Adjustment function cannot be operated when "RGB," "HDTV720p," "HDTV1035i" or "HDTV1080i" is selected on SYSTEM Menu (P23, 24).



## MANUAL PC ADJUSTMENT

This projector can automatically tune to the display signals from most personal computers currently distributed. However, some computers employ special signal formats which are different from the standard ones and may not be tuned by Multi-Scan system of this projector. If this happens, projector cannot reproduce a proper image and the image may be recognized as a flickering picture, a non-synchronized picture, a non-centered picture or a skewed picture.

This projector has a Manual PC Adjustment to enable you to precisely adjust several parameters to match with those special signal formats. This projector has 5 independent memory areas to memorize those parameters manually adjusted. This enables you to recall the setting for a specific computer whenever you use it.

Note : This PC ADJUST Menu cannot be operated when "RGB" is selected on SYSTEM Menu (P23, 24).

- 1 Press MENU button and ON-SCREEN MENU will appear. Press POINT LEFT/RIGHT button to move a red frame pointer to PC ADJUST Menu icon.
- 2 Press POINT DOWN button to move a red frame pointer to the item that you want to adjust and then press SELECT button. Adjustment dialog box will appear. Press POINT LEFT/RIGHT button to adjust the value.

### Fine sync

Adjust the picture as necessary to eliminate flicker from the display. Press POINT LEFT/RIGHT button to adjust value.(From 0 to 255.)

### Total dots

The number of total dots in one horizontal period. Press POINT LEFT/RIGHT button(s) and adjust number to match your PC image.

### Horizontal

Adjust horizontal picture position. Press POINT LEFT/RIGHT button(s) to adjust the position.

### Vertical

Adjust vertical picture position. Press POINT LEFT/RIGHT button(s) to adjust the position.

### Current mode

Press SELECT button to show the information of computer selected.

### Total lines

The number of the total horizontal lines. Press POINT LEFT/RIGHT button(s) and adjust number to match your PC image.

### Clamp

Adjusts clamp level. When the image has a dark bar(s), try this adjustment.

### PC ADJUST MENU

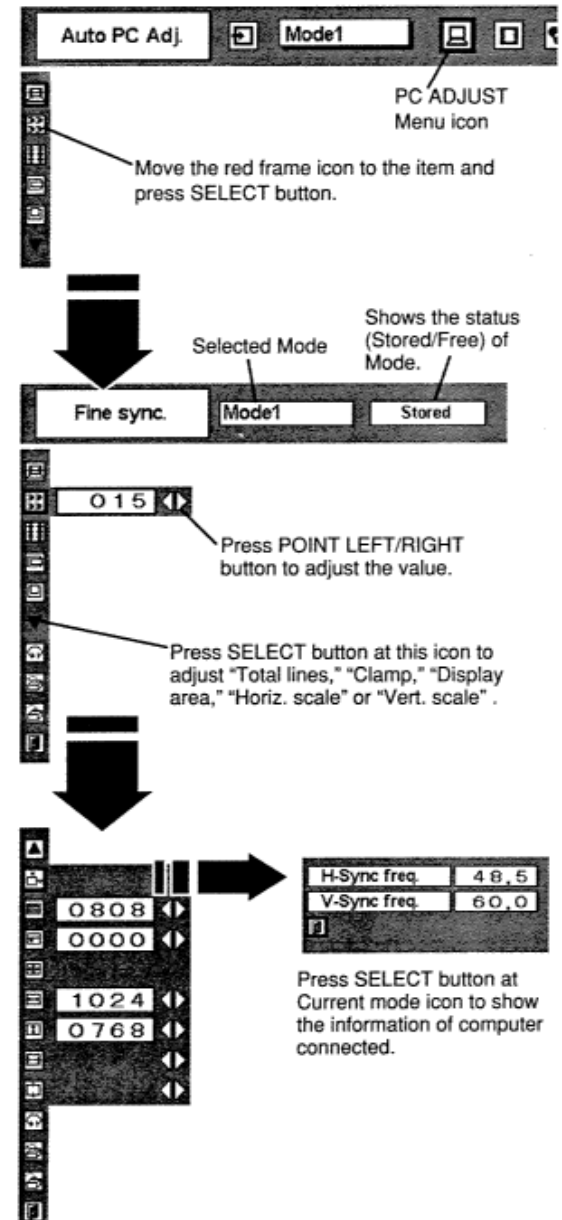

 **Display area**

Selects area displayed with this projector. Select the resolution at the Display area dialog box.

 **Display area H**

Adjustment of horizontal area displayed with this projector. Press POINT LEFT/RIGHT button(s) and adjust number to match the resolution of image.

 **Display area V**

Adjustment of vertical area displayed with this projector. Press POINT LEFT/RIGHT button(s) and adjust number to match the resolution of image.

 **Horizontal scale**

Adjustment of width of image. Press POINT LEFT/RIGHT button(s) for adjustments.

 **Vertical scale**

Adjustment of height of image. Press POINT LEFT/RIGHT button(s) for adjustments.

NOTE: Display area (H/V), Horizontal scale and Vertical scale cannot be adjusted when "HDTV1035i" or "HDTV1080i" is selected on SYSTEM Menu (P23, 24).

Fine sync and Total dots cannot be fully adjusted when 'HDTV1035i' or "HDTV1080i" is selected on SYSTEM Menu (P23, 24).

**3**  **Stored**

To store adjustment parameters, move a red frame pointer to Stored icon and then press SELECT button. Move a red arrow pointer to any of Mode 1 to 5 that you want to store to and then press SELECT button.

 **Mode free**

To clear adjustment parameters previously set, move a red frame pointer to Mode free icon and then SELECT button. Move a red arrow pointer to the Mode that you want to clear and then press SELECT button.

Other icons operates as follows.

 **Reset**

Reset all adjust parameters on adjustment dialog box to previous figure.

 **Quit**

Closes PC ADJUST MENU

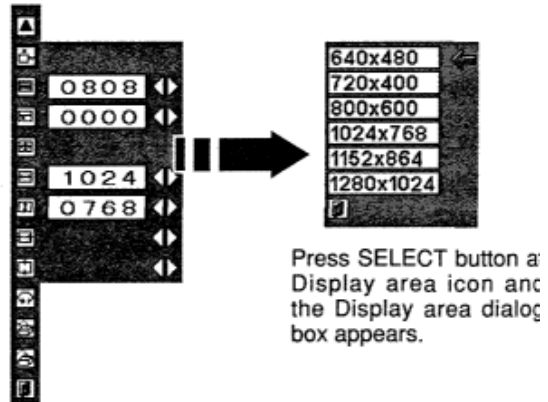

**To store the adjustment data.**

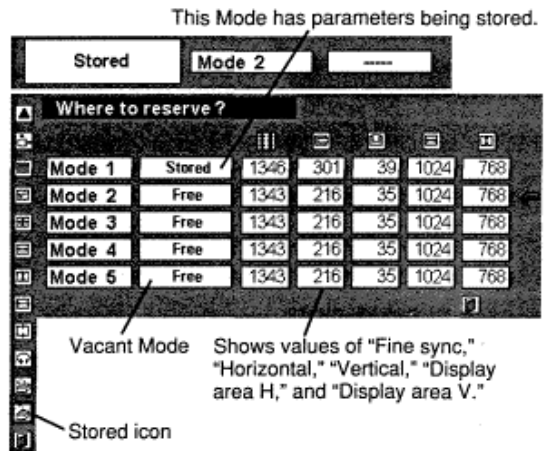

**To clear the adjustment data.**

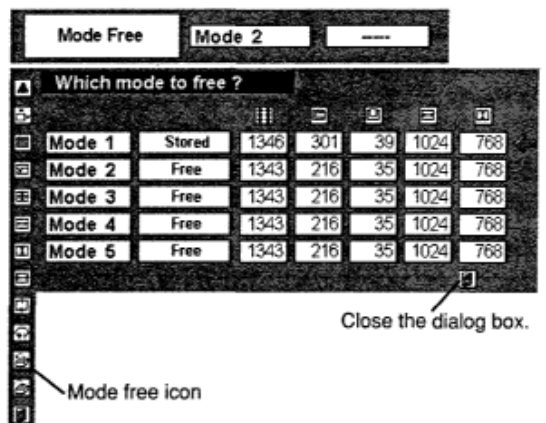

## COMPATIBLE COMPUTER SPECIFICATIONS

Basically this projector can accept the signal from all computers with the V, H-Frequency mentioned below and less than 180 MHz of Dot Clock.  
NOTE : Specifications are subject to change without notice.

ON-SCREEN DISPLAY	RESOLUTION	H-Freq. (kHz)	V-Freq. (Hz)	ON-SCREEN DISPLAY	RESOLUTION	H-Freq. (kHz)	V-Freq. (Hz)
VGA 1	640 x 480	31.47	59.88	XGA 11	1024 x 768	61.00	75.70
VGA 2	720 x 400	31.47	70.09	XGA 12	1024 x 768	35.522	86.96 (Interlace)
VGA 3	640 x 400	31.47	70.09	XGA 13	1024 x 768	46.90	58.20
VGA 4	640 x 480	37.86	74.38	XGA 14	1024 x 768	47.00	58.30
VGA 5	640 x 480	37.86	72.81	XGA15	1024 x 768	58.03	72.0
VGA 6	640 x 480	37.50	75.00	MAC 19	1024 x 768	60.24	75.08
VGA 7	640 x 480	43.269	85.00	MAC 21	1152 x 870	68.68	75.06
MAC LC13	640 x 480	34.97	66.60	SXGA 1	1152 x 864	64.20	70.40
MAC 13	640 x 480	35.00	66.67	SXGA 2	1280 x 1024	62.50	58.60
RGB	————	15.625	50 (Interlace)	SXGA 3	1280 x 1024	63.90	60.00
RGB	————	15.734	60 (Interlace)	SXGA 4	1280 x 1024	63.34	59.98
SVGA 1	800 x 600	35.156	56.25	SXGA 5	1280 x 1024	63.74	60.01
SVGA 2	800 x 600	37.88	60.32	SXGA 6	1280 x 1024	71.69	67.19
SVGA 3	800 x 600	46.875	75.00	SXGA 7	1280 x 1024	81.13	76.107
SVGA 4	800 x 600	53.674	85.06	SXGA 8	1280 x 1024	63.98	60.02
SVGA 5	800 x 600	48.08	72.19	SXGA 9	1280 x 1024	79.976	75.025
SVGA 6	800 x 600	37.90	61.03	SXGA 10	1280 x 960	60.00	60.00
SVGA 7	800 x 600	34.50	55.38	SXGA 11	1152 x 900	61.20	65.20
SVGA 8	800 x 600	38.00	60.51	SXGA 12	1152 x 900	71.40	75.60
SVGA 9	800 x 600	38.60	60.31	SXGA 13	1280 x 1024	50.00	86.00 (Interlace)
SVGA 10	800 x 600	32.70	51.09	SXGA 14	1280 x 1024	50.00	94.00 (Interlace)
SVGA 11	800 x 600	38.00	60.51	SXGA 15	1280 x 1024	63.37	60.01
MAC 16	832 x 624	49.72	74.55	SXGA 16	1280 x 1024	76.97	72.00
XGA 1	1024 x 768	48.36	60.00	SXGA 17	1152 x 900	61.85	66.00
XGA 2	1024 x 768	68.677	84.997	SXGA 18	1280 x 1024	46.43	86.70 (Interlace)
XGA 3	1024 x 768	60.023	75.03	SXGA 19	1280 x 1024	63.79	60.18
XGA 4	1024 x 768	56.47	70.07	SXGA 20	1280 x 1024	91.146	85.024
XGA 5	1024 x 768	60.31	74.92	MAC	1280 x 960	75.00	75.08
XGA 6	1024 x 768	48.50	60.02	MAC	1280 x 1024	80.00	75.08
XGA 7	1024 x 768	44.00	54.58	HDTV720p	————	45.00	60.00
XGA 8	1024 x 768	63.48	79.35	HDTV1035i	————	33.75	60.00 (Interlace)
XGA 9	1024 x 768	36.00	87.17 (Interlace)	HDTV1080i	————	33.75	60.00 (Interlace)
XGA 10	1024 x 768	62.04	77.07				

NOTE: Specifications are subject to change without notice.

# PICTURE IMAGE ADJUSTMENTS

## IMAGE LEVEL SELECT (DIRECT)

Select image level among Standard, Real, Image 1, Image 2, Image 3 and Image 4 by pressing IMAGE button on the Remote Control Unit.

### Standard

Normal picture level preset on this projector. This normal picture level can also be selected by pressing NORMAL button.

### Real

Picture level adjusted for the picture with fine tone.

### IMAGE 1~4

User preset picture adjustment in IMA(.iE AL)JUS I Menu (t~29).

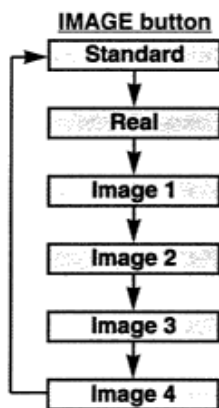

## IMAGE LEVEL SELECT (MENU)

1 Press MENU button and ON-SCREEN MENU will appear. Press POINT LEFT/RIGHT button to move a red frame pointer to IMAGE SELECT Menu icon.

2 Press POINT DOWN button to move a red frame pointer to the level that you want to set and then press SELECT button.



+

Normal picture level preset on this projector.



Picture level adjusted for the picture with fine tone.



IMAGE 1~4

User preset picture adjustment in IMAGE ADJUST Menu (P29).

### IMAGE SELECT MENU

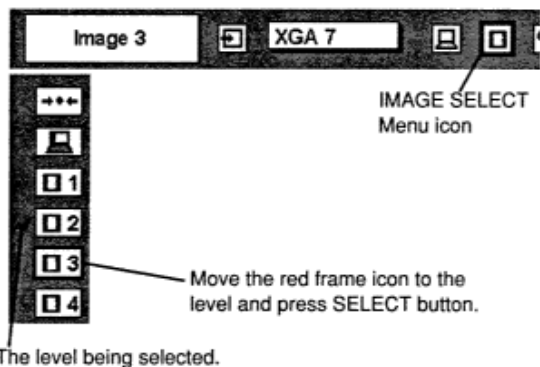

# IMAGE LEVEL ADJUSTMENT

Press MENU button and ON-SCREEN MENU will appear. Press POINT LEFT/RIGHT buttons to move a red frame pointer to IMAGE ADJUST Menu icon.

**2** Press POINT DOWN button to move a red frame pointer to the item that you want to adjust. and then press SELECT button. The level of each item is displayed. Adjust each level by pressing POINT LEFT/RIGHT button(s).

 **Contrast**

Press POINT LEFT button to decrease contrast, and POINT RIGHT button to increase contrast. (From 0 to 63.)

 **Brightness**

Press POINT LEFT button to adjust image darker, and POINT RIGHT button to adjust brighter. (From 0 to 63.)

 **White balance (Red)**

Press POINT LEFT button to lighten red tone and POINT RIGHT button to deeper tone. (From 0 to 63.)

 **White balance (Green)**

Press POINT LEFT button to lighten green tone and POINT RIGHT button to deeper tone. (From 0 to 63.)

 **White balance (Blue)**

Press POINT LEFT button to lighten blue tone and POINT RIGHT button to deeper tone. (From 0 to 63.)

 **Gamma**

Press either POINT LEFT button or POINT RIGHT button to obtain better balance of contrast. (From 0 to 15.)

**3**  **Stored**

To store manually preset image, move a red frame pointer to STORE icon and press SELECT button. Image Level Menu will appear. Move a red frame pointer to the Image 1 to 4 where you want to

set and then press SELECT button.

 **Reset**

Reset all adjustment to previous figure.

 **Quit**

Closes IMAGE MENU.

## IMAGE ADJUST MENU

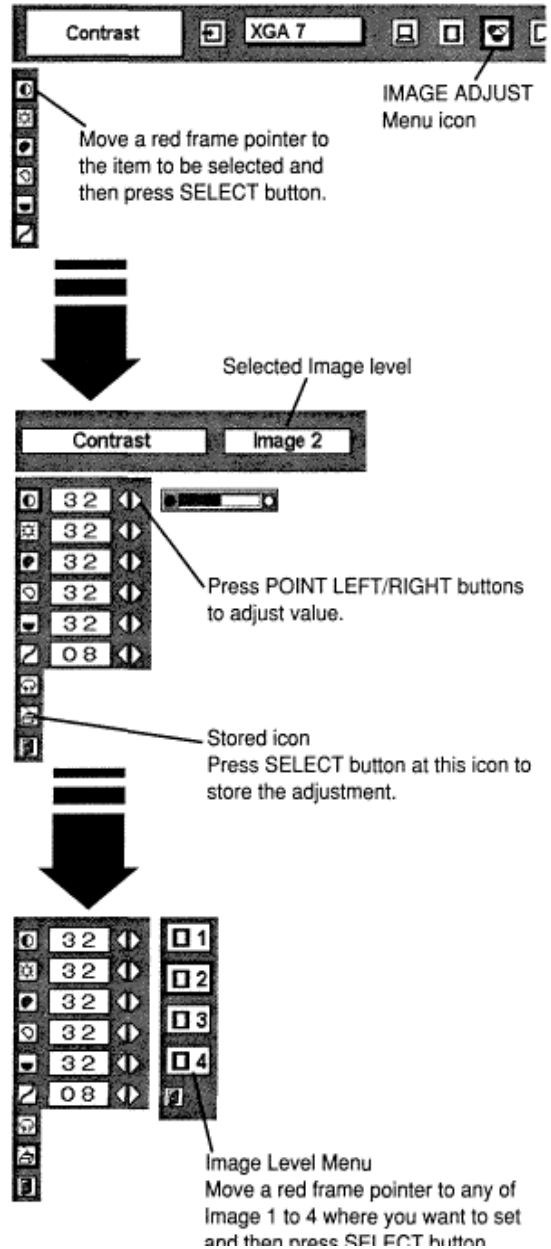

# PICTURE SCREEN ADJUSTMENT

This projector has a picture screen resize function, which enables you to display the desirable image size.

**1** Press **MENU** button and **ON-SCREEN MENU** will appear. Press **POINT LEFT/RIGHT** button(s) to move a red frame pointer to **SCREEN Menu icon**.

**2** Press **POINT DOWN** button and move a red frame pointer to the function that you want to select and then press **SELECT** button.



**Normal**

Provides image to fit the vertical size of the screen.



**Full**

Provides image to fit the horizontal size of the screen.



**True**

Provides image in its original size. When the original image size is larger than screen size (1366 x 768), this projector enters Digital Zoom mode automatically. Image size can be set to Normal by pressing **NORMAL** button.



**Digital Zoom**

Adjusts image size or pans image. In "Digital Zoom" mode, the **ON-SCREEN MENU** disappears and the magnifying glass icon and the message "D. Zoom" is displayed. This projector also enters Digital Zoom mode by pressing the **D.ZOOM A/V** button on Remote Control Unit.

Refer to the following for operation.

## Expand function

To expand the image size, press the **D.ZOOM A** button or the **SELECT** button. The image is magnified by degrees.

## Compress function

To compress the image size, press the **D.ZOOM V** button. The

## Panning function

## SCREEN MENU

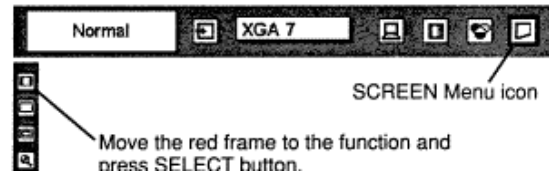

To pan the image, press the **POINT UP/DOWN/LEFT/RIGHT** buttons. Panning function can work only when the image is larger than the screen size.

To return to screen size previously set, press **NORMAL** button.

To cancel Digital Zoom mode, press any button except **D.ZOOM A/V**, **SELECT**, **POINT**, **NORMAL** or **AUTO PC ADJ.** button.

## NOTE

- This **SCREEN Menu** cannot be operated when "HDTV72Op," "HDTV1035i" or "HDTV1080i" is selected on **SYSTEM Menu** (P23, 24).
- True and Digital Zoom cannot be selected when "RGB" is selected on **SYSTEM Menu** (P23, 24).
- This projector cannot display any resolution higher than 1280 X 1024. If your computer's screen resolution is higher than 1280 X 1024, reset the resolution to the lower before connecting projector.
- The image data in other than XGA (1024 x 768) is modified to fit the screen size in the initial mode.
- Panning function may not operate properly if the computer system prepared on **PC ADJUST Menu** is used.

# SELECTING INPUT SOURCE

## DIRECT OPERATION

Choose either Input 2 or Input 3 by pressing INPUT button on the Top Control or on the Remote Control Unit.

If projector cannot reproduce proper video source, select correct input source through MENU OPERATION (see below).

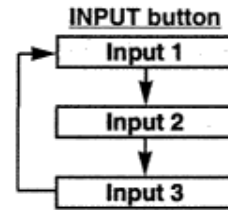

## MENU OPERATION

- 1 Press MENU button and ON-SCREEN MENU will appear. Press POINT LEFT/RIGHT button to move a red frame pointer to INPUT Menu icon.
- 2 Press POINT DOWN button to move a red arrow pointer to either Input 2 or Input 3 that you want to choose and then press SELECT button. Source Select Menu appear.
- 3 Move the pointer to the source that you want to select and then press SELECT button.

### INPUT MENU

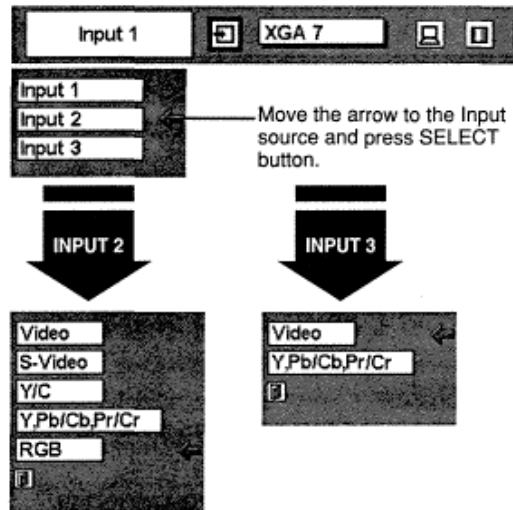

### Source Select Menu (Input 2 / 3)

Move the arrow to the source and press SELECT button.

# SELECTING VIDEO SYSTEM

- 1 Press MENU button and ON-SCREEN MENU will appear. Press POINT LEFT/RIGHT buttons to move a red frame pointer to SYSTEM Menu icon.
- 2 Press POINT DOWN button to move a red arrow pointer to the system that you want to select and then press SELECT button.

## VIDEO JACK, YIC JACKS OR S-VIDEO JACK

**Auto** Projector automatically detects incoming Video system, and adjusts itself to optimize its performance.

When Video System is PAL-M or PAL-N, select system manually.

If projector cannot reproduce proper video image, it is necessary to select a

### **PAL / SECAM / NTSC / NTSC4.43 / PAL-M / PAL-N**

specific broadcast signal format among PAL, SECAM, NTSC, NTSC 4.43, PAL-M, and PAL-N.

### AV SYSTEM MENU (VIDEO OR S-VIDEO)

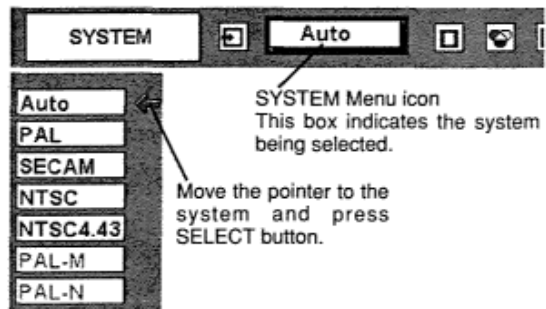

## Y, Pb/Cb, Pr/Cr JACKS

**Auto** Projector automatically detects incoming Video signal, and adjusts itself to optimize its performance.

### **COMPONENT VIDEO SIGNAL FORMAT**

If projector cannot reproduce proper video image, it is necessary to select a specific component video signal format among 480i, 575i, 480p, 575p, 720p, 1035i and 1080i.

### AV SYSTEM MENU (COMPONENT VIDEO)

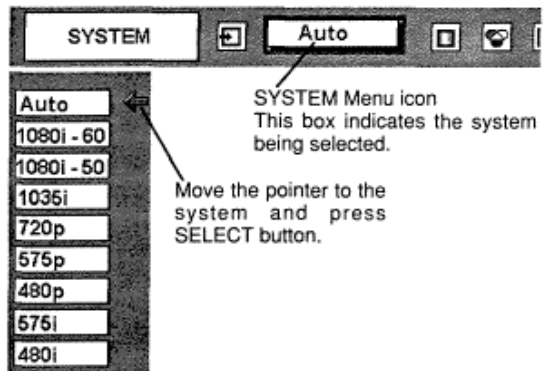



# PICTURE IMAGE ADJUSTMENTS

## IMAGE LEVEL SELECT (DIRECT)

## VIDEO MODE

Select image level among Standard, Cinema, Image 1, Image 2, Image 3 and Image 4 by pressing IMAGE button on the Remote Control Unit.

### Standard

Normal picture level preset on this projector. This normal picture level can also be selected by pressing NORMAL button.

### Cinema

Picture level adjusted for the picture with fine tone.

### IMAGE 1-4

User preset picture adjustment in IMAGE ADJUST Menu (P34).

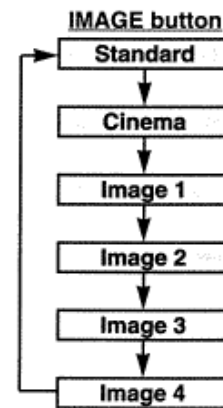

## IMAGE LEVEL SELECT (MENU)

- 1 Press MENU button and ON-SCREEN MENU will appear. Press POINT LEFT/RIGHT button to move a red frame pointer to IMAGE SELECT Menu icon.
- 2 Press POINT DOWN button to move a red frame pointer to the level that you want to set and then press SELECT button.

 **Standard** Normal picture level preset on this projector.

 **Cinema** Picture level adjusted for the picture with fine tone.

 **IMAGE 1-4**

### IMAGE SELECT MENU

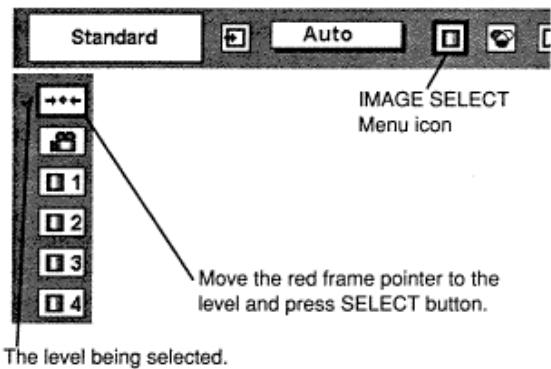

## IMAGE LEVEL ADJUSTMENT

Press MENU button and ON-SCREEN MENU will appear. Press POINT LEFT/RIGHT button(s) to move a red frame pointer to the IMAGE ADJUST Menu icon.

- 2** Press POINT DOWN button to move a red frame pointer to the item that you want to adjust and then press SELECT button. The level of each item is displayed. Adjust each level by pressing POINT LEFT/RIGHT button(s).

### **Contrast**

Press POINT LEFT button to decrease contrast, and POINT RIGHT button to increase contrast. (From 0 to 63.)

### **Brightness**

Press POINT LEFT button to adjust image darker, and POINT RIGHT button to adjust brighter. (From 0 to 63.)

### **Color**

Press POINT LEFT button to lighten color, and POINT RIGHT button to deeper color. (From 0 to 63.)

### **Tint**

Press POINT LEFT button or POINT RIGHT button to obtain proper color. (From 0 to 63.)

### **White balance (Red)**

Press POINT LEFT button to lighten red tone and POINT RIGHT button to deeper tone. (From 0 to 63.)

### **White balance (Green)**

Press POINT LEFT button to lighten green tone and POINT RIGHT button to deeper tone. (From 0 to 63.)

### **White balance (Blue)**

Press POINT LEFT button to lighten blue tone and POINT RIGHT button to deeper tone. (From 0 to 63.)

### **Sharpness**

Press POINT LEFT button to soften the image, and POINT RIGHT button to sharpen the image. (From 0 to 31.)

### **Gamma**

Press either POINT LEFT button or POINT RIGHT button to obtain better balance of contrast. (From 0 to 15.)

### **Noise reduction**

Set "On" to reduce noise (rough parts) of the image.

### **Progressive**

Set "On" to provide progressive scan mode.

### IMAGE ADJUST MENU

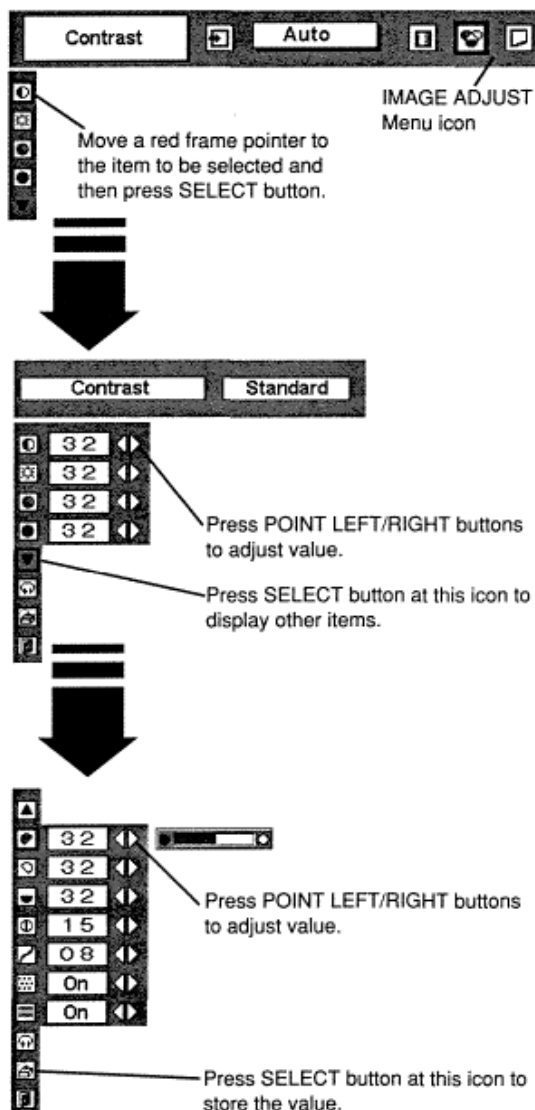

**NOTE:** Tint cannot be adjusted when the video system is PAL, SECAM, PAL-M or PAL-N.  
Noise reduction cannot be selected when the input signal is from Y, Pb/Cb, Pr/Cr jacks.  
Progressive cannot be selected when "480p," "575p" or "720p" is selected on SYSTEM Menu (P32).

### 3 **Stored**

To store the adjustment data, move a red frame pointer to Stored icon and press SELECT button. Image Level Menu will appear. Move a red frame pointer to the Image Level 1 to 4 and then press SELECT button.

Other icons operates as follows.



**Reset**  
Reset all adjustment to previous figure.

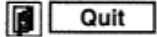

**Quit**  
Closes IMAGE MENU.

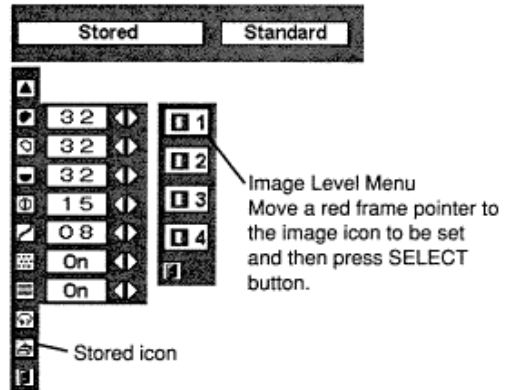

## PICTURE SCREEN ADJUSTMENT

This projector has a picture screen resize function, which enables you to display the desirable image size.

- 1 Press MENU button and ON-SCREEN MENU will appear. Press POINT LEFT/RIGHT button(s) to move a red frame pointer to SCREEN Menu icon.
- 2 Press POINT DOWN button and move a red frame pointer to the function that you want to select and then press SELECT button.

### SCREEN MENU

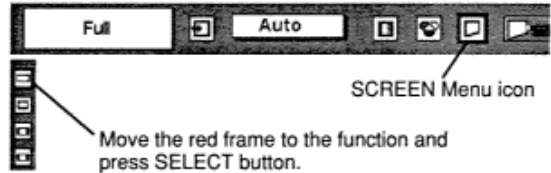

**NOTE :** SCREEN Menu cannot be operated when "720p," "1035i," "1080i-50" or "1080i-60" is selected on SYSTEM Menu (P32).



**Full**  
Provides image to fit width of screen by expanding image width uniformly. This function can be used for providing a squeezed video signal at wide video aspect ratio of 16 : 9. When your video equipment (such as DVD) has 16 : 9 output mode, select 16 : 9 and select Full on this SCREEN Menu to provide better quality.



**Zoom**  
Provides image to fit screen size (16 : 9 aspect ratio) by expanding image width and height uniformly. This function can be used for providing a letter box mode picture (4 : 3 aspect picture with black bar on top and bottom edges) at wide video aspect of 16 : 9.



**Normal**  
Provides image at the normal video aspect ratio of 4 : 3.



**Wide zoom** Provides image to fit width of screen by expanding both sides of image. This function is suitable to provide a normal video signal (4 : 3 aspect ratio) at wide video aspect ratio of 16 : 9.

# SETTING MENU

1 Press MENU button and ON-SCREEN MENU will appear. Press POINT LEFT/RIGHT button(s) to move a red-frame pointer to SETTING icon.

2 Press POINT DOWN button to move a red-frame pointer to the item that you want to set and then press SELECT button. Setting dialog box appears.

## Language

Language used in ON-SCREEN MENU is selectable from among English, German, French, Italian, Spanish, Portuguese, Dutch, Swedish and Japanese.

## Keystone

When the image is distorted vertically, select Keystone. ON-SCREEN Menu disappears and the message "Keystone" is displayed. Correct the Keystone distortion by pressing the POINT UP/DOWN button(s). Refer to KEYSTONE ADJUSTMENT on page 21.

## Blue back

When this function is "On," this projector will produce a blue image instead of the video noise on the screen when the input source is unplugged or turned off.

## Display

This function decides whether to display the On-Screen Displays.  
 On .shows all the On-Screen Displays.  
 Off .sets the On-Screen Displays disappeared except;

- ON SCREEN MENU
- "Power off?" message

## Logo

When this function is "On," projector displays logo when starting up.

## Ceiling

When this function is "On," picture is top / bottom and the left / right reversed. This function is used to project the image from a ceiling mounted projector.

## Rear

When this function is "On," picture is left / right reversed. This function is used to project the image to a rear projection screen.

## SETTING MENU

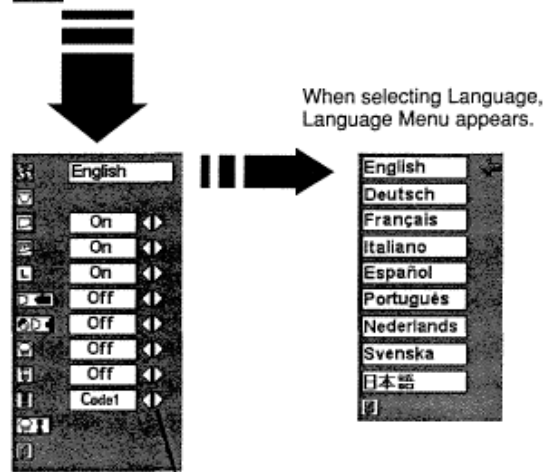
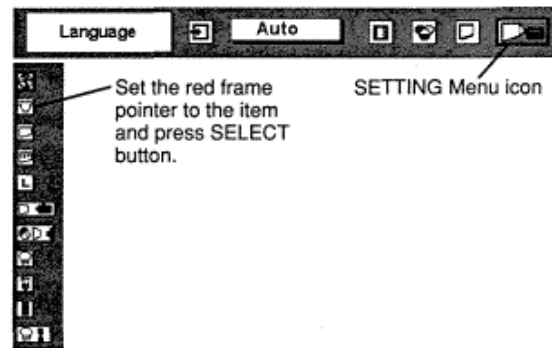

## Ceiling function

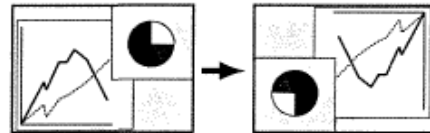

## Rear function

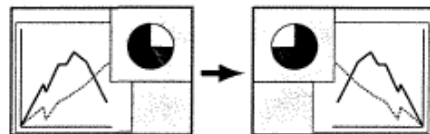



## Power management

This function turns Projection Lamp off when projector detects signal interruption and projector is not used for a certain period in order to reduce power consumption and maintain the Lamp-life. (This projector is shipped with this function ON.)

Power Management function operates to turn Projection Lamp off when the input signal is interrupted and projector is not operated over 5 minutes. This function operates as follows;

1. When the signal is interrupted, "No signal" and the counting down display appears (for 5 minutes).
2. When Projection Lamp turned off, READY Indicator turns off. Cooling Fans operate and Projection Lamp is turned off for 90 seconds. (During this "Cooling Down" period, projector cannot be turned on.)
3. When Projection Lamp has cooled down, READY Indicator flashes and Projection Lamp can be turned on again (Power Management mode).

In this Power Management mode, Projection Lamp is automatically turned on when the input signal connected or projector is operated with any button on the Top Control or on the Remote Control Unit.

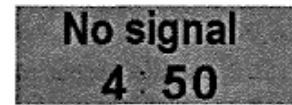

Time left until Lamp off.



## On start

When this function is "On," projector is automatically turned on just by switching MAIN ON / OFF SWITCH on.

Note; Be sure to turn projector off properly (refer to the section "TURNING OFF THE PROJECTOR" on page 20.). If projector is turned off in the wrong steps, On Start function does not operate properly.



## Remote control

This projector has two different remote control codes; the factory-set normal code (Code 1) and the secondary code (Code 2). This switching function prevents the remote control operation mixture (jam) when operating several projectors or video equipment together. When operating projector in "Code 2," both projector and Remote Control must be switched to "Code 2."

### **To change the code of Projector:**

Set the Remote control in the SETTING MENU to "Code 2."

### **To change the code of the Remote Control:**

Press both MENU and NORMAL buttons on the Remote Control Unit together for over 10 seconds.

After changing the code, make sure the Remote Control operates properly.

To return to the normal code (Code 1), operate both projector and Remote Control in the ways above again.

NOTE: When batteries of the Remote Control Unit is replaced, the remote transmit code automatically returns to the normal code (Code 1).

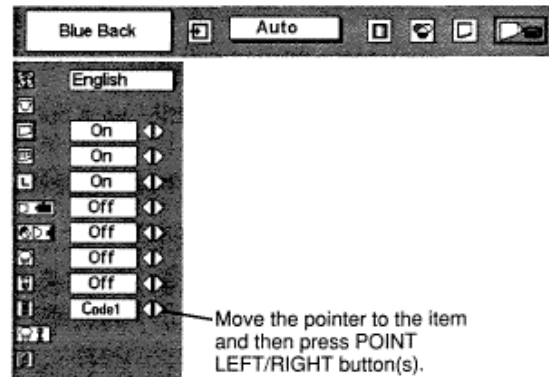

## Lamp counter reset

This function is used to reset Lamp Replace Counter. When replacing Projection Lamp, reset Lamp Replace Counter by using this function. Refer to page 39 for operation

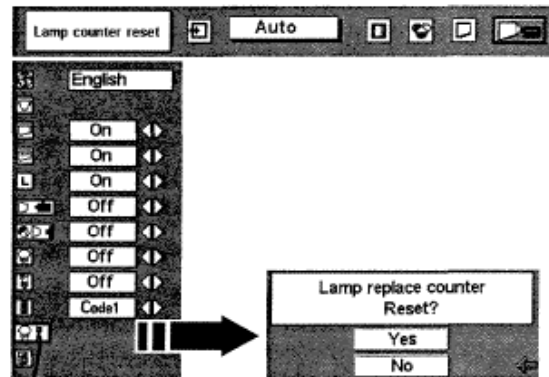

Move the pointer to Lamp counter reset and then press SELECT button. The message "Lamp replace counter reset?" is displayed.

# MAINTENANCE

## WARNING TEMP INDICATOR

**WARNING TEMP.** Indicator flashes red when internal temperature of projector exceeds normal temperature. The Indicator stops flashing when temperature of projector returns to normal. When **WARNING TEMP.** Indicator continues to flash, check the items listed below.

- 1** Ventilation slots of projector may be blocked. In such an event, reposition the appliance so that Ventilation slots are not obstructed.
- 2** Air Filters may be clogged with dust particles. Clean Air Filters by following the section **AIR FILTER CARE AND CLEANING** below.
- 3** If **WARNING TEMP.** Indicator remains on after performing the above checks, Cooling Fans or Internal Circuits may be malfunctioning. Contact a service personnel from an authorized dealer or service station.

## AIR FILTER CARE AND CLEANING

Removable Air Filter prevents dust from accumulating on the surface of Projection Lens and the Projection Mirror. Should Air Filter become clogged with dust particles, it will reduce Cooling Fans' effectiveness and may result in internal heat build up and adversely affect the life of projector. Clean Air Filter following the steps below:

- 1** Turn the power off, and disconnect the AC Power Cord from an AC outlet.
- 2** Turn projector upside down and remove Air Filter Cover by pressing four latches sideways and pulling up. Remove three Air Filters by pulling up the latches.
- 3** Clean Air Filters with brush or wash out the dust and particles. Be sure to dry them out.
-  **4** Replace Air Filters and Air Filter Cover properly. Make sure that they are fully set.

### **CAUTION**

Do not operate projector with Air Filters removed. Dust may accumulate on the LCD Panel and the Mirror degrading picture quality. Do not put small parts into Air Intake Vents. It may result in malfunction of projector.

### **RECOMMENDATION**

**We recommend avoiding dusty/smoky environments when operating projector. Usage in these environments may cause poor image quality.**

When using under dusty or smoky conditions, dust may accumulate on the liquid crystal panel, Projection Lens, or optical elements inside it. This condition may degrade the quality of the projected image. When the above symptoms are noticed, contact your authorized dealer or service station for proper cleaning.

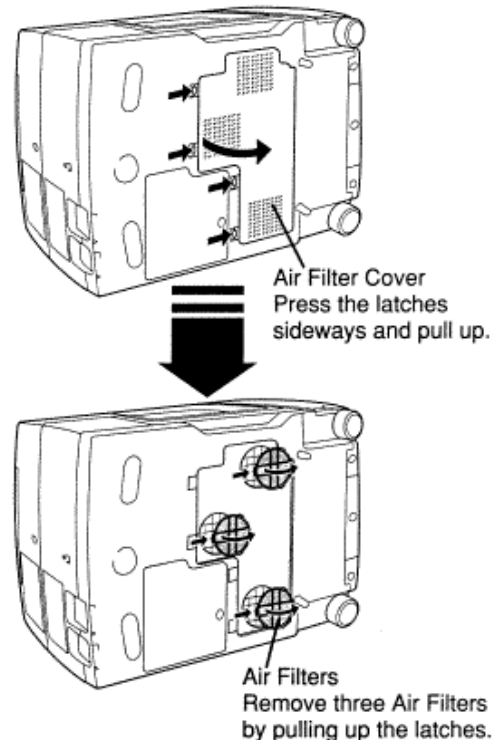

## CLEANING THE PROJECTION LENS

Follow these steps to clean the projection lens:

- 1** Apply a non-abrasive camera lens cleaner to a cleaning cloth. Avoid using an excessive amount of cleaner. Abrasive cleaners, solvents or other soft, dry harsh chemicals might scratch the lens.
- 2** Lightly wipe the cleaning cloth over the lens.
- 3** When projector is not in use, replace the lens cover.

## LAMP REPLACEMENT

When the life of the Lamp of this projector draws to an end, the LAMP REPLACEMENT Indicator lights yellow. When the image becomes dark or the color of the image becomes unnatural, replacement of the Lamp is required.

### **CAUTION**



- For continued safety, replace with a lamp assembly of the same type.
- Allow projector to cool for at least 45 minutes before you open the lamp cover. The inside of projector can become very hot.
- Do not drop the lamp assembly or touch the glass bulb! The glass can shatter and may cause injury.

Follow these steps to replace the lamp assembly.

- 1** Turn off projector and disconnect AC plug. Allow projector to cool for at least 45 minutes.
- 2** Remove a screw with a screwdriver and remove Lamp Cover.
- 3** Remove 2 screws and pull out Lamp Assembly by grasping Handle.
- 4** Replace Lamp Assembly with a new one and tighten 2 screws. Make sure that Lamp Assembly is set properly. Replace Lamp Cover and tighten a screw.
- 5** Connect AC Power Cord to projector and turn on projector.
- 6** Reset Lamp Replace Counter (refer to the section “Lamp Replace Counter” below).

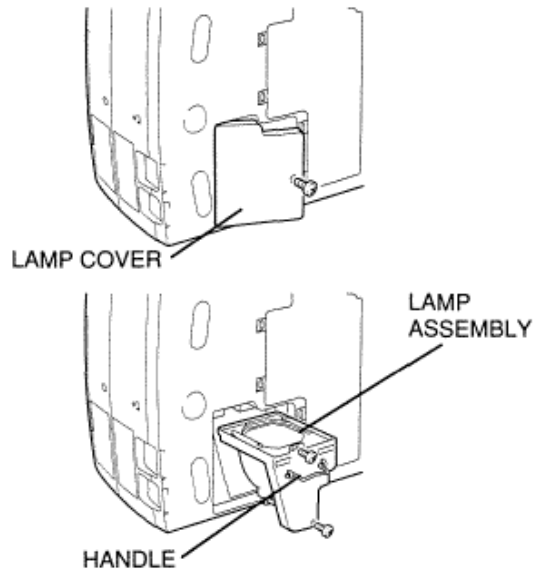

**NOTE:** Do not reset Lamp Replace Counter when Projection Lamp is not replaced.

### **ORDER REPLACEMENT LAMP**

Replacement Lamp can be ordered through your dealer. When ordering the Lamp, give the following information to the dealer.

- Model No. of your projector : LC-VC1
- Replacement Lamp Type No.: POA-LMP28  
(Service Parts No. 610 285 4824)

## LAMP REPLACE COUNTER

Be sure to reset Lamp Replace Counter when Lamp Assembly is replaced. When Lamp Replace Counter is reset, LAMP REPLACE Indicator stops lighting.

- 1.** Turn projector on, press MENU button and ON-SCREEN MENU will appear. Press POINT LEFT/RIGHT button(s) to move a red frame pointer to SETTING Menu icon (refer to page 36, 37).
- 2** Press POINT DOWN button to move a red frame pointer to “Lamp counter reset” and then press SELECT button. The message “Lamp replace counter reset?” is displayed. Move the pointer to and then press SELECT button.
- 3** Another confirmation dialog box appears and select to reset Lamp Replace Counter.

Do not reset Lamp Replace Counter except after Projection Lamp is replaced.

# TROUBLESHOOTING

Before calling your dealer or service center for assistance, check the matters below once again.

1. Make sure you have connected projector to your equipment as described in the section "CONNECTING THE PROJECTOR" on pages 11-13.
2. Check cable connection. Verify that all computer, video and power cords are properly connected.
3. Verify that all power is switched on.
4. If projector still does not produce an image, re-start the computer.
5. If the image still does not appear, unplug projector from the computer and check the computer monitor's display. The problem may be with your graphics controller rather than with projector. (When you reconnect projector, remember to turn the computer and monitor off before you power up projector. Power the equipment back on in order of projector and computer.)
6. If the problem still exists, check the following chart.

Problem:	Try these Solutions
<b>No power.</b>	<ul style="list-style-type: none"> <li>● Plug projector into the AC outlet.</li> <li>● Be sure READY Indicator light is On.</li> <li>● Wait 90 seconds after projector is turned OFF before turning projector back on.</li> </ul> <p>NOTE : After pressing the power ON-OFF switch to OFF, make sure projector works as follows:</p> <ol style="list-style-type: none"> <li>1. The LAMP Indicator will light and the READY Indicator will turn off.</li> <li>2. After 90 seconds, the READY Indicator will light green again and projector may be turned on by pressing the power ON-OFF button.</li> </ol> <ul style="list-style-type: none"> <li>● Check WARNING TEMP. Indicator. If this indicator flashes red, projector cannot be turned on. (See "TURNING ON/OFF THE PROJECTOR" section on page 20.)</li> <li>● Check the Projection Lamp. (Refer to page 39.)</li> </ul>
<b>Image is out of focus.</b>	<ul style="list-style-type: none"> <li>● Adjust the focus</li> <li>● Make sure the projection screen is at least 4.43' (1.35 m) from projector.</li> <li>● Check the projection lens to see if it needs cleaning.</li> </ul> <p>NOTE : Moving projector from a cool temperature location to a warm temperature location may result in moisture condensation on the lens. In such an event, leave projector OFF and wait until condensation disappears.</p>
<b>Picture is Left/Right reversed.</b>	<ul style="list-style-type: none"> <li>● Check Ceiling / Rear feature. (See "SETTING" section on page 36.)</li> </ul>
<b>Picture is Top/Bottom reversed.</b>	<ul style="list-style-type: none"> <li>● Check Ceiling feature. (See "SETTING" section on page 36.)</li> </ul>
<b>Some displays are not seen during the Operation.</b>	<ul style="list-style-type: none"> <li>● Check Display feature. (See "SETTING" section on page 36.)</li> </ul>
<b>No image.</b>	<ul style="list-style-type: none"> <li>● Check the connection between the computer or video equipment and projector.</li> <li>● When turning projector on, it takes about 30 seconds to display the image.</li> <li>● Check the system that you select is corresponding with the computer or the video equipment.</li> <li>● Make sure the temperature is not out of the Operating Temperature (5°C ~ 35°C).</li> </ul>
<b>No sound.</b>	<ul style="list-style-type: none"> <li>● Check audio cable connection from audio input source.</li> <li>● Adjust the audio source.</li> <li>● Press VOLUME (+) button.</li> <li>● Press MUTE button.</li> </ul>



<b>Problem:</b>	<b>Try these Solution</b>
<b>Remote Control Unit does not work.</b>	<ul style="list-style-type: none"> <li>● Check the batteries.</li> <li>● Make sure nothing is between the Remote Receiver and the Remote Control Unit.</li> <li>● Make sure you are not too far from projector when using the Remote Control Unit. Maximum operating range is 16.4' (5m).</li> <li>● Make sure the code of the Remote Control is set to conform to projector. (See "SETTING" section on page 36, 37.)</li> </ul>

**WARNING :**

**High voltages are used to operate this projector. Do not attempt to open the cabinet.**

If the problem still persists after following all operating instructions, contact the sales dealer where you purchased projector or the service center. Give the model number and explain the difficulty. We will advise you how to obtain service.



This symbol on the nameplate means the product is Listed by Underwriters Laboratories Inc. It is designed and manufactured to meet rigid U.L. safety standards against risk of fire, casualty and electrical hazards.

# TECHNICAL SPECIFICATIONS

<b>Projector Type</b>	Multi-media Projector
<b>Dimensions (W x H x D)</b>	12.44" x 6.46" x 18.9" (316mm x 164mm x 480mm)
<b>Net Weight</b>	20.3 lbs (9.2 kg)
<b>LCD Panel System</b>	1.35" TFT Active Matrix type, 3 panels
<b>Panel Resolution</b>	1366 x 768 dots
<b>Number of Pixels</b>	3,147,264 (1366 x 768 x 3 panels)
<b>Color System</b>	PAL, SECAM, NTSC, NTSC4.43, PAL-M and PAL-N
<b>High Definition TV Signal</b>	480i, 480p, 575i, 575p, 720p, 1035i, 1080i-50 and 1080i-60
<b>Scanning Frequency</b>	H-sync. 15 ~ 100 KHz, V-sync. 50 ~ 100 Hz
<b>Projection Image size (Diagonal)</b>	Adjustable from 31" to 400"
<b>Horizontal Resolution</b>	800 TV lines
<b>Projection Lens</b>	F 1.8 ~ 2.1 lens with f 48.4 mm ~ 62.8 mm with motor zoom, focus and shift
<b>Throw Distance</b>	4.43' ~ 45.9' (1.35 m ~ 14.0 m)
<b>Projection Lamp</b>	250 W
<b>Computer / AV Input Jacks</b>	INPUT 1 : HDB 15 pin Type Terminal INPUT 2 : BNC Type Jacks (Video/Y, C/Pb(Cb), Pr(Cr)) / (G, B, R, H, V) Mini DIN 4 pin Type Jack (S-Video) INPUT 3 : RCA Type Jacks (Video/Y, Pb(Cb), Pr(Cr))
<b>Audio Input Jacks (Input 1/2/3)</b>	RCA Type Jacks (R and L(mono)) x 3
<b>Serial Port Terminal</b>	HDB 9 pin Type Terminal
<b>R/C Jack</b>	Mini Jack
<b>Audio Output Jacks</b>	RCA Type Jacks (R and L)
<b>External Speaker Jack</b>	35 mm Mini Jack (8 $\Omega$ 2 W / stereo)
<b>Internal Audio Amp</b>	2.0 W RMS (stereo)
<b>Built-in Speakers</b>	2 speakers, 1.57" x 2.76" (40mm x 70mm)
<b>Feet Adjustment</b>	0' to 9.0"
<b>Voltage and Power Consumption</b>	AC 100 ~ 120 V (4.4 A Max. Ampere), 50 / 60 Hz (The U.S.A and Canada) AC 200 ~ 240 V (2.2 A Max. Ampere), 50 / 60 Hz (Continental Europe)
<b>Operating Temperature</b>	41 °F ~ 95 °F (5 °C ~ 35 °C)
<b>Storage Temperature</b>	14 °F ~ 140 °F (-10 °C ~ 60 °C)
<b>Remote Control Transmitter</b>	Power Source : AA, UM3 or R06 Type x 2 Operating Range : 16.4' (5m) / $\pm$ 30° Dimensions : 1.8" x 0.75" x 6.7" (45mm x 19mm x 170mm) Net Weight : 0.20 lbs (92 g) (including batteries)
<b>Accessories</b>	Owner's Manual AC Power Cord Wired/Wireless Remote Control Transmitter and Batteries Video Cable (RCA x 1) Audio Cable (RCA x 2) S-Video Cable Remote Control Cable Dust Cover Lens Cover

- The specifications are subject to change without notice.

# CONFIGURATIONS OF TERMINALS

## RGB TERMINAL

Terminal HDB1 5-PIN

Connect the display output terminal of computer to this terminal with VGA Cable (not supplied). When connecting the Macintosh computer, the MAC Adapter (not supplied) is required.

### Pin Configuration

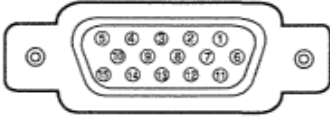

1	Red Input	9	No Connect
2	Green Input	10	Ground (Vert.sync.)
3	Blue Input	11	Sense 0
4	Sense 2	12	Sense 1
5	Ground (Horiz.sync.)	13	Horiz. sync.
6	Ground (Red)	14	Vert. sync.
7	Ground (Green)	15	Reserved
8	Ground (Blue)		

## SERIAL TERMINAL

Terminal HDB9-PIN

Connect the serial port of computer to this terminal with Serial Cable (not supplied).

### Pin Configuration

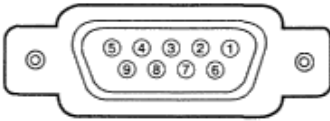

1	No Connect	6	No Connect
2	R x D	7	RTS
3	T x D	8	CTS
4	No Connect	9	No Connect
5	Ground		

# EIKI

## Audio Visual/Video Products

### **EIKI INTERNATIONAL, INC.**

26794 Vista Terrace Drive, Lake Forest,  
CA. 92630-8113, U.S.A.  
TEL (949) 457-0200 FAX (949) 457-7878

### **EIKI CANADA**

310 First Street, Unit 2 P.O. Box 156  
Midland Ontario L4R 4K8 Canada  
TEL (705) 527-4084 FAX (705) 527-4087

### **EIKI DEUTSCHLAND GMBH**

AM Frauwald 12 65510 Idstein  
Germany  
TEL (6126)9371-0 FAX (6126) 9371-11

### **EIKI CZECH SPOL. S.R.O.**

Umelccka 15, 170 00 Praha 7 Holesovice  
Czech Republic  
TEL (2) 20571413 FAX (2) 20571411

### **EIKI INDUSTRIAL CO., LTD**

4-12 Banzai-cho, Kita-Ku  
Osaka, Japan  
TEL (6) 6311-9479 FAX (6) 6311-8486