



**ENG**

AK68-00029F

# DVD PLAYER

## DVD-C5050

# Precautions

## 1. Setting up

Ensure that the mains supply in your house complies with that indicated on the identification sticker located at the back of your player. Install your player horizontally, on a suitable base (furniture), with enough space around it for ventilation (7~10cm). Make sure the ventilation slots are not covered. Do not stack other, or heavy devices on top over the player. Do not place the player on amplifiers or other equipment which may become hot. Before moving the player ensure the disc tray empty. This player is designed for continuous use. Switching off the DVD player to the stand-by mode does not disconnect the electricity supply. In order to separate the player completely from the mains, it has to be disconnected by unplugging the main plug, especially when left unused for a long period of time.

## 2. Caution

Protect the player from moisture (dripping or splashing and that no objects filled with liquids, such as vases, shall be placed on the player), and excess heat (e.g. fireplace) or equipment creating strong magnetic or electric fields (i.e. speakers...) disconnect the power cable from the mains electricity supply if the player malfunctions. Your player is not intended for industrial use but for domestic purposes only. Use of this product is for personal use only. Condensation If your player or disc have been stored in a cold atmosphere, as for example during transportation in the winter, wait for approximately 2 hours until they have reached room temperature.

## 3. For your safety

Never open the player or any of its components. It can be dangerous for you or certain fragile components. You could receive an electric shock or touch the laser beam. Do not place your eyes close to the opening of the disc tray or any other opening to look inside the player.

## 4. Disc

Be careful handle your discs with care. Hold a disc with finger on the border or hole. Always place disc with the label facing upward (in case of a single side disc). Always use a soft cloth to clean disc if necessary, wipe from the centre to the border. Always put disc back into their cases after playing and store in vertical position. Always place the disc properly into the tray using the proper guide area. Never use record cleaning sprays, benzene, static electricity liquids or any other solvent, if the disc surface is dirty. Wipe gently with a soft damp (water only) cloth, never wipe the disc in a circular motion, since circular scratches are likely to occur and could cause noise during playback.

## 5. Battery

The battery used in this product contains the chemicals that are harmful to the environment. Do not dispose of batteries in the general household waste. It is recommended that the replacement of the battery should be done by technician.

## 6. Maintenance of cabinet

For safety reasons, be sure to disconnect the AC power cord from the AC outlet.

- Do not use benzene, thinner, or other solvents for cleaning.
- Wipe the cabinet with a soft cloth.

# Precautions

1

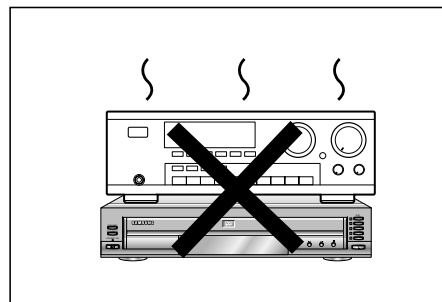
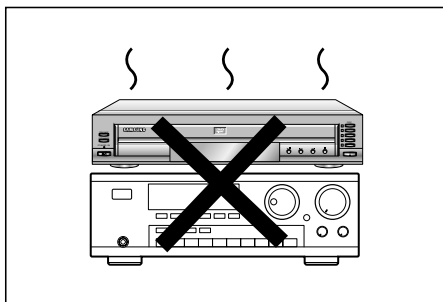
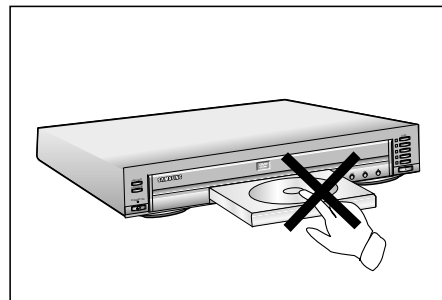
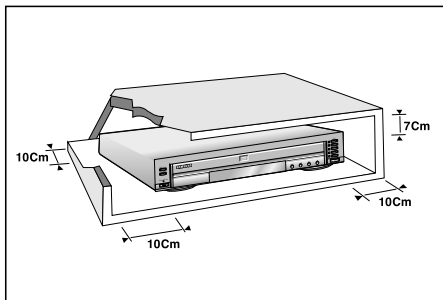

2

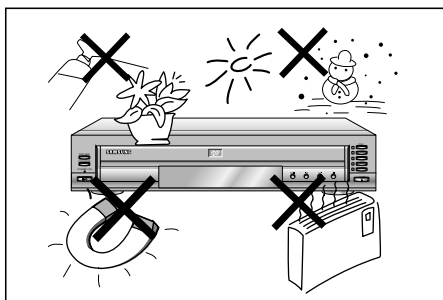

3

CAUTION	LASER RADIATION WHEN OPEN DO NOT STARE INFO BEAM
ATTENTION	RAYONEMENT LASER EN CAS D'OUVERTURE. NE PAS REGARDER DANS LE FAISCEAU.
VORISICHT	LASERSTRAHLUNG, WENN ABDECKUNG GEÖFFNET, NICHT IN DEN STRAHL BLICKEN.
ADVARSEL	LASERSTRÅLING VED ÅBNING. SE IKKE IND I STRÅLEN.
VARNING	LASERSTRÅLING NÄR DENNA DEL ÄR ÖPPNAD. STIRRA EJ IN STRÅLEN.
VARO!	AVATTAESSA OLET ALTITINA LASERSÄTEILYLLE. ÄLÄ TUJOTA SÄTEESEEN.
WAARSCHYWG	LASERSTRALING INDIEN GEOPEND, KIJK NIET IN DE STRAAL.

CLASS 1  
LASER PRODUCT

4

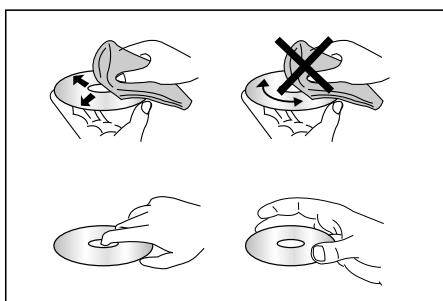

5

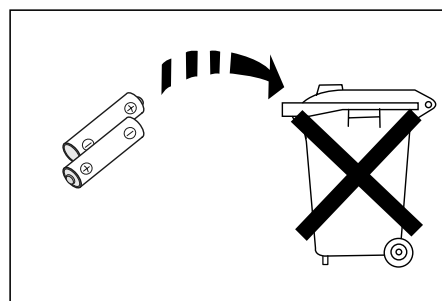

# Before You Start

## Accessories



Remote Control

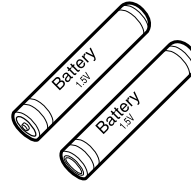

Batteries for Remote Control  
(AA Size)

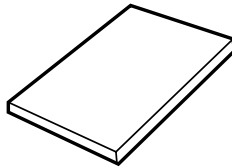

User's Manual

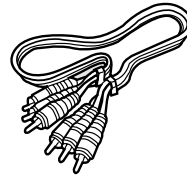

Video/Audio Cable

### Install Batteries in the Remote

- 1** Open the battery cover on the back of the remote.
- 2** Insert two AA batteries. Make sure that the polarities (+ and -) are aligned correctly.
- 3** Replace the battery cover.

### If remote doesn't operate properly:

- Check the polarity + - of the batteries (Dry-Cell)
- Check if the batteries are drained.
- Check if remote sensor is blocked by obstacles.
- Check if there is any fluorescent lighting nearby.

# TABLE OF CONTENTS

General Features .....	6
Disc Type and Characteristics .....	7
Description-Front Panel .....	8
Description-Rear Panel .....	9
Tour of the Remote Control .....	10
Choosing a Connection .....	12
Playing a Disc .....	14
Operating the Disc Changer .....	16
Using the Search & Skip Functions .....	17
Using the Display Function .....	18
Repeat Play .....	19
Program Play & Random Play .....	20
S.FIT Play .....	21
Digest Play .....	22
Using the Disc View Function .....	23
Slow Repeat play .....	24
Selecting the Audio Language .....	25
Selecting the Subtitle Language .....	26
Changing the Camera Angle .....	27
Using the Instant Replay Function .....	28
Using the Bookmark Function .....	29
Using the Zoom & 3D Sound Functions .....	30
MP3 Play .....	31
Using the Setup Menu .....	33
Setting Up the Language Features .....	34
Setting Up the Parental Control .....	36
Setting Up the Audio Options .....	37
Setting Up the Display Options .....	38
Controlling a TV with the Remote .....	39
Troubleshooting .....	40
Specifications .....	41

SETUP

CONNECTIONS

BASIC  
FUNCTIONS

ADVANCED  
FUNCTIONS

CHANGING  
SETUP MENU

REFERENCE

# General Features

## DVD Changer

The DVD Changer holds 5 discs and provides full random play with fast disc changes.

## Excellent Sound

Dolby Digital, a technology developed by Dolby Laboratories provides crystal clear sound reproduction.

## Screen

Both regular and widescreen(16:9) pictures can be viewed.

## Slow Motion

An important scene can be viewed in slow motion.

## Programmed Play

You can program tracks to play in desired order.

## Parental Control

The parental control allows users to set the level necessary to prohibit children from viewing harmful movies such as those with violence, adult subject matter, etc.

## Various On-Screen Menu Functions

You can select various languages(Audio/Subtitle) and screen angles while enjoying movies.

## Repeat

You can repeat a song or movie simply by pressing the REPEAT button.

## MP3

This unit can play discs created from MP3 files.

## Instant Replay

This function is used to replay the previous 10 seconds of the movie from the current position.

### NOTE

\* Discs which cannot be played with this player :

- DVD-ROM
- DVD-RAM
- CD-ROM
- CDV
- CDI
- HD layer of super Audio CD
- CDGs play audio only, not graphics.

\* Ability to play back may depend on recording conditions :

- DVD-R
- CD-RW
- DVD+RW, -RW



## COPY PROTECTION

- Many DVD discs are encoded with copy protection. Because of this, you should only connect your DVD player directly to your TV, not to a VCR. Connecting to a VCR results in a distorted picture from copy-protected DVD discs.
- This product incorporates copyright protection technology that is protected by methods claims of certain U.S. patents and other intellectual property rights owned by Macrovision Corporation and other rights owners. Use of this copyright protection technology must be authorized by Macrovision Corporation, and is intended for home and other limited viewing uses only unless otherwise authorized by Macrovision Corporation. Reverse engineering or disassembly is prohibited.

# Disc Type and Characteristics

This DVD player is capable of playing the following types of discs with the corresponding logos:

SETUP

Disc Types (Logos)	Recording Types	Disc Size	Max. Playing Time	Characteristics
<b>DVD</b> 	Audio + Video	12Cm	Single-sided 240 min. Double-sided 480 min.	<ul style="list-style-type: none"> <li>DVD contains excellent sound and video due to Dolby Digital and MPEG-2 system.</li> <li>Various screen and audio functions can be easily selected through the on-screen menu.</li> </ul>
		8Cm	Single-sided 80 min. Double-sided 160 min.	
<b>VIDEO-CD</b> 	Audio + Video	12Cm	74 min.	<ul style="list-style-type: none"> <li>Video with CD sound, VHS quality &amp; MPEG-1 compression technology.</li> </ul>
		8Cm	20 min.	
<b>AUDIO-CD</b> 	Audio	12Cm	74 min.	<ul style="list-style-type: none"> <li>CD is recorded as a Digital Signal with better audio quality, less distortion and less deterioration of audio quality over time.</li> </ul>
		8Cm	20 min.	

## Disc Markings



• Play Region Number



• PAL broadcast system in U.K, France, Germany, etc.



• Dolby Digital disc



• Stereo disc



• Digital Audio disc



• DTS disc



• MP3 disc

## Play Region Number

Both the DVD player and the discs are coded by region. These regional codes must match in order for the disc to play. If the codes do not match, the disc will not play.

The Region Number for this player is described on the rear panel of the player.

# Description-Front Panel

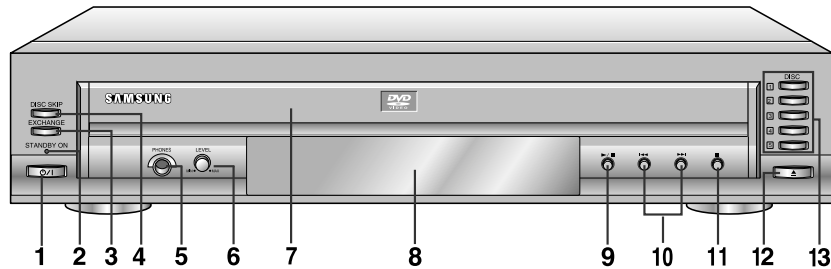

## Front Panel Controls

1. **STANDBY/ON**
  - Use to turn your player on and off (standby).
2. **STANDBY LAMP**
  - When the unit is first plugged in, the indicator lights. When power is pressed on, the lamp goes out.
3. **EXCHANGE**
  - Press this button when you want to change a disc without stopping playback of the current disc.
4. **DISC SKIP**
  - Use to skip a disc in order.
5. **HEADPHONES JACK**
  - You can attach headphones here for private listening.
6. **VOLUME LEVEL**
  - Use to adjust headphones volume level.
7. **DVD CHANGER(TRAY)**
  - Press OPEN/CLOSE to open and close the disc changer.
8. **FRONT DISPLAY**
  - Operation indicators are displayed here.
9. **PLAY/PAUSE**
  - Begin or pause disc play.
10. **SKIP/SEARCH**
  - Use to skip or search a scene or music.
11. **STOP**
  - Stops disc play.
12. **OPEN/CLOSE**
  - Press to open and close the disc tray.
13. **DISC SELECT**
  - Use to select the desired disc loaded in the DVD CHANGER.

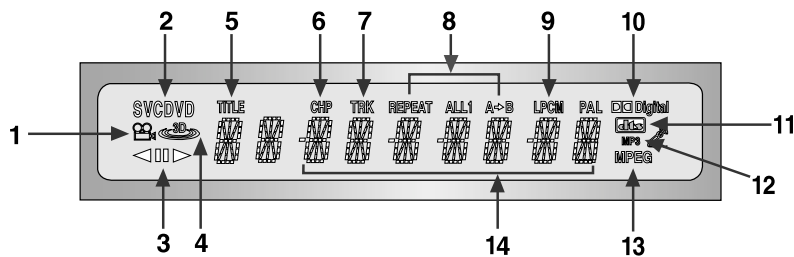

## Front Panel Display

1. Angle indicator. You can select multiple angles of a scene recorded by different cameras.
2. Disc type indicators
3. Reverse play / Pause / Forward play
4. Lights when 3D surround is turned on.
5. DVD : Title number
6. DVD : Chapter number.
7. Video/Audio CD : Track number
8. Repeat play mode
9. Linear PCM audio output
10. Dolby Digital Disc
11. DTS (Digital Theater System) output
12. MP3 indicator
13. MPEG-2 Audio output
14. Displays various messages concerning operations such as PLAY, STOP, LOAD, ...
  - no DISC** : No disc loaded.
  - OPEN** : The disc tray is open.
  - LOAD** : Player is loading disc information.



# Description-Rear Panel

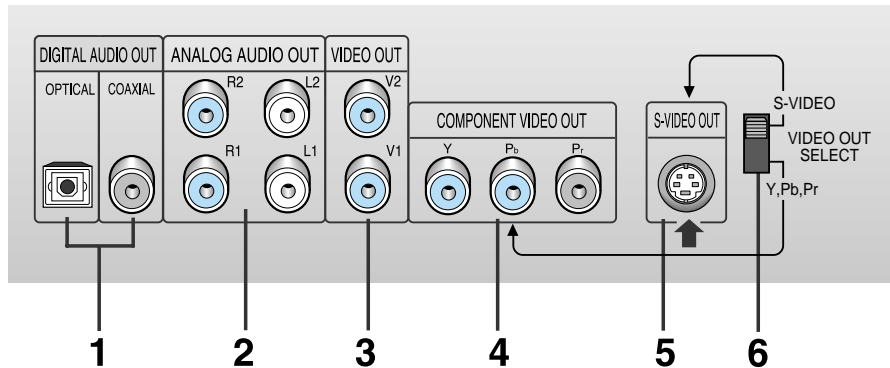

SETUP

## Rear Panel

- 1. DIGITAL AUDIO OUT JACKS**
  - Use either an optical or coaxial digital cable to connect to a compatible Dolby Digital receiver. Use to connect to an A/V Amplifier that contains a Dolby Digital or DTS decoder.
- 2. ANALOG AUDIO OUT JACKS**
  - Connect to the Audio input jacks of your television, audio/video receiver, or VCR.
- 3. VIDEO OUT JACKS**
  - Use a video cable to connect to the Video input jack on your television.
- 4. COMPONENT VIDEO OUT JACKS**
  - Use these jacks if you have a TV with Component Video in jacks. These jacks provide Pr, Pb and Y video. Along with S-Video, Component Video provides the best picture quality. The Y, Pb, Pr must be selected in the VIDEO OUT SELECT.
- 5. S-VIDEO OUT JACK**
  - Use the S-Video cable to connect this jack to the S-Video jack on your television for a higher quality picture. The S-Video must be selected in the VIDEO OUT SELECT.
- 6. VIDEO OUT SELECT SWITCH**
  - Use the switch to set video out.
  - If Y, Pb or Pr is selected, S-Video will not work.
  - If S-Video is selected, Y, Pb or Pr will not work.

### NOTE

- Select the VIDEO OUT SELECT switch in the STOP or Power off mode.

# Tour of the Remote Control

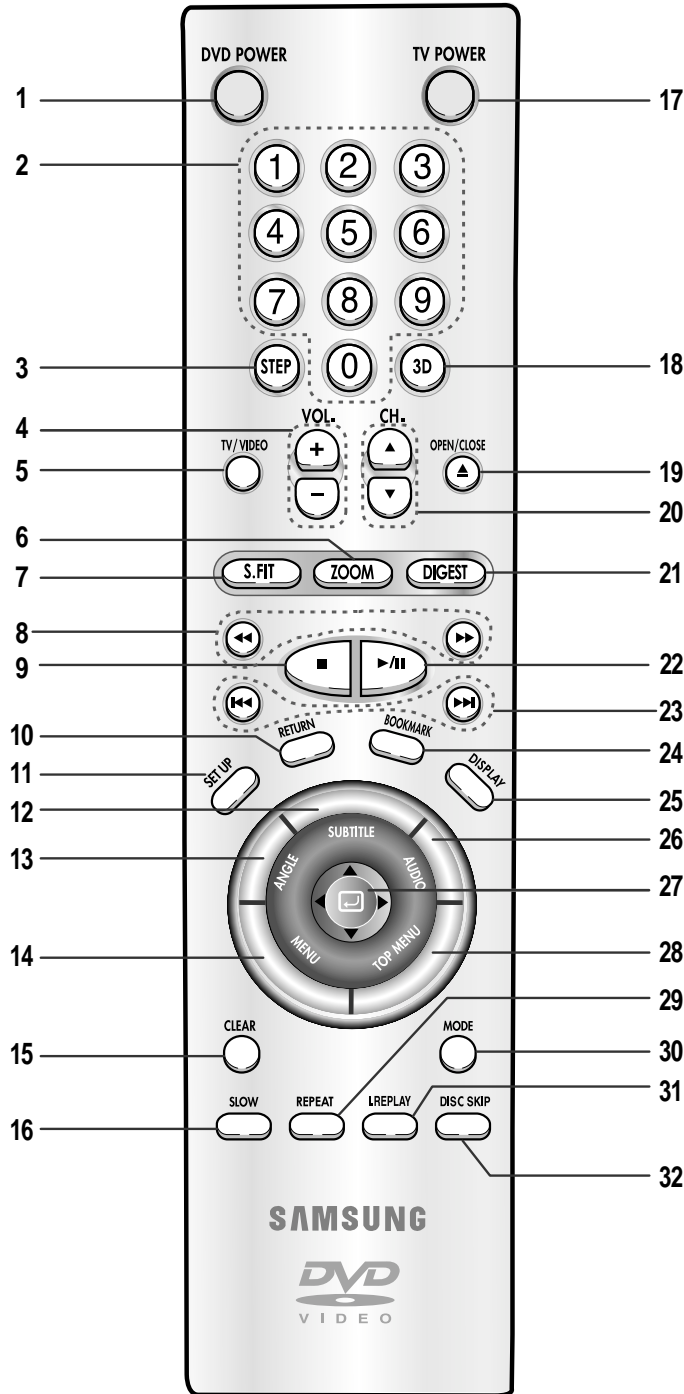

# Tour of the Remote Control

## DVD Function Buttons

1. **DVD POWER Button**
2. **NUMBER Buttons**
3. **STEP Button**
  - Advances play one frame at a time.
4. **VOLUME Buttons**
5. **TV/VIDEO Button**
6. **ZOOM Button**
7. **S.FIT Button**
8. **SEARCH Buttons**
  - Allows you to search forward/backward through a disc.
9. **STOP Button**
10. **RETURN Button**
  - Returns to a previous menu.
11. **SETUP Button**
  - Brings up the DVD player's Setup menu.
12. **SUBTITLE Button**
13. **ANGLE Button**
  - Use to access various camera angles on a DVD.
14. **MENU Button**
  - Brings up the Disc menu.
15. **CLEAR Button**
  - Use to remove menus or status displays from the screen.
16. **SLOW Button**
17. **TV POWER Button**
18. **3D Button**
19. **OPEN/CLOSE Button**
20. **CHANNEL Buttons**
21. **DIGEST Button**
22. **PLAY/PAUSE Button**
  - Begin/Pause disc play.
23. **SKIP Buttons**
  - Use to skip the title, chapter, or track.
24. **BOOKMARK Button**
25. **DISPLAY Button**
  - Displays the current disc mode.
26. **AUDIO Button**
  - Use this button to access various audio functions on a disc.
27. **ENTER/DIRECTION Button (UP/DOWN or LEFT/RIGHT Button)**
  - This button functions as a toggle switch.
28. **TOP MENU Button**
  - Takes you to the menu on the DVD disc or CD/VCD.
29. **REPEAT Button**
  - Allows you to repeat play a title, chapter, track, or disc.
30. **MODE Button**
  - Allows you to program a specific order.
31. **I. REPLAY Button**
  - This function is used to replay the previous 10 seconds of the movie from the current position.
32. **DISC SKIP**
  - Use to skip a disc in order.

SETUP

# Choosing a Connection

The following show examples of connections commonly used to connect the DVD player with a TV and other components.

## Before Connecting the DVD Player

- Always turn off the DVD player, TV, and other components before you connect or disconnect any cables.
- Refer to the owner's manual of the additional components you are connecting for more information on those particular components.

## Connection to an Audio System

Method 1

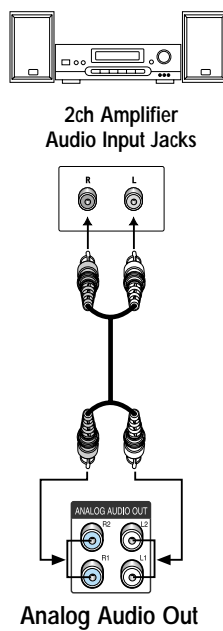

Method 2

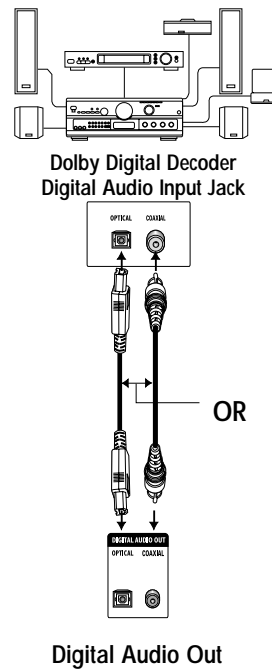

AUDIO

DVD

# Choosing a Connection

## Connection to a TV (For Video)

TV (Normal, Widescreen, Projection, etc..)

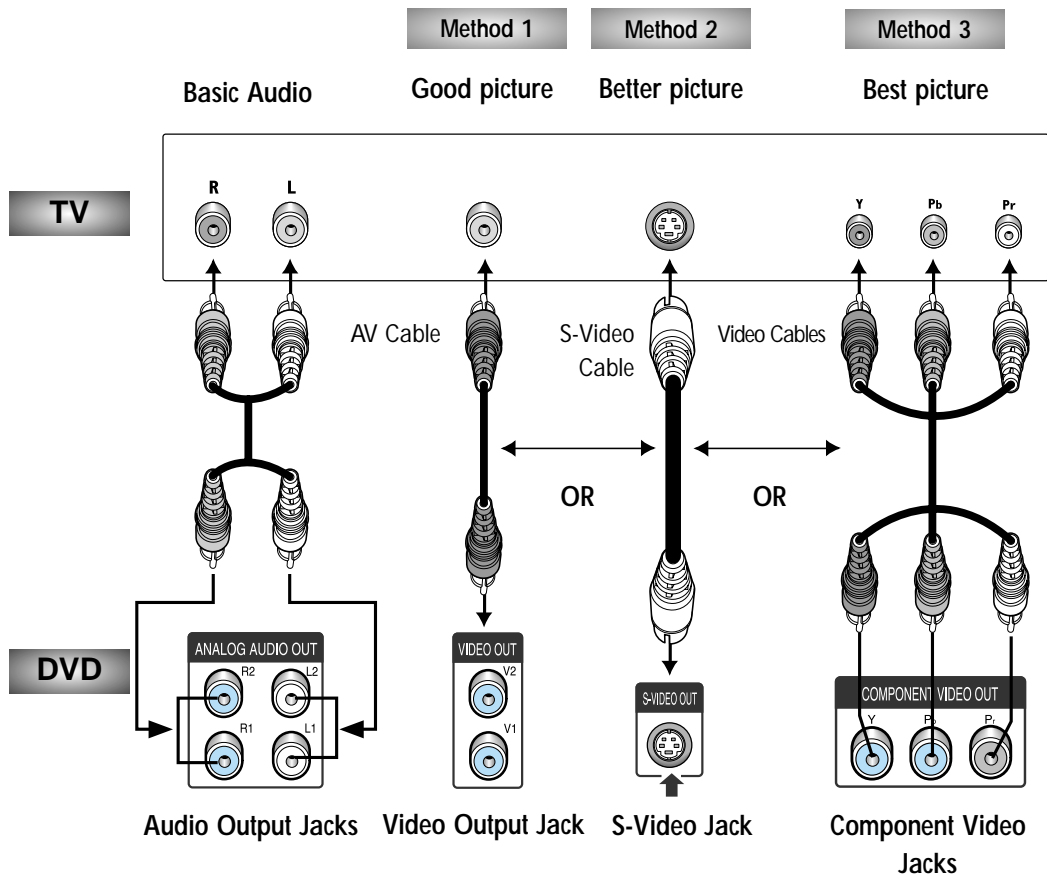

CONNECTIONS

- **Method 1** DVD Player + TV with Video Input Jack
- **Method 2** DVD Player + TV with S-Video Input Jack  
(If S-Video is selected in the VIDEO OUT SELECT.)
- **Method 3** DVD Player + TV with Component Video Jacks  
(If Y, Pb or Pr is selected in the VIDEO OUT SELECT.)

### NOTE

- If Y, Pb or Pr is selected, S-Video will not work.
- If S-Video is selected, Y, Pb or Pr will not work.

# Playing a Disc

## Before Play

- Turn on your TV and press the TV/VIDEO button to select the video mode.
- Turn on your Audio System and select AUX, CD or DVD.

After plugging in the player, the first time you press the DVD POWER button, this screen comes up :

If you want to select the language, press a NUMBER button.

(This screen will only appear the very first time you plug in the player.)

### SELECT MENU LANGUAGE

Press	1	for English
Touche	2	pour Français
Drücke	3	für Deutsch
Pulsar	4	para Español
Premere	5	per Italiano
Toets	6	voor Nederlands

## Play

- 1 Press the OPEN/CLOSE button.  
The STANDBY indicator light goes out and the tray opens.
- 2 Place a disc gently into the tray with the disc's label facing up.
- 3 Press the PLAY/PAUSE button or OPEN/CLOSE button to close the disc tray.
- 4 Stopping Play  
Press the STOP button during play.
- 5 Removing Disc  
Press the OPEN/CLOSE button.
- 6 Pausing Play  
Press the PLAY/PAUSE or STEP button on the remote during play.
  - Screen stops, no sound.
  - To resume again, press PLAY/PAUSE button once again.

## Playing a Disc

### 7 Step Motion Play (Except CD)

Press the STEP button on the remote during play.

- Each time the button is pressed, a new frame will appear.
- No sound is heard during STEP mode.
- Press PLAY/PAUSE to resume normal play.

(You can only perform step motion play in the forward direction.)

### 8 Slow Motion Play (Except CD)

Press the FWD SEARCH or REV SEARCH button on the remote during PAUSE or STEP mode.

- By pressing the FWD SEARCH or REV SEARCH button, you can select slow motion play for 1/8, 1/4 or 1/2 of normal speed.
- No sound is heard during slow mode.
- Press PLAY/PAUSE to resume normal play.
- When playing a VCD, the reverse slow motion play will not work.

#### RESUME function

When you stop disc play, the player remembers where you stopped, so when you press PLAY again, it will pick up where you left off. (unless the disc is removed, the STOP button is pressed twice or the player is unplugged.)

#### NOTE

- If the player is left for 5 minutes in pause mode, it will stop.
- If the player is left in the stop mode for more than 30 minutes, the power will automatically shut off. (Automatic Power - Off Function)
- If the player is left in the stop mode for more than one minute without any user interaction, a screen saver will be activated, and the TV screen will fade in and out repeatedly. Press the PLAY button to resume normal play.
- This  icon indicates an invalid button press.

# Operating the Disc Changer

The DVD Changer holds 5 discs and provides full random play with fast disc changes.

## Exchanging Discs

Exchange allows you to change up to 4 discs except the disc currently playing.

- 1** Press the EXCHANGE button on the front of the player when in the play mode. The tray opens with two slots available for you to load or change discs.
- 2** Press the DISC SKIP button on the remote or on the front of the player to turn the platter to the other two slots. Load or change the third and fourth discs.
  - To change all the discs, first press the STOP button, then the OPEN/CLOSE and DISC SKIP buttons.
- 3** Press the EXCHANGE, OPEN/CLOSE or the desired number's DISC SELECT button on the front of the player to close the disc tray.



DISC EXCHANGE

## Using the DISC SKIP function

Use the Disc Skip function to change to another of the discs currently in the disc platter.

- 1** While in play or stop mode, press the DISC SKIP button. The platter turns clockwise to the next available disc.
- 2** To directly select a disc, press the desired number of the DISC SELECT buttons on the front of the unit to play back the disc in the desired number's slot.
  - Empty disc slots are automatically skipped during disc skip.



# Using the Search & Skip Functions

During play, you can search quickly through a chapter or track or use the skip function to jump to the next selection.

## Searching through a Chapter or Track

**1** During play, press the FWD SEARCH (▶▶) or REV SEARCH (◀◀) button on the remote.

- Press the REVERSE or FORWARD SEARCH button on the remote and press again to search at a faster speed on the DVD, VCD, CD.

DVD	2X, 4X, 8X, 16X, 32X, 128X
VCD	4X, 8X
CD	2X, 4X, 8X

- Depending on the disc, audio may not be heard when a disc is in 2X play mode.

## Skipping Tracks

**1** During play, press the NEXT SKIP(▶▶) or BACK SKIP(◀◀) button.

- When playing a DVD, if you press the NEXT SKIP button, it moves to the next chapter. If you press the BACK SKIP button, it moves to the beginning of the chapter.  
One more press makes it move to the beginning of the previous chapter.
- When playing a VCD 2.0 in MENU OFF mode, a VCD 1.1 or a CD, if you press the NEXT SKIP button, it moves to the next track.  
If you press the BACK SKIP button, it moves to the beginning of the track. One more press makes it move to the beginning of the previous track.
- If a track exceeds 15 minutes when playing a VCD and you press the NEXT SKIP button, it moves forward 5 minutes.  
If you press the BACK SKIP button, it moves backward 5 minutes.
- When playing a VCD 2.0 in the MENU OFF or Track View function, if you press the NEXT SKIP button, it moves to the next MENU or the next Track View display.  
If you press the BACK SKIP button, it moves to the previous MENU or the previous Track View display. (See page 23.)

# Using the Display Function

## When Playing a DVD

**1** During play, press the DISPLAY button on the remote.

- Current title, chapter number, elapsed time, audio, subtitle and volume control will be displayed.
- Use the NUMBER buttons to enter a different title, then press the ENTER button.
- Use the LEFT/RIGHT or NUMBER buttons to enter a chapter number, then press the ENTER button.
- To enter the time from which you want to start, use the UP/DOWN buttons to select, then use the NUMBER buttons to enter the time. Then press the ENTER button.
- Use the LEFT/RIGHT buttons to change the values of the current audio, subtitle and volume.
- To make the screen disappear, press the DISPLAY button again.

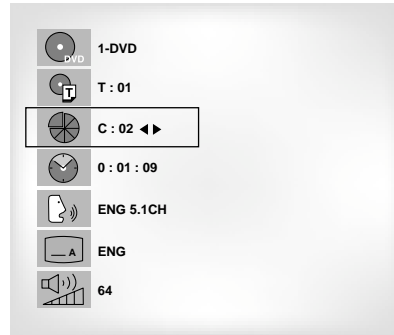

## When Playing a CD/VCD

**1** During play, press the DISPLAY button on the remote.

- Current track number, elapsed time and volume control will be displayed.
- Use the UP/DOWN buttons to select a track. Use the LEFT/RIGHT buttons or NUMBER buttons to enter a different track number, then press the ENTER button.
- To enter the time from which you want to start, use the UP/DOWN buttons to select, then use the NUMBER buttons to enter the time. Press the ENTER button.
- To change the value of the volume, use the LEFT/RIGHT buttons.
- To make the screen disappear, press the DISPLAY button again.
- \* In VCD 2.0 mode (MENU ON mode), only the volume control will appear on screen.

VCD

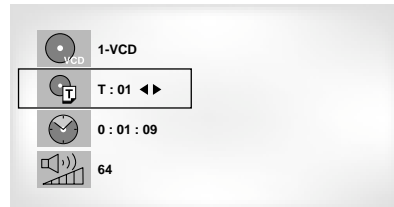

CD

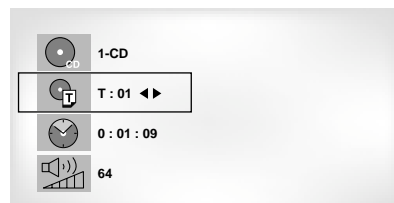

### NOTE

- **What is a Chapter?**  
Each Title on a DVD is usually divided into chapters (similar to tracks on an audio CD).
- **What is a Title?**  
A DVD may contain several different titles. For example, if a disc contains four different movies, each might be considered a title.

# Repeat Play

Repeat the current track, chapter, title, a chosen section (A-B), or all of the disc.

## When playing a DVD

- 1 Press the REPEAT button on the remote. Repeat screen appears.
- 2 Select Chapter, Title or A-B using the LEFT/RIGHT buttons.
  - Repeat A-B
  - Press the REPEAT button. Select A-B on screen with the LEFT/RIGHT buttons or press the A-B button on the remote.
  - Press ENTER at the point where you want the repeat play to start (A). The B is automatically highlighted.
  - Press ENTER at the point where you want the repeat play to stop (B).
- 3 Press ENTER.
- 4 To return to normal play, press REPEAT again, then press the LEFT/RIGHT buttons to select Off and press ENTER.

DVD

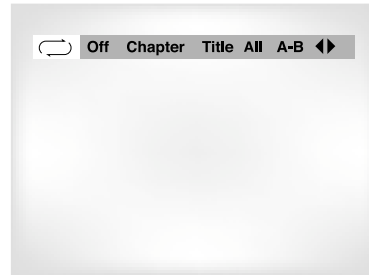

VCD/CD

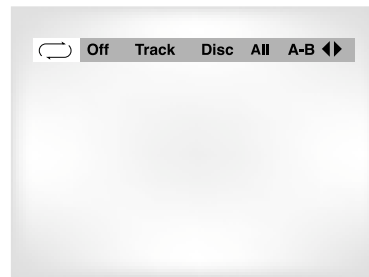

BASIC  
FUNCTIONS

### NOTE

- DVD repeats play by chapter or title, CD and VCD repeat play by disc or track. See page 31 to MP3 disc repeat play.
- Depending on the disc, the Repeat function may not work.
- If the title or track is completed before marking the end (B), the end of title or track becomes B automatically.
- When in VCD 2.0 mode (MENU ON mode), this function does not work.

# Program Play & Random Play

## Program Play (DVD/VCD/CD)

- 1 Press the MODE button.
- 2 Use the LEFT/RIGHT buttons to select PROGRAM. Press the ENTER button.  
All discs in the unit will be read first.
- 3 Use the LEFT/RIGHT buttons to select the first chapter (or track) to add to the program. Press the ENTER button. The selection numbers appear in the Program Order box.
- 4 Press the PLAY/PAUSE button. The disc will be played in programmed order.
  - Use the DISC SKIP key to program another disc.

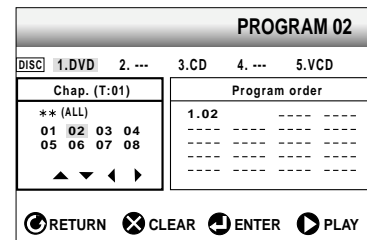
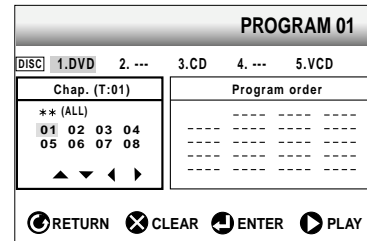

## Random Play (DVD/VCD/CD)

- 1 Press the MODE button.
- 2 Use the LEFT/RIGHT buttons to select RANDOM. Press the ENTER button.
- 3 Press Left/Right buttons to select All discs or Disc. The disc(s) will be played in random order.

### NOTE

- Depending on the disc, the Program and Random Play function may not work.
- When in VCD 2.0 mode (MENU ON mode), these functions do not work.
- To resume normal play, press the CLEAR button.
- Random Play can only operate when the discs are the same type.

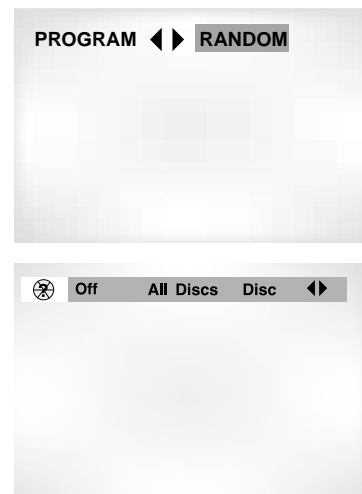

# S.FIT Play

## Screen Fit Play

- 1 During play, press S.FIT button on remote control.
  - Allows you to eliminate the black bars in the top and bottom of the screen when a movie is playing in the Widescreen format(16:9).
  - Screen Fit will not work when the Zoom mode is active. (you can not remove the black bars on the screen) However, Zoom mode will work when Screen Fit is active.

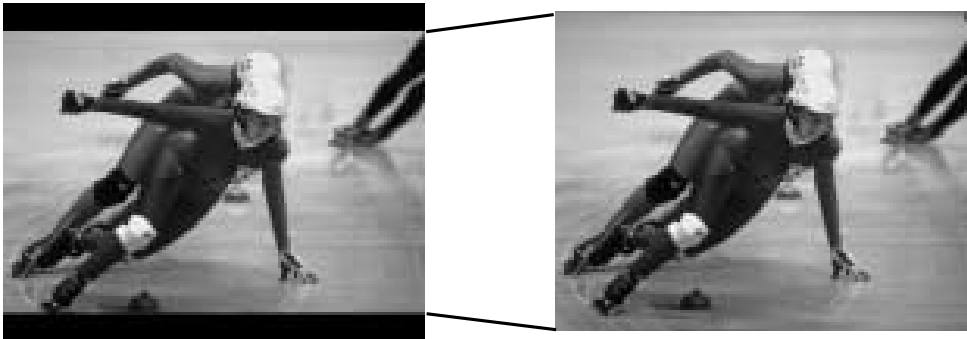

ADVANCED  
FUNCTIONS

### NOTE

- Various aspect ratios are available only in multiple screen format discs.
- This function does not work when a DVD has been recorded in a multi-camera angle format.
- On some DVDs, the black bars cannot be eliminated due to their aspect ratio.

# Digest Play

## Digest Play

**1** During play, press the DIGEST button.

- You'll see the 9 individual windows representing each of the chapters on the TV screen.
- When each window is displayed, the first 3 seconds of the chapter will be played.

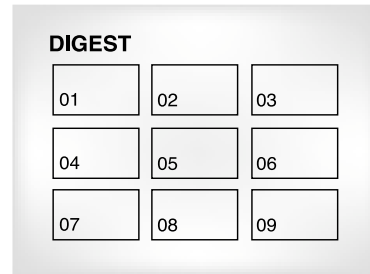

SKIP button

**2** Press UP/DOWN/LEFT/RIGHT buttons or NUMBER buttons to select the window you'd like to see, and press the ENTER button.

- Up to 9 windows(chapters) can be displayed on the screen at a time.
- Press the 'Skip' button for the next 9 chapters if the movie has more than 9.

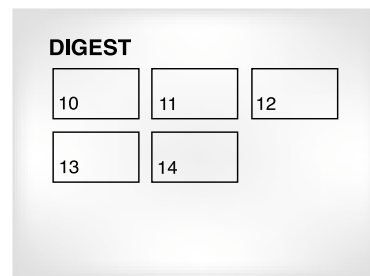

### NOTE

- You can play the DVD player starting with the desired chapter after directly moving to the scene you want.
- 'DIGEST' may not operate depending on the disc in use.

# Using the Disc View Function

## Track View (VCD)

Displays the beginning view of each track and the track number.

- 1 During play, press the TOP MENU button.
- 2 Press the UP/DOWN buttons to select TRACK VIEW. Press the ENTER button.
- 3 Select the desired view by pressing the UP/DOWN or LEFT/RIGHT buttons.
  - Press the SKIP button for the next 9 tracks if the movie has more than 9.
- 4 Press the ENTER button.
  - This function is available with the VCD Menu mode off.

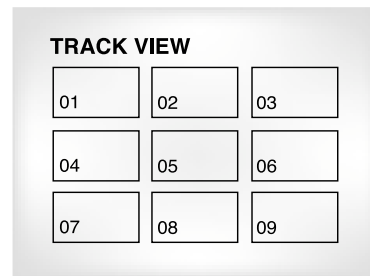
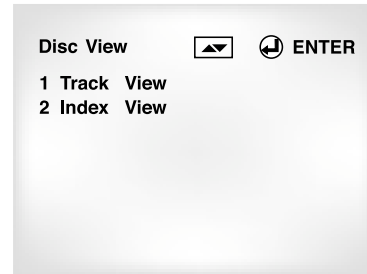

## Index View (VCD)

Displays the equally divided 9 views of the current playing track.

- 1 During play, press the TOP MENU button.
- 2 Press UP/DOWN buttons to select INDEX VIEW. Press the ENTER button.
- 3 Select the desired view by pressing UP/DOWN or LEFT/RIGHT buttons.
- 4 Press the ENTER button.

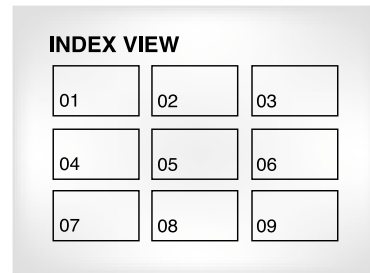

ADVANCED  
FUNCTIONS

### NOTE

- When pressing the TOP MENU button with a DVD; the disc's TITLE MENU function comes up. A disc must have at least two titles for the TITLE MENU function to work.
- When pressing the TOP MENU button with a CD; the unit enters the INTRO mode. INTRO lets you listen to the beginning of each track for about 10 seconds.
- You can also operate it using the DIGEST button.

# Slow Repeat play

This feature allows you slowly repeat scenes containing sports, dancing, musical instruments being played etc. so you can study them more closely.

## When playing a DVD

- 1 During play, press the PLAY/PAUSE button.
- 2 Press the F/SEARCH button to choose the play speed between 1/8X, 1/4X, and 1/2X of normal.
- 3 Press the REPEAT (A-B) button to select the point where the function starts (A).
- 4 Press the REPEAT (A-B) button to select the point where the function ends (B).

### NOTE

- The disc will play from A to B repeatedly at the speed you chose.
- To terminate the function, press the 'CLEAR' button or the 'REPEAT (A-B)' button again. Then press play to resume normal playback.
- A-B REPEAT does not allow you to set point (B) until at least 5 seconds has elapsed after point (A) has been set.



# Selecting the Audio Language

You can select a desired language quickly and easily with the AUDIO button.

## Using the AUDIO button

- 1 Press the AUDIO button.
- 2 Use the UP/DOWN buttons to select the desired language on a DVD.
  - The audio languages are represented by abbreviations.
- 3 Use the UP/DOWN buttons to select Stereo, Right or Left. (On VCD/CD)

DVD



VCD/CD

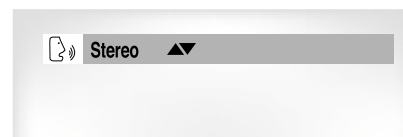

### NOTE

- This function depends on what languages are encoded on the disc and may not work with all DVDs.
- A DVD disc can contain up to 8 audio languages.
- **How to have the same audio language come up whenever you play a DVD;**  
Refer to "Setting Up the Language Features" on page 35.

ADVANCED  
FUNCTIONS

# Selecting the Subtitle Language

You can select a desired subtitle quickly and easily with the SUBTITLE button.

## Using the SUBTITLE button

- 1 Press the SUBTITLE button.
- 2 Use the UP/DOWN buttons to select the desired subtitle language.
- 3 Use the LEFT/RIGHT buttons to determine whether or not the subtitle will be displayed.
  - Initially, the subtitling will not appear on screen.
  - The subtitle languages are represented by abbreviations.



### NOTE

- This function depends on what languages are encoded on the disc and may not work with all DVDs.
- A DVD disc can contain up to 32 subtitle languages.
- **How to have the same subtitle language come up whenever you play a DVD;**  
Refer to "Setting Up the Language Features" on page 35.

## Changing the Camera Angle

When a DVD contains multiple angles of a particular scene, you can select the Angle function.

### Using the ANGLE button

Press the ANGLE button to see if an ANGLE (  ) mark is present at the upper right hand corner of the screen.

- 1** When an ANGLE mark is shown, press the ANGLE button, then an ANGLE select icon will appear at the upper left hand corner of the screen.
- 2** Use the UP/DOWN buttons to select the desired screen angle.
- 3** To turn off the display, press the ANGLE button again.



# Using the Instant Replay Function

## Using the Instant Replay function (DVD)

If you miss part of a scene, you can see it again using this function.

- 1 If you press the I.REPLAY button, the current scene moves backward about 10 seconds, and plays back.

\* Depending on the disc, the Instant Replay function may not work.



Instant Replay

# Using the Bookmark Function

The Bookmark function lets you select parts of a DVD or VCD (MENU OFF mode) so that you can quickly find the section at a later time.

## Using the Bookmark Function (DVD/VCD)

- 1** During play, press the BOOKMARK button on the remote. The Bookmark icons will be displayed.
- 2** Use the LEFT/RIGHT buttons to move to the desired bookmark icon.
- 3** When you reach the scene you want to mark, press the ENTER button. The icon will change to a number (1, 2, or 3).
- 4** Press the BOOKMARK button to turn off the display.

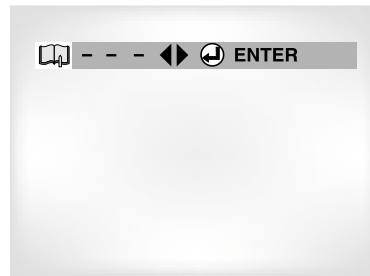

## Recalling a Marked Scene

- 1** During play, press the BOOKMARK button on the remote.
- 2** Use the LEFT/RIGHT buttons to select a marked scene.
- 3** Press the PLAY/PAUSE buttons to skip to the marked scene.



ADVANCED  
FUNCTIONS

## Clearing a Bookmark

- 1** During play, press the BOOKMARK button on the remote.
- 2** Use the LEFT/RIGHT buttons to select the bookmark number you want to delete.
- 3** Press the CLEAR button to delete a bookmark number. Press the BOOKMARK button to turn off display.

### NOTE

- Up to three scenes may be marked at a time.
- When in VCD 2.0 mode (MENU ON mode), this function does not work.
- Depending on the disc, the Bookmark function may not work.

# Using the Zoom & 3D Sound Functions

## Using the Zoom Function (DVD/VCD)

- 1 During play or pause mode, press the ZOOM button on the remote.  
A square will be displayed on screen.
- 2 Use the UP/DOWN or LEFT/RIGHT buttons to select the part of the screen you want to zoom in on.
- 3 Press the ENTER button.
  - During DVD play, press ENTER to zoom in 2X/4X/2X/normal in order.
  - During VCD play, press ENTER to zoom in 2X/normal in order.

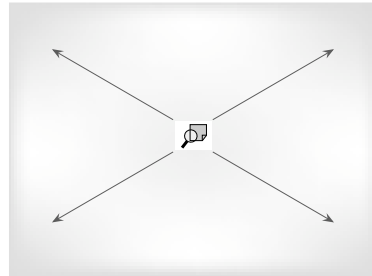

## Using the 3D Sound Function

The simulated surround effect depends on the disc contents. If you connect the unit to your stereo system, you can enhance sound quality and produce a greater surround effect.

This feature is useful when you are using the DVD player with a two channel stereo through the analog outputs.

(Discs which are recorded with LPCM or DTS will not work. When the DIGITAL OUTPUT is set to BIT STREAM in the SETUP MENU, the 3D Sound function will not work.)

- 1 During play, press the 3D button.  
The 3D SOUND mark will be displayed on screen. (Be sure the DIGITAL OUTPUT is set to PCM.)
- 2 Press the UP/DOWN buttons to turn the 3D Sound feature on or off.

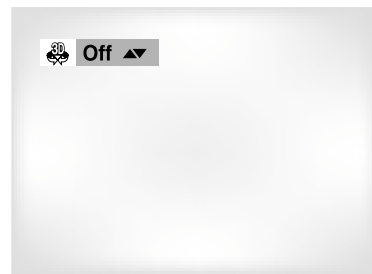

### NOTE

- 3D Sound is possible only on discs recorded using DOLBY SURROUND or DOLBY DIGITAL. However, some of these discs do not contain rear channel sound signals.
- Depending on the disc, the Zoom and 3D Sound function may not work.

# MP3 Play

When an MP3 Disc is inserted into the DVD PLAYER, the first song file of the first folder plays.

## MP3 Play Function

- 1 Press STOP to stop playback of the first song file, then press RETURN to display the music folder menu on the right side of the screen. Up to 8 music folders can be displayed at a time. If you have more than 8 folders on a disc, press the LEFT/RIGHT buttons to bring them up on the screen.
- 2 Use the UP/DOWN buttons to select the desired music folder, then press ENTER. Use the UP/DOWN buttons again to select a song file. Press ENTER to begin playback of the song file.

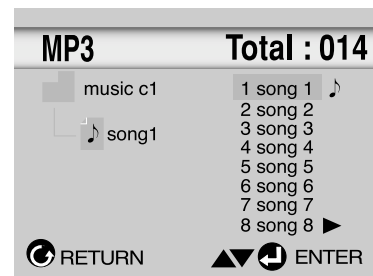
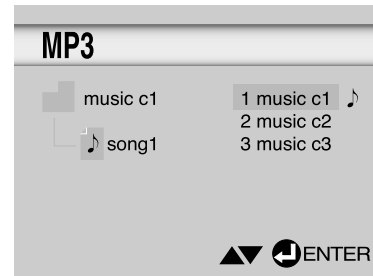

## Program/Random playback

Press the MODE button to switch between the RANDOM and PROGRAM modes. See page 20 for more information on these modes.

### NOTE

- A musical note is displayed next to the file currently playing.
- Press the REPEAT button to hear a song file repeatedly (check mark will appear next to file). Press Repeat again to release the Repeat mode.



ADVANCED  
FUNCTIONS

# MP3 Play

## CD-R MP3 disc requirements

When playing CD-R MP3 discs, please follow the recommendations below:

- **Your MP3 files should be ISO 9660 or JOLIET format.**  
ISO 9660 format and Joliet MP3 files are compatible with Microsoft's DOS and Windows, and with Apple's Mac. These two formats are the most widely used.
- **When naming your MP3 files do not exceed 8 characters, and place ".mp3" as the file extension.**  
General name format of: Title.mp3. When composing your title, make sure that you use 8 characters or less, have no spaces in the name, and avoid the use of special characters including: (.,/, \, =, +).
- **Use a decompression transfer rate of at least 128 Kbps when recording MP3 files.**  
Sound quality with MP3 files basically depends on the rate of compression/decompression you choose. Getting audio CD quality sound requires an analog/digital sampling rate (conversion to MP3 format) of at least 128 Kbps and up to 160 Kbps. However, choosing higher rates, like 192 Kbps or more, only rarely give better sound quality.  
Conversely, files with sampling rates below 128 Kbps will not be played properly.
- **Do not try recording copyright protected MP3 files.**  
Certain "securized" files are encrypted and code protected to prevent illegal copying. These files are of the following types: Windows Media™ (registered trade mark of Microsoft Inc) and SDMI™ (registered trade mark of The SDMI Foundation). You cannot copy such files.
- **Your DVD player only accepts one level of file directory.**  
Consequently you must choose:
  - either to save all your MP3 recording files at the root of the disc;
  - and/or create folders in the directory for each artist or music type (e.g.classical, rock, jazz, etc)
- **Important:** The above recommendations cannot be taken as a guarantee that the DVD player will play MP3 recordings, or as an assurance of sound quality.  
You should note that certain technologies and methods for MP3 file recording on CD-Rs prevent optimal playback of these files on your DVD player (degraded sound quality and in some cases, inability of the player to read the files).



# Using the Setup Menu

The Setup menu lets you customize your DVD player by allowing you to select various language preferences, set up a parental level, even adjust the player to the type of television screen you have.

**1** With the unit in Stop mode, press the SETUP button on the remote.

- 1 Player Menu** : Setup of the Display Language  
Use the Player preference menu to select the language for the player's on-screen displays.
- 2 Disc Menu** : Setup of the Menu Language  
Use the Menu preference menu to select the language you want a DVD's disc menu to be displayed in.
- 3 Audio** : Setup of the Audio Language  
Use the Audio preference menu to select the soundtrack language.
- 4 Subtitle** : Setup of the Subtitle Language  
Use the Subtitle preference menu to select the language the disc's subtitles are to be displayed in.
- 5 Parental** : Setup of the Parental Level  
Allows users to set the level necessary to prevent children from viewing unsuitable movies such as those with violence, adult subject matter, etc.
- 6 Audio Options** : Setup of the Audio Options
- 7 Display Options** : Setup of the Display Options  
Use to select which type of screen you want to watch and several display options.



**2** Use the UP/DOWN buttons on the remote to access the different features.

**3** Press the ENTER button to access the sub features.

To make the setup screen disappear after setting up, press the SETUP button again.

## NOTE

- Depending on the disc, some Setup Menu selections may not work.

CHANGING  
SETUP MENU

# Setting Up the Language Features

If you set the player menu, disc menu, audio and subtitle language in advance, they will come up automatically every time you watch a movie.

## Using the Player Menu Language

- 1 With the unit in Stop mode, press the SETUP button.
- 2 Use the UP/DOWN buttons to select the PLAYER MENU.
- 3 Press the ENTER button.
- 4 Use the UP/DOWN buttons to select 'English'.
- 5 Press the ENTER button.
  - English is selected and the screen returns to SETUP MENU.
  - To make the SETUP MENU disappear, press the RETURN button.

**e.g** Setting up in English.



## Using the Disc Menu Language

This function changes the text language only on the disc menu screens.

- 1 With the unit in Stop mode, press the SETUP button.
- 2 Use the UP/DOWN buttons to select DISC MENU.
- 3 Press the ENTER button.
- 4 Use the UP/DOWN buttons to select 'English'.
  - Select "Others" if the language you want is not listed.
- 5 Press the ENTER button.
  - English is selected and the screen returns to SETUP MENU.

**e.g** Setting up in English.



# Setting Up the Language Features

## Using the Audio Language

- 1 With the unit in Stop mode, press the SETUP button.
- 2 Press the UP/DOWN buttons to move to AUDIO.
- 3 Press the ENTER button.
- 4 Press the UP/DOWN buttons to select 'ENGLISH'.
  - Select "Original" if you want the default soundtrack language to be the original language the disc is recorded in.
  - Select "Others" if the language you want is not listed.
- 5 Press the ENTER button.
  - English is selected and the screen returns to SETUP MENU.



## Using the Subtitle Language

- 1 With the unit in Stop mode, press the SETUP button.
- 2 Use the UP/DOWN buttons to select SUBTITLE.
- 3 Press the ENTER button.
- 4 Use the UP/DOWN buttons to select 'English'.
  - Select "Automatic" if you want the subtitle language to be the same as the language selected as the audio preference.
  - Select "Others" if the language you want is not listed. Some discs may not contain the language you select as your initial language; in that case the disc will use its original language setting.
- 5 Press the ENTER button.
  - English is selected and the screen returns to SETUP MENU.



### NOTE

- If the selected language is not recorded on the disc, the original pre-recorded language is selected.
- **How to make the SETUP MENU disappear or return to menu screen during set up:** Press RETURN button.

CHANGING  
SETUP MENU

# Setting Up the Parental Control

The Parental Control function works in conjunction with DVDs that have been assigned a rating - which helps you control the types of DVDs that your family watches.

There are up to 8 rating levels on a disc.

- 1** With the unit in Stop mode, press SETUP button. The Setup Menu screen appears.
- 2** Use UP/DOWN to select Parental. Press ENTER. The Parental Control screen appears.
- 3** Use LEFT/RIGHT to select Yes if you want to use a password. Press ENTER. The Enter Password screen appears.
- 4** Enter your password. The Re-enter Password screen appears to confirm the password. Enter your password again. The Parental Control screen appears.
- 5 About the Rating Level ;**  
The Rating Level will work only when Use Password is set to Yes. To unlock the player, use LEFT/RIGHT to select No. Use UP/DOWN to select Rating level. Press ENTER.
  - Use UP/DOWN to select the level(e.g. Level 6) and press ENTER. Discs that contain Level 7 will now not play.
  - To cancel the rating level, use LEFT/RIGHT to select No in Use Password.
- 6 About the Change Password ;**
  - Use UP/DOWN to select Change Password. The Change Password screen appears.
  - Enter your new password. Re-enter the new password again.

## NOTE

- How to make the SETUP MENU disappear or return to menu screen during set up; Press RETURN button.
- If you have forgotten your password, see Forget Password in the Troubleshooting Guide.

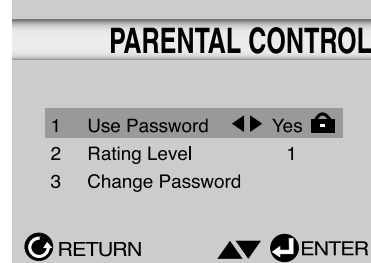
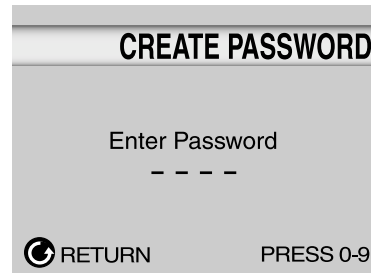
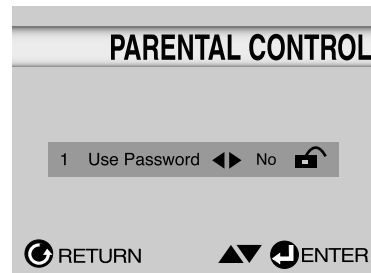

**e.g** Setting up in LEVEL6.



# Setting Up the Audio Options

- 1 With the unit in Stop mode, press the SETUP button.
- 2 Use the UP/DOWN buttons to select Audio Options. Then press the ENTER button.
- 3 Use the UP/DOWN buttons to select the desired item. Then press the LEFT/RIGHT buttons.

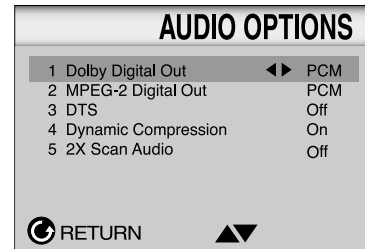

## 1 Dolby Digital Out

1. PCM :  
Converts to PCM(2CH) audio.  
Select PCM when using the Analog Audio Outputs.
2. Bitstream :  
Converts to Dolby Digital Bitstream (5.1CH).  
Select Bitstream when using the Digital Audio Output.

### NOTE

- Be sure to select the correct Digital Output or no audio will be heard.

## 3 DTS

1. Off : Doesn't output digital signal.
2. On : Outputs DTS Bitstream via digital output only.  
Select DTS when connecting to a DTS Decoder.

## 5 2X Scan Audio

1. Off : Turns 2X audio off.  
Though 2X Scan Audio is ON in the SETUP MENU, no sound will be heard on discs which are recorded with LPCM, DTS or MPEG-2 Audio.
2. On : Turns 2X audio on.

### NOTE

- How to make the SETUP MENU disappear or return to menu screen during set up; Press RETURN button.
- Manufactured under license from Dolby Laboratories.  
"Dolby" and the double-D symbol are trademarks of Dolby Laboratories.
- "DTS" and "DTS Digital Out" are trademarks of Digital Theater Systems, Inc.

## 2 MPEG-2 Digital Out

1. PCM :  
Converts to PCM(2CH) audio.  
Select PCM when using the Analog Audio Outputs.
2. Bitstream :  
Converts to MPEG-2 Digital Bitstream (5.1CH or 7.1CH).  
Select Bitstream when using the Digital Audio Output.

## 4 Dynamic Compression

1. On : To select dynamic compression.
2. Off : To select the standard range.

# Setting Up the Display Options

- 1 With the unit in Stop mode, press the SETUP button.
- 2 Use the UP/DOWN buttons to select Display Options. Then press the ENTER button.
- 3 Use the UP/DOWN buttons to select the desired item. Then press the LEFT/RIGHT buttons.

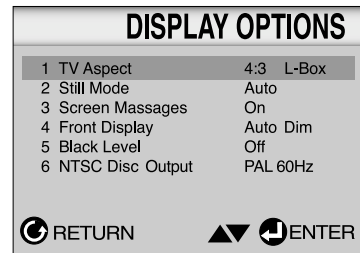

## 1 TV Aspect

Depending on the type of television you have, you may want to adjust the screen setting (aspect ratio).

### 1. 4:3 Letter Box :

Select when you want to see the total 16:9 ratio screen DVD supplies, even though you have a TV with a 4:3 ratio screen. Black bars will appear at the top and bottom of the screen.

### 2. 4:3 Pan-Scan :

Select this for conventional size TVs when you want to see the central portion of the 16:9 screen. (Extreme left and right side of movie picture will be cut off.)

### 3. 16:9 Wide :

You can view the full 16:9 picture on your widescreen TV.

## 2 Still Mode

These options will help prevent picture shake in still mode and display small text clearer.

1. Auto : When selecting Auto, Field/Frame mode will be automatically converted.
2. Field : Select this feature when the screen shakes in the Auto mode.
3. Frame : Select this feature when you want to see small letters more clearly in the Auto mode.

## 3 Screen Messages

Use to turn on-screen messages On or Off.

## 4 Front Display

Adjust the brightness of the unit's front panel display.

1. Auto Dim : Makes the Front Panel Display dim automatically when playing a DVD.
2. Bright : Makes the Front Panel Display bright.
3. Dim : Makes the Front Panel Display dim.

## 5 Black Level

Adjusts the brightness of the screen.(On/Off)

## 6 NTSC Disc Output

"NTSC" if the screen only has one NTSC-video entrance. If this is not the case, you can choose to leave "PAL 60Hz" as is.

### NOTE

- How to make the SETUP MENU disappear or return to menu screen during set up;  
Press the RETURN button.

# Controlling a TV with the Remote

The remote can also be set up to control most TVs. To program the remote, use the code that corresponds to your brand.

TV Codes	
CODE	BRAND
01	SAMSUNG_4
02	SAMSUNG_6, LG, LOEWE, PHILIPS, FINLUX, YOKO, LOEWE OPTA, MITSUBISHI, PHONOLA, RADIOLA, SCHNEIDER
03	SAMSUNG_1
04	SAMSUNG_2
05	SAMSUNG_3
06	SAMSUNG_5
07	TOSHIBA
08	PANASONIC_4
09	GRUNDIG, BLAUPUNKT, SIEMENS
10	SHARP
11	HITACHI
12	SANYO, AKAI, FISHER
13	HITACHI, SABA, THOMSON, NORDMENDE
14	HITACHI, NORDMENDE, SABA, TELEFUNKEN, THOMSON, BRANDT, FERGUSON, PIONEER, TELEAVA
15	SONY
16	TOSHIBA, SANYO, SHARP, SONY, MITSUBISHI
17	TOSHIBA, GRUNDIG, FINLUX
18	TOSHIBA
19	TOSHIBA
20	PHILIPS, PHONOLA, RADIOLA
21	TOSHIBA, GRUNDIG, CGE, IMPERIAL, MIVAR
22	PHILIPS, SABA, BANG&OLUFSEN, BRIONVEGA, FINLUX, FORMENTI, LOEWE OPTA, METZ, WEGA, PHONOLA, RADIOMARELLI, SINGER, SINUDYNE
23	NOKIA, PANASONIC, SABA, PIONEER, REZ, SELECO, SALORA
24	HITACHI, NORDMENDE, PANASONIC, SABA, TELEFUNKEN, THOMSON, CONTINENTAL, EDISON
25	PANASONIC_2
26	PANASONIC_3
27	PANASONIC_6
28	TELEFUNKEN
29	MIVAL
30	LG_2
31	SHARP_2
32	JVC
33	THOMSON ASIA
34	THOMSON ASIA

- 1 Turn on the TV.
- 2 Point the DVD's remote at the TV.
- 3 While holding the TV POWER button down, enter the code for your brand.
- 4 If the TV turns off, setup is complete.
- 5 Enter other codes of the same brand if the first code does not work.
- 5 To operate the TV, use the "TV Function Buttons" described on page 11.

**e.g** For SAMSUNG 4 TVs

While holding down the TV POWER button, enter 0 and then 1.

#### NOTE

The remote may not be able to control every model TV of the brands listed.

REFERENCE

# Troubleshooting

Before requesting service (troubleshooting), please check the following.

Problem	Action	Page
No operations can be performed with remote.	<ul style="list-style-type: none"> <li>• Check the batteries in the remote. May need replacing.</li> <li>• Operate the remote control at a distance of no more than 20 feet.</li> <li>• Remove batteries and hold down one or more buttons for several minutes to drain the microprocessor inside the remote to reset it. Reinstall batteries and try remote again.</li> </ul>	P4
Disc does not play.	<ul style="list-style-type: none"> <li>• Ensure that the disc is installed with the label side facing up.</li> <li>• Check the region number of the DVD.</li> </ul>	P7
5.1 channel sound is not being reproduced.	<ul style="list-style-type: none"> <li>• 5.1 channel sound is reproduced only when the following conditions are met. :               <ol style="list-style-type: none"> <li>1) The DVD player is connected with the proper amplifier</li> <li>2) The disc is recorded with 5.1 channel sound.</li> </ol> </li> <li>• Check whether the disc being played has the "Dolby 5.1 ch" mark on the outside.</li> <li>• Check if your audio system is connected and working properly.</li> <li>• In a SETUP Menu, is the Audio Output set to Bitstream?</li> </ul>	P12
The  icon appears on screen.	<ul style="list-style-type: none"> <li>• The features or action cannot be completed at this time because:               <ol style="list-style-type: none"> <li>1. The DVD's software restricts it.</li> <li>2. The DVD's software doesn't support the feature (e.g., angles).</li> <li>3. The feature is not available at the moment.</li> <li>4. You've requested a title or chapter number or search time that is out of range.</li> </ol> </li> </ul>	P15
Disc Menu doesn't appear.	<ul style="list-style-type: none"> <li>• Check if the disc has a Menu.</li> </ul>	
Play mode differs from the Setup Menu selection.	<ul style="list-style-type: none"> <li>• Some of the functions selected in the Setup Menu may not work properly if the disc is not encoded with the corresponding function.</li> </ul>	P33-38
The screen ratio cannot be changed.	<ul style="list-style-type: none"> <li>• The Screen Ratio is fixed on your DVDs.</li> </ul>	P38
No audio.	<ul style="list-style-type: none"> <li>• Make sure you have selected the correct Digital Output in the Audio Options Menu.</li> </ul>	P37
Forgot password	<ul style="list-style-type: none"> <li>• Press power on from a cold start with no disc in the unit. Press the STOP and PLAY buttons simultaneously on the front panel for three seconds. The Select Menu Language display will appear. Select the desired language button. Press the SETUP button on the remote control to select the Parental Mode. The Parental Mode is now unlocked as indicated on the display. Press the DOWN button to select Parental. Press ENTER and the Create Password display will appear. You can now set your rating level and change your password to a new number.</li> </ul>	P36
If you experience other problems.	<ul style="list-style-type: none"> <li>• Go to the contents and find the section of the instruction book that contains the explanations regarding the current problem, and follow the procedure once again.</li> <li>• If the problem still cannot be solved, please contact your nearest authorized service center.</li> </ul>	



# Specifications

General	Power Requirements	AC 110-240 V, 50/60 Hz
	Power Consumption	15 W
	Weight	5.7 Kg
	Dimensions	W 430 mm x D 404 mm x H 90 mm
	Operating Temperature Range	+5°C to +35°C
	Operating Humidity Range	10 % to 75 %
Disc	DVD (DIGITAL VERSATILE DISC)	Reading Speed : 3.49 m/sec. Approx. Play Time (Single Sided, Single Layer Disc) : 135 min.
	CD : 12Cm (COMPACT DISC)	Reading Speed : 1.2 to 1.4 m/sec. Maximum Play Time : 74 min.
	CD : 8Cm (COMPACT DISC)	Reading Speed : 1.2 to 1.4 m/sec. Maximum Play Time : 20 min.
	VCD : 12Cm	Reading Speed : 1.2 to 1.4 m/sec. Maximum Play Time : 74 min. (Video + Audio)
Video Output	Composite Video	1 channel : 1.0 Vp-p (75 Ω load)
	Component Video	Y : 1.0 Vp-p (75 Ω load) Pr : 0.70 Vp-p (75 Ω load) Pb : 0.70 Vp-p (75 Ω load)
	S-VIDEO	Luminance Signal : 1.0 Vp-p (75 Ω load) Chrominance Signal : 0.286 Vp-p (75 Ω load)
Audio Output	2 Channel	L(1/L), R(2/R)
	*Frequency Response	48 kHz Sampling : 4 Hz to 22 kHz 96 kHz Sampling : 4 Hz to 44 kHz
	*S/N Ratio	110 dB
	*Dynamic Range	100 dB
	*Total Harmonic Distortion	0.004 %

\*: Nominal specification

- Samsung Electronics Co., Ltd. reserves the right to change the specifications without notice.
- Weight and dimensions are approximate.

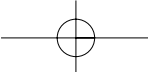

# Memo

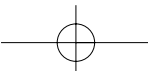
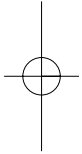

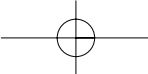

# Memo

