

**Factory set for Natural Gas.
Can be Converted to Propane
with parts provided.**

WARNING: If the information in these instructions are not followed exactly, a fire or explosion may result causing property damage, personal injury or death.

- Do not store or use gasoline or other flammable vapours and liquids in the vicinity of this or any other appliance.
- **WHAT TO DO IF YOU SMELL GAS**
 - Do not try to light any appliance.
 - Do not touch any electrical switch; do not use any phone in your building.
 - Immediately call your gas supplier from a neighbour's phone. Follow the gas supplier's instructions.
- Installation and service must be performed by a Corgi registered installer. A page is included on the inside back page of this booklet for recording commissioning and service details.



Genie

**Operating, Installation and
Servicing Instructions for**

Certikin

**Condensing
Pool & Spa Heaters**

CE 0087

Models:

MB35S

MB50S

**GB, IE, CH, ES, PT,
SI, SK & TR**

TECHNICAL DATA

GENERAL SPECIFICATIONS

WATER CONTENT	MB35S	3.0	Litres	0.66	gallons
	MB50S	4.0	Litres	0.88	gallons
MINIMUM FLOW RATE	80 l/m (17.8 gpm)				
MAX PRIMARY WATER PRESSURE	3 bar (45 psi)				
INTERNAL PUMP SETTING	Speed 3				
MAXIMUM POOL TEMP	Pool 41°C (106°F)				
ELECTRICAL SUPPLY	230V 50Hz, FUSED AT 3A, 130W				
PROTECTION LEVEL	IP44				
FLUE SYSTEM	80/125 PP, to a maximum Flue Equivelant Length of 20m				

PERFORMANCE SPECIFICATIONS

GAS CATEGORY, TYPE AND SUPPLY PRESSURE

II_{2H3P} G20 @ 20 mbar
G31 @ 37 mbar

<i>MODEL</i> <i>Corgi Work Code</i>			NATURAL GAS		PROPANE	
			MB35S 1036909	MB50S 1036910	MB35S 1036913	MB50S 1036914
HEAT INPUT	GROSS	kW Btu/h	38.0 129,650	51.5 179,100	38.0 129,650	51.5 179,100
	NET	kW Btu/h	34.2 116,700	46.39 158,300	35.0 119,400	47.48 162,000
TYPICAL EFFICIENCY		% gross % net	92 - 94 102 - 104	92 - 94 102 - 104	92 - 94 102 - 104	92 - 94 102 - 104
HEAT OUTPUT		kW Btu/h	35.7 121,870	48.4 165,170	35.7 121,870	48.4 165,170
GAS RATE (NG, Propane)		m³/h	3.45	4.64	1.43	1.9
MAXIMUM RATE, COMBUSTION SETTINGS, NG,		CO CO₂	120-150 9.2-9.4	80-120 9.0-9.4	130-160 10.3-10.5	100-130 10.0-10.3
OFFSET SETTING		pA	-3.0	-3.0	-3.0	-3.0
ORIFICE		mm	Not required		4.4	5.2

Contents

Section **Page**

TECHNICAL DATA **Inside cover**

User Instructions 1

INTRODUCTION **3**

Heater Location 3

Gas Supply 4

Conversion 4

Flueing 4

Air Supply 4

Outdoor Heaters 4

Condensate Drain 5

Pool Pump & Pipework 5

Winterisation 5

Electricity Supply 5

INSTALLATION OF HEATER **6**

Procedure 6

Outdoor Terminal 6

Flue Systems 6

Wall Terminal 6

Flue Examples 9

Roof Terminal 11

Plumbing 11

Pressure Switch 11

Gas Conversion 12

Gas Connection 12

Condensate Connection 13

Electrical Connection 13

Commissioning 15

Control Setup 16

Multiple Heater Kit 17

Wall Mounting Kit 19

FAULT FINDING **22**

Operation 22

Safety Controls & Lockouts 22

Engineering Mode 22

Test Temperature Disp.Mode 22

Display Fault Codes 23/24

SERVICING **25**

Routine Service 25

Changing Components 25

Spares 28

Heater Components 29

COMMISSIONING & SERVICE HISTORY **Inside back cover**

List of Figures **Page**

Fig 1.0 Terminal Positions 4

Fig 2.0 Hydraulic Resistance Graph 5

Fig 3.0 Outdoor Terminal Fixing 6

Fig 3.1 Service Access & Pipe Connections 7

Fig 3.2 Wall Terminal Dimensions 7

Fig 3.3 Outdoor Terminal Dimensions 8

Fig 3.4 Roof Terminal Dimensions 8

Fig 4.0 Wall Terminal Installation 9

Fig 4.1 Extended Wall Terminal Installation 9

Fig 4.2 Extended Vertical Roof Installation 9

Fig 4.3 Outdoor Terminal Installation 9

Fig 5.0 Pressure Switch 11

Fig 6.0 Throttle Adjustment 12

Fig 6.1 Orifice Position 12

Fig 6.2 Gas Valve Tappings 12

Fig 7.0 Condensate Disposal 14

Fig 7.1 Condensate Syphon 14

Fig 8.0 Heat Exchanger Air Vent 15

Fig 8.1 Pump Priming Button 15

Fig 8.2 Heat Exchanger Sight Glass 15

Fig 9.0 Controls 16

Fig 10.0 Multiple Heater Install 17

Fig 10.1 Multiple Heater Install 17

Fig 10.2 Multiple Heater Install 18

Fig 10.3 Wall Mounted Heater 19

Fig 10.4 Wall Mounting Dimensions 19

Fig 10.5 Wall Mounting Assembly 20

Fig 11.0 Schematic Wiring 21

Fig 12.0 Electrode gap setting 25

Fig 13.0 Electrical Components 28

Fig 14.0 Heater Components 29

Genie USER'S OPERATING INSTRUCTIONS

FOR YOUR SAFETY - READ BEFORE OPERATING

WARNING: IF YOU DO NOT FOLLOW THESE INSTRUCTIONS EXACTLY, A FIRE OR EXPLOSION MAY RESULT, CAUSING PROPERTY DAMAGE, PERSONAL INJURY OR LOSS OF LIFE.

This appliance is equipped with an ignition device which automatically lights the burner.

BEFORE OPERATING after a prolonged time off, smell all around the appliance area for gas. Be sure to smell next to the floor because some gas is heavier than air and will settle on the floor.

WHAT TO DO IF YOU SMELL GAS

- * Do not try to light any appliance
- * Do not touch any electric switch
- * Do not use any phone in your building.
- * Immediately call your gas supplier from a neighbour's phone. Follow the gas supplier's instructions.
- * If you cannot reach your gas supplier, call the fire service.
- * Isolate the appliance with the Service Cock inside. If this is not accessible, isolate at the gas meter.

- * Do not use this appliance if any part has been under water. Immediately call a qualified service engineer to inspect the appliance and to replace any part of the control system and any gas control which has been damaged.

CAUTION: Propane gas is heavier than air and will settle on the ground. Since it can accumulate in confined areas, extra care should be exercised when lighting Propane heaters.

WARNING: There are no user servicable items in this appliance. Do not interfere with any sealed components.

IMPORTANT INFORMATION

Incorrect water balance will cause premature failure of this heater. Such damage is not covered under warranty. For additional information please see page 3 of these Instructions.

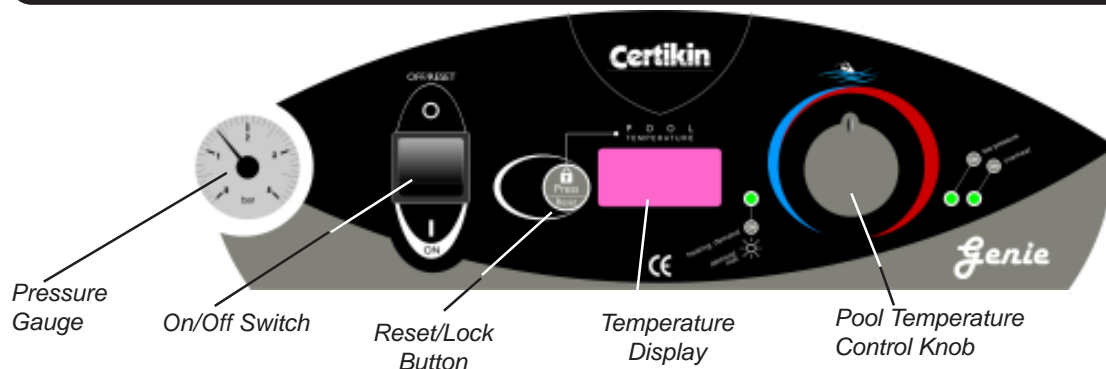

Before Start Up

Keep heater area clear and free from combustibles, flammable liquids and chemicals.

Pool water must be flowing through the Heater and the Heater pressure gauge showing between 1.5 to 2.5 bar for it to operate.

Quick Start

Check that the Electricity and Gas Supplies are on. Turn on the Pool Pump. Turn on the Heater with the switch on the Front Panel and set the desired temperature with the Pool Temperature Knob. In a few seconds the Heater will fire.

Summary of Controls (Left to Right)

Pressure Gauge - This should be between 1.5 to 2.5 bar, repressurise if too low.

ON/OFF Switch - Turns the Heater On and Off.

Lock/Reset Button - If it is pressed for 2 seconds it locks the Set Temperature so the Pool Temperature Knob is inoperative. To unlock, press again for 2 seconds. When locked a short press flashes the Set temperature.

It also resets Gas Control lockouts, GAS and OH2.

Pool Temperature Display - This normally shows the Pool Temperature but also show the Setting Temperature when the Pool Temperature Control Knob is moved. The Display is also used for commissioning and diagnostic purposes. **(Page 16)** If the display alternates the temperature with 'SEr' it is recommended that the Heater is serviced, it will continue to function.

Pool Demand LED - Green

Off - There is no Pool Heating demand, pool heating is off.

On - There is Pool Heating Demand and the Pool is not up to temperature.

Flashing - The Pool Heating Demand is met, the pool is up to temperature.

Pool Temperature Control Knob

16°C to 32°C (60°F to 90°F)

(Maximum is changed in Setup Mode, see Page 16)

Rotate clockwise to increase the Pool Temperature.

The Setting Temperature is shown whilst rotating and for 3 seconds after.

To lock the required Temperature Setting see Lock/Reset Button Page 1

Pool Pump Pressure

- **Yellow LED, Display, Pool Temperature**

On - If the pump is running and there is insufficient pressure, possibly due to a blocked Pool Filter. The Heater will not run.

Overheat - Flashing Red LED, Display "OH2"

Flashing - This indicates the Heater has overheated and it has shutdown. Wait for the Heater to cool then press the Lock/Reset Button to start the Heater again. If this problem persists this should be investigated by a Service Engineer.

Overheat - Red & Yellow LED, Display "GAS"

On - This indicates the Heater Gas Ignition Control has locked out. Press the Lock/Reset Button to start the Heater again. If this problem persists this should be investigated by a Service Engineer.

Condensate - Display "HI"

This indicates that the Condensate drain is blocked and the Heater has shutdown. When the blockage is cleared for the Heater will operate again.

Water Pressure Switch

A water pressure switch is provided in the heater to shut off the burners in the event that water supply to the heater is interrupted. The water pressure switch should be checked and adjusted for proper operation by a qualified service person at the time of installation, and thereafter checked at each service.

WARNING: Operation of the heater without water circulation will cause rapid and severe damage to the Heater.

Water Temperature Settings

The Heater is designed to provide the maximum amount of heat to the pool up to one degree below the set temperature. For that last degree it reduces the power to maximise control. For certain installation designs, if the pool is used before it is up to set temperature, the water entering the pool from the Heater could be noticeably warmer than the pool. This is not a fault but part of the design. It will reduce for the final degree up to set temperature.

CAUTION

Elevated water temperature can be hazardous, and the U.S. Consumer Product Safety Commission recommends the following guidelines:

1. Spa or hot tub water temperatures should never exceed 40°C (104°F). A temperature of 38°C (100°F) is considered safe for a healthy adult. Special caution is suggested for young children.
2. Drinking of alcoholic beverages before or during spa or hot tub use can cause drowsiness which could lead to unconsciousness and subsequently result in drowning.
3. Pregnant Women Beware! Soaking in water over 39°C (102°F) can cause fetal damage during the first three months of pregnancy resulting in the birth of a brain-damaged or deformed child. Pregnant women should stick to the 38°C (100°F) maximum rule.
4. Before entering the spa or hot tub, users should check the water temperature with an accurate thermometer; spa or hot tub thermostats may err in regulating water temperatures by as much as 2°C (4°F).
5. Persons with a medical history of heart disease, circulatory problems, diabetes, or blood pressure problems should obtain a doctor's advice before using pools or hot tubs.
6. Persons taking medications which induce drowsiness, such as tranquilizers, antihistamines, or anticoagulant, should not use spas or hot tubs.

Cleaning

It is recommended that periodically the casing is cleaned and sprayed with WD40 or similar liquid, and any exposed threads are lightly coated in grease.

Service & Maintenance

It is recommended that the Heater is serviced every 2000 hours of operation, for normal use this is about 12 months. The control will alert when you when it reaches this period by its display, 'SEr' alternating with the temperature.

It is a mandatory requirement that any gas work carried out must be by a Corgi registered engineer with an appropriate accreditation.

Winterisation

As supplied the Heater includes a dose of inhibitor and anti-freeze, sufficient to protect the primary heat exchanger down to -5° C. If the Pool and Heater are not going to be used for the cold winter months it is recommended that the equipment is winterised. Contact your pool installer for help with this. Failure to winterise the Heater during a period of freezing could cause damage to the Heater which will not be covered by your warranty.

INTRODUCTION

These Instructions cover a range of direct, floor mounted, gas fired, condensing pool heaters which are room sealed and fan assisted. The flue system available is concentric, left, right, rear, and vertical, all up to 20 metres 'FEL'. There is also an Outdoor Top terminal for use where the Heater is installed out of doors. The ignition system is fully automatic.

There are two models with different outputs - see the **Technical Data on Inside Cover** for details. Both can be installed in multiples to obtain a larger, combined output.

The casing is of green and black polyester powder coated mild steel. The Heaters use a high performance stainless steel heat exchanger and are suitable for connection to pools using chlorinated and salt chlorinated water provided the following levels of chemicals are maintained.

pH	7.2 to 7.8
Total Alkalinity	80 to 140 ppm
Calcium Hardness	200 to 400 ppm
Salt maximum	30000 ppm
Free Chlorine	1 to 4 ppm

All chemicals must be introduced and completely diluted into the pool water before being circulated through the heater. Do not place chlorine tablets or bromine sticks in the skimmer, high chemical concentrations will result when the pump is not running.

Chlorinators must feed downstream of the heater and have an anti-siphoning device to prevent chemical back-up into the heater when the pump is shut off.

NOTE: High chemical concentrates from feeders and chlorinators that are out of adjustment will cause corrosion to the heat exchanger in the heaters. Such damage is not covered under the warranty.

Gas Safety (Installation and Use) Regulations, (as amended).

It is the law that all gas appliances are installed by a competent person (e.g. a CORGI registered operative) in accordance with the above Regulations. Failure to install appliances correctly could lead to prosecution.

It is in your own interest, and that of safety, to ensure that the law is complied with. The installation of the Heater MUST also be in accordance with the current I.E.E.. Wiring Regulations, the Local Building Regulations, Building Standards (Scotland), the Bye Laws of the Local Water Undertaking, any relevant requirements of the Local Authority, and

Health and Safety document No 635, "Electricity at Work Regulations".

Detailed recommendations are contained in the following British Standard Codes of Practice.

Codes of Practice.

BS.6798 Installation of gas fired hot water boilers of rated input not exceeding 70kW.
BS.5440: Part1 and Part 2. Flues (for gas appliances of rated input not exceeding 60kW).
BS 6891 Specification for installation of low pressure gas pipework.
BS5482:1 Code of practice for domestic butane & propane gas burning installations.
Building Regulations Part L1.

IMPORTANT. It is important that no external control devices are directly connected to this appliance - unless covered by these 'Installation and Servicing Instructions' or otherwise recommended by the manufacturer. If in doubt, please enquire. Any direct connection of a control device not recommended by the manufacturer could infringe the Gas Safety (Installation & Use) Regulations, the above regulations and the normal appliance warranty.

Manufacturer's notes must NOT be taken, in any way, as overriding statutory obligations.

Location of Heater

The Heater MUST be installed on a flat and level floor, capable of adequately supporting the weight of the Heater and any ancillary equipment. Provision is provided for the heater to be fixed to the floor.

It is IP 44 Rated and can be installed out of doors in a suitable position. In all cases the choice of position should take into account the flue, the plume and the condensate drainage.

IMPORTANT NOTICE.

If the Heater is to be fitted in a timber framed building it should be fitted in accordance with the British Gas publication 'Guide for Gas Installations in Timber Frame Housing', reference DM2. If in doubt, advice must be sought from the Local Gas Region of British Gas.

The Heater may be installed in any room or internal space. Particular attention is drawn to the requirements of the current I.E.E Wiring regulations and, in Scotland, the electrical provisions of the Building Regulations applicable to Scotland with respect to the installation of the boiler in a room or internal space containing a bath or shower.

Where a room sealed appliance is installed in a room containing a bath or shower then the appliance and any electrical switch or appliance control, utilising mains electricity should be so situated that it

cannot be touched by a person using the bath or shower.

Where installation will be in an unusual location then special procedures may be necessary and BS.6798 gives detailed guidance on this aspect.

A compartment used to enclose the Heater **MUST** be designed and constructed specially for this purpose. An existing cupboard, or compartment, may be used provided it is modified for the purpose. Details of essential features of cupboard compartment design, including airing cupboard installations are given in BS.6798.

In siting the Heater, the following limitations **MUST** be observed:

1. The position selected for installation **MUST** allow adequate space for servicing in front of the boiler and for air circulation around the boiler.
2. This position **MUST** also permit the provision of a satisfactory balanced flue termination.
3. This position **MUST** also permit the provision of a satisfactory connection to the condensate drain.

Gas Supply

An existing meter and pipework should be checked, preferably by the Gas Supplier, to ensure that they are adequate to deal with the rate of gas supply required.

Supply pipes should be sized to suit installation and obtain a working pressure of 20 mbar (NG), 37 mbar (Propane) 29 mbar (Butane). Installation pipes should be fitted in accordance with BS.6891.

A Natural Gas Heater must be connected to a governed meter.

Conversion

For countries permitted to use different gasses the appliance is supplied setup for the primary gas. It can be converted to the alternative by the addition of an Orifice which is supplied with the heater. See page the inside cover for the data and Page12 for conversion instructions.

Flueing

Only flue components specified by the Manufacturer should be used with these appliances. Detailed recommendations for flueing are given in BS.5440: The following notes are intended for general guidance.

1. Be aware of the plume from the flue and the wetting effect it can have to adjacent property.
2. The flue can be taken upwards, left, right or to the rear of the appliance, but **never** downwards.
3. The Heater is supplied separate to the chosen flue set. It can be fitted with up to 20 metres equivalent length of Concentric flue, see the Flue Section on page 8, 9 & 10 for examples and parts selection.

Terminal Position	Minimum
Below window or vent	300 mm
Below gutter or pipes	75 mm
Below eaves	200 mm
Below balcony or roof	200 mm
From a window	200 mm
From vertical pipe	75 mm
From corners	300 mm
Above ground, roof or balcony	300 mm
From facing surface	600 mm
From facing terminal	1200 mm
From opening under a car port	1200 mm
Vertically from a terminal	1500 mm
Horizontally from a terminal	300 mm

Fig. 1.0

IMPORTANT.

It is absolutely **ESSENTIAL** to ensure in practice, that products of combustion discharging from the terminal cannot re-enter the building, or any other adjacent building, through ventilators, windows, doors, other sources of natural air infiltration or forced ventilation/air conditioning.

*If this should occur, the appliance **MUST** be turned OFF IMMEDIATELY and the Local Supplier consulted.*

Air Supply

It is **NOT** necessary to have a purpose provided air vent in the room or internal space in which the boiler is installed.

Where the boiler is installed in a cupboard or compartment **no** air vents are required. However the user may wish to ensure that it is ventilated to provide air circulation.

Outdoor Heaters

These Heaters are certified for outdoor installation, when equipped with the approved terminal.

WARNING: The heater shall not be located in an area where water sprinklers, or other devices, may cause water to spray through the cabinet openings and into the heater. This could cause heavy internal rusting or damage some electrical components, and this would void the warranty.

It is recommended that periodically the casing is cleaned and sprayed with WD40 or similar liquid, and any exposed threads are lightly coated in grease.

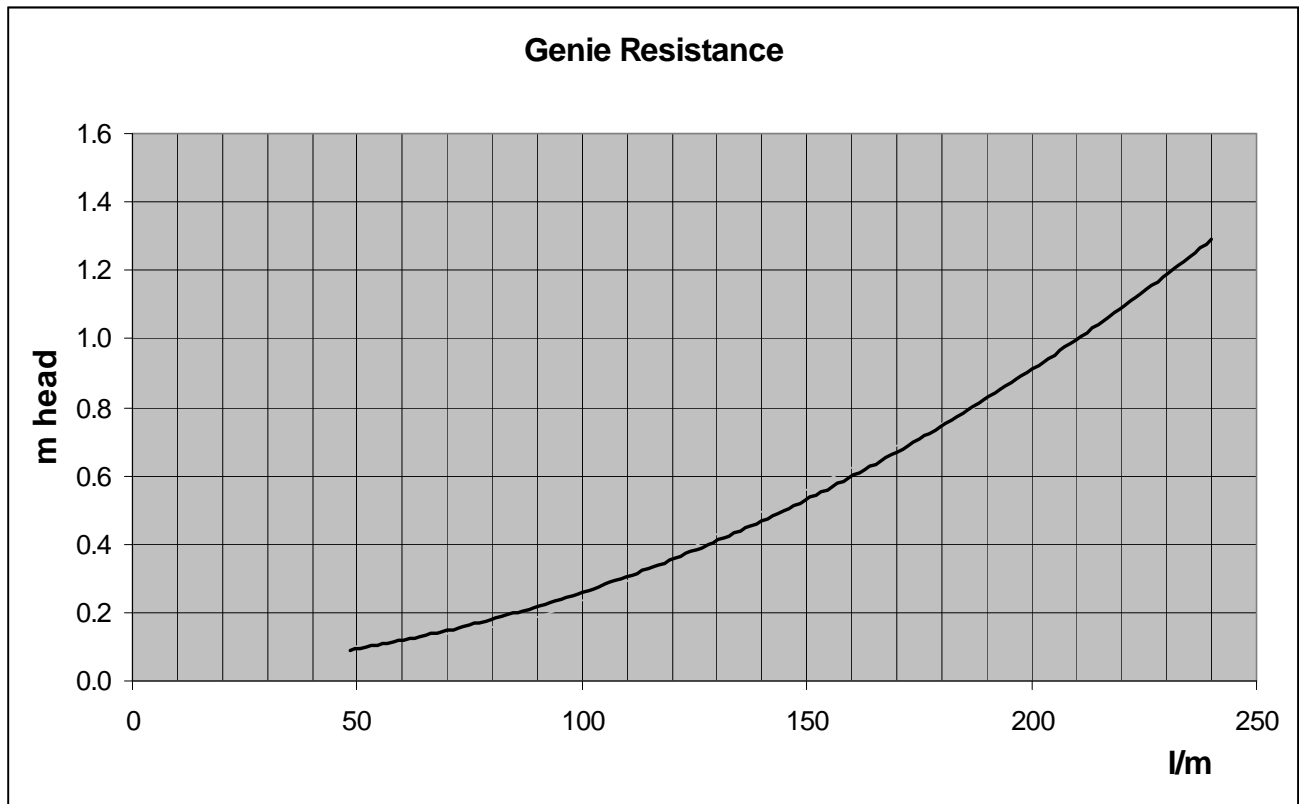

Fig. 2.0

Condensate Drain

See Fig. 7.0, and 7.1

A 75mm condensate trap is provided on the Heater and is satisfactory when connected to Soakaways, Gullies, Rainwater Pipework and Internal Drainage systems. All pipework and fittings in the condensate drainage system **MUST** be made of plastic, unless they carry other liquid waste. **No other materials may be used.** The pipework should be insulated if run out of doors.

The drain outlet on the boiler is :

1¼" or 40 mm Hunter waste pipe.

Pool Pump & Pipework

The Heater is an indirect design and uses two very high performance heat exchangers. The pool water passes through the Secondary, the water in the Primary is completely separate. The Heaters controls modulate the input when approaching the set temperature for greater accuracy and economy. It is recommended that pool pump overrun is used to maximise the life of the Heater.

If a new pump is being fitted consult the Pressure Loss graph (Fig 2.0) to determine its size.

The Heater is provided with both 1½" and 50mm plastic pool connections. As built the connections are 'From Pool' on the left, 'To Pool' on the right, however these can be easily reversed.

With the exception of automatic dosing equipment, the Heater should be plumbed as the last piece of equipment before the pool.

It is permissible to fit an isolating valves on the pipework on either side of the Heater. In these circumstances it is recommended to fit a flow switch in the Heaters Mains supply.

Winterisation

Turn off the Mains electricity and Gas Supply.

As supplied the Heater includes one litre of Sentinel X500 Inhibitor/Anti-freeze, this is sufficient to protect the Heater down to -10°C. It is recommended that this is maintained and so should be replenished if there is a loss of primary water. **See Fig 14.0**

Draining the Heater can be achieved by fitting the drain assembly in place of the double check valve/hose connector. The Condensate Syphon can be drained by removal of its Drain Cap. **See Fig 7.1**

Electricity Supply

Wiring external to the appliance **MUST** be in accordance with the current I.E.E. Wiring Regulations and any Local Regulations that apply.

The Heater is supplied with a plug and lead for 230V ~ 50Hz. Single phase. Fuse rating is 3A.

The method of connection to the mains electricity supply **MUST** facilitate complete electrical isolation of the Heater, preferably by the use of a fused double pole switch having a 3mm (1/8in.) contact separation in both poles and servicing only the Heater and its controls.

The point of connection to the mains should be readily accessible and adjacent to the Heater.

Note. Where a Heater is installed in a room containing a pool or shower, the appliance, any electrical switch or appliance control utilising mains electricity should be so situated that it cannot be touched.

INSTALLATION OF HEATER

Space Required for Installation and Service.

Left, Right or Above	300 mm	12 in.
In Front	800 mm	40 in.

Suggested procedure:

Site to suit the pool, terminal, plume and condensate drain limitations. The Terminal position should follow BS 5440 and be at least 600mm away from any opening or obstacle.

1. **For an indoor installation only** : Mark & Drill Flue hole. (*See Fig. 3.1* and *3.2* for dimensions)
2. Fix the Heater to the floor using the holes provided in the front channel.
3. The Heater is provided with an Electrical Plug and lead. This can be connected to a suitable supply as detailed on Page 5. If it is required to separately time the running of the Heater this can be achieved as follows:
 - Remove Front Top Panel after releasing the retaining M5 screw under the lip.
 - Remove the Electrical Cover to access the Mains connector.
 - Pull out the Mains connector and replace the Mains lead and link wire with a Permanent and Switched live supply.

See Fig 11.0
4. Pipe to the 22mm gas connection. A gas isolating valve is provided on the Heater Gas Valve.
5. Plumb to the Pool Pump and Filter.
6. Fill Primary system with water using the supplied hose connector. The Heater is supplied with one litre of Sentinel X500 Inhibitor/ Anti-Freeze in the pipework.
7. **IMPORTANT.** Remove the air from the primary through the Air Vent on the righthand Side Panel and the Vent on the top of the Primary Heat Exchanger. (*See Fig 8.0*) by running the internal pump in short one second bursts, venting, then pumping, until it has all been removed. There is special button (*See Fig. 8.1*) for operating the pump on its own, under the chassis on the pressure gauge side. To operate the Mains must be connected and on.
8. Test for leaks.
9. Replace the Electrical Cover and Panels.

Assembly of the Outdoor Terminal

A specific Outdoor Top Terminal must be used for an outdoor installation. There must be at least 600mm clearance around the terminal and complete clearance above.

The Outdoor Top Terminal is a push fit into the Flue Adapter and locked in position with a clamping ring. (*See Fig. 3.0 & 3.3*)

If lubrication is required only Centra Cerin or silicone grease should be used.



All Other Flue Systems *Fig. 3.0*

The maximum Flue Equivalent Length (FEL) permitted is 20 metres, horizontal or vertical. The component parts have the following FELs:

1 metre of concentric flue	1.0
2 metres of concentric flue	2.0
A 45 degree concentric bend	1.1
A 90 degree concentric bend	1.5
A concentric Roof Terminal	3.3
A concentric Wall Terminal	3.9

Sum the Flue Equivalent Lengths used in the design this must not exceed 20 metres.

Assembly

All items assemble by a push fit/clamp system. If it is required to lubricate the seals only Centra Cerin supplied by the manufacturer or Silicone Grease should be used.

The pipes should be assembled so the socket end is always furthest from the Heater.

Flues should be supported by brackets every metre of run.

Horizontal flues should incline back to the Heater by 3 degrees (5mm in 100mm)

Wall Terminal

The Horizontal Wall Terminal is supplied with two rubber wallplates, one for inside and one for the outside. The core drill diameter required is 175mm and should incline upwards to the outside.

Because of the incline of the flue the height of the centre of the flue hole on the inside will be determined by the distance the heater is from the wall. the following is the suggested procedure.

Heater Dimensions

Pipe Connections & Locations

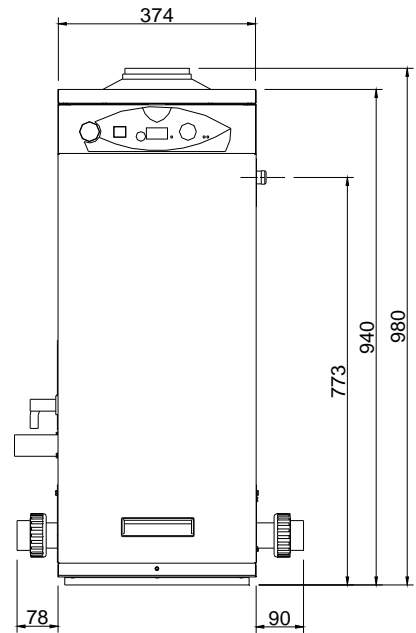
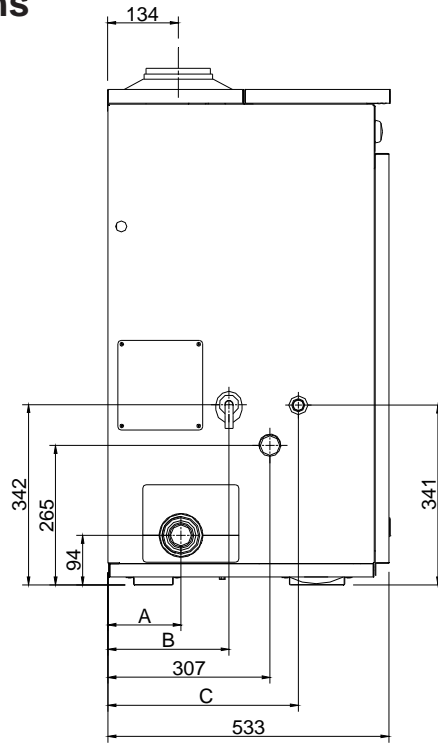
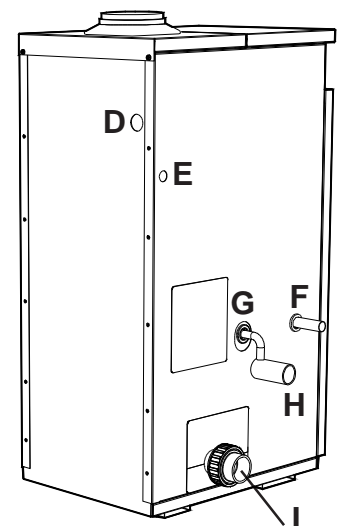

Fig. 3.1

Dimensions			
Model	A	B	C
<i>Genie 35</i>	138mm	229mm	361mm
<i>Genie 50</i>	170mm	261mm	425mm

Service Access	
Left, Right or Above	300mm
In Front	800mm

Connections	
D	Multi Heater Connection
E	Electric & External Control (CCP01)
F	Gas Supply - 22mm Copper
G	Safety Valve Outlet - 15mm Copper
H	Condensate Drain - 1¼" or 40mm Hunter Plastic
I	From Pool - 1½" / 50 mm Plastic Demountable Fittings



Horizontal Wall Terminal Dimensions

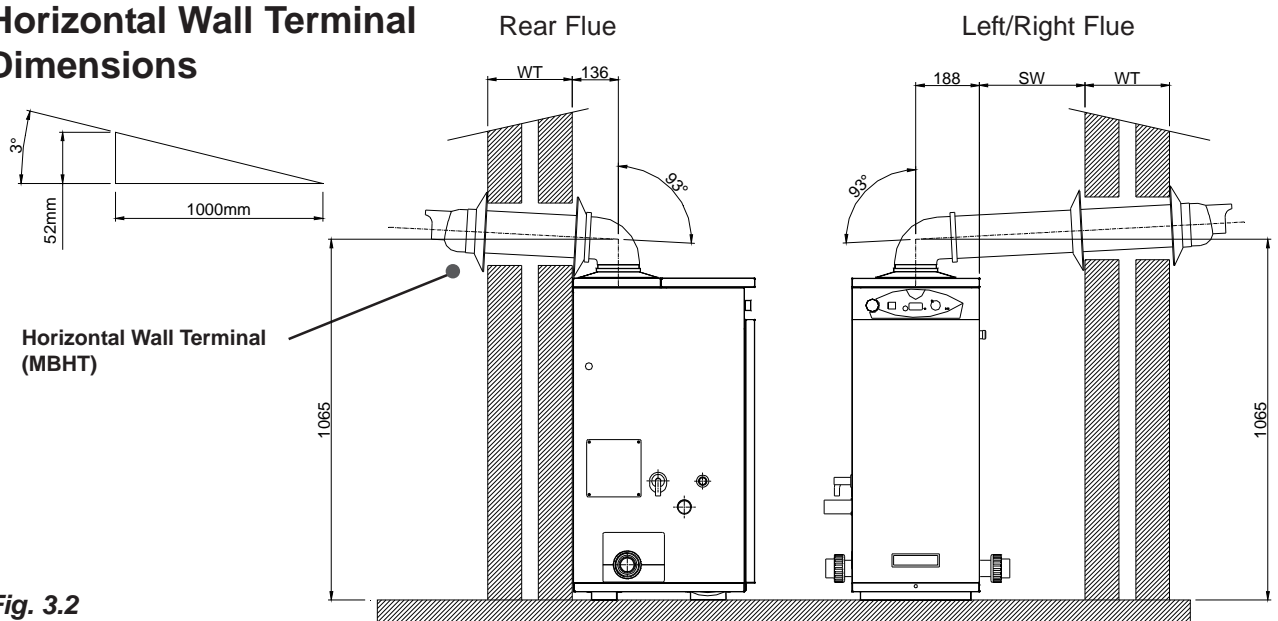

Fig. 3.2

Outdoor Terminal Dimensions

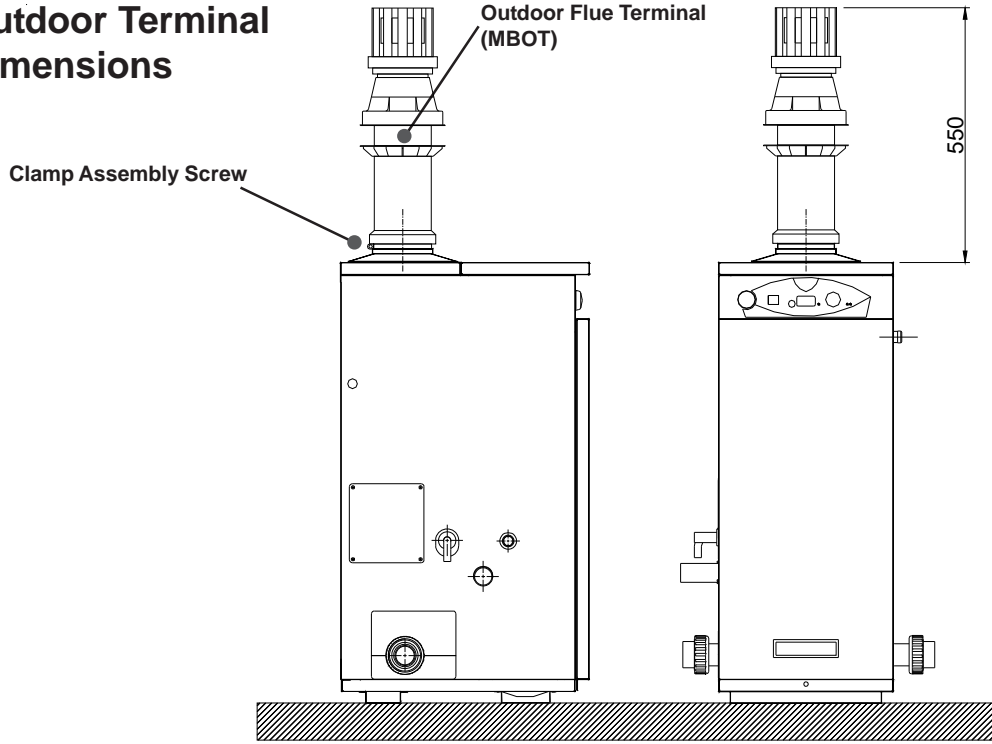

Fig. 3.3

Vertical Roof Terminal Dimensions

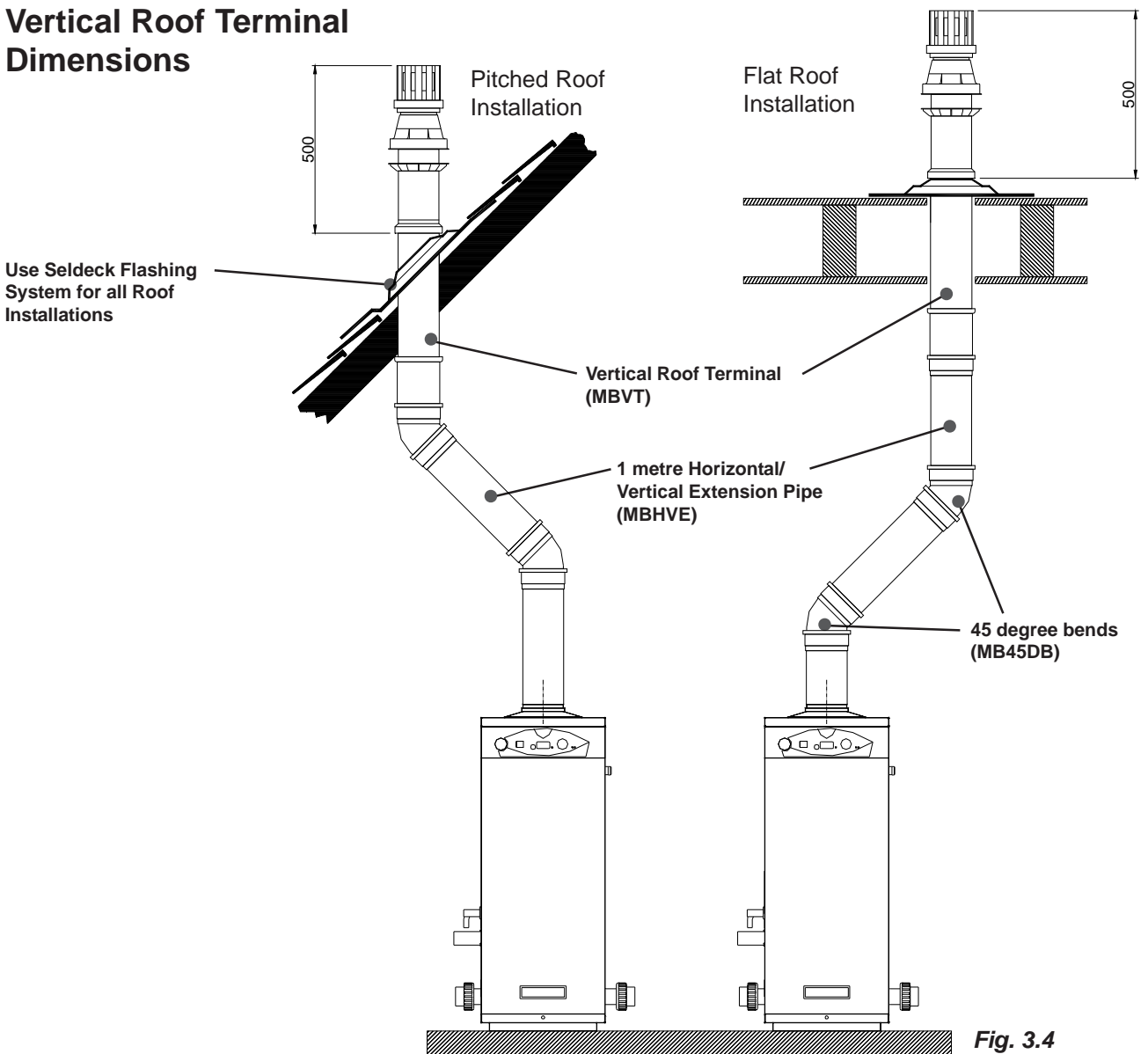

Fig. 3.4

Flue Examples

Outdoor Terminal



Extended Horizontal Wall Terminal



Extended Vertical Roof Terminal



Horizontal Wall Terminal



Flue Kit Part Codes

Determine the type of Flue system you require and choose from the list of kits available below:

Kit Code	Description	Type of Flue System		
		Outdoor Kit	Horizontal Terminal	Vertical Terminal
MBHT	Horizontal Wall Terminal	n/a	Yes	n/a
MBHVE	1 metre Horizontal/Vertical Extension Pipe	n/a	Option	Option
MBVT	Vertical Roof Terminal	n/a	n/a	Yes
MBOT	Outdoor Terminal	Yes	n/a	n/a
MB45DB	45 degree bend	n/a	Option	Option
MB90DB	90 degree bend	n/a	Option	n/a

Flue Kit Part Codes (cont.)

The Maximum Flue Equivalent Length (FEL) permitted is 20 metres, horizontal or vertical. The Flue Kits available below list the FEL for each component. Add up all the FEL's used in your design and check that this does not exceed 20 metres. (see page 6)

Kit Code	Description	FEL Flue Equivalent Length (m)	Photo of Kit
MBHT	Horizontal Wall Terminal	3.9m	
MBHVE	1 metre Horiz./Vertical Extension Pipe	1.0m	
MBVT	Vertical Roof Terminal	3.3m	
MBOT	Outdoor Terminal	n/a	
MB45DB	45 degree bends (pair)	1.1m (per bend)	
MB90DB	90 degree bend	1.5m	

1. Ensure the required service clearance is available.
2. Fit the 90 degree elbow to the heater and measure from its outlet face to the wall.
3. Add 5 mm for every 100 mm distance to 1065 mm.

Example:

Distance measured = 480 mm
 $(5 \times 480) / 100 = 25 \text{ mm}$
 Flue centre $1065 + 25 = 1090\text{mm}$

If it is required to reduce the length of the Terminal the minimum overall length is 300mm. The Flue duct should be cut 10mm longer than the Air duct.

Terminal Guard

The flue products from this appliance are very low temperature so a guard is only required if the terminal is in a position where it may be damaged. A suitable guard is available from:

TFC Ltd. 01732 351555, Model DK6

Roof Terminal

The Vertical Roof Terminal should be fitted in a minimum of 300mm clear unobstructed space. It is not permitted to alter the construction of the Terminal, above the roof line, however the concentric section below the roof line can be altered to suit the installation.

It is recommended that:

1. The Installation of the flues are completed before their connection to the Heater. This will ensure that any debris that gets into the flues can be cleared.
2. That bends in vertical flues are 45 degrees.
3. Flues may be reduced in length by cutting. The inner Flue pipe should be cut so it is 5 to 10mm longer than the outer Air duct. It will ease assembly if the cut edges are cleaned, chamfered and greased before assembly.

Plumbing

The heater requires water flow and pressure to operate properly. It must therefore be installed downstream of the filter and pump. A typical installation is plumbed as follows:

1. The Pump outlet is plumbed to the inlet of the Filter.
2. The outlet side of the Filter is then plumbed to the inlet of the Heater.
3. The outlet of the Heater is plumbed to the return line to the pool or spa. The Pump, Filter and Heater are plumbed in series.

If it is necessary to install a valve on the return to the

pool then it is recommended that a flow switch is installed and interlocked with the Heater supply. The Heater must be located so that any water leaks will not damage the structure of adjacent area. There is no requirement for heat shunt connections to the Heater, plumbing can be made in standard plastic 1½" or 50mm pipe from the supplied demountables

Use the pressure loss chart on page 5 to specify a suitable pump.

Connection to the Heater can be made from either left to right, or right to left, it is supplied with the 'From Pool' connection on the left. To change, undo the demount connection on the **right**, complete with blanking plates, and swap with the connections on the **left**. Ensure that the Pool Sensor is correctly positioned in its pocket after the change.

Flow Rate

The Heaters have a very low resistance to the Pool Water flow and will tolerate a wide range of flows.

**The minimum recommended flow is:
80 litres/min**

Pressure Switch

The Heater is protected by an adjustable water pressure switch that has to close before the Heater will operate.

It is very important to verify that it turns off when the water flow is interrupted.

It has an adjustment range equivalent to ± 1.5 metres. The switch is factory set for most conditions but can be altered if required:

1. With the pump on turn the knurled nut clockwise until a click is heard.
2. Turn the nut anti-clockwise a quarter of a turn.
3. Turn the pump on and off to check the switch operates correctly.



Fig. 5.0

Conversion to LPG

The Heater can be converted on site. NG to Propane, or Propane to Butane.

1. With the Gas and Electrical supply off, undo the three screws that hold the Venturi to the Gas Valve. (See Fig.6.0)
2. Allow the Gas valve to drop and gently hang on its cables.
3. Fit the Conversion Orifice into the Rubber Seal that sits in the Gas Valve. (See Fig.6.1)
4. Re-assemble the Gas Valve and Venturi.
5. Affix the new LPG Serial Number Data Label supplied over the existing.
6. Turn Gas on and check for leaks.
7. Fire Heater and allow to run for 5 minutes before checking and adjusting the CO₂ with the Throttle.
8. Replace the Sealing Cover over the Throttle. (See Fig 6.0 and Datable inside cover)

LPG to NG Conversion

The method is as detailed above except the Orifice is removed and the Venturi and Gas Valve reassembled with just the Rubber Seal between them. A new Serial Number Data Label should be obtained from the manufacturer and affixed over the existing.

Gas Connection

The 22mm copper gas connection provided can be positioned to exit the Heater from either the left or the right. A minimum of 20mb. (NG), 37mb (propane) 28 mbar (butane) must be available at the Heater inlet, with the Heater and other connected appliances firing. Check for gas tightness (B.S. 6891: 1988) in pipework to boiler using a manometer. (See Fig. 6.2) Gas and combustion soundness within the Heater should be checked using sense of smell and leak detection fluid. Check the maximum rate and combustion are to specification.

See Table 6.0 and Datable Inside Cover.

Rating Table (1040 Btu/ft³) (38.8 MJ/m³)

<i>kW gross</i>	<i>Btu/h</i>	<i>sec/ft³m³/2 mins</i>	
7.5	25590	145	0.023
12.5	42650	87	0.039
20	68240	55	0.062
34.6	108055	31.5	0.107
52	177420	21	0.161

Table 6.0

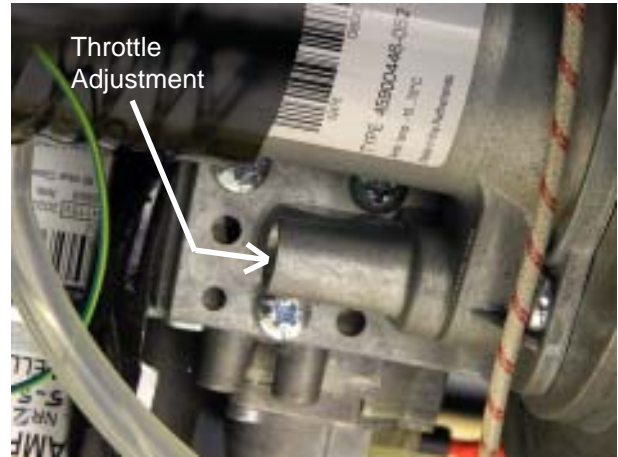
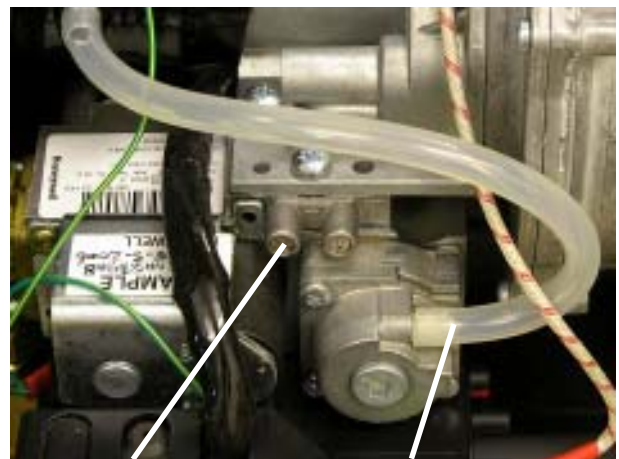

Fig. 6.0



Orifice in position

Fig. 6.1



Inlet pressure tapping

Offset connection

Fig. 6.2

Condensate Connection

The direction of the plastic condensate drain pipe connection can be altered from the factory position on the left, to the right.

- Remove the blanking plate from the left hand side (**See Fig. 3.1**)
- Loosen the two screws holding the Trap bracket and swivel the trap through 90 degrees.
- Secure the bracket and fit the supplied 40 mm pipe.
- Example installations are shown in **Fig 7.0**.
- Fit blanking plate to the right hand side. (**See Fig 7.1**)

Where possible an internal termination of the condensate discharge pipework should be used. If this is not possible external pipes should be kept as short as possible and insulated.

Where fitted in pipework that includes another trap or a pump, for example the filter backwash pipework to drain, an Air Break should be fitted between the Heater and that pipework.

Avoid connecting to a kitchen sink trap as the solids and fats in the drain will cause a blockage.

It is permissible to connect to an external gully or rain water hopper provided they connect to a combined system.

The condensate should not be run into a 'grey water' recycle system.

If the condensate pipe is connected to a stack it should join not less than 450 mm above the foot of the stack. In addition it should be positioned so there is no chance of cross-flow to another connection.

Installation pipework must be in 1¼" or 40 mm Hunter plastic pipe to a suitable drain location with a gradient of 2.5° (45mm/ metre run) minimum. If connected to another drainage trap, an air break is required between the Heater drain and that trap. (**See Fig.7.0 & 7.1**). External runs, should, if possible, be insulated to defer problems from freezing.

Check during commissioning that there is a leak free working connection from the Heater to the drain. The simplest way to do this is to carefully pour some water into the boiler flue and check it emerges at the drain. This will also fill the trap ready for operation.

The "Guide to the Condensing Boiler Assessment Procedure for Dwellings" can be referred to, see <http://www.planningportal.gov.uk/england/professionals/en/1115314255842.html>

Electrical Connections

WARNING: The appliance MUST be earthed.

All wiring for the Heater and system controls MUST conform to I.E.E. Wiring Regulations, and work should be tested using a suitable meter, for Earth Continuity, Polarity, Short Circuit and Resistance to Earth.

The Heater supply must be through a common isolator, a double pole 3A fused isolating switch with a contact separation of 3mm minimum on both poles.

The cable used should be no less than 0.75mm² to BS.6500 PVC, 3 core, and fixed ensuring the earth connection is longer than the Live and Neutral.

Access to the Heater connections is made by the removal of the Front Top Panel and the Electrical Chassis cover, two screws.

The simplest and most flexible control scheme is to use a Certikin CCP01 Control Unit. This provides an electrical safety trip and timer with outputs for the Heater, lights and an auxiliary voltage free output. It is pre-wired and tested and provided in a standard IP55 plastic control box.

The Heater's internal wiring is shown in **Fig.11.0**.

Connections are as follows :-

4 Way Terminal

⊥
N
SL
L

Supply Connection

Earth
Mains Neutral
Switched Live
Permanent Live

A factory installed link has been fitted between SL and L which should be removed if the Heater is to have its own switched supply.

For systems using an external programmer, the electrical wiring should follow the relevant control manufacturer's recommendations, with the switched live from the controls returning to SL in the 4 way push-fit connector.

It is possible to connect several Heaters together using the Multiple Heater Kit. Details for the parts and installation of this kit are given on Page 17.

Example Condensate Disposal Methods

Note: Do not reduce the pipe size below the 40mm provided.

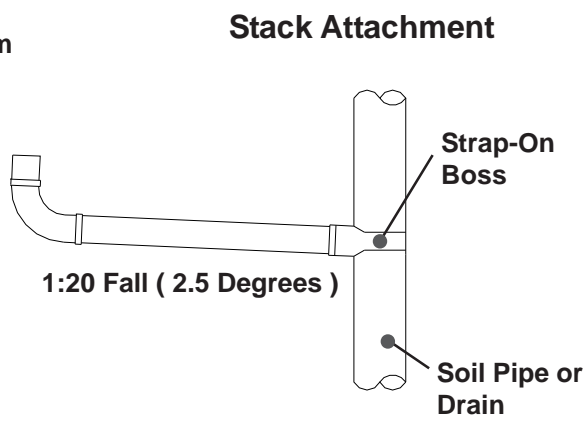
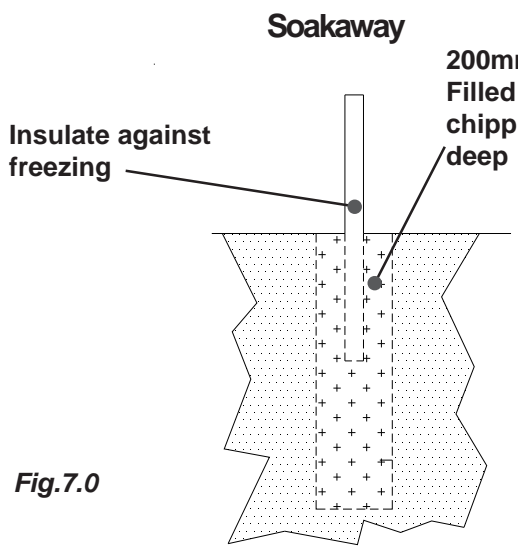

Condensate Syphon (75 mm)

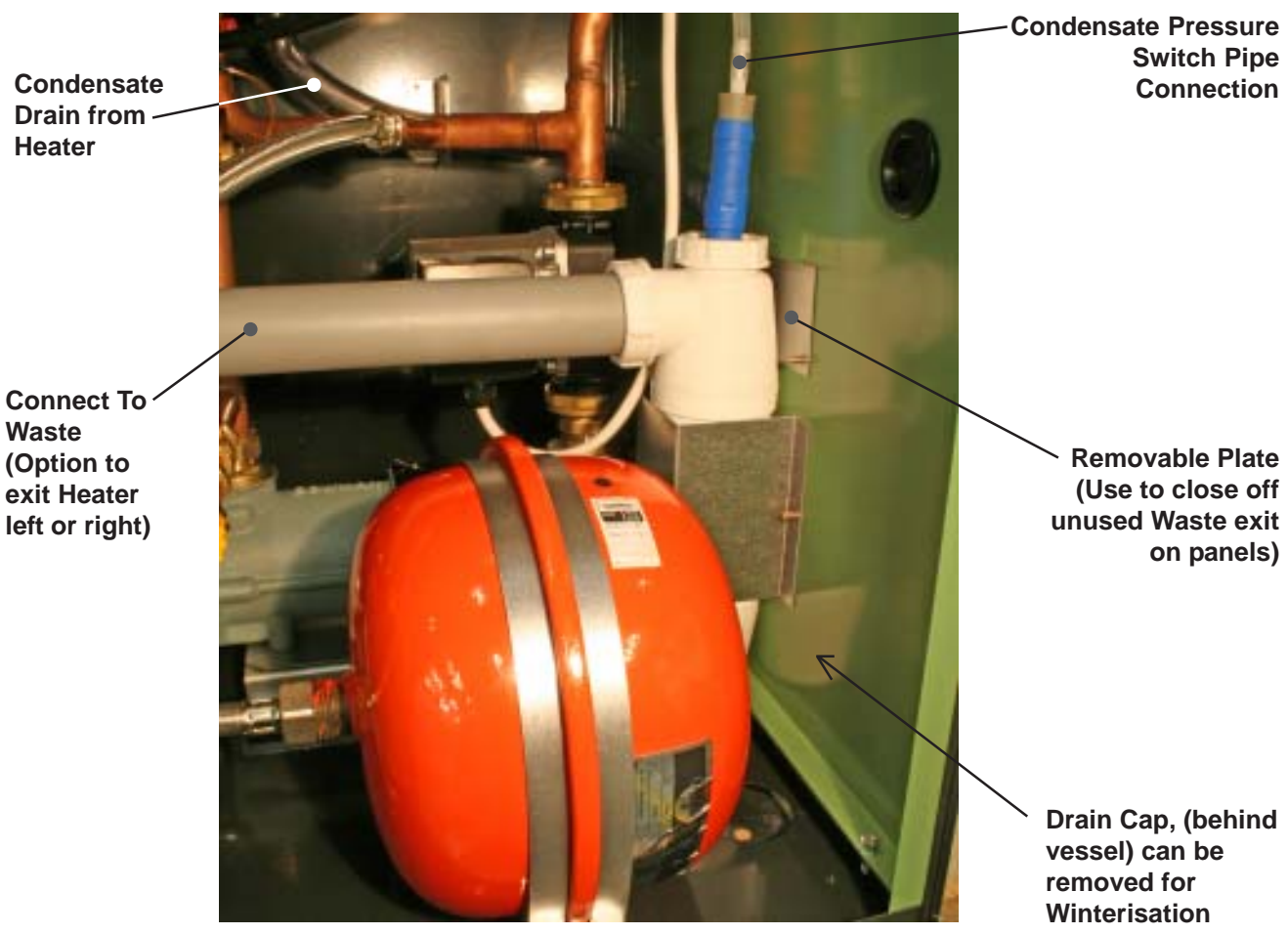

Fig.7.1

Commissioning

General

IMPORTANT The heater primary contains **Sentinel X500 inhibitor/anti-freeze**. The minimum water should be released during filling to maintain its concentration.

The elimination of air from the heat exchanger is essential to maximise the life of the Heater. It is strongly recommended that the Heater is first run with the **GAS OFF** until the air has been purged. If air has not been released then there is a possibility of the Heater overheating and triggering one of its safety thermostats. An Air Vent is provided on the top of the Heat Exchanger (**See Fig 8.0**) to assist its removal. It is opened and closed by rotating the front connector. A second is a standard radiator vent in the righthand Side Panel. A button has been provided to just run the internal pump (**See Fig 8.1**) to aid de-aerating. It requires that the Mains in connected and on, the Pool Pump need not be. See Page 6 for more details.

Commissioning Procedure

The Heater Control is factory set to display in Fahrenheit and work to a maximum temperature of 90°F (32°C). If a Centigrade display or higher temperature 106°F (41°C) maximum is required, enter User Setup Mode. (**See Page 16**)

The boiler is factory set for Natural Gas and fitted with automatic ignition and will start when the gas cock is open, mains is connected and the Pressure Switch is activated by the pool Pump. (for greater detail about the internal controls see the Maintenance section,



Fig. 8.0



Fig. 8.2

Fault Diagnosis)

LPG models require to be modified as described on page 12. It is recommended that the condensate trap is full of water before firing. If the Heater fails to light the gas it will shutdown and try again. It will repeat this a total of 5 times and then locks out. This will show as the **Red LED** lit and **'GAS'** on the display. Press the Lock/Reset button to start another 5 attempts.

It is possible with the front door off to see when the burner is lit through the sight glass. (**See Fig. 8.2**) After the burner has been lit for a few minutes the gas rate and combustion should be checked, see the **Technical Data on Inside Cover** for details. The Heater is factory set and should not require adjustment. When the Heater has been running for at least 10 minutes check all joints, gas and water, for leaks, and correct where necessary. When running satisfactorily, complete the commissioning details on the inside back page of these instructions.

Note: The boiler is fitted with a syphon trap that includes a blocked drain detection device. This is to safeguard the boiler from a blockage or the possible freezing of the condensate pipework in extreme weather. Should this happen the control will lockout and the display will show **'HI'**, as in "condensate level is high". See the Fault Finding section for more details. This will have to be corrected before the Heater will run. The user should be made aware of this feature and, that in the event of blocked or frozen condensate pipework, the boiler will automatically stop functioning. It will start again as soon as the blockage has cleared. Finally, instruct the user on Heaters operation and controls.



Fig. 8.1

Button

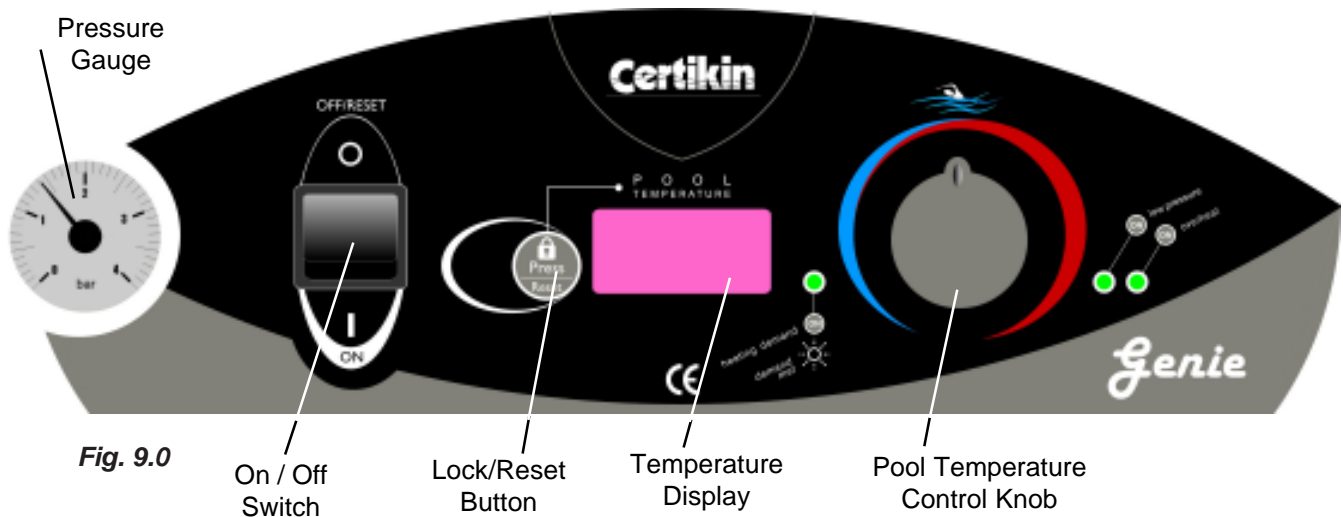



Fig. 9.0

On / Off Switch Lock/Reset Button Temperature Display Pool Temperature Control Knob

User Setup Mode Setting		Factory Setting	Alternative	Display Indicator
1	Display units	° F = Fahrenheit	° C = Centigrade	° F or ° C
2	Maximum temperature	32 °C (90 °F)	41 °C (106 °F)	PL or SPA
3	Software Version			e.g 011

User Setup Mode

Switch on with the panel switch whilst pressing the Lock/Reset button  then release. The control is now in Setup Mode.

The control can now be altered by rotating the Pool Temperature Control Knob to a certain position and then pressing the Lock/Reset button,  then switching off. (**See Fig. 9.0**)

Example:

To change from Fahrenheit to Centigrade:

Turn Panel Switch OFF then back ON whilst pressing the Lock/Reset  button.

Turn the Pool Temperature Control Knob until the display shows 'F'.

Press the Lock/Reset button  once and the display will show 'C'.

Switch the Panel Switch OFF then back ON again.

The Control will now display in Centigrade.

Multiple Heater Kit

Overview

It is possible to connect together several Heaters and by doing so obtain a larger output with an economical and a fail-safe design. The Multiple Heater Kit enables 2 or more Heaters to be connected to obtain the necessary Load Sharing, automatically. This works by one Heater being a Master and the others being Slaves. The Master is set for the required pool temperature and it then controls as many of the Heaters as necessary to obtain the temperature. It also equalises the running time of every Heater so they all do the same amount of work.

Kit Part Codes:

2 Heaters:	MBMIK2
3 Heaters:	MBMIK3
4 Heaters:	MBMIK4
5 Heaters:	MBMIK5
6 Heaters:	MBMIK6
7 Heaters:	MBMIK7
8 Heaters:	MBMIK8

Installation Instructions

- Disconnect the Heater from the Mains then remove the Top Panel and the Electrical Chassis Cover.
- Remove Pool Thermostat Control Knob
- Remove Pool Thermostat Board by removing retaining plate and carefully slide out until fully accessible. (**Fig. 10.0**)
- Carefully fit the Adapter PCB in the space behind the Pool Temp. Display on the Board (**Fig. 10.0**) ensuring that the six pins on the Board pass through the underside of the Adapter PCB and, that the plastic locking pillars snap into place. Refit Pool Thermostat Board and Knob.
- Repeat steps 1) and 2) for all the Heaters.
- Using the supplied cables, pass them through the upper side panel grommet and daisy chain the Heater Adapter PCBs together. The first and last Heater in the 'chain' will use the Terminator Plugs to fill their 2 unused sockets. There are 2 different coloured Terminators, they can go in either the first or last Heater. NB. Ensure the connectors are fully home (**Fig. 10.1**)
- Choose which Heater is to be the Master and then make the rest Slaves by disconnecting their Pool Temp Sensors. Remove the leads to the Pool Temp Sensor from the six way terminal strip on the electrical chassis and tie back in a safe place. (**Fig. 10.2**)
- Any external electrical control should only be connected to the Master, Pool Demand. Remove any Pool Demand links from the Slaves.

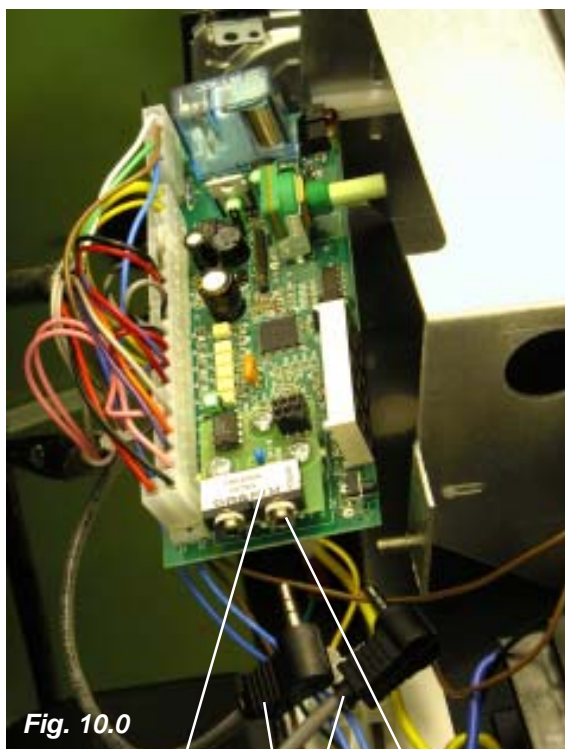

Fig. 10.0

Adapter PCB

Connectors

Interconnection Cables



Fig. 10.1

- Turn on the Mains, then switch on all the Heaters. After a short self-test the Master should show the actual temperature, and the Slaves three dashes “---”. If a Slave continues to show a moving display of dashes this indicates it not correctly connected to the Master, check the Interconnection cable plugs are fully home.
- Replace the panels.

Operation

- Turn on all the Heaters with their Pool Temperature Controls.
- The Master will show temperatures and the Slaves “---”.
- Set the required temperature on the Master and provided there is an electrical demand at the Master’s Pool Demand connection, the Heaters will run.

Features

- A Master is the only Heater with a Pool Sensor connected, move the sensor and the Master changes.
- If the Master Pool Temperature Control is turned off, none of the Heaters will run.
- If a Slave’s Pool Temperature Control is turned off it will not operate. The Master will know and alter its control accordingly.
- If a safety device on the Master operates it will not run but will continue to control the Slaves.
- If the Master Control fails the ‘system’ will fail. Change the Master to a Slave and one of the Slaves to a master to enable the system to run again.
- If a safety device on any of the Slaves operates that Slave will not operate.

- If a Slave has Flow fault which its Pressure Switch detects the burner will stop immediately and the Filter LED will light. It will no longer be available to the group. It will then check every 3 minutes or so to see if the problem has been corrected, the Filter LED will flash. It will put itself back in the group if flow is satisfactory.
- The Master display can be altered in Setup Mode like a single Heater. (see Page 16)
- Unlike a single Heater, there is no modulation of individual burners.

Displays

- The Master display is just like a single Heater.
- A Slave will display “---” when working as part of the group. It will show all the fault conditions of a single Heater except “P/oc”, the Pool Sensor Open Circuit fault. If this is displayed it indicates a interconnection problem, check the cables and connectors.
- The Pool Demand LEDs work as a Single Heater. On when running, Off when off, and Flashing if not needed by the Master.
- The warning LEDs work for all in a group, as per a single Heater.

Pool Temp Sensor wires



Fig. 10.2

Wall Mounting Kit

Overview

The Genie 35 and 50 models can be wall hung using the Wall Mounting Kit.

Kit Part Code: MBWMK35/50

Instructions

- Select a suitable wall and position to mount the Heater. (Note the Heater weighs 40kg.)
- Screw the Top Wall Mounting Bracket level to the wall. (*Fig 10.4*)
- Attach the Top Handle Bracket to the rear of the Heater by using the 3 M4 screws supplied. (*Fig 10.5*)
- Attach the Bottom Wall Mounting Bracket to the rear of the Heater by using the existing 3 gold screws that fix the base to rear panel. (*Fig 10.5*)
- Hang the Heater on Top Wall Mounting Bracket locating it on the two 5mm studs.
- With the Heater now in position drill and screw the Bottom Wall Mounting Bracket to the wall. See (*Fig 10.4*)

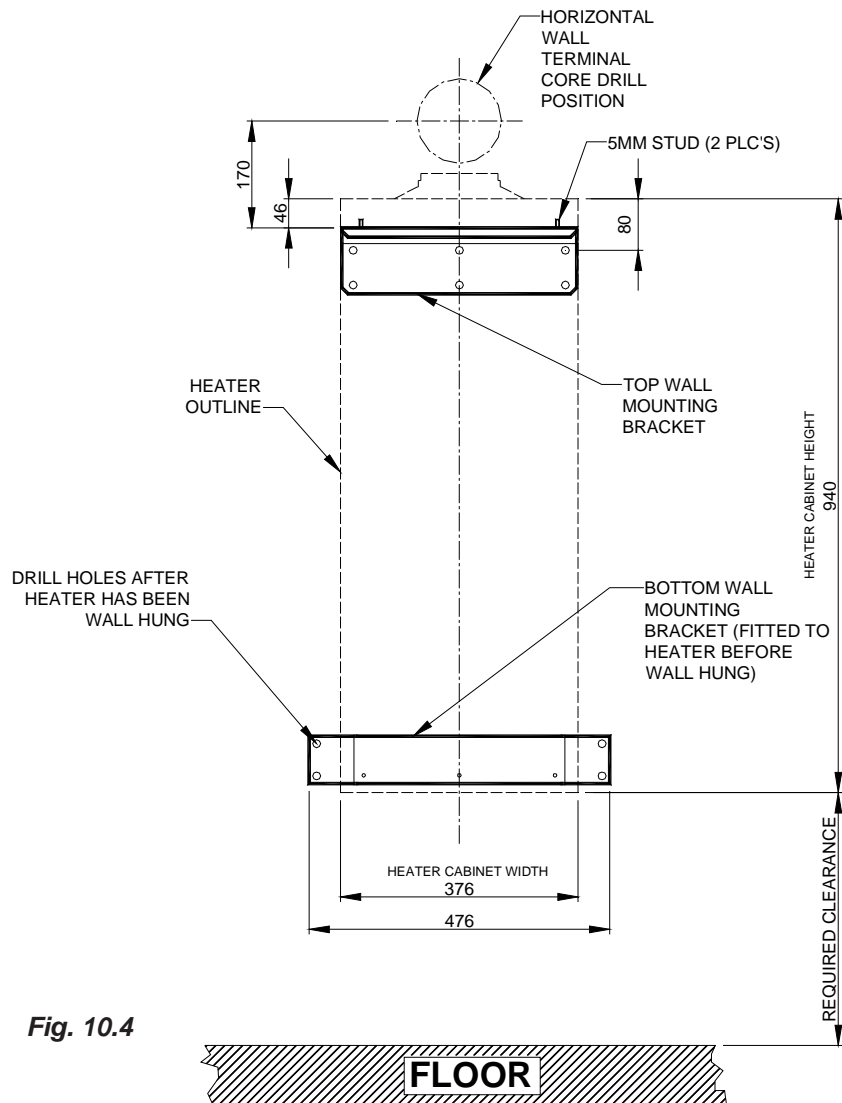
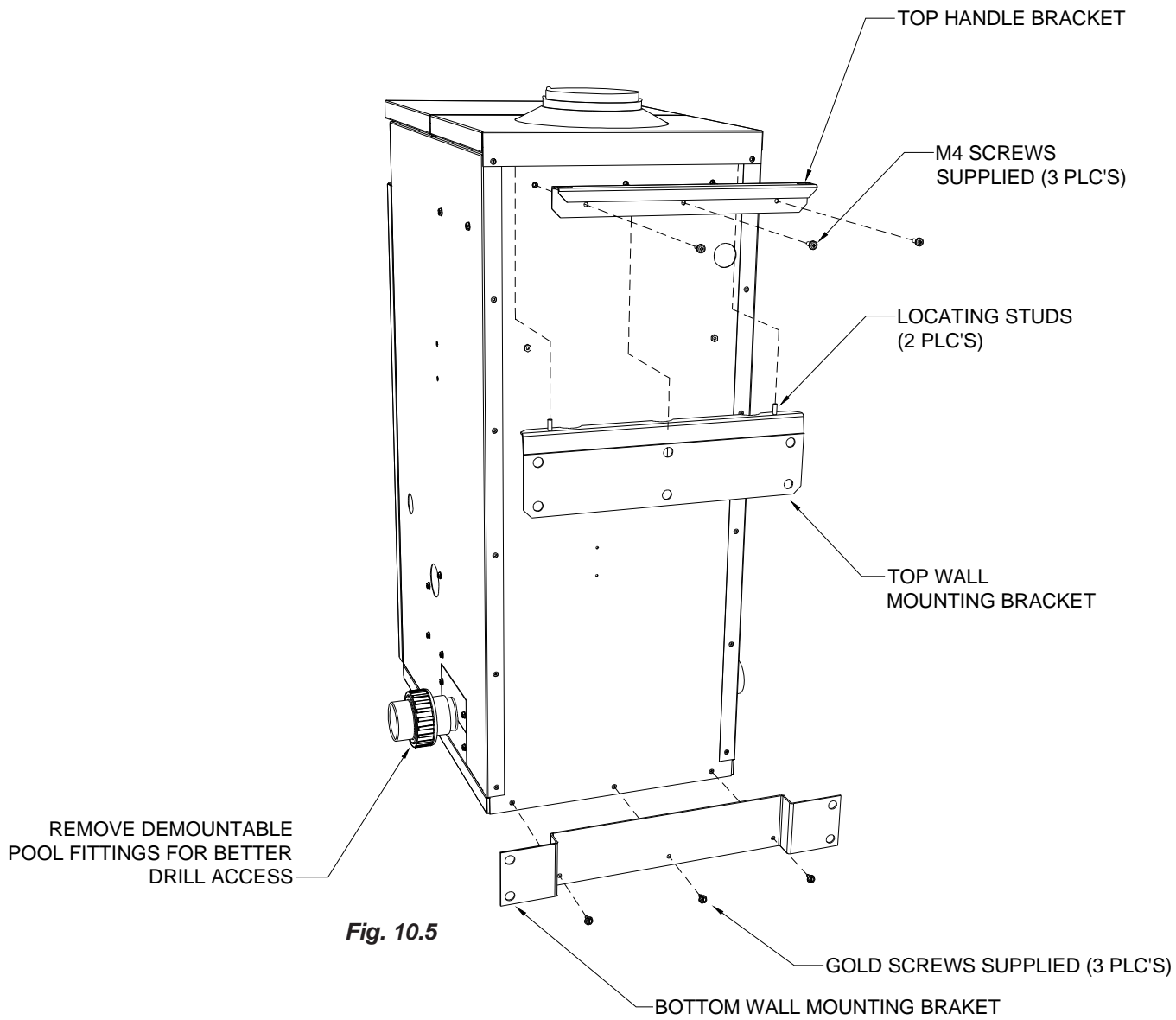

Fig. 10.4



Schematic Wiring

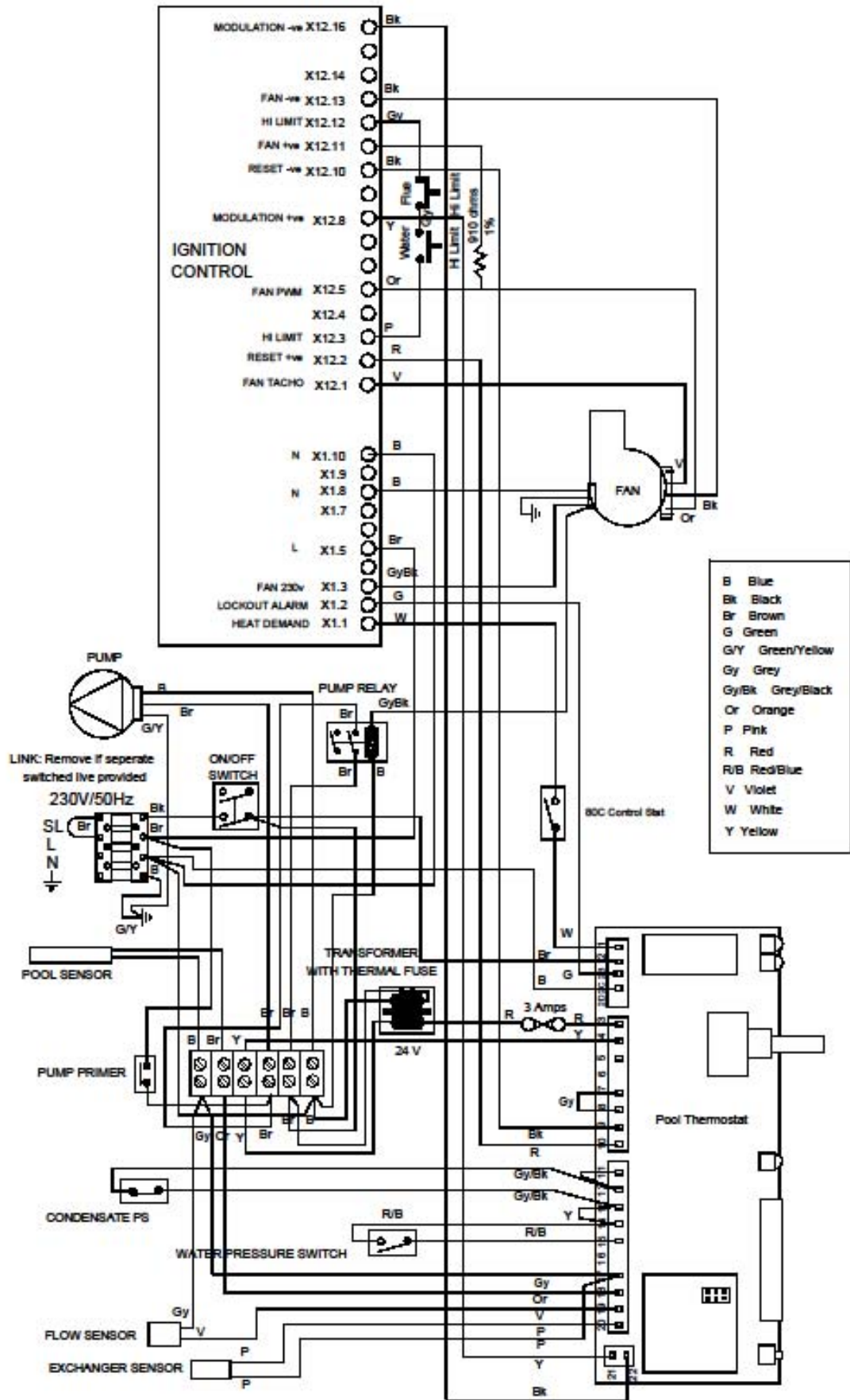

Fig.11.0

FAULT FINDING

WARNING: BEFORE COMMENCING OR COMPLETING ANY ELECTRICAL WORK ON THE APPLIANCE, IT IS RECOMMENDED THAT THE BASIC SAFETY CHECKS FOR EARTH CONTINUITY, SHORT CIRCUIT, POLARITY AND RESISTANCE TO EARTH ARE MADE. ALL WORK CARRIED OUT SHOULD FOLLOW GUIDELINES LAID DOWN BY THE I.E.E.

Operation

The Heater requires Mains on both the Live (L) and Switched Live (SL) connection to be able to run. It is delivered with a link between them which can be removed if a separate Heater switched live is going to be used. To run, the Heater must have a Mains supply, Gas, Pool Pump pressure sufficient to activate the Pressure Switch, all safety switches closed and a pool temperature below the set point.

If all the above are correct then the Gas Ignition Control starts the Ignition sequence:

1. The Fan and internal Pump runs as a pre-purge of the Heat Exchanger
2. After a few seconds a spark is created at the electrode and the burner is lit.
3. The burner flame is sensed and the spark is removed.
4. The Fan speed is then changed to the required speed according to the modulation curve.
5. If it fails to light the burner the spark will stop and the Fan and internal Pump will run on as a post-purge of the Heat Exchanger.
6. The ignition sequence will be repeated up to five times, then the control will lockout and will require a reset to start again.

Safety Controls & Lockouts

The Pool Thermostat Control indicates the actual and set temperature of the pool and also displays all the lockouts. The next pages detail the fault conditions, the indicators, the display and the actions required.

User Setup Mode

Turn off on the Panel Switch. Turn on with the Panel Switch whilst pressing the Lock/Reset Button.  The Control is now in User Setup Mode. See Page 16 for details.

Service Mode

This is a special mode used to set the operation of the Control and to investigate fault conditions, it is entered from User Setup Mode.

Rotate Pool Thermostat knob fully clockwise to show the software version number.

Press the Lock/Reset Button  for 3 seconds. The control is now in Service Mode.

It is now possible to change some of the Control's parameters. To show them, rotate the Pool Thermostat Potentiometer. To zero or change them, press the Reset/Lock button 

To exit, turn the Panel Switch off then back on again.

	Service Mode Setting	Factory Setting	Reset press	Display Indicator
1	Pressure Log	Number of Operations	Resets to zero	Yellow LED ON
2	Unused			Red LED ON
3	Combustion Gas Log	Number of Operations	Resets to zero	OH2, Red LED flashing
4	Gas Lockout Log	Number of Operations	Resets to zero	GAS, Red & Yellow LED ON
5	Condensate Blocked Log	Number of Operations	Resets to zero	HI, Front Red PCB LED ON
6	Unused			Rear Red PCB LED ON
7	Hours run	0	Press resets to zero	156 =1560 hrs both PCB LEDs on
8	Display	td0	td1	td0 / td1

Test Temperature Display Mode 1 (td1).

Temperatures are displayed to 0.1 degree resolution, not the normal 1 degree.

The display will now show each sensor temperature and cycle around them for each press of the Lock/Reset button.











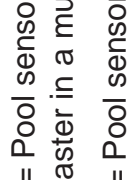



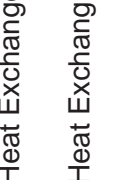

1. Pool Temperature as normally displayed. The Green LED will be alight.
2. Pool Temperature is displayed to 0.1 degrees. The Green LED will be alight.
3. Heat Exchanger Flow Temperature. The Yellow LED will flash rapidly.
4. Heat Exchanger Combustion Temperature. The Red LED will flash rapidly.

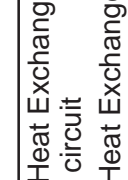
Rotating the potentiometer will change the set temperature. Pressing and holding the button whilst one of the temperatures is displayed will 'lock/unlock' it on the display for continuous observation.

Fault Codes

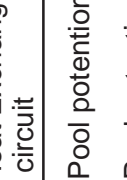
FRONT PANEL		ON PCB		EXPLANATION			
LOCK / RESET	DISPLAY	GREEN	YELLOW	RED	RED LED1	RED LED2	
○		○	○ ○ ○	○	□	□	Flashing
○		●	○ ○ ○	○	□	□	OFF, no mains supply or failed power supply
○		●	○ ○ ○	○	□	□	Running, raising pool temperature to 28°C
○		●	○ ○ ○	○	□	□	Up to temperature, 28°C
○		○	● ○ ○	○	□	□	Insufficient water pressure. Filter?, Blockage?
○		●	○ ○ ○	○	□	□	'SEr' alternating with pool temperature. Service required, working hours has reached setpoint.
●		○	○ ○ ○	●	□	□	'OH2' Flue gas over temperature. Allow to cool then investigate in Engineering Mode. Reset with Button
●		○	● ○ ○	○	□	□	'GAS' Gas Control Lockout. Unable to light burner, reset with Button. OR Flue Stat tripped. Investigate cause. Reset on Flue Stat
●		○	○ ○ ○	○	□	■	'HI' Condensate level high. Blocked? Clear obstruction and allow control to auto reset .

Fault Codes

FRONT PANEL		ON PCB		EXPLANATION
LOCK/RESET	DISPLAY	GREEN	YELLOW	
				'P' alternating with 'oc' = Pool sensor open circuit OR No network detected if a Master in a multiple heater installation
				
				'P' alternating with 'cc' = Pool sensor short circuit 'F' alternating with 'oc' = Heat Exchanger Flow sensor open circuit
				
				'F' alternating with 'cc' = Heat Exchanger Flow sensor short circuit 'H' alternating with 'oc' = Heat Exchanger Combustion sensor open circuit
				
				'H' alternating with 'cc' = Heat Exchanger Combustion sensor short circuit 'Err' alternating with '4' = Pool potentiometer open circuit 'Err' alternating with '5' = Pool potentiometer short circuit
				

For all of the above. Turn off, correct problem and turn back on again and the display and operation will be normal.

SERVICING

Health and Safety Statement :

This Heater contains no asbestos.

Routine Service

To ensure continued efficient operation of the appliance it is recommended that it is checked and serviced at regular intervals.

The frequency of servicing will depend upon the particular installation and usage but in general every 2000 hours of operation should be the maximum. It is law that any service work should be carried out by Corgi registered personnel.

1. Clean burner and combustion chamber.
2. Check condition of ignition spark and sensing probe.
3. Check boiler pipework joints for leaks.
4. Check the Air duct and Flue seals.
5. Check condensate syphon and pipework for leaks.
6. Check the Gas Rate.
7. Check the combustion CO and CO₂.
8. Reset the Service Hours counter in the control.

Follow the procedures given in Changing Components for parts removal in addition to the following notes. In all cases, before work commences turn off the Mains Electricity and Gas Supply.

Burner & Combustion Chamber

To view the burner and the inside of the Heat Exchanger it is suggested you remove the front of the Heat Exchanger complete with the Fan and Gas Valve:

- Remove Door and Front Top Panel
- Disconnect Gascock flange form Valve.
- Unplug Fan electrical connectors.
- Remove Air tube from Flue Adapter.
- Undo cover over Ignition Control connections and remove the two connectors.
- Pull off the Earth Lead connection on the Valve and Heat Exchanger.
- Undo the four nuts holding the Heat Exchanger front and withdraw.
- Assembly is the reverse.
- Reset the Service Hours Counter. (**See Service Mode, page 22**)

Spark & Sense Electrode

- Turn off the Heater.
- Pull off the HT Lead.
- Undo the two screws retaining the electrode assembly and carefully withdraw.
The spark gap should be 3.0 mm ± 0.5.
(**See Fig 12.0**)
- Assembly is the reverse, ensure the gasket is correctly placed.

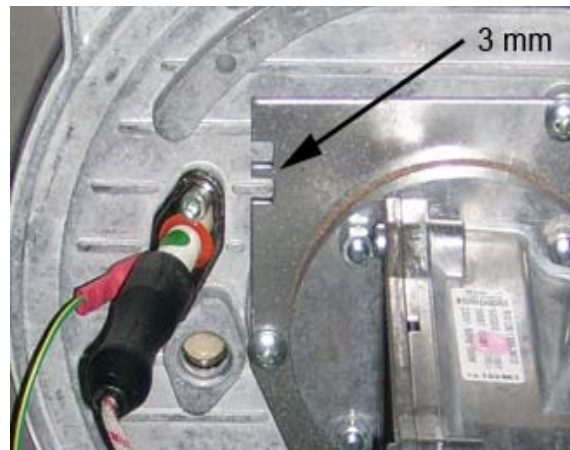

Fig 12.0

Pipework

IMPORTANT. The Heat Exchanger connections are made using O rings and should not be strained in any direction. Any strain will result in damage to the Heat Exchanger and will not be covered by the warranty.

All plastic pipework joints are solvent welded and cannot be remade but have to be replaced.

Condensate Syphon

The lower bowl of the Syphon can be unscrewed, examined and cleaned.

Air Duct & Flue Seals

A visual inspection should establish there are no leaks around any of the seals, including the flexible Air Duct to the Venturi.

Gas Rate & Combustion

See the Datatable on Page 1 for the correct values.

A Combustion sample point is provided on the front of the Flue Adapter. (**See Fig.14.1**)

Changing Components

THERE IS ONE FUSE, THE REMAINDER OF THE CONTROLS ARE NOT REPAIRABLE AND IF NOT WORKING MUST BE REPLACED.

In all cases, before work commences turn off the Mains Electricity and Gas Supply. The following items can be replaced:

- Fuse, 24V supply.
- Transformer.
- Pool Thermostat.
- Condensate Pressure Switch.
- Relay.
- Pool Temperature Sensor.
- Heat Exchanger Flow Sensor.
- Water Pressure Switch.
- Control Thermostat.
- Overheat Thermostat.

- Heat Exchanger Combustion Temperature Sensor.
- Flue Thermostat
- Ignition Control.
- Gas Valve.
- Fan.
- Pump.
- Heat Exchanger.
- Secondary Heat Exchanger.

On the Electrical Chassis

To access these items first remove the Front Top Panel and then the Chassis Cover.

Fuse (See Fig. 13.0)

There is one inline 3A fuse on the 24V supply between the Transformer and the Pool Thermostat. The Fuse Holder bayonets apart to allow its replacement.

Transformer (See Fig. 13.0)

The Transformer includes its own, internal thermal fuse on the primary. If this has gone open circuit the cause should be established before replacing the Transformer.

- Disconnect from the terminal strip and fuse holder.
- Undo the two screws holding it to the chassis and replace.

Pool Thermostat (See Fig. 13.0)

- Pull off the Pool Thermostat Knob.
- Release the Rear Retainer by undoing the Wing Nut.
- Pull off all the PCB connectors.
- Slide out the Thermostat.
- Replacement is the reverse.

Condensate Pressure Switch

(See Fig. 13.0)

- Undo the single fixing screw.
- Pull off the two electrical connectors and transfer to the new Switch. They connect to the 'C' and 'NO' connections.
- Replacement is the reverse

Relay

(See Fig. 13.0)

- Pull off the three electrical connectors and transfer to the new Relay.
- Undo the two fixing nuts and secure new relay in position.

Heater Components

The remainder of the parts can be accessed through the front.

Heat Exchanger Flow Sensor

This is located on the front connection to the Heat Exchanger. (See Fig.14.4)

- Unclip the sensor from the connection.
- Transfer the push on electrical connectors to the replacement and clip back on.

Heat Exchanger Pool Sensor

This is located in a pocket in the 'From Pool' side of the Secondary Heat Exchanger. (See Fig.14.6)

- Pull out the retaining slipper, and pull out sensor.
- Disconnect from the six way terminal strip on the Electrical Chassis.
- Replacement is the reverse.

Water Pressure Switch

This is located on the Inlet connection to the Secondary Heat Exchanger and its removal will require the draining or isolation of the Pool water in the Heater.

(See Fig.14.6)

- Pull off the Electrical Connectors
- Unscrew from the Secondary Heat Exchanger.
- Replacement is the reverse.

If the Water Pressure Switch needs adjustment See Page 12 for details.

Control Thermostat

This is located on the Outlet connection of the Heat Exchanger. (See Fig.14.4)

- Unclip the sensor from the connection.
- Transfer the push on electrical connectors to the replacement and clip back on.

Heat Exchanger Combustion Temperature Sensor

This is located on the top of the Heat Exchanger, on the right hand side. (See Fig.14.1)

- Release the electrical connector by pressing the latch and pulling up.
- Twist the Sensor a quarter turn clockwise and withdraw.

IMPORTANT Ensure the O ring seal is fitted correctly to the replacement before fitting.

- Replacement is the reverse.

Flue Thermostat (manual reset)

This is located on the Flue Adapter. (See Fig.14.1).

- Pull off the electrical connectors.
- Slide out from under the clip.
- Replacement is the reverse.

Ignition Control (See Fig.14.3)

- Undo the single screw holding the Ignition Control.
- Release the two electrical connectors by pressing the latch and pulling apart.
- Pull the Ignition Control away from the Gas Valve.
- Replacement is the reverse.

Gas Valve (See Fig.14.3)

- Remove the Ignition Control, see above.
- Release the Gascock by undoing the four shoulder bolts holding it to the Gas Valve.
- Remove the Offset tube from the Gas Valve and unscrew the Offset Connector and transfer to the new Gas Valve.
- Release the Gas Valve from the Venturi by undoing three screws. (See Fig.14.3)

IMPORTANT Ensure the rubber seal (and orifice if Propane) is transferred from the old Valve and placed between the Venturi and Gas Valve before assembly.

- Replacement is the reverse.
- Fire the Heater and check for gas leaks.
- After five minutes check the rate and combustion is correct to the Datatable. (inside cover). Adjust using the throttle on the Gas Valve, (See Fig. 14.3).

Fan (See Fig.14.2)

- Remove the two electrical connectors on the Fan.
- Remove the two screws holding the Venturi to the Fan.
- Undo the four nuts holding the Fan to the Heat Exchanger and withdraw. (See Fig.14.2)
- Transfer the Venturi gasket to the new fan.
- Replacement is the reverse.

Venturi (See Fig.14.2)

- Remove the Ignition Control and Gas Valve, see above.
- Pull off the Air Tube (See Fig.14.3)
- Undo the two screws holding the Venturi to the Fan and remove.
- Ensure the gasket is transferred to the new venturi or positioned on the Fan before positioning the replacement.
- Replacement is the reverse.
- Fire the Heater and check for gas leaks.
- After five minutes check the rate and combustion is correct to the Datatable. (inside cover). Adjust using the throttle on the Gas Valve if required. (See Fig.14.3).

IMPORTANT. The following components require the draining of the primary. It is recommended that it is re-filled with one litre Sentinel X500 Inhibitor/Anti-freeze to provide winter protection. It is essential that all the air is removed from the Heat Exchanger before the Heater is fired. Running the Heater with air still in it will damage the Heat Exchanger and invalidate the warranty.

Pump (See Fig.14.0)

- Drain the primary waterside of the Heater.
- Disconnect the Pump mains lead from the six way connector in the Electrical Chassis.
- Undo the two water connections of the pump and remove.
- Transfer the mains lead to the new Pump.
- Replacement is the reverse.

Heat Exchanger (See Fig.14.0)

The removal of the Heat Exchanger will require the draining of the Heater.

- Undo both the Demountable connections to the Pool pipework. (See Fig.14.5)
- Undo the screws holding the panels around the Demountable connections. (See Fig.14.5)
- Lower the pipework away from the Heat Exchanger.
- Remove the Front Top Panel and disconnect the Flue Thermostat connections.
- Pull the Air Duct and Flue up and away from the Heater Flue Adapter.
- Disconnect the Heat Exchanger Combustion Sensor by pressing the latch and pulling off.
- Remove the four screws holding the Rear Top Panel.
- Lift the Rear Top Panel with the Flue Adapter clear of the Heat Exchanger.
- Remove the Fan, Gas Valve and Ignition Controller.
- The Heat Exchanger is now only retained by the two side brackets and releasing the four front screws will enable it to be pulled forward. Before releasing ensure there is support available.
- Replacement is the reverse.

IMPORTANT: If the unit is fitted outdoors it is recommended that it is re-filled with a suitable anti-freeze, the manufacturer recommends Sentinel X500.

Secondary Heat Exchanger (See Fig.14.0)

- Drain the pool side sufficiently so that the Heaters Pool Connections can be released.
- Remove the Case retaining Plates around the Heater's Pool Connections.
- Drain the primary system with the draincock provided. Ensure an air vent is open to fully release the water.
- Remove the Pool Sensor from the Secondary Heat Exchanger.
- Remove the Expansion Vessel.
- Remove the single screw fixing the Secondary Heat Exchanger to its mounting plate.
- Remove the single fixing screw holding the Spacer below the Mounting Plate.
- Pull out forwards the Spacer and remove.
- Undo the primary Compression connections on the Secondary Heat Exchanger and allow it to drop off its connections and remove.
- Replacement is the reverse.

IMPORTANT: If the unit is fitted outdoors it is recommended that it is filled with a suitable anti-freeze, the manufacturer recommends Sentinel X500.

Spares

Item	Mfg' Part Number	Supplier Part No
Primary Heat Exchanger (Genie35)	M2136	SPMBG001
Primary Heat Exchanger (Genie 50)	M2139	SPMBG002
Secondary Heat Exchanger	M2678	SPMBG053
Propane Orifice (Genie 35)	M2150	SPMBG014
Propane Orifice (Genie 50)	M2151	SPMBG015
Fan	M2138	SPMBG003
Gas Valve	M2140	SPMBG004
Ignition Control	M2141	SPMBG005
Pool Thermostat PCB	M2155	SPMBG057
Relay	M2688	SPMBG054
Pressure Gauge	M4240	SPCOH2/003
Water Pressure Switch	650634	SPMB506
HT Lead	M2142	SPMBG006
Condensate Syphon	M2143	SPMBG007
Condensate Pressure Switch	M2144	SPMBG008
Spark & Sense Electrode	M2146	SPMBG010
Flue Thermostat	M2147	SPMBG011
Control Thermostat	M2667	SPMBG055
Pool Temperature Sensor	M4416	SPCOH2/002
Ht Exchanger Flow Sensor	M2149	SPMBG013
Genie Pump	M2683	SPMBG056

Electrical Components

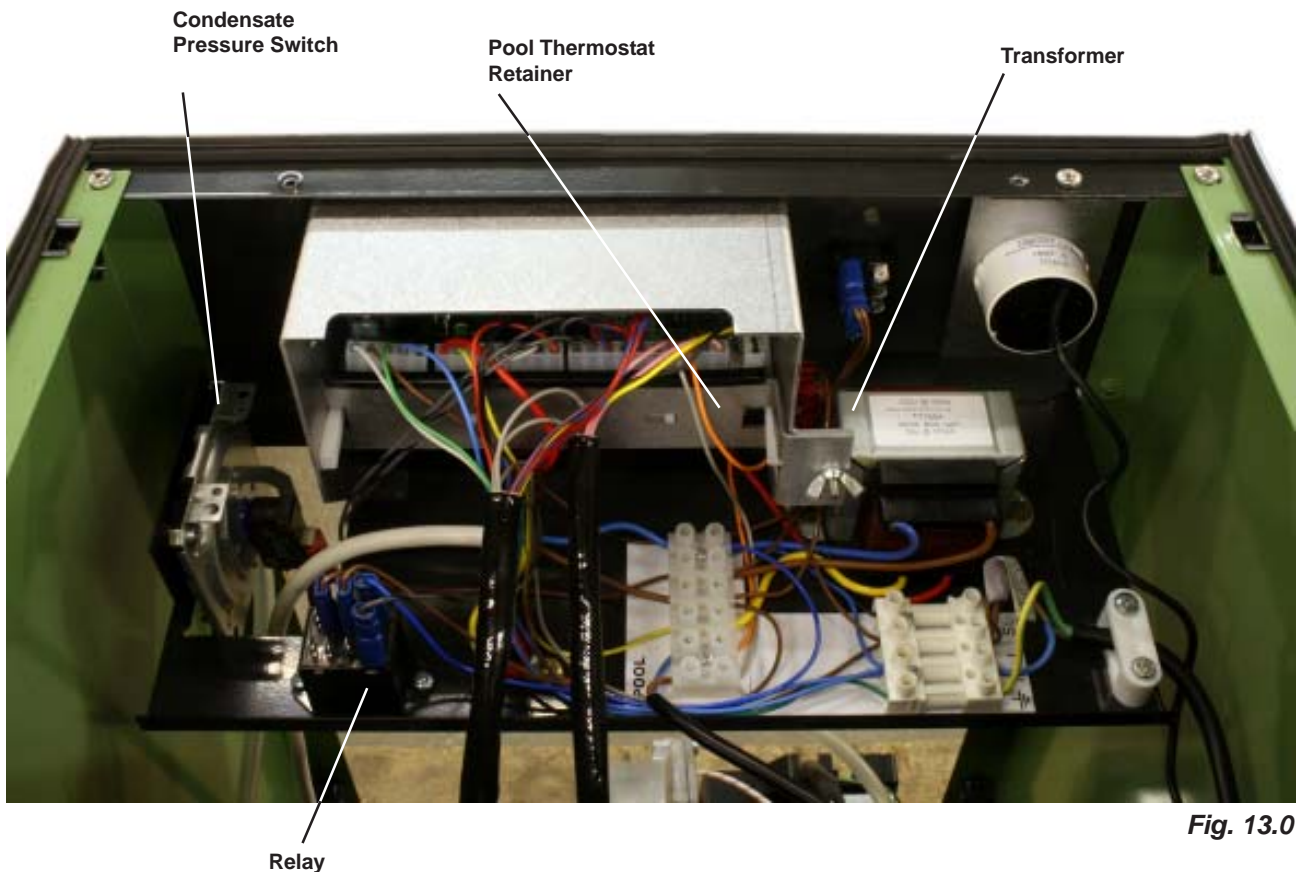

Fig. 13.0

Heater Components

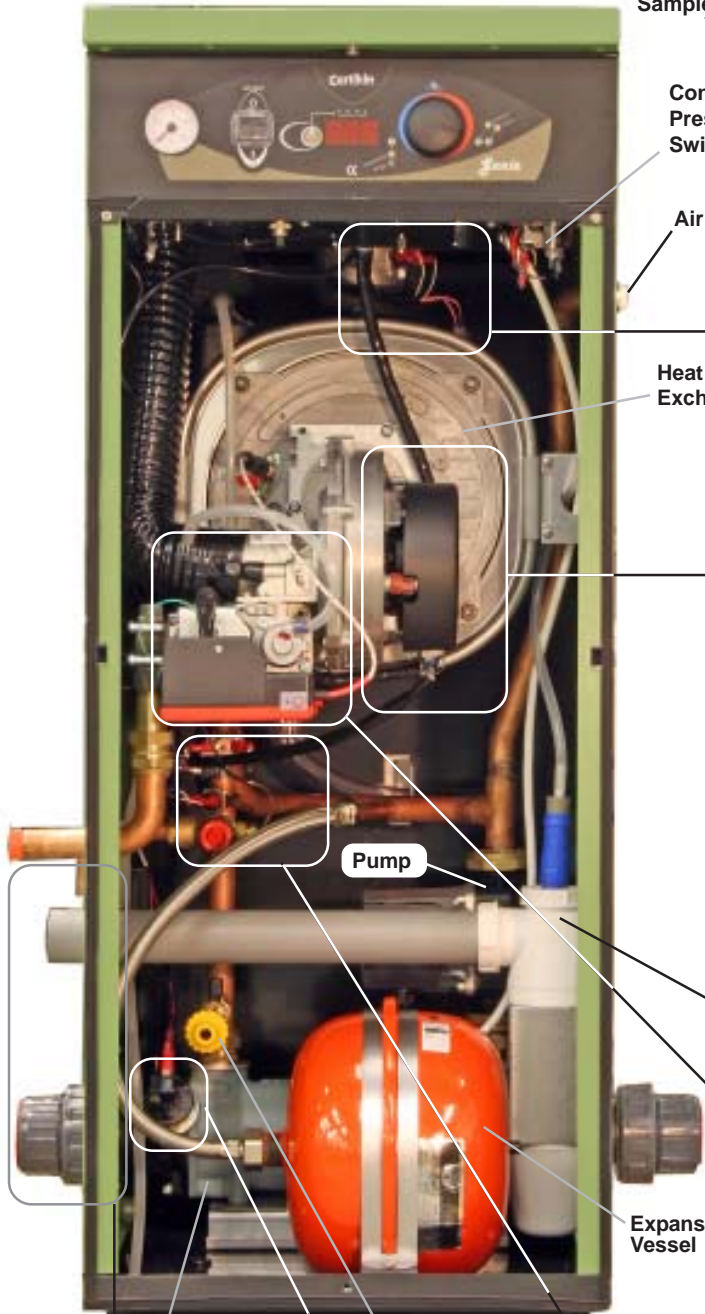
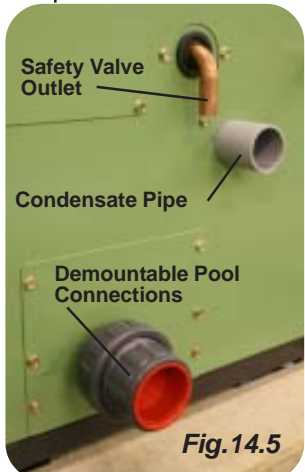
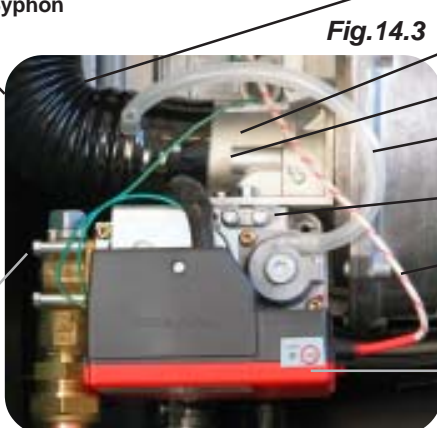
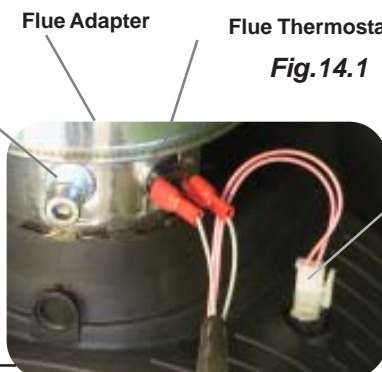

Fig.14.0



INSTALLATION & SERVICE HISTORY

Tick appropriate:

Model		Gas	
Genie 35	Genie 50	NG	LPG

Commissioning

Installer Corgi No		Date:	
Working pressure		mbar	
CO	ppm	CO ₂	%
Instructed User in operation?		Yes/No	

Service History

Date			
Cleaned ?			
Pressure			
CO			
CO ₂			

Date			
Cleaned ?			
Pressure			
CO			
CO ₂			

