

COBY®

TV-DVD1390
TV-DVD2090



Color TV with Digital Tuner and
DVD Player



Instruction Manual

Please read this manual carefully before operation

Precautions

	CAUTION WARNING: SHOCK HAZARD. DO NOT OPEN. AVIS: RISQUE DE CHOC ELECTRIQUE. NE PAS OUVRIR	
CAUTION: TO REDUCE THE RISK OF FIRE AND ELECTRIC SHOCK, DO NOT REMOVE THE COVER (OR BACK) OF THE UNIT. REFER SERVICING ONLY TO QUALIFIED SERVICE PERSONNEL.		



The lightning flash with arrowhead symbol within an equilateral triangle is intended to alert the user to the presence of uninsulated “dangerous voltage” within the product’s enclosure that may be of sufficient magnitude to constitute a risk of electric shock.



The exclamation point within an equilateral triangle is intended to alert the user to the presence of important operation and servicing instructions in the literature accompanying the appliance.

For Customer Use:

Enter below the serial number that is located on the unit. Retain this information for future reference.

Model No. _____

Serial No. _____

WARNING: To prevent fire or shock hazard, do not expose this device to rain or moisture. Dangerous high voltage is present inside the enclosure. Do not open the cabinet.

CAUTION: To prevent electric shock, match wide blade of plug to wide slot of outlet and fully insert.

NOTICE: This product incorporates copyright protection technology that is protected by U.S. patents and other intellectual property rights. Use of this copyright protection technology must be authorized by Macrovision, and is intended for home and other limited viewing uses only unless otherwise authorized by Macrovision. Reverse engineering or disassembly is prohibited.

Precautions

FCC Notice: This equipment has been tested and found to comply with the limits for a Class B digital device pursuant to Part 15 of the FCC Rules. These limits are designed to provide reasonable protection against harmful interference in a residential installation. This equipment generates, uses, and can radiate radio frequency energy and, if not installed and used in accordance with the instructions, may cause harmful interference to radio or television reception. However, there is no guarantee that interference will not occur in a particular installation. If this equipment does cause harmful interference to radio or television reception (which can be determined by turning the equipment off and on), the user is encouraged to try and correct the interference by one or more of the following measures:

- Reorient or relocate the receiving antenna.
- Increase the separation between the equipment and the receiver.
- Connect the equipment into an outlet on a circuit different from that to which the receiver is connected.
- Consult the dealer or an experienced audio/TV technician for help.



For recycling or disposal information about this product, please contact your local authorities or the Electronics Industries Alliance: www.eiae.org.

Important Safety Instructions

1. **Read Instructions:** All the safety and operating instructions should be read before the product is operated.
2. **Retain Instructions:** The safety and operating instructions should be retained for future reference.
3. **Heed Warnings:** All warnings on the product and in the operating instructions should be adhered to.
4. **Follow Instructions:** All operating and usage instructions should be followed.
5. **Cleaning:** Unplug this product from the wall outlet before cleaning. Do not use liquid cleaners or aerosol cleaners. Use a damp cloth for cleaning.
6. **Attachments:** Use only attachments recommended by the manufacturer. Use of other attachments may be hazardous.
7. **Water and Moisture:** Do not use this product near water (e.g., near a bath tub, washbowl, kitchen sink, laundry tub, in wet basements, or near a swimming pool and the like).
8. **Accessories:** Do not place this product on an unstable cart, stand, tripod, bracket, or table. Use only with carts, stands, tripods, brackets, or tables recommended by the manufacturer or sold with the product. Any mounting of the product should follow the manufacturer's instructions and should use a mounting accessory recommended by the manufacturer.
9. A product and cart combination should be moved with care. Quick stops, excessive force, and uneven surfaces may cause the product and cart combination to overturn.
10. **Ventilation:** Slots and openings in the cabinet are provided for ventilation to ensure reliable operation of the product and to protect it from overheating. These openings should never be blocked by placing the product on a bed, sofa, rug, or other similar surface. This product should not be placed in a built-in installation such as a bookcase or rack unless proper ventilation is provided or the manufacturer instructions have been adhered to.
11. **Power Sources:** This product should be operated only from the type of power source indicated on the rating label. If you are not sure of the type of power supply to your home, consult your product dealer or local power company. For products intended to operate from battery power or other sources, refer to the operating instructions.



Important Safety Instructions

12. **Grounding or Polarization:** This product may be equipped with a polarized alternating-current line plug that has one blade wider than the other. This plug will only fit into the power outlet in one direction. This is a safety feature. If you are unable to insert the plug fully into the outlet, try reversing the direction of the plug. If the plug should still fail to fit, contact an electrician to replace the obsolete outlet. Do not defeat the safety purpose of the polarized plug.
13. **Power-Cord Protection:** Power supply cords should be routed so that they are not likely to be walked on or pinched by items placed upon or against them, paying particular attention to cords at plugs, convenience receptacles, and at the point which they exit from the product.
14. **Protective Attachment Plug:** The product may be equipped with an attachment plug with overload protection. This is a safety feature. See the operating instructions for replacement or directions to reset the protective device. If replacement of the plug is required, be sure the service technician has used a replacement plug that has the same overload protection as the original plug as specified by the manufacturer.
15. **Outdoor Antenna Grounding:** If an outside antenna is connected to the product, be sure the antenna system is grounded so as to provide some protection against voltage surges and built-up static charges. Article 810 of the National Electrical Code, ANS/NFPA 70 provides information with regard to proper grounding of the mast and supporting structure, grounding of the lead-in wire to an antenna-discharge unit, size of grounding conductors, location of antenna-discharge unit, connection to grounding electrodes, and requirements for the grounding electrode (see figure).

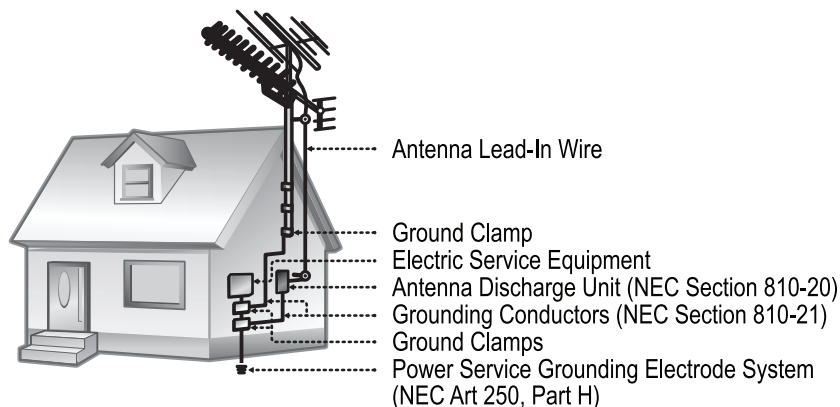

16. **Lightning:** For added protection for this product, unplug it from the wall outlet and disconnect the antenna or cable system during a lightning storm or when it is left unattended and unused for long periods of time. This will prevent damage to the product due to lightning or power-line surges.

Important Safety Instructions

17. **Power Lines:** An outside antenna system should not be located in the vicinity of overhead power lines or other electric light or power circuits, or where it can fall into such power lines or circuits. When installing an outside antenna system, extreme care should be taken to keep from touching such power lines or circuits, as contact with them might be fatal.
18. **Overloading:** Do not overload wall outlets, extension cords, or integral convenience receptacles as this can result in a risk of fire or electric shock.
19. **Object and Liquid Entry:** Never push objects of any kind into this product through openings as they may touch dangerous voltage points or short-out parts that could result in a fire or electric shock. Never spill liquid of any kind on the product.
20. **Servicing:** Do not attempt to service this product yourself as opening or removing covers may expose you to dangerous voltage or other hazards. Refer all servicing to qualified service personnel.
21. **Damage Requiring Service:** Unplug this product from the wall outlet and refer servicing to qualified service personnel under the following conditions: a) when the power-supply or plug is damaged; b) if liquid has been spilled or if objects have fallen into the product; c) if the product has been exposed to rain or water; d) if the product does not operate normally by following the operating instructions. Adjust only those controls that are covered by the operating instructions as improper adjustment of other controls may result in damage and will often require extensive work by a qualified technician to restore the product to its normal operation; e) if the product has been dropped or damaged in any way; f) when the product exhibits a distinct change in performance—this indicates a need for service.
22. **Replacement Parts:** When replacement parts are required, be sure that your service technician has used replacement parts specified by the manufacturer or have the same characteristics as the original part. Unauthorized substitutions may result in fire, electric shock, or other hazards.
23. **Safety Check:** Upon completion of any service or repairs to this product, ask the service technician to perform safety checks to ensure that the product is in proper operating condition.
24. **Wall or Ceiling Mounting:** The product should be mounted to a wall or ceiling only as recommended by the manufacturer.
25. **Heat:** The product should be situated away from heat sources such as radiators, heat registers, stoves, or other products (including amplifiers) that produce heat.

Table of Contents

PRECAUTIONS	2
IMPORTANT SAFETY INSTRUCTIONS	4
TABLE OF CONTENTS.....	7
PACKAGE CONTENTS	10
FEATURES	11
ABOUT OPTICAL DISCS.....	12
Disc Requirements.....	12
DVD Features	13
DVD Region Codes	14
Disc Care and Maintenance.....	15
Handling a Disc.....	15
Cleaning a Disc.....	15
LOCATION OF CONTROLS	16
Front View.....	16
Remote Control.....	18
Using the Remote Control.....	20
CABLE CONNECTIONS.....	22
Standard Connections	22
Cable Input (without cable box).....	22
Cable/Satellite Input (with cable/satellite box)	23
Antenna Input.....	24
Optional Audio/Video Connections	26
Composite Audio/Video Input	26
Component Audio/Video Input	27
Composite Audio/Video Output.....	29
Coaxial Digital Audio Output (DVD only).....	30
Power Connection	32

Table of Contents

DTV MODE (DIGITAL TV)	33
Basic Operation	33
DTV Functions	34
DTV/TV	34
Info	34
EPG (Electronic Program Guide)	35
Fav/Prog (Favorite Channels).....	35
CH-List (Channel List).....	35
Sleep.....	36
DTV Setup	36
Auto Search	37
CH Setup (Channel Setup).....	38
CC Setup (Closed Caption Setup).....	39
Parental Control	40
System Settings	42
Picture / Timer Settings	43
TV MODE (ANALOG TV)	44
Basic Operation	44
TV Functions	45
DTV/TV	45
Info	45
Sleep.....	45
TV Setup.....	46
Picture.....	47
P.Lock (Parental Lock)	47
Timer.....	49
Preset	50
DVD MODE.....	52
Basic Operation	52
Play/Pause/Stop.....	53
Previous/Next (Skip).....	54

Table of Contents

Reverse/Forward (Scan)	54
Slow-Motion	54
Step	55
Repeat Mode	55
A-B Repeat Mode	55
GOTO (Search)	56
Programmed and Random Playback	57
DVD Functions	59
Menu/Title	59
Info	59
Angle	60
Audio	60
Subtitle	60
Zoom	61
DVD Setup	62
Language	63
Display	63
Audio	64
Parental	65
AV MODE	67
Basic Operation	67
COMPONENT MODE	68
Basic Operation	68
TROUBLESHOOTING	69
SPECIFICATIONS	72

Package Contents

Please make sure that the items listed below are included in the package. Should an item be missing, please contact the local retailer from which you purchased this product.

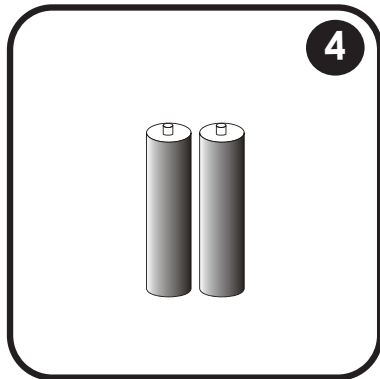
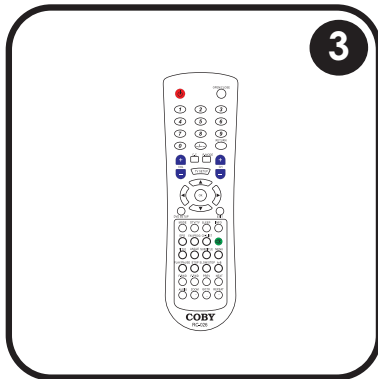
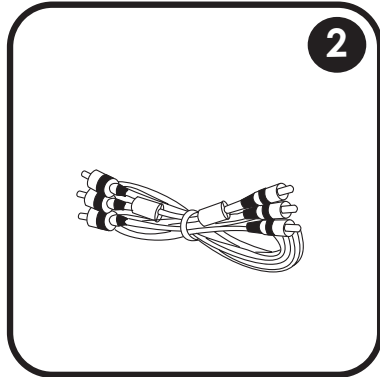
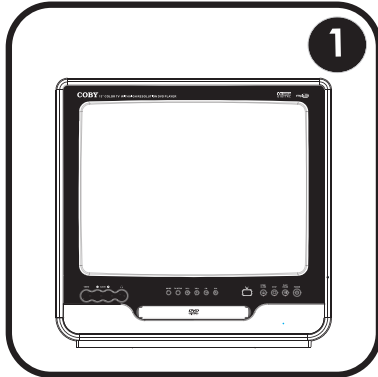

1. Coby Color TV
2. AV Cable
3. Remote Control
4. 2 x "AA" Batteries

Features

- Dual ATSC/NTSC Tuner for Digital and Standard TV Broadcast Reception
- Integrated Front-Loading DVD Player
- DVD, DVD±R/RW, CD, CD-R/RW, and JPEG Compatible
- AV Input Jacks for use with VCRs, Video Games, Media Players, and More
- High-Output Stereo Speakers
- V-Chip Parental Control
- Electronic Program Guide Support
- Multi-Language On-Screen Display
- Sleep Timer
- Energy Efficient Standby Power (<3W)

About Optical Discs

Disc Requirements

This DVD player supports playback of the following discs.





Type	Disc Mark	Content Type	Disc Size	Max. Playback Time
Digital Video Discs (DVDs)		Audio + Video (moving picture)	12 cm	133 min (SS-SL)
				242 min (SS-DL)
				266 min (DS-SL)
				484 min (DS-DL)
Audio Compact Discs (CDs)		Audio	12 cm	74 min
JPEG CDs	--	Still Picture	12 cm	--

This unit can play back CD-R and CD-RW discs that contain audio titles, or JPEG picture files. Discs not listed above are not supported by this unit (e.g., PC CD-ROM, CD-Extra, CD-G, CD-I, etc.)

About Optical Discs

DVD Features

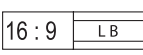
Each DVD disc contains features that may vary depending upon the production of the disc. Some of the icons you may see that represent these features are shown below.

	Number of Audio Tracks
	Number of Subtitles
	Angle Indicator
	Screen Format (Aspect Ratio)
	Zoom



Some of the DVD features enabled by this player depend on how the DVD was produced. Some features may not be enabled if the disc does not support the feature, or they may require special settings. Check the features printed on the DVD package or follow the instructions found on the disc's on-screen menu.

About Optical Discs

DVD Region Codes

DVD discs and DVD players are manufactured under a compulsory worldwide agreement—the DVD Regional Code System. DVD players will only operate with DVD discs encoded with the same corresponding Region Code.

Region Code	Region
1	Canada, USA
2	Europe (including Poland, Romania, Czech Republic), Japan, Middle East (including Saudi Arabia, Egypt, Iran, South Africa)
3	East Asia (including Hong Kong, Taiwan, South Korea), Southeast Asia
4	Australia, Caribbean, Central America, South America, Mexico, New Zealand
5	Africa, the former Soviet Union, India, North Korea, Pakistan, Turkmenistan
6	China



The Region Code for this player is “1”.

About Optical Discs

Disc Care and Maintenance

Optical discs (DVDs, CDs) contain high-density compressed data and need proper handling.

Handling a Disc

- Hold a DVD/CD by its edges. Avoid touching the recorded side of the disc. To remove a DVD/CD from its storage case, press down on the center retention mechanism of the case and lift the disc out.
- Do not subject discs to prolonged exposure to direct sunlight, high humidity, or high temperatures.
- Do not bend or press discs.
- To reduce the risk of scratches, always put discs back in their case after use. Store discs vertically in a cabinet.
- Do not place stickers or labels on either side of a disc.

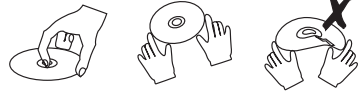

Cleaning a Disc

Use a dry, soft cloth to wipe off any fingerprints and dusts from the playing surface of the disc. Wipe in a straight line radially from the center to the outside edge of the disc. Small dust particles and light stains will not affect playback quality.



Never use chemicals such as record sprays, anti-static sprays, benzene, or thinners to clean a disc. Doing so will damage the surface of the disc permanently.

Location of Controls

Front View

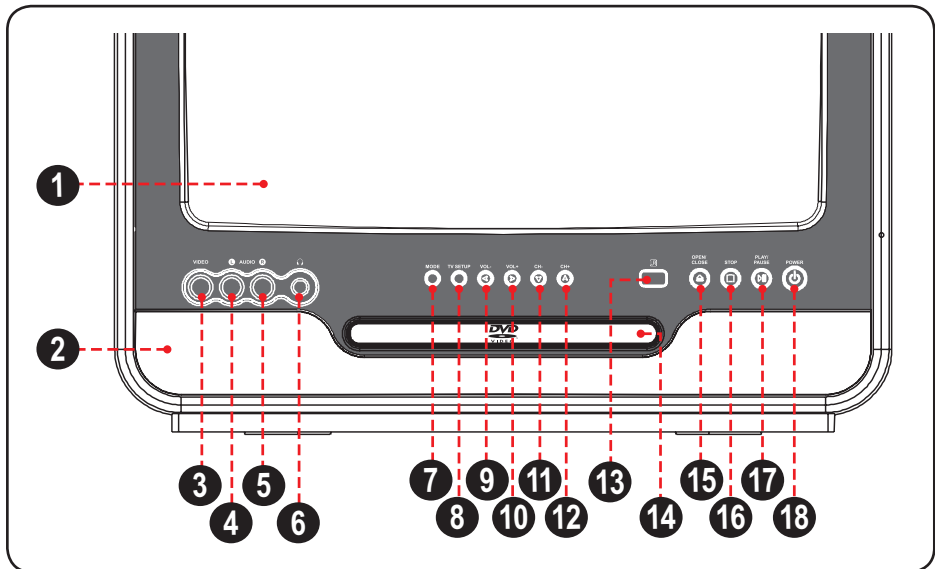

1. Color Screen

2. Stereo Speakers

A/V Input Jacks (AV)

3. Composite Video In

4. Composite Audio In (Left)

5. Composite Audio In (Right)

6. Headphone Out

7. Mode

8. TV Setup

9. Volume Down

10. Volume Up

11. Channel Down

12. Channel Up

13. Remote Sensor /
Power Indicator

14. Disc Tray

15. Open/Close

16. Stop

17. Play/Pause

18. Power

Location of Controls

Right Panel View

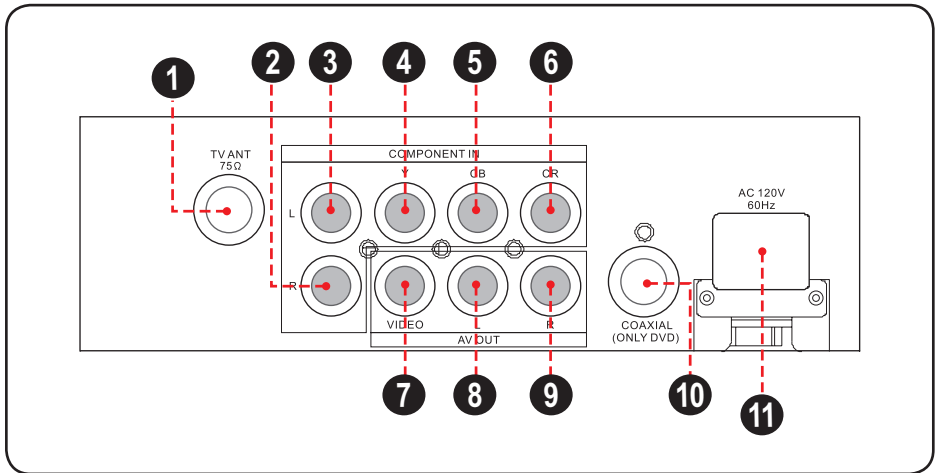

TV Input (TV, DTV)

1. TV Antenna In (75Ω Coaxial)

Component Input Jacks (Component)

2. Component Audio In (Right)
3. Component Audio In (Left)
4. Component Video In (Y)
5. Component Video In (Cb/Pb)
6. Component Video In (Cr/Pr)

A/V Output Jacks

7. Composite Video Out
8. Composite Audio Out (Left)
9. Composite Audio Out (Right)
10. Coaxial Digital Audio Out (DVD Output Only)
11. AC Power Cord

Location of Controls

Remote Control

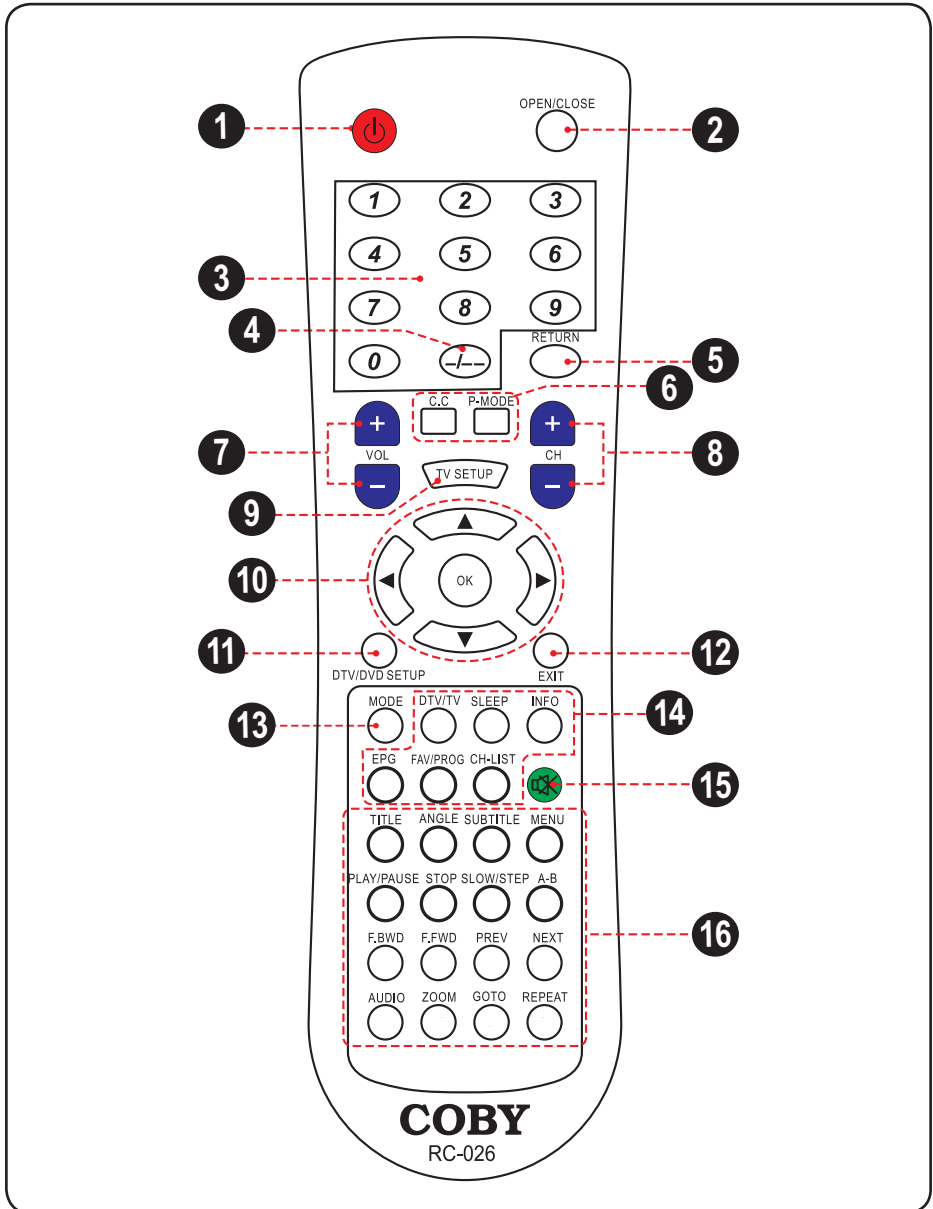

Location of Controls

Remote Key	Description
1. Power	Turn the TV on/off.
2. Open/Close	Open/close the disc tray.
3. Numeric Keypad (0–9)	Use the numeric keypad to a) change channels, and b) input numeric data.
4. Input Select	In TV-Cable mode: toggle between 1-, 2-, and 3-digit channel input. In TV-Air (antenna) mode: toggle between 1- and 2- digit channel input.
5. Return	Return to the previously selected channel.
6. Display Options	Toggle closed-caption and picture display options.
7. Volume Keys	Adjust the volume level.
8. Channel Keys	Scan through the TV channels.
9. TV Setup	Access the TV setup menu.
10. Navigation Keypad	Press the arrow keys to move the on-screen cursor. Press  to select an item.
11. DTV/DVD Setup	In DVD mode: Access the DVD setup menu. In DTV mode: Access the Digital TV setup menu.
12. Exit	Exit the DTV or DVD setup menu.
13. Mode	Change to a different mode (DTV, TV, DVD, AV, COMPONENT)
14. DTV/TV Function Controls	Use the DTV/TV system options (please refer to the sections “DTV Functions” and “TV Functions” for details).
15. Mute	Mute the sound. Press again to restore the sound.
16. DVD Function Controls	Use the DVD system functions (please refer to the section “DVD Functions” for details).

Location of Controls

Using the Remote Control

- Remove the battery compartment cover located on the rear of the remote control. Insert 2 x “AAA” batteries, making sure to match their polarities (+/-) to the markings on the inside of the compartment (refer to the diagram). Replace the cover.
- To use the remote, point it at the remote sensor of the player. Operate the remote within 20 feet of the sensor and at an angle of ± 30 degrees.

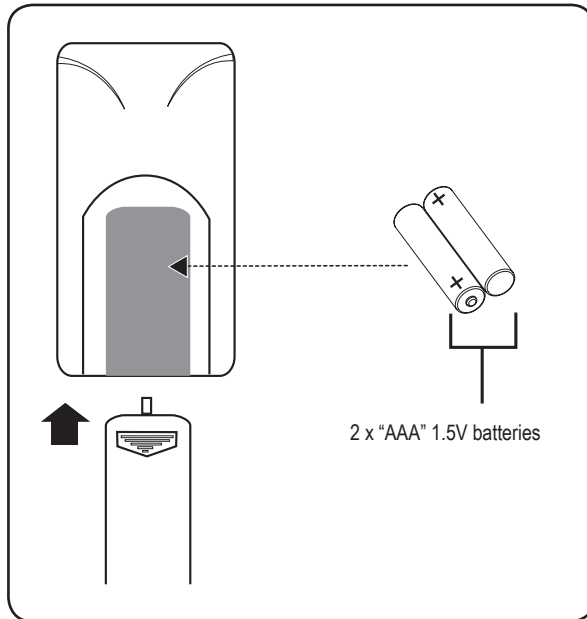

Location of Controls



Do not point bright lights directly at the remote control sensor.

Do not place objects between the remote control unit and the remote control sensor.

Do not use this remote control unit while simultaneously operating the remote control unit of any other equipment.

Batteries in the remote will last for approximately 6 months under normal use. Replace the batteries if the remote control does not work. Do not mix old with new batteries, or different types of batteries.

To avoid damage from possible battery leakage, remove the batteries from the remote if it will not be used for an extended period of time.



The battery used in this device may present a fire or chemical burn if mistreated. Do not recharge, disassemble, incinerate, or heat the battery (~212°F).

Keep batteries away from children.

Cable Connections

Standard Connections

Cable Input (without cable box)

Use this connection if you do not need a cable box to unscramble channels.

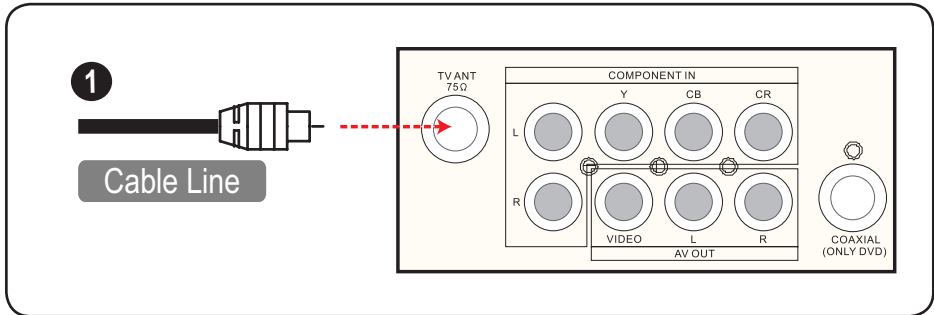

1. Connect the cable line (75Ω coaxial cable) to the TV Antenna In jack located on the rear of the unit.

To view the cable signal:

1. Set the Antenna option to “Cable” in the DTV or TV setup menu.
2. Set the unit to DTV or TV mode (the screen will display the current channel number).



Turn off all devices before making system connections. Do not connect the power until all connections have been made.

Cable Connections

Cable/Satellite Input (with cable/satellite box)

Use this connection if you need a cable or satellite box (receiver) to unscramble channels.

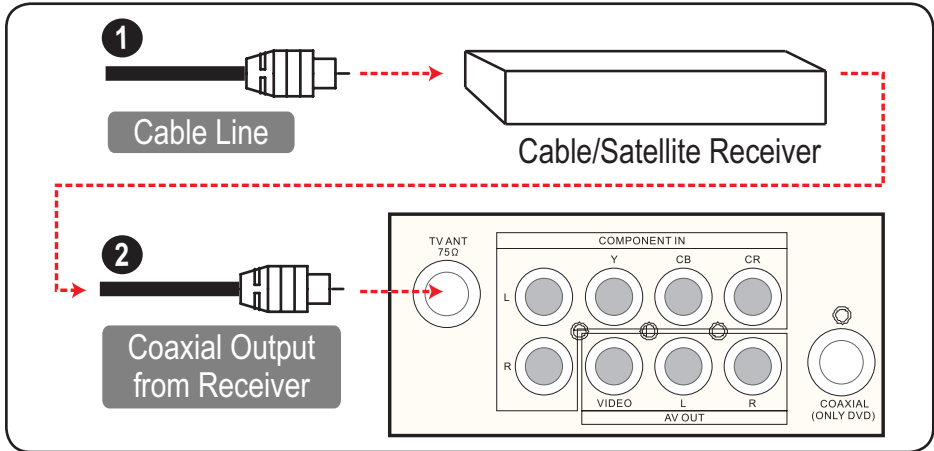

1. Connect the cable/satellite line (75Ω coaxial cable) to the coaxial input of the receiver.
2. Connect a cable line from the coaxial output of the receiver to the TV Antenna In jack located on the rear of the unit.

To view the cable/satellite signal:

1. Set the Antenna option to “Cable” in the DTV or TV setup menu.
2. Set the unit to DTV or TV mode (the screen will display the current channel number).



Additional connections may be possible with your cable/satellite receiver; please refer to the documentation provided with your receiver for more information.

This unit can receive unscrambled digital programming (QAM).

Cable Connections



Turn off all devices before making system connections. Do not connect the power until all connections have been made.

Antenna Input

Use this connection if you are using an indoor or outdoor antenna to receive television signals.

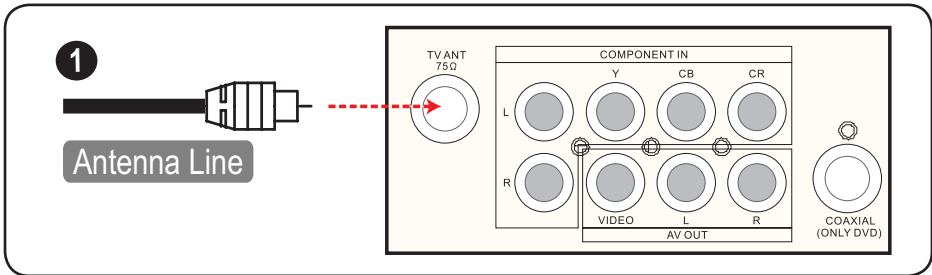

1. Connect the antenna line (75Ω coaxial cable) to the TV Antenna In jack located on the rear of the unit.

To view an analog antenna signal (NTSC):

1. Set the Antenna option to “Air” TV setup menu.
2. Set the unit to TV mode (the screen will display the current channel number).



NTSC television broadcasts will cease in the USA on February 17, 2009. To receive over-the-air television broadcasts after this date, use the digital ATSC tuner (DTV mode).

Cable Connections

To view a digital antenna signal (ATSC):

1. Set the Antenna option to “Air” in the DTV setup menu.
2. Set the unit to DTV mode (the screen will display “DTV”).



When using an indoor antenna (e.g., a rabbit-ear or dipole antenna), keep the antenna away from the display unit to reduce the possibility of interference.



Turn off all devices before making system connections. Do not connect the power until all connections have been made.

Cable Connections

Optional Audio/Video Connections

Composite Audio/Video Input

Use this connection to display optional A/V devices on the unit. A/V devices may include VCRs, DVD players, cable/satellite receivers, camcorders, or game consoles that are equipped with composite audio/video output jacks.

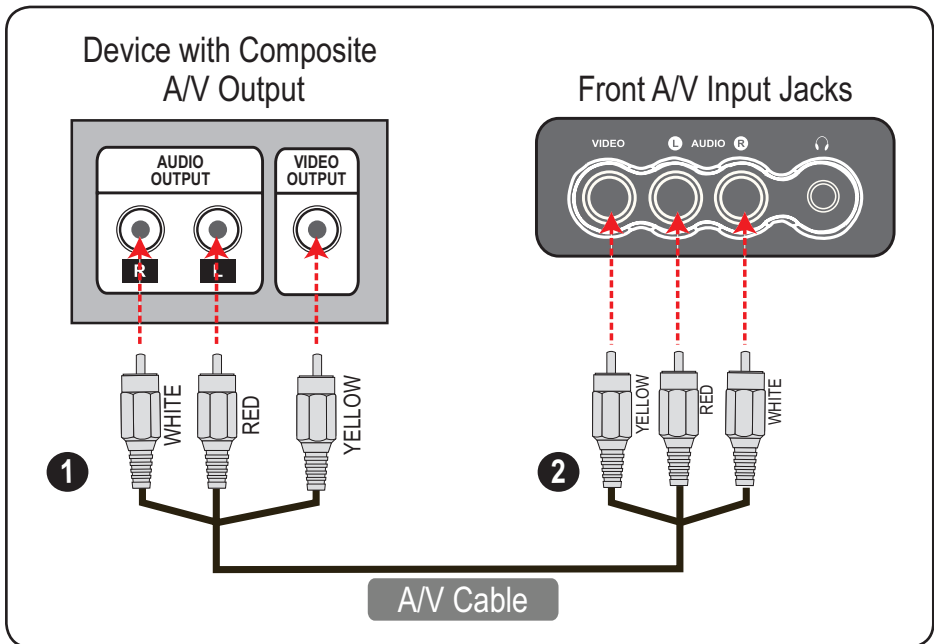

Using the supplied composite A/V cable:

1. Connect the yellow video plug of the cable to the composite video output jack of the external device. Connect the white and red audio plugs to the audio output jacks of the external device.
2. With the other end of the cable, connect the yellow, red, and white plugs to the A/V Input jacks located on the front of the unit.

Cable Connections

To view the composite A/V device signal:

1. Turn on the A/V device.
2. Set the unit to AV mode (the screen will display "AV").



Turn off all devices before making system connections. Do not connect the power until all connections have been made.

Component Audio/Video Input

Use this connection to display optional A/V devices on the unit. A/V devices may include DVD players, cable/satellite receivers, camcorders, or game consoles that are equipped with component audio/video output jacks.

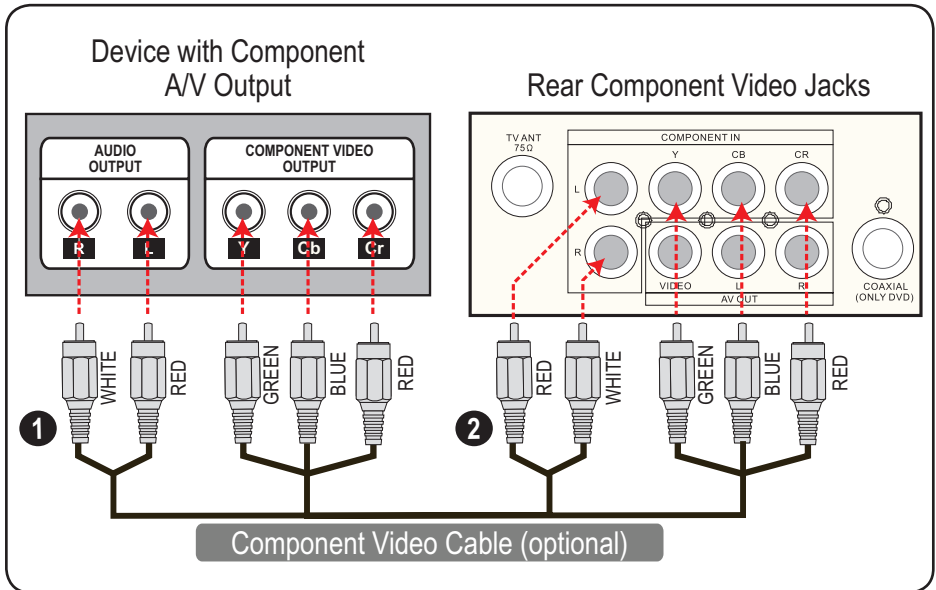

Cable Connections

Using an optional component A/V cable:

1. Connect the green, blue, and red video plugs of the cable to the component video output jacks of the external device (Y, Cb/Pb, and Cr/Pr, respectively). Connect the white and red audio plugs to the audio output jacks of the external device.
2. With the other end of the cable, connect the plugs to their corresponding Component Input jacks located on the rear of the unit.

To view the component A/V device signal:

1. Turn on the A/V device.
2. Set the unit to Component mode (the screen will display "COMPONENT").



Turn off all devices before making system connections. Do not connect the power until all connections have been made.

Cable Connections

Composite Audio/Video Output

Use this connection to output the unit's signal to an external device or display. The external device must be equipped with composite audio/video input jacks.

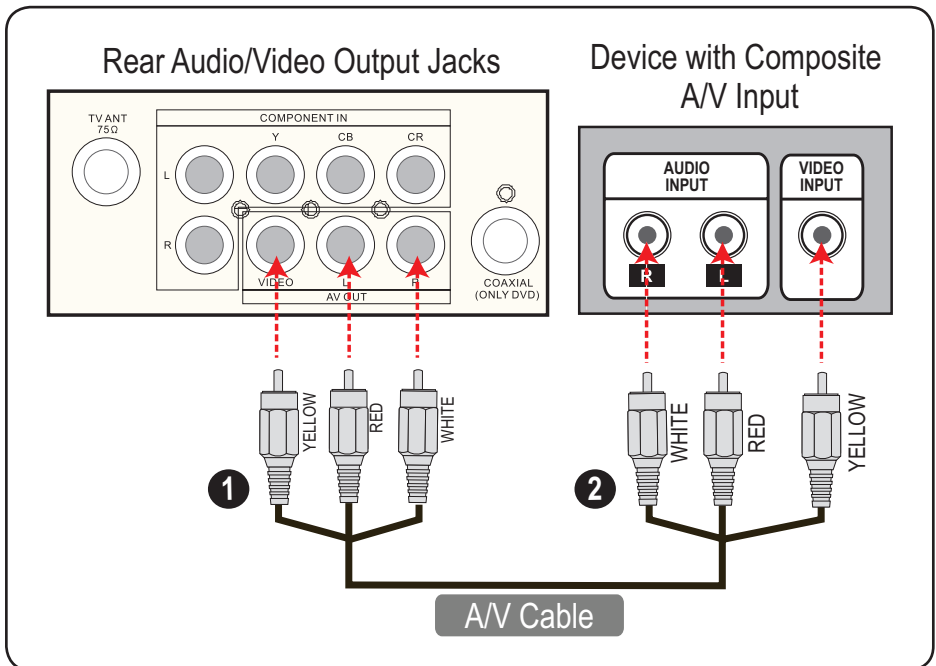

Using the supplied composite A/V cable:

1. Connect the yellow video plug of the cable to the composite video output jack of the external device. Connect the white and red audio plugs to the audio output jacks of the external device.
2. With the other end of the cable, connect the yellow, red, and white plugs to the A/V Input jacks located on the front of the unit.

Cable Connections



You can transmit signals from the unit's DTV, DVD, and AV modes over the AV Output jacks.



Turn off all devices before making system connections. Do not connect the power until all connections have been made.

Coaxial Digital Audio Output (DVD only)

Use this connection in conjunction with the integrated DVD player in order to output digital audio to a home theater receiver. The home theater receiver must be equipped with a coaxial digital audio input jack.

For your reference:

When DVDs recorded in Dolby Digital or MPEG audio are played, Dolby Digital or MPEG audio bitstream is sent to the player's digital audio output connector. When the player is connected to a Dolby Digital or MPEG audio decoder via one of these output sockets, you can enjoy theater-quality audio in your home. A digital audio cable is required when a Dolby Digital decoder or MPEG audio decoder is used.

Dolby Digital is a digital sound compression technique developed by the Dolby Laboratories Licensing Corporation. This techniques supports both 5.1-channel surround sound and stereo (2-channel) sound, and enables a large quantity of sound data to be recorded efficiently onto a disc.

Cable Connections

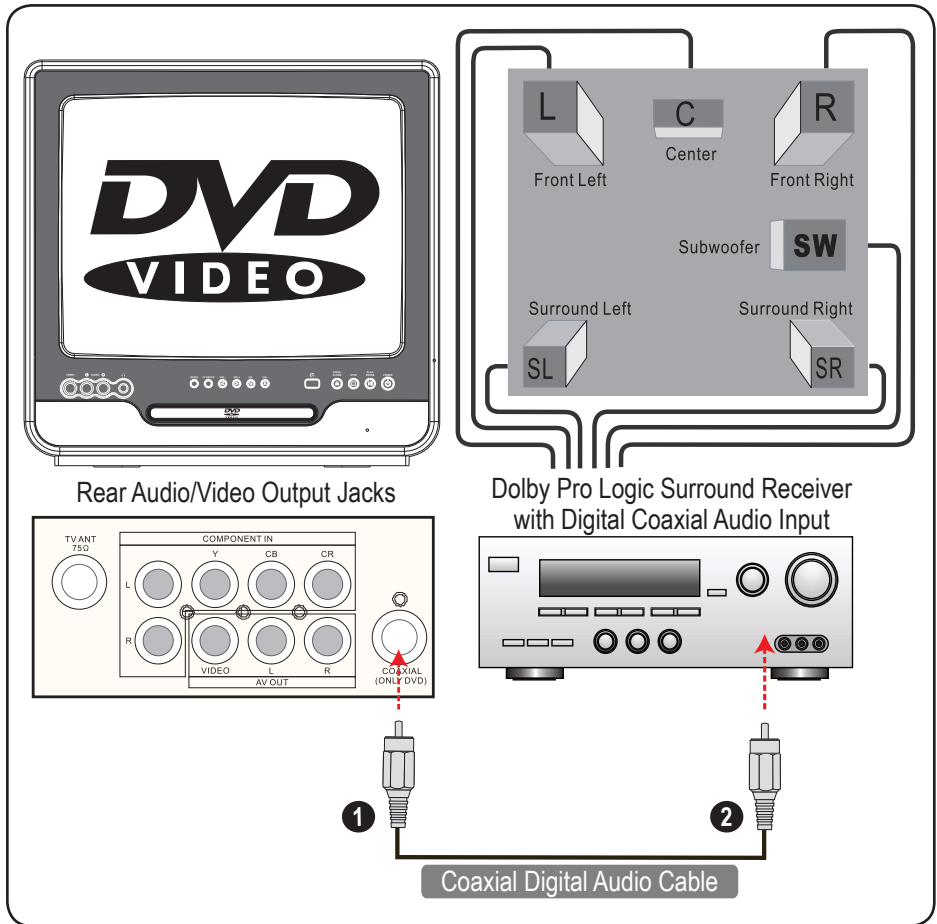

Using an optional coaxial digital audio cable:

1. Connect one end of the cable to the Coaxial Digital Audio Out jack located on the rear of the unit.
2. Connect the other end of the cable to the coaxial digital audio input jack of the receiver.

Cable Connections



*The receiver **MUST** contain a Dolby Digital or MPEG audio decoder.*

Attempting to play DVDs through a receiver without the correct Dolby Digital or MPEG decoder may produce extreme levels of noise. This could damage both your ears & your loudspeakers.

The SPDIF Digital option should be set to “RAW” or “PCM” when using this connection (refer to the section “DVD Mode > DVD Setup > Audio” for details).



Turn off all devices before making system connections. Do not connect the power until all connections have been made.

Power Connection

After all system connections have been made, connect the AC Power Cord to a AC 120V/60Hz wall outlet.



If the player will not be in use for a long period of time, turn the TV off, unplug the unit, and remove the batteries from the remote control.







Make all system connections before plugging the unit into a wall outlet.

DTV Mode (Digital TV)



Set the unit to DTV mode to view digital ATSC TV broadcasts.

Press **MODE** to switch the unit to DTV mode. (You can also press **DTV/TV** to toggle quickly between DTV and TV modes.)

Basic Operation

1. Ensure that all cable connections have been made properly and securely (refer to the section “Cable Connections” for details).
2. Press  to turn the unit on or off.
3. Press **MODE** until the screen displays “DTV” to enter DTV mode.
4. If this is the first time you are using the unit, use the DTV setup menu to auto-search for DTV channels within broadcast range (please see the section “DTV Setup” for details).
5. Press **VOL+** or **VOL-** to adjust the volume level.
 - Press  to disable the sound completely. To restore the sound, press  again.
6. Press **CH+** or **CH-** to scan through the available DTV channels.
 - Press **RETURN** to return to the previously selected channel.
7. To tune to a channel directly:
 - Input the channel number with the numeric keypad and then press  to enter.

DTV Mode (Digital TV)

8. To tune to a channel with multicast broadcasting directly:
 - Input the channel number with the numeric keypad and then press .
 - Input the multicast number with the numeric keypad and then press  to enter.

For your reference:

Digital TV technology allows broadcasters the ability to provide multiple, simultaneous programming over one channel. This is called “multicasting”. Many broadcasters are offering these additional multicast channels. For example, if channel 4 in your area is multicasting, you can tune into these multicast programming streams on channels 4-1, 4-2, and 4-3 in the digital band.

DTV Functions

DTV/TV

Press  to quickly switch between DTV and TV modes.

Info

Press  to display program info for the current channel.



- Press  again to exit the program info display.

DTV Mode (Digital TV)

EPG (Electronic Program Guide)

Press **EPG** to display current and future program info for the current channel (if supported).

While the EPG is displayed:

- Press  to go to the next page.
- Press  to return to the previous page.
- Press **EPG** to exit the EPG display.

Fav/Prog (Favorite Channels)

Press **FAV/PROG** to switch quickly between five of your favorite channels.







You must set the Favorite Channels list before using this feature. Please see the section "DTV Setup" for more details.

CH-List (Channel List)

Press **CH-LIST** to display a list of all available channels.

While the Channel List is displayed:

- Press  or  to move the selection cursor up or down, respectively.
- Press  to change to the selected channel.
- Press  to go to the next page.
- Press  to return to the previous page.
- Press **CH-LIST** to exit the Channel List display.

DTV Mode (Digital TV)

Sleep

Press **SLEEP** to set the sleep timer. The unit will turn off automatically at the end of the timer.

- Each press of **SLEEP** will add 10 minutes to the sleep timer.
- While the sleep timer is set, press **SLEEP** to display the remaining time.

DTV Setup

Use the DTV setup menu to adjust the DTV options.

While the unit is in DTV mode, press **DTV/DVD SETUP** to access the DTV setup menu.

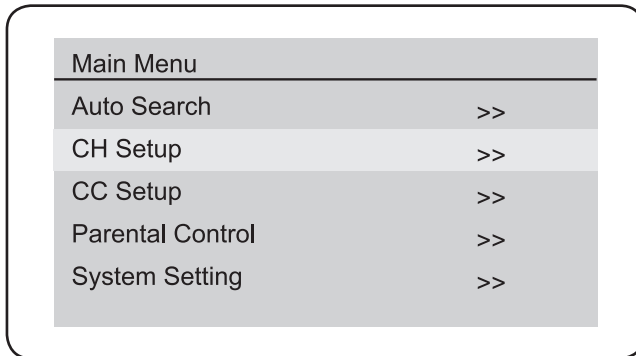

How to use the DTV setup menu:

- Press **▲** or **▼** to move the selection cursor up or down, respectively.
- Press **▶** to enter a sub-menu (sub-menus are indicated by “>>”).
- Press **◀** or **▶** to set the options of a selected menu item.



DTV Mode (Digital TV)

- Press **DTV/DVD SETUP** to return to the previous screen.
- Press **EXIT** to exit the DTV setup menu.

Auto Search

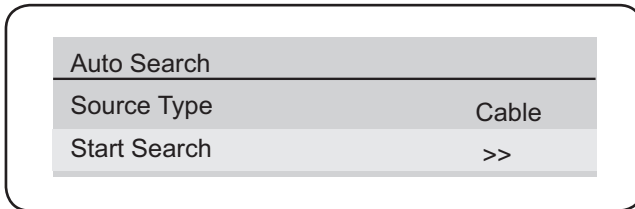
Automatically scan and save all channels within broadcast range.







Menu Item	Description
Source Type	<p>Set the antenna system.</p> <ul style="list-style-type: none">• Air: Use this setting to receive over-the-air broadcasts from an indoor or outdoor antenna.• Cable: Use this setting to receive broadcasts from a cable system provider.
Start Search	<p>Start auto-searching for available channels.</p> <ul style="list-style-type: none">• To cancel during auto-search, press . <div style="border: 1px solid black; padding: 5px; margin-top: 10px;"> Set the Source Type option before starting the auto-search operation.</div>

DTV Mode (Digital TV)

CH Setup (Channel Setup)

Set the DTV channel options.

Channel Setup	
Channel	2-1
Skip	On
Favorite List	>>

Menu Item	Description
Channel	Select a channel to adjust.
Skip	<p>Set the skip option of the channel selected above.</p> <ul style="list-style-type: none">• Off: The channel will be included when scanning through the channel list.• On: The channel will be skipped when scanning through the channel list. <p> You can still tune to a skipped channel by using the numeric keypad.</p>
Favorite List	<p>Access the Favorite List sub-menu to set a list of five of your favorite channels for quick access.</p> <ul style="list-style-type: none">• Press  or  to select Fav.1 to Fav.5.• Press  or  to set your favorite channel. <p>Once this list has been set, you can press FAV/PROG in DTV mode to switch quickly between the channels in the list.</p>

DTV Mode (Digital TV)

CC Setup (Closed Caption Setup)

Set the closed caption options.

CC Setup	
CC Display	Off
608CC Type	C1
708CC Type	Service1
CC Mode	Customer
CC Customer	>>

Menu Item	Description
CC Display	Turn the closed caption display on or off.
608CC Type	Set the closed caption type for older analog format captions.
708CC Type	Set the closed caption type for digital format captions.
CC Mode	Set the closed caption formatting: <ul style="list-style-type: none"> • Broadcast: obtain caption formatting from the channel broadcast. • Customer: use custom caption formatting. Formatting can be set in the CC Customer sub-menu (see below).
CC Customer	Customize the closed caption formatting. <ul style="list-style-type: none"> • Press ▲ or ▼ to select a caption attribute. • Press ◀ or ▶ to adjust the selected attribute. <div style="border: 1px solid black; padding: 5px; margin-top: 10px;">  This sub-menu is only available when the CC Mode option is set to "Customer". </div>

DTV Mode (Digital TV)

Parental Control

Set the Parental Control options to control which types of programming may be viewed on the unit.



The Parental Control menu is password-protected. Use the numeric keypad to enter the 4-digit password in order to access the menu.



The initial password is "0000". The password may be changed in the Parental Control menu. Do NOT forget the password.

Parental Control

V-Chip Setting	>>
RRT Setting	>>
Block Enable	Off
Unrated	Off
Change Password	>>

Menu Item	Description
V-Chip Setting	Set the V-chip options. You can set the following program types to "View" or "Block". <ul style="list-style-type: none">• Movie Ratings• USA TV Content Ratings• Canada English Ratings• Canada French Ratings
RRT Setting	Display the Region Rating Table menu.

DTV Mode (Digital TV)

Menu Item	Description
Block Enable	Turn the V-Chip controls on or off.
Unrated	Turn the rating system on or off.
Change Password	Change the Parental Control password.  Do not forget the Parental Control password; this password cannot be reset.

For your reference:

TV broadcasts include a signal that classifies the contents of the program. When the V-Chip rating options are set, TV broadcasts that have been classified with a higher rating will be blocked.

For more information about ratings in the USA, please visit <http://www.fcc.gov/vchip/>.

For more information about ratings in Canada, please visit <http://www.vchipcanada.ca/>.

DTV Mode (Digital TV)

System Settings

Set the DTV System options.

System Setting	
Reset	>>
Time Setup	>>
OSD Language	English
Audio Language	English
Format	Normal

Menu Item	Description
Reset	<p>Return all DTV Setup options to their default factory settings.</p> <div style="border: 1px solid black; padding: 5px;"> The Parental Control password cannot be reset.</div>
Time Setup	<p>Change the clock settings.</p> <ul style="list-style-type: none">• Clock: the time is set automatically through the DTV broadcast.• Time Zone: set the time zone option.• Daylight Saving: turn the automatic daylight savings time adjustment on or off.
OSD Language	Change the language of the DTV menu.
Audio Language	Change the default audio language. The broadcast must support the selected language.
Format	Set the video display format.

DTV Mode (Digital TV)

Picture / Timer Settings

Picture and Timer settings must be adjusted in the TV setup menu. Press **TV SETUP** to access the TV setup menu.

- For details about the Picture settings, refer to the section “TV Mode (Analog TV) > TV Setup > Picture”.
- For details about the Timer settings, refer to the section “TV Mode (Analog TV) > TV Setup > Timer”.

TV Mode (Analog TV)



Set the unit to TV mode to view analog NTSC TV broadcasts.

Press **MODE** to switch the unit to TV mode. (You can also press **DTV/TV** to toggle quickly between DTV and TV modes.)



NTSC television broadcasts will cease in the USA on February 17, 2009. To receive over-the-air television broadcasts after this date, use the digital ATSC tuner (DTV mode).

Basic Operation

1. Ensure that all cable connections have been made properly and securely (refer to the section “Cable Connections” for details).
2. Press  to turn the unit on or off.
3. Press **MODE** until the screen displays “TV” to enter TV mode.
4. If this is the first time you are using the unit, use the TV setup menu to auto-search for TV channels within broadcast range (please see the section “TV Setup” for details).
5. Press **VOL+** or **VOL-** to adjust the volume level.
 - Press  to disable the sound completely. To restore the sound, press  again.
6. Press **CH+** or **CH-** to scan through the available TV channels.
 - Press **RETURN** to return to the previously selected channel.

TV Mode (Analog TV)

- To tune to a channel directly:
 - Input the channel number with the numeric keypad and then press **OK** to enter.



You can use the Input Select key to change the number of inputs the unit will accept before changing the channel.

*When the TV Antenna source is set to “AIR”, press **[-]** to toggle between 1- and 2-digit channel input.*

*When the TV Antenna source is set to “CABLE”, press **[-]** to toggle between 1-, 2-, and 3-digit channel input.*

TV Functions

DTV/TV

Press **DTV/TV** to quickly switch between DTV and TV modes.

Info

Press **INFO** to display program info for the current channel.

- Press **INFO** again to exit the program info display.

Sleep

Press **SLEEP** to set the sleep timer. The unit will turn off automatically at the end of the timer.

- Each press of **SLEEP** will add 10 minutes to the sleep timer.
- While the sleep timer is set, press **SLEEP** to display the remaining time.

TV Mode (Analog TV)

TV Setup

Use the TV setup menu to adjust the TV options.

While the unit is in TV mode, press **TV SETUP** to access the TV setup menu.

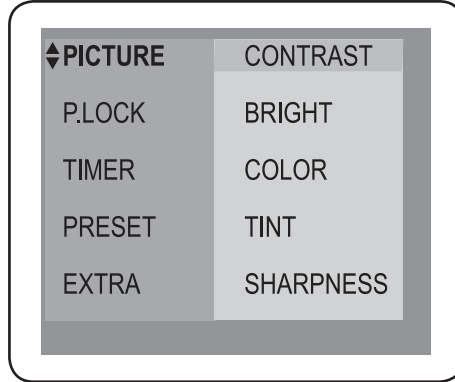

How to use the TV setup menu:

- Press **▲** or **▼** to move the selection cursor up or down, respectively.
- Press **▶** to enter a sub-menu.
- Press **◀** or **▶** to set the options of a selected menu item, or use the numeric keypad if necessary.
- Press **TV SETUP** to return to the previous screen.
- Press **EXIT** to exit the TV setup menu.

TV Mode (Analog TV)

Picture

Set the picture options to change how the screen displays images.

Menu Item	Description
Contrast	Adjust the display contrast.
Bright	Adjust the display brightness.
Color	Adjust the display color saturation.
Tint	Adjust the display tint.
Sharpness	Adjust the display sharpness.

P.Lock (Parental Lock)

Set the Parental Lock options to control which types of programming may be viewed on the unit.





The Parental Lock menu is password-protected. Use the numeric keypad to enter the 4-digit password in order to access the menu.



The initial password is "1111". The password may be changed in the Parental Lock menu. Do NOT forget the password.

TV Mode (Analog TV)

Menu Item	Description
CH Lock	<p>Prevent a channel from being viewed.</p> <ul style="list-style-type: none">• Lock: Turn the lock feature on or off for all channels.• CH: Select the channel to lock.• CH Lock: Turn the lock feature on or off for the channel selected above. <div data-bbox="340 491 1011 619"> When attempting to view a locked channel, the unit will display a blue screen and the message “locked channel”.</div>
Parental	<p>Set the V-chip options. You can set the following program types to “View” or “Block”.</p> <ul style="list-style-type: none">• PARENTAL: Turn the parental lock feature on or off.• MPAA Rating: Set the movie broadcast content ratings.• TV Rating: Set the USA TV broadcast ratings.• Canada English: Set the Canadian English broadcast ratings.• Canada French: Set the Canadian French broadcast ratings.
New Code	<p>Change the Parental Lock password.</p> <div data-bbox="340 1142 1011 1238"> Do not forget the Parental Lock password; this password cannot be reset.</div>

TV Mode (Analog TV)

For your reference:



TV broadcasts include a signal that classifies the contents of the program. When the V-Chip rating options are set, TV broadcasts that have been classified with a higher rating will be blocked.

For more information about ratings in the USA, please visit <http://www.fcc.gov/vchip/>.

For more information about ratings in Canada, please visit <http://www.vchipcanada.ca/>.

Timer

Set the alarm timer options.

Menu Item	Description
On Timer	Set a time for the TV to turn on automatically. <ul style="list-style-type: none">• Press  to toggle between AM and PM.• Use the numeric keypad to enter the time.
On CH	Set the channel that the TV will wake to when the On Timer is set.
Clock	Set the internal clock time of the TV (make sure the clock has been set to the correct time before using the On Timer). <ul style="list-style-type: none">• Press  to toggle between AM and PM.• Use the numeric keypad to enter the time.





Do not unplug the TV or else the On Timer and Clock settings will be lost.

TV Mode (Analog TV)

Preset

Set the preset channel and antenna options for the analog NTSC TV tuner.

Menu Item	Description
CH No	Select a channel to adjust.
CH	<p>After selecting the channel number to adjust (see above), press ◀ or ▶ to toggle between ADDED or DELETED.</p> <ul style="list-style-type: none">• ADDED: The channel will be included when scanning through the channel list.• DELETED: The channel will be skipped when scanning through the channel list. <div style="border: 1px solid black; padding: 5px;"> You can still tune to a deleted channel by using the numeric keypad.</div>
Antenna	<p>Set the antenna system. Press ◀ or ▶ to toggle the antenna setting between AIR or CABLE.</p> <ul style="list-style-type: none">• AIR: Use this setting to receive over-the-air broadcasts from an indoor or outdoor antenna.• CABLE: Use this setting to receive broadcasts from a cable system provider.
Auto Program	<p>Press ◀ or ▶ to initiate the Auto Program feature. The TV will automatically detect signals within reception range and store them to memory.</p> <div style="border: 1px solid black; padding: 5px;"> Set the Antenna option before starting the auto-program operation.</div>

TV Mode (Analog TV)

Extra

Set the Extra options to control the closed-caption, language, background, and auto-program features of the television.

Menu Item	Description
CCD	Set the closed-caption display mode.
Language	Set the on-screen menu language.
Background	Toggle the background feature ON or OFF. When this is set to ON, the TV will display a blue screen (instead of static) when no signal is detected.

DVD Mode

Set the unit to DVD mode to play DVD, DVD±R/RW, CD, CD-R/RW, and JPEG discs with the integrated DVD player.

Press **MODE** to switch the unit to DVD mode.

Basic Operation

1. Ensure that all cable connections have been made properly and securely (refer to the section “Cable Connections” for details).
2. Press  to turn the unit on or off.
3. Press **MODE** until the screen displays “DVD” to enter DVD mode.
4. Load a disc into the player.
 - Press **OPEN/CLOSE** to open the disc tray.
 - Gently place the disc with the label facing up into the disc tray. Do not insert objects other than discs compatible with your DVD player.
 - Press **OPEN/CLOSE** to close the disc tray.



If a single-sided disc has been loaded upside-down, or an otherwise incompatible disc has been loaded, the unit will display “NO DISC” or “INVALID DISC”.

DVDs may have been manufactured with a region code. DVD players cannot play discs with a region code that is different from the player.

If the parental control is set, you will not be able to play a disc that is within the rating setting (see the section “DVD Setup” for more details).

DVD Mode



Invalid Discs: The player is equipped with automatic disc-quality detection software. If the player detects that the disc is damaged or is formatted incorrectly, it may play the disc at a lower quality or stop play completely depending on how damaged the disc is.

DTS Discs: This player does not have a DTS decoder. To enjoy DTS audio discs, use the coaxial digital audio jack to connect the player a receiver with DTS decoding capabilities. You may also select Dolby 5.1 or 2-channel stereo downmix audio instead of the DTS setting.



DVD disc production quality may vary; some discs may deviate from the industry standard. Some incorrectly-formatted discs may still play, however, the playback and operational quality of the disc may be substandard.

Play/Pause/Stop

- Press **PLAY/PAUSE** to play the disc for the first time. (Some discs may start playing automatically.)
- Press **PLAY/PAUSE** during playback to pause. Press **PLAY/PAUSE** again to resume playback.
- Press **STOP** during playback to stop the disc (“Pre-Stop”). Press **PLAY/PAUSE** to resume playback at the time-point at which the disc was stopped.

DVD Mode

- Press **STOP** when the disc is “Pre-Stopped” to stop playback completely. (When **PLAY/PAUSE** is pressed, the disc will start playing from the beginning.)

Previous/Next (Skip)

- Press **PREV** to skip to the previous track (DVD, CD, etc).
- Press **NEXT** to skip to the next track (DVD, CD, etc).

Reverse/Forward (Scan)

- Press **F.BWD** to scan through the disc in reverse. Each successive press of **F.BWD** will change the rate of reverse scanning (see figure below).
- Press **F.FWD** to scan forward through the disc. Each successive press of **F.FWD** will change the rate of forward scanning (see figure below).

→ Normal → x2 → x4 → x8 → x16 → x32

Slow-Motion

- Press **SLOW/STEP** for slow-motion playback. Each successive press of **SLOW/STEP** will change the rate of slow-motion playback (see figure below). Press **PLAY/PAUSE** to resume normal playback.

→ Normal → x1/2 → x1/4 → x1/8 → x1/16

DVD Mode

Step

1. Press **PLAY/PAUSE** to pause playback.
2. Press **SLOW/STEP** to advance playback one frame.
3. Press **PLAY/PAUSE** to resume normal playback.



Audio will be muted during scanning, slow-motion, and step-by-step playback.

Repeat Mode

Press **REPEAT** to select a repeat mode and then press **OK**. Each successive press of **REPEAT** will select the following repeat modes:

	DVD Mode	CD Mode
REPEAT x1	Repeat All	Repeat All
REPEAT x2	Repeat Title	Repeat Track
REPEAT x3	Repeat Chapter	Repeat Off
REPEAT x4	Repeat Off	



Some discs may not support Repeat mode.

A-B Repeat Mode

To repeat a specific section of a disc (looped playback):

1. Press **A-B** to set the desired start point (“A”) of the section to be repeated.
2. Press **A-B** again to set the desired end point (“B”) of the

DVD Mode

section to be repeated.

3. The section “A-B” will now play repeatedly as a loop. Press **A-B** again to resume normal playback.

GOTO (Search)

Press **GOTO** to go directly to a desired point of a disc.

1. Press **GOTO** once to display the Search Bar shown below.
2. Press **◀** or **▶** to select (highlight) an entry field.
 - **For DVD discs:** Select an entry field and then use the numeric keypad to input the desired title, chapter, or time code.

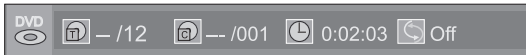

- **For CD discs:** Select an entry field and then use the numeric keypad to input the desired track number or time code.



3. Press **OK** to confirm and execute the search or press **GOTO** to exit search mode.



Some discs may not support the GOTO (search) function.



DVD Mode

Programmed and Random Playback

Change the order in which tracks are played (Normal, Random, Program).

Press **FAV/PROG** to view the Program Mode menu.

- Use the Navigation Keypad to select a program mode and then press **OK**.

Program Mode	Description
 DVD Normal [N] [R] [P]	Select "Normal" to play tracks in normal sequential order.
 DVD Random [N] [R] [P]	Select "Random" to play tracks in random order.
 DVD Program [N] [R] [P]	Select "Program" to play tracks in a custom order.

When "Program" is selected from the Program Mode menu, the Program List screen will appear. Use the Program List to customize the order in which tracks will play.

DVD Program Mode

Select "Program" from the Program Mode menu during DVD playback to display the program mode menu as shown in the figure.

- Use the navigation keypad to select a field. The left column designates the program order number.

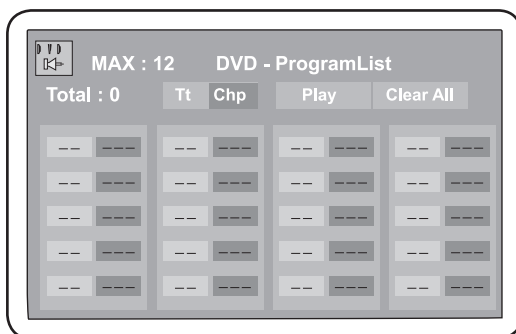

DVD Mode

- Use the numeric keypad to enter track numbers in the left “Trk” columns (or press **OK** to delete).
- Use the numeric keypad to enter chapter numbers in the right “Chp” columns (or press **OK** to delete).
- To start over, use the navigation keypad to select “Clear All”. All Track/Chapter selections will be cleared.
- To play your programmed selections, use the navigation keypad to select “Play” or press **FAV/PROG** to cancel.

CD Program Mode

Select “Program” from the Program Mode menu during CD playback to display the program mode menu shown in the figure.

- Use the navigation keypad to select a field. The left column (Trk) designates the program order number.

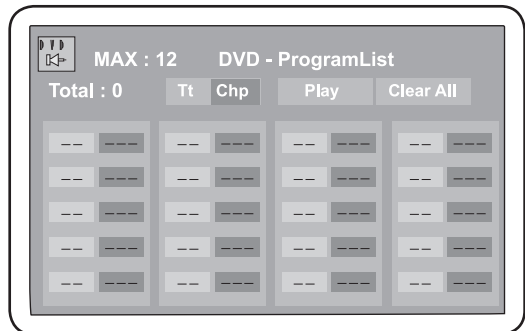

- Use the numeric keypad to enter track numbers in the right “No” columns (or press **OK** to delete).
- To start over, use the navigation keypad to select “Clear All”. All Track selections will be cleared.
- To play your programmed selections, use the navigation keypad to select “Play” or press **FAV/PROG** to cancel.

DVD Mode

DVD Functions

Menu/Title

DVDs may be manufactured with disc and/or title menus. These menus will allow you to access special features of the DVD.

To use these special menus:

- Press **MENU** to access the disc menu.
- If the current track has a menu, press **TITLE** to access the title menu. If no title menu is available, the disc menu may appear.
 - Use the navigation keypad to move the selection cursor and then press **OK**.
 - If necessary, use the numeric keypad to input data.



Features such as alternate camera angles, subtitles, and audio tracks depend on how the DVD was manufactured. Some of these features may not be available on your DVD.

Some of these features may also be controlled on the Setup menu.

Info

Press **INFO** to display playback information on-screen. Press **INFO** again to exit the information display.

DVD Mode

Angle

Press **ANGLE** to select an alternate angle for multi-angle DVD discs. A DVD may contain scenes recorded from various camera positions to allow you to enjoy the same scene from different perspectives.



DVDs that contain multiple angles are usually noted as such on the DVD case.

A DVD may contain up to 9 selectable angles.

Audio

Press **AUDIO** to select an alternate audio language track for multi-language DVD discs.



DVDs that contain multiple audio tracks are usually noted as such on the DVD case.

A DVD may contain up to 8 audio tracks.

Subtitle

Press **SUBTITLE** to select an alternate subtitle language for multi-subtitle DVD discs.



DVDs that contain multiple subtitles are usually noted as such on the DVD case.

A DVD may contain up to 32 subtitles.

DVD Mode

Zoom

Press **ZOOM** to change the magnification level of the picture.

- During DVD or JPEG disc playback, each successive press of **ZOOM** will change the level of magnification as follows: x2, x3, x4, x1/2, x1/3, x1/4, Normal.
- When the magnification level is greater than x1 (normal), use the navigation keypad to pan around the magnified picture.
- When the magnification level is normal, use the navigation keypad to rotate the picture (JPEG disc only).



The picture quality will decrease as the magnification level increases.

DVD Mode

DVD Setup

Use the DVD setup menu to adjust the DVD options.



*Press **STOP** twice to ensure that the player has been completely stopped before entering DVD setup mode.*

While the unit is in DVD mode, press **DTV/DVD SETUP** to access the DVD setup menu.

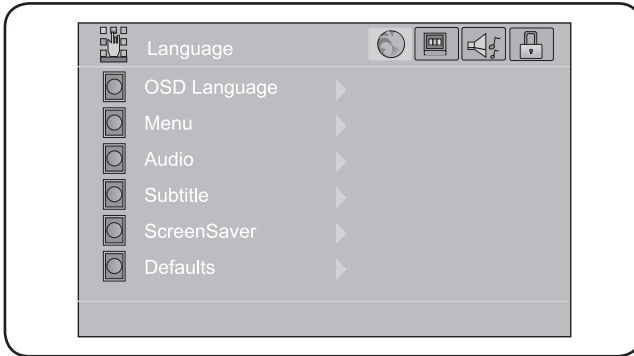

How to use the DVD setup menu:

- Use the navigation keypad to select a desired item.
- Press **OK** to confirm a selection.
- Press **◀** to return to the previous screen.
- Press **DTV/DVD SETUP** to exit the DVD setup menu.

DVD Mode

Language

Set the language options.

Menu Item	Description	Default Setting
OSD Language	Sets the language of the player's on-screen display.	English
Menu	Sets the default menu language of loaded DVDs.	English
Audio	Sets the default language audio track of loaded DVDs.	English
Subtitle	Sets the default subtitle track of loaded DVDs.	English
ScreenSaver	The screensaver prevents burn-in damage to television displays.	On
Default Reset	Reset all options to their factory-default state.	

Display

Set the display options.

Menu Item	Description	Default Setting
Aspect Ratio	Sets the aspect ratio of the display. <ul style="list-style-type: none">• 16:9 is used with widescreen television displays.• 4:3 L-Box (Letterbox) is used with standard television displays.• 4:3 PS (Pan & Scan) is used with standard television displays.	4:3 L-Box

DVD Mode

For your reference:

Letterbox mode fits widescreen content to the screen with black bars at the top and bottom of the picture.

Pan & Scan mode magnifies widescreen content to fill the entire screen. The edges of the picture will be cut off.

Audio

Set the audio options.

Menu Item	Description	Default Setting
Channel Output	Sets the audio channel mix mode (LT/RT, Stereo).	Stereo
SPDIF Digital	Sets the digital audio output signal type (PCM, RAW, OFF). Digital audio output requires a connection to a digital decoding receiver (see your receiver's manual for more information). <ul style="list-style-type: none">• Off: use this setting when the coaxial digital audio connection is not in use to minimize circuit interference.	RAW



To minimize circuit interference, set the SPDIF Digital setting to "Off" when the coaxial digital audio connection is not in use.

DVD Mode

Parental

Set the Parental Control options to control which types of DVDs may be viewed on the unit.



The Parental settings are password-protected. Use the numeric keypad to enter the 4-digit password in order to access the menu.



The initial password is "8888". The password may be changed in the Parental Control menu.

The parental settings password cannot be reset. Please keep the password in a safe place for future reference. Do NOT forget the password.

Menu Item	Description
Change	<p data-bbox="337 863 792 898">Change the Parental Settings password.</p> <p data-bbox="337 914 1003 1023">Enter the old password, the new password, and then the new password again to verify and change the Parental Settings password.</p> <div data-bbox="337 1038 1012 1137"> Do not forget the Parental Control password; this password cannot be reset.</div>

DVD Mode

Menu Item	Description
Rating Level	<p>Sets the maturity rating level of the player. The player will not play any discs rated higher than this setting.</p> <p>There are eight rating levels.</p> <ul style="list-style-type: none">• Level 1 (Kid Safe) will restrict playback to discs suitable for people of all ages.• Level 8 (Adult) will allow playback of all discs, including those suitable for adults only.• A setting of OFF will disable the Rating Level lock. <p>To change the rating level:</p> <ol style="list-style-type: none">1. Select "Rating Level" from the menu and press OK.2. Press ◀ or ▶ to select the desired Rating Level.3. Press OK. You will be prompted to enter the Parental Settings password. Enter the correct password to finish changing the Rating Level.

AV Mode

Use this connection to display optional A/V devices on the unit that are equipped with composite audio/video output jacks..

Set the unit to AV mode to view an external A/V device that has been connected to the composite A/V input jacks.

Press **MODE** to switch the unit to AV mode.



External A/V devices may include VCRs, DVD players, cable/satellite receivers, camcorders, or game consoles that are equipped with composite audio/video output jacks

Basic Operation

1. Ensure that all cable connections have been made properly and securely (refer to the section “Cable Connections” for details).
2. Press  to turn the unit on or off.
3. Turn on and start play on the external A/V device.
4. Press **MODE** until the screen displays “AV” to enter AV mode.

Component Mode

Use this connection to display optional A/V devices on the unit that are equipped with component audio/video output jacks.

Set the unit to Component mode to view an external A/V device that has been connected to the component A/V input jacks.

Press **MODE** to switch the unit to Component mode.



External A/V devices may include VCRs, DVD players, cable/satellite receivers, camcorders, or game consoles that are equipped with component audio/video output jacks

Basic Operation

1. Ensure that all cable connections have been made properly and securely (refer to the section “Cable Connections” for details).
2. Press  to turn the unit on or off.
3. Turn on and start play on the external A/V device.
4. Press **MODE** until the screen displays “Component” to enter Component mode.

Troubleshooting

If you have a problem with this unit, please read the troubleshooting guide below and check our website at www.cobyusa.com for Frequently Asked Questions (FAQs) and firmware updates. If these resources do not resolve the problem, please contact Technical Support.

Address	COBY Electronics Technical Support 56-65 Rust Street Maspeth, NY 11378
Email	techsupport@cobyusa.com
Web	www.cobyusa.com
Phone	800-727-3592: Weekdays 8:00AM–11:00PM EST Weekends 9:00AM–5:30PM EST 718-416-3197: Weekdays 8:00AM–5:30PM EST

There is no power to the device.

- Ensure that the Power Switch is physically set to the ON position.
- Ensure that the AC adapter cord is securely connected to the TV and the proper wall outlet.
- Ensure that the main power has been switched on.

The device does not play.

- Ensure that the TV and Movie rating levels does not exceed the TV's.
- Ensure that the disc's rating level does not exceed the player's.
- Ensure that a supported disc is loaded in the player label-side up.

Troubleshooting

- Ensure that the disc is not damaged or too dirty. Clean the disc or try another disc.
- Moisture may have condensed inside the player. Remove the disc and leave the player on for 1-2 hours and then try again.

There is no picture.

- Ensure that the TV is in the right video mode (press MODE to change the mode).
- Ensure that the TV set has been powered on and is set to the correct AV mode.
- Ensure that the connections between the player and the TV are secure and correct.
- Check if the connection cables are damaged.

The picture is noisy or distorted.

- Reset your TV's color system.
- If an antenna is in use, try repositioning it for better reception.
- Ensure that the aspect ratio of the the video source (e.g., TV antenna, DVD player, cable box, VCR, etc.) matches the aspect ratio of the unit. The aspect ratio of this unit is 4:3.

The picture is noisy or distorted.

- The disc may be damaged or dirty. Clean the disc or try another one.
- Reset your TV's color system.
- If an antenna is in use, try repositioning it for better recep-

Troubleshooting

tion.

There is no sound or distorted sound.

- Ensure that the TV and amplifier have been turned on and properly set up.
- Ensure that the TV and amplifier connections are secure and correct.
- Ensure that the MUTE function of the TV, Amplifier, or Player is not engaged.

The remote control doesn't work.

- Ensure that there are no obstacles between the remote and the player.
- Point the remote at the remote sensor on the main unit.
- Ensure that the batteries in the remote retain a charge and have been installed correctly.
- Try replacing the remote's batteries.

The unit has malfunctioned.

- Unplug the TV and let it rest for 30 minutes. Plug it back in, the restore function should reset the TV.

Specifications

TV-DVD1390

Display Type	13" Color Picture Tube (480i)
TV System	ATSC, QAM, NTSC-M
TV Tuning system	FS with PLL VHF-L: 55.25 ~ 83.25 MHz VHF-H: 175.25 ~ 211.25 MHz UHF: 471.25 ~ 801.25 MHz
Antenna Impedance	75Ω unbalanced
Disc Formats	DVD, DVD±R/RW, CD, CD-R/RW, JPEG
A/V Input	Component Video + Stereo Audio Composite Video + Stereo Audio
A/V Output	Composite Video + Stereo Audio 3.5mm Headphone Coaxial Digital Audio (DVD) Stereo Speakers
Power Supply	AC: 120V/60Hz
Power Consumption	Working: 75W (max) Standby: <3W
Operating Temperature	50°F - 104°F
Unit Dimensions	13.9" x 13.6" x 14.4"

Specifications and manual are subject to change without prior notice.

Specifications

TV-DVD2090

Display Type	20" Color Picture Tube (480i)
TV System	ATSC, QAM, NTSC-M
TV Tuning system	FS with PLL VHF-L: 55.25 ~ 83.25 MHz VHF-H: 175.25 ~ 211.25 MHz UHF: 471.25 ~ 801.25 MHz
Antenna Impedance	75Ω unbalanced
Disc Formats	DVD, DVD±R/RW, CD, CD-R/RW, JPEG
A/V Input	Component Video + Stereo Audio Composite Video + Stereo Audio
A/V Output	Composite Video + Stereo Audio 3.5mm Headphone Coaxial Digital Audio (DVD) Stereo Speakers
Power Supply	AC: 120V/60Hz
Power Consumption	Working: 90W (max) Standby: <3W
Operating Temperature	50°F - 104°F
Unit Dimensions	19.3" x 18.5" x 18.8"

Specifications and manual are subject to change without prior notice.

Notes

Notes

Coby Electronics Corporation

56-65 Rust Street
Maspeth, NY 11378

www.cobyusa.com

www.ecoby.com

Coby is a registered trademark of Coby Electronics Corporation.

Printed in China.