

# Dell™ Metered Rack Power Distribution Unit (rPDU)

## User's Guide

DELLM0001, DELLM001A, DELLM0002, DELLM0003, DELLM0004  
DELLM004A, DELLM0005, DELLM0006, DELLM0007

## Notes and Warnings



**NOTE:** A NOTE indicates important information that helps you make better use of your product.



**CAUTION:** A CAUTION indicates a potentially hazardous situation which, if not avoided, may result in minor or moderate injury or in property damage incidents.



**WARNING:** A WARNING indicates a potentially hazardous situation which, if not avoided, could result in death or injury.



**DANGER:** A DANGER indicates an imminently hazardous situation which, if not avoided, will result in death or serious injury.



**DANGER:** Observe the following instruction to help prevent an imminently hazardous situation which, if not avoided, will result in death or serious injury:

- This rPDU contains **LETHAL VOLTAGES**. All repairs and service should be performed by **AUTHORIZED SERVICE PERSONNEL ONLY**. There are **NO USER SERVICEABLE PARTS** inside the rPDU.

---

**Information in this document is subject to change without notice.**

© 2010 Dell Inc. All rights reserved.

Reproduction in any manner whatsoever without the written permission of Dell Inc. is strictly forbidden.

Trademarks used in this text: *Dell* and the *DELL* logo are trademarks of Dell Inc.; *National Electrical Code* and *NEC* are registered trademarks of National Fire Protection Association, Inc.; *Internet Explorer* and *HyperTerminal* are registered trademarks of Microsoft; *Firefox* is a registered trademark of Mozilla.

Other trademarks and trade names may be used in this document to refer to either the entities claiming the marks and names or their products. Dell Inc. disclaims any proprietary interest in trademarks and trade names other than its own.

# Table of Contents

1	Introduction	
	<b>Physical Description</b>	<b>9</b>
	Installation Configurations	9
	Strain Relief Brackets	10
	Ground Bonding Point	10
	Delta and Wye Configurations	10
	Attached Input Connections	11
	Circuit Breakers	11
	LCD Panel and Pushbutton Controls	12
	Communication and Monitoring Ports	12
	<b>Finding Information</b>	<b>13</b>
2	Safety Warnings	
3	Installation	
	<b>Unpacking the rPDU</b>	<b>15</b>
	<b>Inspecting the Equipment</b>	<b>16</b>
	<b>Checking the Accessory Bag</b>	<b>16</b>
	<b>Preparing for Installation</b>	<b>17</b>
	<b>Installing Hardware for Options</b>	<b>17</b>
	Installing Strain Relief Brackets	17
	Installing Deep Mounting Pegs	18
	<b>Installing the rPDU in the Rack Enclosure</b>	<b>19</b>
	<b>Attaching the Ground Wire</b>	<b>21</b>
	<b>Connecting the Protected Equipment</b>	<b>22</b>
	<b>Starting the rPDU</b>	<b>22</b>
	<b>Shutting Down the rPDU</b>	<b>22</b>
	<b>Front Panels</b>	<b>23</b>
4	External Signaling Ports	
	<b>Communication Ports</b>	<b>27</b>
	Serial Port	28
	Ethernet Port	29

<b>Monitoring Ports</b> .....	<b>29</b>
Temperature and Humidity Sensor (Optional) .....	29
Dry Contact Sensor (Optional) .....	30

## 5 LCD Operation

<b>LCD Panel and Control Buttons</b> .....	<b>31</b>
Locking a Screen .....	33
Automatic Alarm Notification .....	33
<b>Input Status Screen</b> .....	<b>33</b>
<b>Main Menu Selections</b> .....	<b>34</b>
Selecting a Menu .....	35
<b>Performance Menu</b> .....	<b>35</b>
Retrieving Performance Information .....	36
Measured and Calculated Meters .....	38
<b>Alarms Menu</b> .....	<b>39</b>
Retrieving Active Alarms .....	39
<b>Event Log</b> .....	<b>42</b>
Retrieving the Event Log .....	42
<b>System Info</b> .....	<b>43</b>
Retrieving System Identification Information .....	43
<b>Settings</b> .....	<b>43</b>
Retrieving or Changing Configuration Settings in the Settings Menu .....	43

## 6 Serial Interface Operation

<b>Supported Commands</b> .....	<b>50</b>
<b>Nomenclature</b> .....	<b>51</b>
<b>Connecting to the Internal rPDU NMC</b> .....	<b>51</b>
Configuring the Network with a DHCP Server .....	54
Configuring the Network without a DHCP Server .....	55
<b>alarm command</b> .....	<b>56</b>
<b>current command</b> .....	<b>57</b>
<b>exit command</b> .....	<b>58</b>
<b>factory_defaults command</b> .....	<b>59</b>
<b>help command</b> .....	<b>59</b>
<b>network command</b> .....	<b>60</b>
<b>power command</b> .....	<b>61</b>

<b>reboot command</b> .....	<b>61</b>
<b>sensors command</b> .....	<b>62</b>
<b>temperature command</b> .....	<b>63</b>
<b>ver command</b> .....	<b>63</b>
<b>voltage command</b> .....	<b>64</b>

## 7 Web Interface Operation

<b>Navigating the Web Interface</b> .....	<b>66</b>
<b>Accessing the Web Interface</b> .....	<b>68</b>
<b>Configuring DPI Administration Settings</b> .....	<b>69</b>
Configuring Administrator Access .....	69
Configuring User Access .....	69
Setting the Date and Time .....	70
Configuring Email Notification .....	70
Identifying Email Notification Recipients .....	71
Creating Links to External Web Sites .....	72
<b>Configuring DPI Attributes</b> .....	<b>73</b>
Setting Basic DPI Attributes .....	73
Returning Configuration Settings to Default Values .....	73
Uploading a Configuration File .....	74
Downloading a Configuration File .....	74
Configuring Default CSV File Opening Settings .....	75
<b>Configuring Network Access and Control</b> .....	<b>75</b>
Setting General TCP/IPv4 Configuration Options .....	75
Setting General TCP/IPv6 Configuration Options .....	76
Enabling TCP/IP Network Controls .....	77
Adding and Rejecting IP Addresses for SNMP/HTTP Access Control .....	78
Rejecting IP Addresses for SNMP/HTTP Access Control .....	78
Configuring SNMP Protocol Settings .....	79
Configuring SNMP Trap Receivers .....	80
<b>Monitoring and Managing the rPDU</b> .....	<b>81</b>
Viewing Present rPDU Status .....	81
Viewing rPDU and Web/SNMP Card Identification .....	82
Viewing rPDU System Information .....	83
Monitoring Input Statistics .....	83
Managing Environment Sensors .....	86
Viewing Present Alarms and Events .....	88
Viewing Event and Data logs .....	88

Clearing Logs .....	89
Saving Logs to an External File .....	89
Restarting the Internal rPDU NMC .....	90

## Introduction

The Dell™ Metered Rack Power Distribution Unit (rPDU) models are installed at the rear in a rack enclosure. The rack enclosure is designed to hold and protect server, network, and data storage equipment. The rPDUs distribute power in the rack.

The rPDUs are mounted vertically in a recessed channel, providing more room for cabling within the rack enclosure. The recessed location distances the rPDU from the other equipment and does not interfere with the airflow in the rack enclosure.

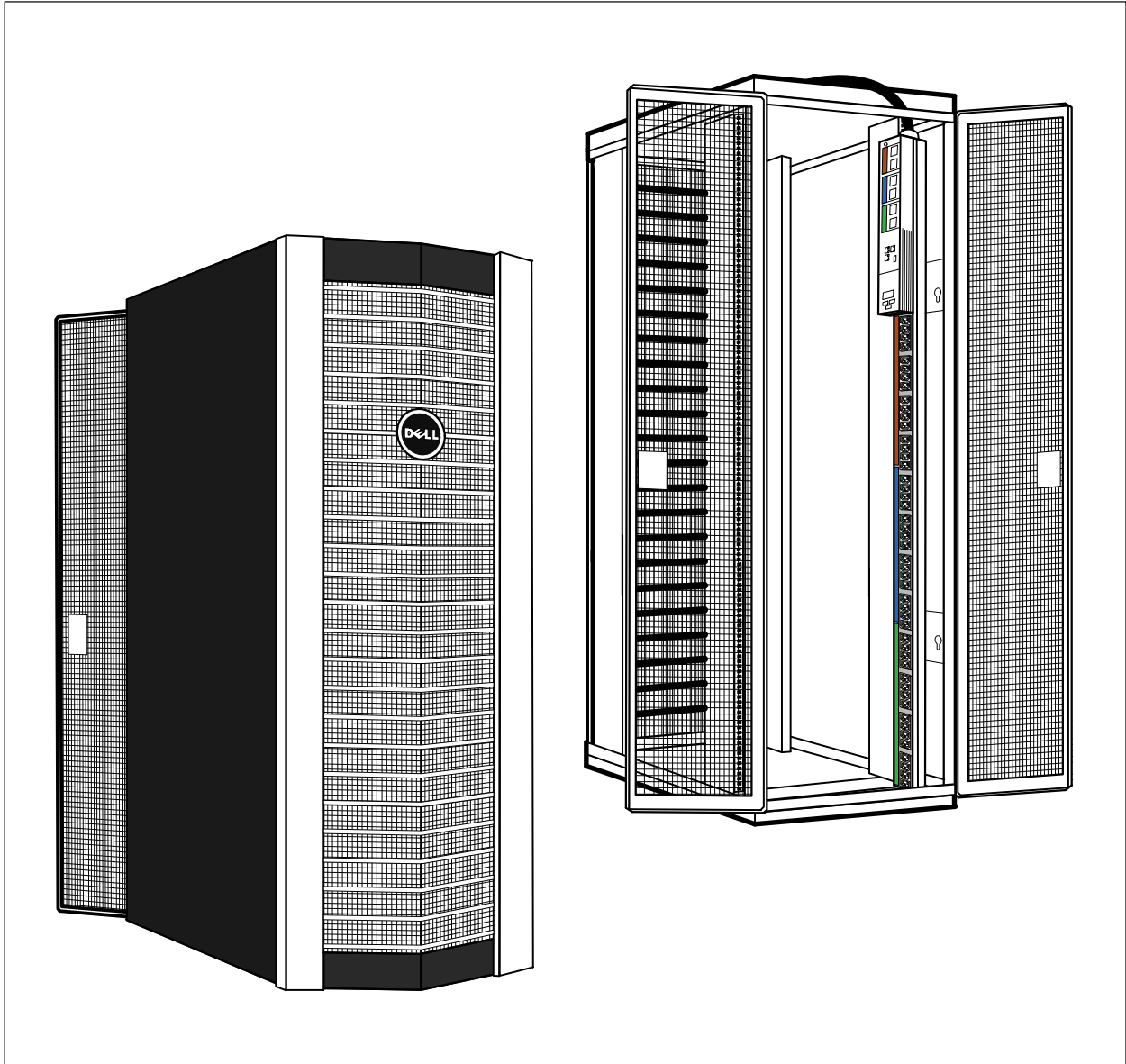


Figure 1. Rack Enclosure with rPDU Installed

Providing outstanding performance and reliability, the rPDU benefits include the following:

- The rPDU can be installed as either 42U or 48U applications (depending on the model).
- The rPDU can be mounted using either factory-installed standard mounting pegs on the back of the rPDU, or turned 90° by using user-installed deep mounting pegs on the side of the rPDU.
- Color-coded silk screening for outlet receptacles and circuit breakers clearly associate circuit breakers with the receptacles they protect.
- The rPDU models provide several configurations of IEC 320 C-13 and IEC 320 C-19 outlet receptacles on the front panel.
- The attached power cords for all models are 3m (10 ft) with IEC60309 input connector plugs.
- All receptacles, circuit breakers, ports, ground bonding point, and user interfaces are located on the front panel of the rPDU for easy access.
- The rPDUs models are configured with either Delta or Wye topology.
- The rPDU provides an environmental monitoring sensor port, a dry contact sensor port, a 10/100 Base-T Ethernet port, and a serial communication port.
- The LCD panel provides pushbutton controls for accessing performance monitoring data, event notifications, and user-configured provisioning options.
- The rPDU provides an internal Dell™ Network Management Card (NMC) for network communications.

The following options are available for the rPDU:

- Side- and front-mounted strain relief brackets for secure power cord retention (bracket type depends on model)
- Dry contact sensor
- Temperature sensor
- Temperature and humidity sensor

The rPDU provides the following meters and measurements for reporting operational status:

- Input Voltage (V)
- Input Frequency in Hertz (Hz)
- Input Current in Amperes (A)
- Input Watts (W)
- Input Volt-amperes (VA)
- Instantaneous Headroom Watts
- Peak Headroom Watts (with time stamp)
- Peak Consumption Watts (with time stamp)
- Cumulative Kilowatt per Hour (with time stamp)
- Temperature (if an optional temperature sensor is installed)
- Humidity (if an optional humidity sensor is installed)
- Real-Time Clock

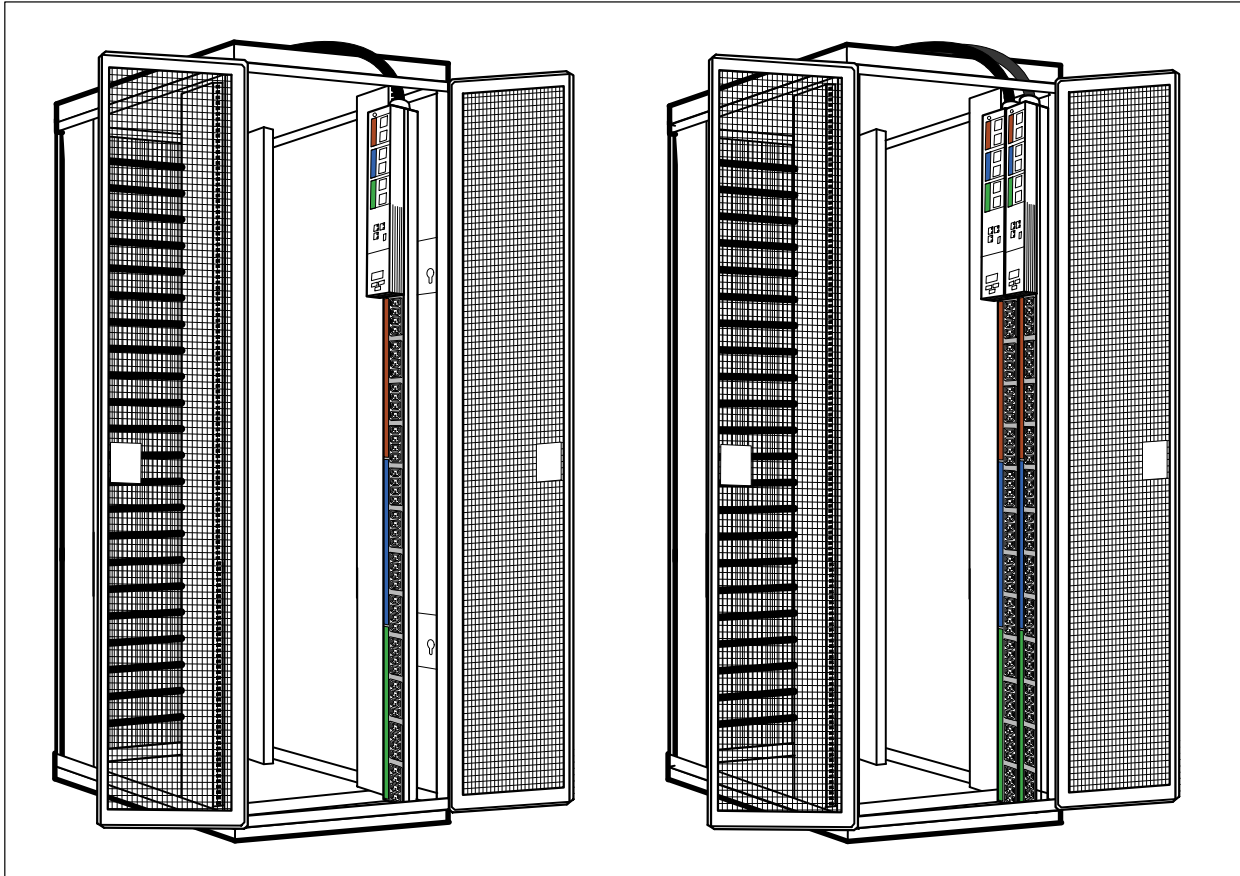


# Physical Description

## Installation Configurations

The rPDUs can be mounted vertically in several installation configurations and orientations to accommodate different site needs. Either one or two rPDUs can be installed in each rPDU tray in the back of a rack enclosure, providing a total of up to four rPDUs (see Figure 2).

**NOTE:** When installing two rPDUs in a side-by-side configuration, you are not restricted to installing the same model. See Figure 2.



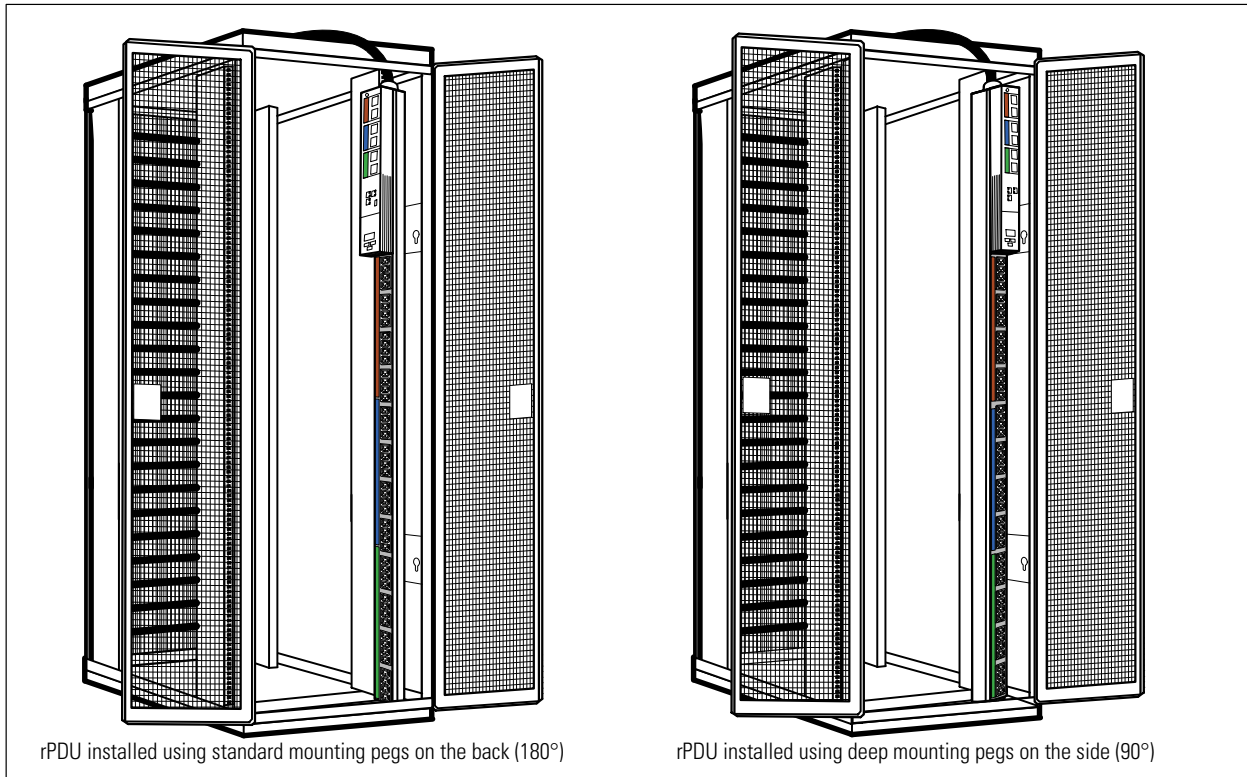
**Figure 2. One or Two rPDUs Installed in the rPDU Tray**

The standard mounting orientation for the rPDU is 180°. This is a snap-in, toolless installation. Two factory-installed mounting pegs are inserted in mounting keyholes on the wall of the rPDU tray.

**NOTE:** The 180° orientation means that the mounting surface (the back of the rPDU) is 180° in relation to the front receptacles.

The rPDU can also be mounted in a 90° orientation. For this configuration, two deep mounting pegs (provided) are user-installed before mounting the rPDU in the rPDU tray (see Figure 3).

**NOTE:** The 90° orientation means that the mounting surface (the side of the rPDU) is 90° in relation to the front receptacles.



**Figure 3. Standard 180° and 90° rPDU Installation**

### Strain Relief Brackets

You can install optional strain relief brackets on any rPDU model. Models with dense receptacle configurations on the front panel have mounting holes for side-mounted relief brackets only. Models with spacing between outlet groupings have mounting holes for both side- and front-mounted relief brackets.

The strain relief bracket kits include three brackets and mounting hardware. The side-mounted brackets can be installed on either side of the rPDU. The front-mounted strain relief brackets are adjustable.

### Ground Bonding Point

The external ground bonding point located on the rPDU front panel may be used to bond other conductive metal components in the rack enclosure to a ground reference point for signaling or other functional purposes. This bonding point can also be used to bond the rPDU to a known earthed reference terminal in the building. Per international regulatory requirements, the primary Safety Earth Bond connection is contained in the rPDU as an integral part of the branch circuit cabling and plug.

### Delta and Wye Configurations

The rPDUs are configured in either Delta or Wye topology.


- The Delta configuration uses a four-wire input connector plug with three phase wires, a protective earth (ground) wire, and no neutral wire. This is commonly expressed as 3W + PE (Delta).
- The Wye configuration uses a five-wire input connector plug with three phase wires, a protective earth (ground) wire, and a neutral wire. This is commonly expressed as 3W + N + PE (Wye).


Table 1 on page 11 lists the Delta or Wye configuration for each model.

## Attached Input Connections

All models use an IEC60309 input connector plug on a 3m (10 ft) cable attached to the rPDU. The type of input connector plug varies by model to accommodate different amperage ratings and Delta or Wye configurations.

The input connector plugs have Ingress Protection (IP) ratings that specify the degree of environmental protection for electrical equipment. All models use IEC60309 input connector plugs that are either splash resistant (S) or waterproof (W).

 **NOTE:** Splash resistant plugs are IP-rated at IP 44, which means the plug is protected against solid objects less than 1.0 mm in diameter.

 **NOTE:** Waterproof plugs are IP-rated at IP 67, which means the plugs are watertight, splashproof, and dust tight.


Standard IEC60309 reference codes provide a useful summary of the input connector plug specifications. The code includes the number of pins, the maximum amperage rating, the type of connection, the alignment tab clock position, and the protective classification.

Table 1 lists the standard IEC60309 reference codes for each model.

**Table 1. Metered rPDU IEC60309 Codes**

Model	IEC Reference Code	Delta 4-Pin Plug (4) or Wye 5-Pin Plug (5)	Maximum Amperage (A) Rating	Plug (P) Receptacle/Socket (R) or Connector (C)	Clock Position PE (6 or 9)	Waterproof (W) or Splash Resistant (S)
DELLM0001	460P9W	4	60	P	9	W
DELLM001A	460P9W	4	60	P	9	W
DELLM0002	532P6S	5	32	P	6	S
DELLM0003	516P6S	5	16	P	6	S
DELLM0004	460P9W	4	60	P	9	W
DELLM004A	460P9W	4	60	P	9	W
DELLM0005	532P6S	5	32	P	6	S
DELLM0006	460P9W	4	60	P	9	W
DELLM0007	532P6S	5	32	P	6	S

## Circuit Breakers

 **NOTE:** The DELLM0003 model does not have circuit breakers.

There are six 20A circuit breakers on the rPDU (two circuit breakers per phase protecting the group of outlet receptacles for that phase). Circuit breakers on the rPDU trip automatically when a power overload is detected. Standard rPDU circuit breakers have Type C trip characteristics.

The rPDU monitoring firmware provides warnings that there is potential for overload and alarms if an overload occurs. These thresholds are user-configurable. To reset the breakers after an overload, flip the breaker switch to the ON position.

Circuit breakers and outlet receptacles are numbered and color-coded on the front panel to show the association between breakers and the receptacles they protect. The phases (L1, L2, and L3) and protecting circuit breakers (CB1 through CB6) are labeled on both circuit breaker groups and outlet receptacle groups (see Figure 4).

## LCD Panel and Pushbutton Controls

The rPDU interface provides access to real-time performance monitoring and event notification data through the LCD panel and pushbutton controls. This interface is also used to set user-configurable values, such as alarm or warning thresholds. See Figure 4.

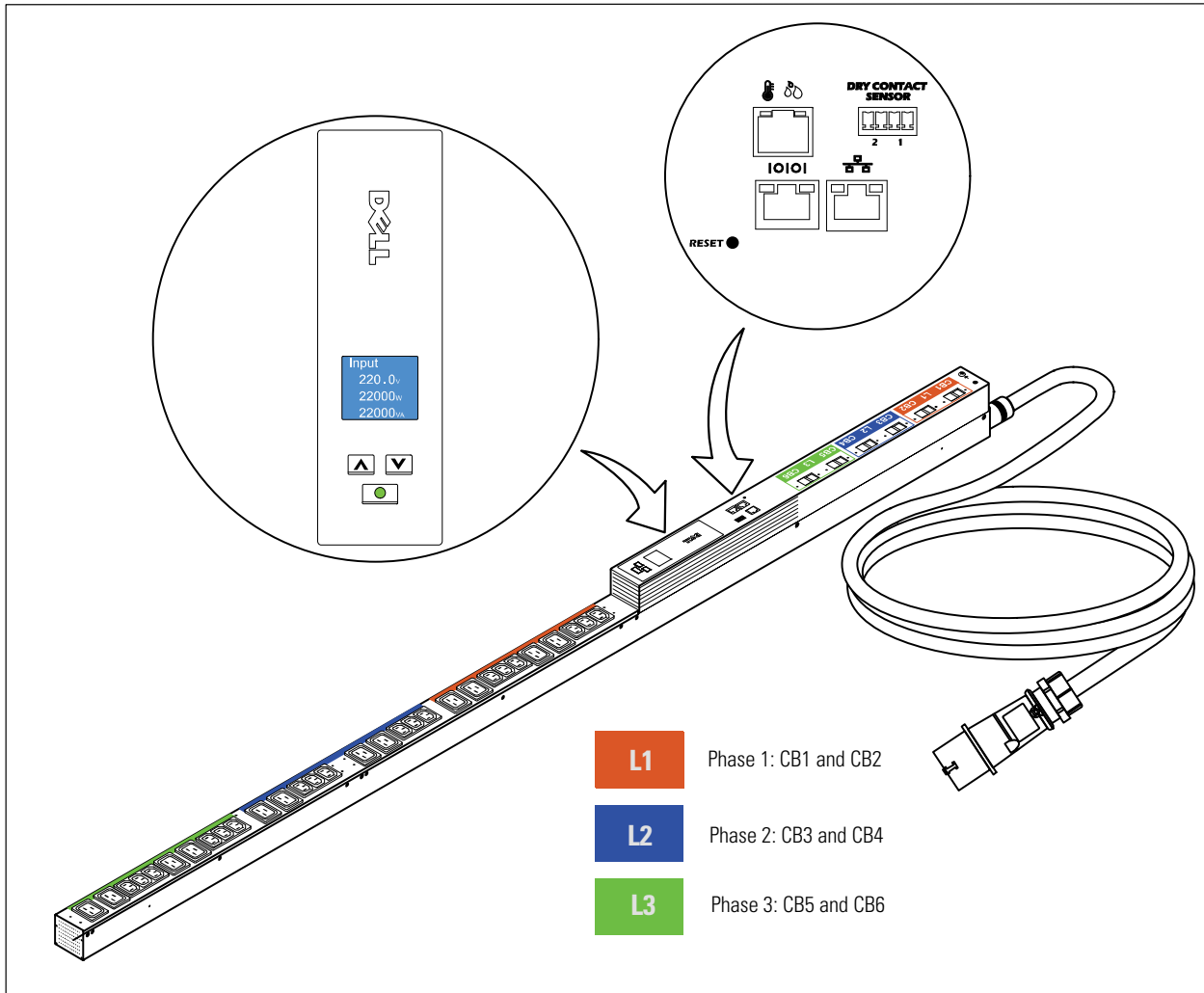


Figure 4. LCD Front Panel

## Communication and Monitoring Ports

Two communication ports are provided. The rPDU has a serial port for an RJ-45 to DB-9 cable (provided) for serial communication. The rPDU also has a 10/100 Base-T Ethernet port for network communication.

The network communication channel can be used to perform firmware upgrades (flash upgrades) over the network. Upgrades can be performed for rPDUs installed in the rack enclosure while they are powered.

Two monitoring ports are provided. The following optional monitoring sensors can be installed:

- Dry contact sensor
- Temperature-only or combined temperature and humidity sensor

## Finding Information



**CAUTION:** The *Safety, Environmental, and Regulatory Information* document provides important safety and regulatory information.

<b>What are You Looking For?</b>	<b>Find It Here</b>
<ul style="list-style-type: none"><li>• <i>Dell Metered Rack Power Distribution Unit (rPDU) User's Guide</i></li><li>• Other rPDU documentation, such as Product Overview documents</li></ul>	Documentation can be found at: <b><a href="https://support.dell.com/support/edocs/ACC/PDU/">support.dell.com/support/edocs/ACC/PDU/</a></b>
<ul style="list-style-type: none"><li>• Software updates</li></ul>	Software updates can be found at: <b><a href="https://support.dell.com">support.dell.com</a></b>
<ul style="list-style-type: none"><li>• How to install the rPDU</li><li>• rPDU specifications</li><li>• How to configure rPDU settings</li><li>• How to operate the rPDU</li></ul>	<b>Dell Metered rPDU User's Guide</b> The user's guide is available at: <b><a href="https://support.dell.com/support/edocs/ACC/PDU/">support.dell.com/support/edocs/ACC/PDU/</a></b>
<ul style="list-style-type: none"><li>• Safety instructions</li><li>• Regulatory information</li><li>• Recycling information</li></ul>	<b>Safety, Environmental, and Regulatory Information</b>
<ul style="list-style-type: none"><li>• Warranty information</li><li>• Terms and Conditions (U.S. only)</li><li>• End User License Agreement</li></ul>	<b>Dell Warranty and Support Information</b>
<ul style="list-style-type: none"><li>• Support information</li></ul>	<b>Dell Support Website — <a href="https://support.dell.com">support.dell.com</a></b> <b>NOTE:</b> Select your region or business segment to view the appropriate support site.

# Safety Warnings

## IMPORTANT SAFETY INSTRUCTIONS SAVE THESE INSTRUCTIONS

This manual contains important instructions that you should follow during installation and operation of the Dell Metered Rack Power Distribution Unit (rPDU). Please read all instructions before operating the equipment and save this manual for future reference.



### **DANGER:**

This rPDU contains LETHAL VOLTAGES. All repairs and service should be performed by AUTHORIZED SERVICE PERSONNEL ONLY.



### **CAUTION:**

- To reduce the risk of fire or electric shock, install this rPDU in a temperature and humidity controlled, indoor environment, free of conductive contaminants. Ambient temperature must not exceed 50°C (122°F). Do not operate near water or excessive humidity (95% maximum).
- To comply with international standards and wiring regulations, the total equipment connected to the output of this rPDU must not have an earth leakage current greater than 3.5 milliamperes.
- For PLUGGABLE EQUIPMENT, a readily accessible disconnect device shall be incorporated in the building installation wiring.
- For PLUGGABLE EQUIPMENT, the power outlet shall be installed near the equipment and shall be readily accessible.

# Installation

This section explains:

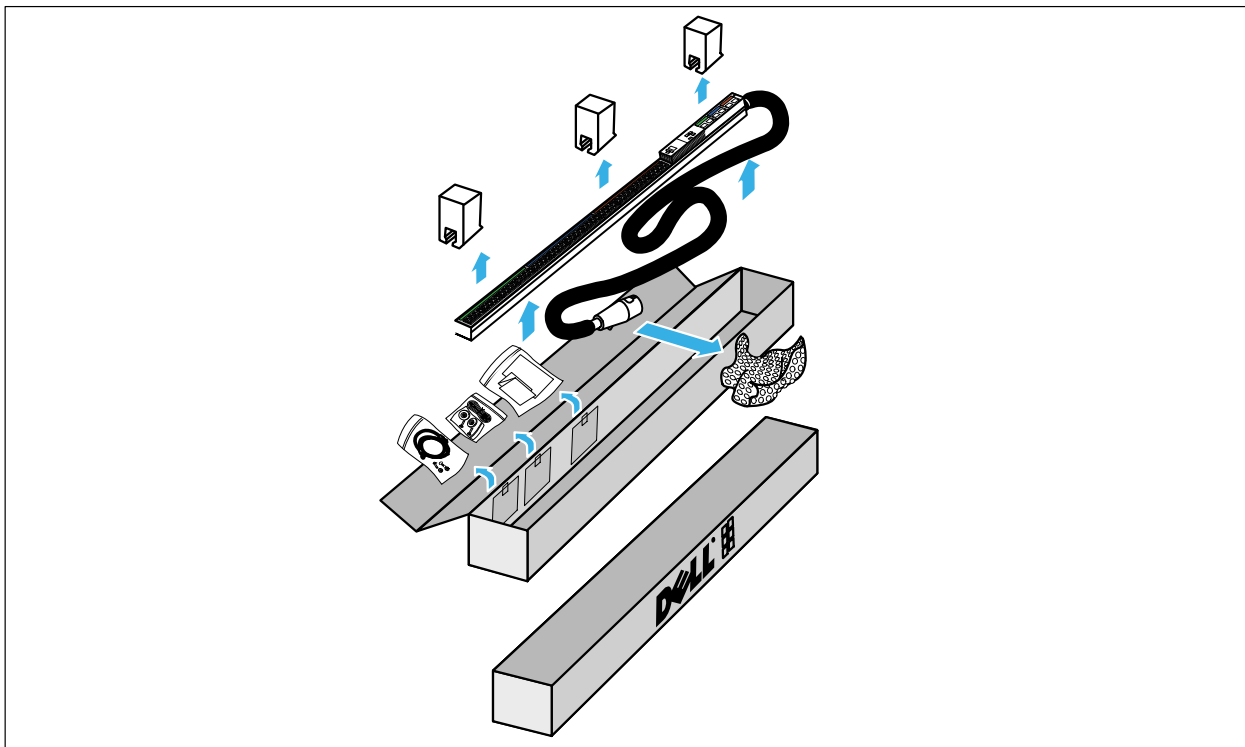
- Unpacking the Dell Metered Rack Power Distribution Unit (rPDU) equipment
- Equipment inspection
- Setup and installation
- Starting up and shutting down the rPDU
- Front panel diagrams

## Unpacking the rPDU

**⚠ CAUTION: Hazard of electric shock. Unpacking the cabinet in a low-temperature environment may cause condensation to occur in and on the rPDU. Do not install the rPDU until the inside and outside are dry.**

Use care when moving and opening the carton. Leave the components packaged until ready to install.

- 1 Remove the top from the carton (see Figure 5).



**Figure 5. Unpacking the rPDU**

- 2 Remove the rPDU, the accessory bag, and documentation from the carton:

Grasp the rPDU and the input connector plug and set them on a flat, stable surface.

Remove the Styrofoam shipping supports from the rPDU and the wrapper from the input connector plug.

Remove the documents and the accessory bag from the inside wall of the carton.

- 3 Place the rPDU in a protected area that has adequate airflow and is free of humidity, flammable gas, and corrosion.
- 4 Discard or recycle the packaging in a responsible manner, or store it for future use.

## Inspecting the Equipment

If any equipment has been damaged during shipment, keep the shipping cartons and packing materials for the carrier or place of purchase and file a claim for shipping damage. If you discover damage after acceptance, file a claim for concealed damage.

To file a claim for shipping damage or concealed damage: 1) File with the carrier within 15 days of receipt of the equipment; 2) Send a copy of the damage claim within 15 days to your service representative.

## Checking the Accessory Bag

The rPDU accessory bag includes the following:

- (2) deep mounting pegs and (2) 8-32 × 5/8" mounting screws (for 90° installation)
- Grounding kit with:
  - (1) silver 10-32 × 0.5" pan-head screw
  - (1) black, M5 × 12 pan-head screw
  - (1) ground wire
  - (2) star washers
- *Safety, Environmental, and Regulatory Information* (SERI) document
- Quick Start Installation Sheet
- (1) RJ-45 Cable (RJ-45-to-DB9-female, 2.0m length, serial cable)

If you ordered the optional strain relief brackets (shipped separately), check that the following associated hardware is included with the option.

For the side-mounted strain relief bracket:

- (3) strain relief brackets
- (8) M3 × 6 flat-head cross screws

For the front-mounted strain relief bracket:

- (3) strain relief brackets
- (4) 6-32 × 1/4" flat-head cross screws



## Preparing for Installation

Before installing the rPDUs in a rack enclosure, consider location and orientation. For most installations, the selected location and orientation depends on the number of rPDUs that will be installed and the cable management plan.

For example, suppose you plan to separate data and power cables on opposite sides of the rack enclosure. For this configuration, install one or two rPDUs in the same tray. Route the data cables to the other rPDU tray (serving as a cable channel) on the opposite side of the rack enclosure.

Another plan might be to balance the data and power cables on each side. For this configuration, install one rPDU on each side of the rack enclosure. The remaining portion of each rPDU tray serves as a cable channel for bundled and properly dressed data cables running beside the rPDU.

Other considerations include the orientation of the rPDU and the type of strain relief brackets mounted on the rPDUs.

## Installing Hardware for Options

Install the hardware that supports installation options before installing the rPDUs in the rack enclosure. This includes the following:

- Strain relief brackets for cord management (optional kit)
- Deep mounting pegs for the 90° mounting option (supplied)



**NOTE:** The factory-installed standard mounting pegs are secured to the chassis by two 8-32 × 3/7" mounting screws. The user-installed deep mounting pegs are secured to the chassis by two 8-32 × 5/8" mounting screws.

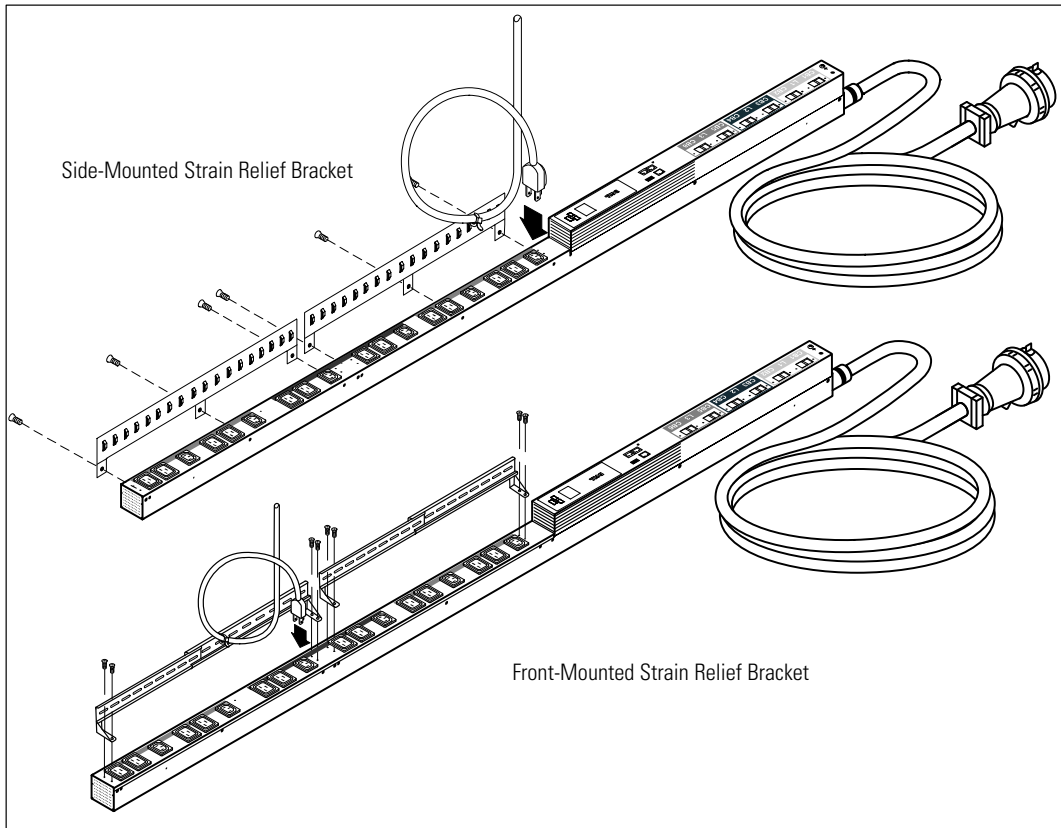
### Installing Strain Relief Brackets

To install the optional strain relief brackets:

- 1 Place the rPDU on a flat, stable surface.
- 2 Align the screw mounting holes on the rPDU with the screw mounting holes on the bracket (see Figure 6).
- 3 Secure the bracket with the supplied screws.
- 4 Are you installing deep mounting pegs for 90° installation?

If no, go to “Installing the rPDU in the Rack Enclosure” on page 19.

If yes, continue to the next section, “Installing Deep Mounting Pegs” on page 18.




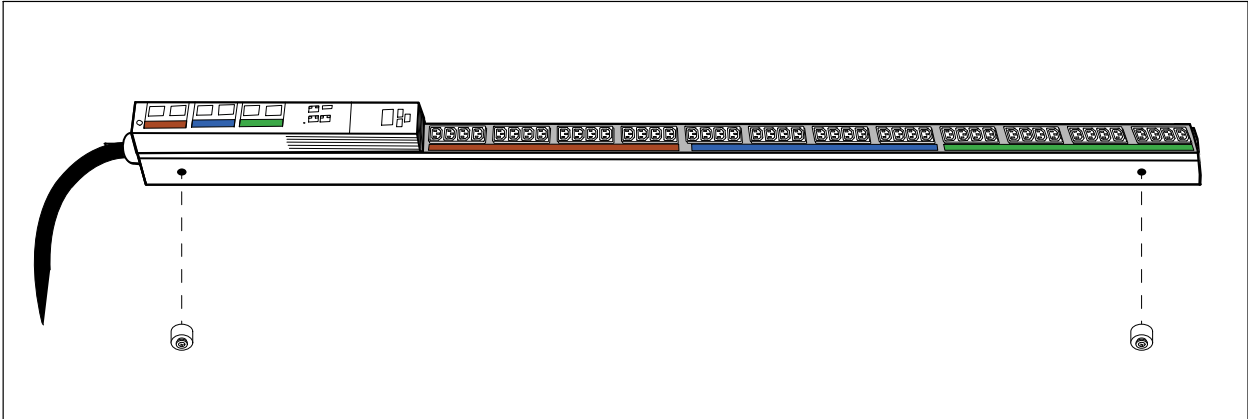
**Figure 6. Strain Relief Bracket**

### Installing Deep Mounting Pegs

To install the deep mounting pegs (supplied) on the side of the rPDU for 90° mounting installations:

- 1 Remove the two deep mounting pegs and two mounting screws from the accessory bag.
- 2 Locate the top and bottom peg mounting holes on the side of the rPDU (see Figure 7).
- 3 Align the peg mounting holes on the rPDU with the mounting hole in the center of the deep mounting pegs.
- 4 Secure the top and bottom deep mounting peg with the provided screws (see Figure 7).

 **NOTE:** Dell recommends removing the standard mounting pegs on the rear of the rPDU if you install the deep mounting pegs (provided in the accessory kit shipped with the rPDU). Retain the standard mounting pegs so the rPDU can be reoriented later if needed.

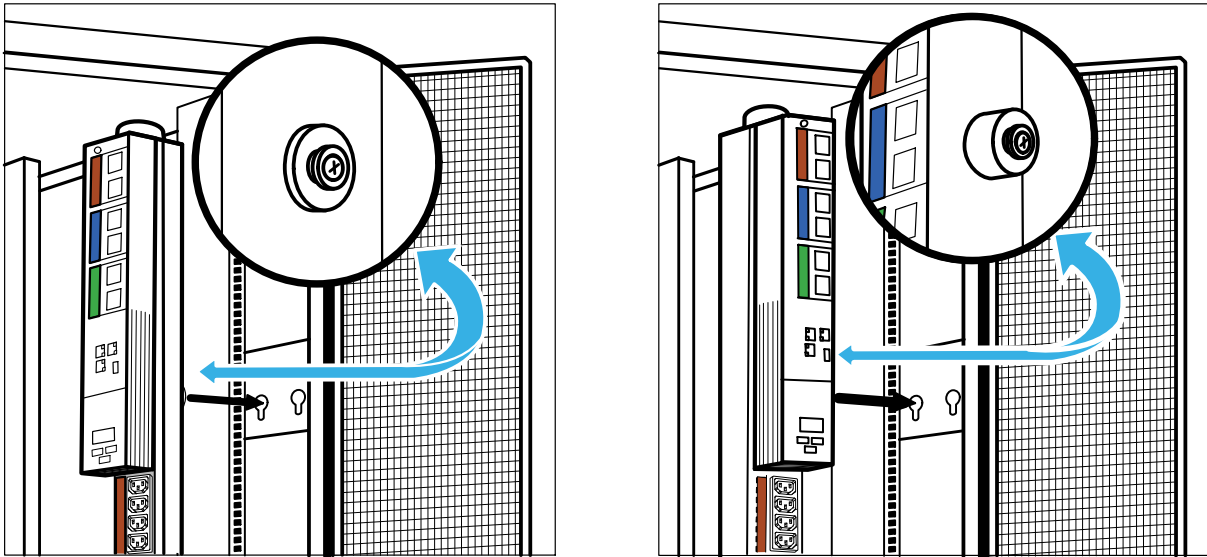


**Figure 7. Installing the Deep Mounting Pegs**

## Installing the rPDU in the Rack Enclosure

To install the rPDU in a rack enclosure:

- 1 Move the rPDU into position at the rear of the rack enclosure.
- 2 Select the proper keyholes in the rPDU tray for mounting the rPDU.
- 3 Align the mounting pegs with the keyholes in wall of the rPDU tray (see Figure 8).

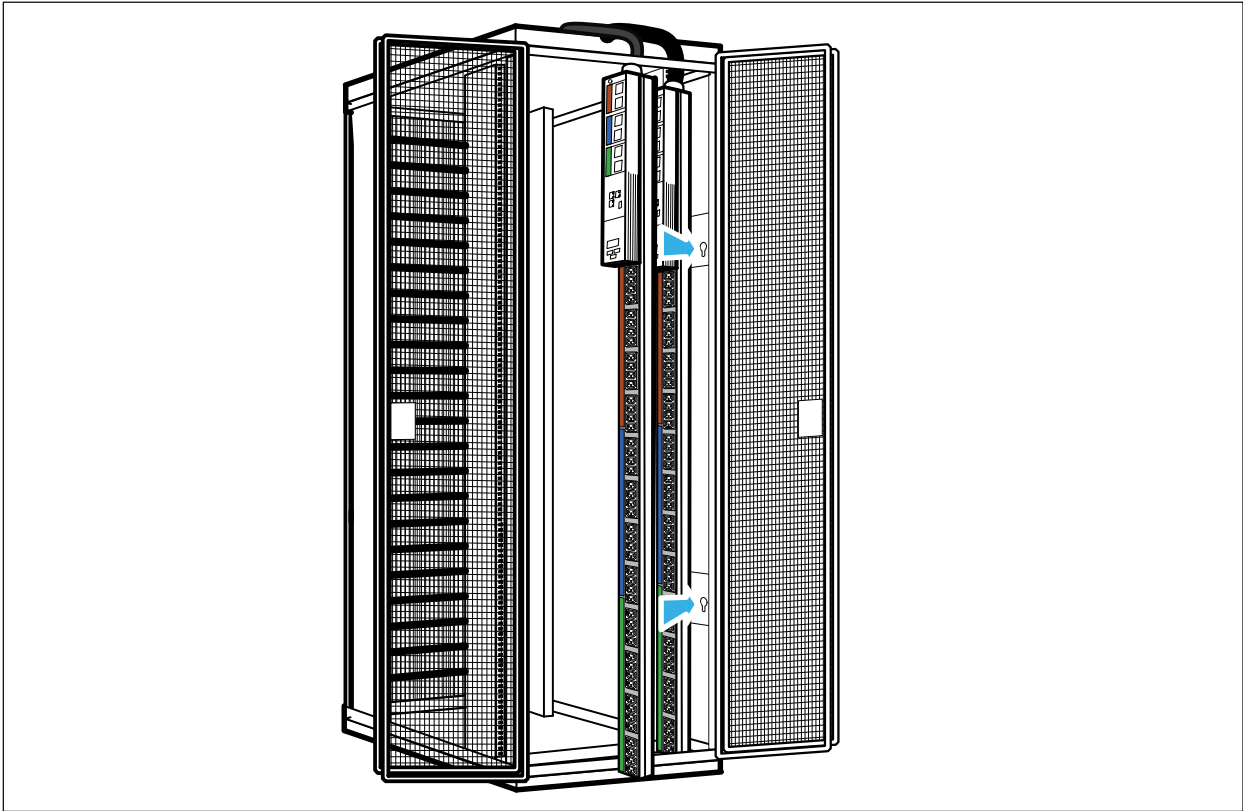


**Figure 8. Aligning and Inserting the Standard or Deep Mounting Pegs (Top Mounting shown; Bottom Mounting not shown)**

- 4 Fully insert both mounting pegs into the keyholes.
- 5 Push down to set the rPDU in place.



**NOTE:** A second rPDU can be installed in the same tray. The procedure is the same. See Figure 9.




**Figure 9. Mounting Two rPDUs in the PDU Tray**

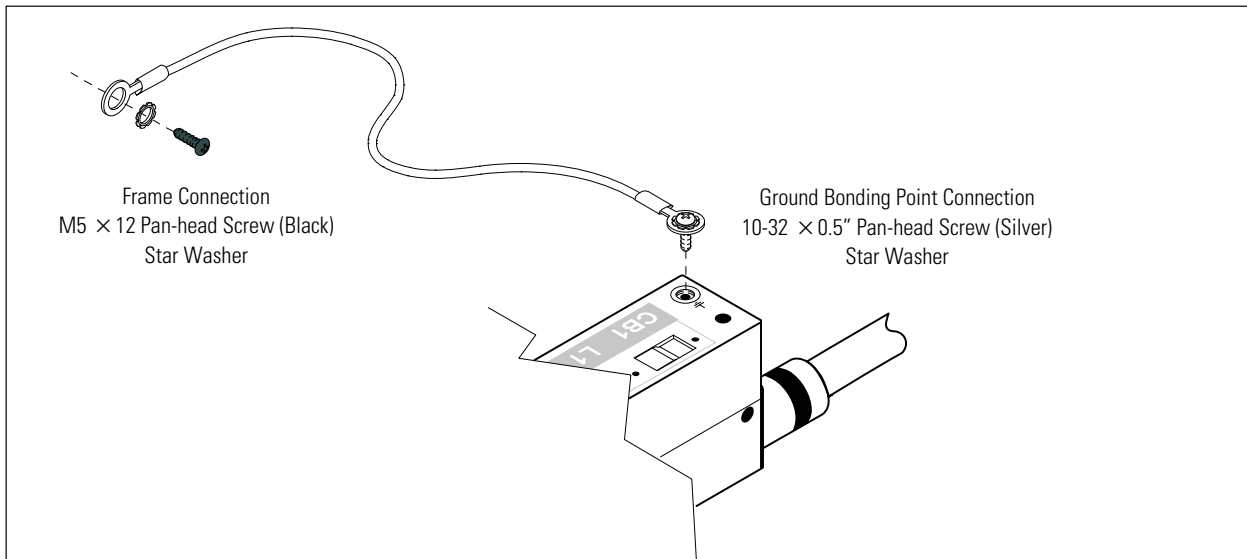
- 6 Continue to “Attaching the Ground Wire” section on page 21.

## Attaching the Ground Wire

To attach the ground wire to the rack:

 **NOTE:** Dell recommends that you ground the rPDU to the rack frame with the ground wire provided in the Grounding Wire Kit.

- 1 Connect one end of the ground wire to the ground bonding point location on the front panel of the rPDU using the silver, 10-32 × 0.5" pan-head screw and star washer (supplied).
- 2 Connect the other end of the ground wire to a hole in the rack frame using the black, M5 × 12 pan-head screw and star washer (supplied). See Figure 10.





**Figure 10. Ground Bonding Point and Frame Connections**

- 3 Continue to “Connecting Protected Equipment” on page 22.

## Connecting the Protected Equipment


 **CAUTION:** For **PLUGGABLE EQUIPMENT**, the power outlet shall be installed near the equipment and shall be readily accessible.

 **CAUTION:** The rPDU output receptacles for each phase are protected by two 20A circuit breakers on the front panel. Confirm that the equipment connected to the rPDU does not exceed the rPDU's capacity.


 **NOTE:** The DELLM0003 model does not have circuit breakers.

To install the plug-receptacles:

- 1 Plug the equipment power cords into the rPDU outlet receptacles.
- 2 If an optional strain relief bracket is installed, attach the power cords to the bracket by looping the cords and securing them with tie wraps.

 **NOTE:** Secure the power cords in the bracket so you can unplug them without removing the tie wrap.


- 3 Plug the rPDU power cord into a power outlet.
- 4 Ensure that each circuit breaker is in the ON position.

 **NOTE:** If power to the rPDU is interrupted, check each circuit breaker and reset if necessary.


## Starting the rPDU

To start the rPDU:

- 1 Plug the rPDU power cord into the power outlet.
- 2 Turn each circuit breaker to the ON position.
- 3 If power to the rPDU is interrupted, check each circuit breaker and reset if necessary.

 **NOTE:** During startup, the Dell Startup screen displays for five seconds and then defaults to the Input Status screen.

## Shutting Down the rPDU

 **NOTE:** The protected equipment may be turned off at the equipment or, for models with circuit breakers, at the circuit breakers on the rPDU.

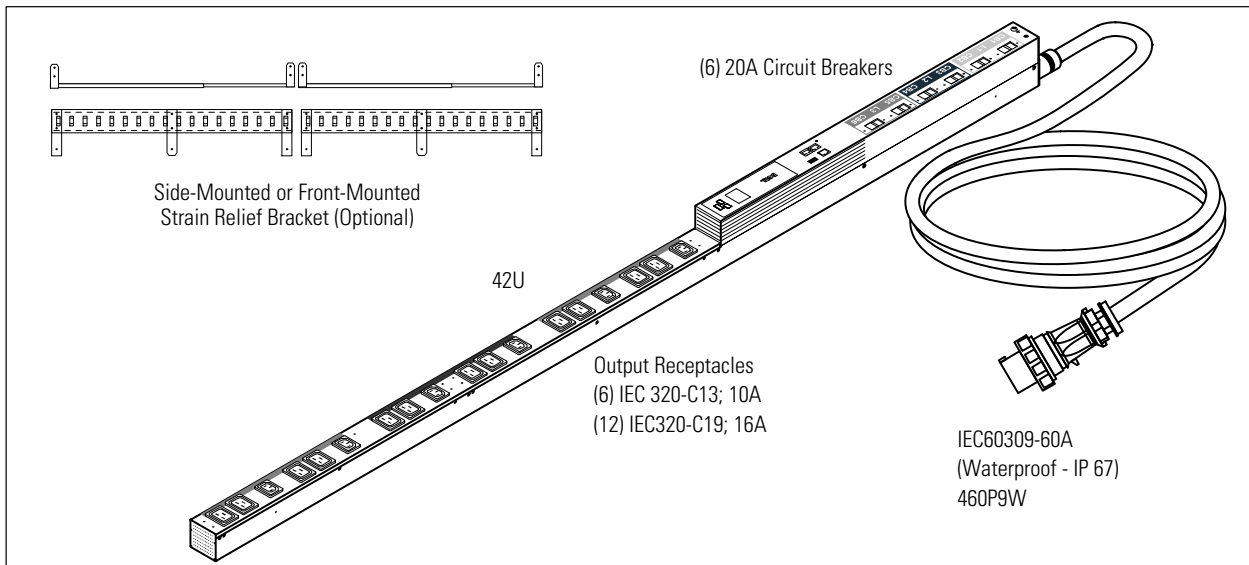
To shut down the rPDU:

- 1 Shut down the protected equipment according to the manufacturer's recommended shutdown sequence.
- 2 **Models with circuit breakers only.** Turn each circuit breaker to the OFF position.
- 3 To remove power from the rPDU completely, disconnect the rPDU input connector at the source.

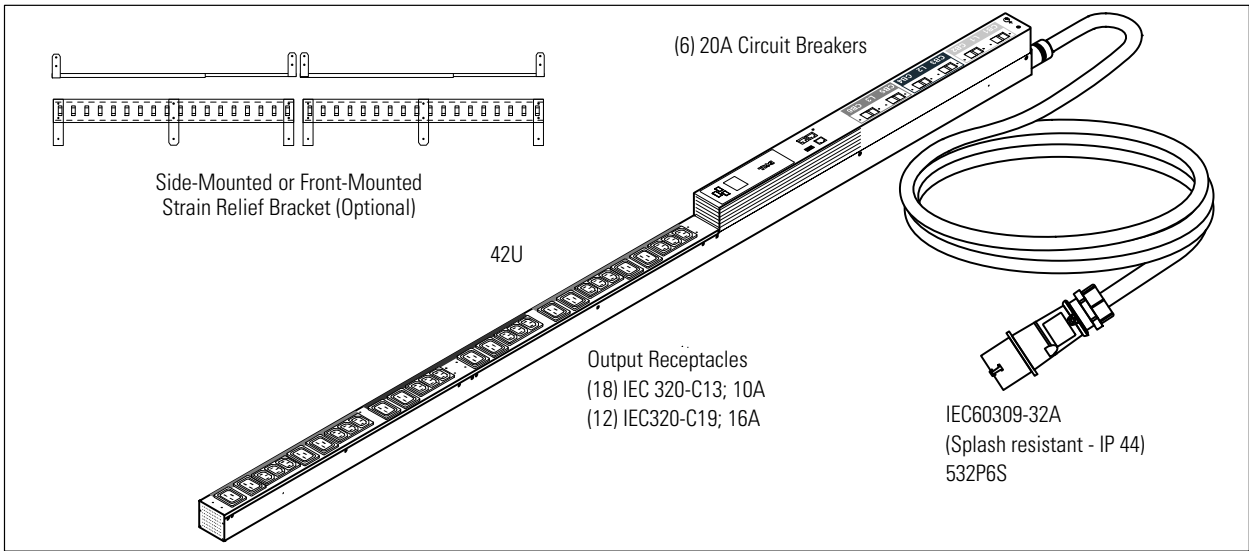
# Front Panels

This section shows the front panels of the rPDU models.

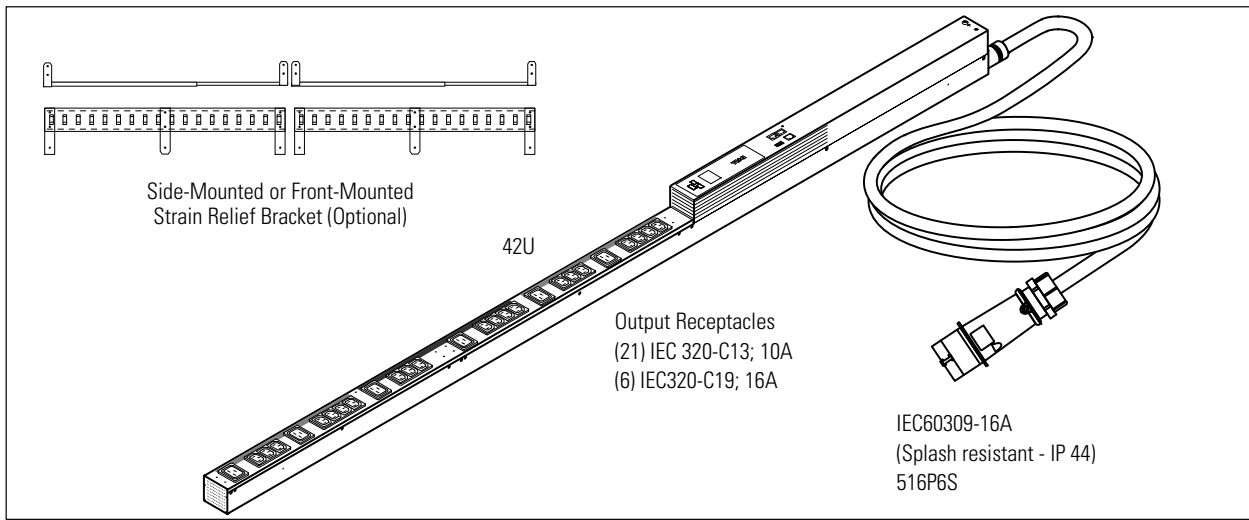
rPDU Model Number	See Figure	On Page
DELLM0001	Figure 11	23
DELLM001A	Figure 11	23
DELLM0002	Figure 12	24
DELLM0003	Figure 13	24
DELLM0004	Figure 14	25
DELLM004A	Figure 14	25
DELLM0005	Figure 15	25
DELLM0006	Figure 16	26
DELLM0007	Figure 17	26



**Figure 11. DELLM0001 and DELLM001A**

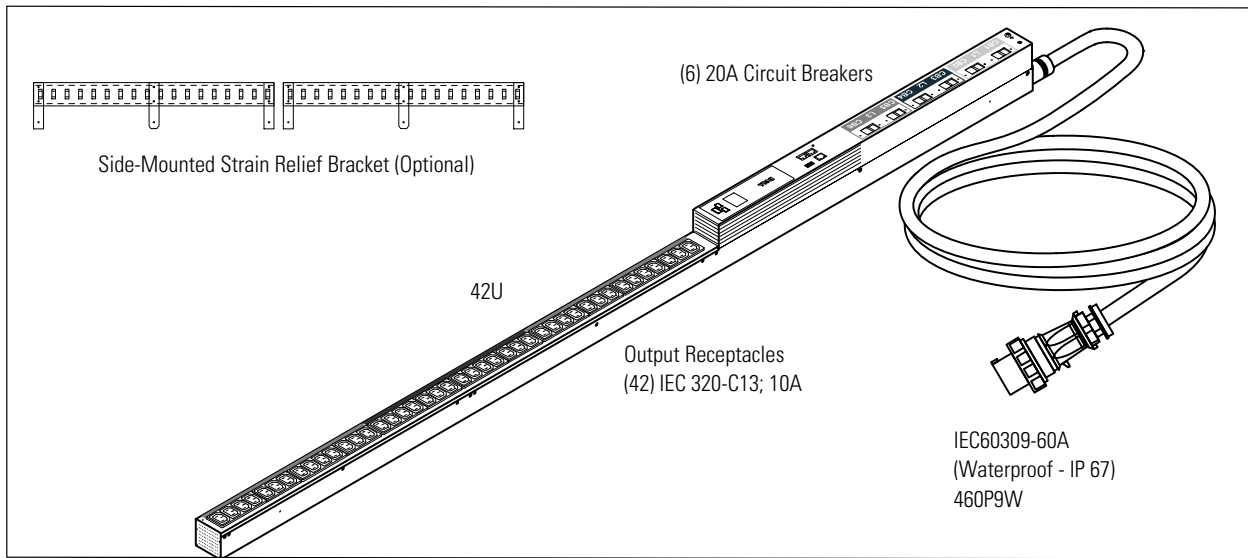


**Figure 12. DELLM0002**

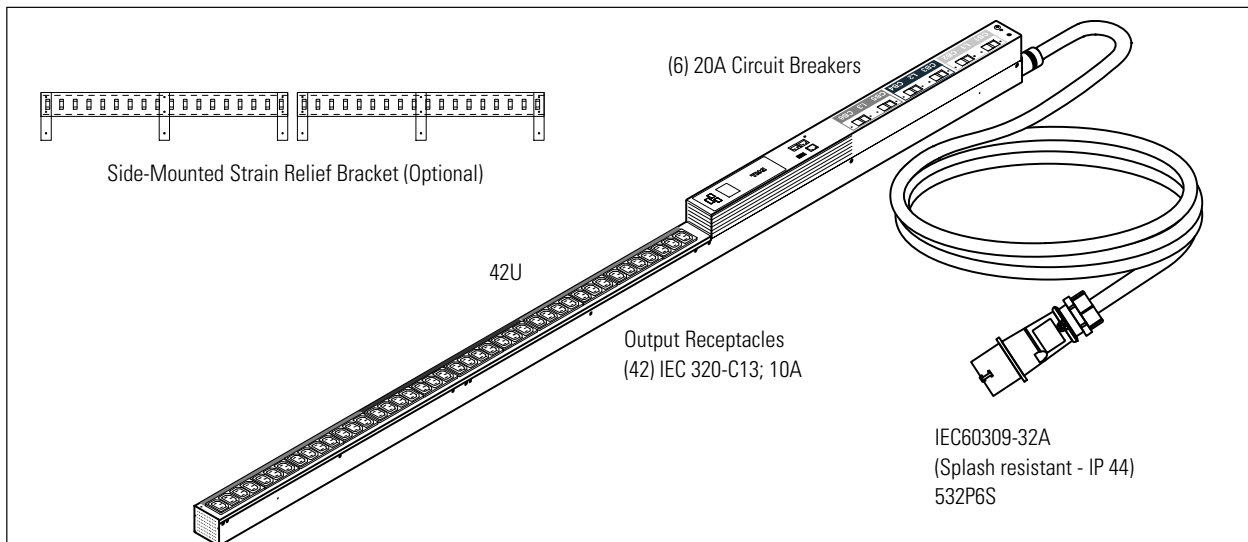


**Figure 13. DELLM0003**

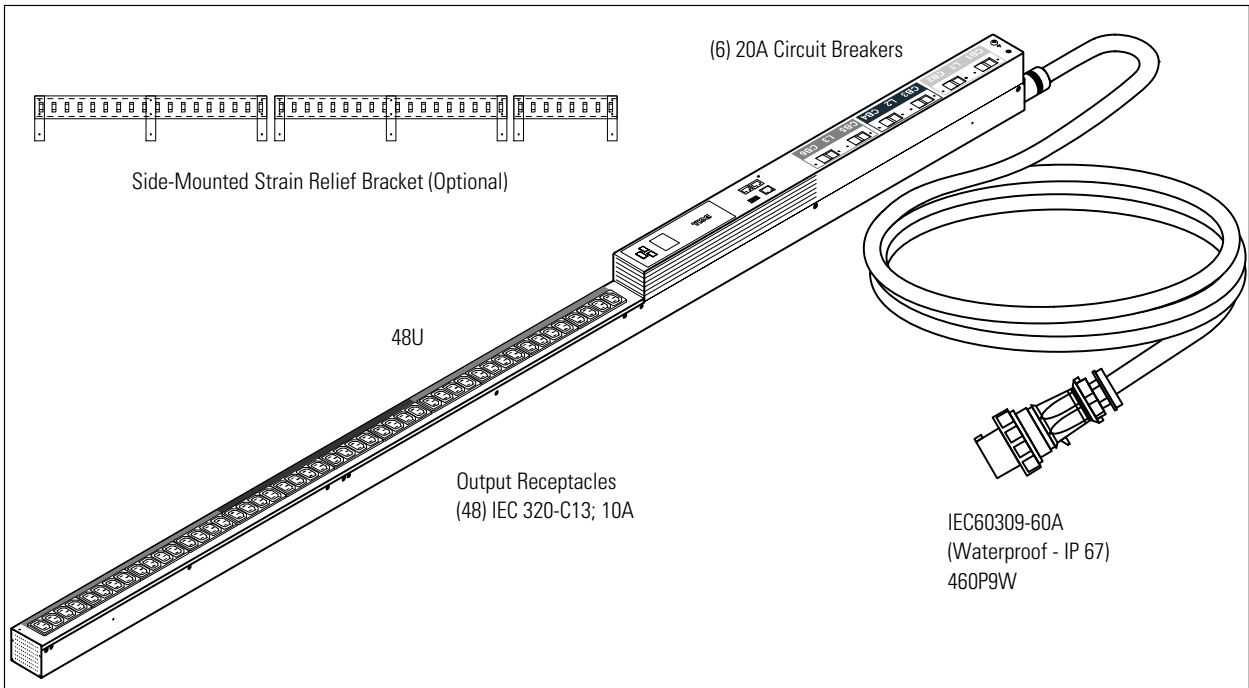




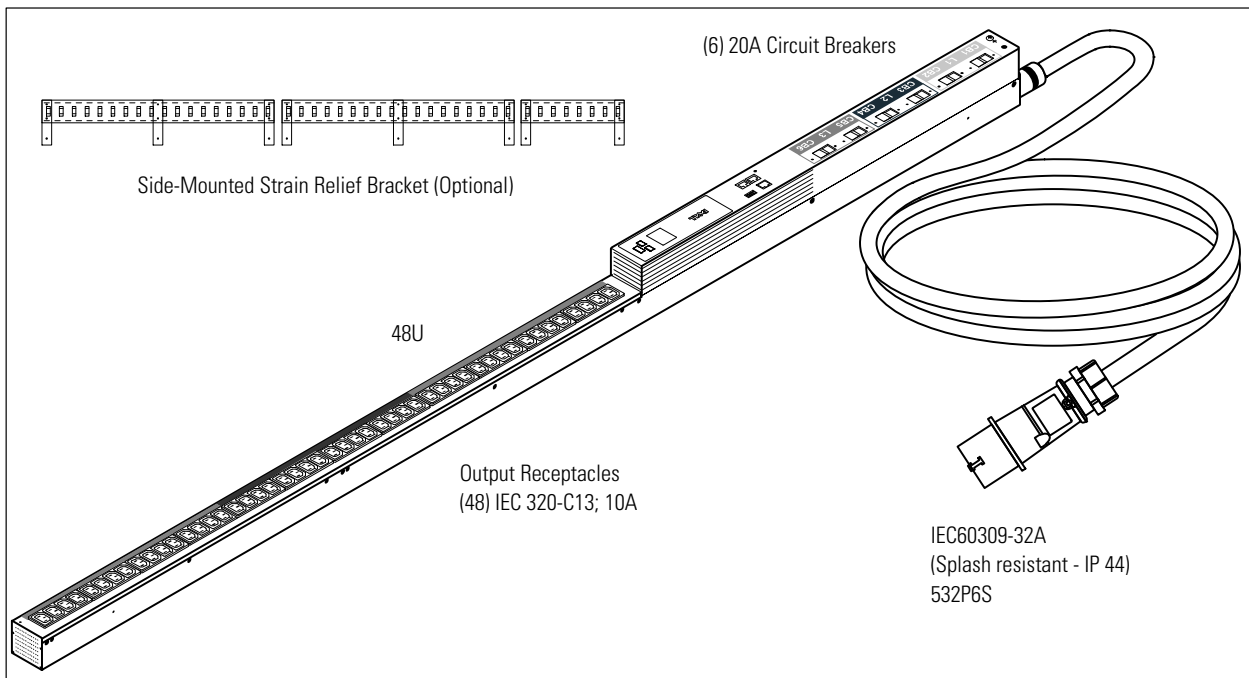
**Figure 14. DELLM0004 and DELLM004A**



**Figure 15. DELLM0005**



**Figure 16. DELLM0006**

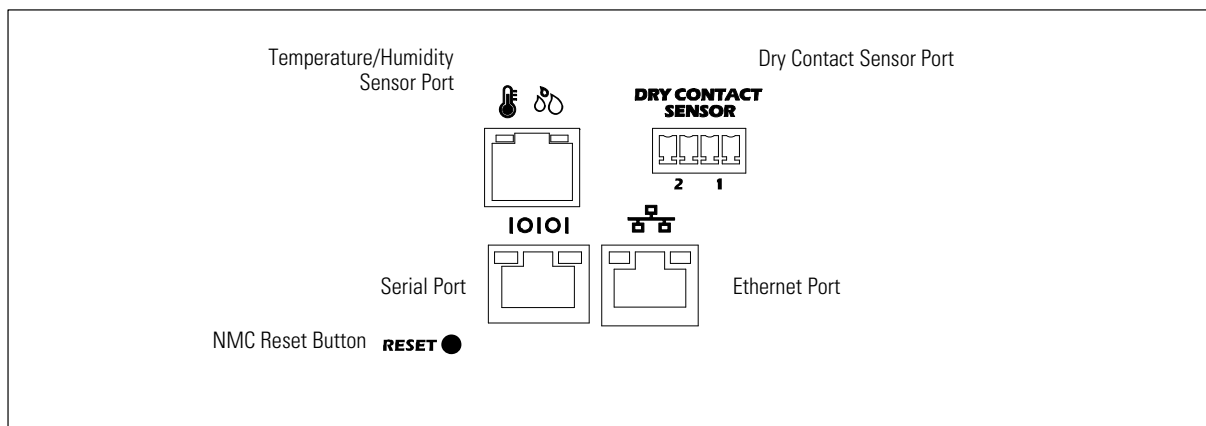


**Figure 17. DELLM0007**

## External Signaling Ports

Two types of external signaling ports are provided on the rPDU front panel (see Figure 18):

- Communication ports
- Monitoring ports




**Figure 18. Communication and Environmental Ports**

### Communication Ports

The rPDU provides both a serial and an Ethernet (10/100 Base-T) communication port for external controls. These communication ports are used to access external controls for upgrading, monitoring, or managing the rPDU.

Firmware upgrades (flash upgrades) update the rPDU firmware and the internal Dell Network Management Card (NMC). Upgrades can be performed either using a command line interface (CLI) upgrade utility or a Web-based graphical user interface.

 **NOTE:** The RESET button on the front panel resets the internal NMC.

Flash upgrades are transparent and do not affect rPDU operation. However, the front panel buttons and LCD operation are disabled during the upgrade. Unique model identification information prevents an incorrect firmware load from being installed on an rPDU during a flash upgrade.

During the flash upgrade, the LCD provides a “Flash Update In Process” message and provides a progress bar. If the upgrade is interrupted, recovery processes allow the upgrade to restart. If the upgrade fails, the LCD displays a “Flash Error” message and the backlight changes to amber text with a dark red background.

The rPDUs can be monitored and settings modified using a graphical Web interface. The settings correspond to the Settings menu (see Settings menu on page 43). This requires a PC connected through the Ethernet port.


## Serial Port

The serial port provides RS-232 serial communication between the rPDUs and a computer using an RJ-45 to DB-9 serial cable (supplied). Use the serial port to connect to a PC and perform the following using a CLI:

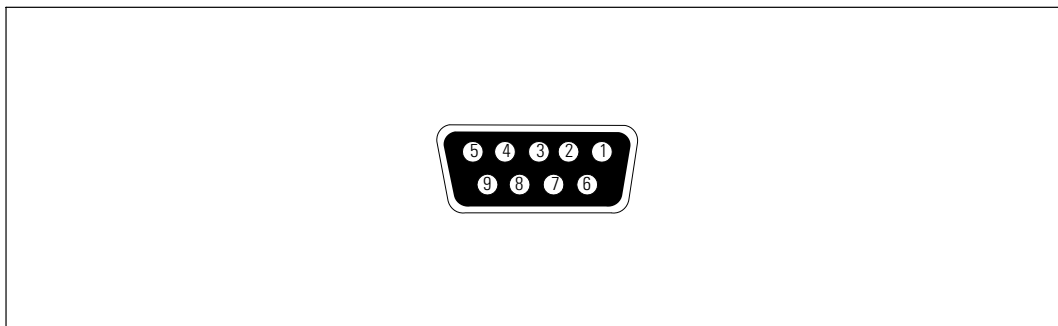
- Configure the internal NMC at startup
- Upgrade the internal NMC and rPDU firmware using a flash update utility program
- Connect to a Dell KVM that supports rPDU communication

To create a serial connection between the rPDU and a PC:

- 1 Locate the RJ-45 to DB-9 serial cable provided in the accessory bag.
- 2 Connect the RJ-45 serial cable connector to the rPDU serial communication port (see Figure 18).
- 3 Connect the serial cable console connector to the RS-232 serial connection port (COM port) on the PC.

 **NOTE:** Use HyperTerminal® or an equivalent terminal emulation application for the CLI.

The cable pins for the RS-232 serial connection (DB-9 female connector) are identified in Figure 19.



**Figure 19. DB-9 Female Connector**

Table 2 provides RS-232 serial connector port pin assignments.

**Table 2. Serial Communication RS-232 Port Pin Assignment**

Pin	Signal Name	Function	Direction from the rPDU
1		Unused	—
2	RXD	Receive Data	In
3	TXD	Transmit Data	Out
4		Unused	—
5	GND	Ground	—
6		Unused	—
7		Unused	—
8		Unused	—
9		Unused	—


 **NOTE:** Unused pins must be left free on all models. The pins labeled “Unused” are not to be pulled high or tied to ground.

Table 3 provides RJ-45 serial connector port pin assignments.

**Table 3. Serial Communication RJ-45 Port Pin Assignment**


Pin	Signal Name	Function	Direction from the rPDU
1		Unused	—
2		Unused	—
3		Unused	—
4	RXD	Receive Data	In
5	TXD	Transmit Data	Out
6	GND	Ground	—
7		Unused	—
8		Unused	—

## Ethernet Port

The rPDU provides an Ethernet (10/100 Base-T) port connection in order to use the internal NMC to monitor and manage rPDUs.

The rPDU defaults to using DHCP when delivered. If you are unable to connect to the rPDU through the network connection with this default address, change the IP address using the serial interface before using any of the network interfaces. See “Serial Interface Operation” on page 50 for more information.

Once connected, you can access the graphical Web interface over the network and verify that the rPDU's internal NMC is operational and recognized by the Web interface so the rPDU can be monitored and managed.

 **NOTE:** The rPDU is defaulted to use DHCP, but additional NMC configuration can be done through the serial connection using a CLI.

To create an Ethernet connection between the rPDU and the network:


- 1 Locate the Ethernet cable to use for this network connection (not provided).
- 2 Ensure the network cable is connected to the network server or router connection.
- 3 Connect the Ethernet cable to the Ethernet connection port on the rPDU (see Figure 18).

## Monitoring Ports

Monitoring ports are used to collect readings from connected sensors. There are two types of environmental monitoring device (EMD) ports on the rPDU. One port is provided for a either a temperature-only or a combined temperature and humidity sensor. A dry contact sensor port is also provided.

### Temperature and Humidity Sensor (Optional)

Temperature-only or combined temperature and humidity sensors provide readings of the ambient conditions where the sensor is installed. If a temperature or humidity reading crosses the high or low threshold setting, an alarm displays in the LCD. (See the Settings menu on page 43.) If the sensor is not installed, or not connected to the rPDU, the LCD displays dashes.


 **NOTE:** An environment alarm does not affect rPDU system operation. The alarm only reports an environmental condition.

Install and set up the sensor as instructed in the installation documentation on [www.dell.com](http://www.dell.com). Connect the appropriate end of the temperature-only or combined temperature and humidity sensor cable to the temperature/humidity sensor port on the rPDU (see Figure 18).

 **NOTE:** Temperature readings are measured in Kelvin (K), then converted and reported as °C on the LCD panel.

### **Dry Contact Sensor (Optional)**

Two dry contacts on the front panel can be configured as either normally open or normally closed when dry contacts are installed. When configured as normally open, the dry contact becomes active when the pins are shorted. When configured as normally closed, the dry contact becomes active when the pins are open. (See the Settings menu on page 43.)


 **NOTE:** When the dry contact is active, an alarm displays. The alarm is cleared by restoring the hardware connection to the state before the dry contact became active.

Install and set up the dry contact sensor as instructed in the installation documentation on [www.dell.com](http://www.dell.com). Connect the dry contact sensor to the appropriate port on the rPDU (see Figure 18).

## LCD Operation

This chapter contains information on how to use the Dell Metered Rack Power Distribution Unit (rPDU), including:

- LCD panel and control button functions
- Menu selections

 **NOTE:** The LCD panel language is not configurable. Only English is provided.

### LCD Panel and Control Buttons

The rPDU has a three-button, graphical LCD panel (see Figure 20). Use the control buttons to change the screen display and retrieve specific performance data or change configuration values.

The display view can also change automatically. For example, the display changes to show active alarms as they occur, or particular displays update due to a change in operating state.

Inactivity can cause a screen change as well. For example, the display returns to the rPDU Input Status screen automatically when no button has been pressed for 15 min.



**Figure 20. LCD Panel**

Table 4 describes the elements that comprise the LCD panel.

**Table 4. LCD Panel Elements**




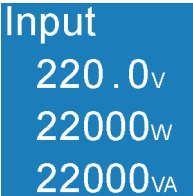






LCD Panel Element	Description
	Scroll up to go back to previous options or menu levels
	Selects a menu or option
	Scroll down to see the next option or menu level
	A standard backlight is continually lit so the white text and a blue background is clearly visible.
	When an rPDU alarm is active, the text changes to amber and the backlight becomes dark.

Table 5 describes the LCD control button functions.


**Table 5. LCD Control Button Functions**

Control Button	Operator Action	Response
	Press for less than one second	Scroll up, moving back to the previous menu.
	Press for longer than one second	Return/exit back one menu layer without initiating a command or changing a setting.
	Press for less than one second	Select the menu or option to be changed.
	Press for longer than one second	Save the setting being edited.
	Press for less than one second	Scroll down, moving forward to the next menu option.

 **NOTE:** The display automatically returns to the Input Status screen when no button has been pressed for 15 minutes and no other screen has been locked by a user. To return to the Main Menu, press any control button.



## Locking a Screen

To lock a screen, press the  button. The screen view stays locked and does not automatically return to the default screen after time-out. When the screen is locked, the image of a key appears at the top of locked screen.

Pressing any control button unlocks the screen, removes the lock symbol, and returns the normal control button functions to the operator (see Figure 21).

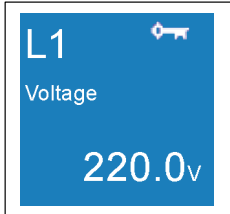



Figure 21. Locked Screen

## Automatic Alarm Notification

When an alarm occurs, the LCD display automatically changes to the active alarm display except under the following circumstances:

- Screen lock is activated
- You are in the Settings menu
- You selected a control button in the last five seconds

 **NOTE:** An active alarm is presented as amber text on a dark background to distinguish it from the standard LCD display.

## Input Status Screen

Five seconds after rPDU startup, the Input Status screen automatically replaces the Dell startup screen. The Input Status screen provides a summary of rPDU input measurements (see Figure 22).

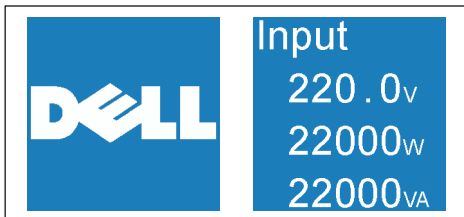


Figure 22. Dell Startup and Input Status Screens

Table 6 describes the values on the Input Status screen display.

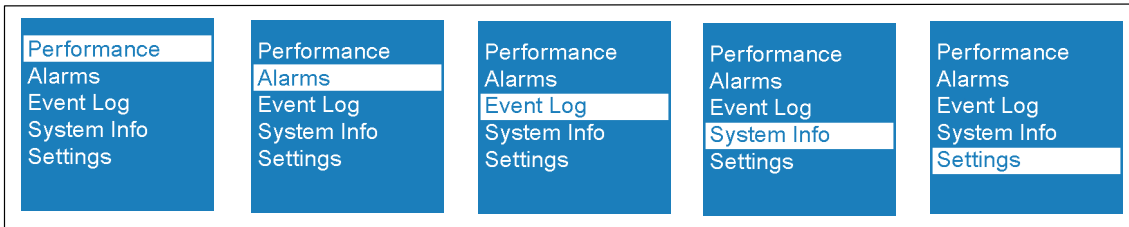
**Table 6. Input Status Screen**

Status	Description
<b>Input Voltage (V)</b>	Present average of the total input voltage for all three rPDU phases, reported in Volts (V). <b>NOTE:</b> If any phase fails to report voltage, the voltage for the remaining phases is averaged.
<b>Input Wattage (W)</b>	Calculated value of the overall input wattage of the rPDU, reported in Watts (W). This is also called active power.
<b>Input Volt-amperes (VA)</b>	Calculated value of the overall input volt-amperes (VA) of the rPDU. This is also called apparent power.

## Main Menu Selections

The rPDU menu selection hierarchy provides useful performance information, alarms, events, identification, and configuration settings.

Make a selection from the rPDU Main Menu to retrieve performance monitoring data, review operation log information, retrieve system identification information, or enter a configuration settings (see Figure 23).



**Figure 23. Main Menu Selections**

Table 7 provides descriptions of Main Menu selections.

**Table 7. Main Menu Selections**

Main Menu	Description
<b>Performance</b>	Selections on the Performance Menu display data that represent the real-time operating status of the system. <ul style="list-style-type: none"><li>• The L1, L2, or L3 submenus provide voltage, frequency, or current data for each phase.</li><li>• The Power submenu provides present readings for power (VA) and wattage (W) data.</li><li>• The Environment menu displays present temperature and humidity readings (if sensors are installed and connected).</li></ul>
<b>Alarms</b>	Alarm screens are only visible when alarms are active. Selecting the Alarm menu displays the message “No active alarm” if no alarms are active.
<b>Event Log</b>	Scroll through the Event Log to review the most recent events (50 events maximum). <b>NOTE:</b> Events do not automatically display when they occur the way alarms display. Events are shown only in the event log.
<b>System Info</b>	The System Info menu provides rPDU identification information, such as model serial number and firmware version identification.
<b>Settings</b>	The Settings menu provides configuration options for customizing performance monitoring thresholds and configuring the user interface.

**NOTE:** For Delta models, L1 represents L1-L3 data, L2 represents L1-L2 data, and L3 represents L2-L3 data.

## Selecting a Menu


To select a menu:

- 1 From the Main menu, use the **▲** or **▼** button to navigate to any menu.
- 2 Press and release the **■** button to select the menu.
- 3 To exit any menu screen and return to the previous menu level, press the **▲** button for longer than one second.

## Performance Menu

Selections on the Performance menu display data that represents the real-time operating status of the system. The Performance menu contains the following submenus:

- The L1, L2, or L3 menus provide voltage, current, and frequency data for each phase.
- The Power menu provides present readings for power (VA) and wattage (W) data.
- The Environment menu displays the present temperature (°C) and humidity (%) readings (if sensors are installed and connected).

 **NOTE:** For Delta models, L1 represents L1-L3 data, L2 represents L1-L2 data, and L3 represents L2-L3 data.

## Retrieving Performance Information

To select an option and retrieve rPDU performance information:

- 1 From the Main menu, use the **▲** or **▼** buttons to navigate to the Performance menu.
  - 2 Press and release the **■** button to select the Performance menu.
  - 3 Use the **▲** or **▼** buttons to navigate to a submenu.
  - 4 Press and release the **■** button to select the submenu.
  - 5 Use the **▲** or **▼** buttons to toggle the available options within a submenu.
- NOTE:** When scrolling through the selections, the up-to-date data displays for each selection.
- 6 To exit any screen and return to the previous menu level, press the **▲** button for longer than one second.

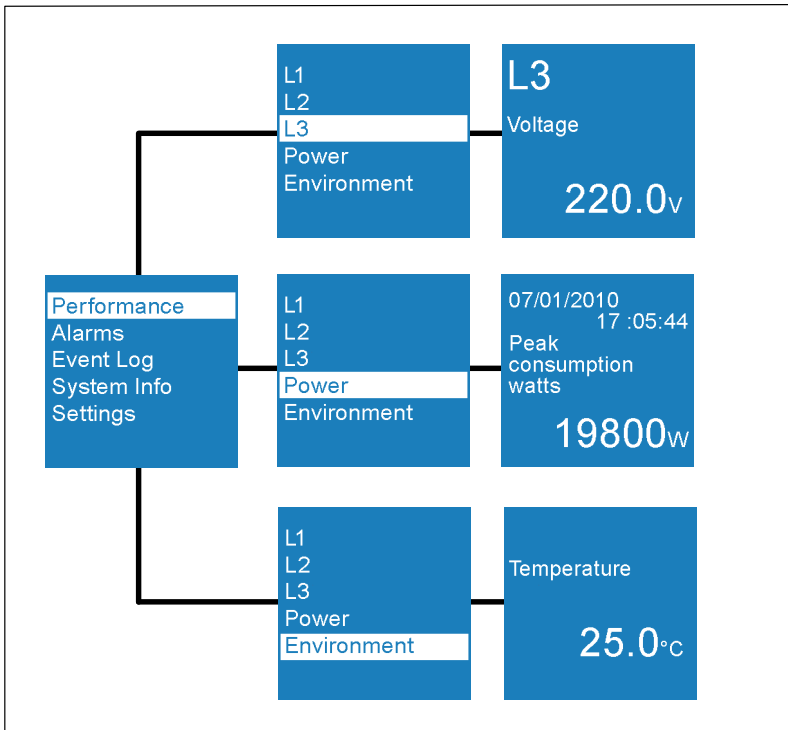


Figure 24. Example Performance Displays

Table 8 provides descriptions of Performance menu selections.

**Table 8. Performance Menu Selections**

<b>Performance Submenu</b>	<b>Option</b>	<b>Description</b>
<b>L1 Menu</b>	<b>L1 Voltage</b>	Present voltage reading for phase 1 (L1), displayed in Volts (V)
	<b>L1 Frequency</b>	Present frequency reading for phase 1 (L1), displayed in Hertz (Hz)
	<b>L1 Current</b>	Present current reading for phase 1 (L1), displayed in Amps (A)
<b>L2 Menu</b>	<b>L2 Voltage</b>	Present voltage reading for phase 2 (L2), displayed in Volts (V)
	<b>L2 Frequency</b>	Present frequency reading for phase 2 (L2), displayed in Hertz (Hz)
	<b>L2 Current</b>	Present current reading for phase 2 (L2), displayed in Amps (A)
<b>L3 Menu</b>	<b>L3 Voltage</b>	Present voltage reading for phase 3 (L3), displayed in Volts (V)
	<b>L3 Frequency</b>	Present frequency reading for phase 3 (L3), displayed in Hertz (Hz)
	<b>L3 Current</b>	Present current reading for phase 3 (L3), displayed in Amps (A)

NOTE: For Delta models, L1 represents L1-L3 data, L2 represents L1-L2 data, and L3 represents L2-L3 data.

**Table 8. Performance Menu Selections (Fortsetzung)**

<b>Performance Submenu</b>	<b>Option</b>	<b>Description</b>
<b>Power</b>	<b>Active Power</b>	Provides the calculated value of the overall input, displayed in watts (W)
	<b>Apparent Power</b>	Provides the calculated value of the overall input, displayed in Volt-amperes (VA)
	<b>Instantaneous Headroom Watts</b>	Provides the watts capacity remaining <b>NOTE:</b> When the rPDU is in an overload state, this value is always 0.
	<b>Peak Headroom Watts</b>	Provides the remaining watts available to support the load at peak demand
	<b>Peak Consumption Watts</b>	Provides the peak power demand on the rPDU with time and date stamp of the most recent data update
	<b>Cumulative kWh Consumption</b>	Provides the total kWh usage with time and date stamp of the most recent data update <b>NOTE:</b> This value accumulates. If this value reaches the maximum value for a 32-bit number, do not reset.
<b>Environment</b>	<b>No sensors connected</b>	Displays dashes on both Temperature and Humidity screens.
	<b>Only Temperature sensor connected</b>	Displays the temperature in °C on the Temperature screen. Displays dashes on the Humidity screen.
	<b>Temperature and Humidity sensors connected</b>	Displays the temperature in °C on the Temperature screen. Displays the humidity percentage on the Humidity screen.

## Measured and Calculated Meters

The rPDU operating status information provided by the Performance menu selections is derived from a series of measured and calculated meters. See Table 9 for descriptions of measured and calculated meters.

**Table 9. Measured and Calculated Meters**

<b>Meter</b>	<b>Unit</b>	<b>Description</b>
Input Voltage	Volts (V)	Present voltage measured at the 3 $\phi$ input of the rPDU
Input Frequency	Hertz (Hz)	Present frequency measured at the input of the rPDU
Input Current	Amps (A)	Present current measured at 3 $\phi$ input of the rPDU
Input Watts	Watts (W)	Calculated value of the overall input W of the rPDU (active power)
Input Volt-amperes	Volt-amperes (VA)	Calculated value of the overall input VA of the rPDU (apparent power)
Instantaneous Headroom Watts	Watts (W)	Present W capacity remaining for the rPDU <b>NOTE:</b> This value is an absolute value calculated from the W rating of rPDU deducted from the W being consumed.
Peak Headroom Watts (with time stamp)	Watts (W)	Remaining W available to support the load at peak demand <b>NOTE:</b> This value is based on the lowest value set for that Instantaneous Headroom Watts. The value can be reset from the LCD or the internal Dell Network Management Card (NMC).


**Table 9. Measured and Calculated Meters (Fortsetzung)**

Meter	Unit	Description
Peak Consumption Watts (with time stamp)	Watts (W)	Peak power demand on the rPDU with time and date stamp of the most recent data update
Cumulative Kilowatt per hour (with time stamp)	Kilowatt per hour (kWh)	Total kWh usage <b>NOTE:</b> This 32-bit meter value is derived by retrieving the current kWh consumption meter once each hour and adding it to the previous value. This value accumulates until it is reset from the LCD or network interface card.
Temperature	Kelvin (K)	Two high temperature thresholds from an environmental thermal-only or thermal and humidity sensor, measured in K and reported as °C
Humidity	Percent (%)	Two low humidity thresholds reported from an environmental thermal and humidity sensor, reported as a percentage (%)
Real Time Clock	MM/DD/YYYY	Current time and date reading from the network interface card real-time clock

## Alarms Menu


Selecting the Alarms menu allows you to review all active alarms in the order of occurrence. If there are no active notices or alarms, a “No Active Alarm” message appears (see Figure 25).

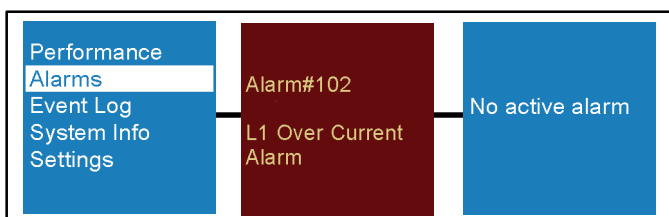
In addition to displaying in the Alarms menu alarms and notices are logged in the Event Log.

 **NOTE:** Events are not shown in rPDU alarm status screens. Events appear only in the Event Log.

### Retrieving Active Alarms


To retrieve active alarms:

- 1 From the Main menu, use the **▲** or **▼** buttons to navigate to the Alarms menu.
- 2 Press and release the  button to select the Alarms menu.
- 3 Use the **▲** or **▼** buttons to navigate forward or back to review the active alarms.
- 4 To exit any screen and return to the previous menu level, press the **▲** button for longer than one second.



**Figure 25. Example Alarms Menu Display**

Table 10 provides descriptions of status alarms, notices, and events.

 **NOTE:** For Delta models, L1 represents L1-L3 data, L2 represents L1-L2 data, and L3 represents L2-L3 data.

**Table 10. Alarms , Notices, and Events**

<b>Name</b>	<b>Description</b>	<b>Type</b>
L1 Over Current Warning	The Phase 1 input current amperage (A) reading is greater than the value configured as the over current warning threshold. This warning indicates that the current A reading is approaching the value set for the over current alarm.  Generates an alarm and is logged in the Event Log.	Notice
L2 Over Current Warning	The Phase 2 input current amperage (A) reading is greater than the value configured as the over current warning threshold. This warning indicates that the current A reading is approaching the value set for the over current alarm.  Generates an alarm and is logged in the Event Log.	Notice
L3 Over Current Warning	The Phase 3 input current amperage (A) reading is greater than the value configured as the over current warning threshold. This warning indicates that the current A reading is approaching the value set for the over current alarm.  Generates an alarm and is logged in the Event Log.	Notice
L1 Over Current Alarm	The Phase 1 input current amperage (A) reading is greater than the value configured as the over current alarm threshold.  Generates an alarm and is logged in the Event Log.	Alarm
L2 Over Current Alarm	The Phase 2 input current amperage (A) reading is greater than the value configured as the over current alarm threshold.  Generates an alarm and is logged in the Event Log.	Alarm
L3 Over Current Alarm	The Phase 3 input current amperage (A) reading is greater than the value configured as the over current alarm threshold.  Generates an alarm and is logged in the Event Log.	Alarm
L1 Low Current Warning	The Phase 1 input current amperage (A) reading is less than the value configured as the low current warning threshold. This warning indicates that the current A reading is approaching the value set for the low current alarm.  Generates an alarm and is logged in the Event Log.	Notice
L2 Low Current Warning	The Phase 2 input current amperage (A) reading is less than the value configured as the low current warning threshold. This warning indicates that the current A reading is approaching the value set for the low current alarm.  Generates an alarm and is logged in the Event Log.	Notice
L3 Low Current Warning	The Phase 3 input current amperage (A) reading is less than the value configured as the low current warning threshold. This warning indicates that the current A reading is approaching the value set for the low current alarm.  Generates an alarm and is logged in the Event Log.	Notice



**Table 10. Alarms , Notices, and Events (Fortsetzung)**

<b>Name</b>	<b>Description</b>	<b>Type</b>
Overload Warning	The total watts (W) reading for all three phases is greater than the value configured as the overload warning threshold. This warning indicates that the current W reading is approaching the value set for the overload alarm. Generates an alarm and is logged in the Event Log.	Notice
Overload Alarm	The total watts (W) reading for all three phases is greater than the value configured as the overload alarm threshold. Generates an alarm and is logged in the Event Log.	Alarm
Low Load Warning	The total watts (W) reading for all three phases is less than the value configured as the low load warning threshold. This warning indicates that the W reading is approaching the value set for the low load alarm. Generates an alarm and is logged in the Event Log.	Notice
Over Temperature Alarm	The temperature level reading is greater than the maximum temperature threshold value. This alarm clears when the temperature drops 5°C below the Temperature High Alarm Level value setting. Generates an alarm and is logged in the Event Log.	Alarm
Over Temperature Warning	The temperature level reading is greater than the warning temperature threshold value. This alarm clears when the temperature drops 5°C below the Temperature High Warning Level value setting. Generates an alarm and is logged in the Event Log.	Notice
Low Humidity Warning	The humidity level reading is less than the value configured as the warning humidity threshold. This alarm clears when the humidity rises 5% above the Humidity Low Warning Level value setting. Generates an alarm and is logged in the Event Log.	Notice
Low Humidity Alarm	The humidity level reading is less than the minimum humidity threshold. This alarm clears when the humidity rises 5% above the Humidity Low Alarm Level value setting. Generates an alarm and is logged in the Event Log.	Alarm
Contact 1 Active	The signal for Dry Contact 1 is active. Generates an alarm and is logged in the Event Log.	Alarm
Contact 2 Active	The signal for Dry Contact 2 is active. Generates an alarm and is logged in the Event Log.	Alarm
Meter IC Fault	Communication is lost. Generates an alarm and is logged in the Event Log.	Alarm

**Table 10. Alarms , Notices, and Events (Fortsetzung)**

Name	Description	Type
Fatal EEPROM Fault	This alarm occurs when the EEPROM experiences a Range Check Failure alarm, an incorrect EEPROM model map alarm, or an EEPROM Checksum Failure alarm. Generates an alarm and is logged in the Event Log.	Alarm
PDU Control Power ON	The rPDU processor is powered on. Logged in the Event Log only.	Event

## Event Log

The Event Log holds up to 50 alarms, events, and most notices. They are logged when they occur. You can scroll through the event screens, beginning with the most recent event.

The first row of each event screen contains the date (MM/DD/YYYY) and time (hh:mm:ss) at which the event occurred. The second row contains the type of event and code. The event description begins on the third row and may continue to the fourth row.

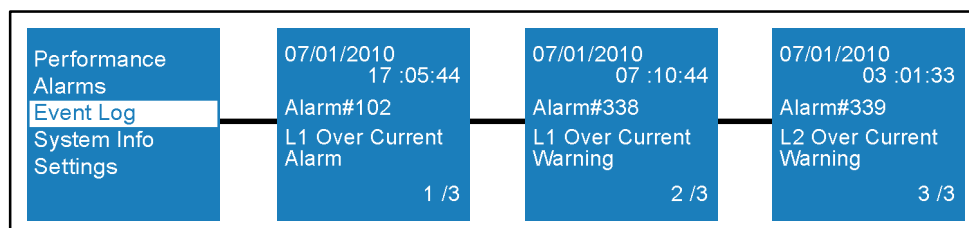
The bottom right corner of the event screen displays two numbers—an ordering number of the event in the log, followed by the total number of events in the log.

If there are no events in the log, the screen displays “No events in log.”

### Retrieving the Event Log

To retrieve the logged events:

- 1 From the Main menu, use the **▲** or **▼** buttons to navigate to the Events Log menu.
- 2 Press the **■** button for longer than one second to see the logged events.
- 3 Use the **▲** or **▼** buttons to navigate forward or back to review the events, notices, and alarms in the order they occurred.
- 4 To exit any screen and return to the previous menu level, press the **▲** button for longer than one second.



**Figure 26. Example Event Log Displays**

## System Info

The System Info menu screens display the following rPDU identification information:

- Type and model
- rPDU part number
- Serial number
- NMC firmware version
- NMC IP address
- NMC MAC address
- rPDU firmware

### Retrieving System Identification Information

To retrieve rPDU system identification information:

- 1 From the Main menu, use the **▲** or **▼** buttons to navigate to the System Info menu.
- 2 Press and release the **■** button to select the System Info menu.
- 3 Use the **▲** or **▼** buttons to toggle the available options within the menu.
- 4 To exit any screen and return to the previous menu level, press the **▲** button for longer than one second.

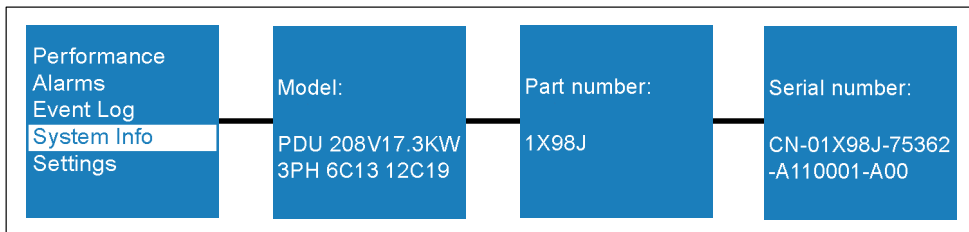


Figure 27. Example Identification Displays

## Settings

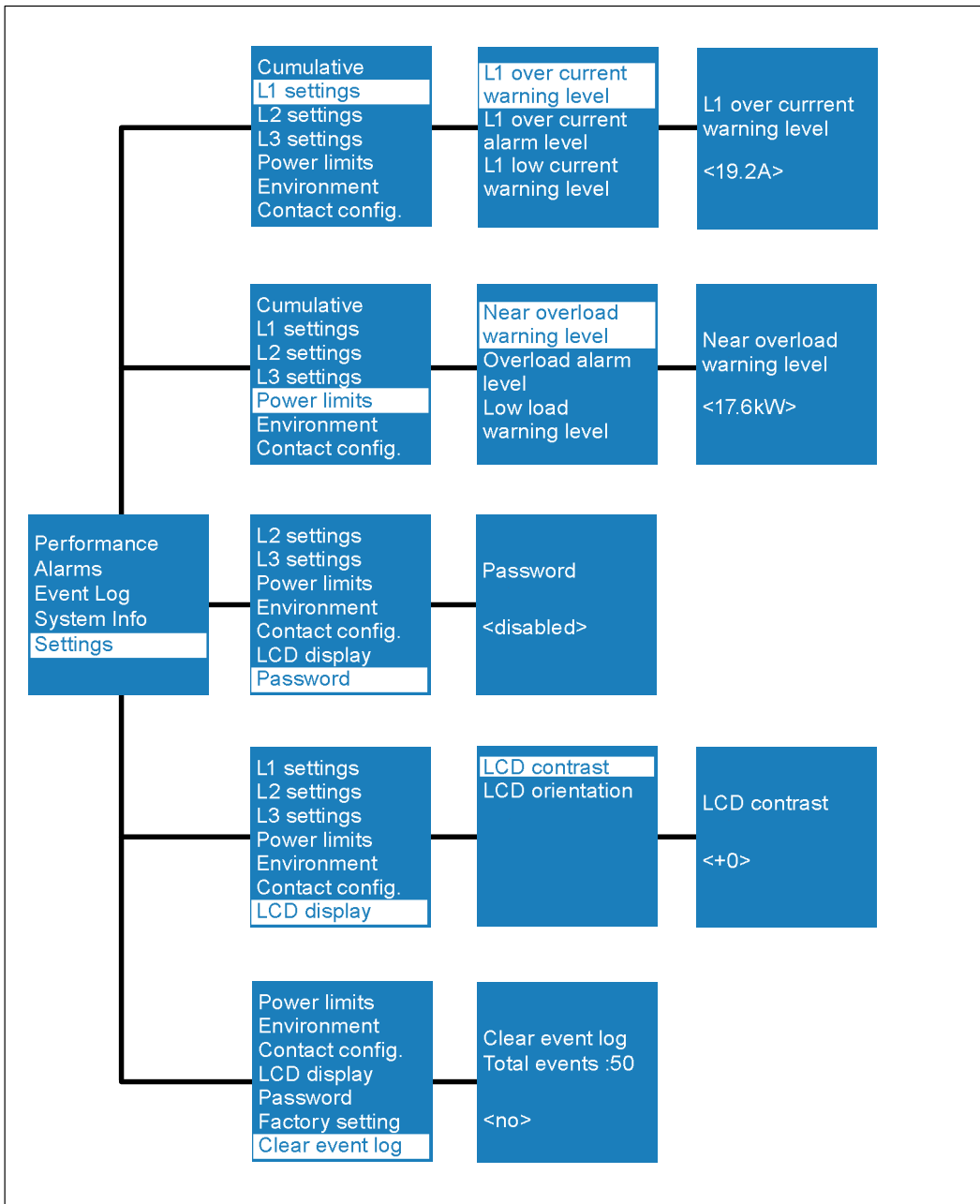
The Settings menu provides user configuration options (see Figure 28). Only the available options display.

**NOTE:** User settings are not protected by default. You can enable the password through the Password setting.

### Retrieving or Changing Configuration Settings in the Settings Menu

- 1 From the Main menu, use the **▲** or **▼** buttons to navigate to the Settings menu.
  - 2 Press and release the **■** button to select the Settings menu.
  - 3 Use the **▲** or **▼** buttons to navigate to a submenu.
  - 4 Press and release the **■** button to select the submenu.
  - 5 Use the **▲** or **▼** buttons to toggle the available configuration options within a submenu.
- NOTE:** When scrolling through the selections, the present setting displays for each selection.
- 6 Press and release the **■** button to select the configuration option you want to change.

- 7 Use the **▲** or **▼** buttons to toggle to the value you want to set.
- 8 Set a new value by pressing the **●** button again for longer than one second.
- 9 To exit any screen and return to the previous menu level, press the **▲** button for longer than one second.



**Figure 28. Example Settings Displays**

Table 11 provides descriptions of Settings menu selections.

**Table 11. Settings**

<b>Settings Submenu</b>	<b>Setting Option</b>	<b>Available Settings</b>	<b>Default Setting</b>
<b>Cumulative</b>	Reset Peak Watts	[No] [Yes] If No, no action. If Yes, the Peak Consumption Watts value is cleared and the date and time stamp for this statistic is set to the present date and time.	No
	Reset Peak Headroom Watts	[No] [Yes] If No, no action. If Yes, the Peak Headroom Watts value is cleared and the date and time stamp for this statistic is set to the present date and time.	No
	Reset Cumulative kWh	[No] [Yes] If No, no action. If Yes, the Cumulative Consumption kWh value is cleared and the date and time stamp for this statistic is set to the present date and time.	No
<b>L1 Settings</b>	L1 Over Current Warning Level	[0.0A]...[48.0A] *	38.4A
		[0.0A]...[32.0A] **	25.6A
		[0.0A]...[16.0A] ***	12.8A
	An input current amperage (A) reading greater than this value causes a warning to generate. This warning indicates that the current A reading has risen to an unacceptable level.		
	L1 Over Current Alarm Level	[0.0A]...[48.0A] *	48.0A
		[0.0A]...[32.0A] **	32.0A
[0.0A]...[16.0A] ***		16.0A	
An input current amperage (A) reading greater than this value causes an over current alarm to generate.			
L1 Low Current Warning Level	[0.0A]...[48.0A] *	0.0A	
	[0.0A]...[32.0A] **	0.0A	
	[0.0A]...[16.0A] ***	0.0A	
An input current amperage (A) reading less than this value causes a warning to generate. This warning indicates that the current A reading is reduced to an unacceptable level.			

\* DELLM0001, DELLM001A, DELLM0004, DELLM004A, DELLM0006

\*\* DELLM0002, DELLM0005, DELLM0007

\*\*\* DELLM0003

NOTE: For Delta models, L1 represents L1-L3 data, L2 represents L1-L2 data, and L3 represents L2-L3 data.

**Table 11. Settings (Continued)**

<b>Settings Submenu</b>	<b>Setting Option</b>	<b>Available Settings</b>	<b>Default Setting</b>	
<b>L2 Settings</b>	L2 Over Current Warning Level	[0.0A]...[48.0A] *	38.4A	
		[0.0A]...[32.0A] **	25.6A	
		[0.0A]...[16.0A] ***	12.8A	
	An input current amperage (A) reading greater than this value causes a warning to generate. This warning indicates that the current A reading has risen to an unacceptable level.			
	L2 Over Current Alarm Level	[0.0A]...[48.0A] *	48.0A	
		[0.0A]...[32.0A] **	32.0A	
		[0.0A]...[16.0A] ***	16.0A	
	An input current amperage (A) reading greater than this value causes a over current alarm to generate.			
	L2 Low Current Warning Level	[0.0A]...[48.0A] *	0.0A	
[0.0A]...[32.0A] **		0.0A		
[0.0A]...[16.0A] ***		0.0A		
An input current amperage (A) reading less than this value causes a warning to generate. This warning indicates that the current A reading is reduced to an unacceptable level.				
<b>L3 Settings</b>	L3 Over Current Warning Level	[0.0A]...[48.0A] *	38.4A	
		[0.0A]...[32.0A] **	25.6A	
		[0.0A]...[16.0A] ***	12.8A	
	An input current amperage (A) reading greater than this value causes a warning to generate. This warning indicates that the current A reading has risen to an unacceptable level.			
	L3 Over Current Alarm Level	[0.0A]...[48.0A] *	48.0A	
		[0.0A]...[32.0A] **	32.0A	
		[0.0A]...[16.0A] ***	16.0A	
	An input current amperage (A) reading greater than this value causes an over current alarm to generate.			
	L3 Low Current Warning Level	[0.0A]...[48.0A] *	0.0A	
[0.0A]...[32.0A] **		0.0A		
[0.0A]...[16.0A] ***		0.0A		
An input current amperage (A) reading less than this value causes a warning to generate. This warning indicates that the current A reading is reduced to an unacceptable level.				

\* DELLM0001, DELLM001A, DELLM0004, DELLM004A, DELLM0006

\*\* DELLM0002, DELLM0005, DELLM0007

\*\*\* DELLM0003

NOTE: For Delta models, L1 represents L1-L3 data, L2 represents L1-L2 data, and L3 represents L2-L3 data.

**Table 11. Settings (Continued)**

<b>Settings Submenu</b>	<b>Setting Option</b>	<b>Available Settings</b>	<b>Default Setting</b>	
<b>Power Limits</b>	Near Overload Warning Level	[0kW]...[17.3kW] *	13.8kW	
		[0kW]...[22.0kW] **	17.6kW	
		[0kW]...[11.0kW] ***	8.8kW	
			An input wattage (kW) reading in excess of this value causes an overload warning to generate. This warning indicates that the current kW reading has risen nearly to the overload alarm level value.	
	Overload Alarm Level	[0kW]...[17.3kW] *	17.3kW	
		[0kW]...[22.0kW] **	22.0kW	
		[0kW]...[11.0kW] ***	11.0kW	
			An input wattage (kW) reading in excess of this value causes an overload alarm to generate.	
	Low Load Warning Level	[0.0kW]...[17.3kW] *	0.0kW	
[0.0kW]...[22.0kW] **		0.0kW		
[0.0kW]...[11.0kW] ***		0.0kW		
		An input wattage (kW) reading less than this value causes a low load warning to generate as a reminder to share the load for this phase.		
<b>Environments</b>	Temperature High Warning Level	[0 degree C]...[65 degree C]	59 degree C	
		A high temperature warning threshold is exceeded when a value greater than this setting is detected by the environmental temperature sensor. A high temperature warning generates.		
	Temperature High Alarm Level	[0 degree C]...[65 degree C]	60 degree C	
		A high temperature alarm threshold is exceeded when a value greater than this setting is detected by the environmental temperature sensor. A high temperature alarm generates.		
	Humidity Low Warning Level	[0%]...[95%]	10%	
	A low humidity warning threshold is exceeded when a value less than this setting is detected by the environmental humidity sensor. A low humidity warning generates.			
Humidity Low Alarm Level	[0%]...[95%]	0%		
	A low humidity alarm threshold is exceeded when a value less than this setting is detected by the environmental humidity sensor. A low humidity alarm generates.			

\* DELLM0001, DELLM001A, DELLM0004, DELLM004A, DELLM0006

\*\* DELLM0002, DELLM0005, DELLM0007

\*\*\* DELLM0003

NOTE: For Delta models, L1 represents L1-L3 data, L2 represents L1-L2 data, and L3 represents L2-L3 data.

**Table 11. Settings (Continued)**

<b>Settings Submenu</b>	<b>Setting Option</b>	<b>Available Settings</b>	<b>Default Setting</b>
<b>Contact config.</b>	Contact 1	[Normally open], [Normally closed] When set to normally open, the dry contact will be active when the pins are shorted. When set to normally closed, the dry contact will be active when the pins are open.	Normally open
	Contact 2	[Normally open], [Normally closed] When set to normally open, the dry contact will be active when the pins are shorted. When set to normally closed, the dry contact will be active when the pins are open.	Normally open
<b>Password</b>	Password	[Enabled] [Disabled] If Enabled, the default password is USER. and all settings are password-protected. <b>NOTE:</b> If you enter an incorrect password, the message “Incorrect Password” appears. Press any button to return to the password screen and retry the password.	Disabled
<b>Factory setting</b>	Restore Factory Defaults	[No], [Yes] If No, no action. If Yes, all configurable settings are restored to factory default values. <b>NOTE:</b> When you select [Yes] and press the select button, a “Factory setting restored” message displays. You are prompted to “Press any key to continue.”	No
<b>Clear event log</b>	Clear Event Log	[No], [Yes] If No, no action. If Yes, all events in the log are cleared and the Total Events value returns to 0.	No

\* DELLM0001, DELLM001A, DELLM0004, DELLM004A, DELLM0006

\*\* DELLM0002, DELLM0005, DELLM0007

\*\*\* DELLM0003

**NOTE:** For Delta models, L1 represents L1-L3 data, L2 represents L1-L2 data, and L3 represents L2-L3 data.



**Table 11. Settings (Continued)**

<b>Settings Submenu</b>	<b>Setting Option</b>	<b>Available Settings</b>	<b>Default Setting</b>
<b>LCD display</b>	LCD Contrast	[-5], [-4], [-3], [-2], [-1], [+0], [+1], [+2], [+3], [+4], [+5]  The LCD contrast is adjustable from -5 to +5. This range covers the maximum adjustment for contrasting the background with the text in the visual display of the control panel.  <b>NOTE:</b> The contrast on the LCD display screen adjusts immediately as the Up and Down buttons are pressed. Once you reach the optimal contrast, press and hold the Select button for one second to set the new contrast.	[+0]
	LCD Orientation	[0 degree], [180 degree]  The LCD orientation is adjustable to accommodate both horizontal (0 degree setting) and vertical (180 degree setting) views.	[0 degree]

\* DELLM0001, DELLM001A, DELLM0004, DELLM004A, DELLM0006

\*\* DELLM0002, DELLM0005, DELLM0007


\*\*\* DELLM0003

**NOTE:** For Delta models, L1 represents L1-L3 data, L2 represents L1-L2 data, and L3 represents L2-L3 data.

## Serial Interface Operation


This section describes remotely configuring and monitoring a Dell Metered Rack Power Distribution Unit (rPDU) through the serial interface connection between the rPDU internal Dell Network Management Card (NMC) and a laptop or workstation.

Access to a command line interface (CLI) using an Avocent protocol is provided through a terminal emulation program, such as HyperTerminal or Telnet.

 **NOTE:** A terminal emulation program can communicate with another computer or network as if it were a specific type of terminal directly connected to that computer or network.

Once connected, you can perform basic configuration and monitoring tasks for the rPDU to which you are connected, including the following:


- Retrieve selected meters and measurements, including current, present power, temperature, and input voltage
- Set or retrieve rPDU critical alarm high threshold values
- Set or retrieve high temperature warning or alarm threshold values, and low humidity warning or alarm threshold values
- Set or retrieve settings for dry contact sensors connected to the rPDU
- Retrieve selected rPDU equipment, software version, and ratings information
- Reset the rPDU settings to factory defaults or reboot the rPDU


 **NOTE:** The rPDU defaults to using DHCP when delivered. If you are unable to connect to the rPDU through the network connection with this default address, change the IP address using the serial interface before using any of the network interfaces.


## Supported Commands

The rPDU serial interface command set for managing and monitoring the rPDU includes the following commands:

- alarm
- current
- exit
- factory\_defaults
- help
- network
- power
- reboot
- sensors
- temperature
- ver
- voltage

 **NOTE:** Command variables are represented in command input syntax surrounded by angle braces (< >). Constants are represented in command input syntax surrounded by straight brackets ([ ]).

 **NOTE:** You must be logged in to the rPDU before commands can be sent.

 **NOTE:** See Page 56 through Page 64 for descriptions of the serial interface commands, including syntax, query options, and example responses.

## Nomenclature

The serial interface CLI uses a different nomenclature to represent current and voltage readings than the nomenclature that displays on the LCD. Table 12 lists the CLI nomenclature that corresponds to voltages and currents.


**Table 12. Serial Interface Nomenclature**

<b>Voltage Nomenclature</b> <sup>1,2</sup>	<b>Description</b>
<b>XN</b>	L1 Line to Neutral on a Wye-configured rPDU
<b>YN</b>	L2 Line to Neutral on a Wye-configured rPDU
<b>ZN</b>	L3 Line to Neutral on a Wye-configured rPDU
<b>XZ</b>	L1 Phase to Phase on a Delta-configured rPDU
<b>XY</b>	L2 Phase to Phase on a Delta-configured rPDU
<b>YZ</b>	L3 Phase to Phase on a Delta-configured rPDU
<b>Current Nomenclature</b>	<b>Description</b>
<b>X</b>	L1 (Phase 1)
<b>Y</b>	L2 (Phase 2)
<b>Z</b>	L3 (Phase 3)

<sup>1</sup> Line-to-Neutral voltage will not be reported on a Delta-configured rPDU.

<sup>2</sup> Line-to-Line voltage will not be reported on a Wye-configured rPDU.

## Connecting to the Internal rPDU NMC

 **NOTE:** The following instructions describe the procedure to establish and save a serial interface connection to an rPDU using HyperTerminal. The serial interface is supported on Microsoft Windows 2000, XP 2003, Vista Windows, and above.

To set up a connection between the rPDU internal NMC and a computer:


- 1 Verify that the serial cable is correctly connected between the rPDU and your computer.
- 2 Create or open a previously saved connection to the rPDU:  
If you have already created a connection to the rPDU you want to access, go to Step 3.  
If you are creating a new connection, go to Step 5.
- 3 Open a saved connection using one of the following options:

Select **Start > All Programs > Accessories > Communications > HyperTerminal > *saved connection name.ht***.

On the **New Connection** dialog, select **File > Open**. The **Open** dialog displays. In the **File Name** window, select the saved connection file you intend to use. Click **Open**.

- 4 Go to Step 9.
- 5 Open HyperTerminal from the computer **Start** menu:  
Select **Start > All Programs > Accessories > Communications > HyperTerminal**.

The **Connection Description** dialog displays.

 **NOTE:** If the **Connection Description** dialog does not display when the **New connection - Hyper Terminal** window opens, select **File > New Connection** from the **File** menu to open the dialog.



**Figure 29. Create a Serial Connection**

- 6 Enter a name for the connection in the **Name:** field. Select an icon representing the type of connection you will use, then click **OK** (see Figure 29).
- 7 On the **Connect To** dialog, provide the communication details for connecting to the rPDU you intend to remotely configure and monitor (see Figure 30).



**Figure 30. Define Serial Connection**


- 8 On the **Properties** dialog for the port you selected, set the **Port Settings** values from the drop-down lists (see Table 13).

**Table 13. Serial Connection Port Settings**

<b>Port Setting</b>	<b>Value</b>
<b>Baud Rate</b>	9600
<b>Data Bits</b>	8
<b>Parity</b>	None
<b>Stop Bits</b>	1
<b>Flow Control</b>	None

- 9 The HyperTerminal session window opens for the connection you selected. The cursor is poised at the command line to begin your session.
- 10 Continue to one of the following sections to configure the network settings:
  - “Configuring the Network with a DHCP Server” on page 54
  - “Configuring the Network without a DHCP Server” on page 55

## Configuring the Network with a DHCP Server

 **NOTE:** The NMC automatically collects the network configuration settings (IP parameters) from the server by default. When the NMC is not connected to the network, it continuously attempts to connect. When the connection is established, rPDU network configuration settings become available using the CLI.

To configure a network with a DHCP server:

- 1 In the HyperTerminal session window, the default user name (**admin**) displays (see the following example).

```
Username: admin
Password: *****
rPDU>
```

- 2 Type **admin** at the password prompt. Press **Enter**.
- 3 Type **network** and press **Enter**. The Network Settings menu displays.
- 4 Type **2** to select Network Settings and press **Enter**. The Network Settings menu displays (see the following example).


```
-----
----- Network Settings -----
-----
1. Read NetworkSettings
2. Modify Network Settings
3. Set Ethernet Speed
0. Exit
```

Select an option ==> 1


- 5 At the **Select an option** prompt, type **1** and press **Enter**. The network configuration settings display (see the following example).

```
-----
Network configuration
-----
MAC address : 00:22:19:FF:8E:13
Mode : DHCP
IP address : 166.99.224.48
Subnet mask : 255.255.255.0
Gateway : 166.99.224.1
Link Local IPv6 address : FE80::222:19FF:FEFF:8E13 /64
Global IPv6 address : 2001:720:410:100A:222:19FF:FEFF:8E13 /64
Global IPv6 address : 1789:720:410:100A:222:19FF:FFF:8E13 /64
-----
```

- 6 Review the present configuration settings.

 **NOTE:** You should record the IP address that displays to use as a reference.

- 7 Type **0** and press **Enter** to exit.
- 8 Type **0** and press **Enter** again. The network connection to the rPDU internal NMC is configured and the card is operational.
- 9 Network configuration is completed.

 **NOTE:** See Page 56 through Page 64 for an alphabetical command listing of detailed syntax, query options, and example responses.

## Configuring the Network without a DHCP Server

To configure a network without a DHCP server:

- 1 In the HyperTerminal session window, enter **admin** at the User prompt, then enter **admin** at the password prompt.
- 2 Type **2** to select Network Settings and press **Enter**. The Network Settings menu displays (see the following example).

```
-----  
----- Network Settings -----  
-----  
1. Read NetworkSettings  
2. Modify Network Settings  
3. Set Ethernet Speed  
0. Exit
```

Select an option ==> 2

- 3 At the **Select an option** prompt, type **2** to configure the network settings manually and press **Enter**. The screen displays a series of questions (see the following example).

For each of the following questions, you can press <Return> to select the value shown in braces, or you can enter a new value.

Should this target obtain IP settings from the network?[N] N

Static IP address [166.99.1.2]? 166.99.21.21

Static IP address is 166.99.21.21

Subnet Mask IP address [255.255.248.0]? 255.255.255.0

Subnet Mask IP address is 255.255.255.0

Gateway address IP address [166.99.17.1]? 166.99.17.1

Gateway address IP address is 166.99.17.1

Wait while your new configuration is saved.


Reset the card to enable the new configuration.

- 4 Follow the directions to respond to the questions displayed:

**Required.** Enter the static IP parameters (for IPV4 only).

For all other questions displayed, press **Enter** to accept the default value (shown in braces), or enter a new value.

- 5 When **Done** displays, type **0** and press **Enter** to exit.
- 6 Type **1** and press **Enter**, then type **2** and press **Enter** to restart the NMC. The NMC restarts with the new IP settings in approximately one minute.
- 7 Network configuration is completed.

 **NOTE:** See Page 56 through Page 64 for an alphabetical command listing of detailed syntax, query options, and example responses.

## alarm command

Use this command to retrieve critical alarm thresholds for individual phases and a total of all phases. Also use this command to set the critical alarm threshold value for individual phases (L1, L2, and L3) or for a total of all phase lines on the rPDU.

### Usage

```
<rPDU>alarm
<rPDU>alarm [<threshold>]
<rPDU>alarm [<threshold> X|Y|Z]] (for three-phase models)
```

where:

<threshold> = 1 to the maximum current, entered as a whole number, reported as Amperage  
100 to the maximum watt rating, entered as a whole number, reported as wattage  
X = Phase L1  
Y = Phase L2  
Z = Phase L3

### Retrieve the current critical alarm threshold settings for one or all rPDU phase lines

```
<rPDU>alarm
```

#### Example

```
rPDU>alarm
Alarm threshold on rPDU is 2000W
Alarm threshold on rPDU phase X is 24.0A
Alarm threshold on rPDU phase Y is 24.0A
Alarm threshold on rPDU phase Z is 24.0A
```

### Set the threshold for the alarm level of a total of all phases on the rPDU

```
rPDU>alarm [<threshold>]
```



**NOTE:** The threshold value you set should be between 1A and the maximum current on the rPDU, or between 100W and maximum watt rating rPDU. Enter the value as a whole number.

#### Example

```
rPDU>alarm 3000
Setting alarm threshold on rPDU to 3000W
```

### Set the threshold for the alarm level of specific phases on the rPDU (Three-phase rPDUs only)

```
rPDU>alarm [<threshold> X|Y|Z]]
```

#### Example

```
rPDU>alarm 20 X
Setting alarm threshold on rPDU phase X to 20.0A
```



## current command

Use this command to retrieve the present current measurement for each rPDU phase line.

### Usage

```
<rPDU>current
<rPDU>current [summary]
<rPDU>current [X|Y|Z] (for three-phase models)
<rPDU>current threshold [X|Y|Z] (for three-phase models)
```

where:

```
[summary] = Present current measurement
[X|Y|Z]   rPDU phase lines:
           X = Phase L1
           Y = Phase L2
           Z = Phase L3
```

### Retrieve the present current measurement for each rPDU phase line (L1, L2, or L3)

```
rPDU>current
```

#### Example

```
rPDU>current
rPDU: RMS current for phase X: 0.1A.
rPDU: RMS current for phase Y: 0.2A.
rPDU: RMS current for phase Z: 0.1A.
```

### Retrieve a summary of current measurements for each rPDU phase (L1, L2, or L3)

```
rPDU>current [summary]
```

#### Example

```
rPDU>current summary
X:0.1A,0.0A,0.0A,0.0A
Y:0.2A,0.0A,0.0A,0.0A
Z:0.3A,0.0A,0.0A,0.0A
```



**NOTE:** The summary response shows the present current reading as the first value; the other three values (minimum, maximum, and average) will always be reported as zero.

### Retrieve a summary of current measurements for a specific rPDU phase (L1, L2, or L3)

```
rPDU>current [summary] [X|Y|Z]
```

#### Example

```
rPDU>current summary X
X:0.1A,0.0A,0.0A,0.0A
```

### Retrieve the present current measurement for a specific rPDU phase (L1, L2, or L3) (Three-phase rPDUs only)

```
rPDU>current [X|Y|Z]
```

#### Example

```
rPDU>current X
rPDU: RMS current for phase X: 0.1A.
```

### Retrieve the present current threshold for all rPDU phases (L1, L2, or L3)

```
rPDU>current threshold
```

#### Example

```
rPDU>current threshold
rPDU: Threshold Phase X 24.0:18.0:0.0
rPDU: Threshold Phase Y 22.0:17.0:2.0
rPDU: Threshold Phase Z 22.0:17.0:2.0
```

### Retrieve the present current threshold for a specific rPDU phase (L1, L2, or L3) (Three-phase rPDUs only)

```
rPDU>current threshold [X|Y|Z]
```

#### Example

```
rPDU>current threshold X
rPDU: Threshold Phase X 24.0:18.0:0.0
```

## exit command

Use this command to log out and exit the serial interface for the rPDU.

### Usage

```
<rPDU>exit
```

### Log out of the serial CLI

```
rPDU>exit
```

#### Example

```
rPDU>exit
Dell <rPDU model>
Copyright (c) 2010 Dell Corporation
DELL DPI 00.01.0028 August 5, 2010
Username:
```

where:

<rPDU model> = Dell model part number. See Table 14 for valid values.

**Table 14. <rPDU model> Value Descriptions**

<rPDU model> Value	<rPDU model> Descriptions
<b>1X98J</b>	PDU 208V 17.3KW 3PH 6C13 12C19 (DELLM0001)
<b>7P35N</b>	PDU 200V 17.3KW 3PH 6C13 12C19 (DELLM001A)
<b>09FG8</b>	PDU 415V 22KW 3PH 18C13 12C19 (DELLM0002)
<b>4J1C2</b>	PDU 415V 11KW 3PH 21C13 6C19 (DELLM0003)
<b>XX5T6</b>	PDU 208V 17.3KW 3PH 42C13 (DELLM0004)
<b>RXKCH</b>	PDU 200V 17.3KW 3PH 42C13 (DELLM004A)
<b>K5YYY</b>	PDU 415V 22KW 3PH 42C13 (DELLM0005)
<b>2CM2K</b>	PDU 208V 17.3KW 3PH 48C13 (DELLM0006)
<b>C0G4D</b>	PDU 415V 22KW 3PH 48C13 (DELLM0007)

## factory\_defaults command

Use this command to reset the rPDU configuration to the factory defaults.

### Usage

```
<rPDU>factory_defaults
```

### Reset the rPDU configuration to the factory defaults

```
rPDU>factory_defaults
```

### Example

```
rPDU>factory_defaults
Setting configuration to defaults on rPDU.
Saving configuration to flash on rPDU... Done.
```

## help command

Use this command to list all available rPDU CLI commands or receive detailed help on specified commands.

### Usage

```
rPDU>help
rPDU><command> help
```

where:

<command> = alarm, current, exit, factory\_defaults, network, power, reboot, sensors, temperature, voltage, ver

### List all available rPDU CLI commands

```
rPDU>help
```

### Example

```
rPDU>help
Available commands:
alarm          current          exit             factory_defaults
help           network          power            reboot
sensors        temperature      voltage          ver
```

### List detailed help on a specific rPDU CLI command

```
rPDU><command> help
```

### Example

```
rPDU>alarm help
Usage: alarm
       alarm [<threshold>]
       alarm [<threshold> X|Y|Z] (for three-phase models)
Sets the threshold for the alarm level to <threshold> on rPDU
```

<threshold> should be between 1A and the maximum current or 100W and maximum watt rating.

## network command

Use this command to access the serial interface CLI and retrieve or modify network configuration.

### Usage

```
rPDU>network
```

### Access the serial interface CLI to retrieve network configuration

```
rPDU>network
```

### Example

```
----- Network Settings -----  
-----  
1. Read NetworkSettings  
2. Modify Network Settings  
3. Set Ethernet Speed  
0. Exit  
  
Select an option ==> 1  
  
-----  
Network configuration  
-----  
MAC address : 00:22:19:FF:8E:13  
Mode : DHCP  
IP address : 166.99.224.48  
Subnet mask : 255.255.255.0  
Gateway : 166.99.224.1  
Link Local IPv6 address : FE80::222:19FF:FEFF:8E13 /64  
Global IPv6 address : 2001:720:410:100A:222:19FF:FEFF:8E13 /64  
Global IPv6 address : 1789:720:410:100A:222:19FF:FFF:8E13 /64  
-----
```

### Access the serial interface CLI to modify network configuration

```
----- Network Settings -----  
-----  
1. Read NetworkSettings  
2. Modify Network Settings  
3. Set Ethernet Speed  
0. Exit  
  
Select an option ==> 2  
  
For each of the following questions, you can press <Return> to select  
the value shown in braces, or you can enter a new value.  
Should this target obtain IP settings from the network?[N] N  
Static IP address [166.99.1.2]? 166.99.21.21  
Static IP address is 166.99.21.21  
Subnet Mask IP address [255.255.248.0]? 255.255.255.0  
Subnet Mask IP address is 255.255.255.0  
Gateway address IP address [166.99.17.1]? 166.99.17.1  
Gateway address IP address is 166.99.17.1  
Wait while your new configuration is saved.  
Reset the card to enable the new configuration.
```



**NOTE:** You must select 0 to exit and log in again as admin (password admin) to use other serial interface commands.

## power command

Use this command to retrieve or clear the power readings for current consumption and peak consumption watts.

### Usage

```
rPDU>power [reset | summary]
```

where:

[reset]	= Clears the peak consumption watts to zero
[summary]	= Current consumption reading in watts (W), followed by the peak consumption power reading in watts (W), separated by commas

### Retrieve current consumption and peak consumption watts power readings

```
rPDU>power
```

#### Example

```
rPDU>power  
rPDU: Power: 1.0W. Peak Consumption Watts: 2.0W.
```

### Retrieve a summary of current consumption and peak consumption watts power readings

```
rPDU>power [summary]
```

#### Example

```
rPDU>power summary  
rPDU: 1.0W,2.0W,0.0W,0.0W
```



**NOTE:** The summary command response shows the present power as the first parameter and the peak consumption watts as the second parameter. The minimum and average values will always be reported as zero.

### Reset the peak consumption watts power readings to zero

```
rPDU>power [reset]
```

#### Example

```
rPDU>power summary  
rPDU: 1.0W,2.0W,0.0W,0.0W
```

```
rPDU>power reset  
rPDU:Clearing peak consumption watts to zero.
```

## reboot command

Use this command to reboot the rPDU.

### Usage

```
rPDU>reboot
```

### Reboot the rPDU

```
rPDU>reboot
```

#### Examples

```
rPDU>reboot  
Saving configuration to flash on rPDU ... Done ...  
Username:
```

## sensors command

Use this command to retrieve values or set temperature and humidity thresholds for environment monitoring sensors connected to an rPDU.

### Usage

```
rPDU>sensors [name]
rPDU>sensors threshold [[name] [<thresholds>]
```

where:

[name] = Valid identifier for temperature sensor (T1) or humidity sensor (H1)  
<thresholds> = High or low threshold values, entered in whole numbers, separated by a space

### Retrieve present sensor readings for each environment monitoring sensor connected to an rPDU

```
rPDU>sensors
```

#### Example


```
rPDU>sensors
rPDU: temperature on sensor T1: 33.3C.
rPDU: humidity on sensor H1: 50%.
rPDU: dry-contact sensor D1 is opened.
rPDU: dry-contact sensor D2 is opened.
```

### Retrieve present thresholds for all environment monitoring sensors connected to an rPDU

```
rPDU>sensors threshold
```

#### Example

```
rPDU>sensors threshold
rPDU: temperature thresholds on sensor T1: 60.0C:59.0C.
rPDU: humidity thresholds on sensor H1: 10.0%:0.0%.
```


 **NOTE:** The retrieved threshold value displays in a format of high value, then low value, separated by colons.

### Retrieve present thresholds for a specific environment monitoring sensor connected to an rPDU

```
rPDU>sensors threshold [name]
```

#### Example

```
rPDU>sensors threshold T1
rPDU: temperature thresholds on sensor T1: 60.0C:59.0C.
```

 **NOTE:** The retrieved threshold value displays in a format of high value, then low value, separated by colons..

### Set thresholds for a specific environment monitoring sensor connected to an rPDU

```
rPDU>sensors threshold[name] [<thresholds>]
```

 **NOTE:** The threshold values are entered in a format of high value, then low value, separated by a space.

#### Examples

```
rPDU>sensors threshold T1 55 50
rPDU: temperature thresholds on sensor T1: 55.0C:50.0C.
```

```
rPDU>sensors threshold H1 15 5
rPDU: humidity thresholds on sensor H1: 15.0%:5.0%.
```

## temperature command

Use this command to retrieve the present temperature reading from the environmental monitoring sensor.

### Usage

```
rPDU>temperature
```

### Retrieve the present temperature reading from the environmental monitoring sensor

```
rPDU>temperature
```

### Example

```
rPDU>temperature  
rPDU: Temperature: 37.0oC.
```

## ver command

Use this command to retrieve selected equipment, software version, and ratings information for the rPDU.

### Usage

```
rPDU>ver
```

### Retrieve selected rPDU equipment, software version, and ratings information

```
rPDU>ver
```

### Example

```
rPDU>ver  
rPDU: Hw with <30>outlets <96> AMPs max <22000> watts max DELL DPI 00.01.0028  
August 5, 2010 id model <09FG8> [(3 phases) <wye>].
```

where:


<outlets>	= Total number of outlets, regardless of outlet type (see Table 15)
<maxcurrent>	= Maximum current for the rPDU
<watrating>	= Maximum wattage rating for the rPDU
<sw>	= Software version number
<model>	= Dell Part Number (see Table 15)
[(3 phases) <delta wye>]	= For an rPDU with 3-phase output only, Delta or Wye configuration

**Table 15. <model> and <outlets> Value Description**

<model> Values	<model> Descriptions	<outlets> Values
<b>1X98J</b>	PDU 208V 17.3KW 3PH 6C13 12C19 (DELLM0001)	18
<b>7P35N</b>	PDU 200V 17.3KW 3PH 6C13 12C19 (DELLM001A)	18
<b>09FG8</b>	PDU 415V 22KW 3PH 18C13 12C19 (DELLM0002)	30
<b>4J1C2</b>	PDU 415V 11KW 3PH 21C13 6C19 (DELLM0003)	27
<b>XX5T6</b>	PDU 208V 17.3KW 3PH 42C13 (DELLM0004)	42
<b>RXKCH</b>	PDU 200V 17.3KW 3PH 42C13 (DELLM004A)	42
<b>K5YYY</b>	PDU 415V 22KW 3PH 42C13 (DELLM0005)	42
<b>2CM2K</b>	PDU 208V 17.3KW 3PH 48C13 (DELLM0006)	48
<b>C0G4D</b>	PDU 415V 22KW 3PH 48C13 (DELLM0007)	48

## voltage command

Use this command to retrieve the input voltage to the rPDU. The command response is specific to a single rPDU and varies depending on whether the rPDU is a single-phase or three-phase model (see Table 16).

 **NOTE:** Voltage command query options cannot be used for single-phase rPDUs. However, query options can be used with voltage command for three-phase rPDUs.

**Table 16. Phase Line Nomenclature for Voltage Command**

Voltage Nomenclature <sup>1,2</sup>	Description
<b>XN</b> RMS voltage between X and N	L1 Line to Neutral on a Wye-configured rPDU
<b>YN</b> RMS voltage between Y and N	L2 Line to Neutral on a Wye-configured rPDU
<b>ZN</b> RMS voltage between Z and N	L3 Line to Neutral on a Wye-configured rPDU
<b>XZ</b> RMS voltage between X and Z	L1 Phase to Phase on a Delta-configured rPDU
<b>XY</b> RMS voltage between X and Y	L2 Phase to Phase on a Delta-configured rPDU
<b>YZ</b> RMS voltage between Y and Z	L3 Phase to Phase on a Delta-configured rPDU

<sup>1</sup> Line-to-Neutral voltage will not be reported on a Delta-configured rPDU  
<sup>2</sup> Line-to-Line voltage will not be reported on a Wye-configured rPDU

### Usage

```
rPDU>voltage [summary] [XN|YN|ZN|XZ|XY|YZ]
```

where:

[summary] = Retrieves a summary of voltage per phase for all three phases  
[XN|YN|ZN|XZ|XY|YZ] = Phase line (see Table 16)

### Retrieve the present input voltage for rPDU phase lines

```
rPDU> voltage
```

#### Single-Phase Example

```
rPDU> voltage  
rPDU: RMS voltage: 240V.
```

#### Three-Phase Wye Example

```
rPDU>voltage  
rPDU: RMS voltage between X and N: 208V.  
rPDU: RMS voltage between Y and N: 209V.  
rPDU: RMS voltage between X and N: 207V.
```

#### Three-Phase Delta Example

```
rPDU>voltage  
rPDU: RMS voltage between X and Z: 208V.  
rPDU: RMS voltage between X and Y: 209V.  
rPDU: RMS voltage between Y and Z: 207V.
```



### Retrieve the input voltage for a specific phase line (Three-phase rPDUs only)

```
rPDU>[XN|YN|ZN|XZ|XY|YZ]
```

#### *Three-Phase Wye Example*


```
rPDU>voltage XN  
rPDU: RMS voltage between X and N: 230V.
```


#### *Three-Phase Delta Example*

```
rPDU>voltage XY  
rPDU: RMS voltage between X and Y: 208V.
```

### Retrieve a summary of the input voltage for rPDU phase lines (Three-phase rPDUs only)

```
rPDU>voltage [summary]
```

 **NOTE:** The summary option retrieves the voltage summary for each phase.

 **NOTE:** The summary option response displays the present power as the first parameter and the peak consumption watts as the second parameter. The minimum and average values will always be reported as zero.

#### *Three-Phase Wye Example*

```
rPDU>voltage summary  
XN:229V,0V,0V,0V  
YN:230V,0V,0V,0V  
ZN:231V0V,0V,0V
```

#### *Three-Phase Delta Example*

```
rPDU>voltage summary  
XY:208V, 0V,0V,0V.  
YZ:209V, 0V,0V,0V.  
XZ:207V, 0V,0V,0V.
```

### Retrieve a summary of the input voltage for a specific phase line (Three-phase rPDUs only)

```
rPDU>voltage [summary] [XN|YN|ZN|XZ|XY|YZ]
```

#### *Three-Phase Wye Example*

```
rPDU>voltage summary XN  
XN:229V,0V,0V,0V.
```


#### *Three-Phase Delta Example*


```
rPDU>voltage summary YZ  
YZ:209V,0V,0V,0V.
```


## Web Interface Operation

This chapter describes configuring and monitoring a Dell Metered Rack Power Distribution Unit (rPDU) remotely through the Dell™ Device Power Interconnect (DPI) Web interface.

- Navigating the Web interface
- Accessing the Web interface
- Configuring DPI administration settings
- Configuring DPI attributes
- Configuring network access and control
- Monitoring and managing the rPDU

 **NOTE:** The Web interface language is not configurable. Only English is provided.

 **NOTE:** The data that displays on the Web interface depends on the rPDU model you are using. The examples shown represent typical data displays reported from a single model.

 **NOTE:** The two most recent Microsoft Internet Explorer® and Firefox® browser versions are currently supported.

## Navigating the Web Interface

The Dell DPI is a graphical Web interface used to remotely monitor or configure the rPDU (see Figure 31). This section describes the functions provided by this interface.

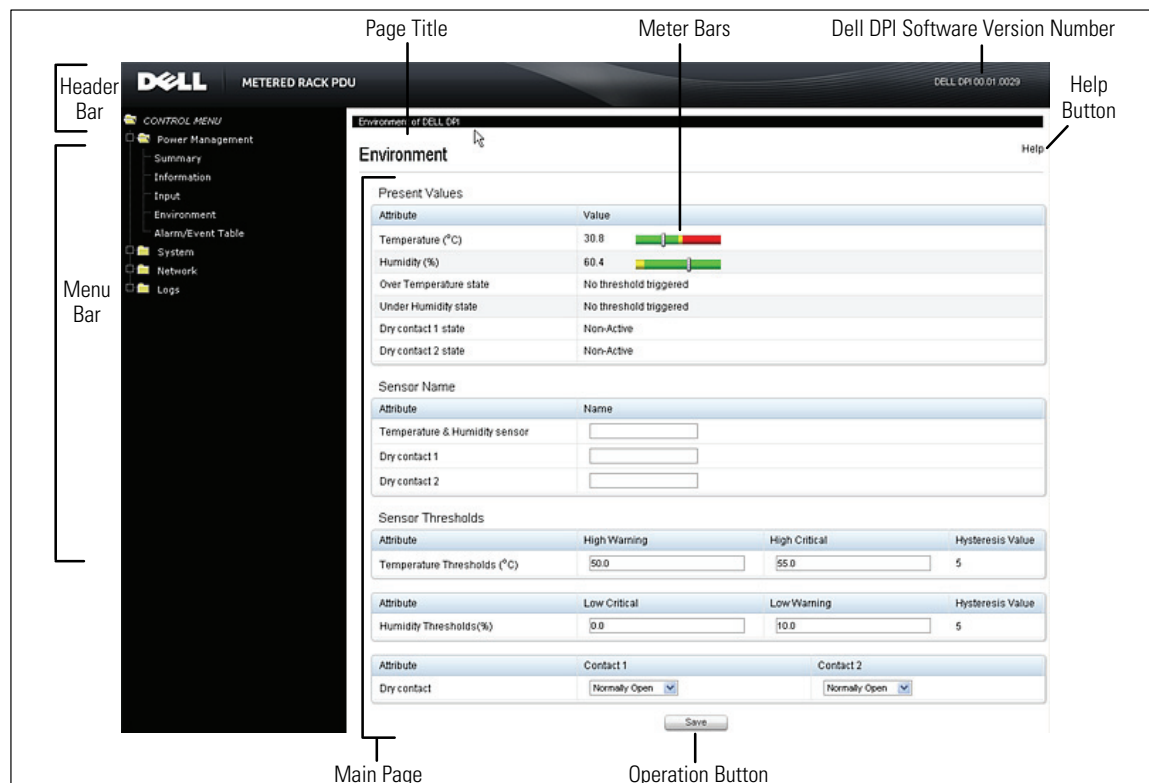

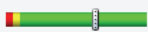

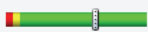

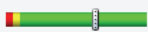
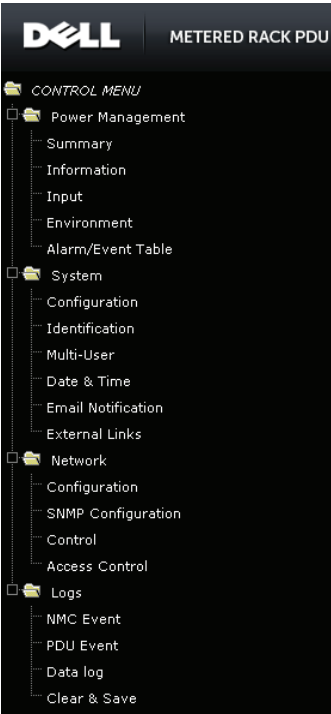


Figure 31. Navigating the Web Interface

Table 17 provides Web interface descriptions.

**Table 17. Web Interface Descriptions**

<b>Area</b>	<b>Description</b>						
<b>Header Bar</b>	The header bar displays the Dell DPI application name and software version number.						
<b>Menu Bar</b>	<p>The menu bar on the left panel contains links to pages for configuring the system or managing and monitoring the rPDU. The menu hierarchy is expandable and collapsible. You can move the menu bar out of view using the horizontal scrolling tab at the bottom of the page.</p> <p>Click any selection in the menu bar to retrieve rPDU performance data, review operation log information, retrieve system identification information, or enter a configuration settings (see Figure 32). The data on the selected page is presented in tables.</p>						
<b>Main Page</b>	<p>As each menu link is selected, the corresponding information displays on the Main Page. The top of the page displays the title and a Help link. Click Help on any page to see online help for the currently displayed page.</p> <p><b>NOTE:</b> You can expand your view of the Main Page contents vertically using the elevator tab on the side of the page. If you need more window viewing area, you can resize the window to a wider or taller size.</p>						
<b>Operation Buttons and Icons</b>	Operation buttons and icons are provided to save data entries and updates. Enter data by typing or selecting entries and clicking the associated button. Some pages have buttons for specialized functions, such as clearing accumulated data logs. File operation icons are also provided to save or download files.						
<b>Meter Bar</b>	<p>Meter bars provide a visual cue of the readings for selected data. The position of the white, vertical sliding bar indicates the present data reading. The color bar indicates high and low operation thresholds for this parameter (example shown below).</p> <div data-bbox="545 1076 1146 1155" style="border: 1px solid black; padding: 5px;"> <table border="1"> <tbody> <tr> <td data-bbox="553 1087 889 1119">Temperature (°C)</td> <td data-bbox="898 1087 979 1119">31.2</td> <td data-bbox="987 1087 1133 1119"></td> </tr> <tr> <td data-bbox="553 1123 889 1155">Humidity (%)</td> <td data-bbox="898 1123 979 1155">61.5</td> <td data-bbox="987 1123 1133 1155"></td> </tr> </tbody> </table> </div>	Temperature (°C)	31.2		Humidity (%)	61.5	
Temperature (°C)	31.2						
Humidity (%)	61.5						



**Figure 32. Menu Selections**

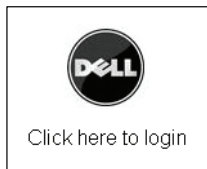
## Accessing the Web Interface

The Web interface can be accessed using standard Web browsers. Up to eight users can be provided with access to the interface, but only one administrator can be identified. Web access is enabled by default, but the administrator can disable access for any other user.

**NOTE:** The rPDU defaults to using DHCP when delivered. If you are unable to connect to the rPDU through the network connection with this default address, change the IP address using the serial interface before using any of the network interfaces. See “Serial Interface Operation” on page 50 for more information.

To access the Web interface:

- 1 Open the Web browser and navigate to the IP address of the rPDU.
- 2 Click the Dell logo start button to log in (see Figure 33).

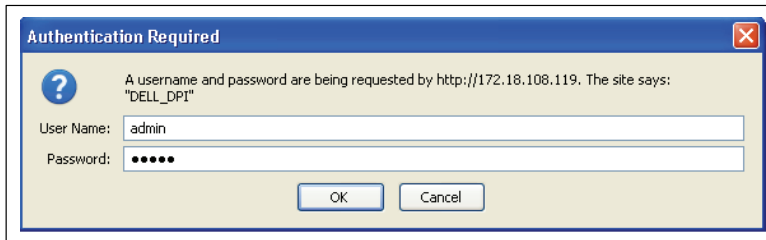


**Figure 33. Start Button**


- 3 Enter a valid user name and password in the **Authentication Required** dialog box. Click **OK** to continue or **Cancel** to exit.

The Home page displays with a menu bar on the left and the Summary table of present values in the Main Page on the right.


- 4 Click any selection in the menu bar to open the corresponding page in the Main Page.



**Figure 34. Login Authentication**

 **NOTE:** The default user name is admin and the default password is admin.


## Configuring DPI Administration Settings

 **NOTE:** Only the administrator can configure these options.

This section explains:

- Configuring administrator and user access and privileges
- Setting the date and time
- Setting up automatic Email notification
- Creating links to external Web sites


### Configuring Administrator Access


 **NOTE:** The default administrator user name and default password is admin.

To change the administrator user name and password:

- 1 From the **System** menu, click **Configuration**. The Configuration page displays.
- 2 Locate the **Administrator User Name and Password** table.
- 3 To change the administrator user name, enter the new password in the **Administrator User Name** field.
- 4 To change the administrator password, enter the new password in the **Administrator Password** field. The characters appear as asterisks (\*).
- 5 Enter the new password in the **Confirm Administrator Password** field. The characters appear as asterisks (\*).
- 6 Click **Save** to apply the new user name and password.
- 7 This procedure is completed.

### Configuring User Access

 **NOTE:** Only the administrator can configure these settings.


 **NOTE:** Up to eight users are allowed.

To configure access and privileges for multiple users:

- 1 From the **System** menu, click **Multi-User**. The Multi-User page displays.
- 2 Locate the **Multi-User List** table.
- 3 In the **User Name** field, enter the login ID to be used by this user.
- 4 Enter a password for the user in the **Password** field. The characters appear as asterisks (\*).


- 5 From the **Access Type** list, select the user privilege. Selections are **Device Access** or **Read Only**.
- 6 Click **Save** to apply the new user name, password, and access privilege.
- 7 Repeat these steps to authorize additional users. When all intended user access is configured, this procedure is completed.

## Setting the Date and Time

 **NOTE:** The default is to synchronize the date and time from the computer clock.

To set the date and time:

- 1 From the **System** menu, click **Date & Time**. The Date and Time page displays.

 **NOTE:** The Current Date and Time table displays the present system date and time.

- 2 In the **Configure Date and Time** table, choose one of the following methods:


To synchronize with computer time, go to Step 3.

To synchronize with a Network Time Protocol (NTP) server, go to Step 5.

To set the time and date manually, go to Step 9.

- 3 Select the **Synchronize with computer time** radio button. The current computer date and time displays.
- 4 Go to Step 10.
- 5 Select the **Synchronize with NTP server** radio button.
- 6 Type the NTP server address or DNS host address in the appropriate field, then select the time zone from the list.
- 7 Optional. Enable Daylight Savings Time by selecting the check box.
- 8 Go to Step 10.
- 9 Select the **Set manually** radio button. Type the time and date in the appropriate field.
- 10 Optional. Select a new format in the **Date Display Format** list.
- 11 Click **Save**.
- 12 This procedure is completed.

## Configuring Email Notification

 **NOTE:** Only the administrator can configure these settings.

To configure automatic Email notification:


- 1 From the **System** menu, click **Email Notification**. The Email Notification page displays.
- 2 Locate the **Email Configuration** table.
- 3 Complete entries for attributes (see Table 18).
- 4 Click **Save**.
- 5 This procedure is completed.

Table 18 describes the attributes in the Email Configuration table.

**Table 18. Email Configuration**


Attribute	Description
<b>Mail Server</b>	OPTIONAL. You can enter the IP Address or Host name of a SMTP mail server that will be used to send Email messages from the Dell DPI.  NOTE: If entering a Host name, you are also required to enter the DNS Address.
<b>DNS Address</b>	The IP address of your network. You must enter the DNS server address if you entered a Host name for the Mail Server.
<b>Optional SMTP Username</b>	OPTIONAL. The user name of the Simple Mail Transfer Protocol (SMTP) mail server that will be used by the Dell DPI to log into the mail server to forward Email notifications.
<b>Optional SMTP Password</b>	OPTIONAL. The corresponding user password of the mail server.
<b>Sender's Email Address</b>	Specifies the content of the "From" field of the Email. If you do not provide a sender's Email address, the "From" field of the Email will be account@[ipv4_address] or account@[ipv6_address].
<b>SMTP Reply to Address</b>	The address to which the user will reply when the event mail is received.
<b>SMTP Port Number</b>	The SMTP port number. You can enter a port number other than the standard port setting for SMTP (port 25).

### Identifying Email Notification Recipients

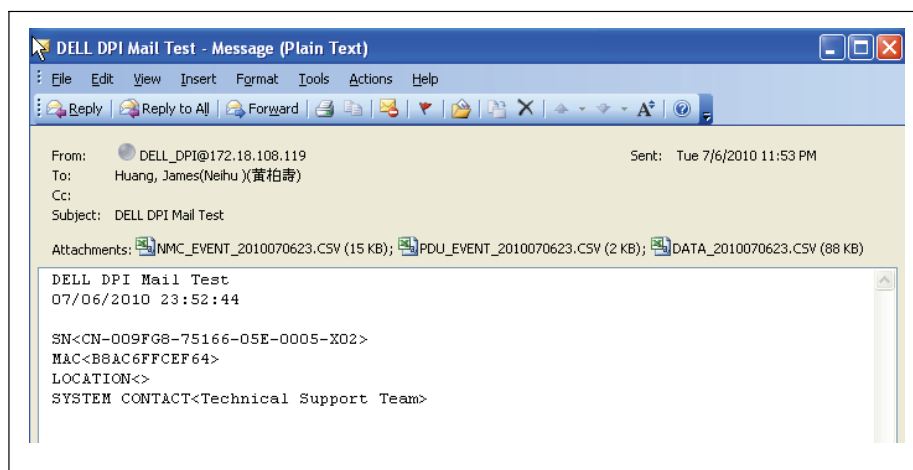
 **NOTE:** Only the administrator can configure these settings.

To configure automatic Email notification:

- 1 From the **System** menu, click **Email Notification**. The Email Notification page displays.
- 2 Locate the **Email Recipients Table**.
- 3 Complete entries for attributes (see Table 19).
- 4 Click **Save**.
- 5 Optional. Click **Send Test** to send a test Email to the recipients according to the Mail Type setting (see Figure 35 and Table 19).

 **NOTE:** If alarms and events have occurred, the event or alarm information is included in the test Email. However, if no alarms or events have occurred, and the **Send Test** button is clicked only once, the Email notification will contain no information. The purpose of this test is to ensure the Email address is valid.

- 6 This procedure is completed.




**Figure 35. Email Notification Test for Mail Type Daily Status**

Table 19 describes the attributes in the Email Recipients Table.

**Table 19. Email Recipients Table**


Attribute	Description
<b>Index</b>	Index number of the entry in the table.
<b>Mail Account</b>	Email address for the recipient of automatic notifications from the Dell DPI.
<b>Description</b>	User-defined description for reference.
<b>Mail Type</b>	Type of notification sent to this recipient. Selections include: <ul style="list-style-type: none"> <li>• None – No Email notification sent.</li> <li>• Events – Sends a text-only notification of any traps (no log files).</li> <li>• Daily Status – Sends both the data and event logs for the past 24 hours, starting 24 hours after the recipient is set up in the system.</li> <li>• Event/Status – Sends both text-only notification of any traps as well as data and event logs for the past 24 hours.</li> </ul>
<b>Event Level</b>	Sets the severity level of notification for Events or Events/Status mail types. (This filter is based on the SNMP-based traps). Selections include Critical, Major, Minor, or All.
<b>Mail Daily Report Level</b>	Sets the hour of the day the Email notification will be sent (Daily Status mail type only). Valid values are 00:00–23:00.

### Creating Links to External Web Sites

 **NOTE:** After external links are created, the link can be enabled to display at the bottom of the menu bar.

To create a link to external Web sites:

- 1 From the **System** menu, click **External Links**. The External Links page displays. Locate the **Links Table**.
- 2 In the **Screen Text** field, enter the external link name that will display at the bottom of the menu bar if the link is enabled (limited to 31 characters).
- 3 In the **Link Address** field, enter the URL of the external link (limited to 31 characters).

 **NOTE:** It is not necessary to include http:// in the address. These characters are added automatically.

- 4 From the **Status** list, select either **Enabled** or **Disabled** to display the external link name at the bottom of the menu bar.
- 5 This procedure is completed.




# Configuring DPI Attributes

This section explains:

- Setting the Dell DPI system attributes
- Resetting the Dell DPI configuration to default values
- Uploading or downloading configuration files
- Configuring default file opening settings for Comma Separated Values (CSV) file formats

## Setting Basic DPI Attributes

 **NOTE:** Only the administrator can configure these settings.

To configure the Dell DPI:

- 1 From the **System** menu, click **Configuration**. The Configuration page displays.
- 2 Locate the **System** table.
- 3 Complete entries for attributes (see Table 20).
- 4 Click **Save** to apply the Dell DPI configuration settings in the System table.
- 5 This procedure is completed.



 **NOTE:** These settings are in effect until the administrator enters new data and saves the changes. The present settings can be viewed in this table at any time.

Table 20 describes the attributes in the System table.

<b>Attribute</b>	<b>Description</b>
<b>System Name</b>	Dell system name. Limited to 31 characters. The default value is Dell PDU.
<b>System Contact</b>	System manager defined in MIB-II. Limited to 31 characters.
<b>System Location</b>	System installation locality defined in MIB-II. Limited to 31 characters.
<b>Data Log Interval (Sec)</b>	Polling time (in seconds) of the history log.
<b>Web Refresh Rate (Sec)</b>	Web refresh rate (in seconds) of the Summary, Input, and Environment pages in the <b>Power Management</b> menu. Select from 4 to 10 seconds. The default value is 10 seconds.

## Returning Configuration Settings to Default Values

 **NOTE:** Only the administrator can configure these settings.

To return the configuration to default values:

- 1 From the **System** menu, click **Configuration**. The Configuration page displays.
- 2 Under Control, click the **Reset to Default** button.  
The system is reset to the default configuration values.
- 3 This procedure is completed.

## Uploading a Configuration File

To upload a configuration file:

- 1 From the **System** menu, click **Configuration**. The Configuration page displays.
- 2 Under Upload & Download, click the **Browse** button and browse to the configuration file you want to upload.
- 3 Click the **Upload Configuration** button.
- 4 This procedure is completed.

## Downloading a Configuration File

To download a configuration file:

- 1 From the **System** menu, click **Configuration**. The Configuration page displays.
- 2 Under Upload & Download, click the **Download Configuration** icon.
- 3 Does the file download dialog box display or does the file data display in the browser window?  
If the dialog box displays, go to Step 4.  
If the file data displays in the Browser window, go to “Configuring Default CSV File Opening Settings” on page 75.
- 4 Choose to open or save the current Dell DPI configuration file and click **OK** (see Figure 36). Otherwise, click **Cancel**.
- 5 This procedure is completed.

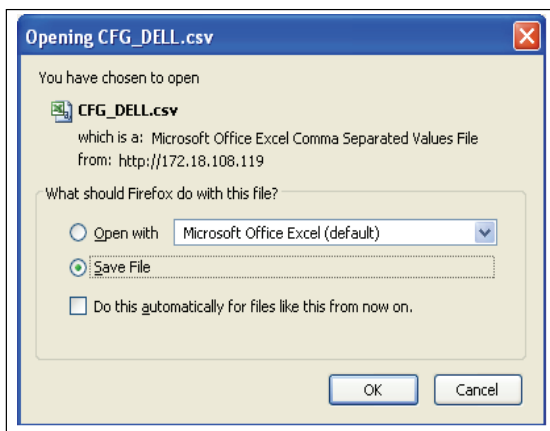


Figure 36. File Download Dialog Box

## Configuring Default CSV File Opening Settings

To configure default CSV file opening settings:

**1** After the configuration file is downloaded a destination on your desktop, correct the default file opening settings as follows:

- Click the **My Computer** icon and select **Folder Options** from the menu.
- Select the **File Type** tab and select **CSV** as the file type.
- Click the **Advanced** button, then select **Open**.
- Select the **Confirm open after download** check box.



**NOTE:** Do not select the **Browse in the same window** option.

- Repeat the steps to correct the default file opening settings for the file type **XLS**.



**NOTE:** After these settings are corrected, other configuration files will download properly.

**2** This procedure is completed.

## Configuring Network Access and Control

This section explains:

- Setting general IPv4 and IPv6 configuration options
- Enabling TCP/IP network controls
- Setting SNMP/HTTP access control
- Configuring SNMP protocol settings and trap receivers

### Setting General TCP/IPv4 Configuration Options

To configure TCP/IPv4:

**1** From the **Network** menu, click **Configuration**. The Network Configuration page displays.

**2** Locate the **General TCP/IPv4 Configuration** table and enter configuration values for IPv4 (see Table 21).

**3** Click **Save**.

**4** This procedure is completed.

Table 21 describes the attributes in the General TCP/IPv4 Configuration table.

**Table 21. General TCP/IPv4 Configuration**

<b>Attribute</b>	<b>Description</b>
<b>IP Address</b>	IP address of the Dell DPI in dotted format. Limited to 15 characters. DHCP is the default value.
<b>Gateway Address</b>	IP address of the gateway in dotted format. Limited to 15 characters. Gateway address 192.168.1.254 is the default value.
<b>Subnet Mask</b>	Subnet mask of the Dell DPI in dotted format. Limited to 15 characters. Subnet mask 255.255.0.0 is the default value.
<b>DNS Address</b>	IP address of your network DNS server. This is a required entry if you entered a Host name for the Mail Server in the Email Configuration table on the Email Notification page. Otherwise, 0.0.0.0 will be the value in the <b>DNS Address</b> field.

### **Setting General TCP/IPv6 Configuration Options**

To configure TCP/IPv6:

- 1** From the **Network** menu, click **Configuration**. The Network Configuration page displays.
- 2** Locate the **General TCP/IPv6 Configuration** table and enter configuration values for IPv6 (see Table 22).
- 3** Click **Save**.
- 4** This procedure is completed.

Table 22 describes the attributes in the General TCP/IPv6 Configuration table.

**Table 22. General TCP/IPv6 Configuration**

<b>Attribute</b>	<b>Description</b>
<b>Address Auto Configuration</b>	Enables or disables IPv6 address auto-configuration of the Dell DPI. If auto-configuration is enabled, the DPI searches for a “Router Advertisement” message to perform stateless auto-configuration. If no “Router Advertisement” message is found on the same link or the same subnet, the DPI performs a stateful auto-configuration using DHCPv6. Select <b>Enabled</b> or <b>Disabled</b> from the list. <b>NOTE:</b> Always set this value to <b>Disabled</b> if you are configuring TCP/IPv4.
<b>Address Status</b>	READ ONLY. Displays the status of Dell DPI IPv6 global address as valid or invalid. Valid status means the IPv6 global address is ensured uniquely and can be used for network communication. If IPv6 auto-configuration is enabled and successfully auto-configures the IPv6 global address, the status reported in this field is Valid. If the IPv6 auto-configuration fails, or if auto-configuration is disabled and manual configuration fails, the status reported in this field is Invalid. <b>NOTE:</b> The IPv6 link-local address is always valid on the same link or subnet.
<b>Link-Local Address</b>	READ ONLY. The IPv6 link-local address of the Dell DPI.
<b>Global Address</b>	IPv6 global address of the Dell DPI, such as 2001:B181:2::2E0:D8FF:FEFF:8A59.
<b>Global Prefix Length</b>	Prefix length of Dell DPI IPv6 global address. <b>NOTE:</b> If the prefix is 2001:B181:2::/64, the prefix length is 64. Normally, the prefix length is limited to 0 to 64.
<b>Default Router Address</b>	IPv6 address of Dell DPI default router.

### Enabling TCP/IP Network Controls

To configure TCP/IP network controls:


- 1 From the **Network** menu, click **Control**. The Network Control page displays.
- 2 Enter configuration values in the **TCP/IP Control** table (see Table 23).
- 3 Click **Save**.
- 4 This procedure is completed.

Table 23 describes the attributes in the TCP/IP Control table.

**Table 23. TCP/IP Control**

Attribute	Description
<b>BootP/DHCP Status</b>	Enable or disable the Boot Protocol (BootP)/Dynamic Host Configuration Protocol (DHCP) process. These protocols are used to obtain a dynamic IP address from a BootP/DHCP server.
<b>PING Echo</b>	Enable or disable the Dell DPI to respond to Ping requests.
<b>Network Upgrade</b>	Enable or disable the Trivial File Transfer Protocol (TFTP) upgrade control. You can use the provided upgrade utility on Windows using TFTP to upgrade the Dell DPI firmware.
<b>Telnet Connection</b>	Enable or disable the terminal to the server application (Telnet) control process, such as telnet 192.168.1.1. You can configure the Telnet protocol to use a port number other than the standard Telnet port (23).
<b>HTTP Support</b>	Enable or disable the HTTP connection with the Dell DPI. You can configure the HTTP protocol to use a port number other than standard HTTP port (80).

### Adding and Rejecting IP Addresses for SNMP/HTTP Access Control

 **NOTE:** The default IP address setting is 255.255.255.255.


To set and accept IP addresses:

- 1 From the **Network** menu, click **Access Control**. The SNMP/HTTP Access Control page displays.
- 2 Enter configuration values in the **Access Control Table** (see Table 24).
- 3 Select **Accept** from the **Access Type** list.
- 4 Click **Set Value**.
- 5 This procedure is completed.

### Rejecting IP Addresses for SNMP/HTTP Access Control

To reject IP addresses:

- 1 From the **Network** menu, click **Access Control**. The SNMP/HTTP Access Control page displays.
- 2 Enter the IP address in the **Access Control Table** (see Table 24).
- 3 Select **32** for the Mask value.

 **NOTE:** The Valid Address Range value is generated in the field automatically when the Mask value is set.

- 4 Select **Reject** from the **Access Type** list.
- 5 Click **Set Value**.
- 6 This procedure is completed.

Table 24 describes the attributes in the Access Control Table.

**Table 24. Access Control Table**

Attribute	Description
<b>Index</b>	Index number of the entry in the table.
<b>IP Address</b>	Management station's IP address. Empty value denotes entry not configured. The IP address is either an IPv4 or an IPv6 address.
<b>IPv6</b>	Only select this check box if you entered an IPv6 address.
<b>Mask</b>	The mask bits to verify the IPv4 or IPv6 address. Select from 1–32.
<b>Valid Address Range</b>	SYSTEM-GENERATED. The valid IP address range is set automatically when the mask is set.
<b>Description</b>	User-defined description string.
<b>Access Type</b>	Accepts or rejects the entry. Selections are <b>Accept</b> or <b>Reject</b> .

### Configuring SNMP Protocol Settings

To set SNMP protocol settings:

- 1 From the **Network** menu, click **SNMP Configuration**. The SNMP Configuration page displays.
- 2 Enter configuration values in the **SNMP Protocol Settings** table (see Table 25).
- 3 Click **Save**.
- 4 This procedure is completed.

Table 25 describes the attributes in the SNMP Protocol Settings table.

**Table 25. SNMP Protocol Settings**

Attribute	Description
<b>SNMP Status</b>	Enable or disable the SNMP connection with the Dell DPI.
<b>SNMP UDP Port</b>	Simple Network Management Protocol (SNMP) User Datagram Protocol (UDP) port. You can configure the SNMP protocol to use a port number other than the standard SNMP port (161).
<b>SNMP Version</b>	Simple Network Management Protocol (SNMP) version. Valid values are SNMPv1 and SNMPv2.
<b>SNMP Read Community</b>	Community name for clients allowed to access with read-only privileges. Limited to 31 characters. The characters appear as asterisks (*).
<b>SNMP Write Community</b>	Community name for clients allowed access with read-write privileges. Limited to 31 characters. The characters appear as asterisks (*).

## Configuring SNMP Trap Receivers

To set SNMP trap receivers:

- 1 From the **Network** menu, click **SNMP Configuration**. The SNMP Configuration page displays.
- 2 Enter configuration values in the **TRAP Receivers Table** (see Table 26).
- 3 Click **Save**.
- 4 This procedure is completed.

Table 26 describes the attributes in the TRAP Receivers Table.

**Table 26. TRAP Receivers Table**

<b>Attribute</b>	<b>Description</b>
<b>Index</b>	Index number of the entry in the table.
<b>NMS IP Address</b>	NMS station address to which the trap should be sent. The NMS address is entered in dotted format. IP address can be IPv4, IPv6, or DNS host name.
<b>Community</b>	Community string of the trap rPDU to be sent. Limited to 15 characters.
<b>Trap Type</b>	Disables traps or receives traps based on Dell DPI MIB. Selections are <b>Disabled</b> or <b>MIB Trap</b> .
<b>Severity</b>	Severity level of the trap to be received. Selections are: <ul style="list-style-type: none"><li>• All Traps – All traps are received.</li><li>• Minor – Minor severity traps are received.</li><li>• Major – Major severity traps are received.</li><li>• Critical – Significant traps, such as the outlet voltage over threshold, are received.</li><li>• None – No traps are received.</li></ul>
<b>Description</b>	User-defined description string for reference.



# Monitoring and Managing the rPDU

This section explains:

- Viewing the present rPDU status
- Viewing rPDU and Web/SNMP card identification
- Monitoring input power statistics
- Resetting rPDU input threshold values for low, high, and critical warnings
- Managing environmental sensors
- Monitoring alarms and events
- Managing event and data logs
- Restarting the internal rPDU NMC

## Viewing Present rPDU Status



**NOTE:** The Summary table always displays on the Main Page when the Web interface opens.

To view the present rPDU status:

- 1 From the **Power Management** menu, click **Summary**. The Summary page displays.
- 2 Review the present values for the rPDU (see Figure 37 and Table 27).
- 3 This procedure is completed.

Summary	
Present Values	
Attribute	Value
PDU Nominal Active Power (W)	22000
PDU Nominal Apparent Power (VA)	22000
PDU Total Rating Current (A)	96

**Figure 37. Summary**

Table 27 describes the attributes in the Present Values table.

**Table 27. Present Values**

Attribute	Description
<b>PDU Nominal Active Power (W)</b>	Calculated value of the overall input wattage of the rPDU, reported in Watts (W). This is also called active power.
<b>PDU Nominal Apparent Power (VA)</b>	Calculated value of the overall input volt-amperes (VA) of the rPDU. This is also called apparent power.
<b>PDU Total Rating Current (A)</b>	Present current measured at 3 $\phi$ input of the rPDU, reported in amperes (A).

### Viewing rPDU and Web/SNMP Card Identification

To view rPDU and Web/SNMP card identification:

- 1 From the **System** menu, click **Identification**. The Identification page displays.
- 2 Review the **PDU Identification** table and review the **Web/SNMP Card Identification** table (see Figure 38).
- 3 This procedure is completed.

Identification	
PDU Identification	
Attribute	Value
Model	DELL
Part Number	09FG8
Serial Number	CN-009FG8-75166-05E-0005-X02
Firmware Version	00.01.0009
Web/SNMP Card Identification	
Attribute	Value
Firmware Version	DELL DPI 00.01.0025
Serial Number	pm1005113
MAC Address	B8-AC-6F-FC-EF-64
NMC Up-Time	0 days 12 hours 46 mins 39.16 secs.

**Figure 38. Identification**

## Viewing rPDU System Information

To view rPDU system information:

- 1 From the **Power Management** menu, click **Information**. The Information page displays.
- 2 Review the **Present Values** table (see Figure 39).
- 3 This procedure is completed.

Information		Help
Present Values		
Attribute	Value	
Manufacturer	DELL	
Part Number	XX5T6	
Product name	DELL PDU 208V 17.3KW 3PH 42C13	
Serial Number	CN-0XX5T6-75166-06S-0006-X02	
FW version	00.01.0009	

**Figure 39. PDU Information**

## Monitoring Input Statistics

To view input readings or change rPDU warning thresholds:


- 1 From the **Power Management** menu, click **Input**. The Input page displays.
  - 2 Review the present input values for the rPDU, input power statistics, and input thresholds (see Table 28 and Figure 40).
-  **NOTE:** If you reset values for power statistics, you must click **Reset** before leaving this screen or the change will not be preserved. If you change input threshold values, you must click **Save** to save your changes (see Table 28).
- 3 This procedure is completed.

Table 28 describes the attributes in the Input Statistics tables.

**Table 28. Input Statistics**

Table	Attribute	Description
<b>Present Values (Phase 1, Phase 2, and Phase 3)</b>	PDU Input Voltage (V)	Present voltage reading for Phase 1, Phase 2, and Phase 3, displayed in Volts (V).
	PDU Input Current (A)	Present current reading for Phase 1, Phase 2, and Phase 3, displayed in Amps (A). A meter bar provides a visual representation of the reading.
	PDU Over Current State	Present current reading compared to the value set as the over current warning threshold. Either no threshold is triggered, or the threshold has been surpassed.
<b>Present Values</b>	PDU Input Frequency (Hz)	Present frequency measured at the input of the rPDU.
	PDU Input Active Power (W)	Calculated value of the overall input wattage of the rPDU, reported in Watts (W). A meter bar provides a visual representation of the reading.
	PDU Input Apparent Power (VA)	Calculated value of the overall input volt-amperes (VA) of the rPDU.

**Table 28. Input Statistics (Fortsetzung)**

<b>Table</b>	<b>Attribute</b>	<b>Description</b>
	PDU Input Remaining Active Power (W)	Provides the watts capacity remaining. <b>NOTE:</b> When the rPDU is in an overload state, this value is always 0.
	PDU Overload State	Present total watts (W) reading for all three phases is compared to the value configured as the overload alarm threshold. Either no threshold is triggered, or the threshold has been surpassed.
<b>Input Power Statistics</b>	PDU Input Peak Headroom Watts (Values provided for Watts and Time)	Provides the remaining watts available to support the load at peak demand. Provides a time and date stamp of the most recent data update. Click <b>Reset</b> to clear this value to the maximum value for this model and reset the time to the present time.
	PDU Input Peak Consumption Watts (Values provided for Watts and Time)	Provides the peak power demand on the rPDU. Provides a time and date stamp of the most recent data update. Click <b>Reset</b> to clear this value to zero (0) and reset the time to the present time.
	PDU Input Cumulative kWh (Values provided for Watts and Time)	Provides the total kWh usage. Provides a time and date stamp of the most recent data update. <b>NOTE:</b> This value accumulates. If this value reaches the maximum value for a 32-bit number, do not reset. Click <b>Reset</b> to clear this value to zero (0) and reset the time to the present time.
<b>Input Thresholds</b>	Phase 1 Current Thresholds (A)	Low Warning: Causes an alarm when the input current amperage (A) reading falls below the low warning threshold value displayed in the table.
		High Warning: Causes an alarm when the input current amperage (A) reading exceeds the high warning threshold value displayed in the table.
		High Critical: Causes an alarm when the input current amperage (A) reading exceeds the high critical threshold value displayed in the table.
	Phase 2 Current Thresholds (A)	Low Warning: Causes an alarm when the input current amperage (A) reading falls below the low warning threshold value displayed in the table.
		High Warning: Causes an alarm when the input current amperage (A) reading exceeds the high warning threshold value displayed in the table.
		High Critical: Causes an alarm when the input current amperage (A) reading exceeds the high critical threshold value displayed in the table.
	Phase 3 Current Thresholds (A)	Low Warning: Causes an alarm when the input current amperage (A) reading falls below the low warning threshold value displayed in the table.
		High Warning: Causes an alarm when the input current amperage (A) reading exceeds the high warning threshold value displayed in the table.

**Table 28. Input Statistics (Fortsetzung)**

Table	Attribute	Description
		High Critical: Causes an alarm when the input current amperage (A) reading exceeds the high critical threshold value displayed in the table.
<b>Input Thresholds</b>	Load Thresholds (W)	For Phase 1, Phase 2, or Phase 3: Causes an alarm when the total watts (W) reading for all three phases exceeds the overload warning threshold value displayed in the table.

NOTE: If you correct any threshold values in this table, click **Save** to save your changes.

**Input**
Help

---

Present Values

Attribute	Phase 1	Phase 2	Phase 3
PDU Input Voltage (V)	210.96	211.29	210.64
PDU Input Current (A)	4.13	6.31	6.21
PDU Over Current State	L1 Low Current Warning	No threshold triggered	No threshold triggered

Attribute	Value
PDU Input Frequency (Hz)	60.0
PDU Input Active Power (W)	1542
PDU Input Apparent Power (VA)	2024
PDU Input Remaining Active Power (W)	15757
PDU Overload State	Low Load Warning

Input Power Statistics

Attribute	PDU Input Peak Headroom Watts	PDU Input Peak Consumption Watts	PDU Input Cumulative kWh
Watts	14952	2348	0
Time	08/26/2010 03:08:54	08/26/2010 03:08:54	Since 08/21/2010 03:37:05
Reset	<input type="button" value="Reset"/>	<input type="button" value="Reset"/>	<input type="button" value="Reset"/>

Input Thresholds

Attribute	Low warning	High warning	High Critical
Phase 1 Current Thresholds (A)	<input type="text" value="5.00"/>	<input type="text" value="38.40"/>	<input type="text" value="48.00"/>
Phase 2 Current Thresholds (A)	<input type="text" value="5.00"/>	<input type="text" value="38.40"/>	<input type="text" value="48.00"/>
Phase 3 Current Thresholds (A)	<input type="text" value="5.00"/>	<input type="text" value="38.40"/>	<input type="text" value="48.00"/>
Load Thresholds (W)	<input type="text" value="2000"/>	<input type="text" value="13840"/>	<input type="text" value="17300"/>

**Figure 40. Input**


The meter bar colors on the Input page represent the following:


- **Blue** – The current reading for L1, L2, or L3 is below the low current warning threshold value that displays in the **Low warning** field, or the overall rPDU input wattage reading is below the load threshold value in the **Low warning** field.
- **Green** – The current reading is within the range of tolerance and no threshold has been triggered.
- **Yellow** – The current reading for L1, L2, or L3 is above the current warning threshold value that displays in the **High warning** field, or the overall rPDU input wattage reading is above the load threshold value in the **High warning** field.
- **Red** – The current reading for L1, L2, or L3 is above the current critical alarm threshold value that displays in the **High critical** field, or the overall rPDU input wattage reading is above the load threshold value in the **High critical** field.

### Managing Environment Sensors

To view readings or change warning thresholds for environment sensors:

- 1 From the **Power Management** menu, click **Environment**. The Environment page displays.
- 2 Review the present values for all sensors connected to the rPDU (see Table 29 and Figure 41).

 **NOTE:** If a sensor is not connected to the rPDU, a “Non-active” value displays.

 **NOTE:** If you change any sensor threshold values, you must click **Save** to save your changes (see Table 29).

- 3 This procedure is completed.

Table 29 describes the attributes in the Environment tables.

**Table 29. Environment**

Table	Attribute	Description
<b>Present Values</b>	Temperature (°C)	Displays the temperature in °C on the Temperature screen. A meter bar provides a visual representation of the reading.
	Humidity (%)	Displays the humidity percentage on the Humidity screen. A meter bar provides a visual representation of the reading.
	Over Temperature State	The current temperature compared to the value configured as the temperature threshold. Either no threshold is triggered, or the threshold has been surpassed.
	Under Humidity State	The current humidity compared to the value configured as the under-humidity threshold. Either no threshold is triggered, or the threshold has been surpassed.
	Dry Contact 1 State	The present state of dry contact 1. Either the dry contact is Normally Closed, Normally Open, or Non-active.
	Dry Contact 2 State	The present state of dry contact 2. Either the dry contact is Normally Closed, Normally Open, or Non-active.
<b>Sensor Name</b>	Temperature & Humidity Sensor	The user-defined sensor name.
	Dry Contact 1	The user-defined dry contact 1 sensor name.
	Dry Contact 2	The user-defined dry contact 2 sensor name.

**Table 29. Environment (Fortsetzung)**



Table	Attribute	Description
Sensor Thresholds	Temperature Thresholds (°C)	High Warning, High Critical Alarm: Temperature (°C) threshold setting in the range of 0.0–65.0 values. The Hysteresis Value displays (read-only).
	Humidity Thresholds (%)	Low Warning, Low Critical Alarm: Humidity. percentage threshold setting in the range of 0.0–95.0. The Hysteresis Value displays (read-only)
	Dry Contact	The operation setting for Dry Contact 1 or Dry Contact 2. Selections are Normally Closed or Normally Open.

**NOTE:** If you correct any threshold values in this table, click **Save** to save your changes.

**Environment**
Help

---

Present Values

Attribute	Value
Temperature (°C)	30.6 
Humidity (%)	62.5 
Over Temperature state	No threshold triggered
Under Humidity state	No threshold triggered
Dry contact 1 state	Non-Active
Dry contact 2 state	Non-Active

Sensor Name

Attribute	Name
Temperature & Humidity sensor	<input type="text"/>
Dry contact 1	<input type="text"/>
Dry contact 2	<input type="text"/>

Sensor Thresholds

Attribute	High Warning	High Critical	Hysteresis Value
Temperature Thresholds (°C)	<input type="text" value="50.0"/>	<input type="text" value="55.0"/>	5

Attribute	Low Critical	Low Warning	Hysteresis Value
Humidity Thresholds(%)	<input type="text" value="5.0"/>	<input type="text" value="10.0"/>	5

Attribute	Contact 1	Contact 2
Dry contact	<input type="text" value="Normally Open"/>	<input type="text" value="Normally Open"/>

**Figure 41. Environment**

The meter bar colors on the Environment page represent the following:

- **Green** – The temperature or humidity reading is within the range of tolerance and no threshold has been triggered.
- **Yellow** – The temperature reading is above the high temperature warning threshold value that displays in the the **High warning** field, or the humidity reading is below the low humidity warning level threshold value that displays in the **Low warning** field.
- **Red** – The temperature reading is above the high temperature alarm threshold value that displays in the **High critical** field, or the humidity reading is below the low humidity alarm threshold value that displays in the **Low critical** field.

## Viewing Present Alarms and Events



**NOTE:** The Alarm/Event Table provides the number of active alarms, the ID of the active alarm or event number, the time the alarm occurred, and an alarm description.

To view present alarms and events:

- 1 From the **Power Management** menu, click **Alarm/Event Table**. The Alarm/Event Table page displays.
- 2 Review the present alarms and events for the rPDU.
- 3 This procedure is completed.

## Viewing Event and Data logs



**NOTE:** The logs list all entries that have occurred since the table was cleared. The accumulated entries are overwritten when a maximum of 50 entries are collected. The logs can also be cleared manually with the **Logs** menu bar **Clear and Save** selection.

To view event and data logs:

- 1 From the **Logs** menu, click the link for the type of log you want to review:
  - **NMC Event** – Lists the NMC events that occurred in the specified date range, including a description and the date and time the event occurred.
  - **PDU Event** – Lists the events that occurred in the specified date range, including a description and the date and time the event occurred.
  - **Data log** – Provides a comprehensive snap-shot of all fundamental Dell DPI parameters by date and time stamp.




**NOTE:** The data collection interval for these measurements can be changed by selecting **Configuration** from the **System** menu and modifying the **Data Log Interval** setting.

- 2 In the log event list that displays for your selection, click the link for the selected date range you want to review.
- 3 This procedure is completed.




## Clearing Logs

 **NOTE:** Logs are overwritten automatically when a maximum of 50 entries are collected. Use this option if you choose to clear a log or logs before this maximum is reached.

To clear logs:

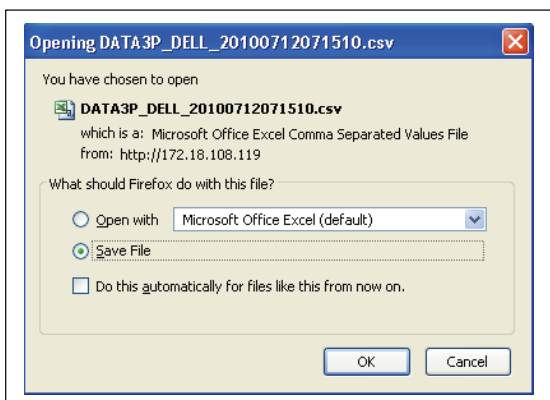
- 1 From the **Logs** menu bar, click **Clear & Save**. The Clear and Save page displays.
- 2 Under Clear Log Data, click one of the following buttons to clear the accumulated entries in the log:
  - Clear Data Log
  - Clear NMC Event Log
  - Clear PDU Event Log
- 3 A dialog box message prompts: Are you sure? Click **OK** or **Cancel**.
- 4 This procedure is completed.

## Saving Logs to an External File

 **NOTE:** The logs are saved to your computer as a spreadsheet in CSV format.

To save logs to an external file:

- 1 From the **Logs** menu bar, click **Clear & Save**. The Clear and Save page displays.
- 2 Under **Save Log Data**, click the icon for the type of log you want to save:
  - Data Log
  - NMC Event Log
  - PDU Event Log
- 3 Does the file download dialog box display or does the file data display in the browser window?  
If the dialog box displays, go to Step 4.  
If the file data displays in the Browser window, go to “Configuring Default CSV File Opening Settings” on page 75.
- 4 Choose to open or save the current log file and click **OK** or **Cancel** (see Figure 42).
- 5 This procedure is completed.



**Figure 42. File Download Dialog Box**

## Restarting the Internal rPDU NMC

To restart the rPDU NMC:

- 1 From the **System** menu, click **Configuration**. The Configuration page displays.
- 2 Under Control, click the **Restart NMC** button. The NMC restarts.
- 3 This procedure is completed.