



Catalog 6



*S*challtechnik Dr.-Ing. SCHOEPS GmbH was founded in Karlsruhe in 1948, operating from only a few small, private rooms at first. The company now occupies a site of over 1,500 sq.m., where 40 people are engaged in the development, production and distribution of professional condenser microphones and accessories.

SCHOEPS 
Mikrofone



Dr. Schoeps



Dr. Küsters

The founders of the company



Ulrich Schoeps, Dr. Helmut Wittek, Christian Langen

The present-day leadership



Our "classic" logo (– 2002)

High quality, reliability and neutral, accurate sound have always been hallmarks of our products. Over the years the reputation of our microphones has spread, largely by word of mouth, and the number of satisfied SCHOEPS users has grown steadily.

Nowadays we supply our microphones to broadcasters, sound recording studios and film recordists as well as musicians and other highly demanding individual users throughout the world. In addition, SCHOEPS microphones are used in top-flight conference and sound reinforcement applications, delivering extraordinary sound quality and reliability.

We have grown as a company by maintaining close contact with our customers, by remaining flexible and being available to offer individual advice. With this approach we hope to continue fulfilling our customers' requirements – and along with our customers, we hope to further the development of the recording art.



	page
<i>Our Product Lines</i>	4
<i>Guidelines for Selection</i>	
<i>The Colette Modular System</i>	9
<i>Microphone capsules</i>	
<i>Microphone amplifiers</i>	
<i>Accessories</i>	
<i>The Compact System</i>	47
<i>CCM _L and CCM _U microphones</i>	
<i>Accessories (by application)</i>	55
<i>for the modular and the compact system</i>	
<i>Special-Purpose Microphones</i>	73
<i>Shotgun microphone</i>	
<i>Speech capsules /compact speech microphones</i>	
<i>Headsets</i>	
<i>Hand-held microphones</i>	
<i>Stereo and Surround</i>	81
<i>Stereo microphones and sets</i>	
<i>Surround sets</i>	
<i>Stereo preamplifier</i>	
<i>Other Accessories</i>	109
<i>In-line filters and attenuators</i>	
<i>Cables</i>	
<i>Mounting accessories</i>	
<i>Wind- and popscreens</i>	
<i>Technical Appendix</i>	127
<i>Index</i>	137



SCHOEPS Microphones ... modular



Modular Microphones ("COLETTE" System)

A microphone capsule may be attached directly to a microphone amplifier to form a complete microphone.

Twenty capsule types and six amplifier types offer a large number of possible combinations; special versions also exist for certain amplifier types.

Microphones of the Colette modular system are described starting on page 13.



Active Accessories

Between a Colette microphone capsule and its amplifier, Active Accessories can be inserted. These special elements of the Colette series allow unobtrusive placement of the microphones, or offer other special functions such as steep, adjustable low-cut filters.

At left is an example of a Colette-series microphone with an Active Extension Tube between its capsule and amplifier.

*RC 1200g Active
Extension Tube*





... or compact:

Compact Microphones

The CCM-series compact microphones are miniature microphones of full professional quality. Their capsules are identical to those of the modular series, while their amplifiers achieve the same high level of performance, with balanced, symmetrical outputs at very low impedance.

The capsule and circuitry of a CCM are contained within a single unit, so capsules are not interchangeable.

Microphones of the compact series are described starting on page 47.



XLR-3M

Accessories

The CCM series can be used with most mechanical accessories of the Colette modular system.

CCM_L microphones (CCMs which feature a detachable cable) can also be used with special CCM-series accessories that parallel many of the Colette Active Accessories.

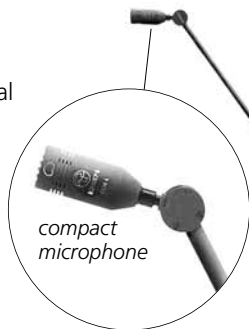

compact
microphone

Explanation of symbols

COLETTE modular — microphones of the Colette modular system:



CCM compact — microphones of the Compact system:



RL 1200g
straight extension
tube





Choosing a microphone

A microphone that offers natural sound quality will be suitable for almost any instrument, voice or ensemble. To achieve this, smooth frequency response at all angles of sound incidence is a fundamental requirement along with excellent transient response, wide dynamic range and low distortion. We specialize in small, single-diaphragm condenser microphones – the kind of microphone that can most closely approach these ideals – and we offer some twenty different capsule types. A few are designed for special purposes but most have a very wide range of applications.

Often there are many possible ways to make a good recording, and many microphone types that might be chosen. The recording location, the positions of the sound sources and microphone(s), the character of the program material and the desired effect must all be considered. Audio engineering is a job for human beings, not rulebooks, and the suggestions which we offer here are meant only as points of departure.

For near-to-medium-distance pickup, especially in the studio, the cardioid is the most commonly used directional pattern. The MK 4 single-pattern cardioid of the Colette series is our best-selling capsule. It has a clear, natural sound character without harshness or artificial coloration. Unlike large, dual-diaphragm microphones, its pattern is well maintained at low and high frequencies, not just in the midrange. We also offer the MK 4V, a laterally-addressed cardioid capsule with a gentle high-frequency response elevation. It, too, has smoother polar response than any large-diaphragm cardioid, so that sounds picked up from the sides of the capsule blend in with on-axis sound in a natural sounding way. For this reason the MK 4V is a special favorite for two-microphone stereo recording. It is the capsule used in the CMXY 4V stereo microphone and in several of our surround microphone sets.

Patterns other than cardioid may be preferable in many situations, however. For example, when there is a need to focus especially on one source of direct sound while reducing the pickup of other sound sources and room sound, a supercardioid capsule (MK 41, MK 41V) or even a "shotgun" microphone (CMIT 5) may be useful. In addition to providing a clearer and "drier" pickup for a given miking distance, supercardioids can give more accurate stereo imaging than cardioids when they are used in coincident stereo pairs. For more even pickup of broad sound sources, on the other hand, our MK 21 "wide cardioid" capsule might be considered. It has remarkably uniform response at all angles of incidence, plus a warm sound quality with rich, but not exaggerated, low-frequency response. A pair of wide cardioid capsules with appropriate spacing between them can be an excellent choice for stereo recording.

For recording in concert halls, churches and other venues with good natural reverberance, many stereo and surround pickup techniques have been developed; please see the charts on pages 131 and 132 for some

well-established examples. Many such methods involve microphone patterns other than cardioid (e.g. "Decca Tree" or "Blumlein" stereo), but the "ORTF" stereo recording method, developed using the forerunner of the Colette-series MK 4, is recognized as one of the most generally useful. (Our MSTC 64 stereo microphone is the definitive implementation of this recording method today.)

Sometimes the choice of a microphone is dictated by practical aspects of the recording environment. For example, directional microphones when used at close range tend to have elevated low-frequency response; this "proximity effect" is sometimes desirable as a special effect but can also be quite a problem, especially with male speaking voices. Proximity effect can ordinarily be filtered or equalized out, but specially-made speech capsules, with suitable compensation already built in, offer a simpler alternative especially for fixed installations such as sound reinforcement and public address systems. Such capsules are also less sensitive to breath noise ("popping" on spoken consonants), handling noise and room rumble generally. Or to take another case, outdoor recording with directional microphones can be ruined by wind noise; windscreens are effective only to a certain degree, and have adverse effects on directivity and sound quality. A pure pressure transducer such as our MK 2S is inherently resistant to wind, and may allow recording to proceed under conditions that would prove impossible for a directional microphone.

A recommended starting point: If there is one SCHOEPS microphone type that is simultaneously as versatile, as economical and as high in performance as possible, it would be our model CMC 65. With its switchable two-pattern MK 5 capsule (omnidirectional or cardioid) and CMC 6 amplifier (for 48-Volt or 12-Volt phantom powering, with extra RFI protection built in) this microphone offers the capabilities needed in the greatest number of practical recording situations. Unlike the dual-diaphragm capsules of other manufacturers, the single-diaphragm design of the MK 5 makes no compromise in performance, quality or reliability, yet its cost is distinctly lower than that of two separate capsules. With the CMC 65 as the starting point, other capsule types and/or SCHOEPS Active Accessories can be added at any time for further flexibility.

	Applications:	Recommendations:
Speech / Speakers	On a lectern	MK 4 (cardioid) with close-speech guard B 5 D
	Conference recording	MK 4 (cardioid) with close-speech guard B 5 D
	TV speaker's table	MK 4 (cardioid), no popscreen required at distances greater than around one-half meter
	Radio announcer	MK 4V (cardioid with lateral pickup) with pop filter PR 120 SV
	Noisy environments	MK 4S or MK 40 speech cardioid; MK 41S speech supercardioid (for ca. 10 - 20 cm miking distance)
	TV "round table" discussion	MK 4 (cardioid) or boundary-layer capsule BLM 03 Cg (hemisphere)
	Church	MK 40 (speech cardioid), perhaps as boundary layer microphone with BLC; BLM 03 Cg (hemisphere)
	Stage	radio microphone type HXiR (Audio Ltd.) with MK 4 (cardioid) and B 5 D popscreen or MK 2S (omni)
	News reporting	MK 5 (omni/cardioid, switchable) with windscreen B 5 D or W 5 D or W 20 R1; (the omni setting if there is strong wind; cardioid if other nearby sound needs to be reduced)
Film	MK 41 (supercardioid) or CMIT 5 U shotgun microphone	
Vocals	Stage (movable)	CMR (microphone amplifier for pocket transmitters) with MK 4 (cardioid) and B 5 D popscreen, or with MK 2S (omni)
	Stage (fixed)	MK 4 (cardioid) on RC Active Tube with B 5 D windscreen, CMH 64 handheld microphone (cardioid)
	Studio	MK 4, MK 4V (cardioids) with pop filter PR 120 S, PR 120 SV
Instruments	In general	MK 4 (cardioid), MK 21 (wide cardioid)
	Organ	MK 2S (omni) (also useful when trying to obtain more room sound); especially when the room's character is less than optimal or if the bass is too strong: MK 21 or even MK 4
	Tympani, bass drum, etc.	MK 2, MK 2H, MK 2S (for full response to the lowest audible frequencies)
	Solo pickup with adapters	flute: MK 8 (figure-8); violin, saxophone: MK 4 or MK 4V (cardioids)
	Accent ("spot") miking	MK 4 (cardioid), MK 41 (supercardioid), MK 21 (wide cardioid)
Stereo	Orchestra, chorus	ORTF microphone MSTC 64; for best low-frequency reproduction: A/B recording (e.g. with MK 2S) or with boundary-layer capsules BLM 3g or BLM 03 Cg, Decca Tree with 3 x MK 2S, perhaps using KA 40 accessory spheres; in particularly good acoustic: sphere microphone KFM 6
	Small orchestra/ensemble	M/S with RCY stereo Active Extension Tube, modular or compact microphones or boundary-layer capsules, X/Y; in particularly good acoustic: KFM 6 sphere
	Film and video dialog/effects	M/S with MK 41 (supercardioid) in the M-channel or X/Y on a boom, boundary layer with BLM 03 Cg e.g. under a thin tablecloth or in a car under the top
Surround	Orchestra	OCT surround, KFM 360, Decca Tree with 3 x MK 2S, perhaps using KA 40 accessory spheres
	Film and video dialog/effects	Double M/S on a boom and possibly a Hamasaki Square for increased envelopment

	<i>Pressure transducers</i> (omnidirectional microphones)	<i>Pressure-gradient transducers</i> (directional microphones – e.g. cardioid)
Frequency response:	Essentially flat, with accurate reproduction of the lowest frequencies. The on-axis response of the free-field capsule does not have a high-frequency emphasis but the capsule meant for the reverberant sound field does.	Reduced sensitivity (rolloff) at low frequencies, which can be compensated by close placement to the sound source (proximity effect)
Directional pattern:	Omnidirectional pattern in its ideal form only at low and middle frequencies. At very high frequencies there is an increasing directivity. For this reason even omnidirectional microphones are aimed toward the sound source.	Types: wide cardioid, cardioid, supercardioid (hypercardioid), bidirectional (figure-8), shotgun microphones. The frequency response of our figure-8 is nearly the same in all directions; the wide cardioid capsule has this advantage also.
Near-field behavior:	No proximity effect	Proximity effect: Elevation of the low frequencies as working distance decreases in near-field use (quite noticeable at less than 50 cm)
Sensitivity to vibration, wind and popping:	Very little; simple foam-type windscreens often offer good protection.	Considerable; shock mounting and larger, more elaborately constructed windscreens may be needed.

All of the wide variety of SCHOEPS microphones, without exception, use single-diaphragm electrostatic transducers.



*Jimmy Haslip and Marcus Baylor of The Yellowjackets
photo: Michael Frank*



Colette Modular System



	page
<i>System Overview</i>	11
<i>Microphone Capsules</i>	13
<i>Microphone Amplifiers</i>	31
<i>Accessories for the Modular System</i>	41



Microphone capsule (MK 4 shown here)

Microphone amplifier (CMC 6_ shown here)



Colette Modular System

The Colette modular system has been well proven for over thirty-five years, and is constantly being expanded.

Any condenser microphone consists of two main components: a capsule and an amplifier. The capsule converts sound waves into electrical signals; it determines the essential sound quality of a microphone as well as its directional pattern(s). The amplifier contains the circuitry needed to polarize (charge) the capacitive capsule and to convert its output to a balanced, low-impedance signal.

Microphones of the Colette series are *modular*: Capsules and amplifiers may be purchased separately or in combination; any Colette capsule works with any CMC-series amplifier. By changing capsules, different directional patterns and other characteristics can be chosen without requiring a complete, separate microphone for each application. (Several other special-purpose SCHOEPS amplifier types also work with Colette capsules, as described later in this catalog).

Colette series microphones can be used with special "Active Accessories" for visual or other reasons. The photo above left shows a long, thin "Active Extension Tube" being used between a Colette-series microphone's capsule and amplifier. This provides an unobtrusive way to place a microphone capsule directly in front of a vocalist or announcer without blocking anyone's view. This type of extension tube has become the standard for miking orchestras in television and video productions.

The lower photo at left (with the capsule shown mounted on a small table stand) shows another example. "Active cables" allow microphone capsules to be concealed in film, video and theatre scenery, while the amplifier of the microphone is located some distance away. In live concert recording, Active Cables or Tubes allow microphone capsules to be placed in optimal locations while preserving the audience's lines of sight.



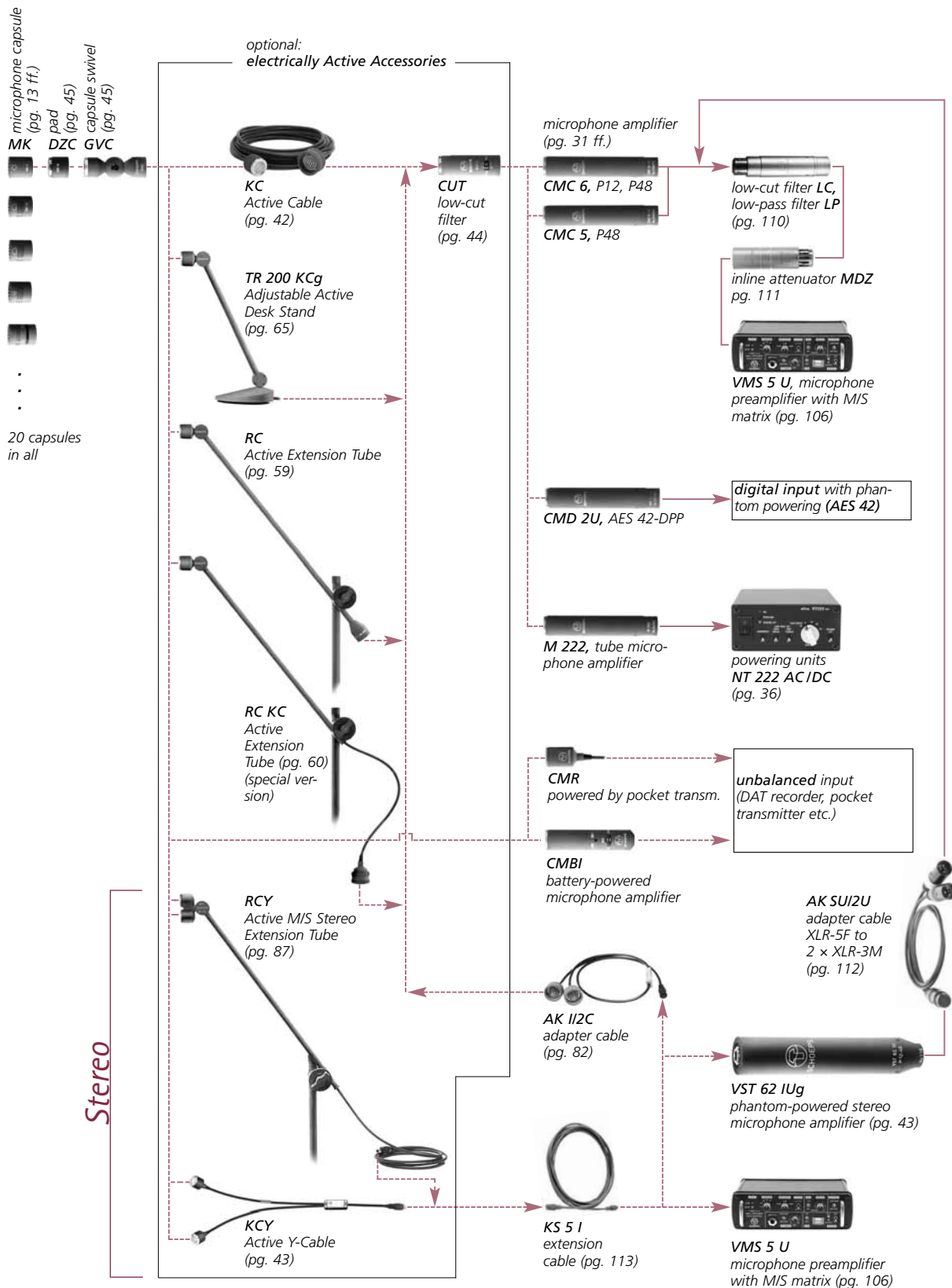

Signal:
balanced ———
unbalanced - - - - -



Sara K. in concert



Microphone Capsules



	page
<i>Pressure Transducers</i>	14
<i>Boundary-Layer Capsules</i>	18
<i>Wide Cardioids</i>	21
<i>Cardioids</i>	23
<i>Supercardioids</i>	25
<i>Figure-8</i>	27
<i>Switchable Capsules</i>	28



omni



Microphone Capsule MK 2

- omnidirectional pattern
- very flat frequency response
- for use close to the sound source (frontal sound incidence)
- often preferred for relatively close miking of instruments, vocalists, etc.

As can be seen from the frequency response curve, this capsule type has flat frequency response for frontal sound incidence. This yields a very natural quality when picking up sound that is predominantly direct, i.e. close to the source or in a "dry" acoustic. The sonic impression never becomes overly brilliant or "sharp."

Please note that there is some directivity at high frequencies due to the physics of sound wavelengths. Thus even with an omnidirectional microphone, it still matters which way the capsule is "aimed."

The MK 2 is often used for acoustical measurement, an application for which it has gained a considerable reputation. A mechanical adapter (type AMBK 1, from 20 mm to 1" diameter) is available for calibration with B&K devices. Please note that because of dimensional tolerances, only the nickel-finish version of the MK 2 can be used with this adapter.

Length: 22 mm
Diameter: 20 mm
Weight: 17 g

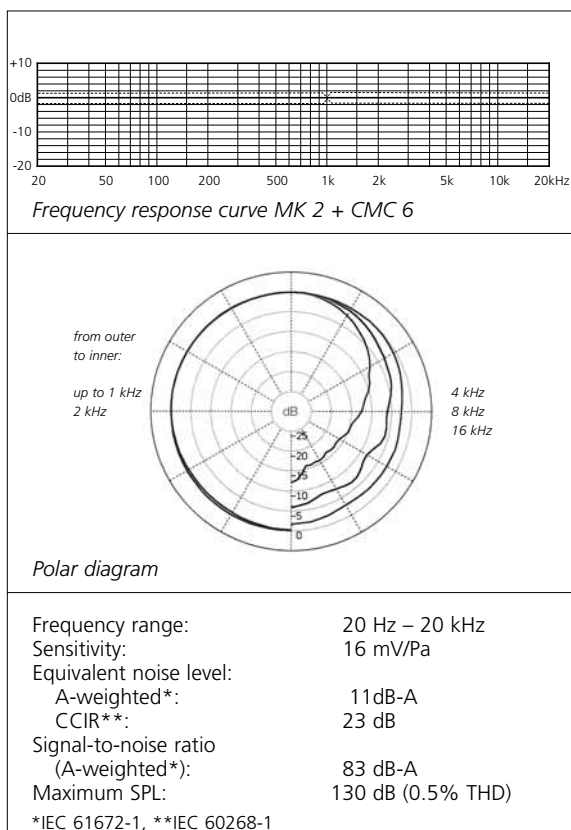

A frequency response graph for this capsule with the CMC 6 xt or CMD 2 xt amplifiers is shown on page 135.

Microphone Capsule MK 2H

- omnidirectional pattern
- mild high-frequency rise to compensate for losses at medium recording distance
- often chosen for “spaced microphone” stereo pickup and “Decca Tree” arrangements

If this microphone capsule is used indoors at medium recording distances (i.e. where direct sound energy is similar in amount to reflected sound energy), its overall response will be linear. Its extended frequency response and low noise make it appropriate for the most demanding applications.

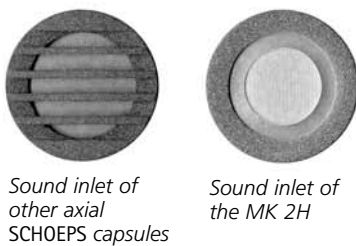

The sound inlet of the MK 2H is narrower than that of our other pressure transducers, causing a slight, purely acoustic response elevation above 6 kHz. This reduces the high frequency loss for diffuse sound, thus helping to preserve natural sound quality.

The MK 2H, like the MK 2S, is ideal for natural-sounding pickup of instruments and orchestras in spaces with well balanced reverberance. The choice between the two capsule types is essentially a matter of personal preference. At a given miking distance the MK 2H might be described as more “balanced and round” sounding while the MK 2S would give a slight additional brilliance. However, one might also choose the MK 2H for slightly closer placement or the MK 2S for slightly more distant placement – and then these two capsule types would have very similar sound quality, with the main difference being the balance of direct to reverberant sound which is picked up.

For spaced microphone (“A/B”) stereo recording and especially the “Decca Tree” method, KA 40 accessory spheres are recommended; please see page 114.

Length: 22 mm
Diameter: 20 mm
Weight: 17 g

A frequency response graph for this capsule with the CMC 6 xt or CMD 2 xt amplifiers is shown on page 135.

omni

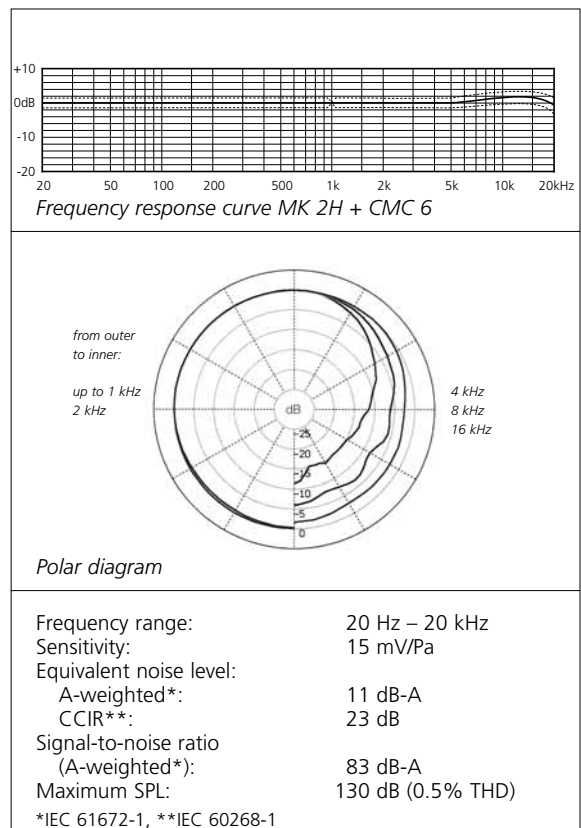



omni



Microphone Capsule MK 2S

- omnidirectional pattern
- slight high-frequency rise to compensate for losses at moderate recording distances
- for a very wide range of recording applications
- often preferred for “spaced microphone” stereo pickup and “Decca Tree” arrangements

The MK 2S exhibits a slight high-frequency emphasis for frontal sound incidence, with only a slight rolloff of high frequencies off axis and in the reverberant sound field. This frequency response characteristic falls between that of the MK 2 and the MK 3, making the capsule suitable for a wide range of applications. The MK 2S has proven particularly useful in two- and three-microphone stereo arrays, where its placement near the reverberation radius of the sound field (see page 130) presents a sonically balanced pickup favored by many recording engineers. This model has become our most popular pressure transducer.

For spaced microphone (“A/B”) stereo recording and especially the “Decca Tree” method, KA 40 accessory spheres are recommended; please see page 114.

Length: 22 mm
Diameter: 20 mm
Weight: 17 g

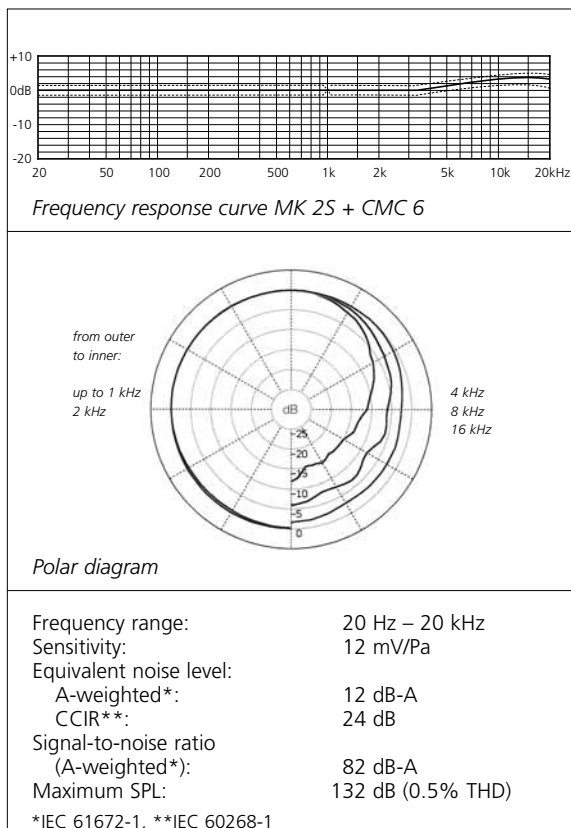

A frequency response graph for this capsule with the CMC 6 xt or CMD 2 xt amplifiers is shown on page 135.



Microphone Capsule MK 3

- omnidirectional pattern
- diffuse-field capsule, for miking distances at which the predominant sound is no longer direct
- useful for relatively distant placement in reverberant environments – as a room microphone, for “spaced microphone” stereo pickup and in “Decca Tree” arrangements

The MK 3 is designed for placement in a diffuse sound field, i.e. at distances in reverberant environments where the greater portion of arriving sound has already been reflected from various room surfaces. In such placement the integrated frequency response of this capsule is essentially flat; the on-axis high-frequency response elevation shown in the graph below is not heard as such. It is remarkable how well-focused a recording can be made with omnidirectional microphones at such distances, when the microphones have been designed and placed appropriately.

If this type of microphone is used close to the sound source, the emphasis of high frequencies for on-axis sound incidence would become clearly audible, producing an overly brilliant sonic impression. Since most recording today is miked more closely than in decades past, capsules such as the MK 25 or MK 2H are a reasonable norm for the majority of spaced-omni and “Decca Tree” applications. But if miking distances more typical of the mono and early stereo era are to be used, a capsule such as the MK 3, with its full diffuse-field equalization, may well offer the optimal balance of focus, depth and spaciousness – and the KA 40 accessory spheres (see page 114) can then add a further measure of presence to the sound at such distances, if desired.

The MK 3 is also often used as an ambient room microphone.

Length: 22 mm
Diameter: 20 mm
Weight: 17 g

A frequency response graph for this capsule with the CMC 6 xt or CMD 2 xt amplifiers is shown on page 135.

omni



COLETTE modular

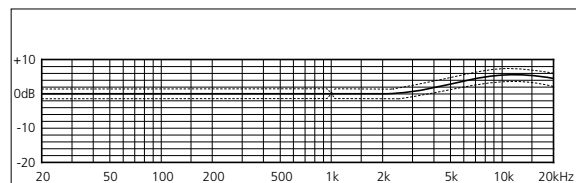

Frequency response curve MK 3 + CMC 6

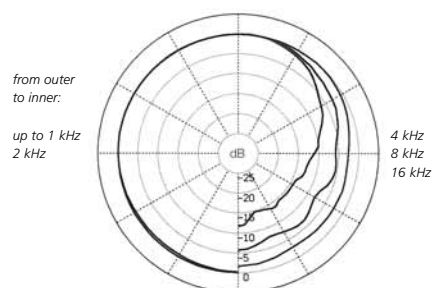

Polar diagram

Frequency range:	20 Hz – 20 kHz
Sensitivity:	10 mV/Pa
Equivalent noise level:	
A-weighted*:	14 dB-A
CCIR**:	26 dB
Signal-to-noise ratio (A-weighted*):	80 dB-A
Maximum SPL:	134 dB (0.5% THD)

*IEC 61672-1, **IEC 60268-1

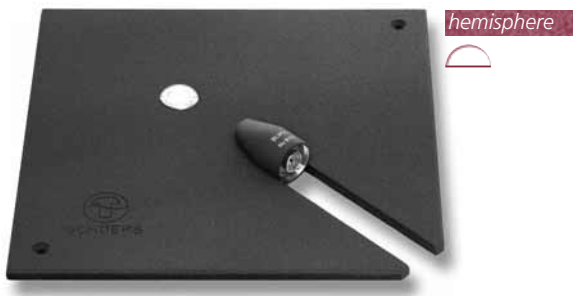

BLM 3g
with CMC 6 microphone amplifier

Boundary-Layer Capsule BLM 3g

- microphone capsule (pressure transducer) designed for placement at an acoustic boundary
- when the pickup angle changes, the sound color does not change
- excellent reproduction of low frequencies
- often preferred for orchestral recording

Boundary-layer recording offers unobtrusive microphone placement possibilities; no stands or hanging fixtures are required. When pressure transducers are used, the result is a hemispherical directional characteristic that is independent of frequency; thus it is not necessary to aim the microphones, and if the angle of sound pickup changes, the sound quality remains essentially the same.

The technique is based on an effect in physics by which sound pressure doubles along a sound-reflecting surface. If a transducer is placed directly on such a surface, or is built within it as with the BLM 3, its sensitivity to direct sound will be twice that of an equivalent transducer in a free sound field. Its response to diffuse sound remains unchanged, however, causing a notable increase in the clarity of pickup for a given miking distance.

In theory an ideal transducer of this type would have a membrane of infinitesimally small size, and would be mounted flush with an infinitely large, perfectly sound-reflecting surface. In practice, the plate in which the small transducer of the BLM 3g is mounted assures reflection of only the high and medium frequencies. To reflect sound at lower frequencies (greater wavelengths), the dimensions of the surface must be correspondingly larger. So the microphone should be placed on a floor, wall or ceiling, or mounted on another surface large enough to reflect the lowest frequencies of interest.

Since the plate of the BLM 3g is only 5 mm thick and the transducer is not mounted at its center, the edges of the plate have very little effect upon the sound pickup. The BLM 3g does not interfere with the natural sound field; off-axis sounds thus encounter very little frequency discrimination. Sound coloration is low, even for moving sound sources, because the frequency response is essentially the same for all angles within the hemispherical pickup pattern.

Microphones used near sound-reflecting surfaces ordinarily produce comb-filter effects. This does not occur with the BLM 3g, since at the boundary in which the transducer is mounted there can be no phase difference between the direct sound and its reflection.

Ordinary pressure transducers show a difference in sensitivity between direct and diffuse sound at high frequencies. In a properly placed boundary-layer microphone, however, this difference occurs at all frequencies. The sound pressure for direct sound is doubled at an acoustic boundary (6 dB increase), while the essentially random phase relationships of reflections in the

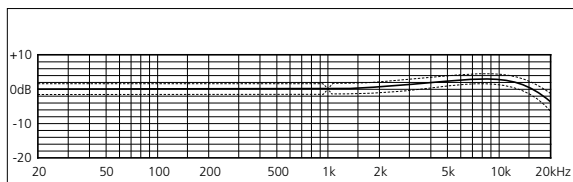

Frequency response curve BLM 3g + CMC 6

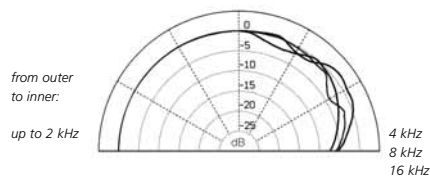

Polar diagram

Frequency range:	20 Hz – 20 kHz
Sensitivity:	19 mV/Pa
Equivalent noise level:	
A-weighted*:	12 dB-A
CCIR**:	23 dB
Signal-to-noise ratio (A-weighted*):	82 dB-A
Maximum SPL:	128 dB (0.5% THD)

*IEC 61672-1, **IEC 60268-1



diffuse sound field cause the boundary-layer microphone's sensitivity to increase by only 3 dB. Thus a boundary-layer microphone will suppress diffuse sound somewhat, even though it is not directional. It will pick up less "room sound" and the recording will be slightly "drier" than it would be with an omnidirectional microphone.

The capsule itself is a classic electrostatic pressure transducer, which assures accurate reproduction of even the lowest frequencies along with the high signal-to-noise ratio and stable performance typical of professional condenser microphones.

This type of transducer is inherently insensitive to wind and vibration and the BLM 3g is comparatively heavy, so it picks up very little solid-borne noise. For example, when footsteps are recorded, most of the sound reaching the microphone will be conducted through the air rather than the floor.

Typical applications include pickup of stage dialogue, or in orchestra pits, as an ambience microphone and for special public address applications. Since the microphone may well be used on the floor, the likelihood of damage from its being stepped on has been reduced by careful design and construction. As a rule, the capsule will not be harmed by normal footwear.

The BLM 3g (boundary-layer microphone capsule) resembles any other microphone capsule of the Colette series in that it needs a microphone amplifier (e.g. CMC, CMD 2U or M 222) to form a complete microphone. This arrangement allows the pad (DZC) and Active Accessories such as the variable low-cut filter (CUT 1 or CUT 2) or the Active Cable (KC) to be added as well.

Boundary layer microphones are particularly useful for unobtrusive recording with A/B (spaced microphone) methods, but M/S recording is also possible, using the special MS-BLM accessory (see photo above right).

Dimensions: plate: 200 mm × 200 mm × 5 mm
 Height of the microphone-amplifier connector: 21 mm
 Weight: 570 g (without microphone amplifier)
 Surface finish: matte gray

Accessory (included):

polished wood case

Accessory (optional):

M/S double clamp MS-BLM allowing Mid-Side (M/S) stereo pickup with the BLM 3g in the Mid channel

The MS-BLM can be used when making M/S recordings with a BLM 3g. Its larger side holds the microphone amplifier (e.g. CMC) or capsule connector of the KC Active Cable, screwed onto the BLM 3g. The smaller side either holds an Active Cable with an MK 8 capsule or a CCM 8 U compact microphone, which should be placed over the sound inlet of the BLM 3g. The engraved "8" on the end of the MK 8 or CCM 8 U should lie parallel to the plate of the BLM 3g, and the red dot should point to the left when viewed from behind the microphones.

The great advantage of M/S technique is the ability to make adjustments during post-production. The "M" and "S" channels can be recorded directly, and matrixed into stereo left and right signals in playback. The apparent width of the stereo image can then be set appropriately for the given situation.

Color: gray



Setup for M/S recordings with BLM 3g + MS-BLM and MK 8 + KC Active Cable or compact microphone CCM 8U

COLETTE
modular

Directional boundary-layer recording:

microphone: e.g. cardioid
 CCM 4 or MK 4 with
 Active Cable



hemi-cardioid

hemi-supercardioid

COLETTE
modular

CCM
compact



COLETTE
modular



BLM 03 Cg
with microphone amplifier CMC 6Ug

Miniature Boundary-Layer Capsule BLM 03 Cg

- pressure transducer with hemispherical pattern
- active miniature version of the BLM 3g
- unobtrusive, for a very wide range of recording applications
- often preferred for room pickup or for placement on podiums or speakers' tables

The BLM 03 Cg offers all the recognized advantages of the BLM 3g, while its smaller size permits more unobtrusive microphone placement. Its shallow profile and circular shape can often be disguised or hidden, e.g. under a light tablecloth. It is recommended in those cases where the BLM 3g is too large (e.g. for TV or film sound) or too heavy, e.g. for mounting in the interior of a car under the roof, or beneath the lid of a piano:



An Active Cable hard-wired to the BLM 03 Cg allows it to be joined to any microphone amplifier of the Colette series (except the CMBl) to become a complete microphone. The Active Filter CUT may also be added.

Any boundary-layer microphone must be placed on a sound-reflecting surface large enough for adequate low frequency pickup. A table top may suffice for speech applications such as conference recording, but most setups for music recording will require a larger surface.

Dimensions: diameter: 80 mm,
max. height: ca. 8.6 mm

Cable length: 5 m

Weight without microphone amplifier CMC: 233 g

Surface finish: matte gray (g)

Accessories (included): polished wood case

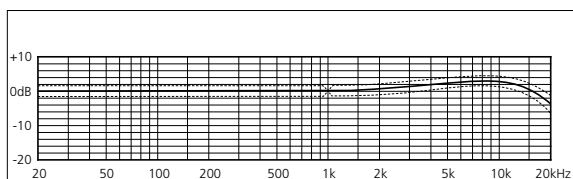

Frequency response curve BLM 03 Cg + CMC 6

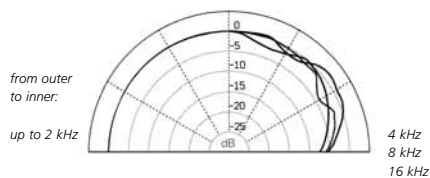

Polar diagram

Frequency range:	20 Hz – 20 kHz
Sensitivity:	19 mV/Pa
Equivalent noise level:	
A-weighted*:	12 dB-A
CCIR**:	23 dB
Signal-to-noise ratio (A-weighted)*:	82 dB-A
Maximum SPL:	128 dB (0.5% THD)

*IEC 61672-1, **IEC 60268-1



Microphone Capsule MK 21

- wide cardioid with especially consistent directionality throughout its frequency range
- pleasant sonic impression, often described as "warm"
- often preferred for use as a spot microphone, or as the main pair for overall stereo pickup

This type of capsule has a directional pattern between omni and cardioid. The basic idea in designing this capsule was to combine the advantages of the cardioid with those of the omni. This results in a pickup pattern which blends the two sets of characteristics. It has fuller and more extended low-frequency response than a cardioid, with less proximity effect, while picking up more room sound than a cardioid.

The polar diagram shows the directivity of the MK 21 to be only slightly dependent on frequency. This contrasts with omnidirectional capsules, whose directivity increases with rising frequency, and with cardioids (at least smaller ones), which tend to accentuate high frequencies that arrive at oblique angles. The MK 21's orientation is less critical than with a cardioid, since direct sound arriving on axis and reverberant or other sounds off axis are both reproduced accurately. This lack of coloration in the off-axis pickup produces a "warm" and natural sonic impression.

The low directivity of this capsule type prevents it from generating large enough level differences for X/Y use, though M/S and near-coincident spacings are often successful.

Together with the cardioid and supercardioid, this is one of the most preferred types among our capsules.

Length: 22 mm
Diameter: 20 mm
Weight: 17 g

A frequency response graph for this capsule with the CMC 6 xt or CMD 2 xt amplifiers is shown on page 135.

wide cardioid



COLETTE modular

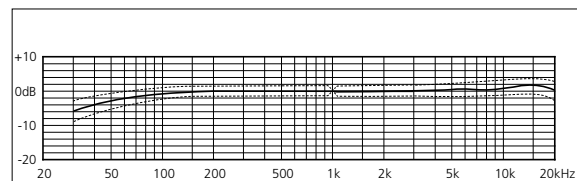

Frequency response curve MK 21 + CMC 6

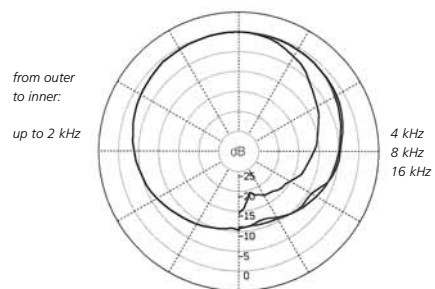

Polar diagram

Frequency range:	30 Hz – 20 kHz
Sensitivity:	13 mV/Pa
Equivalent noise level:	
A-weighted*:	14 dB-A
CCIR**:	24 dB
Signal-to-noise ratio (A-weighted*):	80 dB-A
Maximum SPL:	132 dB (0.5% THD)
*IEC 61672-1, **IEC 60268-1	



wide cardioid



Microphone Capsule MK 21H

- wide cardioid pattern with especially consistent directionality throughout its frequency range
- high-frequency elevation for brilliance of sound
- often preferred for use when recording vocals, acoustic guitar or percussion

This capsule type is an outgrowth of our field experience with the MK 21. It embodies suggestions made by various pop musicians who wished certain instruments (such as percussion, acoustic guitar and vocals) to be reproduced with a touch of additional brightness, while maintaining the essential uniformity of response to sound originating anywhere in the capsule's front hemisphere.

The frequency response of the MK 21H rises at high frequencies, reaching +4 dB at 7 kHz. Unlike most other condenser microphones, this capsule's response does not then roll off, but "stays up" even at very high frequencies.

As with our MK 21, the frequency response of this model is exceptionally consistent for all directions of sound incidence.

Length: 22 mm
Diameter: 20 mm
Weight: 17 g

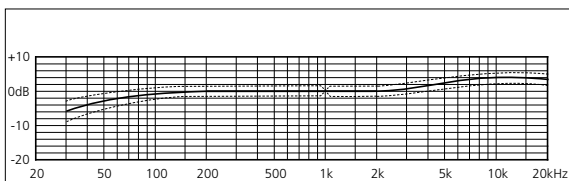

Frequency response curve MK 21H + CMC 6

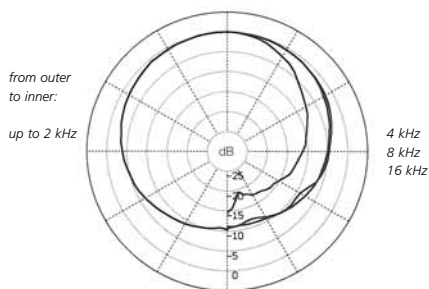

Polar diagram

Frequency range:	30 Hz – 20 kHz
Sensitivity:	10 mV/Pa
Equivalent noise level:	
A-weighted*:	16 dB-A
CCIR**:	26 dB
Signal-to-noise ratio (A-weighted)*:	78 dB-A
Maximum SPL:	134 dB (0.5% THD)

*IEC 61672-1, **IEC 60268-1

A frequency response graph for this capsule with the CMC 6 xt or CMD 2 xt amplifiers is shown on page 135.



Microphone Capsule MK 4

- classic cardioid, with consistent directionality throughout its frequency range
- suitable for the widest range of applications, either as a spot microphone or for stereo recording with coincident, ORTF or M/S microphone arrangements
- often preferred for singing or speaking voices and most instruments

The MK 4 is our best-selling capsule. It offers the highest sound quality, flat frequency response, optimal rejection of rear-incident sound, and a directional pattern that remains constant throughout the audio frequency range. In the diffuse sound field it shows only a mild rise around 10 kHz; the sonic impression thus remains free of coloration even when sound is arriving from all sides at once. The sonic impression is thus free of coloration whether sound is arriving at the front or at the sides of the microphone, as well as for diffuse sound (reverberation) in a room.

For those who dare to use their ears rather than just their eyes when choosing a vocal microphone, a Colette microphone using the MK 4 capsule can be a remarkable instrument. It is often preferred by opera singers and other trained vocalists. But its natural, transparent character also suits it very well for use in pop and rock applications, on stage or in the studio, where equalization is a part of the plan. A microphone with a clear, neutral sound quality provides the ideal point of departure whenever special "coloring" is needed.

Length: 22 mm
Diameter: 20 mm
Weight: 17 g

A frequency response graph for this capsule with the CMC 6 xt or CMD 2 xt amplifiers is shown on page 135.

cardioid



COLETTE modular

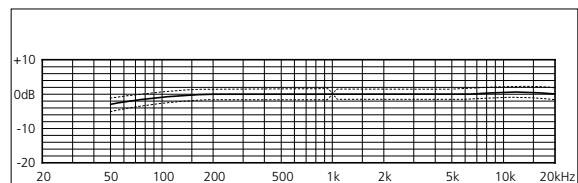

Frequency response curve MK 4 + CMC 6

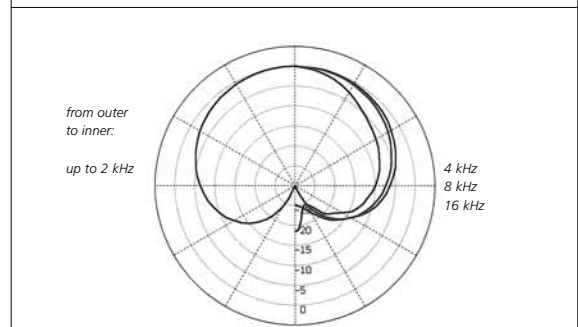

Polar diagram

Frequency range:	40 Hz – 20 kHz
Sensitivity:	13 mV/Pa
Equivalent noise level:	
A-weighted*:	15 dB-A
CCIR**:	24 dB
Signal-to-noise ratio (A-weighted*):	79 dB-A
Maximum SPL:	132 dB (0.5% THD)
*IEC 61672-1, **IEC 60268-1	

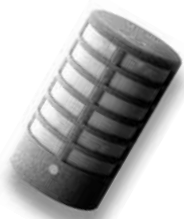

cardioid



Microphone Capsule MK 4V

- “vertical” (side-addressed) cardioid capsule
- for a very wide range of recording applications
- slight high-frequency emphasis
- often preferred for singing or speaking voices and most instruments

The MK 4V was created in answer to requests for a cardioid with its main axis along the side. In addition to its usefulness in the concert hall, this capsule type is of particular value in speech recording, since its slight emphasis around 10 kHz helps to improve intelligibility.

The directional response is especially well maintained even at higher frequencies, due to the acoustically transparent housing. There is less high-frequency emphasis of off-axis sound than occurs with most small, axial-response cardioids. The MK 4V still sounds somewhat brighter than the MK 4, however, because of its overall frequency response.

For speech applications, SCHOEPS offers the pop filter PR 120 SV.

The MK 4V may be easier to use in near-coincident setups than the MK 4: the microphone bodies do not get in each other's way.

Length: 34 mm
Diameter: 20 mm
Weight: 18 g

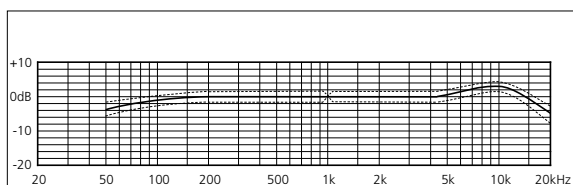

Frequency response curve MK 4V + CMC 6

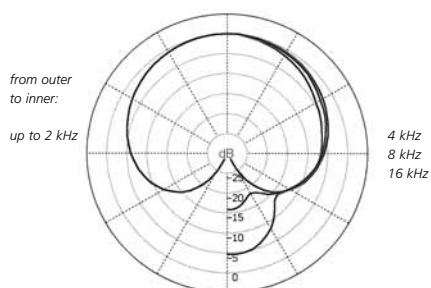

Polar diagram

Frequency range:	40 Hz – 20 kHz
Sensitivity:	13 mV/Pa
Equivalent noise level:	
A-weighted*:	14 dB-A
CCIR**:	24 dB
Signal-to-noise ratio (A-weighted*):	80 dB-A
Maximum SPL:	132 dB (0.5% THD)

*IEC 61672-1, **IEC 60268-1



Microphone Capsule MK 41

- supercardioid with highly consistent directionality throughout its frequency range
- for music and speech
- high directivity, comparable to that of a short “shotgun” microphone up through midrange frequencies
- often preferred for use in film sound recording and as a spot microphone in orchestras

The MK 41 is strongly directional. Sound arriving from off axis is attenuated even more than with a cardioid. The pickup is “drier” and less susceptible to acoustic feedback than any other SCHOEPS capsule type (a loudspeaker should not be located directly along the rear axis of the microphone, however).

Its directivity is highly independent of frequency, so that even sounds arriving off axis and reverberant sound are registered without coloration. Consequently, even distant placement of the capsule produces a very natural sound pickup. This is a real advantage over interference-tube “shotgun” microphones, whose directivity is very frequency-dependent – exceeding that of a supercardioid only at higher frequencies. Interference-tube microphones are notoriously sensitive to their position in a room, where the shifting patterns of reflections cause corresponding shifts in sound color. Thus the MK 41 are surprisingly effective, space-saving alternatives to shotgun microphones – and being small, they can often be placed closer to the sound source. (Regarding shotgun microphones, see also page 129.)

An M/S microphone arrangement can be set up at quite some distance from the sound source if an MK 41 is used for the “M” channel.

Compared to the cardioid MK 4, the MK 41 has slightly more rolloff at the low end due to the gradient effect. Its diffuse field response elevation is less than that of the MK 4.

Length: 22 mm
Diameter: 20 mm
Weight: 17 g

A frequency response graph for this capsule with the CMC 6 xt or CMD 2 xt amplifiers is shown on page 135.

supercardioid



COLETTE modular

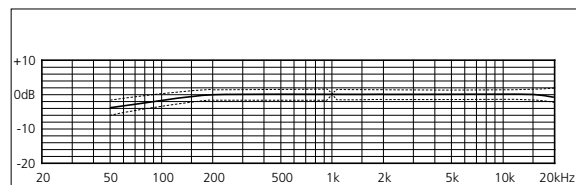

Frequency response curve MK 41 + CMC 6

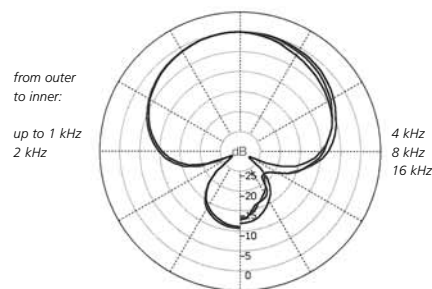

Polar diagram

Frequency range:	40 Hz – 20 kHz
Sensitivity:	14 mV/Pa
Equivalent noise level:	
A-weighted*:	15 dB-A
CCIR**:	24 dB
Signal-to-noise ratio (A-weighted*):	79 dB-A
Maximum SPL:	132 dB (0.5% THD)

*IEC 61672-1, **IEC 60268-1



supercardioid



Microphone Capsule MK 41V

- supercardioid with especially consistent directionality throughout its frequency range
- “vertical” (side-addressed) supercardioid capsule
- for a very wide range of recording applications
- high directivity, comparable to that of a short “shot-gun” microphone up through midrange frequencies
- often preferred for use in music and speech recording, as a spot microphone and also as a main microphone, especially when using the OCT recording method

Like the MK 41, the MK 41V is useful in all situations with music or speech, either as a “spot” microphone or as an overall directional microphone. However, this type of capsule is addressed from the side.

It excels particularly in the constancy of its polar response throughout the audio spectrum. As a result, sound within 90° on either side of the main axis is picked up with virtually no alteration of frequency response or tone color. This is strongly evident with sound sources that are in motion, but is also of great benefit in obtaining stable, precise stereo imaging for normal music recordings.

This capsule type is therefore preferred for use as a support microphone as well as in the OCT (“Optimized Cardioid Triangle”) microphone system for surround sound recording introduced by Günther Theile of the IRT, Munich. (The front left and right channels in that system are picked up by sideways-facing supercardioid microphones; see page 132 in the technical appendix to this catalog.)

When mounted on CMC amplifiers, the MK 41V may be easier to use in near-coincident setups than the MK 41 because the parallel microphone bodies will not get in each other’s way.

Length: 34 mm
Diameter: 20 mm
Weight: 18 g

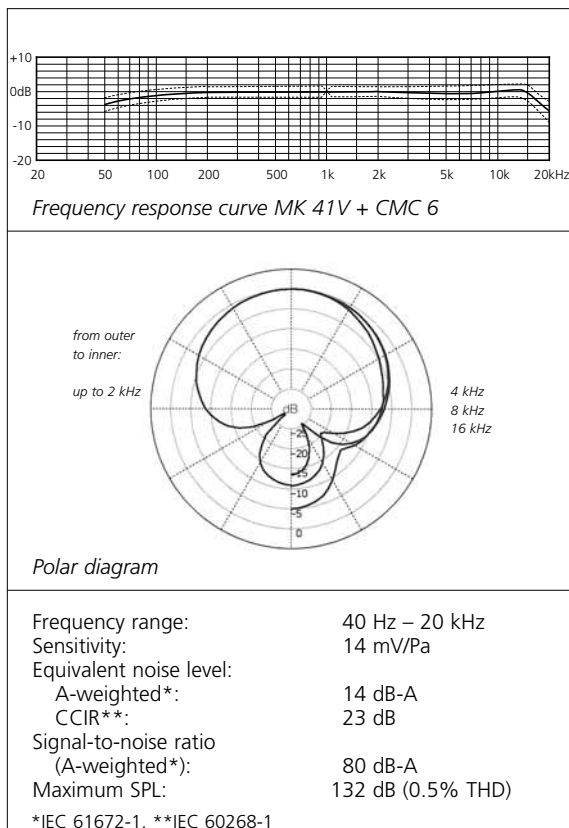



Microphone Capsule MK 8

- pure pressure-gradient transducer
- figure-8 pattern with near-ideal consistency across the frequency range
- side-addressed (pickup perpendicular to the microphone body)
- optimal for use in M/S and Blumlein stereo recording

This capsule type is a true dipole (bidirectional) transducer, operating with a single diaphragm. Its main axis is at a right angle to the capsule, and is marked at 0° and 180° with a red and a black dot respectively.

When M/S stereo recordings are made, the 0° axis normally faces to the left as viewed from behind the microphone setup. The "8" engraved on the top of the housing should be aligned on its side so as to appear horizontal, at a precise right angle to the Mid capsule. The microphone should be placed directly above or beneath the "M" channel microphone, and as close to it as possible.

The inherent qualities of a pure pressure-gradient transducer are readily observed in this capsule type:

- Its sensitivity decreases at low frequencies.
- The directional characteristic is extraordinarily independent of frequency.
- Proximity effect is present.

The sound quality of the MK 8 is clear and neutral. The frequency response rolls off above 16 kHz.

When an MK 8 is used as a spot microphone, care must be taken to avoid picking up early reflections or unwanted direct sound from its rear, since sound arriving from the back is picked up with full level but reversed in polarity. This could result in partial cancellation of the intended sound, which can lead to comb-filter effects at higher frequencies.

The directivity index of a figure-8 pattern is the same as that of a cardioid; if microphones with these two patterns are placed at the same distance from a sound source, a quantitatively similar balance of direct and reverberant sound would be picked up. In practice such a comparison would be deceptive, however, since a figure-8 does not respond to sound coming from the sides, from above or from beneath its main axis as does a cardioid. The figure-8 has a rear lobe equal in sensitivity to its front lobe, and this exactly makes up the quantitative difference – but in normally reverberant settings, the sound reaching a figure-8's rear lobe will be delayed and dispersed to a considerably greater extent than the reverberant sound energy which a cardioid picks up from its front and sides; the reflected sound will typically be subject to far more high frequency absorption as well. Thus the reverberant sound energy picked up by a figure-8, though theoretically equal in amount, is quite different in character from that which would be picked up by a cardioid in the same position.

figure-8



COLETTE modular

Length: 34 mm
Diameter: 20 mm
Weight: 18 g

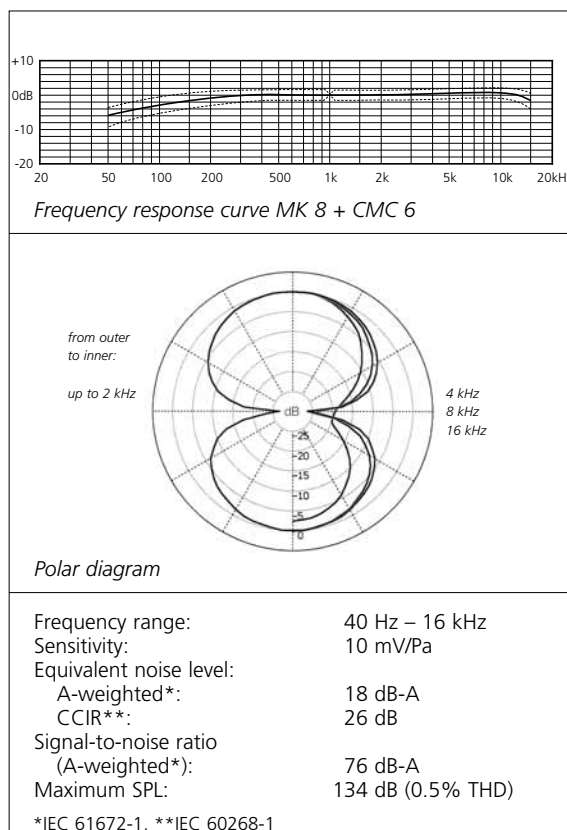



switchable



Microphone Capsule MK 5

- omni and cardioid patterns, mechanically switchable
- slight emphasis of the high frequencies
- broad range of applications
- preferred uses similar to those of the MK 2 or MK 2S and the MK 4:

In the cardioid setting: for use with singing or speaking voices or most instruments, as a spot microphone, and for stereo recording with coincident, ORTF or M/S microphone arrangements.

In the omnidirectional setting: for recording instruments, singers, etc. at relatively close range

The MK 5 offers two selectable directional patterns, but uses only one membrane – a no-compromise approach. The fact that full response is maintained to the highest audible frequencies is unusual for a switchable-pattern microphone.

In its omnidirectional setting the MK 5 is a true pressure transducer with smooth, extended low-frequency response, low sensitivity to most wind and breath noise, handling noise or mechanical vibration, and no proximity effect.

Unlike conventional, dual-diaphragm multi-pattern microphones, its cardioid setting retains its full directionality even at very low frequencies. The benefits of this design in purity and clarity of sound are immediately audible.

The MK 5 has a slight high-frequency emphasis as compared with the corresponding single-pattern omni (MK 2) and cardioid (MK 4).



The MK 5 is nearly an all-purpose capsule. It is what we recommend for those starting out with the Colette series, unless particular circumstances (such as the need for greater directivity or a bidirectional pattern) would indicate a different choice.

(Please note: The pattern selector should be definitely set to one position or the other; in-between settings will yield undefined results.)

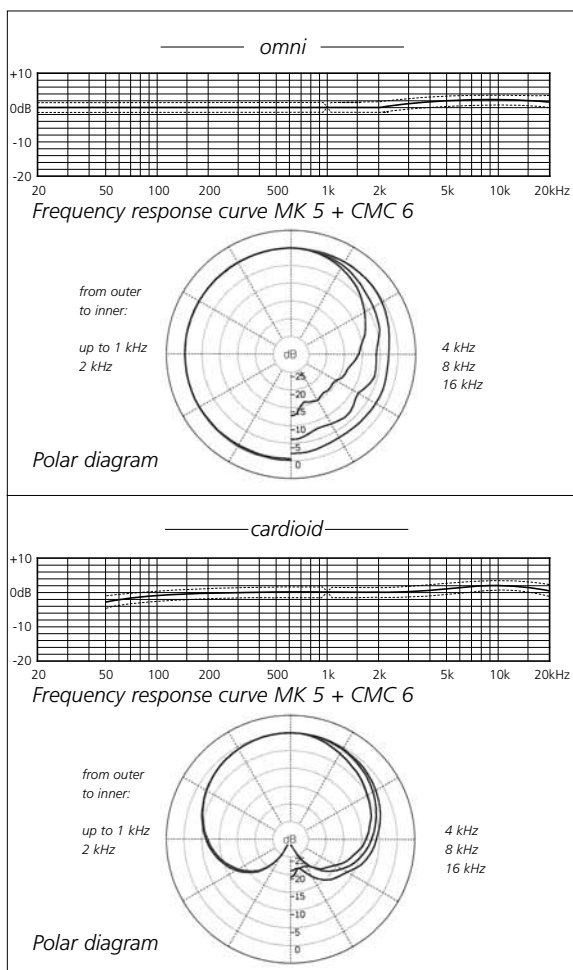
Length: 27 mm
Diameter: 20 mm
Weight: 25 g



A frequency response graph for this capsule with the CMC 6 xt or CMD 2 xt amplifiers is shown on page 135.

		
Frequency range:	20 Hz – 20 kHz	40 Hz – 20 kHz
Sensitivity:	10 mV/Pa	13 mV/Pa
Equivalent noise level:		
A-weighted*:	14 dB-A	15 dB-A
CCIR**:	26 dB	24 dB
Signal-to-noise ratio (A-weighted*):	80 dB-A	79 dB-A
Maximum SPL (0.5% THD):	133 dB	132 dB

*IEC 61672-1, **IEC 60268-1

Microphone Capsule MK 6

- omni, cardioid and figure-8, mechanically switchable
- very broad range of applications
- main axis: lateral (perpendicular to the microphone body)
- the most nearly “universal” capsule in the Colette modular system

The MK 6 operates with a single diaphragm. When the ribbed cap of the capsule is rotated, a system of internal shutters alters the acoustic chambering around the diaphragm to change its characteristic from omni to cardioid to figure-8.

In the omnidirectional setting the MK 6 is a true pressure transducer with flat response down to the lowest frequencies. (Other manufacturers use two diaphragms to achieve a switchable pattern arrangement. But that causes the “omnidirectional” setting to behave as a pressure-gradient transducer, with greater vulnerability to solid-borne sound and proximity effect, while failing to produce the full low-frequency response of a pressure transducer. It also causes the cardioid pattern to lose directivity at low frequencies.) In the cardioid setting, the MK 6 closely resembles the MK 4V, while in the figure-8 setting it resembles the MK 8.

As with the MK 8, the 0° axis is perpendicular to the body of the capsule and is indicated by a red dot at the lower rim of the capsule. A black dot marks the 180° direction.

Length: 39 mm
Diameter: 20 mm
Weight: 23 g



	20 Hz – 16 kHz	40 Hz – 16 kHz	40 Hz – 16 kHz
Frequency range:	20 Hz – 16 kHz	40 Hz – 16 kHz	40 Hz – 16 kHz
Sensitivity:	10 mV/Pa	11 mV/Pa	10 mV/Pa
Equivalent noise level:			
A-weighted*:	14 dB-A	16 dB-A	18 dB-A
CCIR**:	26 dB	26 dB	27 dB
Signal-to-noise ratio (A-weighted*):	80 dB-A	78 dB-A	76 dB-A
Maximum SPL (0.5% THD):	135 dB	134 dB	134 dB

*IEC 61672-1, **IEC 60268-1

switchable

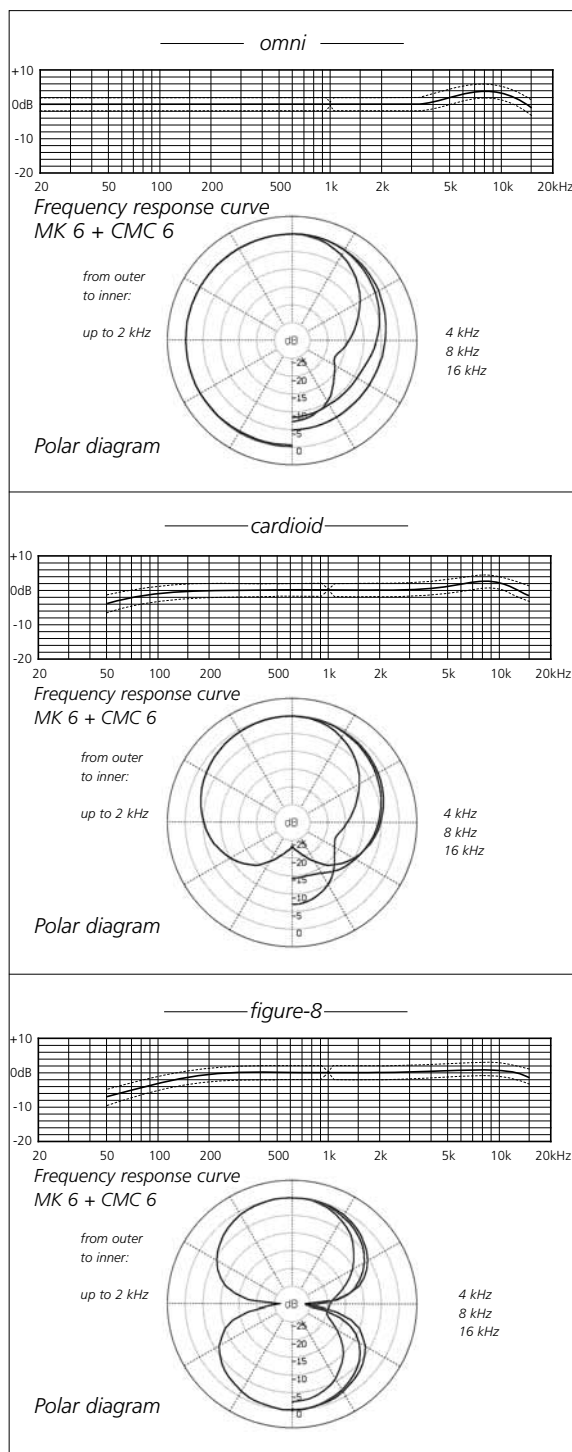



*Jazz saxophonist Jan Garbarek with CMC 64 microphone and B 5 D windscreen
Photo: Gert Rickmann-Wunderlich*



Microphone Amplifiers



	page
<i>... phantom-powered</i>	32
<i>... digital</i>	35
<i>with vacuum tube</i>	36
<i>battery-powered</i>	37
<i>for pocket transmitters</i>	39



MK_
microphone capsule **CMC 6Ug**
microphone amplifier



Type designation of a complete microphone:

CMC 64 Ug

6	powering	12 V ± 1 V and 48 V ± 4 V phantom
4	capsule type	MK 4
U	connector	XLR-3M
g	surface finish	matte gray, non-reflective surface finish



CMC 5Ug
for 48 V
phantom
powering

Microphone Amplifier CMC_

- flat frequency response
- extremely low noise and distortion
- balanced, very low-impedance output
- can be used with very long cables (several hundred meters)

The capsules of condenser microphones (the only type which we manufacture) can't be connected directly to microphone cables or inputs; a microphone amplifier is required in between. Thus a complete microphone of the Colette series comprises any of the twenty available types of capsules combined with an amplifier (e.g. a CMC_).

The microphone amplifier provides the electrostatic charge which the capsule requires in order to produce a signal. Since only a miniscule amount of current is contained in this signal, amplification of the current is required. To avoid interference to the signal on the way from the microphone to the input of the mixer or preamp, the signal is conveyed at low impedance and in balanced form. CMC amplifiers offer a symmetrical, transformerless, direct-coupled Class A output stage with low impedance, low distortion, and high freedom from interference.

Powering Condenser Microphones

Since microphone amplifiers are electrically active, they require a source of operating current. The prevailing standard method for providing such current is known as "phantom powering." There are two implementations: the 48-Volt version (which is widely used) and the 12-Volt version, which is less often encountered.

We offer two microphone amplifier versions: the more recent model CMC 6 (for standard 48- and 12-Volt phantom powering) and the older model CMC 5, which is exclusively for use with 48-Volt phantom powering.

The circuitry of the CMC 6 recognizes the supply voltage and adjusts itself automatically. Its performance characteristics remain essentially the same either way; mainly, the difference is that the current drawn at 12 Volts is greater than at 48 Volts. However, the 12-Volt mode is more efficient and might be preferred for battery-powered recording.

CMC 5 or CMC 6? – A Guide for the Choice

The CMC 6 offers greater flexibility with regard to powering as well as higher immunity to any radio-frequency interference which may be radiated into a microphone cable. For installations in which 48-Volt powering will always be provided and in which RFI is not an issue, the model CMC 5 is available.

With regard to audio quality the difference between the CMC 5 and CMC 6 is quite small, and concerns only the very lowest audio frequencies. The standard versions of both amplifiers contain filters to guard against inaudible infrasonic disturbances which could lead to overload in a preamp or mixer, particularly if it



has input transformers. The filter in the standard version of the CMC 6 has a corner frequency of 20 Hz and a slope of 12 dB/octave, while in the standard version of the CMC 5 this filter has a corner frequency of 30 Hz and a slope of 6 dB/octave (but please see the following section on variant versions).

Variant Amplifier Versions

Special versions of the CMC 5 and/or CMC 6 are available with different gain (amplification factor) or extended frequency range. Either type of amplifier can be specially ordered, or retrofitted at the factory, to have a different (e.g. lower) low-frequency limit from the standard version (see, for example, the "linear" version listed below).

Please note:

The two amplifiers in a stereo pair of microphones should be of the same type.

On request, we can select "matched pairs" of capsules with equal sensitivity and frequency response for critical applications, at slight additional cost.

CMC "linear"

CMC microphone amplifiers normally have a gradual rolloff in response below 30 Hz (20 Hz in the CMC 6) to guard against infrasonic disturbances from various sources such as air movement and vibration. However, when using pressure (omnidirectional) transducers, particularly with digital recording, it can be desirable to pick up frequencies below 20 Hz without attenuation. The special technology of the CMC microphone amplifiers makes this possible; on request we can deliver microphone amplifiers with response that is flat to as low as 3 Hz.

Caution must be advised with respect to infrasonics, however. Since pressure transducers can pick up very low frequencies, ventilation systems in large spaces (churches, concert halls) or traffic rumble can create a problem. With pressure gradient transducers the risk is even greater. They are far less sensitive to very low frequency sound, but respond much more strongly to low-frequency mechanical stimuli such as air currents and solid-borne noise. Such signals may be below the audible range of frequencies, but they can overload electronic circuitry and produce severe distortion, particularly in transformer-coupled circuitry.

CMC 6 Uxt – the 40 kHz Version

This version is indicated by the letters "xt" engraved on the microphone's output socket as shown at right. It extends the frequency response of the axially addressed Colette capsules beyond 40 kHz.

The frequency response curves on these pages were obtained with standard CMC amplifiers such as the CMC 6. Curves obtained with the CMC 6xt (special

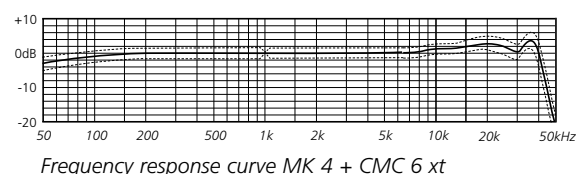



amplifier version with extended high-frequency response) are shown on page 135.

CMC "+5 dB"

The sensitivity of a microphone using this type of amplifier is 5 dB higher than with the standard version, but the equivalent noise level and maximum output voltage are not materially affected. Thus the highest sound pressure level which the microphone can accept without distortion is 5 dB lower than in the standard version, while the signal-to-noise ratio is essentially the same with either gain setting.

This version might be chosen in order to raise the microphone's signals above the noise level of the equipment to which it will be connected, and/or for working with sounds that occur mainly at low levels.

Current consumption of microphones :

The current required by the SCHOEPS class "A" output circuit falls well within the 10 mA limit set by the prevailing standard (DIN EN 61938, July 97). However, certain commercially available power supplies, preamplifiers, and mixing desks – mostly older, but some more recent – may fail to meet this standard. Such units may not be able to power SCHOEPS microphones adequately, especially where headroom at high SPL is desired. Where doubt exists, equipment should be checked to verify its suitability for professional work with SCHOEPS microphones.

The PHS 48 accessory test plug can be helpful in testing equipment quickly and easily to see whether it is compatible with SCHOEPS 48-Volt phantom-powered microphones.



Accessories (included with all CMC versions):

polished wood case for two microphones, SG 20 stand clamp with swivel

Technical Specifications:

Amplifier type	Powering	Current consumption	Impedance	Low-cut frequency (-3 dB)
CMC 6, -6xt:	12 V ± 1 V phantom	8 mA	25 Ohms	20 Hz
	48 V ± 4 V phantom (automatically switched)	4 mA	35 Ohms	20 Hz
CMC 5:	48 V ± 4 V phantom	4 mA	35 Ohms	30 Hz
Maximum output voltage:	1 V (at 1 kHz and 1 kOhm load resistance)			
Minimum recommended load impedance:	600 Ohms (If a lower load impedance is used, the main effect will be to reduce the maximum output level of the microphone.)			
Length:	116 mm (incl. 3 mm capsule thread)			
Diameter:	20 mm			
Weight:	CMC 5: 63 g; CMC 6/6xt: 60 g			
Surface finish:	matte gray (g) or nickel (ni) Other surface finishes available on request.			



Digital Microphone Amplifier CMD 2U

- for digital inputs that implement the AES 42-2006 standard
- for use with any and all microphone capsules of the SCHOEPS "Colette" system
- can be used with all SCHOEPS Active Accessories (extension tubes, cables, goosenecks and CUT filters)
- offers freedom from analog interference
- designed for highest-quality music recording, but also ideal for ENG and conference applications
- only 100 mA current consumption (digital phantom powering as specified by AES 42-DPP, 10 Volts)
- handles the full dynamic range from the noise floor to the absolute SPL limit without adjustment



The digital amplifier CMD 2U seamlessly extends the SCHOEPS "Colette" modular microphone system. Instead of 48-Volt phantom powering, it operates with the standard digital phantom powering of an AES 42-type digital input. Sonically it is fully the equal of SCHOEPS' CMC-series analog microphones, but the internal A/D conversion eliminates analog interference and signal losses either in the cable or at the inputs of analog preamps and mixers.

The CMD 2U was nominated in 2005 for the "mipa" (Musikmesse International Press Award).

CMD 2Uxt – the 40 kHz Version

This version has frequency response to 40 kHz and beyond, and can be used with any SCHOEPS "Colette" capsules that are axially addressed rather than side-addressed.

Special marking: the letters "xt" engraved on the back of the connector housing.

Standard surface finish: matte gray (g)

Accessories (included):

polished wood case for two microphones, SG 20 stand clamp with swivel

Technical Specifications

Microphone amplifier CMD 2U, measured with MK 2S capsule (omnidirectional)

Dynamic range:	115 dB (A-weighted, RMS)*; 103 dB (CCIR, quasi-peak)**
Sample word length:	24 bits
Sampling rates (set internally):	44.1 kHz or 48 kHz, 88.2 kHz, 96 kHz, 172.4 kHz, 192 kHz
Synchronization:	none (operating mode = AES 42-2001, Mode 1); multi-channel applications require inputs with sampling rate conversion
Powering:	AES 42-DPP, 10 Volts, 100 mA
Input type required:	AES 42 (i.e. AES 3 with AES 42-DPP digital phantom powering)
Maximum cable length:	for ordinary microphone cable: 100 meters with 110 Ohm AES-3 cable: > 400 meters
Sensitivity at the standard level of 94 dB SPL:	-34.5 dBFS
Maximum SPL:	128 dB
Equivalent noise level:	15 dB (A-weighted, RMS)* 27 dB (CCIR, quasi-peak)**
Output configuration:	XLR-3M, AES 3, 110 Ohm characteristic impedance
Dimensions:	Length: 116 mm (incl. 3 mm threading for the capsule) Diameter: 20 mm

*IEC 61672-1, **IEC 60268-1



COLETTE
modular



M 222 with
MK 4 micro-
phone capsule

Tube Microphone M 222 Powering Units NT 222 DC and NT 222 AC

– made exclusively for SCHOEPS by **eloo**

The model M 222 is based on the name of the legendary SCHOEPS tube microphone M 221 B. However, its circuit design does not merely recycle techniques from the sixties; rather, it unites a first-quality tube with fully up-to-date circuitry. For example the audio signal path is transformerless, and the overall specifications and performance have been significantly improved.

The dimensions and fittings of the M 222 amplifier are the same as those of the CMC series. Any capsules of

the Colette series can be used (including the BLM 03 Cg) as well as all Active Accessories such as the CUT, KC, RC and GVC.

The M 222 can be ordered with two different powering units. With the NT 222 DC, an AC adapter is supplied but portable operation from an external 12-Volt supply (e.g. car battery) is possible as well; the output is also switchable to line level.

The NT 222 AC has identical dimensions, but its mains transformer is internal and the output is not switchable to line level. Thanks to its universal output circuitry it can be used with any microphone input, whether phantom powered or not and whether balanced or not. When connected to 48 V phantom power ("P48 ON"), cable runs up to 200 m can be used. "HARMONICS" (see below) is adjustable in five steps.

The power supply offers a "TUBE DIRECT" switch setting in which there are no semiconductors in the signal path whatsoever. A "HARMONICS" switch alters the Q-point of the tube, causing the gradual increase of harmonics to set in earlier, to emphasize the typical "tube sound."

Visit **eloo**: www.M222.de

Supplied equipment:

- transport case with:
- tube microphone M 222
- microphone cable KS 5U, 5 m long
- powering unit NT 222 DC or NT 222 AC
- popscreen B 5
- stand clamp with swivel SG 20
- only with NT 222 DC: miniature mains adapter, 90 – 260 V

Capsules must be ordered separately.

Technical Specifications:

M 222:

- Dimensions: diameter: 20 mm,
length: 116 mm (without capsule)
- Output connector: XLR-5M (gold-plated contacts)
- Maximum SPL: 142 dB-SPL (k=0.5%, with MK 2S
and without attenuation)
- Output: transformerless, balanced
- Surface finish: matte gray (g), nickel (ni)

NT 222 DC and NT 222 AC

- Dimensions: 105 mm × 50 mm × 140 mm
- Input: XLR-5F, balanced
- Output: XLR-3M (balanced, can be operated
in unbalanced mode without loss
of level)
- Max. output level: DC: 9.5 V_{rms} (+19.6 dBV)
AC: 3 V_{rms} (+9.5 dBV)
- Max. cable length: more than 100 m, (TUBE DIRECT:
40 m total length)
- Switches: ON/OFF, FILTER 150 Hz (6 dB/Oct),

HARMONICS (for more "tube sound"),
(DC: 1 step, AC: 5 steps)

NT 222 DC:

- Further switches: FILTER 60 Hz (12 dB/Oct), GROUND
LIFT, GAIN (-10 dB(Tube Direct)/0/10/20/30 dB)
- Powering: with miniature mains adapter (included) or
other mains adapters offering 12 VDC, ca. 300 mA,
may be unstabilized (internal switching regulator);
galvanic isolation from ground (switchable)

NT 222 AC:

- Further switches: ATT -10 dB, BAL. /UNBAL, P48
(activates cable driver, for cable lengths up to 200 m;
requires 12 V or 48 V phantom powering)
- Powering: 90 – 260 V AC powering

KS 5 U:

- XLR-5 microphone cable for use with NT 222 DC and
NT 222 AC, 5 m long, low capacitance, flexible,
100% shielded, gold-plated contacts

Battery-powered Microphone Amplifier CMBI

- unbalanced, medium-impedance output
- for mobile recording applications with short cables (a few meters)
- for connection to any desired microphone input, e.g. pocket or other portable recorders or “wireless microphones” (transmitters)

If a recorder has no phantom powering or a microphone input is unbalanced as in many portable recorders and wireless microphone transmitters, a phantom-powered microphone can be awkward to use. For these and other situations SCHOEPS offers the CMBI, a battery-powered microphone amplifier with unbalanced output.

Combine this with one of 19 microphone capsules of the Colette series and you obtain a microphone which is acoustically equivalent to the balanced version using a CMC microphone amplifier.

The CMBI is powered by a readily available internal 6 V silver oxide battery which, combined with power-saving circuitry, gives up to 80 hours of operation. About 6 hours before the end of battery life, a built-in LED begins to light up as a warning.

In addition to battery operation, the CMBI allows for external powering through the output cable. (The included K 5 ISK cable is not suitable for this mode of operation.)

Because of this model's unbalanced, low-level output and its medium output impedance, the total cable length should be kept to less than about 15 m to avoid possible RF interference and impaired performance.

Possible arrangements for connecting the CMBI are shown on the following page.

Accessories (included):

polished wood case, SG 20 stand clamp with swivel, battery, adapter cable K 5 ISK (miniature plug to 3.6 mm mini stereo phone plug, 5 m long)

Accessories (optional):

microphone capsules, windscreens, etc.

Please note:

Neither Colette series Active Accessories nor the BLM 03 Cg can be used with the CMBI.



CMBIg
with matte gray
surface finish





Battery-powered Microphone Amplifier CMBI

Instead of a large XLR connector, the CMBI has a flush-mounted 5-pin miniature connector at the output which also allows for external powering. For normal connection of the CMBI to a DAT recorder, etc., a 5 m cable with a 3.5 mm mini stereo plug is included (see Fig. 1 below).

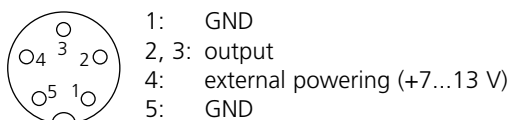

This cable can be extended with a standard 3.5 mm stereo jack to stereo plug cable, or with a miniature-connector extension cable such as SCHOEPS KS 5 I (Fig. 2).

For operation with pocket transmitters we have ready-made cables with special connectors on request (Fig. 3).

For stereo recordings there is a Y-shaped cable (KIY 250/0 I) which connects two CMBI to a compact junction box by means of two pieces of cable, each 250 mm in length. The short cable leading out of this box has a miniature connector and can be extended either with the K 5 ISK cable (Fig. 4) or with the extension cable KS 5 I.

Technical Specifications:

Sensitivity and equivalent noise level:
depends on capsule, see page 134
Maximum output voltage:
"0 dB" - setting: 700 mV
"-15 dB" - setting: ca. 140 mV
Maximum sound pressure level at 0.5% THD
(capsule- and load-dependent):
switch setting "0 dB":
 $R_L \geq 10 \text{ k}\Omega$: $\geq 130 \text{ dB-SPL}$
 $R_L = 1 \text{ k}\Omega$: ca. 120 dB-SPL
switch setting "-15 dB":
at least 130 dB-SPL

Output: unbalanced, impedance:
in setting "0 dB": 500 Ohms
in setting "-15 dB": 300 Ohms

Switches: combined on/off/attenuation switch with
three settings: on (0 dB)/off/on (-15 dB)

Powering:
internal: 6 V silver oxide battery (e.g. IEC 4 SR 44),
maximum battery life: 80 h
External powering: 7 – 13 VDC, 1.7 mA

Output connector: 5-pin miniature

Diameter: 20 mm

Length without capsule: 92 mm

Weight: 72 g

Surface finish: matte gray (g) or nickel (ni)

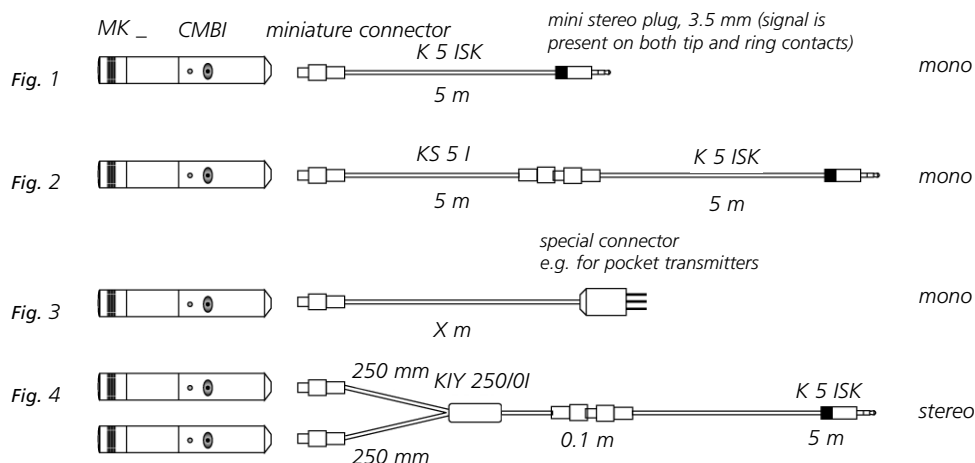

Possibilities for connecting the CMBI



Microphone Amplifier for Pocket Transmitters CMR

- specially designed for using SCHOEPS "Colette"-series microphone capsules with pocket transmitters
- low power consumption: only about 1/20 to 1/50 that of a phantom-powered microphone
- low-impedance, unbalanced output

A SCHOEPS Colette-series condenser microphone normally consists of a CMC microphone amplifier plus one of the many available types of SCHOEPS Colette-series microphone capsule, operating from a source of 12-Volt or 48-Volt phantom powering. However, such powering is not available when the microphone is used with a pocket transmitter, as is often the case in film and television production. In this situation the CMR microphone amplifier can be used. It allows any SCHOEPS "Colette" series capsule (except the BLM 03 C active boundary layer capsule) to be used with pocket transmitters. As with electret microphones only a very low supply current is required, yet the CMR offers low output impedance and good immunity to interference. The biggest benefit of all, however, is SCHOEPS' well-known sound quality, which this amplifier delivers fully.

The robust connecting cable is reinforced with Kevlar fibers. It remains flexible at low temperatures, and does not twist.

What types of equipment can the CMR be used with?
If the input of the equipment provides 1 mA for a microphone at 4 Volts or higher, the equipment should be suitable.

The current list of compatible devices is available on www.schoeps.de/data/CMR-compatibility.pdf. At the time of publication of this catalog, the following models were on this list:

- Audio Ltd.: MiniTX, TxiR, TX200+Envoy
- Lectrosonics: SM "+10", UM 300 B, UM 500
- Shure: UHF U1, UHF U1L, UHF ULX1



CMR, actual size

- Sennheiser: SK 50 (not SK5212)
- Micron: TX 700, TX 716A
- Wiscom: MTP 22

If in doubt, simply ask your SCHOEPS representative or dealer.

Output cable

In many cases you would only have to tell us the type of equipment and the desired cable length. We could then make up an output cable for you with the proper wiring and plug.

Lead arrangement of the two-conductor shielded cable:
Shield: ground (both signal and powering)
Blue: + pole of the power supply
White: audio output

Standard surface finish: matte gray (g)

Accessories (included): polished wood case

Technical Specifications:

Operating voltage:	4 - 10 Volts DC
Current requirement:	ca. 1 mA
Sensitivity:	ca. 0.6 times the value as measured with a standard CMC microphone amplifier. For example with the MK 4 cardioid, the sensitivity is about 8 mV/Pa, the maximum sound pressure is 130 dB SPL and the equivalent input noise is 29 dB CCIR** or 18 dB A-weighted*.
Frequency response:	The frequency response characteristic will be that of the capsule which is chosen.
Maximum output voltage:	900 mV with 20 kOhm load impedance (ca. -1 dBV) 560 mV with 2 kOhm load impedance (ca. -5 dBV)
Output impedance:	15 Ohms at 1 kHz
Length:	38 mm (not counting rubber cable bushing and capsule)
Diameter:	20 mm
Weight, without cable or capsule:	25 g (0.88 oz.)
Length of the output cable:	2 m standard; other lengths possible
Diameter of the output cable:	3 mm
Output connector:	The connector is wired to the customer's specifications.

*IEC 61672-1

**IEC 60268-1



By gracious permission of Maier Sound Design GmbH, Kamen



Accessories for the Modular System



	page
<i>Active Accessories</i>	42
<i>Other Accessories</i>	45



COLETTE
modular



*MK _ microphone capsule
KC 5g Active Cable
CMC microphone amplifier (pg. 31)
TCg table stand (pg. 66)*



*Special version:
WKC 5g = KC 5g KC 5g with right-angle connector*

Active Colette Cables KC, WKC

Active Colette Cables may be inserted between any capsule of the Colette modular system and the microphone amplifiers CMC, CMD 2U and M 222.

We recommend that the length not be excessive for the anticipated use, to avoid radio-frequency interference from sources such as SCR-equipped lighting boards. Greater than the standard cable length of 5 m may be required when hanging a microphone from a ceiling, but we do not recommend runs in excess of 20 m since the circuit up to the microphone amplifier is unbalanced.

The cable itself is highly resistant to stretching, bending and abrasion. Moreover it does not tend to twist after being suspended, even with temperature changes. This is of importance, e.g. when the microphone is hung from the ceiling.

Type designation: KC 5g: 5 m long
KC 10g: 10 m long

Special lengths can be ordered.

COLETTE
modular

Details: see page 55 ff. Here we show some examples



*TR 200 KC
Active Desk Stand*



RC Active Extension Tube



*SRSKC 420g
Active Gooseneck*



*RC Active
Extension Tube*



Active Stereo Cable KCY for MK Capsules

for stereo microphone amplifier VST 62 IUg or stereo microphone preamplifier VMS 5 U

Due to its unbalanced signal arrangement, the output cable should be no longer than necessary. If longer cables (up to several hundred meters) are required, the VST 62 should be connected to a relatively short KCY arrangement; it has balanced, low-impedance outputs and can drive very long cables without interference.

Standard lengths:

KCY 250/0 Ig: input cable: 250 mm; output cable: 10 cm only, for use with an extension cable (e.g. KS 5); 5 m long)

KCY 250/5 Ig: input cable: 250 mm; output cable: 5 m for direct connection without an extension cable

Other lengths are available on request.



KCY with HSGMSC cable hanger for M/S

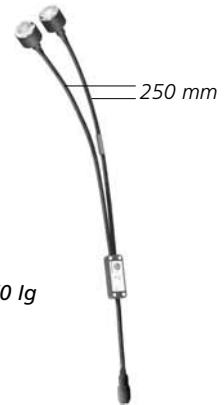

KCY 250/0 Ig

5-pin Binder miniature plug (I)

Phantom-powered Stereo Microphone Amplifier VST 62 IUg

- for stereo recordings with the Active Stereo Cable or the RCY Active Stereo Extension Tube (for M/S stereo)
- for 12/48 V phantom powering
- suitable for microphone cables of up to several hundred meters

Surface finish: matte gray (g)

Accessories (optional):

K 30 STR stand support clamp for microphone amplifiers, for attaching the VST 62 IUg to any 12 mm rod (e.g. STR vertical support rod)

Mounting accessories for M/S, ORTF, X/Y: see page 82 ff.



VST 62IU

K 30 STR

M/S microphone arrangement with RCY 1200 Active Stereo Extension Tube and VST 62 stereo microphone amplifier

Technical Specifications:

Acoustical specifications: as stated for the MK microphone capsules with the CMC 6 microphone amplifier (page 134).

Phantom powering: 12 V \pm 1 V and 48 V \pm 4 V (automatic changeover)

Current consumption per channel: 4 mA, independent of the powering voltage

Maximum output voltage at 0.5% THD: 950 mV (at 1 kHz and 1 kOhm load impedance)

Impedance: 60 Ohms

Minimum recommended load impedance: 600 Ohms

Low-cut frequency (-3 dB): 20 Hz

Maximum cable length: several hundred meters; depends on the cable specifications

Length: 170 mm

Diameter: 30 mm

Weight: ca. 230 g

Output connector: XLR-5 (pin assignment see pg. 133)

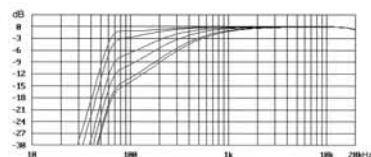

Frequency response of the CUT 1 at various settings of the control

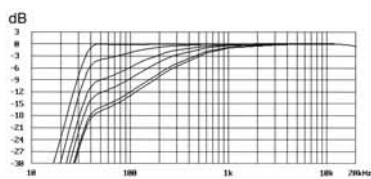

Frequency response of the CUT 2 at various settings of the control



Variable Low-Cut Filters CUT 1, CUT 2

- can be screwed onto the CMC, CMD or M 222 microphone amplifiers
- very effective suppression of low-frequency and infrasonic effects of wind and vibration: 24 dB/oct below 60 Hz (CUT 1) or below 30 Hz (CUT 2)
- user-adjustable variable rolloff
- offsets proximity effect

The CUT 1 or CUT 2 is inserted between the capsule and the microphone amplifier. The CUT filter performs two tasks:

First, it prevents the effect of infrasonic disturbances from being passed on to any succeeding device.

In particular, pressure-gradient transducers (directional microphones) produce very high infrasonic signal levels when exposed to wind. These can saturate an input transformer or an amplifier stage even before the audible portion of the disturbance becomes noticeable.

To avoid this, a very sharp (24 dB/oct) infrasonic filter is permanently engaged. It has only a negligible effect on speech, which is the principal field of application for the CUT 1 (cutoff frequency = 60 Hz). The CUT 2's infrasonic filter is an octave lower (i.e. 30 Hz), and has no audible effect on speech pickup whatsoever.

The **second task** is to offset proximity effect and/or to improve speech intelligibility in reverberant rooms by means of an additional 6 dB/oct rolloff. By turning a recessed thumbwheel the user can vary the frequency at which this begins to have an effect, and thus tailor the low-frequency response as required. Its turnover frequency can be continuously varied between 30 Hz (CUT 2) or 70 Hz (CUT 1) and 600 Hz (see response curves, above right).

Of course it is to be expected that filters such as the CUTs will affect the naturalness of the sound picked up by the microphone. But in many cases the CUTs (in combination with the appropriate windscreens W 20 and W 20 R1, the diameter of the CUTs have a slight step near their front ends.

Since the weight of a microphone increases with the addition of a CUT, the stiffer elastic suspension A 20 S is required.

The CUTs raise the sensitivity of standard microphone amplifiers by 5 dB, while those marked with "+ 5 dB" will retain their increased sensitivity.

The CUTs raise the sensitivity of standard microphone amplifiers by 5 dB, while those marked with "+ 5 dB" will retain their increased sensitivity.

Dimensions: length: 64 mm, diameter: 20/21 mm
Weight: 50 g
Surface finish: matte gray (g) or nickel (ni)

Capsule Swivel GVC

- allows the angle of a capsule to be adjusted on all microphone amplifiers of the Colette modular system
- adjustable from 0° through 120° in either direction

The electrically passive GVC capsule swivel may be inserted between any capsule and microphone amplifier of the Colette modular system, or before an Active Cable, Active Extension Tube, or the CUT 1.

This is especially useful with capsules intended for frontal sound pickup such as the MK 4 (cardioid).

Maximum length: 64 mm
Diameter: 20/21 mm
Weight: 75 g
Surface: matte gray (g) or nickel (ni)

Laterally-addressed capsules (MK 4V, MK 41V, MK 4VXS, MK 6 and MK 8) can be used on the GVC with a small elastic ring which we will supply at no extra charge. This ring should be slipped over the threads of the GVC so that the capsule can be aimed in the desired direction.



MK _ microphone capsule
GVCg capsule swivel
CMC microphone amplifier (pg. 32)



Pads DZC 10, DZC 20

- ca. 10 or 20 dB constant attenuation
- raises maximum sound pressure level by ca. 10 dB/20 dB
- attenuates signal ahead of microphone amplifiers of the Colette modular system

Under extreme conditions, even a SCHOEPS Colette series microphone can be overdriven by very high sound pressure levels. Here the limiting factor is not the capsule but the microphone amplifier. The overload point ranges from 128 – 135 dB-SPL, depending on the capsule and the amplifier type (e.g. 5 dB lower with the "+5 dB" version).

In these situations the signal level at the amplifier input may be attenuated by inserting a DZC between the capsule and the microphone amplifier or the Active Accessories.

The use of two DZC 10 on one microphone will result in an attenuation of only ca. 15 dB due to the capacitive principle of operation. If the level must be attenuated by a full 20 dB, a DZC 20 should be used.

Dimensions: length: 18 mm, diameter: 20 mm
Weight: 14 g
Surface finish: matte gray (g) or nickel (ni)





Accessories for Stereo Recording:



MAB 1000 Microphone bar for spaced microphone stereo recording (see page 84)



STCg for ORTF stereo recording (see page 92)



UMS 20 for M/S, X/Y and ORTF stereo recording methods (see page 114)



AMS CI and *WSR MS CI* for M/S stereo recordings (see page 88)



COMPACT SYSTEM



System Overview 49 page

CCM Compact Microphones 50



CCM _L

CCM _U
(special version)



XLR-3M

COMPACT MICROPHONES CCM-L, CCM-U

- compact
- balanced output (Lemo/XLR-3M) as in the Colette modular series microphones (CMC)
- for 12/48 V phantom powering
- suitable for use with very long cables (up to ca. 300 meters, depending on the cable materials)

The CCM series offers a simpler alternative to the Colette series when there is no need to exchange capsules on a single amplifier. The capsules are identical to those of the Colette series, but each is built together with a highly miniaturized amplifier circuit into a single, inseparable unit. A CCM thus resembles a Colette-series capsule on the end of an Active Cable, but its output is a balanced, low-impedance signal which can be directly connected to a preamp, mixer input or recorder with 12 or 48-Volt phantom powering.

Two general varieties are offered. In the CCM _U type, a robust XLR cable is permanently attached to the microphone. The CCM _L type has a thinner, detachable XLR cable with a Lemo plug at the microphone end, which allows the use of certain special accessories that resemble Active Accessories of the Colette series.

The two general types:

CCM-L: The thin, removable connecting cable is sturdy and reliable. It terminates in an XLR-3 plug and features a miniature Lemo connector with a threaded collar, so that when it is connected to the microphone, nothing can rattle

CCM-U: special version which is lighter and 7 mm shorter; the XLR cable is heavier-duty and permanently connected to the microphone

Accessories (included):

polished wood case, SGC miniature stand mount with swivel (see on the right);
CCM L: K 5 LU adapter cable (Lemo/XLR-3M), 5 m long



SGC

Technical specifications: see page 54

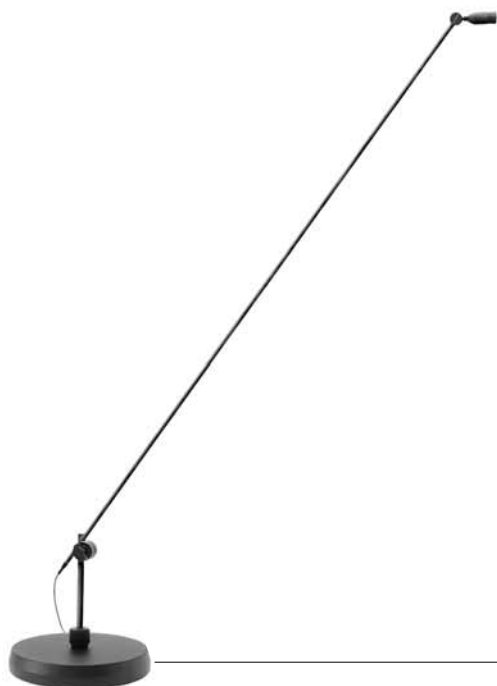

CCM _L compact microphone, e.g. CCM 4Lg (cardioid)
RL 1200g straight extension tube (RG 8 swivel included), pg. 59
STR 350g support rod, pg. 116
BF 250 floor stand, pg. 118

CCM_L

Compact microphone
(pg. 48 ff., 76 ff.)

adjustable-height stand
STV 900/1400 L3Ug, (pg. 58)

straight extension tube, e.g. **RL 700g**
(pg. 59)

straight extension tube for mounting in table surface
RLG 350 Ug
(pg. 62)

gooseneck for mounting in table surface
S 250 L5Ug
(pg. 62)

desk stand
TR 200 Lg
(pg. 65)

desk stand
TSR 200 Lg,
(pg. 65)

Stereo
see page 83 ff.

Y-cable **KLY I** (pg. 113)

Y-cable **KLY SU** (pg. 113)

adapter cable to XLR-5M:
KS 5IU (pg. 113)

AK SUI2U
adapter cable
XLR-5F
to 2 x XLR-3M
(pg. 112)

adapter cable
K 5 LU
(Lemo/XLR-3M,
included with
CCM_L)
(pg. 113)

low-cut filter
LC 60 U
or
LC 120 U
(pg. 110)

inline attenuator
MDZ
(pg. 111)



VMS 5 U, microphone preamplifier with MIS matrix
(pg. 106)

CCM_U

Compact microphone with permanently attached cable; (special version, pg. 48 and 76 ff.)



T2 CCM 4
movable twin table microphone, pg. 66



C2 CCM 4
twin table microphone, pg. 64

all signals shown above are balanced



CCM
compact



omni



CCM 2 Compact Microphone

- omnidirectional pattern
- flat frequency response
- for use close to the sound source (frontal sound incidence)
- often preferred for relatively close miking of instruments, vocalists, etc.

Technical specifications: pages 54 and 132



omni



CCM 2H Compact Microphone

- omnidirectional pattern
- mild high-frequency rise to compensate for losses at medium recording distance
- often chosen for “spaced microphone” stereo pickup and “Decca Tree” arrangements, often with the KA 40 sphere attachment being used



omni



CCM 2S Compact Microphone

- omnidirectional pattern
- slight high-frequency rise to compensate for losses at recording distance near the reverberation radius (page 130)
- for a very wide range of recording applications
- often preferred for “spaced microphone” stereo pickup and “Decca Tree” arrangements



CCM 3 Compact Microphone

- omnidirectional pattern
- diffuse-field capsule, for miking distances at which the predominant sound is no longer direct
- useful for relatively distant placement in reverberant environments – as a room microphone, for “spaced microphone” stereo pickup and in “Decca Tree” arrangements

Technical specifications: pages 54 and 132

omni



CCM
compact

CCM 21 Compact Microphone

- wide cardioid with especially consistent directionality throughout its frequency range
- pleasant sonic impression, often described as “warm”
- often preferred for use as a spot microphone, or as the main pair for overall stereo pickup

wide cardioid



CCM 21H Compact Microphone

- wide cardioid pattern with especially consistent directionality throughout its frequency range
- high-frequency elevation for brilliance of sound
- often preferred for use when recording vocals, acoustic guitar or percussion

wide cardioid





CCM
compact



cardioid



CCM 4 Compact Microphone

- classic cardioid, with consistent directionality throughout its frequency range
- suitable for the widest range of applications, either as a spot microphone or for stereo recording with coincident, ORTF or M/S microphone arrangements
- often preferred for singing or speaking voices and most instruments

Technical specifications: pages 54 and 132



cardioid



CCM 4V Compact Microphone

- “vertical” (side-addressed) cardioid capsule
- for a very wide range of recording applications
- slight high-frequency emphasis
- often preferred for singing or speaking voices and most instruments



supercardioid



CCM 41 Compact Microphone

- supercardioid with highly consistent directionality throughout its frequency range
- for music and speech
- high directivity, comparable to that of a short “shot-gun” microphone up through midrange frequencies
- often preferred for use in film sound recording and as a spot microphone in orchestras



CCM 41V Compact Microphone

- supercardioid with especially consistent directionality throughout its frequency range
- “vertical” (side-addressed) supercardioid capsule
- for a very wide range of recording applications
- high directivity, comparable to that of a short “shot-gun” microphone up through midrange frequencies
- often preferred for use in music and speech recording, as a spot microphone and also as a main microphone, especially when using the OCT recording method

Technical specifications: pages 54 and 132

supercardioid



CCM
compact

CCM 8 Compact Microphone

- pure pressure-gradient transducer
- figure-8 pattern with near-ideal consistency across the frequency range
- side-addressed (pickup perpendicular to the microphone body)
- optimal for use in M/S and Blumlein stereo recording

figure-8



CCM 5 Compact Microphone

- omni and cardioid patterns, mechanically switchable
- slight emphasis of the high frequencies
- broad range of applications
- preferred uses similar to those of the MK 2 or MK 2S and the MK 4:
In the cardioid setting: for use with singing or speaking voices or most instruments, as a spot microphone, and for stereo recording with coincident, ORTF or M/S microphone arrangements.
In the omnidirectional setting: for recording instruments, singers, etc. at relatively close range

switchable





CCM
compact

New!



Boundary layer recording with
BL CCM 3L

hemisphere



Boundary-Layer Microphone for fixed Installations BL CCM 3Lg

- unobtrusive
- avoids “comb filter” effect

This special version of the CCM 3L compact microphone is equipped with a flange enabling it to be built into the surface of a table or speaker's rostrum. This makes the microphone nearly invisible, and at the same time improves the sound quality by eliminating comb filter effects.

Technical specifications

Length: 45 mm, diameter: 28.6/20 mm

Weight: 49 g

For further specifications see below, and also page 132

Surface finish: matte gray (g)

hemi-cardioid



hemi-supercardioid



Accessory for CCM compact microphones

BLCg

mounting plate for directional boundary- layer recording with Compact Microphone CCM 4 (cardioid) or CCM 41 (supercardioid); 100 mm diameter

Surface finish: matte gray (g)

Technical Specifications for all CCM Types:

Powering:	12 V ± 1 V or 48 V ± 4 V phantom powering
Current consumption (automatically switched):	P12 : 8 mA, P48 : 4 mA
Source impedance:	90 Ohms
Minimum recommended load impedance:	600 Ohms
Low-cut frequency (-3 dB):	20 Hz
For all other specifications see page 134 or under the corresponding Colette capsules.	
Length U-version:	46 mm – 58 mm, type-dependent
Length L-version:	46 mm – 58 mm without connector
Diameter:	20 mm
Weight without cable:	U-version: 33 g, L-version: 43 g
Surface finish:	matte gray (g) or nickel (ni)
Standard length of the cable (K 5 LU):	5 m
Other lengths are available on special order, but the carrying case has room only for cables up to 10 m.	



Accessories by Application



	page
<i>Microphones on Stands</i>	56
<i>Microphone Stand</i>	58
<i>Extension Tubes</i>	59
<i>Table Mounting</i>	61
<i>Desk Stands and Boundary-Layer</i>	66
<i>Cable Hangers</i>	67
<i>Mounting on a Boom</i>	68
<i>Instrument Adapters</i>	69



COLETTE modular



Stand Clamp with Swivel SG 20

- for a microphone of 20 or 21 mm diameter (e.g. CMC, CMD, CMIT or CMBI)

The base of the SG 20 has a 5/8" -27 NS internal thread. A threaded adapter is supplied for 3/8" and 1/2" mounting. The angle can be varied continuously in the vertical plane.

Color: gray

COLETTE modular



Dual Stand Clamp SG 22

The angle between the microphones can be varied as well as the angle of inclination for the pair. However, the SG 22 is not suitable for stereo pickups because of the very limited range of angles and spacings possible between the microphones. It is primarily intended for holding a main microphone and a backup when extreme operational security is required.

In the mid-position (shown at left) the microphones are oriented perpendicular to the microphone stand. The angle of inclination is +90° to -90° from the mid position.

COLETTE modular



Dual Stand Clamp SG 22 MOD

Holds two microphones with 20 mm diameter in parallel alignment. Their distance can be varied from 4 mm to 52 mm, while they can be oriented parallel to the stand, perpendicular to the stand, or at any angle in between.

Certain "near-coincident" microphone arrangements for stereo recording can be created in this way. With a pair of CMC amplifiers placed upright side by side, laterally-addressed Colette directional capsules (the MK 4V, MK 41V, MK 6 and MK 8) can be used with any desired angle set between their main axes. The other directional capsules (the MK 4, MK 41 and MK 5) can be used with GVC angle adapters; even some coincident microphone setups are then possible.

COLETTE modular

CCM compact



SGCM
All-metal clamp with black chrome finish – stable construction with knurled screw for especially secure grip

SGC
Clamp made of gray plastic material – the unobtrusive standard version

Miniature Stand Mount with Swivel SGC, SGCM

- for CCM compact microphones or Active Cable with microphone capsule
- adjustable from 0° through 100° in either direction

The internal thread of the SGC or SGCM screws onto any 3/8" rod (e.g. vertical support rods STR) or stand adapter.

The SGC is an integral part of the HC miniature cable hanger and the TCg table stand.

Color: gray/black

Elastic Suspensions with Swivel *A 20 S, A 20*

- for a microphone of 20 or 21 mm diameter
(e.g. CMC, CMD, CMI or CMB)

The A 20 is recommended when only the microphone amplifier and a capsule are used, and maximum protection from vibration is desired, for example on a boom.

When accessories such as the CUT filters, GVC or S 250 Cg are added to the microphone, the stiffer elastics of the A 20 S are required.

A special clamp secures the microphone cable. This is necessary with the A 20 and advantageous with the A 20 S.

The microphone can be tilted to any angle.

Threads: 5/8" -27 NS with adapter for 3/8" and 1/2"
Color: gray



Elastic Double Suspensions *A 22 S, A 22*

The angle between the microphones can be varied as well as the angle of inclination for the pair. However, it is not suitable for stereo pickups because of the very limited range of angles and spacings possible between the microphones. This type of clamp is primarily intended for holding a main microphone and a backup when extreme operational security is required.

The A 22 S is the standard version. The A 22 has softer elastics.

Color: gray



Elastic Miniature Suspension with Swivel *AC*

- for CCM compact microphones or Active Cable with microphone capsule
- variable angle

Matching pop filter: B 1 or B 5. Not intended for use with larger, heavier windscreens.

Diameter: 61 mm; thread: 3/8"; color: gray





Adjustable-height Microphone Stand with Swivel STV 900/1400 L3Ug

- microphone stand for CCM _L COMPACT CONDENSER MICROPHONES
- adjustable to any angle at any time without unlocking
- height: 900 mm to 1400 mm
- angle range: 0° (vertical) to 120°
- angle of rotation: 360°
- tube diameters: 8 mm and 12 mm
- mounting: on 3/8" threaded studs or 12 mm chucks (e.g. SCHOEPS floor stand BF 250)
- minimum cable length (at maximum height of the STV): 3 m; other cable lengths are available on request.
- output connector: XLR-3M

Surface finish: matte gray (g)

Recommended popscreens: B 1 D or B 5 D

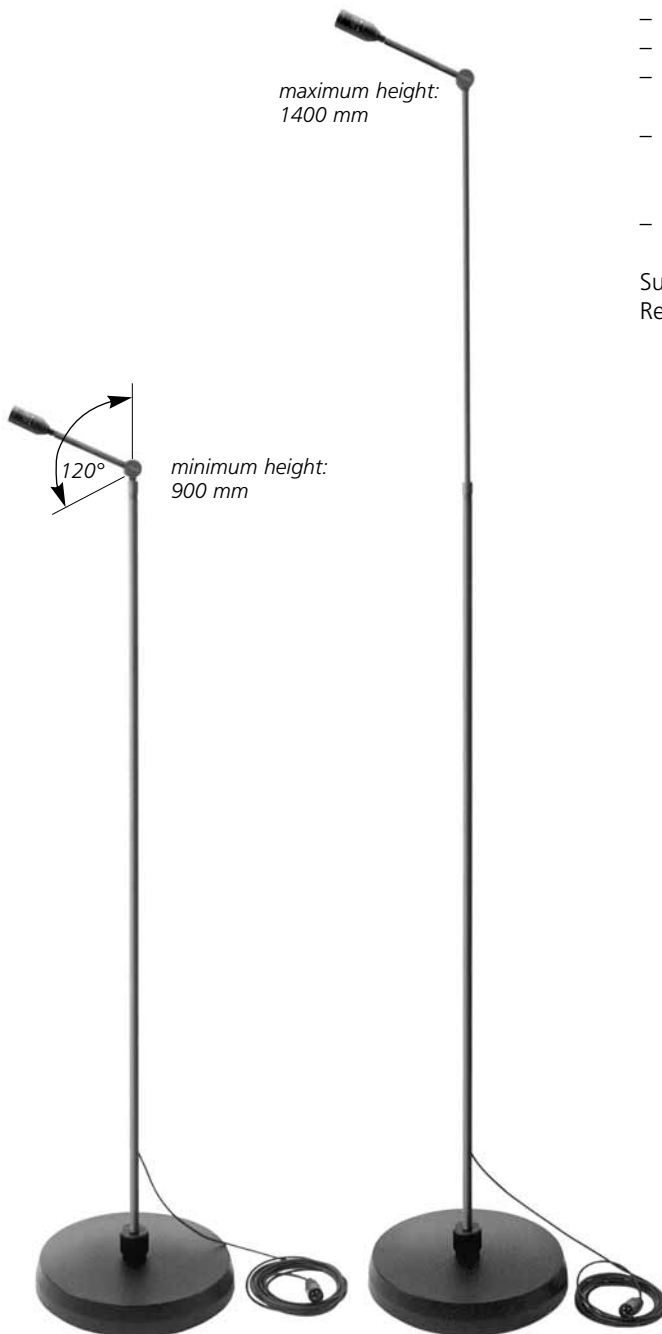

Compact microphone CCM _L
STV 900/1400 L3Ug
floor stand BF 250, pg. 118



Active Extension Tube RC

Active Extension Tubes are used between a Colette-series microphone's capsule and amplifier. This provides an unobtrusive way to place a microphone capsule directly in front of a vocalist or announcer without blocking anyone's view. This type of extension tube has become the standard for miking orchestras in television and video productions.

The RG 8 swivel clamps the Colette tube onto a vertical support rod, allowing adjustment of the tube's height and angle. The angle of the capsule relative to the tube is adjustable independently from 0° (fully extended) to 120°. This gives the Colette tube a very wide range of applications.

Standard lengths:

- RC 350g: 350 mm; recommended stand base (if the STR vertical support rod is fairly short): T 5g
 - RC 700g: 700 mm; recommended stand base: BF 250
 - RC 1200g: 1200 mm; stand base: BF 250
- Special lengths of less than 1200 mm can also be ordered.
Diameter of tube: 8 mm
Surface finish: matte gray (g). Other surface finishes available on request.

Accessory (included): swivel joint RG 8
Recommended popcreens: B 1 D or B 5 D

Note:

Laterally-addressed capsules (MK 4V, MK 41V, MK 4VXS, MK 6 and MK 8) can be used on the RC with a small elastic ring which we will supply at no extra charge. This ring should be slipped over the threads of the RC so that the capsule can be aimed in the desired direction.

Straight Extension Tube RL

- extension tube for CCM _L COMPACT CONDENSER MICROPHONES
- at the front end: Lemo socket; at the output: Lemo plug for the existing adapter cable of the CCM _L
- the swivel at the front end can be set from 0° (fully extended) to 120°

Standard lengths etc. just as with the RC tubes.

The K 5 LU adapter cable is included with the CCM _L, while the RG 8 swivel is included with the RL straight extension tube.

Recommended popscreens: B 1 D or B 5 D



RC with B 1 D
pop filter



RC with B 5 D
close-speech
guard

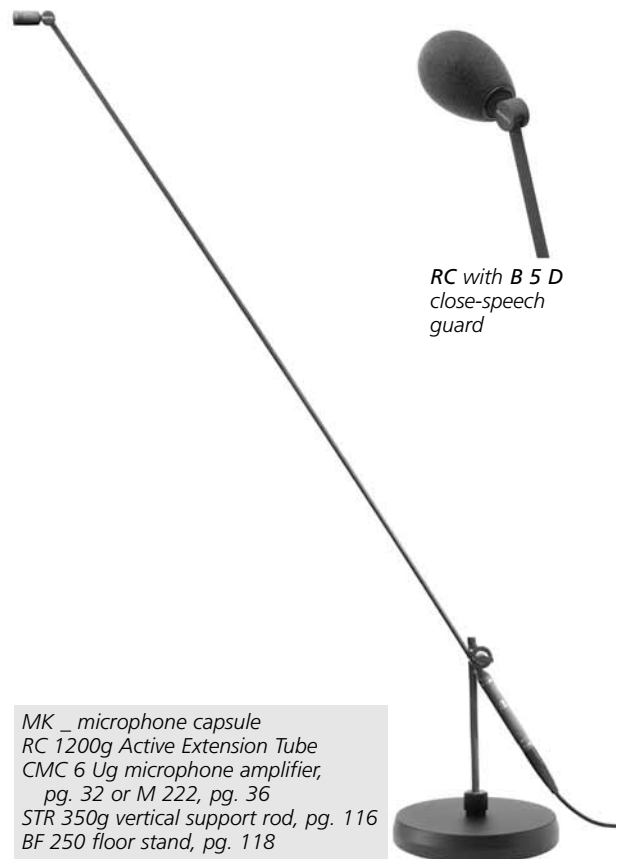

MK _ microphone capsule
RC 1200g Active Extension Tube
CMC 6 Ug microphone amplifier,
pg. 32 or M 222, pg. 36
STR 350g vertical support rod, pg. 116
BF 250 floor stand, pg. 118



CCM _L compact microphone
RL 700g straight extension tube
STR 350g vertical support rod, pg. 116
BF 250 floor stand, pg. 118



COLETTE
modular



MK _ microphone capsule
RC 350 KC 0,5g Active Extension Tube
CMC 6 Ug microphone amplifier,
pg. 32 or M 222, pg. 36
STR 600g vertical support rod, pg. 116
K 20 STR clamp for CMC: K 20 STR, pg. 117
(BF 250 floor stand, pg. 118)

Special Version of the RC Active Extension Tube: RC KC

This special type of Colette Active Extension Tube terminates in a connector mounted on a flexible, 0.5-meter Colette cable. This connector is screwed onto the microphone amplifier, which may then be mounted on the vertical support rod with a clamp or inserted in the cable path at a hidden position.

This arrangement is most useful when working in close quarters, where inadvertent movement at the rear of the microphone stand might disturb the alignment, or where the microphone amplifier body and cable connector might be objectionable and when the arrangement is not changed frequently.

The possible drawbacks are:

The inconvenience of wrapping and securing the cable attached to the tube especially if it is long.

The length should not exceed what is necessary, in order to avoid possible interference.

Both of these problems can be avoided by choosing a similar arrangement with the compact microphone CCM _L instead – see previous page.

Type designation: e.g. RC 350 KC: 0,5g = RC 350g with 0.5 m cable length

Special lengths are available on request.

Surface finish: matte gray (g)

Included accessory: swivel joint RG 8

COLETTE
modular



RG 88

Special Version: Double Extension Tube R2C KC

Twin version of the RC KC Colette tubes of the Colette modular system. Each tube terminates in a connector mounted on a flexible, 0.5-meter Colette cable. These connectors are screwed onto the microphone amplifiers, which may then be mounted on the vertical support rod with K 20 STR clamps or inserted in the cable path at a hidden position.

The second channel serves as a fail-safe backup.

Type designation:

e.g. R2C 350 KC 0,5 g:
350 mm tube length, 0.5 m cable length

Surface finish: matte gray (g)

Included accessory: Swivel joint RG 88, for attachment to STR support rods

Matching windscreen:

B 55 D (twin B 5 D)



Setting up microphones on a table top

A good speaker's desk, or a table on which microphones are to be set up, calls either for a rather heavy-weight construction or for a perforated metal surface to be used. A heavy tabletop will not flex much; a perforated surface on the other hand will radiate and reflect less sound energy than one which is flat and solid.

It is not always necessary to use several directional microphones (e.g. cardioids) when recording round-table discussions. A single boundary-layer microphone such as the BLM 03 Cg can be placed at the center of the table or the BL CCM 3 can be built into the table

top and concealed perhaps beneath a thin covering cloth, solving the problem in elegant fashion. This type of microphone is also significantly less sensitive to solid-borne noise than an ordinary directional type such as a cardioid. Even if monitor loudspeakers are nearby, the risk of feedback is less than might be expected since the boundary-layer effect discriminates in favor of direct sound. In addition, by using one boundary-layer microphone instead of several conventional microphones, the risk of phase cancellation is greatly reduced.

Microphone Setups with RC Active Extension Tube or RL Straight Extension Tube

The photos at right show 350 mm tubes and 100 mm STR support rods. If greater extension is required for either part of the setup, two AF 1 table mount elastic suspensions should be mounted one above the other with the mounting cylinder ST 20-3/8. The latter has a cylindrical base which fits inside the AF 1 suspensions, plus a threaded upper part to hold the STR support rod (which should be the 61 mm version – please specify this length when ordering). This arrangement is also recommended for situations in which the Active Extension Tube must be tilted at a 45° angle or greater.

To run the Colette cable through the AF 1, its output connector (which is larger than 20 mm) must be disassembled, unsoldered and removed, then resoldered on the other side. The cable passes through a notch in the cylinder.

Surface finish: matte gray (g)

MK _ microphone capsule
RC 350 KC 0,5g Active Extension Tube
(CMC 6 Ug microphone amplifier, pg. 32)
STR 100g vertical support rod, pg. 116
1 x AF 1 table mount elastic suspension, pg. 116
+ ST 20-3/8 mounting cylinder, pg. 116
or: 2 x AF 1 + ST 20-3/8 mounting cylinder
(long version – see description above)

CCM _L compact microphone
RL 350g straight extension tube
K 5 LU, adapter cable of the CCM _
STR 100g vertical support rod, pg. 116
1 x AF 1 table mount elastic suspension, pg. 116
+ ST 20-3/8 mounting cylinder, pg. 116
or: 2 x AF 1 + ST 20-3/8 mounting cylinder
(long version – see description above)



COLETTE
modular



CCM
compact



CCM
compact



CCM_L compact microphone
RLG 350Ug straight extension tube
1 or 2 × AF 1 flanged mounting
adapter, pg. 116

Straight Extension Tube with two Swivels RLG 350 Ug

- elegant table tube for CCM_L
- swivel joints at both ends of the tube
- tube length: 350 mm

Special versions (e.g. with permanently attached output cable) are available on request.

If the tube rod must be tilted at a 45° angle or greater or if greater extension is required for either part of the setup, two AF 1 adapters should be mounted one above the other, with the cylindrical lower part of the RLG 350 inserted into the upper AF 1 while the XLR plug rests in the lower one.

Surface finish: matte gray (g)
Output connector: XLR-3M

CCM
compact



CCM_L compact microphone
S 250 L5Ug gooseneck
ST 20-3/8 mounting cylinder, pg. 116
AF 1 flanged mounting adapter pg. 116



5 m cable
with XLR-3M

Gooseneck with Cable S 250 L5Ug

- length: 250 mm
- permanently attached cable, 5 m long
- with 3/8" internal thread
- output connector: XLR-3M

The cable can be brought out from the side of the gooseneck or, after resoldering the connector, from the center of the gooseneck on through the AF 1 (unit is delivered with cable exiting from the side).

Surface finish: matte gray (g)

CCM
compact



CCM_L compact microphone
S 250 LUg gooseneck
AF 1 table mount elastic suspension,
pg. 116



Gooseneck with XLR-3M S 250 LUg

Like S 250 L5Ug, but with an XLR-3M plug at the bottom end instead of the cable.



Goosenecks RS 420 L5Ug and SRS 420 L5Ug

- special long (420 mm) gooseneck
- for use with any microphone of the CCM _L series
- output connector: XLR-3M

These goosenecks have a miniature Lemo plug for CCM _L compact microphones at the upper end and a short, rigid tube at the bottom. The tubing directly above this rigid part is flexible. In the SRS version the tubing near the upper end is flexible as well, allowing the microphone's angle to be set.

To isolate the microphone from solid-borne sound, due to the length of the gooseneck two AF 1 flanged mounting adapters with internal shock mount should be used, one above the other. These are held together by an ST 20-3/8 mounting cylinder of at least 61 mm length, with other lengths available on request; see the illustration and explanation on page 133. The cylinder is to be ordered separately.

Cable length: 5 m
Surface finish: matte gray (g)

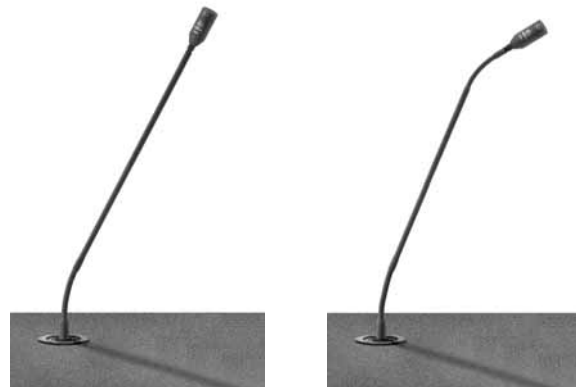

RS 420 L5Ug

SRS 420 L5Ug

CCM _L compact microphone
RS 420 L5Ug or SRS 420 L5Ug gooseneck
long version of the ST 20-3/8 mounting cylinder, pg. 116
2x AF 1 flanged mounting adapter, pg. 116

CCM
compact
New!

Goosenecks S 250 Cg, RS 420 Cg, SRS 420 Cg

These goosenecks are used directly between capsules and amplifiers of the Colette series. For mounting in a table top, the AF 1 flange (not included) offers good isolation from solid-borne noise. Mounting is generally quite straightforward and simple.

A CUT 1 or CUT 2 variable low-cut filter can be used on the amplifier – though the filter does not fit into the AF 1, so it would have to “ride” above the table top.

S 250 Cg: When there is a particularly great need to isolate the microphone from solid-borne noise, the elastic suspension A 20 S can be used along with the S 250 Cg. In an arrangement as shown at right, only the gooseneck and capsule will be visible, and the suspension will be relatively soft.

(S)RS 420 Cg: With the RS 420 and SRS 420 goosenecks, two AF 1 flanged mounting adapters should be used for stability, one above the other, with both holding the microphone amplifier (e.g. CMC). For a similar arrangement see the illustration at the bottom of page 133.

Lengths:
S 250 Cg: 250 mm
RS 420 Cg: 420 mm, (rigid part: 317 mm)
SRS 420 Cg: 420 mm, (rigid part: 257 mm)
Other lengths or versions (e.g. older SKC models) are available on request.
Surface finish: matte gray (g)

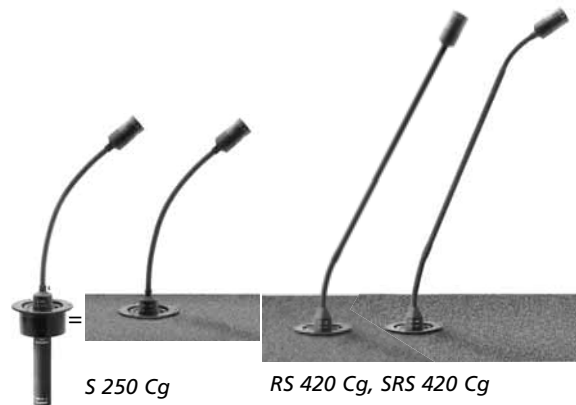

S 250 Cg

RS 420 Cg, SRS 420 Cg

MK _ microphone capsule
S 250 Cg, RS 420 Cg or SRS 420 Cg gooseneck
CMC 6 Ug microphone amplifier, pg. 32
AF 1 flanged mounting adapter, pg. 116

COLETTE
modular
New!

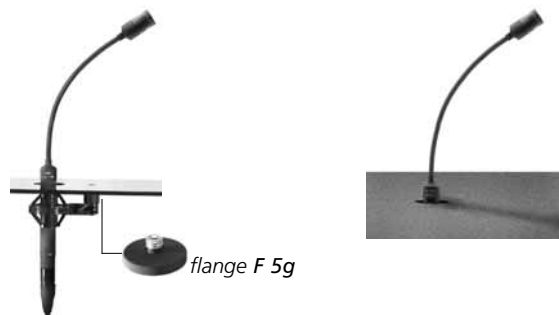

flange F 5g

MK _ microphone capsule
S 250 Cg gooseneck
CMC 6 Ug microphone amplifier, pg. 32
A 20 S elastic suspension, pg. 57
F 5g table mounting flange, pg. 117

COLETTE
modular



COLETTE modular
CCM compact

Variant 1:

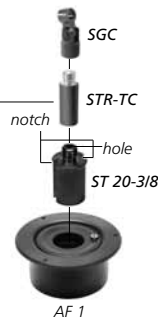

Further ways of mounting microphones on a table with elastic suspension

1. Simple mounting and a relatively restrictive grip.

CCM _L or CCM _U compact microphone
or MK _ microphone capsule + KC cable
SGC miniature stand mount with swivel, pg. 56
STR-TC vertical support rod, pg. 116
ST 20-3/8 mounting cylinder, pg. 116
AF 1 flanged mounting adapter, pg. 116

COLETTE modular
CCM compact

Variant 2:

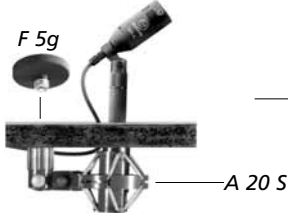

2. Very good isolation from solid-borne noise, and elegant appearance due to the smaller opening required in the table top.

CCM _L or CCM _U compact microphone
or MK _ microphone capsule + KC cable
SGC miniature stand mount with swivel, pg. 56
STR-TC vertical support rod, pg. 116
ST 20-3/8 mounting cylinder, pg. 116
A 20 S elastic suspension, pg. 57
F 5g table mounting flange, pg. 117

COLETTE modular

Variant 3:



3. Like variant 2, but because of the weight increase caused by the GVC, the stiffer version of the A 20 elastic suspension should be used.

MK _ microphone capsule
GVC capsule swivel, pg. 45
CMC 6 Ug microphone amplifier, pg. 32
A 20 S elastic suspension, pg. 57
F 5g table mounting flange, pg. 117

COLETTE modular

Variant 4:



AF 1 above the table surface



AF 1 beneath the table surface

4. Simple mounting and more restrictive grip than with variant 3.

MK _ microphone capsule
GVC capsule swivel, pg. 45
CMC 6 Ug microphone amplifier, pg. 32
AF 1 flanged mounting adapter, pg. 116

CCM compact



C2 CCM 4 Ug in AF 1 flanged mounting adapter with internal shock mount



Double Tabletop Microphone C2 CCM 4 Ug

This table microphone consists of two CCM 4 compact microphones (cardioids) rigidly attached to one another and facing in the same direction. They can be tilted forward or backward together. The second channel serves as a fail-safe backup.

For technical specifications see pages 23 and 54.

Suitable windscreen: WMS

Output connector: XLR-5M

Surface finish: matte gray (g)



Adjustable Active Desk Stand TR 200 KC 2g

- for use with microphone capsules
- elegant design
- fully adjustable swivel joints at both ends of the tube

This elegant microphone desk stand is easily adjusted in height and angle, thus offering an esthetically pleasing alternative to goosenecks, which are often twisted into awkward shapes.

The permanently attached cable is brought out at the base of the TR 200 KC 2g. It can be connected to any CMC, CMD or M 222 amplifier of the Colette modular system.

Cable length is 2 m; other lengths can be ordered.
Base diameter: 80 mm
Height when extended, without capsule: 230 mm
Surface finish: matte gray (g)



COLETTE
modular

Adjustable Active Desk Stands TR 200 Lg, TSR 200 Lg

- as TR 200 KC 2g (see above), but for CCM_L compact microphones
- TSR 200 L with gooseneck on the upper end of the tube

The required K 5 LU adapter cable (Lemo to XLR-3M) is included with the CCM_L.

These desk stands are also available with permanently attached cable, either at the rear or the bottom of the base.

Surface finish: matte gray (g)

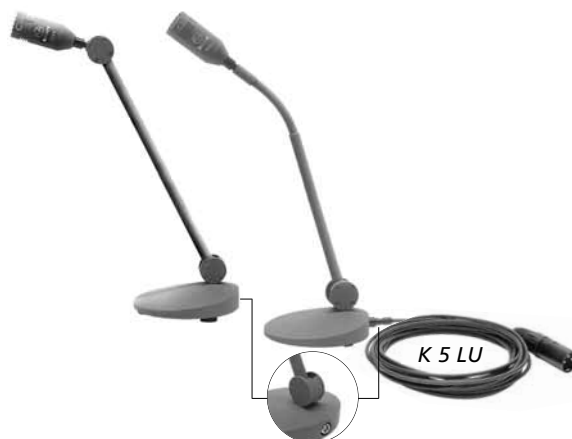

CCM
compact

New!

Metal Tripod T 20g

- tripod for a standard microphone of the Colette modular system (e.g. CMC, 20 mm diameter)
- the microphone can be tilted to any desired angle

Surface finish: matte gray (g)



COLETTE
modular

Metal Tripod TA 20g

As T 20g, but with integral shock mount.
Surface finish: matte gray (g)



COLETTE
modular



CCM
compact



Double Tabletop Microphone with integral Desk Stand T2 CCM 4g

This table microphone consists of two CCM 4 compact microphones (cardioids) rigidly attached to one another and facing in the same direction. They can be tilted forward or backward together. The second channel serves as a fail-safe backup. The permanently attached output cable terminates in an XLR-5M connector.

Base diameter: 80 mm
Height when extended: 129 mm
Height to the top of the rotary joint: 73 mm
Cable length: 5 m
For technical specifications see pages 23 and 54.
Surface finish: matte gray (g)

Suitable windscreen: WMS

COLETTE
modular
CCM
compact



Miniature Table Stand TCg, TC 2g

– adjustable angle

These elegant table stands, with vibration-isolating base, can be placed unobtrusively. The vertical rod is removable, allowing the microphone to be mounted on the base close to the mounting surface. A neat cable run is obtained when the cable is put into the wire loop between the bolt and the socket.

Dimensions: base diameter: 57 mm
height: 80 mm
Surface: matte gray (g)

MK _ microphone capsule(s)
KC (pg. 45) or KCY Active Cable (pg. 43)
CMC 6 Ug microphone amplifier
(not shown), pg. 32
or
CCM _L /U compact microphones, pg. 50 ff.
TC table stand



COLETTE
modular



Heavy Table Stand T 5g

– solid metal
– with 3/8" threaded stud, e.g. for STR support rods

Dimensions: diameter: 129 mm, height: 52 mm
Weight: 1.5 kg
Surface finish: matte gray (g)

CMC 6 Ug microphone amplifier, pg. 32
SG 20 stand clamp, pg. 56
T 5g heavy table stand



Boundary-Layer Adapter BLCg

Turns any directional (e.g. cardioid or supercardioid) CCM compact microphone or capsule with Active Cable into a boundary-layer ("PZM") microphone. This is especially useful when recording moving singers / actors on a stage, or when a microphone on a stand would be obtrusive. A rubber ring built into the bottom of the plate prevents inadvertent rotation of the plate or marring of the surface on which it is placed.

Diameter: 100 mm;
Surface finish: matte gray (g)

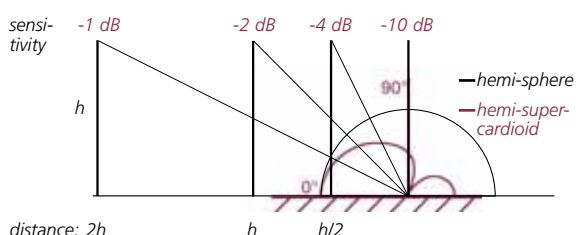

A directional boundary-layer microphone tends to "even" the balance of speakers and singers at various distances. For sources at greater distances, the sensitivity of the microphone increases in a compensating manner due to the angle of sound incidence, as shown here with a supercardioid.

Cable Hanger H 20g

This cable hanger suspends a microphone of the Colette modular system from its cable, and allows it to be set both vertically and horizontally to nearly any angle. A tie line can be attached to a loop in the cable to keep the microphone absolutely steady.

The use of SCHOEPS microphone cable particularly minimizes the risk that the cable will twist after being set up, e.g. in response to an increase in temperature.

Color: gray/matte gray (g)

Miniature Cable Hanger HC

This accessory is used when hanging a capsule on a KC Active Cable or a CCM compact microphone. Incorporated in its design is the SGC swivel which allows orientation to any angle laterally, and vertically to any angle from 0° to 100° .

There is very little danger of an Active KC Cable or the cable of a CCM twisting (e.g. as a result of rising temperature) after it has been suspended.

The HC is suitable only for use with the CCM_U or the Active Cable KC because of the cable diameter. If used with the CCM_L (which has a thinner cable), the mounting should be secured additionally with adhesive tape. Color: gray



Example of a directional boundary-layer microphone using a supercardioid:

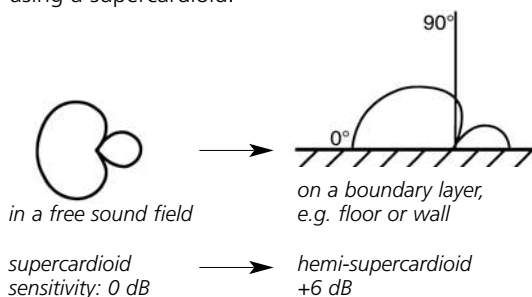

Placing the microphone on a rigid room boundary of sufficient area (a floor, wall, etc.) will increase its pickup of direct sound by 3 dB more than its pickup of diffuse sound. This provides a noticeable improvement in clarity.



COLETTE
modular

CCM
compact

COLETTE
modular

COLETTE
modular

CCM
compact



COLETTE
modular
CCM
compact



recommended windscreen:
W 5 D

Elastic Suspension for Boom Operation ACA 53

- especially for indoor use
- small and lightweight
- can be used with small, lightweight windscreens (W 20 R1, W 5 D)

This elastic suspension holds either a CCM compact microphone or the capsule end of a KC Active Cable plus a capsule of the Colette modular system onto the end of a boom.

The microphone is held securely by a metal clamp with thumb wheel. The low weight – 190g including a windscreen – leads to an extraordinarily light weight at the end of the boom, and thus to easy handling.

The 3/8" internal thread fits any readily available microphone boom.

Color: black

CCM
compact



Windjammer WJ 100 LU
(synthetic fur cover);
additionally available for
enhancing the effectiveness
of wind noise reduction



Basket Windscreen for a single CCM _L WSR 100 LU

- especially for outdoor use
- small and lightweight
- good isolation against solid-borne noise (handling noise)
- cable: internal: extraordinarily flexible, external: robust
- with 3/8" internal thread for booms
- optional: Windjammer, a fur-like "overcoat" which enhances the effectiveness

The cable from the CCM and the output cable join together at the small "Connbox." The output cable is permanently connected to this box, but the cable from the CCM itself is attached by means of a miniature connector. This allows the rapid exchange of the cable when necessary.

Version for M/S stereo: see page 89

Basket diameter: 100 mm
Length of the output cable: 16 cm
Output connector: XLR-3M



Picking Up the Sound of Musical Instruments

... is best accomplished with a normal microphone such as a CMC amplifier with MK 4 capsule. This can be stand-mounted, or an Active Colette Extension Tube can be used.

On stage, however, the risk of acoustic feedback may necessitate very close miking – perhaps by means of an adapter that attaches directly to the instrument. That approach may also be necessary in order to get consistent sound despite a player's physical motions. As far as the sound quality is concerned, it is always a compromise. However, SCHOEPS microphones do as much as possible to allow good sound quality to be obtained with this type of technique.

All of the following musical instrument adapters are suitable both for CCM compact microphones and for Colette microphone capsules on KC Active Extension Cables.



Julian Rachlin with the Guarnerius del Gesù violin "ex Carrodus" from 1741

Attached to the violin: SCHOEPS CCM 4V with violin mount VA 1

Violin Mount VA 1

- recommended microphones: CCM 4 or CCM 4V compact microphones and MK 4 or MK 4V microphone capsules

The VA 1 is designed to clamp onto the body of a violin. A leather covering on all points of contact prevents damage to the instrument's surface finish. By attaching near the edge of the violin where the motion of the wood is very slight, damping of the instrument is kept to a minimum.

The main axis of the capsule or microphone should be aimed toward the strings of the violin.

Range of span: ca. 25 to 40 mm

To protect the microphone against rosin deposits, a thin, dark gray foam cover (B 1) is included.



leather strips (at points of contact)



Violin/Viola Mount VA 2

As VA 1, but with range of span: ca. 26 mm to 50 mm



COLETTE
modular
CCM
compact



New!



*Violoncello Mount
VA 3*

Similar to the VA 1, but the span is adjustable between 80 - 140 mm.
The VA 3 is also suitable for being attached to guitars.

New!

COLETTE
modular
CCM
compact



*Double Bass Mount
VA 4*

Similar to the VA 1, but the span is adjustable between 200 mm - 260 mm.
Very good results have been noted especially in classical music recording.

New!



*Double Bass Mount
VA 5*

– recommended microphones:
CCM 2 and CCM 8 compact microphones or MK 2
and MK 8 microphone capsules

This adapter is attached to the bridge rather than the body of the instrument.

Range of span: ca. 10 mm to 20 mm.

Adapter for Flute
FA 1

- recommended microphones: CCM 8 compact microphone or MK 8 microphone capsule

The FA 1 is a double clip made of plastic which fastens to the head joint of a flute. We recommend the MK 8 capsule or CCM 8 compact microphone, with the 0° axis oriented toward the embouchure hole.



Adapter for Guitar
GA 1

- recommended microphones: CCM 4VXS or CCM 4A compact microphones or MK 4VXS or MK 4A microphone capsules

The GA 1 clamps onto the sound hole of a guitar and is tightened by turning a coin in the outward-facing slot (see photo). With this mounting device the microphone or capsule is positioned within the instrument, where the maximum sound level can be obtained without risk of feedback.

For this application it is necessary to use a capsule or microphone with reduced low-frequency response, such as those types stated above.

The span is adjustable between 0 - 50 mm.



Adapter for Saxophone
SA 2

- recommended microphones: CCM 4 or CCM 4V compact microphones or MK 4 or MK 4V microphone capsules

The SA 2 has an elastic suspension which significantly reduces the transmission of handling noise from the instrument to the microphone.



clamp for the cable



New!

COLETTE
modular
CCM
compact



The C-MIT 5U shotgun microphone received a Pro Audio Review Excellence 2006 Award and was nominated for a 2006 TEC Award in MIX magazine.



Special-Purpose Microphones



Shotgun Microphone 74

Speech capsules/compact microphones 76

Headsets 79

Hand-held Microphones 80

page



New!



Shotgun Microphone CMIT 5 U

- unusually low coloration of off-axis sound
- suitable for music recording as well as dialogue
- pickup quality remains constant even if the microphone is rotated on its axis
- even greater immunity to wind noise than a SCHOEPS supercardioid
- very lightweight, robust all-metal housing

When making outdoor recordings of dialog, for example, even a supercardioid may pick up too much noise from nearby sources. The CMIT 5 can help in such situations, while maintaining the highest standard of sound quality. This is achieved in part by keeping the mid- and high-frequency pickup angles fairly similar. The pattern at high frequencies is not as narrow as with long shotgun microphones. In active scenes it is easier to cue the boom and keep actors 'on mike' while avoiding the muffled sound quality typical of many shotgun microphones. However, the midrange directivity of the CMIT 5 is greater than one might expect from a microphone of its length; the narrowing of its pickup pattern is already in evidence at 2 kHz.

The sound quality of the CMIT 5 remains consistent even if the microphone is rotated on its axis, since its directional pattern is the same in both the vertical and horizontal planes.

Three pushbutton-activated filters allow the microphone to adapt to the recording situation:

- High-frequency emphasis (+ 5 dB at 10 kHz) enhances speech intelligibility, and compensates for high-frequency loss caused by windscreens;
- A steep low-cut filter (18 dB/oct. below 80 Hz) suppresses wind and boom noise;
- A gentle low-frequency rolloff (6 dB/oct. below 300 Hz) compensates for proximity effect.

Pairs of LEDs next to each pushbutton indicate the status of the filters. Even in darkness the user can read the settings and see that the microphone is operational. The settings are retained when the microphone is switched off.

The capsule and amplifier of the CMIT 5 U are built as a single unit, unlike microphones of the SCHOEPS "Colette" series.

General information about shotgun microphones can be found on page 129.

Accessories (included):

polished wood case, SG 20 stand clamp with swivel, W 140 foam-type windscreen for moderate wind

Accessories (optional): elastic suspension and basket-type windscreens See photographs at left and on the following page.

For data of windscreens, see page 120

*available only at your Rycote dealer



W 140

SG 20



Rycote
"Mount & Handle"*



CMIT 5 U with "Softie"*

Technical Specifications:

Directional pattern: supercardioid /lobe-shaped

Frequency range: 40 Hz – 20 kHz

Switchable filters: 80 Hz with 18 dB/Okt., 300 Hz with 6 dB/Okt., 5 dB lift at 10 kHz (shelving)

Sensitivity: 17 mV/Pa

Equivalent noise level (filters off): 14 dB-A**, 24 dB CCIR***

Maximum sound pressure level: 132 dB SPL at 0.5% THD

Powering: 48 V ± 4 V phantom

Current consumption: 4.4 mA

Maximum output voltage: 1.3 V (at 1 kHz, 1 kOhms)

Output impedance: 50 Ohms

Recommended load impedance: 600 Ohms or greater

Dimensions: length: 251 mm, diameter: 21 mm

Weight: only 89 g (3-1/8 ounces)

Color: blue (see page 72)

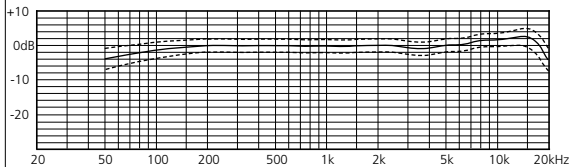

Frequency response (tolerances shown)

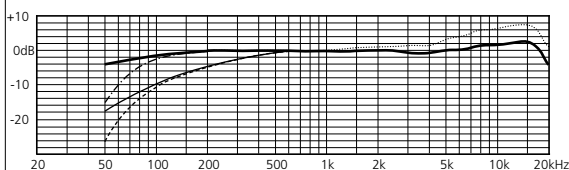

Frequency response curve:

— without filters - - - 80 Hz, 18 dB/oct.
 — 300 Hz, 6 dB/oct. - - - 80 Hz + 300 Hz
 10 kHz: +5 dB

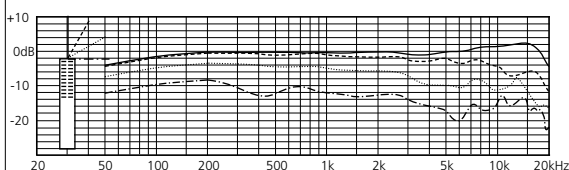

Frequency response curve without filters at 0°, 30°, 60°, 90° angle of incidence

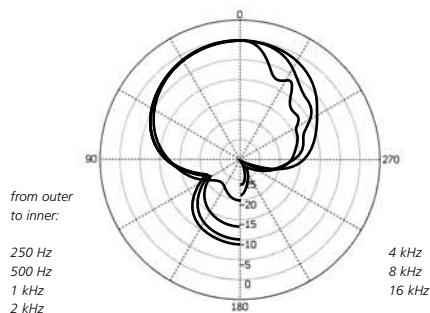

Polar diagram

** according to IEC 61672-1
 *** according to IEC 60268-1



CMIT Mono Set :
 CMIT 5 U shotgun microphone, elastic suspension with pistol grip and Connbox, WSR CMIT basket-type windscreen (100 mm dia.), WJ CMIT Windjammer

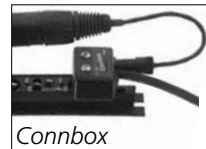

Connbox



CMIT MIS Set for MIS stereo:
 CMIT 5 U shotgun microphone, WSR MS CMIT basket-type windscreen (100 mm dia., comprising elastic suspension with pistol grip and Connbox and a KMSC MIS double clamp), WJ CMIT Windjammer, CCM 8Lg figure-8 compact microphone



windscreen with Windjammer



Double MIS Set "CMIT":
 CMIT 5 U shotgun microphone, elastic suspension with pistol grip and Connbox, WSR DMS CMIT LU basket-type windscreen (150 mm dia.), Windjammer WJ DMS CMIT, 2 × KMSC MIS double clamp, 1 × CCM 4Lg (cardioid), 1 × CCM 8Lg (figure-8)



Connbox

Microphones for Close Pickup

COLETTE
modular

The microphones and capsules presented on the following pages are directional (cardioid or supercardioid). Each has a distinct low-frequency rolloff built in, to compensate for proximity effect and to reduce pickup of room noise. They are mainly used for speech at close range (e.g. 20 cm or less) when clarity and intelligibility of the spoken word is the primary requirement. They are not recommended for musical instruments, vocal soloists or voiceover work unless the miking is unusually close. Even speech pickup at moderate distances can sound thin and bright.

These capsules and microphones are often included in fixed installations. As an alternative, especially if the problems which they deal with are only occasionally encountered, standard cardioids or supercardioids can be used along with the CUT 1 variable filter (for Colette-series microphones) or the LC 60 or LC 120 inline filter (for Colette- or CCM-series microphones). The CUT 1 is particularly versatile in that it allows the amount of low-frequency attenuation to be tailored to

the specific voice, working distance and locale. Low frequencies can often be reduced in a preamp or mixing console, but the CUT 1 reduces the danger of overloading the inputs of such equipment due to wind or breath noise, which can generate surprisingly high signal levels.

Diameter of the MK capsules and the CCM compact microphones: 20 mm

For further technical specifications of the CMC microphone amplifiers see page 34 and for those of the CCM compact microphones, see page 54.

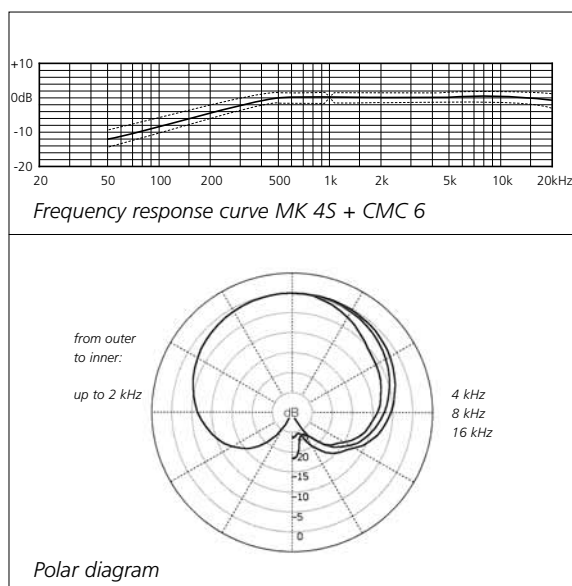
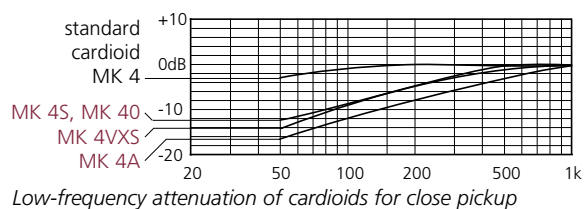

MK 4S, CCM 4S

- for pickup of speech or music at close range (under 50 cm)
- cardioid pattern
- considerable attenuation of low frequencies

This type of microphone has a low-frequency rolloff to compensate for the low-frequency boost which occurs when close-miking.

It is used primarily in voiceover and sound reinforcement applications, and wherever good speech audibility in a noisy environment is a prime requirement. It is suited for the recording of music in exceptional cases only. When it is used at a distance of ca. 10 cm flat frequency response can be obtained.



MK 40, CCM 40

- for pickup of speech or music at close range (under 50 cm)
- cardioid pattern
- considerable attenuation of low frequencies
- emphasis of high frequencies
- for severe acoustic conditions

This microphone type has the same features as the MK 4 S, but in addition emphasizes the frequency response in the 9 kHz region by 4 dB. This effects a further improvement of speech intelligibility, particularly in very reverberant venues such as churches.

The MK 40 is used primarily for sound reinforcement of speech. It is not particularly recommended for music recording.



corresponding CCM L-Version / U-Version

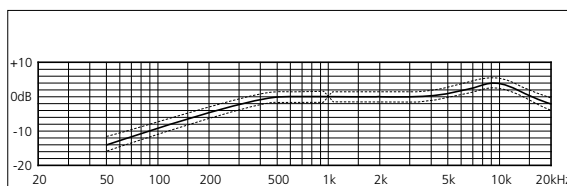

Frequency response MK 40 + CMC 6

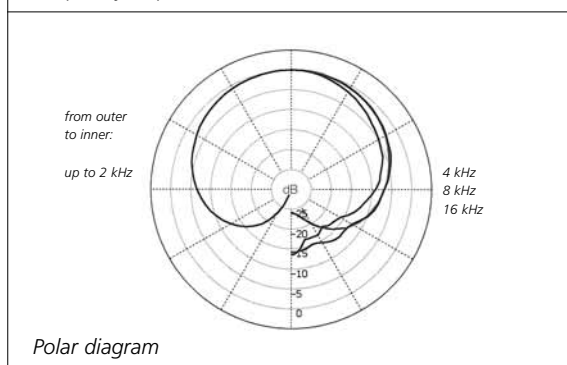

Polar diagram

MK 4VXS, CCM 4VXS

- for pickup of speech or music at close range (under 10 cm)
- cardioid for lateral pickup
- considerable attenuation of low frequencies
- emphasis of high frequencies

This cardioid microphone, with its main axis along its side, improves speech intelligibility in very loud environments. It is designed for the very closest speech pickup, i.e. directly in front of the speaker's mouth. Its low-frequency rolloff is compensated by proximity effect. Thus it has (up to the point of its high-frequency emphasis) a flat frequency response for the speaker's voice, while showing a rolloff at low frequencies for all sound that originates from a greater distance. As a result, background sounds are picked up less strongly than the person speaking.

The MK 4VXS or CCM 4VXS should be used with the popscreen B 5 in order to prevent "popping" sounds from the voice.

The CCM 4VXS has proved itself especially when used in the broadcasting or recording of motor sporting events. In this case it is attached to the user's headphones.



corresponding CCM L-Version / U-Version

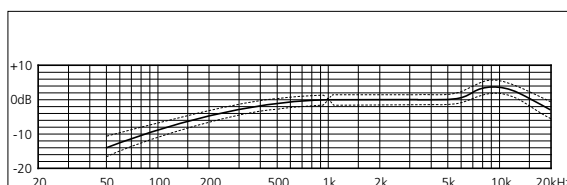

Frequency response MK 4VXS + CMC 6

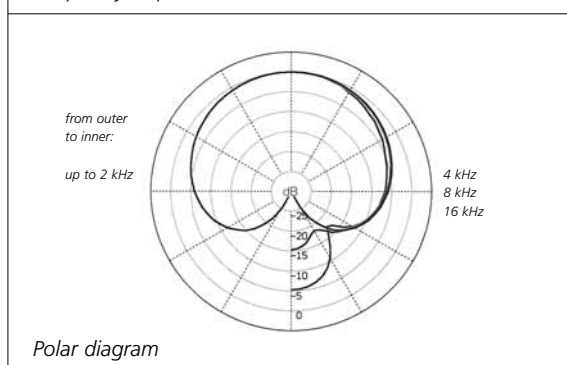

Polar diagram



Headset HS 4VXS

Microphones for Close Pickup

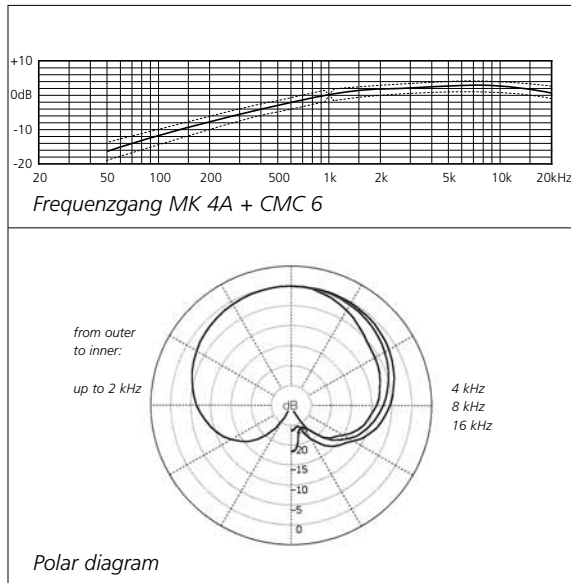

MK 4A, CCM 4A

- for pickup of speech or music at close range (under 10 cm)
- cardioid pattern
- reduced sensitivity
- considerable attenuation of low frequencies



When cardioids are used in some situations, e.g. as hand-held microphones for vocalists or announcers, proximity effect can become quite prominent. In addition, the output level can become much higher than that of the other microphones being used at the same time, which may be more distant and/or of dynamic type. Neither characteristic is desirable. So SCHOEPS offers the MK 4S/CCM 4S in a special version known as the MK 4A or CCM 4A ("A" for "attenuation"), with a stronger low-frequency rolloff and 10 dB lower sensitivity.

This microphone type is recommended for use exclusively in situations of very close pickup and high sound pressure levels. At greater distances it would only deliver a low output level, resulting in an effective reduction in signal-to-noise ratio.



corresponding CCM L-Version / U-Version

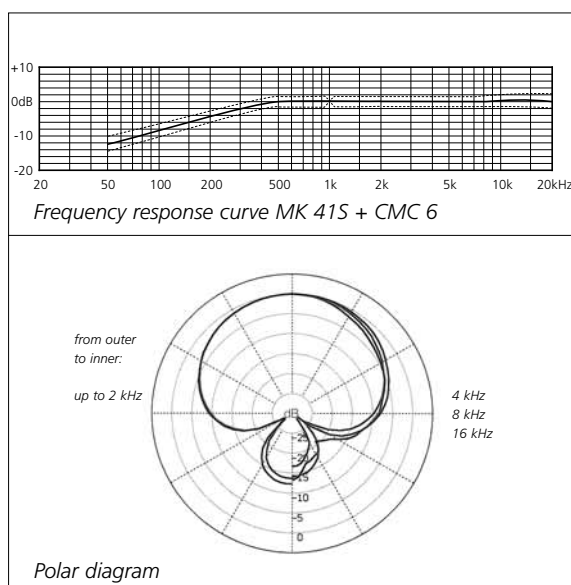

MK 41S, CCM 41 S

- for pickup of speech or music at close range (under 50 cm)
- supercardioid directional pattern which is highly uniform throughout the frequency range
- considerable attenuation of low frequencies
- excellent suppression of ambient noise



In its frequency response and in the range of its applications this microphone type resembles the MK 4S or CCM 4S, but due to its greater directivity it attenuates reverberant sound further, and it is less prone to feedback.

The rolloff of its low-frequency response is offset by proximity effect at close working distances.



corresponding CCM L-Version / U-Version

Headsets HS 4VXS, HS 2S

- with cardioid (HS 4VXS) or omnidirectional (HS 2S) microphone attached
- highest-quality pickup of speech
- HS 4VXS: effective suppression of noise from surroundings
- excellent protection from vocal “popping” sounds
- The earpiece on the opposite side can be folded out of the way of the ear.

These headsets are delivered as a complete set consisting of:

- the CCM 4VXS Lg compact microphone (a cardioid designed for extremely close pickup of speech) or the CCM 2S Lg (omni); both have a matte gray surface finish
- the HBL, a connecting rod for the microphone with a fixed-angle suspension
- a foam popscreen B 5
- a pair of closed stereo headphones

The HCCM 4VXS Lg was developed in cooperation with the sound engineers of a TV station who sought the highest possible quality of sound even under the extreme conditions of Formula 1 motor races.

A closed type of headphone was chosen to shield the wearer from surrounding noise; it was also chosen so that its size would accommodate the microphone.

The microphone of the HS 4VXS offers a strong bass rolloff and a mild high-frequency boost. It is designed for lateral sound pickup at the shortest possible distance, i.e. directly in front of the speaker's mouth. Proximity effect compensates for its low-frequency rolloff such that the microphone has an even frequency response for the person speaking, while background noise encounters the full response rolloff and is greatly reduced.

The microphone should be protected from vocal “popping” noises by the use of a small, simple foam windscreen such as the B 5; this is also recommended for hygienic reasons.

Since the cable between the microphone and the headset (KHS LI) is subjected to increased stress, it can easily be exchanged if necessary.

In place of the cardioid microphone, an omnidirectional microphone such as the CCM 2S Lg can be used; the result (model HS 2S) would have lower sensitivity to popping and handling noise.

For standard cable lengths and connectors, see illustration.

Other connectors (supplied by the customer) can be installed at no extra charge if requested when ordering.

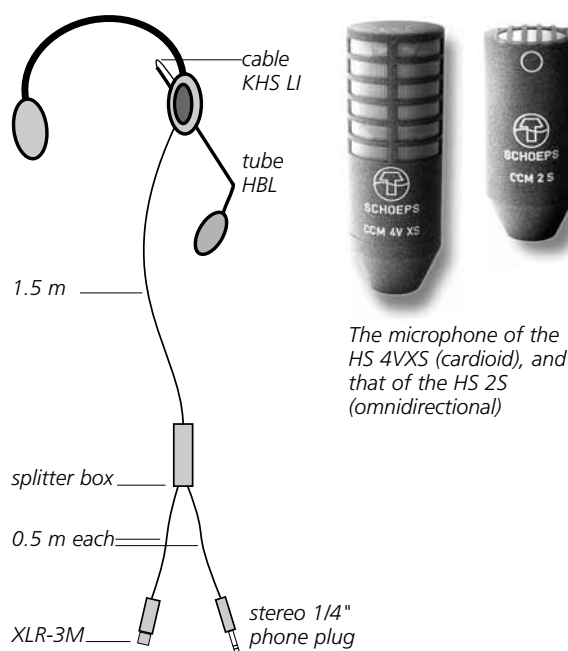

The microphone of the HS 4VXS (cardioid), and that of the HS 2S (omnidirectional)

Headset with standard arrangement of connecting cables

Technical Specifications:

Phantom powering:
current consumption: 12 V: 8 mA, 48 V: 4 mA
(automatically switched)
Source impedance: 90 Ohms
All other data are identical with CMC 6 + MK 4VXS or MK 2S.
Length of the microphone: CCM 4VXS: 58mm,
CCM 2S: 46 mm
Diameter: 20 mm
Weight (without cable): ca. 110 g



Stereo and Surround



	page
<i>Stereo microphones and Sets</i>	82
<i>Surround Sets</i>	97
<i>Stereo Preamplifier</i>	105

Miniature Stereo – Modular System



COLETTE
modular

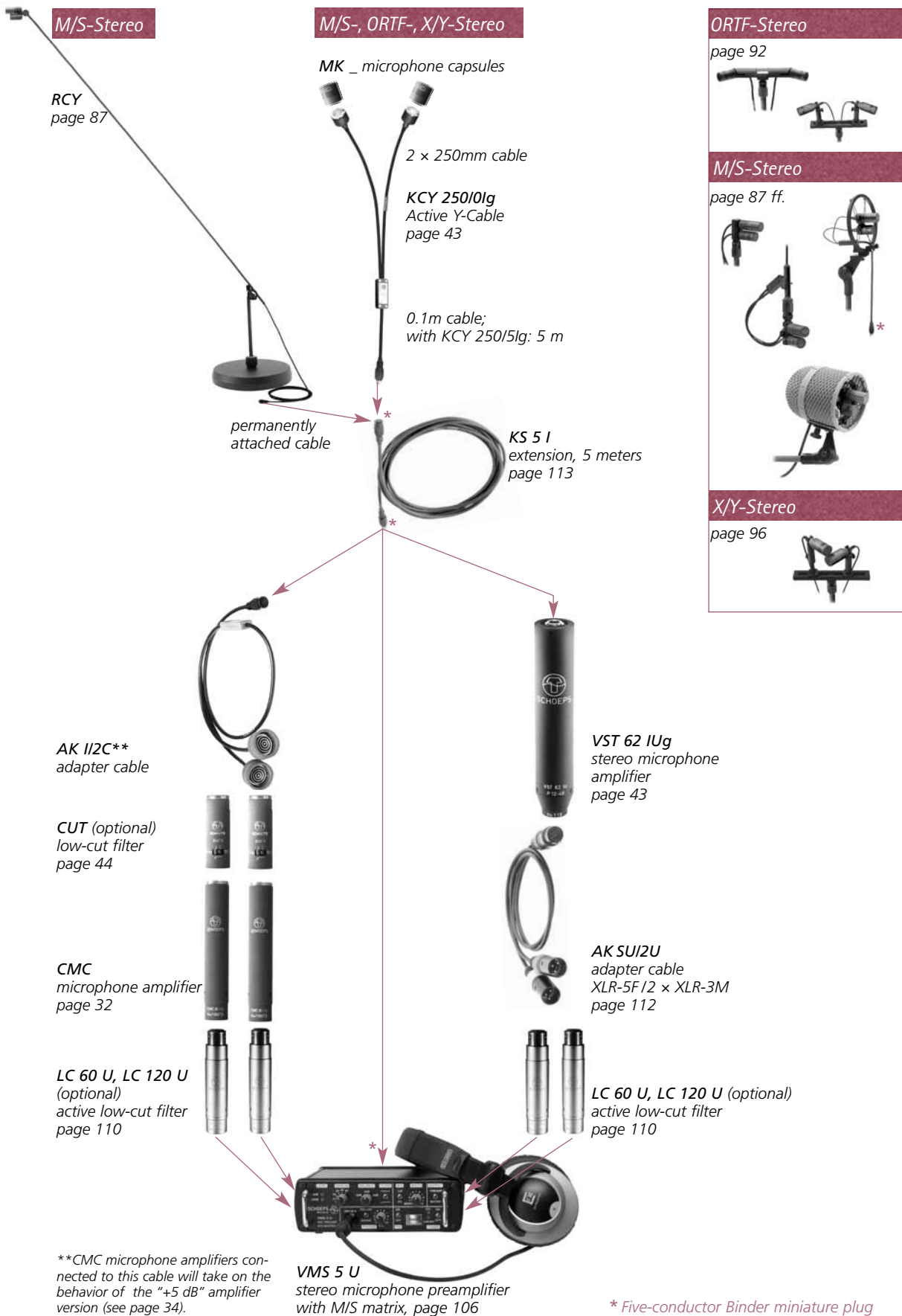



Miniature Stereo – Compact System

M/S-, ORTF-, X/Y-Stereo

CCM_L
compact microphones

2 × 250 mm cable
KLY 250/01
Y-cable
page 113

0.1 m cable;
with **KLY 250/51**: 5 m

X/Y-Stereo

CMXY 4V Ug
page 94

CMXY 4V Ig with
miniature socket *

KS 5 IU
adapter cable to
XLR-5M and extension,
5 m
page 113

AK SU/2U
adapter cable
XLR-5F/2 × XLR-3M
page 112

LC 60 U, LC 120 U (optional)
active low-cut filter
page 110

VMS 5 U
stereo microphone preamplifier
with M/S matrix, page 106

ORTF-Stereo

page 92



M/S-Stereo

page 87 ff.

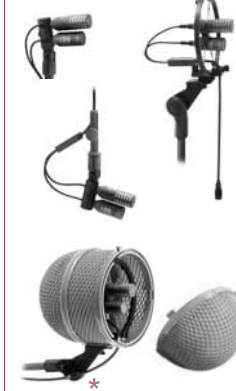

X/Y-Stereo

page 96



Features of these systems:

- allow for small and lightweight stereo recording setups without compromise in sound quality
- powered from battery or via AC supply (optional)
- suited for all two-microphone stereo recording techniques with 50 cm distance or less between microphones
- especially suited for M/S and ORTF

* Five-conductor Binder miniature plug



COLETTE
modular

CCM
compact

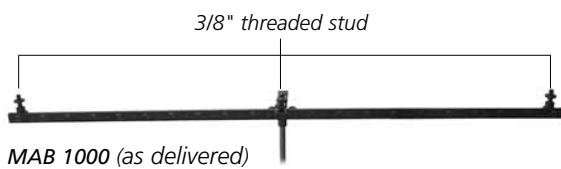
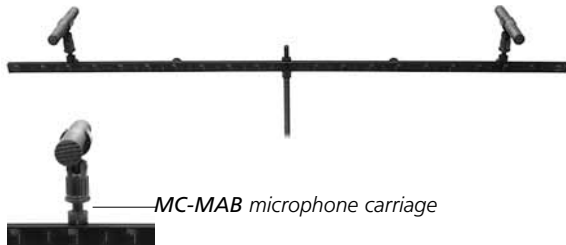

MAB 1000 (as delivered)



KMAB 1000
carrying case
(included)

A/B Stereo

A/B and OCT Stereo Mounting Bar MAB 1000

- for two microphones in an A/B arrangement (can be used for ORTF)
- with extension bar for a third, central microphone offset slightly in front of the other two (see pages 100 or 134); this is especially useful for OCT pickup
- can be expanded for five-channel OCT surround

This 1-meter-long mounting bar has 3/8" threaded attachments for three stand adapters or shock mounts. The microphone positions are continuously adjustable. Each side of the bar is engraved with markings every 2.5 cm so that distances of 5 cm, 10 cm, 15 cm, etc. can easily be set between the two outer microphones. Thread: 3/8"; length: 1000 mm; weight: 500 g

Accessories (included): KMAB 1000, robust, foam-lined carrying case for two MAB 1000 mounting bars and a CB-MAB mounting bracket

Accessories (optional):

- ST 5/8-3/8, robust adapter for mounting the MAB 1000 onto stands with a 5/8" thread
- stand clamps and shock mounts: SG 20 or A 20 for Colette-series microphones (e.g. CMC); SGC or AC for CCM-series microphones
- CB-MAB mounting bracket for OCT surround; holds two MAB 1000 stereo bars at variable distance (13 – 47 cm)
- MC-MAB microphone carriage for additional microphones
- mounting bar (40 cm) for OCT 2

Blumlein Stereo

Universal Stereo Bracket UMS 20

- for two microphones of the Colette modular system (e.g. CMC, 20 mm diameter)
- for Blumlein, M/S, ORTF, X/Y

The mounting adapter for this device has 5/8 - 27 NS threads and can be directly attached to a microphone stand. However, because it has a 20 mm diameter, it can also fit into an optional SG 20 stand clamp or A 20 S elastic suspension.

Thread of the mounting adapter:
5/8" - 27 NS, with adapter to 3/8" and 1/2"
Surface finish: metal: matte black
plastic microphone holders: gray



UMS 20 with
WB windscreen

COLETTE
modular

Stereo Sphere Microphone KFM 6

smaller version: KFM 360

- head-related stereo microphone for loudspeaker reproduction
- very good imaging and sense of depth; good localization, very natural sound
- with qualities of a dummy head when headphones are used for listening
- natural sound with superior low-frequency performance
- for phantom powering (12 V or 48 V)

Stereo microphones such as the KFM 6 are distinguished by the simplicity of the recording technique and of the setup. Only two microphones and recording tracks are required, and with the KFM 6 only one microphone cable is needed.

The KFM 6 sphere microphone is the embodiment of a stereo microphone design using an acoustic baffle. It bears some resemblance to a "dummy head" and follows some of the same principles – but while dummy head recordings can provide excellent results, they are suitable only for headphone listening. The "Sphere" microphone was developed so that similarly convincing results could be achieved for loudspeaker playback. To fulfill this objective the microphone must provide not only interaural arrival-time cues, but also spectral-vs-angular incidence information. A further requirement was that the frequency response on the main axis of the microphone in the free sound field and also the frequency response in the diffuse sound field remain flat. (See G. Theile: "On the naturalness of two-channel stereo sound," AES/SMPTE Joint Television Conference, Jan. 1991, Detroit)

In constructing the KFM 6, two special pressure transducers are mounted flush on the surface of a sphere 20 cm in diameter, an acoustic baffle having especially favorable properties.

Normally two pressure transducers placed so close to each other would not provide a convincing stereo image. However, the sphere between the capsules creates a frequency-dependent emphasis of level differences comparable to that which occurs naturally between the human ears.

The frequency response on the stereo main axis of the KFM 6 is flat when measured at the output of either channel. If a sound source moves around the sphere, the level in the one channel will increase by the same amount as it decreases in the other. This is brought about by the unique construction of the microphone capsules, the effect of the sphere as an acoustic baffle, and some special electronic circuitry built into the amplifier. As a result, the energy sum of the two channels is largely independent of the angle of sound incidence and shows essentially flat frequency response in both the direct and the diffuse sound field. Furthermore, the directionality of the microphone is essentially constant throughout the audio frequency range.

These features, combined with an exceptionally flat response that extends down to the very lowest fre-





quencies, are responsible for the remarkably natural impression of space, depth and image typical of the KFM 6.

Some practical information about the KFM 6:

- The recording room should have a good sound.
- In practice, the recording angle⁺ of the KFM 6 has a fixed value of 90°.
- A LED pinpoints the stereo main axis. This is especially useful when the KFM 6 is positioned at some distance.
- The sensitivity of the KFM 6 is about 15 – 20 dB higher than that of a standard Colette series microphone.
- The KFM 6 can operate into unbalanced inputs without any loss of level and without transformers. This requires a powering device with DC decoupling.
- Any standardized 12 V or 48 V phantom powering is suitable.

Please note: When a 12 V phantom powering is used, the maximum SPL is reduced by 7 dB.

- In order to assure proper operation, make sure that both channels are powered simultaneously at all times.

Accessories (included):

- HKFM, a universal device for suspending the KFM 6 on lines
- KG, ball-and-socket joint for mounting the KFM 6 on a stand
- AK SU/2U, adapter cable (XLR-5F to 2 × XLR-3M)



Accessories (optional):

- KKFM, wooden shipping case for the KFM 6 and accessories such as the mounting and suspension devices, other hardware, cables, etc.; dimensions: 385 x 325 x 230 mm, weight: 4.2 kg
- WKFM (see previous page), a foam windscreen for outdoor use in moderate wind. It has minimal effect on the sound pickup (diam. 200/240 mm x 40 mm)
- XLR-5 stereo cables (page 116)

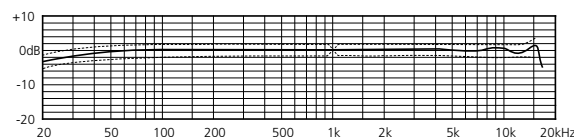

Frequency response curve on the stereo main axis

Technical Specifications:

The following data were measured on the axis of the capsules. A standard 48 V phantom power supply was used and the load impedance was 1 kOhm.

Classification of the special capsules:	pressure transducer
Recording angle ⁺ for full stereo reproduction:	ca. 90°
Frequency range:	18 Hz – 16 kHz
Sensitivity:	100 mV/Pa
Equivalent noise level, CCIR**:	25 dB
Equivalent noise level, A-weighted*:	17 dB-A
Signal-to-noise ratio, A-weighted*:	77 dB-A
Maximum sound pressure level for 0.5% THD:	123 dB-SPL
Output voltage at maximum SPL:	2.8 V
Source impedance:	60 Ohms
Minimum recommended load impedance:	600 Ohms
Powering:	12 V ± 1 V or 48 V ± 4 V phantom
Current consumption per channel:	4.4 mA, independent of the supply voltage; at high sound pressure levels slightly more
Measuring conditions:	see page 134
Weight:	ca. 1.1 kg
Diameter of the sphere:	200 mm
Total weight of the suspension device:	ca. 0.5 kg
Surface finish:	matte gray
Pin assignment (XLR-5M):	see page 133

*IEC 61672-1, **IEC 60268-1

* This is the range within which the sound sources should be placed, as "seen" by the microphone.



Active M/S Stereo Extension Tube RCY

- small, particularly unobtrusive stereo arrangement
- a swivel at the upper end allows angles from 0° to 120° to be set
- also suitable for use as part of a "Straus-Paket" in which the signals from a cardioid and an omnidirectional microphone are blended together, e.g. to obtain a "wide cardioid" pattern

Tube lengths: 350 mm, 700 mm, 1200 mm
 Standard cable length: 2 m
 Special lengths of tube and cable are available.
 The RG 8 swivel joint and a rubber ring (see on the right) are included.

Type designation: for example RCY 1200/2lg
 (1200 mm tube and 2 m cable, matte gray (g))
 Extension: KS 5 I: 5 m long or KS 10 I: 10 m long

Matching windscreen: WMS

MK 8g microphone capsule (figure-8), pg. 27
 MK _ microphone capsule
 RCY 1200lg Active Stereo Extension Tube
 VST 62 1Ug stereo microphone amplifier, pg. 43
 or VMS 5 U microphone preamplifier, pg. 106
 STR 350g vertical support rod, pg. 116
 BF 250 floor stand, pg. 116

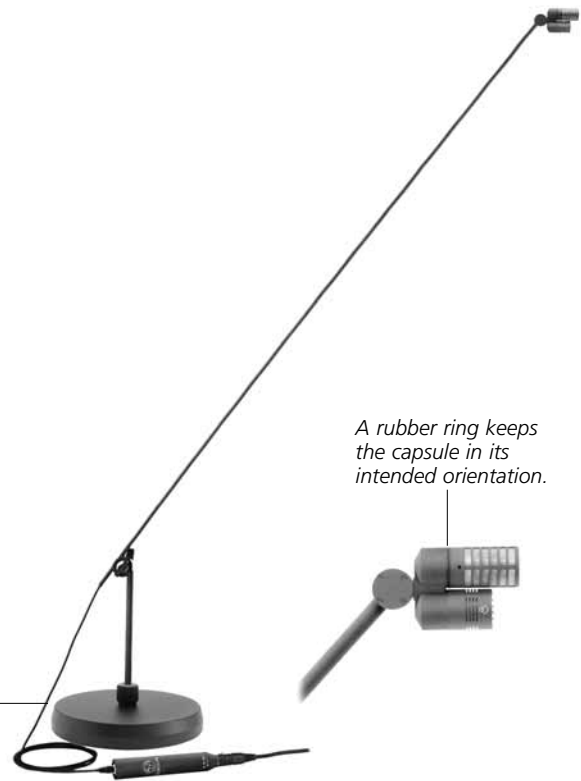

A rubber ring keeps the capsule in its intended orientation.

COLETTE modular
 CCM compact

Mounting Stud with Swivel for M/S SGMSC

Thread: 5/8"-27 NS internal thread. An adapter is included for 3/8" and 1/2" mounting.

Matching windscreen: WMS



COLETTE modular
 CCM compact

Miniature Cable Hanger for M/S HSGMSC

The microphones can be adjusted in their orientation by inclining the double clamp or turning it to either side.

Thread: 5/8"-27 NS internal thread. An adapter is included for 3/8" and 1/2" mounting.

Matching windscreen: WMS



COLETTE modular
 CCM compact



COLETTE modular
CCM compact



Double Clamp for Upgrading from Mono to M/S Stereo KMSC

- for adapting a microphone of any directionality (including shotgun microphones) to M/S stereo, by the use of a CCM 8 (figure-8)

No further parts are needed beyond the clamp and microphone. Existing windscreens can still be used. The small CCM 8 adds hardly any weight to that of the setup as a whole.



CCM 8 compact microphone, pg. 27
CMIT 5 U shotgun microphone, pg. 74
KMSC double clamp

COLETTE modular
CCM compact

AMS = indoor version without cable



Elastic Suspension for M/S with Swivel AMS, AMS _

- for Colette capsules on Active Cables, or for CCM _L compact microphones

This elastic suspension is available either by itself (AMS) or with one of three "Y"-shaped adapter cables:

- the KCY 115/0,25 I cable for two Colette capsules (the resulting set is then called the AMS CI),
- the KLY 115/0,25 SU cable for two CCM _L microphones (the resulting set is then called the AMS LU),
- or the KLY 115/0,25 I cable for two CCM _L microphones (the resulting set is then called the AMS LI).

The forward ends of the cables are all 115 mm long and are made of a thin, especially flexible material. This combination of characteristics provides both good isolation from solid-borne sound and optimal durability for the output cable.

With a windscreen and, if necessary, the fur-like "overcoat" (Windjammer) the AMS _ becomes the WSR MS _ windscreen with elastic suspension that is best suited for outdoor recordings:

COLETTE modular

AMS CI = indoor version for MK capsules, with KCY 115/0,25 I cable



3/8" inner thread

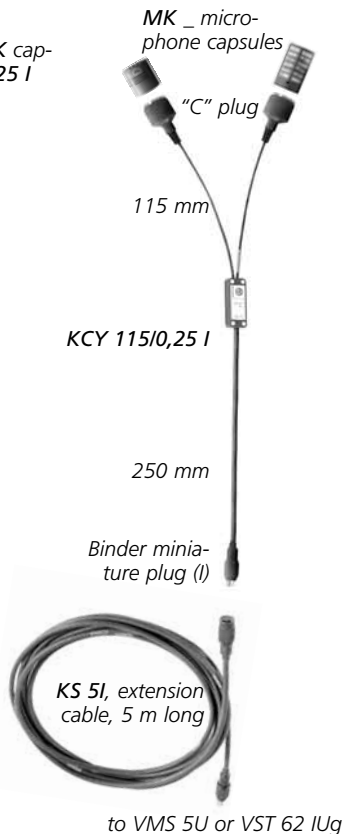

Example: outdoor version of the AMS CI which, with a windscreen, becomes the WSR MS CI; diameter of the basket: 150 mm

WJ MSIXY Windjammer; accessory (fur-like "overcoat") for WSR MS CI, -LI, -LU

AMS LU

= indoor version for CCM microphones; with KLY 115/0,25 SU cable



AMS LI

= indoor version for CCM microphones; with KLY 115/0,25 I cable



Basket Windscreen with elastic suspension for CCM_L WSR MS 100 LU

- M/S stereo version of the WSR 100 LU
- cable: internal: extraordinarily flexible, external: robust
- optional: Windjammer, a fur-like "overcoat" which enhances the effectiveness

The cable from the CCM and the output cable join together at the small "Connbox." The output cable is permanently connected to this box, but the cable from the CCM itself is attached by means of a miniature connector. This allows the rapid exchange of the cable when necessary.

Basket diameter: 100 mm
Length of the output cable: 16 cm
Output connector: XLR-5M



Connbox



WJ 100 LU Windjammer

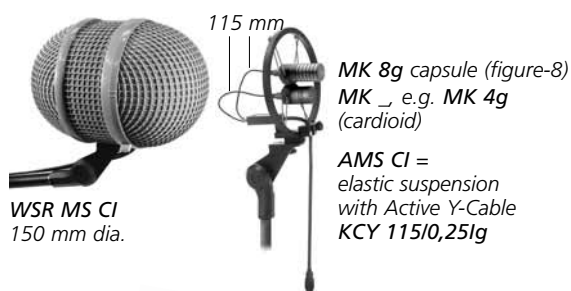

WSR MS CI
150 mm dia.

MK 8g capsule (figure-8)
MK _g, e.g. MK 4g
(cardioid)

AMS CI =
elastic suspension
with Active Y-Cable
KCY 115/0,25lg



extension
e.g. KS 5 I (5m)



VMS 5 U
stereo microphone preamplifier
with M/S matrix, page 106



WJ MSIXY Windjammer;
(fur-like "overcoat")



... with the Modular System

This approach to M/S recording takes advantage of the modular nature of the Colette System, and might be preferred by those who already own one or more of the Colette capsules involved.

- WSR MS CI basket windscreen for M/S with AMS CI elastic suspension (including pre-mounted Active Y-Cable KCY 115/0,25lg), without capsules. (Version without pre-mounted cable: WSR MS, which can be used with the more common KC Active Cables).
- Windjammer fur-like "overcoat" for the WSR MS CI, to increase resistance to wind noise
- MK _g microphone capsule for the M channel, e.g. MK 4g (cardioid) or MK 41g (supercardioid, for higher directivity)
- MK 8g capsule with bidirectional characteristic for the S channel
- KCY 115/0,25lg Active Y-Cable with 25 cm single end piece. The two branches (115 mm long) which connect to the capsules are made from a special material that is designed to remain flexible even at sub-freezing temperatures.
Note: The KCY is also available with 5 meter output cable (KCY 115/5lg), but handling and storage are easier with the shorter cable; the extension cable (KS 5 I) can be simply attached or removed.
- KS 5 I extension cable (5 m long), necessary for the KCY 115/0,25lg
- VMS 5 U special powering unit for capsules with Active Cable; contains microphone preamplifier, M/S matrix and headphone output. Instead of the VMS 5 U, the stereo microphone amplifier VST 62 IUg or two CMC microphone amplifiers – via adapter cable AK I/2C – can be used. The latter combination allows the variable low-cut filter CUT 1 or CUT 2 to be used as well.

... with CCM_L Compact Microphones

This version is the one which we recommend particularly to our newer customers since the Y-cable is the only component specially required for this application. The microphones themselves are in no way limited to use only for M/S recording.

WSR MS LI	basket windscreens for M/S with AMS LI elastic suspension (pre-mounted Y-cable KLY 115/0,25U is included), without microphones. (Version without pre-mounted cable: WSR MS)
Windjammer	fur-like "overcoat" for WSR MS, to increase its resistance to wind noise
CCM 4 Lg	cardioid compact microphone for the M channel; a CCM 41Lg supercardioid can be used when greater directivity is needed
CCM 8 Lg	compact microphone with bidirectional characteristic for the S channel
KLY 115/0,25I	Y-cable; the single end piece is 25 cm long. The two branches (115 mm long) which connect to the capsules are made from a special material that is designed to remain flexible even at sub-freezing temperatures (-20° C). Note: The KLY is also available with 5 meter output cable (KLY 115/5lg), but handling and storage are easier with the shorter cable; the extension cable (KS 5 IU) can be simply attached or removed.
KS 5 IU	stereo adapter and extension cable to XLR-5M
AK SU/2U	adapter cable XLR-5F to 2 × XLR-3M
VMS 5 U	microphone preamplifier with phantom powering, M/S matrix and headphone output

The windscreen is also available in the WSR MS LU version with an XLR-5M plug instead of the miniature Binder connector.



WSR MS LI, 150 mm dia.

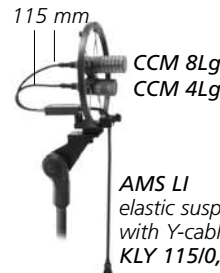

AMS LI elastic suspension with Y-cable KLY 115/0,25 I



WSR MS 100 LU 100 mm dia.



extension and adapter KS 5 IU (5m)



AK SU/2U adapter cable XLR-5F/2 × XLR-3M page 116



VMS 5 U stereo microphone preamplifier with M/S matrix, page 106



Windjammer (fur-like "overcoat"): for WSR MS LI: WJ MSIXY for WSR MS 100 LU: WJ 100 LU

The parts shown here as being needed for M/S stereo recording are available as a complete "M/S Stereo Set:"
 1 × WSR MS LI, 1 × WJ MS/XY Windjammer,
 1 × KS 5 IU, 1 × AK SU/2U,
 1 × CCM 8 Lg (figure-8), including K 5 LU adapter cable (Lemo/XLR-3M), SGC stand mount and polished wood case,
 1 × CCM 4 Lg (cardioid); included accessories: as with CCM 8 Lg
 The supercardioid CCM 41 L can be substituted for the cardioid CCM 4 L at a slight increase in cost.
 Optional: active low-cut filter LC 60

M/S and ORTF Stereo



COLETTE
modular



Adapter for M/S using Boundary-Layer Technique MS-BLM

For the BLM 3g boundary-layer capsule and MK 8 microphone capsule with Active KC Cable or CCM 8U compact microphone

COLETTE
modular



Universal Stereo Bracket UMS 20

- for two microphones of the Colette modular system (e.g. CMC, 20 mm diameter)
- for M/S, Blumlein, ORTF, XY

Matching windscreen for M/S: WMS 129

COLETTE
modular



Elastic Suspension for M/S AMS 22

- for two standard microphones of the Colette modular system (e.g. CMC, 20mm diameter)

Its base has a 5/8"-27 NS internal thread. A threaded adapter is supplied for 3/8" and 1/2" mounting.

Color: gray /matte gray
Matching windscreen: WMS



ORTF Stereo

COLETTE
modular



STCg, rear view



ORTF Mounting Bar STCg

Thread: 5/8"-27 NS, with adapter for 3/8" and 1/2"
The SG 20 stand clamp is included.

CCM
compact



Miniature Stereo Mounting Bar M 100 C (page 96)

ORTF is a well-proven method of near-coincident stereo recording that uses two cardioids. For more information please see the following page as well as page 131 in the technical appendix.

COLETTE
modular



Universal Stereo Bracket UMS 20

- for two standard microphones of the Colette modular system (e.g. CMC, 20mm diameter)
 - for ORTF, Blumlein, M/S, XY
- More on the UMS 20: page 114

**ORTF Stereo Microphone
MSTC 64**

- for recordings with ORTF technique
- placement relatively uncritical
- good stereo imaging
- for a very wide range of recording applications
- for 12/48 V phantom powering

This microphone consists of a T-shaped body with two built-in microphone amplifiers, and a matched pair of MK 4 cardioid capsules of the Colette modular system which are mounted 170 mm apart with an included angle of 110° (ORTF system). The stereophonic recording angle⁺ is 95°.

This is probably the simplest stereo technique in general use. In almost any situation it produces an evenly-spread stereo image with good localization, often without the need for spot or ambient miking. Setup is particularly quick and simple since the capsule spacing and angles are fixed, with only a single stand and microphone cable required. Placement is relatively uncritical and the technique produces good results even in the hands of an inexperienced or hasty user.

The MSTC 64 accepts any 12 V or 48 V standardized phantom powering, with the maximum sound pressure level being slightly reduced (ca. 4 dB) when powered by 12 V.

The two MK 4g capsules included with the MSTC 64g are a specially selected, matched pair.

The designation MSTC 64g refers to a dual microphone amplifier MSTC 6g equipped with two MK 4g cardioid capsules.

Surface finish: matte gray (g) or nickel (ni)

Technical Specifications

of the MSTC 64, measured on the axis of the MK 4 capsules:

Recording angle⁺: ca. 95°
 Frequency range: 40 Hz – 20 kHz
 Sensitivity: 13 mV/Pa
 Equivalent noise level, CCIR^{**}: 24 dB
 Equivalent noise level, A-weighted^{*}: 15 dB-A
 Signal-to-noise ratio, A-weighted^{*}: 79 dB-A
 Maximum SPL for 0.5% THD: 132 dB-SPL
 Output voltage at maximum SPL: 1V
 Source impedance: 35 Ohm
 Minimum recommended load: 600 Ohm
 Powering: 12 V ± 1 V or 48 V ± 4 V phantom
 Current consumption per channel:
 4 mA, independent of the supply voltage
 Weight: ca. 230 g
 Pin assignment (XLR-5M): see page 133

^{*}IEC 61672-1, ^{**}IEC 60268-1



ORTF microphone MSTC 64 Ug
 B 5 D windscreens, pg. 125
 A 20 S elastic suspension, pg. 57

MSTC 64 Ug with
 BBG windscreens:



without Windjammers



with WJ BBG Windjammers

Accessories (included):

polished wood case, SG 20 stand clamp

In many situations the use of an elastic suspension is advisable. Due to the weight of the MSTC, the A 20 S with its stiffer elastics should be used.

popscreens and windscreens for the MSTC 64 are described in the section beginning on page 119.

⁺This is the range within which the sound sources should be placed, as "seen" by the microphone.



CMXY 4V Ug
actual size

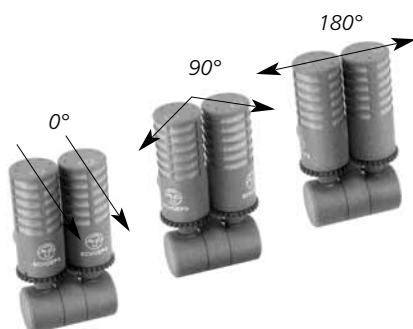

The angle between the microphone's axes can be adjusted continuously in the range from 0° to 180°.

X/Y Stereo Microphone CMXY 4V

- 2 × cardioid with lateral pickup
- compact, elegant and lightweight
- for a very wide range of recording applications
- with XLR-5M or miniature output connector

The CMXY 4V is a compact and versatile X/Y stereo microphone which is both elegant and very unobtrusive. Its mild high-frequency boost increases the intelligibility of speech and compensates for high-frequency losses typical of moderate recording distances. It thus lends itself ideally to music recordings, TV and broadcast use, e.g. on a table for discussions, for presenters, boom operations or as a stereo spot microphone on a stand.

The side-by-side arrangement of capsules is somewhat unusual. But there can never be perfect three-dimensional coincidence between any two microphones, and the distance between center points of the capsules in a CMXY is only 21 mm. While this distance is in the horizontal plane, it is considerably less than the vertical distance between capsules in most other stereo microphones of professional quality. Thus the precision of stereo imaging and mono compatibility are fully in keeping with established professional requirements. The overall width of the two microphones combined is similar to (often less than) the diameter of a conventional stereo microphone's capsule assembly. This is possible by using the smallest non-electret condenser microphones with balanced outputs, the CCM Compact Condenser Microphones.

Unlike conventional microphones which have one fixed and one rotatable capsule, the angle between the capsules of the CMXY 4V (and hence the recording angle⁺) can be adjusted without affecting the main stereo axis. The capsules always rotate equally and in opposite directions by means of an ingenious gear arrangement in the base of the microphone. This greatly simplifies setting up the microphone.

The CMXY 4V has balanced outputs at an impedance of only 90 Ohms. This allows cable lengths of up to several hundred meters to be used without loss of sound quality, while the risk of electromagnetic interference is greatly reduced.

Two versions are available (see on top of the next page):

CMXY 4V Ig: miniature output connector;

the KS 5 IU adapter cable to XLR-5M is included.

CMXY 4V Ug: XLR-5M output plug

The adapter cable AK SU/2U (XLR-5F to 2 × XLR-3M) is included.

Surface finish: matte gray (g)

Accessory (included): polished wood case

Technical Specifications:

Polar pattern:	2 × cardioid with lateral pickup (CCM 4V)
Frequency range:	40 Hz – 20 kHz
Maximum SPL:	132 dB SPL at 0.5%THD
Equivalent noise level:	14 dB-A*, 24 dB (CCIR**)
Phantom powering:	12 V ± 1 V (8 mA) or 48 V ± 4 V (4 mA), automatically switched
Impedance:	90 Ohms
Max. output voltage:	ca. 1 Volt
Length:	I-version: 110 mm, U-version: 119 mm
Maximum width:	43 mm
Maximum depth:	22 mm
Weight:	190 g

*IEC 61672-1, **IEC 60268-1

⁺This is the range within which the sound sources should be placed, as "seen" by the microphone.

CMXY 4V Ig



WMS
windscreen

A 20 S
elastic
suspension

KS 5 IU
adapter cable



CMXY 4V Ig
suspended



WSR CMXY
basket-type windscreen with
A 20 CMXY elastic suspension
(modified A 20 S)



WSR CMXY Wind-
jammer ; fur-like
"overcoat"

CMXY 4V Ug



A 20 S
elastic
suspension



Notes:

If the "basket"-type windscreen WSR CMXY is to be used, the version of the microphone with miniature output connector ("I") would be preferable. If the version with XLR-5M connector ("U") must be used with this windscreen, a short (right-angle) XLR connector is required on the cable to avoid its scraping against the inside of the "basket."

When any microphone is placed near (but not directly onto) a flat surface, comb-filter effects will occur. These can be reduced if the surface (e.g. the table top) consists of a perforated material.



COLETTE
modular



Universal Stereo Bracket UMS 20

- for two STANDARD microphones of the Colette modular system (e.g. CMC, 20 mm diameter)
- for M/S, Blumlein, ORTF, X/Y

For further information: see page 114

COLETTE
modular
CCM
compact



Miniature Stereo Mounting Bar M 100 C

- for X/Y and ORTF

Suitable axially addressed microphones: MK 4 microphone capsule or CCM 4 U/L compact microphone,
Suitable laterally addressed microphones: MK 4V microphone capsule or CCM 4V U/L compact microphone

For critical applications the M 100 C can be suspended in an A 20 S shock mount with the aid of the ST 20-3/8 mounting cylinder. Alternatively, it can be suspended from a cable by means of the H 20g cable hanger.

The entire bar is hinged so that it can be tilted forward or backward.

Mounting adapter: 5/8" - 27 NS, with adapter to 3/8" and 1/2"

Color: black anodized



Surround Sets



	page
<i>Sphere Surround</i>	97
<i>OCT/OCT Surround</i>	100
<i>"Double M/S"</i>	101
<i>"IRT Cross"</i>	103



DSP-4 KFM 360
processor unit with built-in A/D and
D/A converters

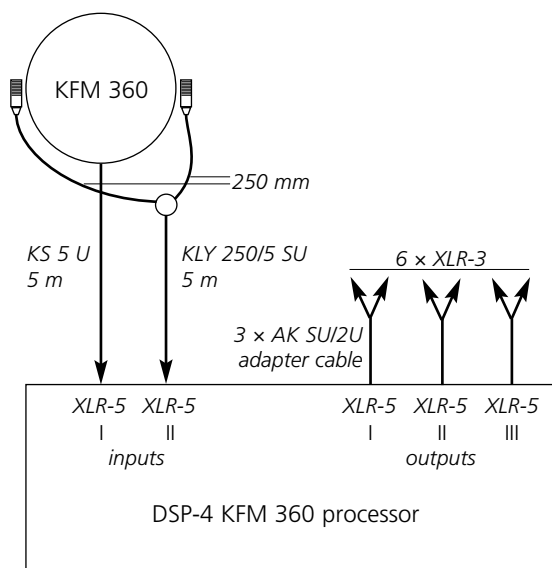

*This is the range within which the sound sources should be placed, as "seen" by the microphone.

Surround Microphone System by Bruck with KFM 360 and DSP-4 KFM 360

- compact, highly effective arrangement
- extensive capability for post-processing in digital domain (many important parameters can be adjusted after the recording has been made)
- digital and analog inputs and outputs
- analog-style controls
- user preference settings can be stored and recalled

The central unit in this system is the KFM 360 sphere microphone. It uses two pressure transducers and can also be used for stereophonic recording. Its recording angle⁺ is ca. 120°, thus permitting closer miking than the pure stereo microphone KFM 6 (90°). The necessary high-frequency compensation for the pressure transducers is built into the processor unit.

Surround capability is achieved through the use of two figure-8 microphones, which can be attached next to the pressure transducers by an adjustable, detachable clamp system with bayonet-style connectors (SGC-KFM). The main axes of these two microphones should be aimed precisely forward.

The DSP-4 KFM 360 processor derives the four "corner" channels (L, R, LS, RS) from the microphone signals. A center channel signal is obtained from the two front signals. An additional output channel is provided which carries only the frequencies below 70 Hz. To avoid perceiving the presence of the rear loudspeakers one can lower the level of their signals, delay them and/or set an upper limit on their frequency response.

The front stereo image width is adjustable, and the directional patterns of the front-facing and rear-facing pairs of "virtual microphones" (see "Operating principle" below) can be chosen independently of one another.

The processor unit offers both analog and digital inputs for the microphone signals. In addition to providing gain, it offers high-frequency compensation for the pressure transducers as well as low-frequency compensation for the figure-8s.

As with M/S recording, matrixing can be performed during post-production. All matrixing in the DSP-4 is performed in the digital domain.

Operating principle:

The front and rear channels result from the sum (front) and difference (rear) of the omnidirectional and figure-8 microphones on each side respectively (see illustration on the next page). The four resulting "virtual microphones" which this process creates will seem to be aimed forward and backward, as the figure-8s are. At higher frequencies, however, they will seem to be aimed further outward. Their directional pattern can be varied anywhere from omnidirectional to cardioid to figure-8; the pattern of the two rear-facing virtual microphones can be different from that of the two forward-facing ones. Altering the directional patterns alters the sound as well, in ways that are not possible with ordinary equalizers. This permits a flexible means



of adapting to a recording situation – to the acoustic conditions in the recording space – and this can even be done during post-production if the unprocessed microphone signals are recorded.

The signals from the four “virtual microphones” comprise a type of surround reproduction which is valid in its own terms but lacks the center channel and low-frequency channel of the standard 5.1 approach, so these additional facilities are provided by the digital signal processor.

The complete KFM surround set consists of:

- KFM 360 sphere microphone
- 1 x KG ball-and-socket joint for mounting on a stand
- 2 x CCM 8 L compact microphone (as a matched pair); included: K 5 LU adapter cable (Lemo/XLR-3M), SGC stand mount with swivel and a polished wood case
- 2 x SGC-KFM mounting clamp for CCM 8
- DSP-4 KFM processor with mains cable and wood case
- 3 x AK SU/2U adapter cable (XLR-5F to 2 x XLR-3M) for connecting the processor’s analog outputs
- 1 x KS 5U stereo cable for connecting the KFM 360 (5 m long; advantage: only one cable is necessary for two channels)
- 1 x KLY 250/5 SU, Y-cable, 5 m long, for connecting the two CCM 8 to the processor

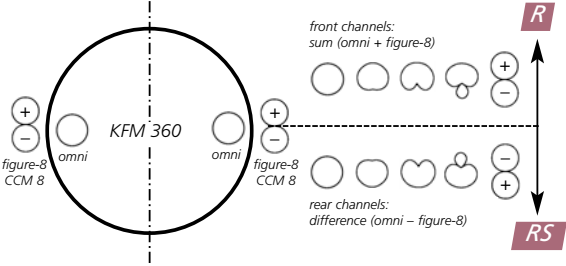

Operating principle: derivation of right (R) and right surround (RS) signals (rough diagram)

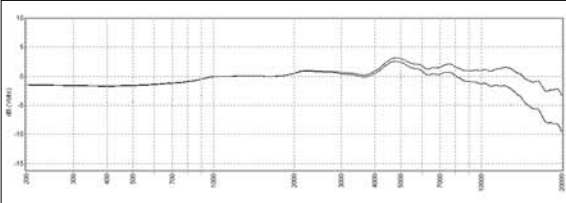

Frequency response curves showing the effect of the processor’s built-in corrective equalization (before/after)

Available separately:
for the KS 5 U and KLY 250/5 SU cables:
 extension cables (e.g. KS 10 U, 10 m; KS 20 U, 20 m)
for the KFM 360:
 KKFMM wood case and HKFM suspension device.
 When a KFM 360 is ordered separately, it comes with 1 x KG, 2 x SGC-KFM, 1 x AK SU/2U (XLR-5F / 2 x XLR-3M)

Technical Specifications:

- KFM 360**
- for 12 V ± 1 V (8 mA), 48 V ± 4 V (4 mA) phantom powering
 - 2 pressure transducers, built into the sphere
 - diameter: 18 cm
 - recording angle⁺: ca. 120°
 - weight: 800 g

CCM 8L
 figure-8, for technical specifications: see page 27

DSP-4 KFM 360
Analog inputs (2 x 2, XLR-5F, balanced, transformerless, 48 V phantom powering, 20 kOhm):
 “Analogue Mic Gain”: “+10 dB” | “+20 dB”
 Maximum input level: -4 dBu | -14 dBu
 Maximum SPL
 KFM 360: 130 dB-SPL | 120 dB-SPL
 (The digital output level can be adjusted.)

Analog outputs: 3 x 2, XLR-5M, balanced, transformerless, 100 Ohms, max. 6 dBV (2V_{rms}):
 REC mode: outputs I, II: unprocessed input signals, output III: Monitor;
 SURR. mode: output I: L, R; output II: C, LFE; output III: SL, SR

Maximum analog output level: +6 dBu
 Digital inputs/outputs: channel assignment just as with the analog outputs; data format: 24 bit AES/EBU
Digital inputs: 2 x 2, XLR-3F
Digital outputs: 3 x 2, XLR-3M
 synchronization/sample rate:;
 with internal synchronization: 44.1 / 48 / 96 kHz
 with external synchronization (through master inputs): 25 – 100 kHz
 Elevation of the digital level: max. 33 dB
 Dynamic range:
 A/D converter: 98 dB (peak) CCIR
 110 dB (rms) unweighted
 D/A converter: 100 dB (peak) CCIR
 113 dB (rms) unweighted
 Characteristic impedance of the cable connected to the digital outputs: 110 Ohms
 Mains voltage: switchable 110 – 120 V / 220 – 240 V
 Power consumption: 15 VA
 Fuse: 230 V: 100 mA slow blow; 110 V: 200 mA slow blow
 Dimensions (W x H x D) 22 x 9 x 24.6 cm
 about 8.7" x 3.5" x 9.7"
 Weight: 2.7 kg (about 6 lbs)



COLETTE
modular
CCM
compact

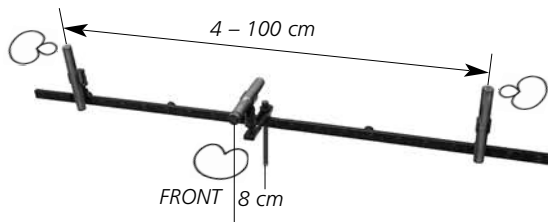

OCT stereo bar MAB 1000
Microphones:
center: MK 4 cardioid + CMC 6 or CCM 4
sides: 2 x MK 41V supercardioid + CMC 6
or CCM 41V

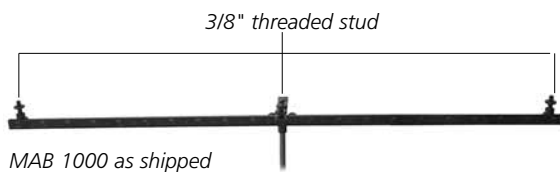

MAB 1000 as shipped



COLETTE
modular
CCM
compact

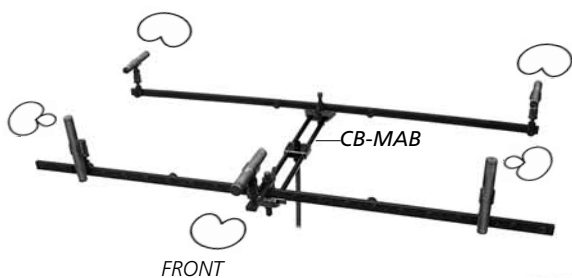

OCT surround setup:
2 x A/B/OCT stereo bar MAB 1000
1 x mounting bracket CB-MAB
Microphones:
center: MK 4 cardioid + CMC 6 or CCM 4
sides: 2 x MK 41V supercardioid + CMC 6
or CCM 41V
rear: 2 x MK 4 + CMC 6 or CCM 4



KMAB 1000

OCT Stereo Bar (by Günther Theile, IRT Munich, Germany) MAB 1000

- for recording the three front channels for surround
- can also be used for A/B stereo (spaced omni recording)
- recording angle[†]: 90 – 160°
- good separation between the L/C and R/C sectors
- distance between microphones: 4 – 100 cm
- can be expanded for five-channel OCT surround

The OCT (Optimized Cardioid Triangle) is a well-designed method for obtaining the front channels for a convincing surround recording of music. A detailed description of the OCT technique can be found on page 132 in the technical appendix.

This 1-meter-long mounting bar has 3/8" threaded attachments for three stand adapters or shock mounts (not included). The microphones can be positioned anywhere along the bar. Each side of the bar is engraved with markings every 2.5 cm so that distances of 5 cm, 10 cm, 15 cm, etc. can easily be set between the two outer microphones.

Please note: Stand adapters or shock mounts must be ordered separately. Recommended stand clamps or shock mounts: SG or A 20 for Colette-series microphones (e.g. CMC); SGC or AC for CCM-series microphones. A standard extension bar for the forward-facing cardioid in OCT is included; a longer arm for the OCT 2 variant is optional.

Thread: 3/8", length: 1000 mm, weight: 500 g

OCT Surround Setup (by Günther Theile, IRT Munich, Germany)

- for recording five-channel surround
- the simplest and most compact arrangement for surround recording with OCT

A complete OCT surround setup is obtained by adding a mounting bracket (CB-MAB) along with a second MAB 1000 stereo bar for the rear-channel microphones.

Further information:
see page 132 and www.hauptmikrofon.de

Accessories (included): KMAB 1000, robust, foam-lined carrying case for the two MAB 1000 mounting bars and the CB-MAB mounting bracket

[†]This is the range within which the sound sources should be placed, as "seen" by the microphone.



"Double M/S" Surround with Double MS Set

- requires only three microphones and channels for 5.0 surround
- very small, lightweight array
- can be well protected against wind (with "fur" Windjammer)
- matrixing can be performed during or after recording

"Double M/S" is an improved version of the well-known M/S stereo recording technique. In addition to a front-facing cardioid or supercardioid "mid" microphone and a figure-8 "side" microphone, a rear-facing directional microphone is set up (see illustration at right). The front- and rear-facing microphones share the signal of the figure-8 microphone so as to form two complete, back-to-back M/S systems. One M/S system then provides the three front channels (the center channel signal being provided directly by the mid microphone of the front system), while the other system provides the two surround channels. An arrangement of this kind allows flexible processing of the stereo surround image width and post-production adjustment for both of the M/S pairs.

The microphones and accessories for Double M/S recording are available in three different sets:

1. Double M/S Set with Splitter
 - 2 x CCM 4VL cardioid compact microphones (or a CCM 41VL supercardioid can be substituted for the forward-facing cardioid at a small increase in price)
 - 1 x CCM 8L figure-8 compact microphone
 - special shock mount for the three compact microphones
 - adapter cable from three Lemo plugs to one XLR-7 output
 - WSR DMS LU basket-type windscreen
 - WJ DMS "Windjammer" windscreen cover
 - KDMS 5U 5-meter (16.5') XLR-7 extension cable
 - DMS passive splitter box
2. Double M/S Set with MDMS

As above, but with the M DMS U matrix box (see next page) in place of the DMS splitter box

Note: The CCM 41V supercardioid is not an option for this set.
3. Double M/S Set with CMIT
 - 1 x CMIT 5 U shotgun microphone
 - 1 x CCM 8L figure-8 compact microphone
 - 1 x CCM 4L cardioid compact microphone
 - shock mount for a CMIT 5 U shotgun microphone with KMSC clips for the two compact microphones
 - adapter cable from two Lemo plugs and one XLR-3 plug to one XLR-7 output
 - WSR DMS CMIT LU basket-type windscreen
 - WJ DMS CMIT "Windjammer" windscreen cover
 - KDMS 5U 5-meter (16.5') XLR-7 extension cable
 - DMS passive splitter box

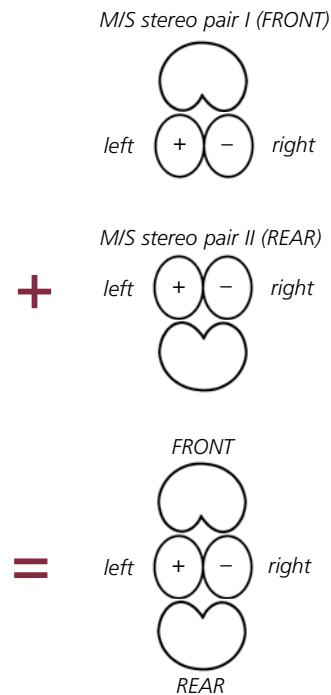

Double M/S viewed from top; for reasons of clarity, not drawn one above the other (coincident).

Double M/S Set with Splitter:

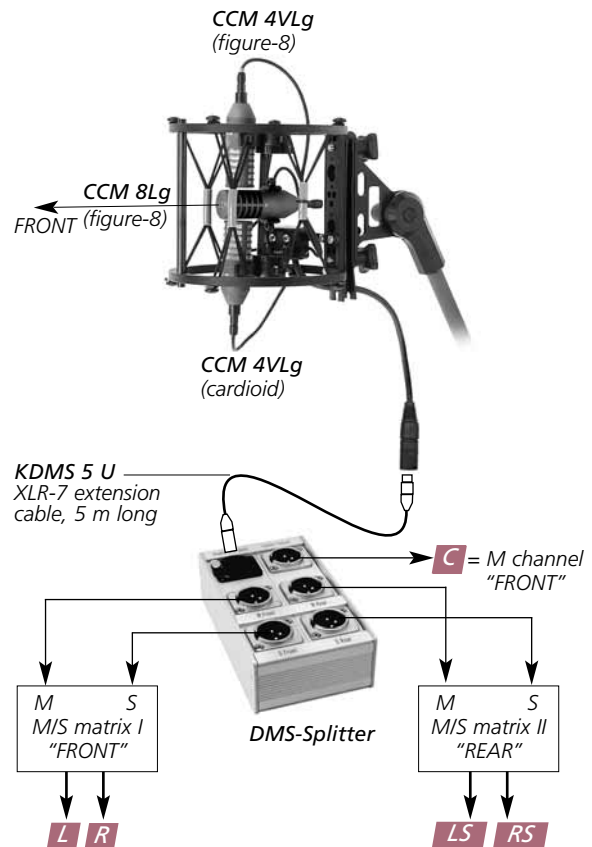

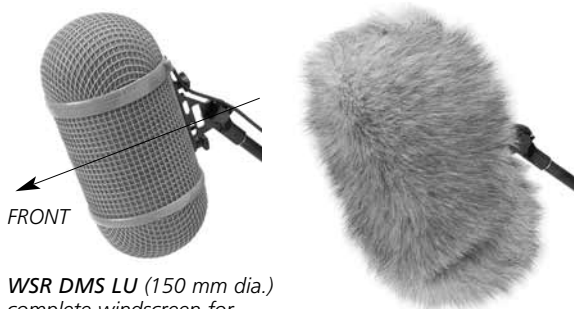

WSR DMS LU (150 mm dia.)
complete windscreen for
Double M/S Set "Splitter"
and "MDMS"

WJ DMS Windjammer
(fur-like cover for enhancing the
protection against wind noise)

Double M/S Set with MDMS:

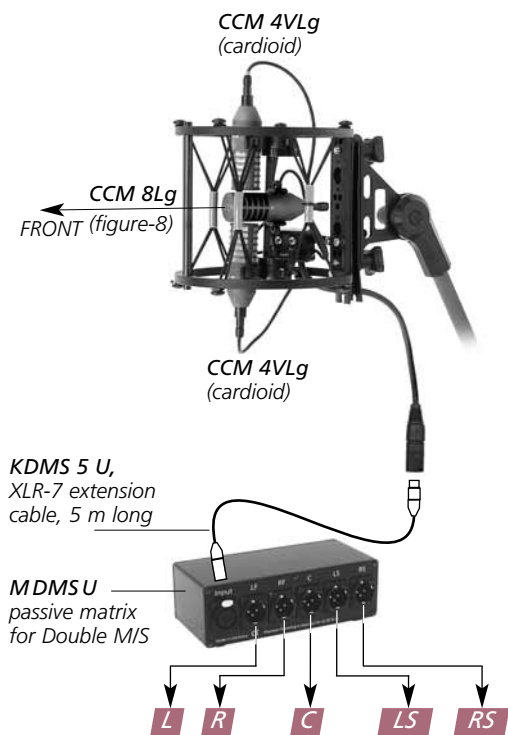

New!

KDMS 5 U,
XLR-7 extension
cable, 5 m long

MDMS U
passive matrix
for Double M/S

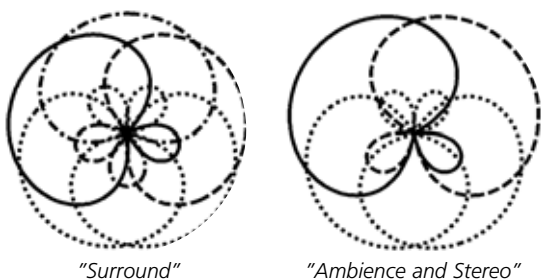

The directional patterns which are effectively created by
matrixing the output signals from the MDMS in "Surround"
mode (above left) and in "Ambience and Stereo" mode
(above right)

1. Double M/S Set with Splitter

The DMS splitter box is a passive device that simplifies connecting a double M/S microphone array to the phantom-powered inputs of preamplifiers or mixers that contain matrixing circuitry (e.g. 2 × SCHOEPS VMS 5 U). It divides the three signals into five (the center channel plus the front- and rear-facing M/S pairs), and prevents the two microphones which serve dual functions from being powered twice.

2. Double M/S Set with MDMS

The SCHOEPS MDMS matrix is, in all respects, the simplest and most elegant way to obtain surround signals. It is a small, sturdy box with high-quality transformers forming a passive decoder matrix. Microphone signals are converted directly into 5.0 L/R/C/LS/RS surround signals. A second, switchable mode supplies four signals with no center-channel output.

The matrix parameters have been chosen so that the resulting signals correspond to an optimal arrangement (as shown at left) while avoiding unwanted artifacts. Both settings have the following characteristics:

- minimal overlap (crosstalk)
- optimal pickup balance in all directions
- well-balanced 360° localization capability
- optimal constancy of total levels across 360°
- minimal pickup via the rear lobe (< -11 dB)

The matrix settings were determined through extensive practical testing, including ambient recordings, television shows, and theatrical and musical performances. In general the best possible results will be those obtained by using the output signals of the MDMS matrix directly.

Our investigations also considered other ways to optimize the functioning of the double M/S sets in concert halls and other typical settings in which surround recordings must maintain a fundamental front-back distinction. For example, delaying the surround-channel signals can improve the perception of spaciousness and avoid localization errors throughout a wider listening area. As a further measure to improve the spatial impression, the double M/S array can be augmented with more distantly-placed room microphones.

Phantom powering is required on only three of the inputs to which the MDMS is connected.

Note: The coefficients of the MDMS have been set for use with a front-facing SCHOEPS cardioid microphone. Unfortunately, the supercardioid or shotgun alternatives of the other Double M/S sets would not produce suitable results with this arrangement.

A "Double M/S" VST plug-in for Windows can be obtained by filling in a registration form at www.schoeps.de/dmsplugin.html. This plug-in supports simple, intuitive decoding of the three microphone signals.



New!

3. Double M/S Set with CMIT

Instead of a cardioid microphone for the front M channel, our CMIT 5 "shotgun" microphone can be used, with the other two microphones (the side-facing figure-8 and the rear-facing cardioid) attached to it via two KMSC double microphone clips. A special, longer windscreen is provided. This set works well with the DMS splitter box as described previously.

Output connector: XLR-7

Two options for the surround sets:

If the microphone signals are to be recorded directly and processed only later, an optional XLR-7 to 3 x XLR-3 adapter cable (model AK DMS 3U) can be used in place of the splitter box.

Similarly, the AK 3U DMS adapter cable (3 x XLR-3F to XLR-7M) is available so that the splitter box or matrix can be positioned at the far end of a multi-core extension cable.

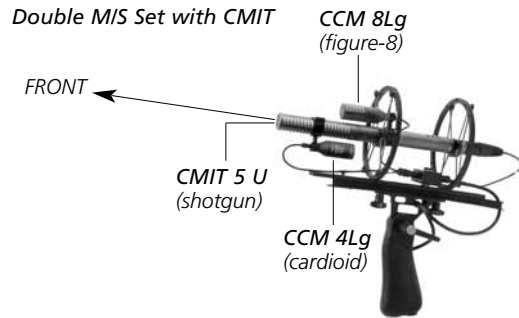

WSR DMS CMIT LU (150 mm dia.)

Ambient/Surround Recording Array: "IRT Cross" Mounting Bars CB 250, CB 200

The IRT microphone cross is an arrangement for ambient recording. Its primary characteristic is a transparent and spacious rendering of the acoustic environment. It is useful as a four-channel arrangement for room tone (for example in combination with the OCT surround system, see pages 100 and 132) and can also be used for full surround (e.g. 360° cinema sound recording or for other playback arrangements in which the speakers are placed in the four corners of a square).

The CB 250 is the version which more closely approximates the theoretical ideal, while the CB 200 is the original, somewhat smaller version.

CB 140

A modified form of IRT Cross exists for supercardioids as well. Since the distance between microphones is only 140 mm, the cross itself is distinctly smaller.

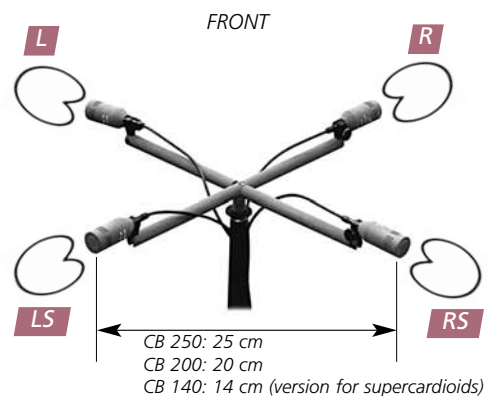

IRT cross mounting bars CB 250 and CB 200:
4 x cardioid CCM 4 / CCM 4V
or MK 4 / MK 4V with Active KC Cable

CB 140 cross:
4x supercardioid CCM 41 / CCM 41V
or MK 41 / MK 41V with Active KC Cable

COLETTE
modular
CCM
compact





Microphone Preamplifier





COLETTE
modular
CCM
compact



rear panel, as seen from above



underside



Stereo Microphone Preamplifier with Phantom Powering and M/S Matrix VMS 5 U

- frequency response: 20 Hz – 80 kHz (-3 dB)
- two low-cut filters: 20 Hz (permanent) and 150 Hz (switchable)
- switchable M/S matrix
- switch for “swapping” channels with M/S recording
- switchable 48-Volt phantom power; the ability to disable phantom powering is important for M/S post-production
- inputs: XLR-3F (balanced) and special socket for Active Y-Cable of the Colette modular system
- outputs: XLR-3M (balanced); easy connection to unbalanced inputs without loss of signal level
- can run from six internal batteries (primary or rechargeable) or from externally supplied DC
- glitch-free, automatic switchover to internal batteries in the event of AC power loss
- battery level meter and low-voltage warning LED
- protection from accidental overdischarge of internal NiCads
- automatic shutoff if voltage gets too low
- headphone monitor output
- gold-plated sockets and switch contacts for long service life
- black all-metal housing (aluminum)

Battery-operated microphone preamplifiers sometimes have high noise figures because current consumption is kept limited in the interests of longer battery life. But the VMS 5 U places hardly any such limitation on the performance of the microphones. In addition, its frequency response leaves nothing to be desired.

One of the characteristics of high-quality equipment is durability. It may be several years before you find out whether the potentiometers and switches on a unit will become noisy when used. In the design of this product, SCHOEPS placed the primary emphasis on reliability and durability, choosing all its components (such as switches and sockets with gold-plated contacts) accordingly.

The unit shuts itself off if the battery voltage falls beneath a certain threshold value, in order to prevent completely draining the batteries and possibly damaging circuit components.

A further quality feature is the all-metal housing, which is unbreakable and protects against radiated electromagnetic interference.

For increased ease of use, the lettering on the back panel is printed upside down relative to the front panel, so that it is unnecessary to turn the unit around in order to read the labeling.

The VMS 5 U with its universal power supply capability and compact dimensions is equally well suited for portable or fixed operation.

A set of batteries is included with the unit.
Available separately: AC power adapter VMS 5 DC-W,
 a high-quality off-line switching power supply for 90 –
 264 Volt AC.



VMS 5 DC-W

A special version (VMS 5 U lin.) without the fixed 20 Hz
 low-cut filter is available for measurement applications.
 This version is not recommended for audio applications
 because of the possibility of infrasonic noise problems.

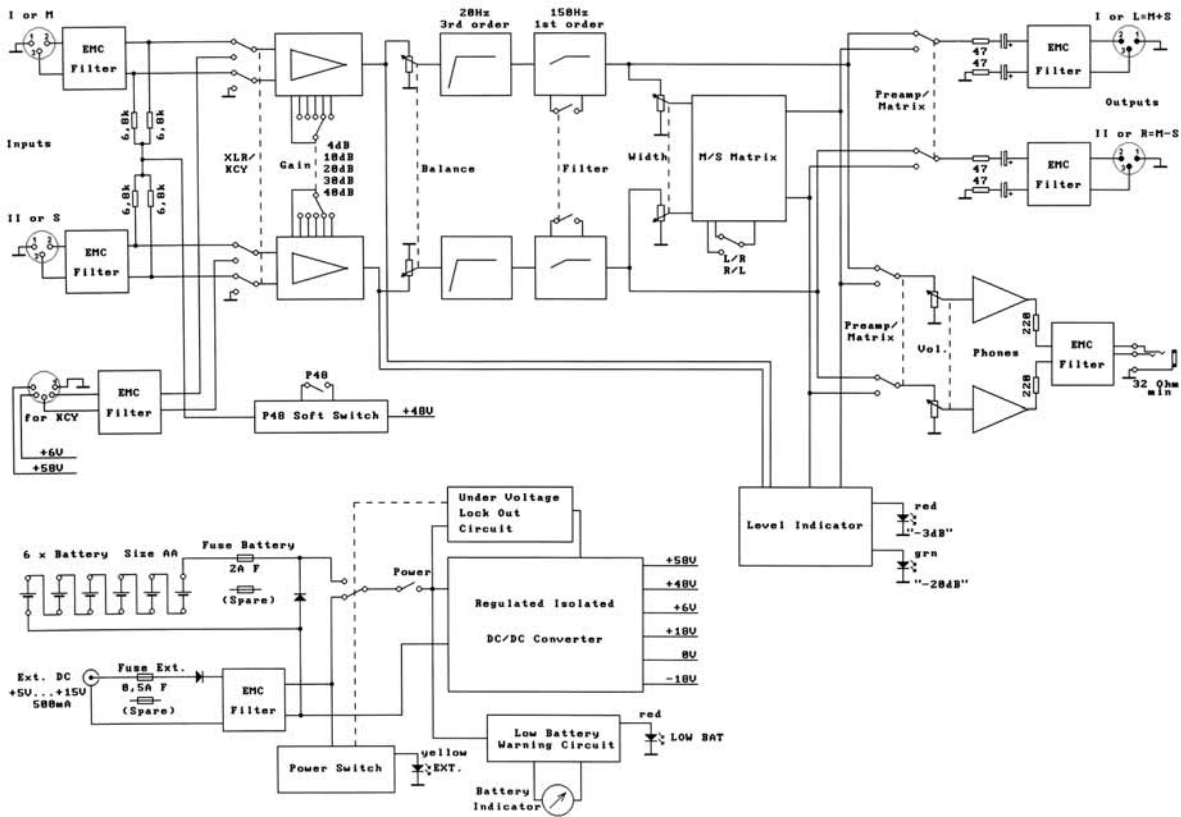

Block diagram of the VMS 5 U microphone preamplifier

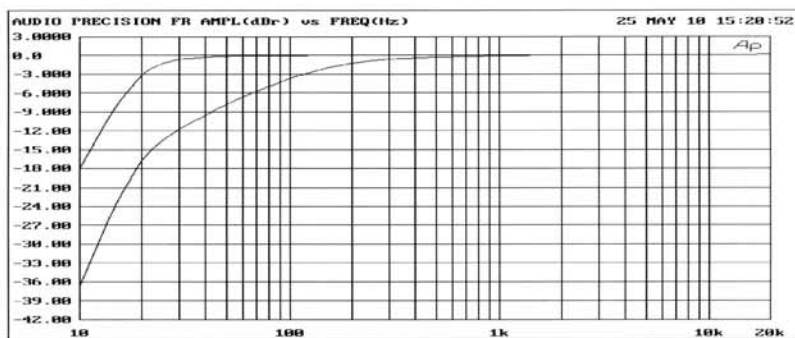

Frequency response curves with (below) and without (above) the switchable low-cut filter



Technical Specifications:

Inputs

Switchable between two XLR-3F sockets and a special input for the SCHOEPS KCY Active Cable.

XLR inputs are balanced and transformerless; the 48-Volt phantom powering is switchable (for subsequent M/S dematrixing).

Input impedance: 20 kOhms

Frequency range: 20 Hz – 80 kHz (-3 dB)

Recommended minimum sensitivity of microphones at XLR inputs: 8 mV/Pa

Maximum input level for <0.5% THD:

at 4 dB gain setting: 14 dBV (5V_{rms})

at 20 dB gain setting: -2.2 dBV (780 mV_{rms})

Preamplifier gain settings: 4, 10, 20, 30 or 40 dB

Overall performance specifications of VMS 5 U with SCHOEPS CMC 6 microphone amplifier and MK 4 capsule (cardioid):

Maximum sound pressure level at 0.5% THD and equivalent noise level according as a function of gain:

gain:	4 dB	10 dB	20 dB	30 dB	40 dB
max SPL/dB:	132	132	130	120	109
L _{noise} /dB CCIR**:	27.5	26.5	26	26	25.5
L _{noise} /dB-A*:	16.5	16	15.5	15.5	15.5

Level indicators: -20 dB, -3 dB

The BALANCE potentiometer permits compensation for differences in microphone sensitivity up to 20 dB.

The polarity inversion switch permits rapid change of input channel assignments in M/S recording, as when changing between an upright stereo microphone and one that is hanging downwards.

Outputs

The outputs are impedance-balanced and transformerless, and are switchable between the amplified microphone signals and the decoded M/S stereo signals.

Output impedance: 100 Ohms

Maximum output level for <0.5% THD:
18 dBV (8 V_{rms})

Recommended load impedance: 2 kOhms or greater

Headphone output

Switchable; either the amplified microphone signals (=left/right for A/B recordings, or mid/side for M/S) or the decoded M/S stereo signals can be monitored.

Headphone impedance: 32 – 2,000 Ohms

Headphone socket: 1/4" stereo phone jack

Filters

An infrasonic filter (20 Hz, 18 dB/oct.) is permanently active.

In addition, a low-cut filter (150 Hz, 6 dB/oct.) can be switched on.

The upper frequency limit is 80 kHz.

Powering

An internal filter/regulator circuit which generates and stabilizes the supply voltages permits a wide range of input voltages (5.5 V to 15.5 V).

Operation with internal batteries (possibly rechargeable)

Number and type of cells: 6 × AA (also called LR6)

Recommended primary cell type: Alkaline

Recommended rechargeable cell type: NiMH

A user-replaceable fuse protects against reversing the polarity of the batteries.

Battery life with alkaline cells: ca. 8.5 hours

Battery life with rechargeable batteries:

ca. 3 hours (700 mAh NiCd)

ca. 5 hours (1100 mAh NiMH)

ca. 5.5 hours (1300 mAh NiMH)

ca. 7 hours (1600 mAh NiMH)

ca. 12 hours (3400 mAh gelled lead-acid battery (external))

A voltage indicator displays the battery voltage within the unit.

A warning LED will begin to blink if the voltage falls

beneath a critical value (time remaining at that point with 1300 mAh rechargeable batteries: at least 10 minutes).

The unit will shut itself off automatically to help prevent damage from draining the batteries completely. The unit resumes operation only after the on/off switch is used.

External powering

An appropriate AC power adapter is available (model VMS 5 DC-W). Other adapters offering a regulated or unregulated output voltage of 6 Volts DC (at 500 mA) to 15 Volts DC (at 250 mA) can also be used. Under no circumstances should an open-circuit voltage of 16 V be exceeded; otherwise a fuse inside the VMS 5 U will blow.

Coaxial socket, 5.5/2.1 mm diameter

Reverse polarity will not damage the unit, though it will not operate.

If external powering is present, any internal batteries are automatically disconnected (indicated by yellow LED "EXT."). This protects the batteries from being discharged unintentionally.

The battery voltage indicator displays the level of any external powering.

External powering with outboard rechargeable battery:

nominal 6 – 12 V; we recommend gelled lead-acid batteries (6 V, 3400 mAh type = 12 hours of operation).

Parallel operation of a VMS 5 U along with one or more other pieces of equipment from a single power supply is generally possible, because of the internal voltage regulation.

Robust, black aluminum case.

Overall measurements: (W × H × D):

162 mm × 60 mm × 172 mm

(approximately 6-2/3" × 2-1/3" × 6-3/4")

Weight (with batteries): 1.1 kg

(approximately 2 lb. 7 oz.)

*IEC 61672-1, **IEC 60268-1



Accessories arranged by Category



	page
<i>Electronic Accessories</i>	110
<i>Cables/Adapter Cables</i>	112
<i>Mechanical Accessories</i>	114
<i>Windscreens and Popscreens</i>	119



COLETTE
modular
CCM
compact



Technical Specifications:

Filter: in-line low-cut, Butterworth, 18 dB/octave
Cut-off frequency (-3 dB): LC 60 U: 60 Hz, LC 120 U:
120 Hz

A maximum of two filters may be used in series,
which would then result in a 36 dB/octave slope.

Output impedance: 40 Ohms at 1 kHz with
SCHOEPS CCM compact microphones or CMC
microphones of the Colette modular system

Gain: 0 dB

Maximum output voltage: ca. 1 V when 4 mA cur-
rent is being drawn

Diameter: 20 mm

Length: 94 mm

Surface finish: nickel

LC 120 U

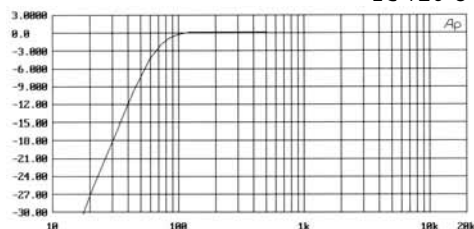

Active Low-Cut Filters LC 60 U (60 Hz), LC 120 U (120 Hz)

- active low-cut filters for phantom-powered micro-
phones, in particular CCM COMPACT CONDENSER
MICROPHONES and CMC microphones of the Colette
modular system
- for standard phantom power, 12 V or 48 V

These electronic filters can be inserted anywhere in the microphone cable path. With a rolloff of 18 dB/octave, the LC 60 U suppresses low-frequency acoustic interference (e.g. wind noise, or solid-borne infrasonic noise such as handling noise during boom operation) without detracting from the sound quality of voice recordings. Under extreme conditions the LC 120 U can be used, though it may have an audible effect on the sound of a voice. Both filters can help prevent overloading the input circuit to which a microphone is connected – a problem which occurs more often than many people realize.

The specifications of the SCHOEPS microphones (sensitivity, noise, source impedance) remain nearly unchanged with the LC.

These low-cut filters are suitable not only for SCHOEPS microphones but also for phantom-powered microphones of other manufacturers, provided that they have a current consumption of at least 2 mA. Otherwise the maximum sound pressure level would be reduced.

Please note:

The use of two LC in series is possible, particularly with SCHOEPS microphones, but is not recommended. The cutoff frequency would be raised, and the maximum output level with 12-Volt operation would be lowered. In no case should three LC be cascaded, especially if the microphones have less than 4 mA current consumption.

COLETTE
modular
CCM
compact



Active Low-Pass Filter LP 40 U

- for adapting the signal from a pressure (omnidirectional) microphone to fill in the bass region of directional microphones (especially with the OCT system)
- for phantom-powered microphones

The low-frequency response of any directional microphone is inherently inferior to that of omnidirectional (pressure) microphones. When using directional microphones, one can extend the low-frequency response by adding in signals from omnidirectional microphones that have been low-pass filtered with a device such as the LP 40.

The LP 40 filter is designed to extend the frequency response of the SCHOEPS supercardioid (MK 41(V) or CCM 41(V)) with the lowest possible ripple. This makes it ideal for use with the OCT front surround system (pg. 132); it can also be used to extend the response of directional microphones with other patterns.



Technical Specifications:

Filter: in-line low-pass, critical damping, 12 dB/octave
 Cut-off frequency (-3 dB): 40 Hz
 Output impedance: 40 Ohms @ 1 kHz with
 SCHOEPS CCM compact microphones and CMC
 standard Colette microphone amplifiers
 Gain: 0 dB
 Maximum output voltage (depends on current
 drawn by microphone): ca. 1 V for 4 mA
 Connectors: XLR-3
 Dimensions: length: 94 mm, diameter: 20 mm
 Surface finish: nickel

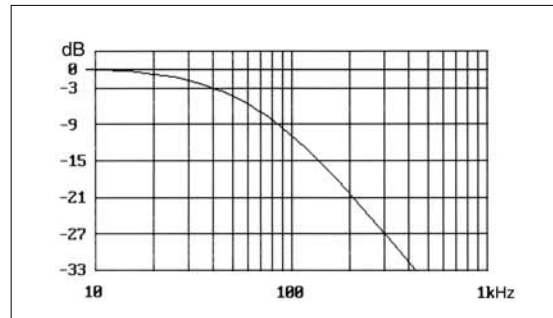

Inline Attenuators
MDZ 10, MDZ 20

- for phantom- or parallel-powered microphones
- ca. 10 dB/20 dB constant attenuation
- avoids overloading sensitive inputs
- to be inserted between the microphone cable and the phantom-power supply
- does not reduce the microphone's signal-to-noise ratio

Connectors: XLR-3F/XLR-3M
 Dimensions: length: 75 mm; max. diameter: 19 mm
 Color: black

Please note: With parallel-powered microphones, the MDZ must be inserted between the powering unit and the output cable.



COLETTE
 modular
 CCM
 compact

Phantom Power Tester
PHS 48

- quick test of 48 V phantom powering (current)
- indication by a green LED

The PHS 48 can be plugged into a microphone input or cable that carries 48-Volt phantom power, to verify that sufficient current is available to power a SCHOEPS microphone. According to the standards, a 48 V phantom powered microphone may draw a current of up to 10 mA per channel. SCHOEPS CMC 5, CMC 6 and CCM microphones actually need only 4 mA (ca. 5 mA if Active Accessories are used), so the PHS 48 tests for approximately this amount of available current at the required voltage level.

Connector: XLR-3M
 Dimensions: length: 53 mm, diameter: 19 mm
 Surface finish: nickel







SCHOEPS Microphone Cables are ...

- particularly thin (4/4.4 mm), extremely robust (Kevlar fiber)
- hardly visible when suspended
- flexible in the cold
- non-twisting when used for hanging a microphone
- also available in bulk (no connectors) with two, three or four conductors

The above remarks apply to all our cables on these two pages.

Technical specifications: see page 133

New!

EMC = electromagnetic compatibility (i.e. greatly improved immunity from interference)



ring of capacitors

Inside view of the special XLR plug; the socket connector has similar construction.

HQ Microphone Cables

K 5 U: 2 × 2 conductors, star-quad, screened, 5 m, XLR-3, black, pins gold-plated
 K 10 U, K 20 U: as above, but 10/20 meters long
 Other lengths are available on request.
 For quick identification, the plug and socket connectors feature contrasting nickel and black finish.
 Diameter: 4 mm

Ground loops and induced interference: SCHOEPS single-channel microphone cables feature special interference-resistant connectors from Neutrik. Instead of the usual DC connection between pin 1 and the connector shell, they use an array of miniature capacitors. This arrangement offers distinctly improved protection from RF interference while simultaneously avoiding ground loops, and settles any controversy over connecting pin 1 to the cable shield once and for all.



Stereo cable (4.4 mm dia.):

- KS 5 U: 2 × 2 conductors, screened, 5 m, XLR-5, black, pins gold-plated
 KS 10 U, KS 20 U: as above, but 10/20 meters long
 Other lengths are available on request.



Cable for Double M/S surround:

- KDMS 10 U: 3 × 2 conductors, screened, 10 m, XLR-7, black, pins gold-plated
 KDMS 20 U: as above, but 20 meters long



AK SU/2U

Stereo XLR-5F jack to two XLR-3M plugs.
 Color coding: channel I: yellow, channel II: red
 Length: 0.5 m

AK 2U/SU

Two mono XLR-3F jacks to XLR-5M plug.
 Color coding: channel I: yellow, channel II: red
 Length: 0.5 m



K 5 LU

This is the adapter cable from the Lemo output connector of the CCM_L COMPACT CONDENSER MICROPHONES to XLR-3M. It is supplied with the CCM_L.

Diameter: 3 mm
Length: 5 m; other lengths are available on request



CCM
compact

Stereo Cable KLY

for CCM_L compact microphones

The forward ends of the KLY are 250 mm long (except the WSR MS). The output cable can be any reasonable length desired. The 100 mm version KLY 250/0 I results in a particularly compact unit.

The following standard cable lengths are available:
KLY 250/0 SU: 10 cm cable only; extension cable:
e.g. KS 5 U, 5 m long
KLY 250/5 SU: 5 m cable length for direct connection without an extension cable

This cable is also available with miniature Binder connectors in case the XLR should be too large or heavy for certain applications; it is then known as the KLY 250/0 I or KLY 250/5 I. (See below for extension cables and adapter cables for XLR output.)

Other lengths are available on request.

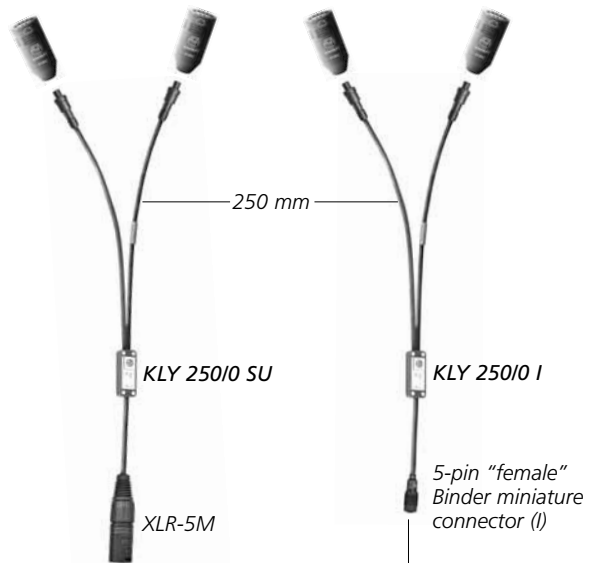

CCM
compact

KS 5 IU

Stereo adapter cable from Binder miniature connector to XLR-5M plug of the miniature stereo recording system with CCM_L COMPACT MICROPHONES and miniature stereo microphone CMXY 4VI.

Length: 5 m; other lengths are available on request



CCM
compact

KS 5 I

Stereo extension cable with Binder miniature connectors; for miniature stereo recording system with Active Cable

Length: 5 m; other lengths are available on request



COLETTE
modular



COLETTE modular



KA 40,
(here shown
on a CCM _L)

Sphere Attachment KA 40

This sphere accessory (40 mm diameter) is for use with omnidirectional microphones as shown in the photo at left.

It creates the illusion of closer placement so that greater miking distances can be used while maintaining good "focus" in the sound. This in turn improves the blend and balance when recording orchestras or choruses, for example. The effect is due partly to an increase in directivity, but mainly to the elevated mid-range response (see frequency response curves, pg. 135). The low-frequency response remains undiminished.

Surface finish: matte gray

This sphere attachment is ideally suited for the "Decca Tree":

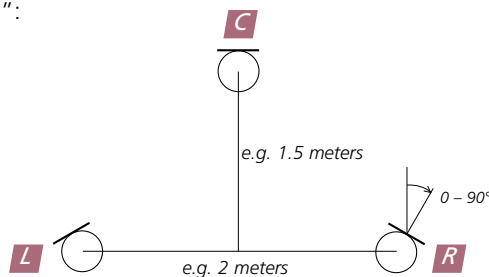

3 x CCM 2S (omni) with KA 40; the spacings are dependent on the room and a matter of taste. The microphones are available as a matched "Decca Tree" set, including sphere attachments, in a special wood case.

COLETTE modular



X/Y



ORTF



M/S



Blumlein

Universal Stereo Bracket UMS 20

– for microphones of the Colette modular system (e.g. CMC, 20 mm diameter)

With this device and two corresponding microphones, nearly any of the familiar stereo techniques (X/Y, M/S, ORTF, Blumlein (crossed figure-8s), small A/B) can easily be set up.

Its microphone clamps slide and rotate on a bar marked with angles and spacings, with detents in the four familiar positions. It is also lockable at any desired point in-between.

The mounting adapter has a diameter of 20 mm and fits into the SG 20 stand clamp or the A 20 S elastic suspension for horizontal and vertical mounting angles. SG 20 and A 20 S are not included.

Mounting adapter: 5/8" - 27 NS, with adapter to 3/8" and 1/2"

Surface finish:
matte black, plastic
holders: gray



Miniature Stereo Mounting Bar M 100 C

ORTF with two axially addressed capsules or microphones: MK 4 or MK 5 capsules + KC Active Cables or CCM 4 or CCM 5 compact microphones
X/Y as above or with laterally addressed capsules or microphones such as the MK 4V or CCM 4V U/L

The M 100 C is the solution for SCHOEPS compact stereo recording rigs. This "T-Bar" style mount is unobtrusive with a bar length of only six inches and a black anodized finish. The device can be tilted forward or backward as needed.

When shockmounting is critical, the addition of the A 20 S and ST 20-3/8 mounting cylinder is all that is needed. For installations requiring a small stereo SCHOEPS setup that must be hung, the M 100 C with an H 20g upgrade is perfect.

Threads: 5/8"-27 NS with adapter for 3/8" and 1/2"
Length: 100 mm; other lengths available on special order.



ORTF



XY



A/B Stereo Mounting Bar/OCT Mounting Bar MAB 1000

- for two (or more) microphones
- for A/B (spaced omni recording) and ORTF
- with extension bar for a third, central microphone placed slightly forward (e.g. for OCT; see pages 100 and 132)
- can be expanded for five-channel OCT surround

Any distance from 4 to 100 cm can be set between the microphones. Each side of the bar is engraved with markings every 2.5 cm so that distances of 5 cm, 10 cm, 15 cm, etc. can easily be set between the two outer microphones.

Thread: 3/8"; length: 1000 mm; weight: 500 g

Accessories (included): KMAB 1000, robust, foam-lined carrying case for the two MAB 1000 stereo bars and a CB-MAB mounting bracket

Accessories (optional):

- stand clamps or shock mounts: SG 20 or A 20 for Colette-series microphones (e.g. CMC); SGC or AC for CCM-series microphones.
- CB-MAB mounting bracket for OCT surround; holds two MAB 1000 bars at variable distance (13 – 47 cm)
- MC-MAB microphone carriage for additional microphones
- 40 cm extension bar for OCT 2

A/B setup with
2 x SG 20 stand clamp
2 x CMC 62S Ug (omni)

microphone carriage MC-MAB

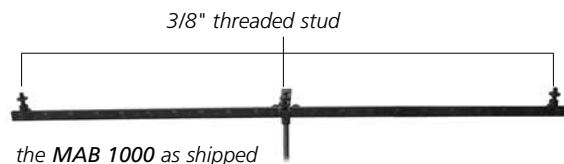

the MAB 1000 as shipped

KMAB 1000
transport case
(included)



OCT surround setup with two MAB 1000 and CB-MAB mounting bracket



COLETTE
modular
CCM
compact

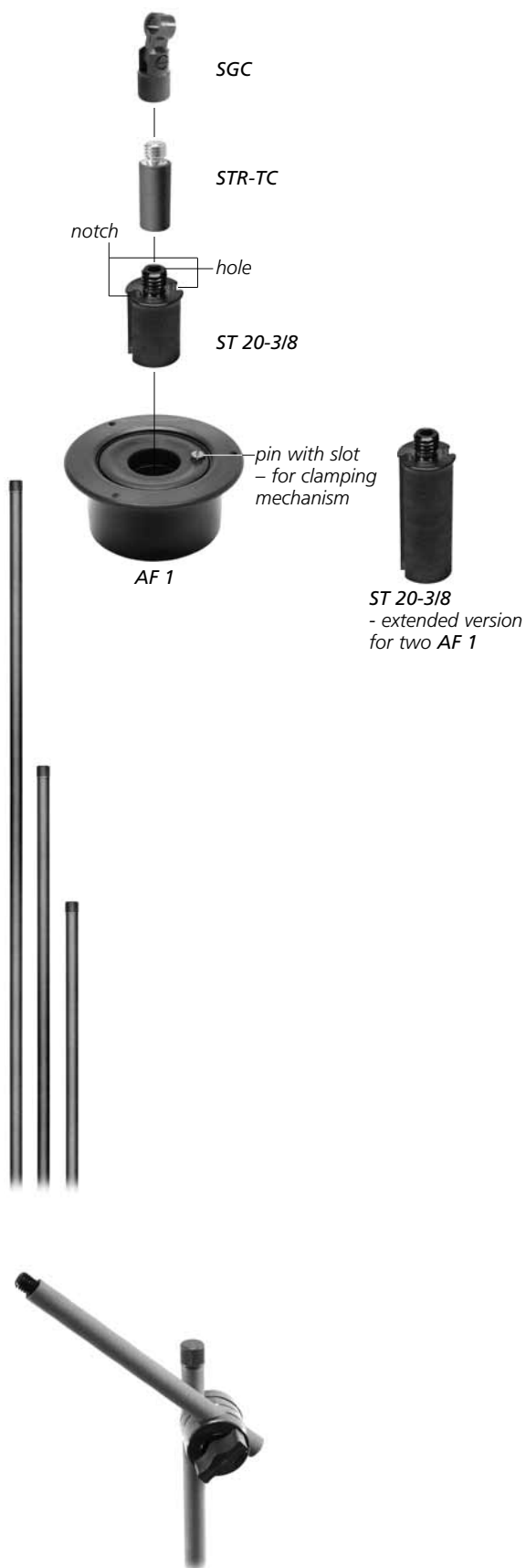

Flanged Mounting Adapter with Internal Shock Mount AF 1, Mounting Cylinders ST 20-3/8 and STR-TC

This convenient elastic suspension device accepts any microphone or accessory (such as a gooseneck) with a 20 mm diameter. A clamping arrangement holds the item in place.

For use with our accessories, a mounting cylinder (ST 20-3/8) with 20 mm outer diameter and a stud with 3/8" threading is available. It has a hole drilled in the center of its top which could be used to pass a miniature cable through. To avoid the need for unsoldering and resoldering the cable connector, however, two notches are also provided on the sides of the adapter. (Exception: the connector used at the amplifier end of Colette Active Extension Tubes RC KC won't fit through the 20 mm opening).

Dimensions: flange: 69 mm diameter
cylinder: 54 mm diameter,
29 mm depth below the flange

Color (cylinder and adapter): black
The ST 20-3/8 mounting cylinder must be ordered separately.

Vertical Support Rods STR 250g, 350g, 600g, 1000g

These support rods have complementary 3/8" threads on each end and can thus be screwed together in any combination to extend one another. They can also be attached to the floor stand BF 250.

A gray plastic cap is provided to allow covering the upper threads of an STR if desired.

Lengths: 250 mm, 350 mm, 600 mm, 1000 mm
Diameter: 12 mm
Wrench size for tightening the rods (via flat spots at the lower end): 10 mm
Surface finish: matte gray (g)

Stand Connector RG 12

The RG 12 connects two STR vertical support rods or any other rods with 12 mm in diameter. The angle may be adjusted over a wide range.

Maximum length of the angled rod when a CMC is fixed at the end and when no counterweight is used: appr. 50 cm

Surface finish: matte gray

**Stand Support Clamp
for a Microphone Amplifier
K 20 STR**

With this clamp a CMC microphone amplifier can be mounted onto an STR vertical support rod or any other rod 12 mm in diameter. This is especially useful for RC KC extension tubes of the Colette modular system whose flexible cable attaches to a CMC amplifier.

Color: gray



**Table Mounting Flange
F 5g**

The F 5g is mounted on a table top with a screw. It allows the attachment of accessories with 3/8" internal threads. It can also be used with a thread adapter to support any stand adapter or shock mount with 5/8"-27 threads.

Dimensions: height (without threaded stud): 6 mm
diameter: 36 mm

Color matte gray (g)



**Universal Clamp
Z 10**

The Z 10 allows microphones or accessory parts to be mounted onto the edge of a table or the like. The Z 10 allows microphones or accessory parts to be mounted onto the edge of a table or the like. It can also grasp tubular shapes; its pressure pad is grooved for this purpose (see detail photo, right). It can be used as a miniature tripod table stand as well.

An SG 20 or other stand clamp for holding a microphone can be attached to the 3/8" thread, while an adjustable joint lets the microphone be angled in any direction.

Maximum thickness of table edge, etc.: 40 mm
Color: black





Heavy Table Stand T 5g

– with 3/8" threaded stud, e.g. for STR support rods

Dimensions: diameter: 129 mm, height: 52 mm

Weight: 1.5 kg

Surface finish: matte gray (g)



Heavy Floor Stand BF 250

The BF 250 is supplied with a quick release twist-lock chuck, type SPV 12-3/8, to create a quick connect and disconnect system for an STR vertical support rod. This can simply be plugged into the chuck and tightened by hand with a half turn of the milled cap nut.

The chuck SPV 12-3/8 is also available separately for the purpose of updating older equipment. It can be screwed on with an open-ended wrench.

Diameter: 250 mm, height (without the SPV): 38 mm

Surface finish: black textured varnish



SM 270 under BF 250 floor stand

Vibration Isolation Foam Mat SM 270

– additional isolation against vibration for BF 250

Occasionally a microphone must be placed on a very "noisy" wooden floor, which can lead to pickup of footstep noise, and – especially when an RC Active Extension Tube is used – even some mechanical "ringing." Sometimes the existing acoustic isolation of the heavy floor stand BF 250 does not suffice to keep the microphone free of these disturbances. For that reason we offer the SM 270, an isolation mat which is simply placed beneath the BF 250. It is made of a specially-treated foam material that is very well able to hold its shape.

Dimensions: diameter: 270 mm, thickness: 12 mm

Color: blue-green



Which popscreen or windscreen is right for my microphone?

Before taking up this question, one should first consider the choice of microphone type.

With a SCHOEPS supercardioid, the level of noise in mild to moderate wind will be some 2 to 5 dB higher than with a SCHOEPS cardioid under similar conditions. But the difference in wind noise pickup between pressure transducers and pressure gradient transducers generally (i.e. omnidirectional microphones vs. directional microphones as a class) can be as much as 20 dB. Thus when wind noise is a factor, one should always consider whether an omnidirectional microphone could perhaps be used. Furthermore, it should be considered that a windscreen will affect the low-frequency polar pattern of a directional microphone (see below).

One widely useful choice of capsule would be the switchable-pattern MK 5 (omnidirectional/cardioid).

In general, when comparing two windscreens which are equally effective, the smaller one will always have a greater adverse effect on sound quality. If two windscreens are the same size, the one which is more effective will have the greater adverse influence on sound quality – altering the microphone's frequency response and (with directional microphones) the polar pattern as well. Thus it is advisable to select a windscreen that is only as effective as is really necessary, and perhaps to use a larger windscreen rather than a smaller one that has the required degree of effectiveness.

Establishing some terms:

Popscreens are only for indoor use, to reduce the air currents produced when singers or speakers pronounce consonants such as "p" or "t".

Close speech guards are for use in moderate air currents and with microphones on moving boom arms, and/or as heavier-duty popscreens.

Windscreens suppress even more strongly the disturbances due to air motion, making it possible to record outdoors.

Screens for pressure transducers (MK 2, MK 2H, MK 2S, MK 3, omnidirectional setting of MK 5 and MK 6)

The most suitable windscreens generally are those made of homogeneous, fine open-pore foam. They are also the simplest and least expensive choice.

Effect on sound quality: Limited to a high-frequency rolloff which can be corrected with equalization or by choosing a brighter sounding capsule.

Effect on polar response: None.

Practical suggestions: Adequate protection should be available from a light foam windscreen (**B 5**) for mild wind or a thicker windscreen (**W 5**) for stronger wind. Further protection would require a basket-type windscreen with fur-like covering. Since wind noise can cause extremely high output levels at low frequencies, the input of the equipment to which the microphone

is connected can become overloaded, which may create the false impression that the microphone itself is being overloaded. Thus one might also consider using a low-cut filter (CUT 1 or LC 60).

The following combinations have worked particularly well in practice: Capsule MK 2S or MK 3, foam windscreen W 5 or W 5 D, and Active Low-cut Filter CUT 1 or in-line filters LC 60 or LC 120.

Hollow foam windscreens and basket-type windscreens can also be used.

Effect on sound quality: Again the effect is restricted to the high frequencies, but in addition to the rolloff, a slight unevenness of response is introduced. This will depend on the capsule type, the diameter of the basket, the position of the microphone within the basket and the possible use of a fur-like "overcoat."

The degree of wind noise suppression will depend on the thickness of the foam and the "overcoat."

Effect on polar response: Slight, and limited to the high frequencies.

Screens for pressure gradient transducers such as the cardioid MK 4 or supercardioid MK 41

For this case we recommend windscreens that have an enclosed volume of air. There are two types: hollow foam windscreens and basket-type windscreens. The latter type is often augmented by an optional fur-like covering which increases its effectiveness.

Effect on sound quality: There is some reduction of low-frequency response, since the pressure difference between the front and rear sound inlets of the capsule is made smaller by the basket structure. At high frequencies, in addition to a slight rolloff, a certain unevenness of response is introduced. This will depend on the capsule type, the diameter of the basket, the position of the microphone within the basket and the possible use of a fur-like "overcoat." Windscreens with this type of covering (e.g. W 20 R 1) are especially effective because no wind turbulence will arise at their surface while any existing turbulence will be reduced.

Effect on polar response: At low frequencies the decreasing pressure gradient component will cause the directional pattern to become more nearly omnidirectional. In extreme cases a supercardioid may take on a cardioid pattern at low frequencies, while a cardioid capsule's pattern may resemble that of a wide cardioid or an omnidirectional capsule.

Practical suggestions: The hollow windscreens **B 5 D** and **W 5 D** are suitable for mild to moderate wind conditions. In strong wind, the largest practical basket-type windscreen should be used (e.g. WSR MS) with a fur-like outer covering.

Perhaps an optimal balance of size and effectiveness can be achieved by using the W 20 R 1 windscreen and either the Active Low-cut Filter CUT 1 or the in-line filters LC 60 or LC 120.



Attenuation of the A-weighted wind-noise level compared to the unprotected transducer at a



... with pressure gradient transducer (CMC 641/CCM 41*)

Type of windscreen	Attenuation	Wind noise
-	0 dB-A	130 dB-A
B 5	20 dB-A	110 dB-A
B 20	26 dB-A	104 dB-A
W 5	28 dB-A	102 dB-A
B 5 D	32 dB-A	98 dB-A
B 20 S	34 dB-A	96 dB-A
W 20	38 dB-A	92 dB-A
BBG	44 dB-A	86 dB-A
WSR 100 LU	44 dB-A	86 dB-A
W 5 D	46 dB-A	84 dB-A
W 20 R1	51 dB-A	79 dB-A
WSR MS	52 dB-A	78 dB-A
BBG with Windjammer	57 dB-A	73 dB-A
WSR 100 LU with Windjammer	57 dB-A	73 dB-A
WSR MS with Windjammer	62 dB-A	68 dB-A

For a given strength of wind, the noise level produced in a pressure transducer will always be distinctly less than that produced in a pressure gradient transducer. Thus when wind might be a problem, we recommend using an omnidirectional microphone where possible, rather than (for example) a cardioid. In addition, a low-cut filter (CUT 1 or LC 60) should be used to suppress the wind noise even further. An omnidirectional microphone with this type of low-frequency cut can still have better low-frequency response than a cardioid; any cardioid has an inherent low-frequency response rolloff, and that rolloff is only accentuated by the use of a windscreen.

* The corresponding values for the cardioid (CMC 64 or CCM 4) are consistently 2 to 5 dB better; for the wide cardioid (CMC 621 or CCM 21) the difference is 5 to 7 dB.

Compatibility chart

	CMC, CMD + capsule	CCM_L	CCM_U	capsule on KC	RC	RCY	MSTC	CMXY	notes
B 1+	✓	✓	✓	✓	✓		-		+ Primary function: protection against dust deposits
B 5	✓	✓	✓	✓	✓		✓		
W 5	✓	✓	✓	✓	✓		✓		++ Cannot be used with MK 6 or 8 or corresponding CCM compact microphones. With MK/CCM 4V, 4VXS, 41V: see page 125
B 20+++	✓	✓	✓	✓	✓		✓		
B 20 S+++	✓	✓	✓	✓	✓		✓		
W 20	✓	✓	✓	✓	✓		✓		
W 20 R1	✓	✓	-	-	✓		✓		+++ Cannot be used with MK 4V, 4VXS, 41V, 6 or 8 or corresponding CCM compact microphones.
BBG	✓	-	-	-			✓		
WSR (MS) 100 LU		✓							
WSR MS		✓	✓	✓					✓ recommended - not recommended
WSR CMXY								✓	
B 1 D	✓	✓	✓	✓	✓		✓		
B 5 D++	✓	✓	✓	✓	✓		✓		
W 5 D+++	✓	✓	-	-	✓		✓		
WMS	✓	✓	✓	✓		✓		✓	
WB	✓	✓	✓	✓					

wind speed of 18 km/h (ca. 11 mph) ...

These results are A-weighted according to IEC 61672-1.



... with pressure transducer (CMC 62/CCM 2)

Type of windscreen	Attenuation	Wind noise
-	0 dB-A	110 dB-A
B 20	25 dB-A	85 dB-A
B 20 S	27 dB-A	83 dB-A
B 5	28 dB-A	82 dB-A
W 20	29 dB-A	81 dB-A
B 5 D	35 dB-A	75 dB-A
WSR MS	37 dB-A	73 dB-A
W 5	38 dB-A	72 dB-A
W 5 D	40 dB-A	70 dB-A
BBG	41 dB-A	69 dB-A
WSR 100 LU	41 dB-A	69 dB-A
W 20 R1	43 dB-A	67 dB-A
WSR MS with Windjammer	47 dB-A	63 dB-A
BBG with Windjammer	53 dB-A	57 dB-A
WSR 100 LU with Windjammer	53 dB-A	57 dB-A



CMC 641/CCM 41 *

Attenuation

WB	-
WMS	32 dB-A



CMC 68/CCM 8

Attenuation

	21 dB-A
	27/36 dB-A (side/end face)

WKFM: 12/22 dB-A attenuation of 12/22 dB-A on the capsule's axis/stereo main axis



Wind noise attenuation with **CMIT 5 U shotgun microphone**, all filters in "off" position:

W 140	18 dB-A
Softie	30 dB-A
Windscreen type:	(without/with Windjammer)
mono and MS-Stereo-Set, Ø 100 mm	30 dB-A/41 dB-A
Surround-Set, Ø 150 mm	47 dB-A/51 dB-A

Popscreens

for: 

PR 120 S



for microphones with axial pickup; page 122

PR 120 SV



for microphones with lateral pickup; page 122

B 1 D



for microphones with axial pickup; page 122

Foam-Type Windscreens

for: 

B 1



light close-speech guard; protection against rosin deposit (see violin adapter); page 123

B 5



close-speech guard for mild wind; page 123

W 5



windscreen for strong wind; page 123

Basket-Type Windscreens

for: 

B 20



close-speech guard; page 123

B 20 S



close-speech guard; page 123

W 20



windscreen for medium wind; page 124

W 20 R1



windscreen for strong wind; page 124

BBG



for strong wind; page 124

WSR 100 LU



for a single CCM _L; page 68

WSR MS 100 LU



for M/S stereo with CCM _L; page 89

WSR MS



for strong wind; for mono and M/S stereo; page 88

Hollow Foam-Type Windscreens

for: 

B 5 D



close-speech guard; for mild wind; page 125

W 5 D



windscreen for stronger wind; page 126

Special Foam-Type Windscreens

WMS



for M/S stereo; for mild wind; page 126

WKFM



for sphere microphone KFM 6; page 77

WB



for Blumlein stereo; for mild wind; page 126



PR 120 S

SG 20

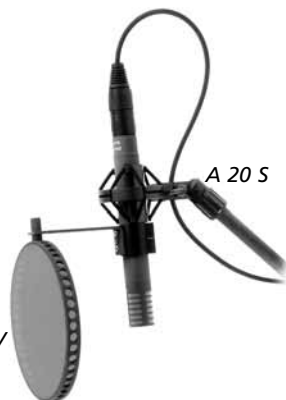

A 20 S

PR 120 SV

New!

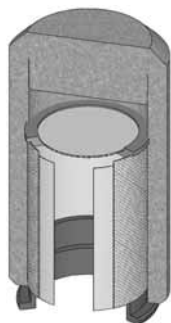

Popscreens

PR 120 S and PR 120 SV

These popscreens are a patented product of Tonstudio Pauly. They guard against the popping noise generated by plosives such as "P" and "T" during close-miking. The popping noise is caused by an airstream which accompanies these consonants. The PR 120 S damps this stream with two layers of a lightweight fabric attached to a rugged aluminum frame.

Mounting is accomplished simply by clipping this unit onto the microphone body.

Despite its high effectiveness, the PR 120 S has no audible effect on the sonic impression.

Dimensions: diameter: 120 mm, height: 11 mm
The surface is gray/matte gray.

Popscreen B 1 D

The B 1 D is a highly effective popscreen with a deceptively simple outward appearance. As with the B 5 D and the basket-type windscreens, the sound inlets of the microphone are enclosed by a volume of air.

The B 1 D is most effective in the axial direction; thus we offer it as a popscreen rather than a windscreen. It is designed exclusively for axially-addressed capsules such as the MK 4, MK 41 and their CCM counterparts, rather than for the MK 6, MK 8, or any capsule or CCM with a "V" in its name.

It is as effective as the distinctly larger B 5 D, but as one might expect, it also has slightly more of an effect on sound quality.

Dimensions: 32 mm diameter × 59 mm
Color: gray

Foam-Type Windscreens

Capsule Guard B 1

Thin foam covering for a CCM or Colette capsule, especially suitable for protecting a capsule from rosin dust when attached to a string instrument (e.g. with the VA 1 violin mount).

Dimensions: 28 mm diameter × 41mm
Color: Anthracite





Solid Foam Popscreen B 5

Acoustic foam close-speech popscreen; provides sufficient protection at normal speaking distances for cardioids and other directional capsules, especially when speech capsules are used. With omnidirectional capsules it may even be used outdoors in light wind. Minimal effect on sound quality.

Dimensions: 70 mm × diameter 45 mm (max.)
Available colors: gray, black



Solid Foam Ball W 5

Acoustic foam windscreen, especially for use with omnidirectional microphones in wind. Usable as a low-cost alternative to popscreens when greater effectiveness is needed. With pressure-gradient transducers it can be used in light wind only, but it offers the advantage that its influence on sound and polar pattern is minimal, especially at low frequencies.

Dimensions: sphere with 90 mm diameter
Color: gray



Basket-Type Windscreens

Basket Popscreen B 20

Small close-speech guard with plastic basket and washable nylon fabric.

Cannot be used with MK 4V, MK 41V, MK 4VXS, MK 6, MK 8 microphone capsules or corresponding CCM compact microphones.

Diameter: 50 mm; color: gray/light gray



Basket Popscreen B 20 S

Similar to the B 20 but with a double layer of nylon fabric. More effective than the B 20 but causes greater sound coloration. Cannot be used with MK 4V, MK 41V, MK 4VXS, MK 6 or MK 8 microphone capsules or corresponding compact microphones.

Diameter: 50 mm; color: light gray





Basket W 20

Basket windscreen with nylon fabric, made of two separable halves. It is rain-resistant and less unusual-looking than a fur-like windscreen. The capsule front must be positioned approximately at its center.

Diameter: 80 mm; color: light gray



Basket Frame with synthetic Fur Cover W 20 R1

Comprises a basket (W 20 R) and a fur-like overcoat (R1). It is ca. 13 dB more effective than the W 20, with no greater impairment of the sound quality. It is used like the W 20 with the capsule front positioned in the center.

Diameter: ca. 90 mm; color: tinged with gray



with WJ BBG
Windjammer
(synthetic fur cover)

Basket Windscreen for exterior Use BBG

This sturdy, highly effective “basket-type” windscreen has two separable halves. It is intended for use with microphones of the Colette modular system, particularly the ORTF microphone MSTC 64. The front sound inlet of each capsule should be positioned in the center of its respective basket.

Due to its high effectiveness, some audible effect on sound quality may occur.

For maximum effectiveness this windscreen can be used with the “Windjammer” overcoat, which will help suppress wind noise by a further 13 dB-A.

Diameter (without Windjammer): ca. 10 cm

CCM
compact



Basket Windshield with elastic Suspension for CCM_L

Mono version: WSR 100 LU (pg. 68),

M/S-stereo version: WSR MS 100 LU (pg. 89);

Basket Windscreens

WSR MS, WSR MS CI, WSR MS LI, WSR MS LU
(see miniature stereo on pages 82 and 90)

This is the most effective windscreen that we offer. It can be used with one or a pair of microphone capsules on KC Active Cables, or CCM _L or CCM_U compact microphones.

It contains an AMS double elastic suspension for M/S stereo recording.

The following versions are available:

WSR MS: without cable

WSR MS CI: for microphone capsules, with KCY 115/0,25 I_g Y-cable; special miniature output plug for VMS 5 U microphone preamplifier or VST 62 I_{Ug} stereo microphone amplifier

WSR MS LI: for CCM _L microphones, with KLY 115/0,25 I Y-cable
input connector: Lemo; output connector: female miniature Binder
extension: KS 5 I (5 m long)

WSR MS LU: with KLY 115/0,25 SU Y-cable;
input connector: Lemo; output connector: XLR-5M

The microphone side of the above Y-cables is 115 mm long; the output side is 250 mm.

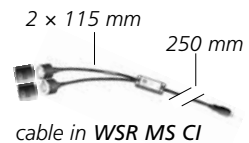

WJ MSIXY
Windjammer;
fur-like "overcoat"
which enhances the
suppression of wind
noise



Hollow Foam-Type Windscreens

Hollow Foam Popscreen B 5 D

Application: for use especially on pressure-gradient transducers in light wind and as a close-speech guard.

The B 5 D offers good effectiveness, yet has only a slight influence on the sound. The microphone must be inserted up to the stop.

Although it has not been designed for that purpose, it is possible to use it on the MK 4V, MK 41V or MK 4VXS microphone capsules and the corresponding CCM COMPACT CONDENSER MICROPHONES. The microphone's slight inherent high-frequency emphasis is then compensated for.

The B 5 D cannot be used with MK 6 or MK 8 capsules, or the corresponding CCM compact microphones.

Dimensions: 70 mm x diameter 50 mm (max.)
Color: gray, with additional gray, porous velvet-like surface treatment





Hollow Foam Ball W 5 D

- for use on pressure-gradient and pressure transducers in wind.

The foam encloses an air chamber around the capsule, similar to a basket windscreen. It is highly effective, yet it has only a slight influence on the sound.

When using CCM _L compact microphone, please be careful to place the W 5 D all the way onto it.

The W 5 D cannot be used with the KC Active Cable, CCM _U compact microphones and microphone capsules for lateral pickup (MK 6, MK 4V, MK 41V, MK 4VXS, or MK 8), or the corresponding CCM compact microphones.

Dimensions: sphere with diameter 90 mm
Color: black, with additional black, porous velvet-like surface treatment

Special Foam-Type Windscreens



Windscreen WMS

- close-speech guard and windscreen for M/S stereo

This windscreen has a gray porous velvet-like surface treatment. It is designed so that conventional M/S setups (AMS 22, UMS 20) as well as most miniature microphone arrangements for M/S (RCY, SGMSC, HSGMSC) and also the X/Y microphone CMXY can be protected from mild wind.

For its small dimensions, the WMS offers remarkable effectiveness with relatively little adverse effect on the sound quality.

Dimensions: sphere with 68 mm diameter
Color: gray, with additional gray, velvet-like surface treatment



Windscreen for Blumlein Setups WB

The WB is suitable for CMC or CMD 2U microphones with UMS 20, as well as KC Active Cables with MK capsules or CCM compact microphones, in a Blumlein arrangement (two crossed figure-8 microphones) and M/S arrangements using an MK 8 (figure-8) and an MK 4V (cardioid) or MK 41V (supercardioid) or the corresponding CCM microphones.

Dimensions: diameter 50 mm × 95 mm
Color: gray



Technical Appendix

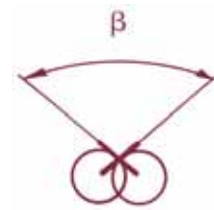

	page
<u>Principal Microphone Characteristics</u>	128
<u>Stereo Techniques</u>	131
<u>Surround Techniques</u>	132
<u>XLR, Cable Specifications</u>	133
<u>Overview of Capsule Specifications</u>	134
<u>Frequency Response Curves for "xt" Amplifiers, Miscellaneous</u>	135



Pressure Transducers

... are characterized by an omnidirectional polar pattern, i.e. they pick up sound from all directions to an (ideally) equal degree. Microphones of this type do not have “proximity effect” (low-frequency emphasis with close placement to a sound source). But condenser microphones operating on this principle can have flat frequency response down to the lowest audible frequencies, permitting full, impressive low frequency sound reproduction. Unlike a loudspeaker, a microphone's membrane size has no effect on its low-frequency capabilities since it operates purely as a sensor, like an eardrum; it doesn't have to move large volumes of air at low frequencies as a loudspeaker must do.

For reasons of physics (capsule dimensions), the omnidirectional pattern can be maintained in its ideal form only up through the midrange frequencies. At higher frequencies, sounds arriving on axis are progressively emphasized by the interaction of the capsule housing with the shorter wavelengths. The larger the diameter of the housing, the greater the difference in high-frequency response between on-axis and off-axis sound. This effect can be seen clearly in the capsules' polar diagrams. It is the reason for their differing frequency response in the direct versus the diffuse sound field.

When the high-frequency emphasis is corrected so that the response measures flat on axis, the result is a pressure transducer type such as the MK 2 or CCM 2. These microphones are ideally suited to picking up acoustic sources in the near field. But if a microphone of this type is placed in the reverberant sound field, where reflections from walls, ceiling, floor, etc. predominate, there will be a loss of overall brilliance. These reflections, with their high-frequency content attenuated by surface absorption, reach the microphone at oblique angles of incidence and suffer additional losses as compared with sounds picked up directly. Here (in the diffuse sound field, beyond the reverberation radius*) a microphone with some high-frequency emphasis (MK 2H, MK 2S, MK 3 or the corresponding CCM compact microphones) is required so that at high frequencies there will be balanced sound rather than a rolloff. This, of course, adds brilliance to sounds picked up at close range and on axis – an effect which may be desired in some circumstances.

A pressure transducer with ideal response in all situations does not exist. A very small capsule could allow the high-frequency response to be flat regardless of direct- or diffuse-field placement, but such small capsules are quite noisy. The user must therefore consider the nature of the pickup and make an appropriate choice. Please note that the design of the MK 2S or CCM 2S achieves a technically sophisticated compromise between the requirements of working in the direct and the reverberant sound fields (in the region of the reverberation radius).

Particularly for two- and three-microphone stereo pickups, which are usually made near the reverberation radius (where the direct and reverberant sound

fields are of equal level), the MK 2S and CCM 2S have become favorites of many sound engineers. This is also true for the MK 2H and CCM 2H, whose characteristics are somewhat closer to those of the free-field models MK 2 and CCM 2.

Pressure-Gradient Transducers

Note: Usually, any directional microphone is referred to as a “pressure-gradient transducer” even when it has only a limited pressure-gradient component (e.g. a cardioid). This usage is technically not quite correct, since a true pressure gradient transducer always has a bidirectional (figure-8) pattern. Nevertheless, we have adopted this nearly universal practice.

SCHOEPS makes many different types of directional capsules and microphones, each having specific features and a range of typical applications.

What they all have in common, as you can see from their polar response diagrams, is that their sensitivity to any sound depends on the angle of incidence of that sound; they “favor” sound that arrives from particular directions. This allows them to maintain the same balance of direct to diffuse (reverberant) sound when placed at a greater distance from the sound source than an equally sensitive omnidirectional microphone.

The bidirectional MK 8 and CCM 8 are pure pressure-gradient transducers. Our other directional microphones use combinations of the pressure and pressure-gradient principles; their various directional characteristics result from differing proportions of these ingredients.

All our microphones, including the multi-pattern ones, are single-diaphragm – a feature unique to SCHOEPS. This results in polar patterns that are less frequency-dependent than any dual-diaphragm design can offer, a high-frequency response that is distinctly more extended, and low-frequency response (with our single-pattern omnidirectional microphones or in the omnidirectional setting of our multi-pattern microphones) that is essentially perfect.

One advantage of small pressure-gradient transducers such as SCHOEPS microphones is that their directional pattern can be kept constant across a wider frequency range than with a pressure transducer. On the other hand, their low-frequency response in a free sound field is not as extended as that of a pressure transducer. Placement in the near field can compensate for this bass rolloff via proximity effect, but there is also a risk of overcompensation.

Proximity effect may also be used to suppress environmental noise by choosing a microphone type having a large bass rolloff and/or by the use of a corresponding electronic filter. A cardioid microphone at a distance of less than 40 cm, for example, will pick up a speaking voice quite clearly, while environmental noise will be suppressed due to the directivity of the cardioid pattern and its bass rolloff. At the same time,



the lower frequencies in a person's voice will be restored to normal by virtue of proximity effect, resulting in a clear and full sound.

By choosing a microphone of high directivity it is also possible to avoid acoustic feedback. If a loudspeaker is set up within the reverberation radius*, it should, for obvious reasons, be positioned where the microphone has its minimum sensitivity. If the loudspeaker is beyond the reverberation radius, its radiated sound will reach the microphone after being reflected by the walls, floor and ceiling of the room, arriving as reverberant sound from many directions. The microphone will pick this up less strongly than the direct sound from the source on the main axis.

Off-axis attenuation increases with greater microphone directivity. The greater this is, the less danger there will be of acoustic feedback. This is true only in the direct sound field, however; in a diffuse sound field (beyond the reverberation radius), a directional microphone will offer no help for this problem.

When dealing with pressure-gradient transducers, their greater sensitivity to wind and vibration should be kept in mind. Suspensions that damp solid-borne noise (elastic suspensions and/or sound-isolated stands) are highly recommended, as well as popscreens and windscreens wherever appropriate.

Interference Tube ("Shotgun") Microphones

A "shotgun" microphone has a pressure-gradient transducer with an interference tube fitted in front. At upper-midrange and high frequencies the tube suppresses off-axis sound; this effect is more pronounced at higher frequencies, and can generally be made greater with a longer interference tube. At midrange frequencies and below, however, a shotgun microphone cannot have greater directivity than a supercardioid unless its interference tube is so long that it would be impractical for most purposes.

For the sake of high-quality sound, it is desirable for a microphone to have similar frequency response at all angles of sound incidence. However, this may become a secondary consideration when very high directivity is required. It is somewhat like the situation with windscreens: Everyone knows that they affect the sound quality, but sometimes they are necessary in order to get a usable recording at all.

Here are some things which are worth knowing about "shotgun" microphones, including the SCHOEPS CMIT 5:

1. For any given length of the interference tube, a shotgun microphone's design can be optimized for maximum directivity or for best sound quality, but unfortunately not for both at the same time. The SCHOEPS CMIT 5 has been optimized for best sound quality.
2. Room reflections and reverberance contribute enor-

**see next page*

mously to the character of any sound. With a shotgun microphone, the pickup angle at high frequencies will be narrower than at lower frequencies; as a result, diffuse room sound will be picked up with a distinct high-frequency rolloff, which can make the sound rather dull. This tendency will be emphasized further if a windscreen is used. For this reason a supercardioid is often a better choice for indoor recording. Of course if there is a special need to reduce the pickup of room sound at high frequencies (for example, if there is interfering high-frequency noise), a shotgun microphone may still be preferable.

The tendency toward dull sound can be counteracted with a high-frequency boost, which can also benefit speech intelligibility. The SCHOEPS CMIT 5 offers a built-in, switchable high-frequency boost of this kind.

The polar patterns of shotgun microphones often have multiple narrow lobes of sensitivity. These can cause disturbing comb-filter-like effects when the microphone (or a sound source) is in motion, especially in indoor recordings. Special care was taken to smooth out these response lobes in the design of the SCHOEPS CMIT 5.

Since any off-axis sound will be picked up with reduced high-frequency content, a shotgun microphone must always "track" (follow) a moving actor or other sound source precisely – particularly if the microphone is close to the person being followed and/or its interference tube is a longer one. Precise tracking is not always easy, and even if it can be done perfectly, other sound sources in the room (including noise sources and other nearby voices) will still be picked up from off-axis.

3. Since shotgun microphones are frequently used outdoors and/or on booms, they should have a low-cut filter available to suppress wind and handling noise. The SCHOEPS CMIT 5 has a switchable low-cut filter of this type.

In addition, any directional microphone will increase its pickup of low and lower-midrange frequencies when it is positioned near a sound source. To avoid false boominess, a shotgun microphone should also have a filter to compensate for this "proximity effect." These two requirements involve different frequency ranges and different ideal filter slopes, however, so a single low-cut filter is always a compromise at best. The SCHOEPS CMIT 5 has a switchable low-cut filter with two different characteristics available: a relatively sharp cutoff for suppressing room rumble or wind and handling noise, or a more gradual slope that reaches somewhat higher in frequency to compensate for proximity effect.

4. For high frequency sound, shotgun microphones increase the distance at which a good proportion of direct sound may be obtained. But their use still makes clear sense only when they are already close enough for direct sound to predominate in the result. For outdoor recording this will not be an issue when there is little or no reflected sound energy – but indoors, even



a shotgun microphone should generally be kept fairly close to the intended sound source.

5. The usefulness of shotgun microphones for stereophonic recording is limited by the fact that their polar patterns differ at low vs. high frequencies. X/Y stereo recording with two shotgun microphones cannot really be recommended, but M/S stereo recording with a SCHOEPS CMIT 5 with a small figure-8 condenser microphone or capsule (such as the SCHOEPS CCM 8 or MK 8) mounted on it can produce very good results.

When mounting a figure-8 microphone or capsule on a shotgun microphone, one should be sure to place their diaphragms one directly above the other, remembering of course that the diaphragm of a shotgun microphone is at the base of the interference tube, not at its tip:



M/S arrangement with shotgun microphone (shown here: CMIT 5 with CCM 8 and KM5C clip.) The membranes of the two microphones must be aligned one above the other; the black line indicates their location.

6. A shotgun microphone requires a larger windscreen than, for example, a small supercardioid. On a boom this adds extra weight and an additional wind load.

7. Speaking more generally, inexperienced users tend to expect greater "selectivity" than a shotgun microphone has to offer. A shotgun microphone cannot exclude the sound of someone's voice by aiming it at a person standing right next to them, nor can it compensate for a recording distance that is much greater than normal for an ordinary microphone. In fact, when placed too far away the sound quality of a shotgun microphone will probably be distinctly inferior to that of a good supercardioid, since it will be working in a diffuse sound field where its response falls off at high frequencies (as explained earlier).

The above points are intended to clarify the choice between a shotgun microphone and another highly directional type, the supercardioid. A direct comparison under "real world" conditions is often a surprising and revealing experience.

**** Reverberation radius ("critical distance"):**

A sound source generates a certain level of direct sound energy which diminishes strongly as a function of distance. If the sound is occurring in a room, some amount of diffuse sound energy will be built up by repeated reflections from acoustic barriers (mainly walls).

The level of diffuse sound in any given part of the room will depend less on the distance from the sound source than is the case for the level of direct sound. In the theoretical ideal case, the level of diffuse sound would be the same everywhere in the room.

The distance at which the reflected sound reaches an equal level to the direct sound is called the reverberation radius. ("Radius" is used because we assume that sound from a point source will spread out in a spherical manner

Overview of Stereophonic Recording Techniques

Overview of surround recording techniques: see following page

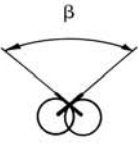
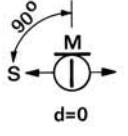
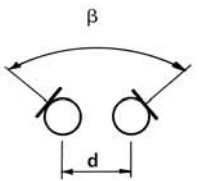
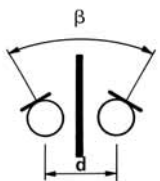
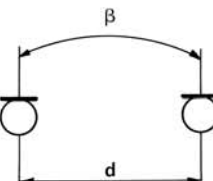
Stereo recording principle	coincident microphone placement		level differences + minor arrival-time differences	microphones separated by an acoustically opaque object	major arrival-time differences
Name	X/Y	M/S	ORTF (for example)	Jecklin disk (for ex.)	A/B (spaced omni recording)
Geometry					
Distance (d) between microphones	0 cm usually vertically aligned		5 cm – 30 cm ↕ distance and angle are interdependent	depends on the object between them	40 cm – 80 cm or greater (up to several meters)
Angle between microphones	70° – 180°	90°	0°–180°	typically 20°	0° – 90°
Acoustic operating principle of the microphone	pressure-gradient transducer (e.g. SCHOEPS cardioid MK 4 or CCM 4)			usually pressure transducers* (e.g. SCHOEPS MK 2S or CCM 2S)	
Sonic impression	clean, clear, often bright			big, spacious; especially good low-frequency reproduction when omnidirectional condenser microphones are used	
Spaciousness	often rather limited		satisfactory	good	very good
Localization	←		good	adequate	→ indistinct, (potentially unstable)

*These recording methods can also employ pressure gradient microphones, though this is not often done.

**The appropriate angle between microphones depends on their directional pattern and the recording angle (the range within which the sound sources should be placed, as "seen" by the microphone.)



Category of microphone arrangement →	Coincident placement	Near-coincident placement	Microphones separated by an acoustic baffle	Spaced microphones
Principle by which the stereo effect is obtained	level differences	level plus minor arrival-time differences	frequency-dependent level and time differences	arrival-time differences primarily
Typical setups	Double M/S, First-order Ambisonics	OCT Surround, MMAD, INA 5, IRT cross	KFM 360 system	Decca Tree, Omni Curtain, Polyhymnia Array, Hamasaki Square
Geometry				
Distance between microphones	0 cm	15 – 100 cm	15 – 20 cm	100 – 500 cm
Microphone types used	pressure-gradient transducers (e.g. SCHOEPS cardioid CCM 4 or MK 4, supercardioid CCM 41 or MK 41, figure-8 CCM 8 or MK 8)		SCHOEPS KFM 360 / DSP-4 KFM 360	mainly pressure transducers (e.g. SCHOEPS CCM/MK 2H), also possible with cardioids or wide cardioids
Sonic impression (depending on which microphones are used)	clean, clear, often bright	natural, clean, clear	natural	spacious
			full low-frequency reproduction when omnidirectional microphones are used	
Spaciousness*	often limited; depends on M/S decoding parameters	natural, transparent, good depth	natural	good, enhanced (can become exaggerated)
Localization*	good; depends on decoding parameters	very good	generally fairly good	somewhat indistinct
Size of listening area*	small; better when additional delay is employed	large	rather large	depends on microphone distances
Envelopment*	limited; better when supplemented by an A/B pair	good envelopment possible		
Downmix compatibility	two-channel and/or mono (!)	two-channel compatibility can be good if considered in the array design (e.g. OCT 2)	perfect	potentially good, but this requirement must be taken into account and the setup tested for this purpose

* The statements here are necessarily rather general. The properties of the recording often depend on various parameters which cannot be covered in detail in this list. These properties can furthermore be varied by combining various aspects of different setups.

This list should be considered as a snapshot of current techniques for surround recording. It may be subject to change. It is not intended to create dogmas or "untouchable" recipes for surround recording. The recording engineer and producer are needed more than ever to listen, consider and adjust the results obtained.

Specifications for SCHOEPS Microphone Cables

- flexible, even in the cold
- highly tear-resistant insulation (Kevlar-reinforced)
- high bending strength
- will not turn with changing temperature, thus ideal for suspending microphones
- 100% shield coverage in three- and four-conductor versions

	2-conductor	3-conductor	4-conductor
conductor diameter:	0.14 mm ²	0.14 mm ²	0.14 mm ²
insulating material:	Hytrel	Hytrel	Hytrel
conductor arrangement:	2 braided conductors	3 braided conductors	4 braided conductors
shielding:	crossbraided, tinned copper conductors	crossbraided with conductive inner covering, 100% coverage	crossbraided with conductive inner covering, 100% coverage
outer covering:	Polyurethane	Polyurethane	Polyurethane
outer diameter:	3 mm	4 mm	4.4 mm
weight:	15 g/m (0.16 oz/ft)	22 g/m (0.24 oz/ft)	25 g/m (0.27 oz/ft)
minimum bending radius:	10 mm	13 mm	15 mm
resistance:	100 Ohm/km	100 Ohm/km	100 Ohm/km
capacitance (conductor /conductor):	100 pF/m	100 pF/m	100 pF/m
insulation resistance:	> 50 MOhm × km	> 50 MOhm × km	> 50 MOhm × km

Pin Assignment with XLR-3M Plugs:

- Pin 1: GND
- Pin 2: +phase
- Pin 3: -phase

bottom view
(as the pins are seen)

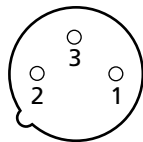

Pin Assignment with XLR-5M Plugs:

- Pin 1: GND
- Pin 2: +phase channel I
- Pin 3: -phase channel I
- Pin 4: +phase channel II
- Pin 5: -phase channel II

bottom view
(as the pins are seen)

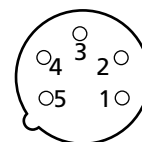

Instructions for Mounting longer Goosenecks with two AF 1 Flanges

First, fasten the two AF 1s securely, one precisely above the other, to the lectern or table top. Then screw the gooseneck onto the 3/8" threads at the end of the ST 20-3/8 cylinder. Push the XLR connector of the output cable through the AF 1s and press the cable into the groove in the side of the cylinder. Finally, insert the cylinder (with the output cable now attached) into the AF 1s.

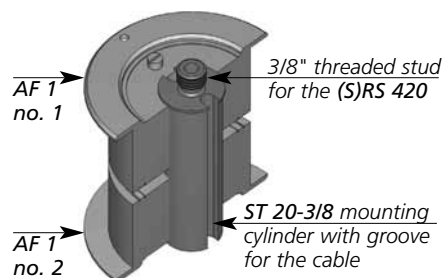



Specifications for MK _ capsules with CMC 6 microphone amplifier, and CCM

(When the CMC 6 xt microphone amplifier is used with axially addressed capsules (*) the frequency response extends beyond 40 kHz).

microphone type (MK_/CCM_)	polar pattern	frequency range	sensitivity	equivalent noise level CCIR*** A-weighted**	signal-to-noise A-weighted**	max. SPL 0.5%THD)
MK/CCM 2*	omni	20 Hz – 20 kHz*	16 mV/Pa	23 dB 11 dB-A	83 dB-A	130 dB
MK/CCM 2H*	omni	20 Hz – 20 kHz*	15 mV/Pa	23 dB 11 dB-A	83 dB-A	130 dB
MK/CCM 2S*	omni	20 Hz – 20 kHz*	12 mV/Pa	24 dB 12 dB-A	82 dB-A	132 dB
MK/CCM 3*	omni	20 Hz – 20 kHz*	10 mV/Pa	26 dB 14 dB-A	80 dB-A	134 dB
BLM 3g	hemisphere	20 Hz – 20 kHz	19 mV/Pa	23 dB 12 dB-A	82 dB-A	128 dB
BLM 03 Cg	hemisphere	20 Hz – 20 kHz	19 mV/Pa	23 dB 12 dB-A	82 dB-A	128 dB
MK/CCM 21*	wide cardioid	30 Hz – 20 kHz*	13 mV/Pa	24 dB 14 dB-A	80 dB-A	132 dB
MK/CCM 21H*	wide cardioid	30 Hz – 20 kHz*	10 mV/Pa	26 dB 16 dB-A	78 dB-A	134 dB
MK/CCM 4*	cardioid	40 Hz – 20 kHz*	13 mV/Pa	24 dB 15 dB-A	79 dB-A	132 dB
MK/CCM 4V	cardioid	40 Hz – 20 kHz	13 mV/Pa	24 dB 14 dB-A	80 dB-A	132 dB
MK/CCM 41*	supercardioid	40 Hz – 20 kHz*	14 mV/Pa	24 dB 15 dB-A	79 dB-A	132 dB
MK/CCM 41V	supercardioid	40 Hz – 20 kHz	14mV/Pa	23 dB 14 dB-A	80 dB-A	132 dB
MK/CCM 8	figure-8	40 Hz – 16 kHz	10 mV/Pa	26 dB 18 dB-A	76 dB-A	134 dB
MK/CCM 5*	omni	20 Hz – 20 kHz*	10 mV/Pa	26 dB 14 dB-A	80 dB-A	133 dB
	cardioid	40 Hz – 20 kHz*	13 mV/Pa	24 dB 15 dB-A	79 dB-A	132 dB
MK 6	omni	20 Hz – 16 kHz	10 mV/Pa	26 dB 14 dB-A	80 dB-A	135 dB
	cardioid	40 Hz – 16 kHz	11 mV/Pa	26 dB 16 dB-A	78 dB-A	134 dB
	figure-8	40 Hz – 16 kHz	10 mV/Pa	27 dB 18 dB-A	76 dB-A	134 dB
MK/CCM 4S	cardioid	80 Hz – 20 kHz	12 mV/Pa	25 dB 15 dB-A	79 dB-A	132 dB
MK/CCM 40	cardioid	80 Hz – 20 kHz	18 mV/Pa	22 dB 12 dB-A	82 dB-A	129 dB
MK/CCM 4A	cardioid	close pickup	3 mV/Pa	31 dB 19 dB-A	75 dB-A	144 dB
MK/CCM 4VXS	cardioid	close pickup	10 mV/Pa	25 dB 14 dB-A	80 dB-A	134 dB
MK/CCM 41S	supercardioid	80 Hz – 20 kHz	14 mV/Pa	24 dB 15 dB-A	80 dB-A	132 dB

* Axially-addressed capsule; when used with the CMC 6 xt amplifier, the frequency range extends up to 40 kHz.

** IEC 61672-1

*** IEC 60268-1

Conditions of measurement:

Sensitivity: measured on-axis in the free sound field with a CMC 6 microphone amplifier at 1 kHz and with a load resistance of 1 kOhm with standardized powering

Equivalent noise level and signal-to-noise ratio are measured according to IEC 60268-1 ("CCIR") and IEC 61672-1 ("A-weighted").

Maximum sound pressure level (max. SPL): SPL at which the total harmonic distortion (THD) at the output of the microphone is 0.5%.

The data for boundary-layer capsules (BLM 3g, BLM 03 Cg) assume an adequately large sound-reflecting area.

Signal-to-noise specifications that follow these standards are intended to allow comparison of noise floor levels for different microphones. Unlike signal-to-noise specifications for other types of audio equipment (which give the ratio of a component's clipping point to its noise floor), these values do not indicate a microphone's entire available dynamic range. Instead, the values are measured with reference to a standard sound pressure level of 1 Pascal (1 Pa = 94 dB SPL) even

though the actual maximum SPL capability of any usable microphone must exceed that reference level substantially. (SCHOEPS microphones when properly powered can typically handle levels some 40 dB above 1 Pa, for example.)

As a result of this approach, professional microphones can seem to have rather modest signal-to-noise values even when they have extremely low noise and very high SPL capability in fact. Ultimately the two other values mentioned (equivalent noise and maximum SPL) both affect a microphone's suitability for a given application.

The use of "A" weighting when specifying the equivalent noise level of microphones is another often-misunderstood aspect of the standards. "A" weighting yields a distinctly lower noise specification – often by 10 dB or thereabouts – and this figure, of course, becomes the one most often cited in advertising. But the CCIR weighted noise level may well be a more accurate indicator of a microphone's perceived noise level in practice.



Frequency Response Curves "xt" Amplifier, KA 40

Frequency response of CMC 6 xt or CMD 2 xt amplifiers with various capsules:

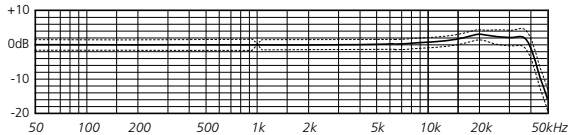

Frequency response curve MK 2 + CMD 2 xt or CMC 6 xt

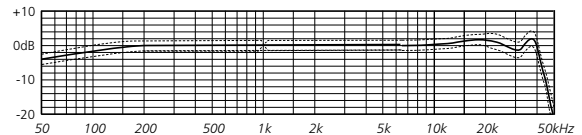

Frequency response curve MK 41 + CMD 2 xt or CMC 6 xt

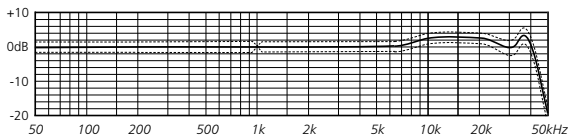

Frequency response curve MK 2H + CMD 2 xt or CMC 6 xt

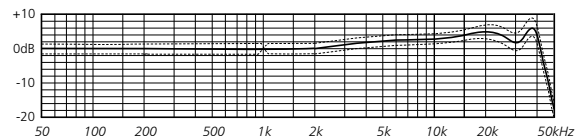

Frequency response curve MK 5 (omnidirectional setting) + CMD 2 xt or CMC 6 xt

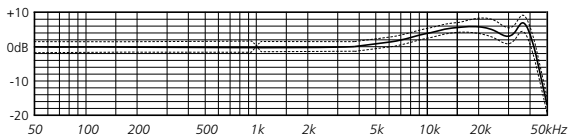

Frequency response curve MK 2S + CMD 2 xt or CMC 6 xt

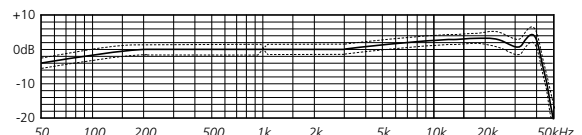

Frequency response curve MK 5 (cardioid setting) + CMD 2 xt or CMC 6 xt

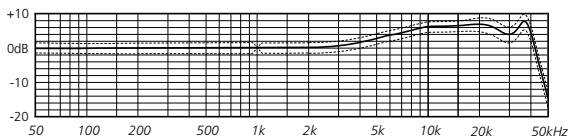

Frequency response curve MK 3 + CMD 2 xt or CMC 6 xt

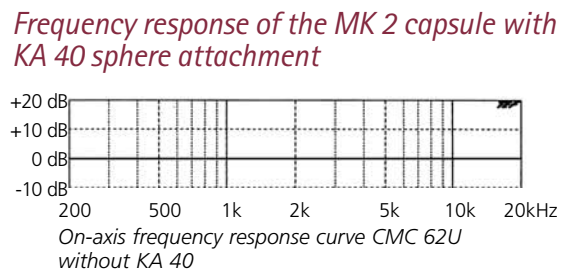

On-axis frequency response curve CMC 62U without KA 40

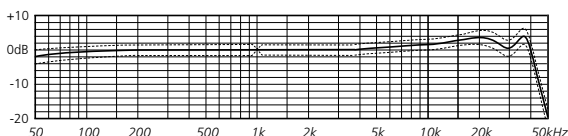

Frequency response curve MK 21 + CMD 2 xt or CMC 6 xt

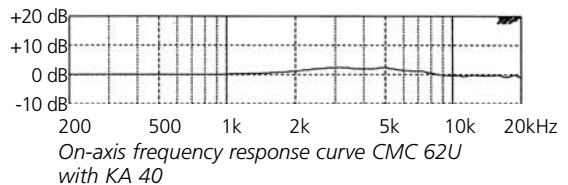

On-axis frequency response curve CMC 62U with KA 40

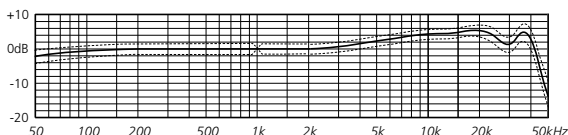

Frequency response curve MK 21H + CMD 2 xt or CMC 6 xt

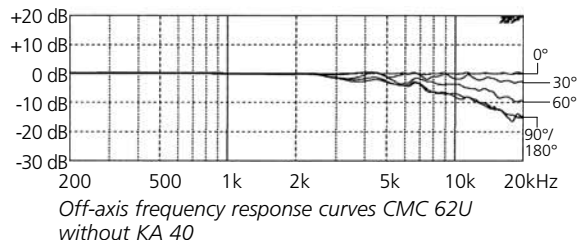

Off-axis frequency response curves CMC 62U without KA 40

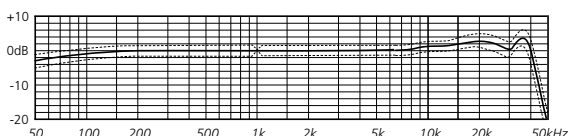

Frequency response curve MK 4 + CMD 2 xt or CMC 6 xt

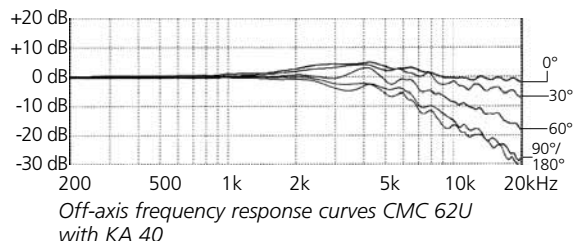

Off-axis frequency response curves CMC 62U with KA 40





Product Finder





















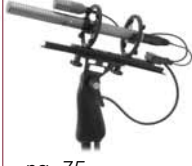













index

Product Overview



	Recording technique: mono / A/B	double pickup	baffle-derived stereo
<p>Recording situation:</p> <p>on a stand</p>			
<p>on a table or lectern, (fixed)</p>			
<p>on a table (movable)</p>			
<p>hanging</p>			
<p>on an instrument</p>			
<p>on floor or wall</p>			
<p>on a boom (outdoors)</p>			
<p>miscellaneous</p>			



ORTF	X/Y	M/S	Blumlein	surround
 <i>pg. 93</i>  <i>pg. 93</i>  <i>pg. 92</i>  <i>pg. 92</i>  <i>pg. 92</i>	 <i>pg. 95</i>  <i>pg. 96</i>  <i>pg. 96</i>	 <i>pg. 92</i>  <i>pg. 92</i>  <i>pg. 75</i>  <i>pg. 87</i>  <i>pg. 88</i>	 <i>pg. 84</i>	 <i>pg. 98</i>  <i>pg. 103</i>  <i>pg. 101</i>
	 <i>when perforated metal is used instead of a solid table top; pg. 94</i>	 <i>pg. 87</i>		 <i>pg. 103</i>  <i>pg. 100</i>
	 <i>when perforated metal is used instead of a solid table top; pg. 94</i>	 <i>pg. 87, 118</i>		
 <i>pg. 93</i>	 <i>pg. 95</i>	 <i>pg. 87</i>		 <i>pg. 98</i>
 <i>pg. 67</i>		 <i>pg. 19</i>		
 <i>pg. 93</i>	 <i>pg. 95</i>	 <i>pg. 88</i>  <i>pg. 89</i>  <i>pg. 75</i>		



by Product Category

Accessories	
Active, modular system	41 ff.
electronic	110
mechanical	114
Active Accessories	41 ff.
Active Cables	42 ff.
Active Extension Tubes, mono	59
double version	60
M/S stereo	43, 87
Adapter cables	112 ff.
Attachment	114, 135
Attenuators	45, 111
Base	118
Bass filters for modular system	44
Bass filter for phantom-powered microphones	110
Boundary-layer adapter	67
Boundary-layer capsules	18 ff.
Boundary-layer microphones, directional	54, 67
Cable hangers, mono	67
M/S stereo	87
Cables	111, 133
Capsules	14 ff.
Capsule swivel	45
Cardioids	
for music and speech	23, 52
for close speech in noisy surroundings.	76
CCM compact system	49
CCM compact microphones	5, 48
CMC microphone amplifier	32
Clamps	57
Close-speech microphones	76
Colette modular system	4, 9 ff.
Compact microphones	48
COMPACT MICROPHONE SYSTEM	49
Decca set	
Desk stands	65 ff.
Directional microphones	23 ff., 74, 129
Double M/S	75, 101 ff.
Double extension tube	60
Double tabletop microphone	64, 66
Elastic suspensions	
for stands	57
for booms	68
for table mounting	116
miniature for M/S stereo	88, 89, 92
EMC cable	112
Extension tubes	59
for M/S stereo	43, 87
Figure-8	27, 53
Floor stand	118
Foam mat	118
Foam-type windscreens	122
hollow version	125
Goosenecks	62 ff.
Handheld microphones	80
Headset	79
High-pass filter	44, 110
Hollow foam-type windscreens	125
Instrument adapters	69 ff.
Interference-tube directional microphone	74, 129
IRT cross mounting bar	103
Low-cut filter for modular system	44
Low-cut filter for CCM and other phantom-powered microphones	110
Low-pass filter	110
Matrix	106
Measurement microphone	14
Microphones	
battery-powered	37
phantom-powered	31
with tube microphone amplifier	36
switchable pattern	28, 53
for A/B recordings	14 – 20, 50
for Blumlein recordings	27, 53
for boundary-layer technique	18, 54, 67
for close speech	76
for mounting under table	61
for M/S recordings	87
for pocket transmitters	39
for speakers/singers	80
for X/Y recordings	94
Microphone mounting bars	84, 96, 114
Microphone cables	112, 133
Microphone capsules	14 ff.
switchable pattern	28, 53
Microphone clamps	57
Microphone cross (IRT)	103
Microphone specifications	134
Microphone preamplifier	106
Microphone stand	58
Miniature stereo recording system	82
Modular system	9 ff.
M/S bar	86
M/S boundary-layer technique	19, 92
M/S double clamp	88
M/S stereo	87 ff.
OCT system	100, 132
OCT surround	100, 132
Omnidirectional microphones	14 ff., 50
ORTF microphone	93
ORTF stereo	92 ff.
Pads	45, 111
Phantom powering tester	111
Pop filters	122
Powering unit	106
Pressure transducers	14 ff., 50, 128
Pressure-gradient transducers	21 ff., 51, 128
“PZM” microphones	18 ff.
directional	54, 67
Recording techniques,	131 ff.
Saxophone adapter	66
SCH0EPS cable	71
Shock mounts	
for stands	57
for booms	68
miniature for M/S stereo	88, 89, 92
Shotgun microphones	74, 129
Special capsules/microphones for close pickup	76
Sphere attachment	114, 135
Sphere microphone for stereo	85
for surround/stereo	98
Stand clamps	56
for M/S stereo	87
Stereo microphones	81 ff.
Stereo microphone amplifier	106
Stereo bracket	114
Stereo recording techniques, overview	131
Straight extension tubes	59
Supercardioids	25, 53
Support rods	116
Surround front system (OCT)	100, 132
Surround matrix	102
Surround setups	97 ff.
Surround recording techniques (overview)	132
Swivel for capsules	45
Table mounting	61
Table mounting flange	117
Table stands	66, 118
Tabletop microphones	64 ff.
Tester for phantom powering	111
Tripod table stands	65
Tube microphone amplifier	36
Vertical support rod	116
Vibration isolation mat	118
Vocalist microphones	80
Wide cardioids	22, 51
Windscreens	119 ff.
Windscreens for M/S	126
X/Y stereo	94 ff.
X/Y stereo microphone	94
Y-cables	11, 43, 49, 82, 113



Search by Product Name

AC	57	MK 4VXSg	77
ACA 53	68	MK 40g	77
AF 1	116	MK 41g	27
AK DMS 3U	102	MK 415g	78
AKI/2C	82	MK 41Vg	26
AK SU/2U	112	MK 5g	28
AK 2U/SU	112	MK 6g	29
AMS, AMS CI, -LI, -LU	88, 89	MK 8g	27
AMS 22	92	MS-BLM	19
A 20 (S)	57	MSTC 64g	93
A 20 CMXY	95	M 100 C	96
A 22 (S)	57	M 222	36
BBG	124	PHS 48	111
BF 250	118	PR 120 S, PR 120 SV	122
BLCg	67	PS 4	80
BL CCM 3Lg	54	RC _g	59
BLM 03 Cg	20	RC _KC 0,5g	60
BLM 3g	18	RCY _/2 lg	87
B 1	122	RG 8	59
B 1 D	122	RG 12	116
B 5	123	RLG 350 Ug	62
B 5 D, B 55 D	125	RL _g	59
B 20 (S)	123	RS 420 Cg	63
CB-MAB	100	RS 420 L5Ug	63
CB 140, CB 200, CB 250	103	R2C _ KC 0,5g	60
CCM _ , all types	48 ff.	S _ Cg	63
CMB-I	37	SA 2	71
CMC _Ug	31	SGC, SGCM	56
CMD 2U	35	SGH	80
CMH 64U, CMH 641U	80	SGMSC	87
CMIT 5 U	74	SG 20	56
CMR	39	SG 22	56
CMXY 4V lg/CMXY 4V Ug	94	SG 22 mod	56
CUT 1g, CUT 2g	44	SM 270	118
C2 CCM 4 Ug	64	Softie (for CMIT 5 U)	74
DMS-Splitter	101	SPV 12-3/8	118
Double MS Sets	97	SRS 420 Cg	63
DSP-4 KFM 360 processor	98	SRS 420 L5Ug	63
DZC 10g, DZC 20g	45	STCg	92
F 5g	117	STR-TC	116
FA 1	71	STR _g	116
GA 1	71	STV 900/1400 L3Ug	58
GVCg	45	ST 5/8-3/8	84
HBL	79	ST 20-3/8	116
HC	67	S 250 Cg	63
HSGMSC	87	S 250 L5Ug	62
HS 2S, HS 4VXS	79	S 250 LUg	62
H 20g	67	TA 20g	65
KA 40	114	TCg, TC 2g	66
KC _g	42	TR 200 KC 2g	65
KCY 250/ _ lg	43	TR 200 Lg	65
K DMS 5U	101	TSR 200 Lg	65
KFM 6	85	T2 CCM4g	66
KFM 360	98	T 5g	118
KHS LI	79	T 20g	65
KIY 250/0 I	38	UMS 20	114
KKFM	86	VA 1	69
KLY 115/ _ I	89	VA 2	69
KLY 115/0,25 SU	89	VA 3	70
KLY 250/5 SU	113	VA 4	70
KMAB 1000	84	VA 5	70
KMSC	88	VMS 5 U	106
KS _ I	113	VMS 5 DC-W	107
KS 5 IU	113	VST 62 IUg	43
KS _ U	112	WB	126
K 5 LU	113	WKC 5g	44
K 20 STR	117	WKFM	85
K 30 STR	45	WMS	126
K _ U	112	WSR CMIT U (with Connbox)	75
LC 60 U, LC 120 U	110	WSR CMXY	95
LP 40 U	110	WSR DMS CMIT LU (with Connbox, 2x KMSC)	75, 103
MAB 1000	84	WSR DMS LU (with Connbox)	102
MC-MAB	84	WSR MS (without internal cables)	88
MDMS U	102	WSR MS CI, -LI, -LU (with cables and cable box)	88, 89
MDZ 10 U, MDZ 20 U	111	WSR MS CMIT LU (with Connbox, KMSC)	75
MK 2g	14	WSR MS 100 LU (with Connbox, KMSC)	89
MK 2Hg	15	WSR 100 LU (with Connbox)	68
MK 2Sg	16	W 5	123
MK 21g	21	W 5 D	126
MK 21Hg	22	W 20	124
MK 3g	17	W 20 R 1	124
MK 4g	23	W 140	74
MK 4Ag	78	Z 10	117
MK 4Sg	76		
MK 4Vg	24		







Schalltechnik Dr.-Ing. **SCHOEPS** GmbH
Spitalstr. 20
76227 Karlsruhe
Germany

Tel.: +49 721 / 943 20-0 · Fax: +49 721 / 495 750
mailbox@schoeps.de · www.schoeps.de

U.S. editorial consultant / translator: David Satz

*Not responsible for errors or omissions.
© Schalltechnik Dr.-Ing. **SCHOEPS** GmbH
Printed in Germany 080107a*



Photos on this page: Silke Voss, Karlsruhe