



OPERATING INSTRUCTIONS

INDOOR UNIT
MSZ-FA25VA
MSZ-FA35VA

For customers

Thank you very much for purchasing this Mitsubishi room air conditioner.

- To use this unit correctly and safely, be sure to read these operating instructions before use. Keep this manual carefully for later reference.
- Be sure to receive a guarantee card from your dealer and check that the purchased date and shop name, etc. are entered correctly.
- This air conditioner should not be installed by the customer. (Safety and performance functions cannot be assured.)



CONTENTS

SAFETY PRECAUTIONS	2
NAME OF EACH PART	3
PREPARATION BEFORE OPERATION	4
AUTO CHANGEOVER... AUTO MODE OPERATION	6
MANUAL OPERATION (COOL, DRY, HEAT)	7
i-see CONTROL OPERATION... SENSIBLE-TEMPERATURE CONTROL	7
AREA SETTING WITH i-see SENSOR	8
AREA SETTING	8
AIR FLOW VELOCITY AND DIRECTION ADJUSTMENT	9
PLASMA DUO... PLASMA DEODORIZING & PLASMA AIR PURIFYING	9
ECONO COOL OPERATION	11
TIMER OPERATION (ON/OFF TIMER)	11
WHEN THE AIR CONDITIONER IS NOT GOING TO BE USED FOR A LONG TIME	11
MAINTENANCE	11
CLEANING THE FRONT PANEL, HEAT EXCHANGER AND FAN	12
CLEANING THE AIR FILTER	12
CLEANING THE PLASMA DEODORIZING/AIR PURIFYING FILTER UNITS	13
REPLACEMENT OF THE PLASMA DEODORIZING FILTER (DEODORIZING CERAMIC FILTER)	13
CLEANING THE AIR OUTLET AND FAN OF THE INDOOR UNIT	14
BEFORE CONTACTING THE SERVICE REPRESENTATIVE, CHECK THE FOLLOWING AGAIN	15
WHEN YOU THINK THAT TROUBLE HAS OCCURRED	15
INSTALLATION, RELOCATION AND INSPECTION	16
SPECIFICATIONS	17







SAFETY PRECAUTIONS

- Since rotating parts and parts which could cause an electric shock are used in this product, be sure to read these "Safety Precautions" before use.
- Since the cautionary items shown here are important for safety, be sure to observe them.

Marks and their meanings

-  **WARNING:** Incorrect handling could cause a serious hazard, such as death, serious injury, etc. with a high probability.
-  **CAUTION:** Incorrect handling could cause a serious hazard depending on the conditions.





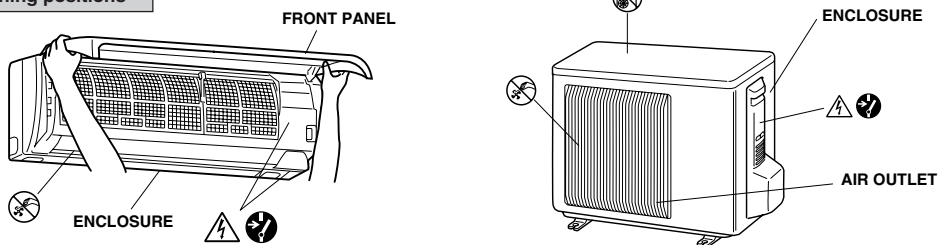

Meanings of symbols used in this manual



- The colour of the sticker affixed to the unit is written in the parentheses.
-  : Be sure not to do.
 -  : Be sure to follow the instruction.
 -  (Black) : Never insert your finger or stick, etc.
 -  (Black) : Never step onto the indoor/outdoor unit and do not put anything on them.
 -  : Danger of electric shock. Be careful.
 -  : Be sure to disconnect the power supply plug from the power outlet.
 -  : Be sure to shut off the power.
- After reading this manual, keep it together with the installation manual in a handy place for easy reference.

Warning positions



- This air conditioner is NOT intended for use by children or infirm persons without supervisions.

 WARNING	
	<p>Do not use intermediate connection of the power supply cord or the extension cord and do not connect many devices to one AC outlet.</p> <ul style="list-style-type: none"> • A fire or an electric shock may result from poor contact, poor insulation, exceeding the permissible current, etc.
	<p>Do not scratch or process the power supply cord, etc.</p> <ul style="list-style-type: none"> • Do not put heavy object on the power supply cord and do not scratch or process the cord. The cord may be damaged and this may cause a fire or an electric shock.
	<p>Do not turn the breaker off/on and/or disconnect/connect the power supply plug during operation.</p> <ul style="list-style-type: none"> • This may cause a fire due to spark, etc. • Be sure to turn off the breaker and/or disconnect the power supply plug absolutely after switching the indoor unit off with the remote controller.
	<p>Do not expose your skin directly to cool air for a long time.</p> <ul style="list-style-type: none"> • This could damage your health.
	<p>The customer should not install this unit.</p> <ul style="list-style-type: none"> • If this is done incorrectly, it may cause a fire, an electric shock, or injury from the unit falling, water leaking, etc. Consult your dealer.
 	<p>Do not insert your finger or a stick, etc. into the air inlet/outlet.</p> <ul style="list-style-type: none"> • Since the fan rotates at high speed, this may cause an injury. • Young children should be supervised to ensure that they do not play with the air conditioner.
 	<p>When an abnormality (burning smell, etc.) occurs, stop the air conditioner and disconnect the power supply plug and/or turn off the breaker.</p> <ul style="list-style-type: none"> • If the unit continues to be operated in an abnormal condition, it may cause a fire, trouble, etc. In this case, consult your dealer.
	<p>Repairs or relocation should not be done by the customer.</p> <ul style="list-style-type: none"> • If this is done incorrectly, it may cause a fire, an electric shock, or injury from the unit falling, water leaking, etc. Consult your dealer. • If the power supply cord is damaged, it must be replaced by the manufacturer or its service agent in order to avoid a hazard.

 CAUTION	
	<p>When the air filter is to be removed, do not touch the metal part of the indoor unit.</p> <ul style="list-style-type: none"> • This may cause an injury.
	<p>Do not use an insecticide or flammable spray.</p> <ul style="list-style-type: none"> • This may cause a fire or deformation of the cabinet.
	<p>Do not put a pet or houseplant where it will be exposed to direct airflow.</p> <ul style="list-style-type: none"> • This could injure the pet or plant.
	<p>Do not leave the unit on an installation stand which is damaged.</p> <ul style="list-style-type: none"> • The unit may fall and this may cause an injury.
	<p>Do not step onto an unstable bench when maintaining the unit, etc.</p> <ul style="list-style-type: none"> • This may cause an injury, etc., if you fall down.
	<p>Do not pull the power supply cord.</p> <ul style="list-style-type: none"> • The core wire of the power supply cord may be disconnected and this may cause a fire.
	<p>Do not charge or disassemble the batteries and do not throw them into a fire.</p> <ul style="list-style-type: none"> • This may result in leakage, fire or an explosion.
	<p>Do not operate the unit for a long time in high humidity, e.g. leaving a door or window open.</p> <ul style="list-style-type: none"> • In the cooling mode, if the unit is operated in a room with high humidity (80% RH or more) for a long time, water condensed in the air conditioner may drop and wet or damage furniture, etc.
	<p>Do not operate the unit at low outside temperature (less than -10°C) in the cooling mode.</p> <ul style="list-style-type: none"> • In the cooling mode, if the unit is operated at low outside temperature (less than -10°C), water condensed in the air conditioner may drop and wet or damage furniture, etc.

SAFETY PRECAUTIONS

⚠ CAUTION

⊘	Do not use the unit for special purposes.
	<ul style="list-style-type: none"> Do not use this air conditioner to preserve precision devices, food, animals, plants and art objects. This may cause deterioration of quality, etc.
!	Do not put a stove, etc. where they are exposed to direct airflow.
	<ul style="list-style-type: none"> This may cause imperfect combustion.
!	When the unit is to be cleaned, switch it off and disconnect the power supply plug or turn off the breaker.
	<ul style="list-style-type: none"> Since the fan rotates at high speed during operation, this may cause an injury.
!	When the unit is not going to be used for a long time, disconnect the power supply plug or turn off the breaker.
	<ul style="list-style-type: none"> Otherwise, dirt may collect and this may cause a fire.
!	Replace the 2 batteries with new ones of same type.
	<ul style="list-style-type: none"> Using an old battery together with a new one may result in heat generation, leakage or an explosion.
!	If liquid from the batteries gets onto your skin or clothes, wash it well with clean water.
	<ul style="list-style-type: none"> If liquid from the batteries gets into your eyes, wash them well with clean water and consult a doctor at once.
!	Ventilate well in using the unit with a stove, etc.
	<ul style="list-style-type: none"> An oxygen shortage may occur.
⚡	Do not operate switches with wet hands.
	<ul style="list-style-type: none"> This may cause an electric shock.
!	Do not clean the air conditioner with water.
	<ul style="list-style-type: none"> Water may enter the unit and degrade the insulation. This may cause an electric shock.
⊘	Do not step or put anything on the indoor/outdoor unit.
	<ul style="list-style-type: none"> This may cause an injury, etc. if you or something falls down.

For installation

⚠ WARNING

- Consult your dealer for installation of the air conditioner.

⚠ CAUTION

⊘	Do not install the unit where flammable gas could leak.
	<ul style="list-style-type: none"> If gas leaks and collects around the unit, it may cause an explosion.
!	Earth the unit.
	<ul style="list-style-type: none"> Do not connect the earth to a gas pipe, water pipe, lightning rod or the earth of a telephone. If the earthing is incorrect, it may cause an electric shock.
!	Install an earth leakage breaker depending on the place where the air conditioner is to be installed (humid places, etc.).
	<ul style="list-style-type: none"> If the earth leakage breaker is not installed, it may cause an electric shock.
!	Drain should be fully drained.
	<ul style="list-style-type: none"> If the drainage route is incomplete, water may drop from the unit. This may wet and damage the furniture.

NAME OF EACH PART

Indoor unit

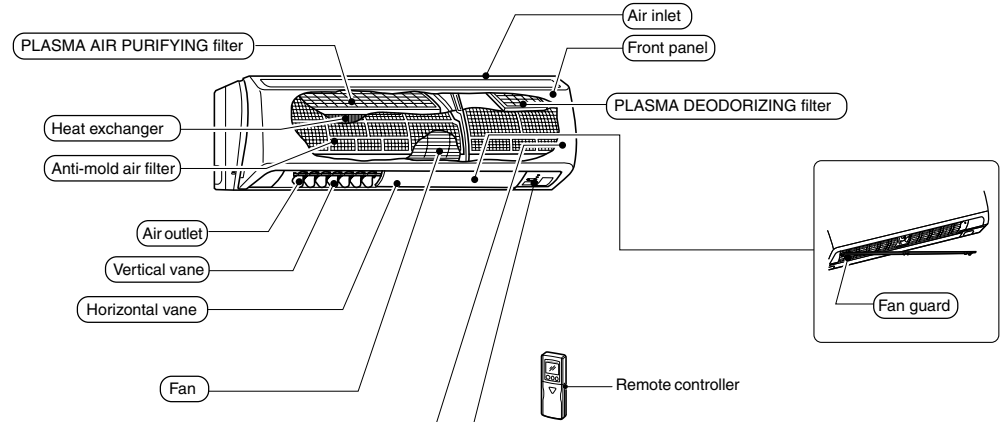

Auto front panel

When the unit starts operating, the front panel opens automatically to draw in air. When the unit stops operating, the front panel closes automatically.

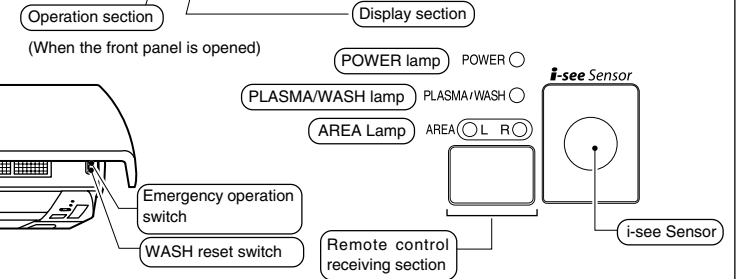
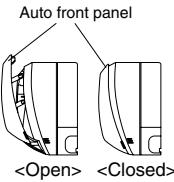

Outdoor unit

MUZ-FA25/35VA

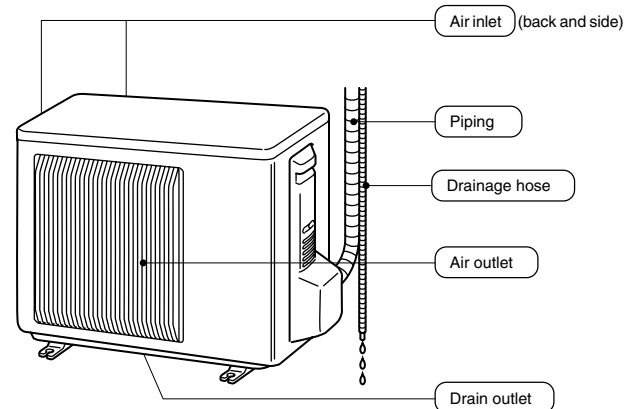

NAME OF EACH PART

Remote controller

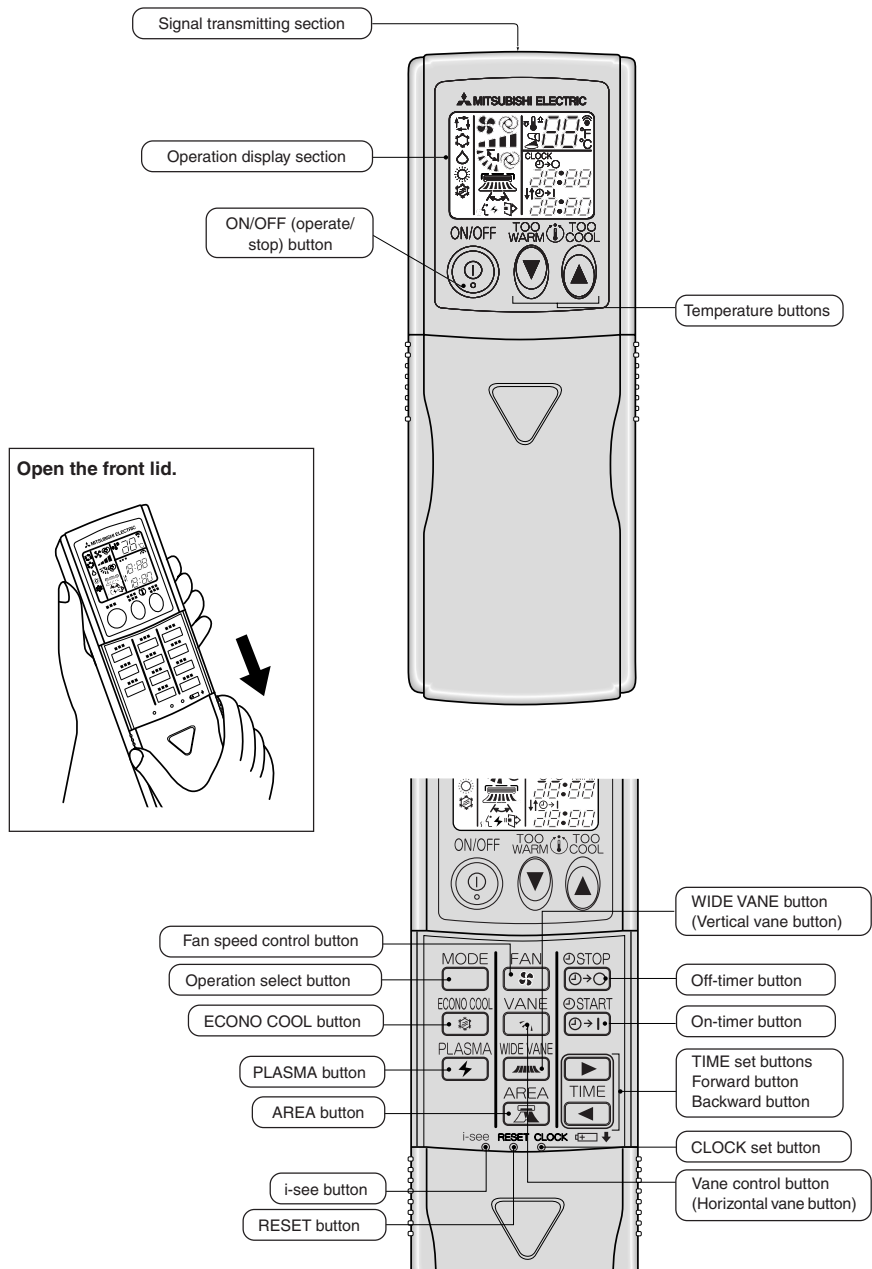

PREPARATION BEFORE OPERATION

Auto restart function

These models are equipped with an auto restart function. If you do not want to use this function, please consult the service representative because the setting of the unit needs to be changed.

Auto restart function is ...

When the indoor unit is controlled with the remote controller, the operation mode, the set temperature and the fan speed are stored in the memory. If a power failure occurs or the main power is turned off during operation, "Auto restart function" sets automatically to start operating in the same mode as the one set with the remote controller just before the shutoff of the main power. (Refer to page 6 for details.)

Outdoor unit

Insert the power supply plug into the power outlet and/or turn the breaker on.

WARNING:

Remove dirt from the power supply plug and insert the plug securely. If dirt adheres to the plug or insertion is incomplete, it may cause a fire or an electric shock.

Remoto controller

Use the remote controller provided with the unit only. Do not use other remote controller.

Be sure to set the slide switch inside the remote controller to an appropriate position in accordance with the installed position of the indoor unit. If the switch is not set correctly, the air conditioner may not function properly.

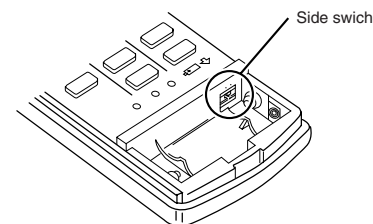

Area	Left	Center	Right
Position of the slide switch	L . C . R	L . C . R	L . C . R
Display on the remote controller			

Where is the indoor unit installed in your room?

Installed at left, if the distance is not more than 50 cm.

Installed at right, if the distance is not more than 50 cm.

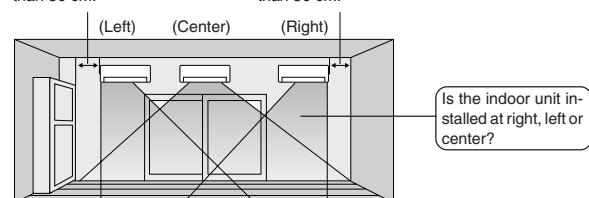

* If the indoor unit is installed more than 50 cm away from the side walls, cabinets or other nearby objects, set the slide switch to the "center" position.

PREPARATION BEFORE OPERATION

Remote controller

How to set the batteries and the current time

- 1 Remove the front lid and insert batteries. Then reattach the front lid.

Insert the minus pole of the batteries first. Check if the polarity of the batteries is correct.

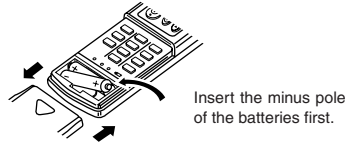

Insert the minus pole of the batteries first.

- 2 Press the RESET button.

Press using a thin stick.

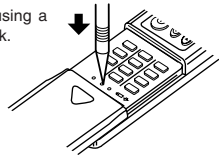

- If the RESET button is not pressed, the remote controller may not operate correctly.
- Be sure to press the RESET button not too strongly.

- 3 Press the CLOCK set button.

Press using a thin stick.

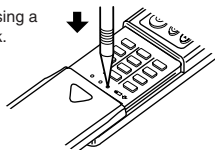

- 4 Press the (Forward) and (Backward) buttons (TIME SET buttons) to set the current time.

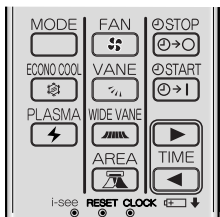

- Each time the button is pressed, the set time increases by 1 minute, and each time the button is pressed, the set time decreases by 1 minute.
- Pressing those buttons longer increases/decreases the set time by 10 minutes.

- 5 Press the CLOCK set button again and close the front lid.

Handling of the remote controller

- The range that the signal can reach is about 6 m when the remote controller is pointed at the front of the indoor unit.
- When a button is pressed, one or two beeps will be heard from the indoor unit. If no sound is heard, operate again.
- Use the remote controller carefully. If it is dropped, thrown or it gets wet, the remote controller may not operate.

When installing on a wall, etc.

- Install the remote controller holder in a position where the signal reception sound (beep) can be heard from the indoor unit when the button is pressed.

How to install/remove the remote controller

Installing : Insert the remote controller downward.
Removing : Pull it up.

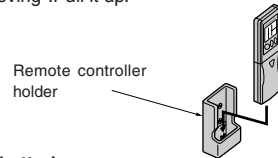

Dry-cell batteries

■ Reference for replacing batteries

Replace the batteries with new AAA alkaline batteries in the following cases:

- When the indoor unit does not respond to the remote control signal.
- When the display on the remote controller becomes dim.
- When a button of the remote controller is pressed, all displays appear on the screen, and then disappear immediately.

Do not use manganese batteries. The remote controller could malfunction.

- The service life of an alkaline battery is about 1 year. However, a battery whose time limit is approaching may be exhausted soon. The recommended usable time limit is indicated (month/year) on the bottom of the battery.
- To prevent liquid leakage, take out all batteries when the remote controller is not going to be used for a long time.

⚠ CAUTION:

If liquid from the batteries gets onto your skin or clothes, wash it well with clean water.

If liquid from the batteries gets into your eyes, wash them well with clean water and consult a doctor at once.

- Do not use rechargeable batteries.
- Replace the 2 batteries with new ones of the same type.
- Dispose of exhausted batteries in the correct manner.

When the remote controller cannot be used (emergency operation)

When the batteries of the remote controller run out or the remote controller malfunctions, the emergency operation can be done using the EMERGENCY OPERATION switch.

- 1 Press the EMERGENCY OPERATION switch.

- Each time the EMERGENCY OPERATION switch is pressed, the unit will operate in order of EMERGENCY COOL MODE, EMERGENCY HEAT MODE and STOP MODE.

However, when the EMERGENCY OPERATION switch is once pressed, the unit will operate in test run for 30 minutes and then the operation mode shifts to EMERGENCY MODE.

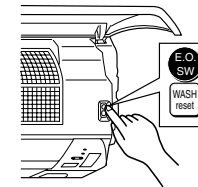

NOTE:

Three seconds after the EMERGENCY OPERATION switch is pressed, the front panel automatically starts moving forward. Close the front panel manually before it starts moving.

- Details of EMERGENCY COOL MODE are as shown below. However, the temperature control does not work for 30 minutes in test run and the unit is set to continuous operation. The fan speed is set to High in test run and shifts to Medium after 30 minutes.

Operation mode	COOL	HEAT
Set temperature	24°C	24°C
Fan speed	Medium	Medium
Horizontal vane	Auto	Auto
Vertical vane	Straight	Straight

- The operation mode is indicated by the POWER indicator lamp on the indoor unit as following figure.

Operation Indicator lamp

EMERGENCY COOL AREA

EMERGENCY HEAT AREA

STOP AREA

NOTE:

This is the indication of the EMERGENCY OPERATION mode. AREA setting is not available during the EMERGENCY OPERATION.

- 2 To stop the emergency operation, press the EMERGENCY OPERATION switch once (in case of EMERGENCY HEAT MODE) or twice (in case of EMERGENCY COOL MODE).

AUTO CHANGEOVER... AUTO MODE OPERATION

An automatic cooling and heating changeover operation system ensures easy control and year-round air conditioning.

Once the desired temperature is set, unit operation is switched automatically between cooling and heating according to the room temperature. In addition, fan control of the outdoor unit enables cooling operation at outside temperature as low as -10 °C.

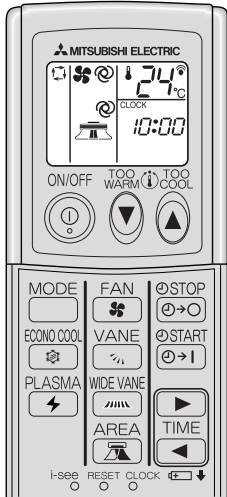

To select the AUTO mode:

- 1 Press the button.
- 2 Select the (AUTO) mode by pressing the button.

Each time this button is pressed, the operation mode is changed in sequence:

(AUTO) → (COOL) → (DRY) → (HEAT)

The set temperature is also displayed on the remote controller.

To stop operation:

- 1 Press the button.

After the operation mode is set once, the operation starts in the same mode as the one set previously from the next time by simply pressing the button.

When the set temperature is to be changed:

- Press the button to lower the temperature. One press lowers the temperature by about 1°C.
- Press the button to lower the temperature. One press lowers the temperature by about 1°C.

Description of “AUTO CHANGEOVER”

(1) Initial mode

- ① When unit starts the operation with AUTO operation from off;
 - If the room temperature is higher than the set temperature, operation starts in COOL mode.
 - If the room temperature is equal to or lower than the set temperature, operation starts in HEAT mode.

(2) Mode change

- ① COOL mode changes to HEAT mode when about 15 minutes have passed with the room temperature 2 degrees below the set temperature.
- ② HEAT mode changes to COOL mode when about 15 minutes have passed with the room temperature 2 degrees above the set temperature.

NOTE:

If two or more indoor units are operating in multi system, there might be a case that the indoor unit, which is operating in (AUTO), cannot change over to the other operating mode (COOL HEAT) and becomes a state of standby. Refer to the detailed information for multi system air conditioner explained on the right.

Description of “AUTO RESTART FUNCTION”

- These units are equipped with an auto restart function. When the main power is turned on, the air conditioner will start operation automatically in the same mode as the one set with the remote controller before the shutoff of the main power.
- If the unit was set to off with the remote controller before the shutoff of the main power, it will remain stopped even after the main power is turned on.
- If the unit is operated in “ AUTO” mode before power failure, the operation mode (COOL, DRY or HEAT) is not stored in the memory. When the main power is turned on, the unit decides the operation mode by the initial room temperature at restart and starts operation again.

Information for multi system air conditioner

Multi system air conditioner can connect two or more indoor units with one outdoor unit. According to the capacity, two or more units can operate simultaneously.

- When you try to operate two or more indoor units with one outdoor unit simultaneously, one for the cooling and the other for heating, the operation mode of the indoor unit that operates earlier is selected. The other indoor units that will start the operation later cannot operate, indicating an operation state. (Refer to the table of Operation Indicator lamp below.) In this case, please set all the indoor units to the same operation mode.
- When indoor unit starts the operation while the defrosting of outdoor unit is being done, it takes a few minutes (max. 10 minutes) to blow out the warm air.
- In the heating operation, the indoor unit that does not operate may get warm or the sound of refrigerant flowing may be heard. This is not a malfunction since the refrigerant continuously flows into the indoor unit that does not operate.

Details of display on the indoor unit

The operation indicator at the right side of the indoor unit indicates the operation state.

POWER POWER: Lighted during operation and on the set of ON timer.

PLASMA/WASH PLASMA/WASH: Please refer to the page explaining each function.

AREA L R AREA: Please refer to the page explaining each function.

Lighted
 Blinking
 Not lighted

Operation indicator lamp

Indication	Operation state
POWER	This shows a state of standby for operation.
PLASMA/WASH	Please refer to Information for multi system air conditioner. (See above)
AREA L R	

MANUAL OPERATION (COOL, DRY, HEAT)

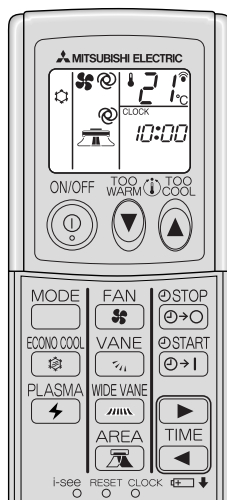

To select the COOL, DRY or HEAT mode:

- 1 Press the button.
- 2 Select the operation mode by pressing the button.
Each time this button is pressed, the operation mode is changed in sequence:
 (AUTO) → (COOL) → (DRY) → (HEAT)

To stop operation:

- Press the button.
After the operation mode is set once, the operation starts in the same mode as the one set previously from the next time by simply pressing the .

When the set temperature is to be changed:

- Press the button to lower the temperature. One press lowers the temperature by about 1°C.
- Press the button to lower the temperature. One press lowers the temperature by about 1°C.

In DRY operation

- The temperature control (temperature setting) cannot be done.
- The room temperature is slightly lowered in this operation mode.

If the air conditioner doesn't cool or heat effectively...

If the fan speed is set to Low or AUTO, sometimes the air conditioner may not cool or heat the air effectively. In this case, change the fan speed to Med. or upper.

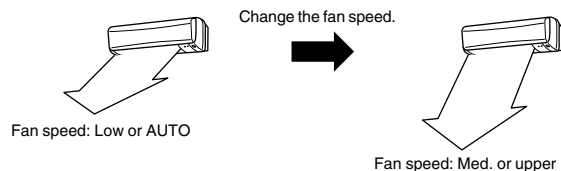

i-see CONTROL OPERATION... SENSIBLE-TEMPERATURE CONTROL

The air conditioner controls the temperature you perceive (“sensible temperature”) in accordance with the room temperature as well as floor/wall temperatures (“i-see control operation”).
To control the room temperature instead of the sensible temperature, cancel the i-see control operation.

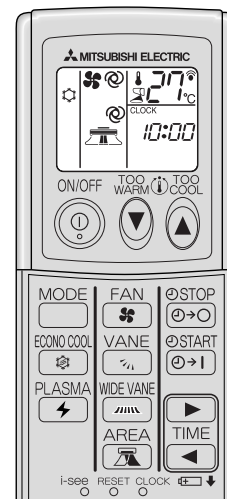

To start i-see control operation:

- During MANUAL COOL or MANUAL HEAT mode, press the i-see button with a thin stick.
When the unit starts the operation in the i-see control operation, the i-see Sensor moves to the right and left intermittently, measuring the floor and wall temperatures.

NOTE:
The i-see control operation is activated when the remote controller is first used following replacement of the batteries or resetting of the remote controller.

To release i-see control operation:

- Press the i-see button with a thin stick again during operation.
NOTE:
If the air conditioner is turned off without canceling the i-see control operation, the i-see control operation is activated the next time the air conditioner is turned on.

i-see control operation

The sensors constantly measure the room and floor/wall temperatures to automatically adjust to the set temperature by estimating the temperature actually perceived by a person inside the room (“sensible temperature”).

Advantages

- The air inside the room is conditioned quickly to a comfortable condition.
- The room will not become too cold or hot even when the air conditioner is kept on for a long period.
- The air conditioner will not overcool or overheat, which means you can save on electricity.

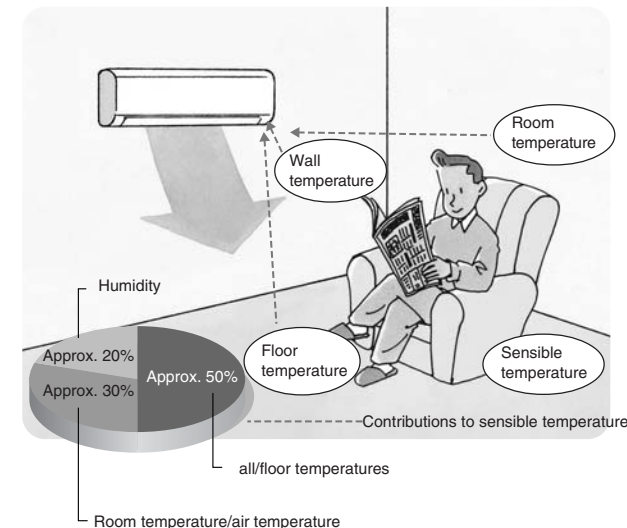

i-see CONTROL OPERATION... SENSIBLE-TEMPERATURE CONTROL

i-see Sensor

- When the AREA setting is not activated, the sensing range of the i-see Sensor differs depending on the installation location of the air conditioner.

Installation position	Installed at left	Installed at center	Installed at right
Image of sensing range			
Direction of sensor	Right	Center	Left

Refer to the description on page 4 for slide switch setting.

- If the AREA setting is activated, the i-see Sensor moves in a range of 150 degrees detecting floor/wall temperature of 3 area (left, right, center). Therefore, the detected temperatures may be different from the temperatures measured on commercial thermometers depending on the condition or temperature distribution on the floor and/or wall.
- Install the front panel correctly after being removed for maintenance or service so that the floor/wall temperatures can be measured correctly.

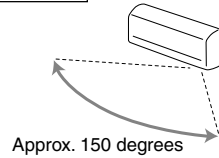

AREA SETTING WITH i-see SENSOR

In the AREA setting, the horizontal air flow direction changes automatically according to the detection of the i-see Sensor which detects the floor/wall temperature to air-condition the room evenly. In addition, because the desired area can be quickly air-conditioned, comfort and energy-saving effect are increased.

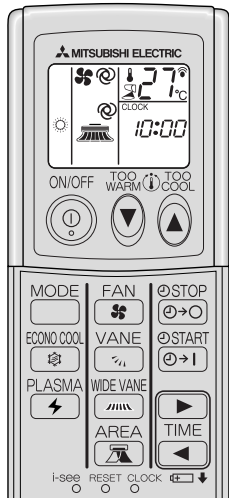

To set the AREA setting:

- Press the button.

Each time the button is pressed, the area is changed in sequence:
 (AUTO) → (LEFT) → (RIGHT) → Cancel

NOTE:

- AREA setting is only available during i-see control operation. (Refer to page 7, 8)
- If the AREA setting is canceled, the vertical vane returns to the previously set position before AREA setting.
- The horizontal air flow direction (), including horizontal SWING, can not be set during AREA setting.

Moving of horizontal air flow direction	<ul style="list-style-type: none"> If the AREA setting is set to AUTO in heating operation, the indoor unit automatically delivers warm air to the area where the floor/wall temperature is the lowest in the room. If the AREA setting is set to AUTO in cooling operation, the indoor unit automatically delivers cool air to the area where the floor/wall temperature is the highest in the room. <p>Ex.) In heating operation</p> <div style="display: flex; justify-content: space-around;"> <div style="text-align: center;"> <p>Day</p> </div> <div style="text-align: center;"> <p>Night</p> </div> </div> <p>The indoor unit delivers warm air detecting the cold area in the room.</p>
Indoor unit display	<p>Indication of AREA setting</p> <div style="display: flex; justify-content: space-around; align-items: center;"> <div style="text-align: center;"> </div> <div style="text-align: center;"> </div> </div>
NOTE	<ul style="list-style-type: none"> The horizontal air flow direction changes if the i-see Sensor detects approx. 3°C temperature difference. In AUTO of AREA setting, both right and left lamps are lighted when the room is evenly air-conditioned. <div style="text-align: center;"> </div>

To release the AREA setting:

- Press the button to select "Cancel".

- When the button is pressed during AREA setting, AREA setting is released.

Indoor unit installation location and air-conditioning area

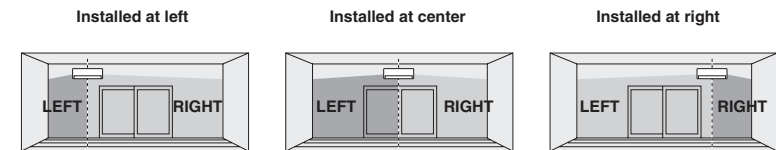

- Be sure to set the slide switch inside the remote controller to an appropriate position in accordance with the installed position of the indoor unit. If the switch is not set correctly, the air conditioner may not function properly. (Refer to page 4.)

SUPPLEMENT

		To air-condition mainly the left area of the room	To air-condition the entire room The horizontal air flow direction and indoor unit display are switched according to the room temperature (floor/wall).	To air-condition mainly the right area of the room
Remote controller button		Press to select LEFT.	Press to select AUTO.	Press to select RIGHT.
Remote controller display				
i-see Sensor operation				
Control range of horizontal air flow direction. The vertical air flow direction conforms to the setting on the remote controller. (The horizontal air flow direction is controlled in this range.)	Installed at center 			
	Installed at left 			
	Installed at right 			
Indoor unit display	AREA	AREA	AREA OR OR	AREA

AIR FLOW VELOCITY AND DIRECTION ADJUSTMENT

AIR FLOW velocity and direction can be selected as required.

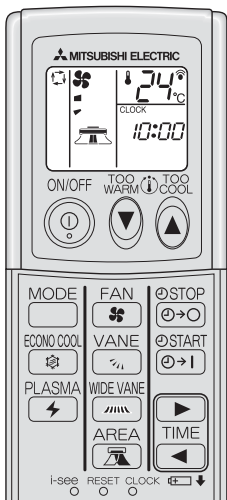

To change the AIR FLOW velocity, press the button.

Each time the button is pressed, the fan speed is changed in sequence:

- (Low) → (Med.) → (High) → (Super High) → (AUTO)
- Use the (Super High) notch to cool/heat the room more efficiently.
- If the operating sound of the air conditioner disturbs your sleep, use the (Low) notch.

To change the AIR FLOW blowing direction vertically, press the button.

Each time the button is pressed, the angle of the horizontal vane is changed in sequence: (1) → (2) → (3) → (4) → (SWING) → (AUTO)

SWING OPERATION

Use the swing operation for the air flow to reach all corners of the room.

Recommended horizontal vane range for more efficient air-conditioning

Use the (AUTO) position usually.

Use position (1) in the COOL or DRY mode and use positions (2) to (4) in the HEAT mode when adjusting to your requirements.

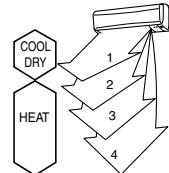

Movement of the horizontal vane







	COOL/DRY	HEAT
	<p>Horizontal position</p> <ul style="list-style-type: none"> • The vane automatically moves to horizontal position. It will not swing. <p>NOTE: Air blows out upper than position (1).</p> <ul style="list-style-type: none"> • To constantly change the air flow direction, select (SWING) with the button. 	<p>At the start of heating operation</p> <p>Horizontal position Very small air flow When air becomes warm... Position (4)</p> <ul style="list-style-type: none"> • Immediately after the air conditioner starts operating, the vane stays at horizontal position. Once the air from the indoor unit becomes sufficiently warm, the vane moves to position (4). • Once the air conditioner starts operating, the fan speed increases gradually as the air from the indoor unit gets warmer, and continues until the set speed is finally reached.
	<p>After around 0.5 to 1 hour Position (1)</p> <p>When the air flow direction is set to position (2), (3) or (4)</p> <ul style="list-style-type: none"> • After around one hour of operation, the air conditioner automatically moves the vane to position (1). To change the air flow direction to the original setting, operate the VANE button on the remote controller again. • The vane does not move to the straight-down position in the COOL and DRY mode. 	<p>At the start of heating operation</p> <p>Horizontal position Very small air flow When air becomes warm... Set position</p> <ul style="list-style-type: none"> • Immediately after the air conditioner starts operating, the vane stays at horizontal position. Once the air from the indoor unit becomes sufficiently warm, the vane moves to the position corresponding to the set direction of air flow. • Once the air conditioner starts operating, the fan speed increases gradually as the air from the indoor unit gets warmer, and continues until the set speed is finally reached.
	<ul style="list-style-type: none"> • The vane moves intermittently between positions (1) and (4). The vane stops for a brief period at positions (1) and (4). 	<ul style="list-style-type: none"> • The vane moves intermittently between positions (2) and (4). The vane stops for a brief period at positions (2) and (4).

NOTE:

- Adjust the AIR FLOW direction using the remote controller. Moving the horizontal vane and vertical vane manually can cause trouble.
- When the operation mode changes in “ (AUTO)” mode, the horizontal vane is automatically changed to the position in each mode.

AIR FLOW VELOCITY AND DIRECTION ADJUSTMENT

To change the air flow direction not to blow directly onto your body.

To change the air flow direction	When to use this function?	COOL/DRY	HEAT
Pressing and holding the  button for 2 seconds or more causes the horizontal vane to reverse and move to horizontal position.  Horizontal position	Use this function if you don't want the air from the indoor unit to blow directly onto your body. <ul style="list-style-type: none"> Depending on the shape of the room, the air may blow directly onto your body. Press the  button again to return the vane to the previously-set position. 	The air conditioner starts the cooling or drying operation approx. 3 minutes after the vane has moved to the horizontal position. <ul style="list-style-type: none"> When the  button is pressed again, the vane returns to the previously-set position and the air conditioner starts the cooling or drying operation in approx. 3 minutes. 	The air conditioner starts heating operation approx. 3 minutes after the vane has moved to the horizontal position. <ul style="list-style-type: none"> Sometimes the area around your feet may not warm. To warm the area around the feet, set the horizontal vane to  (AUTO) or the downward-blowing position. When the  button is pressed again, the vane returns to the previously-set position and the air conditioner starts heating operation in approx. 3 minutes.

NOTE:

- If you make the air flow not to blow directly onto your body by pressing  button, the compressor stops for 3 minutes even during the operation of the air conditioner.
- The air conditioner operates with decreased air flow until the compressor turns on again.

To change the AIR FLOW blowing direction horizontally, press the  button.

Each time the button is pressed, the angle of the VERTICAL VANE is changed in sequence:

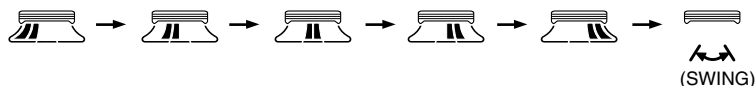

SWING OPERATION

Use the swing operation for the air flow to reach all corners of the room.

WHEN THE AIR CONDITIONER IS NOT GOING TO BE USED FOR A LONG TIME

Use the PLASMA operation when you want to remove odor (cigarette smell, etc.) or clean the air (get rid of dust, pollens or other allergens) inside the room.

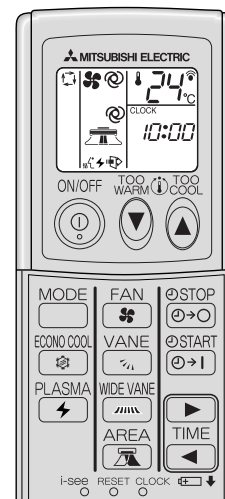

To start PLASMA operation:

Select the operation mode of PLASMA by pressing the  button during the operation of air conditioner.

Each time this button is pressed, the operation mode of PLASMA is changed in sequence:

 →  →  → Cancel (The sign of PLASMA operation disappears.)

PLASMA/WASH lamp turns on in the display section of the indoor unit and PLASMA DEODORIZING and/or PLASMA AIR PURIFYING unit is energized. Adjust the air flow to your desired speed.

To release PLASMA operation:

Select the "Cancel" by pressing the  button during the operation of the air conditioner.

Once the PLASMA operation is selected, PLASMA operation will be performed every time the air conditioner is turned on until the "Cancel" is selected with the  button.

Description of PLASMA operation:

< function >

Both PLASMA DEODORIZING and PLASMA AIR PURIFYING operation works.

< function >

The PLASMA DEODORIZING operation cleans the air inside the room by adsorbing and decomposing the particles of odor-releasing substances and gases such as formaldehyde.

< function >

The PLASMA AIR PURIFYING operation cleans the air inside the room by adsorbing the particles of cigarette smoke or allergens such as pollens and house dust.

NOTE:

- Carbon monoxide released from cigarettes cannot be removed by PLASMA operation. Open the windows to let the outside air in from time to time.
- During PLASMA operation, you may smell ozone that is generated in small quantities from the PLASMA DEODORIZING/AIR PURIFYING filter units. This is not a malfunction.
- You may hear a small "hissing" sound during PLASMA operation. This is the sound of plasma discharge, and not a malfunction.



Never touch the PLASMA DEODORIZING/AIR PURIFYING filter units during the operation of the air conditioner. Although the filter units are safety-conscious design, touching the units could be the cause of trouble as they discharge high voltage electricity.

<Cleaning>

When the PLASMA/WASH lamp blinks, please clean the PLASMA DEODORIZING/AIR PURIFYING filter units. Please refer to page 13 for the cleaning instructions.

POWER 

PLASMA/WASH 

AREA  L  R

<Replacing the PLASMA DEODORIZING filter>

* Refer to "REPLACEMENT OF THE PLASMA DEODORIZING FILTER..." on page 13.

ECONO COOL OPERATION

Use this operation when you want to be comfortable in COOL mode even with energy saved.

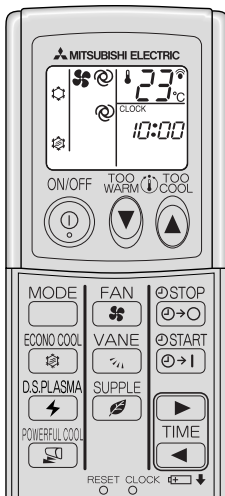

Perform the following operations while the unit is operating in the MANUAL COOL mode.

1 Press the button.

When the (ECONO COOL) operation is selected in COOL mode, the air conditioner performs swing operation vertically in various cycle according to the temperature of air conditioner.

Also SET TEMPERATURE is automatically set 2°C higher than in COOL mode.

To release the ECONO COOL operation:

1 Press the button again.

• When the button is pressed or the operation mode is changed during the ECONO COOL operation, ECONO COOL operation is released.

• The button, the or button and ON/OFF timer (explained below) are available.

What is "ECONO COOL"?

Swing air flow (change of air flow) makes you feel cooler than constant air flow. So, even though the set temperature is automatically set 2°C higher, it is possible to perform cooling operation with keeping comfort. As a result, energy can be saved.

TIMER OPERATION (ON/OFF TIMER)

It is convenient to set the timer when you go to bed, when you get home, when you get up, etc.

How to set the ON timer

1 Press the button during operation.

Each time the button is pressed, the ON timer mode alternates between ON and OFF.

2 Set the time of the timer using the TIME buttons (Forward) and (Backward).

Each time the button is pressed, the set time increases by 10 minutes; each time the button is pressed, the set time decreases by 10 minutes.

To release the ON timer:

1 Press the button.

How to set the OFF timer

1 Press the button during operation.

Each time the button is pressed, the OFF timer mode alternates between ON and OFF.

2 Set the time of the timer using the TIME buttons (Forward) and (Backward).

Each time the button is pressed, the set time increases by 10 minutes; each time the button is pressed, the set time decreases by 10 minutes.

To release the OFF timer:

1 Press the button.

Programming timer operation

The ON timer and the OFF timer can be used in combination. The timer of the set time that is reached first will operate first. ("↓" mark indicates the order of timer operations.)

• If the current time has not been set, the timer operation cannot be used.

NOTE:

If the main power is turned off or a power failure occurs while AUTO START/STOP timer is active, the timer setting is cancelled. As these models are equipped with an auto restart function, the air conditioner starts operating with timer cancelled at the same time that power is restored.

WHEN THE AIR CONDITIONER IS NOT GOING TO BE USED FOR A LONG TIME

When it is not going to be used for a long time:

1 Perform the FAN operation for 3 or 4 hours to dry the inside of the air conditioner.

• To perform FAN operation, set the remote controller to the highest temperature in the MANUAL COOL mode. (Refer to page 7.)

2 Turn off the breaker and/or disconnect the power supply plug.



CAUTION:

Turn off the breaker or disconnect the power supply plug when the air conditioner is not going to be used for a long time.

Dirt may collect and this may cause a fire.

3 Remove the batteries from the remote controller.

CAUTION:

To prevent liquid leakage, take out all batteries when the remote controller is not going to be used for a long time.

When the air conditioner is to be used again:

1 Clean the air filter and install it in the indoor unit.

(Refer to page 12 for cleaning instructions.)

2 Check that the air inlet and outlet of the indoor/outdoor units are not blocked with any obstacles.

3 Check that the earth is connected correctly.

CAUTION:

Earth the unit.

Do not connect the earth to a gas pipe, water pipe, lightning rod or the earth of a telephone. If the earthing is incorrect, it may cause an electric shock.

MAINTENANCE

Before starting maintenance

1 Turn off the breaker and/or disconnect the power supply plug.



CAUTION:

When the unit is to be cleaned, switch it off and disconnect the power supply plug or turn off the breaker. Since the fan rotates at high speed during operation, it may cause an injury.

Cleaning the indoor unit

1 Clean the unit using a soft dry cloth.

- If the dirt is noticeable, wipe the unit with a cloth soaked in a solution of mild detergent diluted in lukewarm water.
- Do not use gasoline, thinner, benzene, polishing powder, or insecticide. The unit may be damaged.
- The front panel may come off if it is lifted up past its level position. If the front panel comes off, refer to step 3 in CLEANING THE FRONT PANEL.

CLEANING THE FRONT PANEL

Front panel

- 1 Press and unlock the knobs on both sides of the front panel and lift the panel up until a “click” is heard. (1) Holding the hinges, lift the panel up until it is level, and pull the hinges forward to remove the front panel. (2)

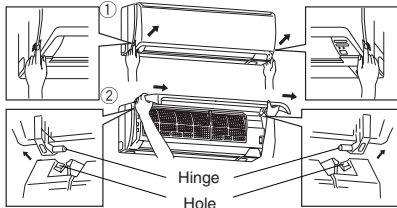

CAUTION:

- Do not drop the front panel or pull it out forcibly. The panel may be damaged.
- Do not step onto an unstable bench when removing or installing the front panel. This may cause an injury, etc. if you fall down.
- Be sure not to bend the metal bar (silver) that is visible when the front panel is open. This could cause a malfunction or an abnormal sound to be produced during operation.

- 2 Wipe the front panel with a soft dry cloth or wash it with water. After washing the panel, wipe up the remaining water with a soft dry cloth and let it dry out of direct sunlight.

- If the dirt is noticeable, wipe the front panel with a cloth soaked in a solution of mild detergent diluted in lukewarm water.
- Do not use gasoline, benzine, thinner, polishing powder, or insecticide and do not wash the front panel with a scrubbing brush or the hard surface of a sponge.
- Do not soak the front panel in water/lukewarm water longer than two hours and do not expose the panel to direct sunlight, heat, or flames when drying it. The panel may be deformed or discolored.

- 3 Hold both ends of the front panel, keep the panel level, and insert the hinges into the holes on the upper part of the indoor unit until they click into place. Then, close the front panel securely and press the 3 positions on the front panel as indicated by the arrows.

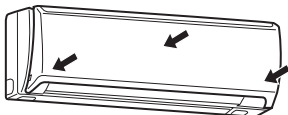

Heat exchanger

- 1 Remove the anti-mold air filter and PLASMA DEODORIZING/AIR PURIFYING filter units before cleaning the heat exchanger.

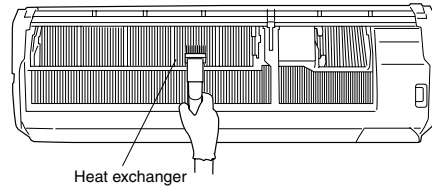

You can sweep the surface of heat exchanger if you install the brush of QUICK CLEAN KIT to your vacuum cleaner. Please refer to the instructions described in QUICK CLEAN KIT for details.

WARNING:

- Do not touch the heat exchanger directly with your hands. Otherwise you may get injured. (It's recommended to protect your hands with a pair of gloves.)

CAUTION:

- Do not step onto an unstable bench when cleaning. Otherwise you may fall down and get injured.
- Use only the brush of QUICK CLEAN KIT. Do not use other stuffs. Otherwise the heat exchanger of the indoor unit may get damaged.

Optional product

Name of part	Quick clean Kit
Parts number	MAC-093SS-E

Optional product is available from your local dealer.

NOTE:

The QUICK CLEAN KIT can only be fitted to a vacuum cleaner with a hose/tube diameter (inside diameter) of 32 to 39 mm. Refer to the instructions of the QUICK CLEAN KIT.

Fan

Refer to page 14 for cleaning the fan.

CLEANING THE D.S. PLASMA UNIT

Cleaning the anti-mold air filter (about once every 2 weeks)

- 1 Holding the knob on the anti-mold air filter, pull up the filter slightly and then pull down to remove.

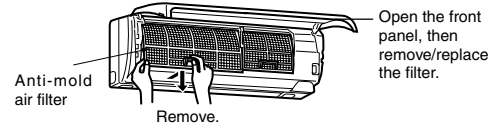

CAUTION:

When the anti-mold air filter is to be removed, do not touch the metal parts of the indoor unit. This may cause an injury.

- 2 Remove dirt from the anti-mold air filter using a vacuum cleaner or by washing the filter with water.

- Do not wash with scrubbing brush or hard surface of sponge. Otherwise, the filter may deform.
- If the dirt is noticeable, wash the filter with a solution of mild detergent diluted in lukewarm water.
- If hot water (50°C or more) is used, the filter may be deformed.

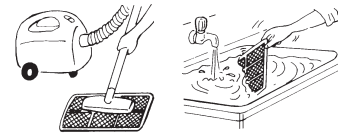

- 3 After washing with water/lukewarm water, dry the anti-mold air filter well in the shade.

- Do not expose the anti-mold air filter to direct sunlight or heat from a fire when drying it.

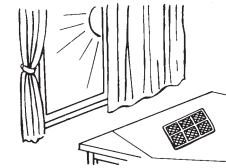

- 4 Install the anti-mold air filter. (Securely install its tabs.)

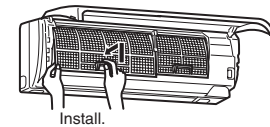

CLEANING THE PLASMA DEODORIZING/AIR PURIFYING FILTER UNITS

If the PLASMA/WASH lamp on the indoor unit blinks, clean the filters as soon as possible. The lamp will start blinking when accumulated operating time exceeds 330 hours.

Before cleaning

Switch the indoor unit off with the remote controller and disconnect the power supply plug and/or turn off the breaker. Otherwise, you may get injured since the PLASMA DEODORIZING/AIR PURIFYING filter units are charged with high voltage.



- 1 Hold the knobs on both sides of the front panel and lift the panel up until its level.

- 2 Remove the anti-mold air filter.

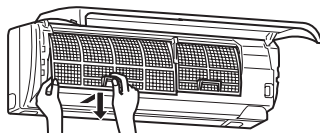

- 3 Remove the PLASMA DEODORIZING/AIR PURIFYING filter units.

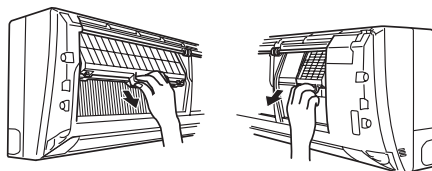

Cleaning

- 1 Vacuum the filter surface using a vacuum cleaner or wash with water, and then soak the filters in warm water of 30 to 40 C for 10 to 15 minutes. (To remove persistent stains, clean the filters with a water-diluted mild or weak alkali detergent.)



- 2 After the filter units have been soaked, shake them horizontally and vertically and then rinse under running water. Shake off excess water.

- To remove persistent soiling, such as oil and nicotine stains, repeat the above steps two to three times.

- 3 Dry the filter units by hanging them in a shaded, well-ventilated place. If the filter units are not hanged, position them according to the illustration below.

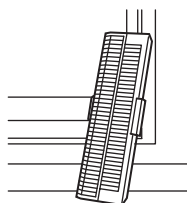

- Deodorizing ceramic filter inside the PLASMA DEODORIZING filter unit is fragile, so handle it with care. Clean the filter without removing it from the filter unit. (See the description to the right for the details of the deodorizing ceramic filter.)

NOTE:

- If the D.S. PLASMA unit is soaked in water to clean, the filter frames may turn white, but this does not affect performance or quality. Continue to use the unit.
- Do not use detergents that contain bleach.
- Do not disassemble the PLASMA DEODORIZING/AIR PURIFYING filter units.
- Do not dry the PLASMA DEODORIZING/AIR PURIFYING filter units using hot air from a hair dryer, etc. (The filter unit may deform due to heat.)
- Install the PLASMA DEODORIZING/AIR PURIFYING filter units only when they are completely dry. If the filter unit remains wet, the PLASMA/WASH lamp may blink and the PLASMA function may be disabled.

REPLACEMENT OF THE AIR CLEANING FILTER

Reinstalling

Install the PLASMA DEODORIZING/AIR PURIFYING filter units by following the removal procedure in reverse.

- 1 Insert the top of the PLASMA DEODORIZING/AIR PURIFYING filter units into the aperture in the plasma element holder.
- 2 Push in the PLASMA DEODORIZING/AIR PURIFYING filter units until they click into place.
 - The front panel does not close if the PLASMA DEODORIZING/AIR PURIFYING filter units are not installed properly.
- 3 Install the anti-mold air filter.
- 4 Connect the power supply plug and/or turn on the breaker.
- 5 Press the WASH reset switch. A short “beep” is heard and the blinks of the PLASMA/WASH lamp will be canceled. Make sure the PLASMA/WASH lamp is not blinking at the start of operation next time.
- 6 Hold both sides of the front panel and close the front panel.
- 7 Press the 3 positions on the front panel as indicated by the arrows.

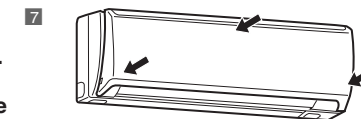
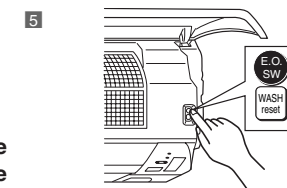
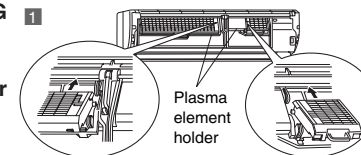

REPLACEMENT OF THE PLASMA DEODORIZING FILTER (DEODORIZING CERAMIC FILTER)

Replacing the deodorizing ceramic filter (about once every 6 years)

Deodorizing ceramic filter is installed inside the PLASMA DEODORIZING filter unit. The filter is fragile. Handle it with care.

- 1 Release the two knobs to open the filter unit.
- 2 Pull the side knobs outward and then forward to remove, as illustrated below.

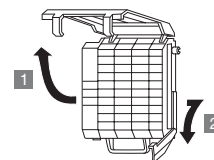

- 3 Pull out the deodorizing ceramic filter from the side of the filter unit.

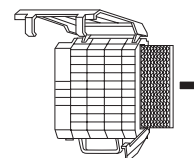

- 4 Install the deodorizing ceramic filter by following the removal procedure in reverse.

CAUTION:

- The PLASMA DEODORIZING filter unit may not operate properly if the deodorizing ceramic filter is not installed. Be sure to install the deodorizing ceramic filter.
- Dispose of the deodorizing ceramic filter according to the local regulation for waste in your area. (Main material:ceramic.)

Optional product

Name of parts	Deodorizing ceramic filter
Parts number	MAC-305FT-E

CLEANING THE AIR OUTLET AND FAN OF THE INDOOR UNIT

Before cleaning

- ⚠ Switch the indoor unit off with the remote controller and disconnect the power supply plug and/or turn off the breaker, otherwise you may get injured since the fan of the indoor unit rotates at high speed during operation.

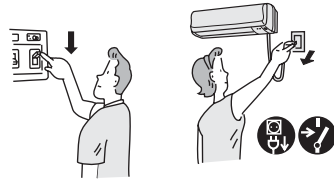

Cleaning

- 1 Hold the knobs on both sides of the front panel and lift the panel up until its level.
- 2 Holding the both ends of the horizontal vane, pull the horizontal vane towards you manually and make sure the fan has stopped.

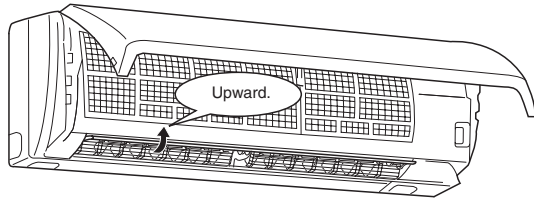

- 3 Remove the horizontal vane. Be sure to hold horizontal vane when unlocking the stoppers.

Follow the procedure ① and ② to remove the horizontal vane.

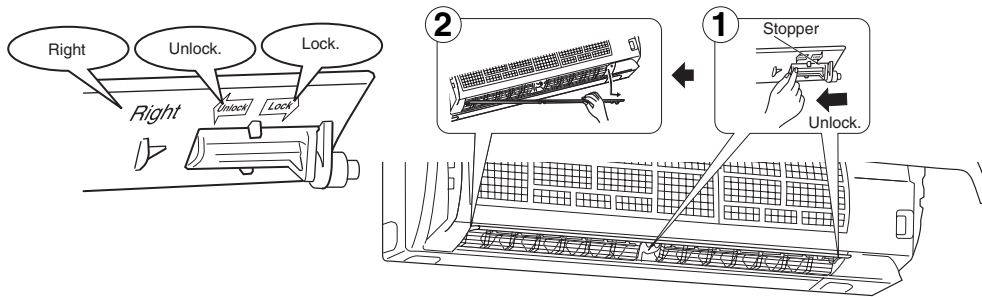

- 4 Swing the vertical vanes out one by one.

- ① Holding the unit lightly with one hand, grab the tab of each vertical vane with the other hand and pull it downward to swing out each vertical vane.

Hold the tab of each vertical vane and move the vertical vanes in the directions of the arrows. The vanes cannot be removed.

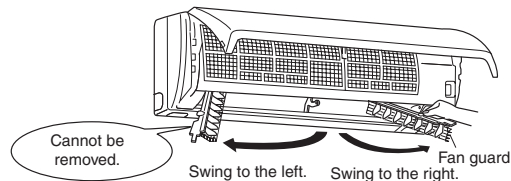
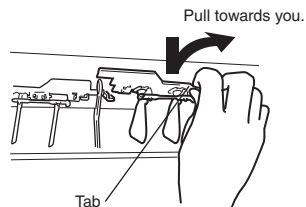

- Be sure to hold the tab to swing out the vertical vanes, otherwise the vanes can be damaged.
- Do not use excessive force to the fan guard during this procedure. The fan guard may be deformed and the vanes may not work properly.

- 5 Clean the air outlet and fan of the indoor unit. (Make sure the fan has stopped.)



- Be careful not to injure your hands.
- If the air outlet or fan is dirty, moldy, or dusty, clean with a wet or dry soft cloth or with the brush of QUICK CLEAN KIT which is installed to a vacuum cleaner. If the dirt is noticeable around the air outlet, clean with a cloth soaked in a solution of mild detergent diluted in lukewarm water.
- Please refer to the instructions described in QUICK CLEAN KIT for the details of the way to clean with the brush of QUICK CLEAN KIT.
- Do not use gasoline, benzene and polishing powder.
- Do not use excessive force to the fan. Otherwise, it may be cracked.

- 6 Put the vertical vanes back to their original positions one by one.

- ① Hold the tab of each vertical vane and insert the vertical vanes into their respective grooves.
- ② Push each vertical vane until it clicks into place.



- Be sure to hold the tabs to install the vertical vanes, otherwise the vanes can be damaged.
- Do not use excessive force to the fan guard during this procedure. The fan guard may be deformed and the vanes may not work properly.
- Put the vertical vanes back correctly to their original positions. Otherwise, condensed water may drip down from the indoor unit or the horizontal vane could malfunction.

- 7 Install the horizontal vane. (Reverse the removal procedures.)

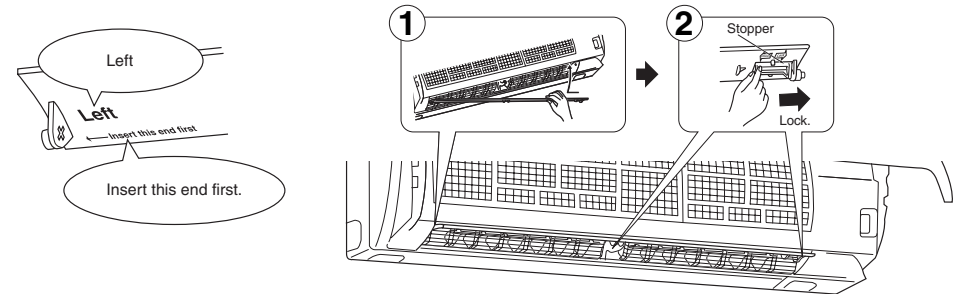

In procedure ② lock the stoppers until they click into place.

- 8 Hold both sides of the front panel and close the front panel.

- 9 Press the 3 positions on the front panel as indicated by the arrows. (Refer to page 13.)

After Cleaning

Insert the power supply plug into the power outlet and/or turn on the breaker.

Check that all LED lamps are not blinking.

If they are blinking, the horizontal vane is not installed correctly.

In this case, disconnect the power supply plug and/or turn off the breaker, and then reinstall the horizontal vane by following the procedures in step 7.

- If you operate the air conditioner after cleaning the air outlet and fan, do not get close to the air outlet as any remaining dirt may be discharged.

BEFORE CONTACTING THE SERVICE REPRESENTATIVE, CHECK THE FOLLOWING AGAIN

Question	Check points
The air conditioner cannot be operated.	<ul style="list-style-type: none"> Is the breaker turned on? Is the fuse blown? Is the ON timer set? (Page 11)
All LED lamps on the indoor unit are blinking.	<ul style="list-style-type: none"> Is the horizontal vane attached to the indoor unit correctly? (Page 14)
The horizontal vane does not move.	<ul style="list-style-type: none"> Are the horizontal vane and the vertical vane attached to the indoor unit correctly? (Page 14) Is the fan guard deformed?
The room cannot be cooled or heated sufficiently.	<ul style="list-style-type: none"> Is the temperature setting correct? (Page 7) Is the filter clean? (Page 12) Is the fan of the indoor unit clean? (Page 12) Are there any obstacles blocking the air inlet or outlet of the indoor or outdoor unit? Is a window or door open?
The air from the indoor unit smells strange.	<ul style="list-style-type: none"> Is the filter clean? (Page 12) Is the fan of the indoor unit clean? (Page 12)
The display on the remote controller does not appear or it is dim. The indoor unit does not respond to the remote control signal.	<ul style="list-style-type: none"> Are the batteries exhausted? (Page 5) Is the polarity (+, -) of the batteries correct? (Page 5) Are any buttons on the remote controller of other electric appliances being pressed?
When a power failure occurs.	<ul style="list-style-type: none"> Does the air conditioner start operating again? If the air conditioner had operated before the power failure, as these models are equipped with an auto restart function, the air conditioner should start operating again. (Refer to Description of "AUTO RESTART FUNCTION" on page 6.)

Even if the above items are checked, when the air conditioner does not recover from the trouble, stop using the air conditioner and consult your dealer.

In the following cases, stop using the air conditioner and consult your dealer.

- When water leaks or drops from the indoor unit.
- When the POWER lamp blinks.
- When the breaker trips frequently.
- The remote control signal may not be received in a room where an electronic ON/OFF type fluorescent lamp (inverter-type fluorescent lamp, etc.) is used.
- Operation of the air conditioner may interfere with radio or TV reception in areas where the reception is weak. An amplifier may be required for the affected device.
- When thunder is heard, stop operation and disconnect the power supply plug or turn off the breaker. Otherwise, the electrical parts may be damaged.

WHEN YOU THINK THAT TROUBLE HAS OCCURRED

Question	Answer (not a malfunction)
The air conditioner cannot be operated for about 3 minutes when restarted.	<ul style="list-style-type: none"> This protects the air conditioner according to instructions from the microprocessor. Please wait.
Cracking sound is heard.	<ul style="list-style-type: none"> This sound is generated by the expansion/contraction of the front panel, etc. due to change in temperature.
The air from the indoor unit smells strange.	<ul style="list-style-type: none"> The air conditioner may suck in an odor adhering to the wall, carpet, furniture, cloth, etc. and blow it out with the air. Is the PLASMA DEODORIZING filter unit clean? Clean the unit if it's dirty and replace the deodorizing ceramic filter with new one if the dirt on the filter is noticeable. During PLASMA operation, you may smell ozone that is generated in small quantities from the PLASMA DEODORIZING/AIR PURIFYING filter units. This is not a malfunction.
The fan of the outdoor unit does not rotate even though the compressor is running. Even if the fan starts to rotate, it stops soon.	<ul style="list-style-type: none"> When the outside temperature is low, the fan may not operate to maintain sufficient cooling capacity.
The sound of water flowing is heard.	<ul style="list-style-type: none"> This is the sound of refrigerant flowing inside the air conditioner. This is the sound of condensed water flowing in the heat exchanger. This is the sound of the heat exchanger defrosting.
The sound as burbling is heard.	<ul style="list-style-type: none"> This sound is heard when the outside air is absorbed from the drain hose in turning on the range hood or the ventilation fan and that makes water flowing in the drain hose spout out. This sound is also heard when the outside air blows into the drain hose in case the outside wind is strong.
The room cannot be cooled sufficiently.	<ul style="list-style-type: none"> When a ventilation fan or a gas cooker is used in a room, the cooling load increases, resulting in an insufficient cooling effect. When the outside air temperature is high, the cooling effect may not be sufficient.
Mist is discharged from the air outlet of the indoor unit.	<ul style="list-style-type: none"> The cool air from the air conditioner rapidly cools moisture in the air inside the room, and it turns into mist.
Mechanical sound is heard from the indoor unit.	<ul style="list-style-type: none"> This is the switching sound in turning on/off the fan or the compressor.

Question	Answer (not a malfunction)
The air flow direction changes during operation. The direction of the horizontal vane cannot be adjusted with the remote controller.	<ul style="list-style-type: none"> When the air conditioner is operated in COOL or DRY mode, if the operation continues with air blowing down for 1 hour, the direction of the air flow is automatically set to position (1) to prevent condensed water from dropping. In the heating operation, if the air flow temperature is too low or when defrosting is being done, the horizontal vane position is automatically set to horizontal.
Water leaks from the outdoor unit.	<ul style="list-style-type: none"> During COOL and DRY operations, pipe or pipe connecting sections are cooled and this causes water to condense. In the heating operation, the defrosting operation makes water frozen on the outdoor unit melt and drip down. In the heating operation, water condensed on the heat exchanger drips down.
White smoke is discharged from the outdoor unit.	<ul style="list-style-type: none"> In the heating operation, vapor generated by the defrosting operation looks like white smoke.
Air does not blow out soon in the heating operation.	<ul style="list-style-type: none"> Please wait as the air conditioner is preparing to blow out warm air.
The operation is stopped for about 10 minutes in the heating operation.	<ul style="list-style-type: none"> Defrosting of the outdoor unit is being done (Defrosting operation). Since this is completed in 10 minutes, please wait. (When the external temperature is too low and humidity is too high, frost is formed.)
Hissing sound is sometimes heard.	<ul style="list-style-type: none"> This is the sound when the flow of refrigerant inside the air conditioner is switched.
The room cannot be heated sufficiently.	<ul style="list-style-type: none"> When the outside air temperature is low, the heating effect may not be sufficient.
In a multi-unit system, the indoor unit which is not operating becomes warm and a sound, similar to water flowing, is heard from the unit.	<ul style="list-style-type: none"> A small amount of refrigerant continues to flow into the indoor unit even though it is not operating.
The air conditioner starts the operation only with the main power turned on, though you do not operate the unit with the remote controller.	<ul style="list-style-type: none"> These models are equipped with an auto restart function. When the main power is turned off without stopping the air conditioner with the remote controller and is turned on again, the air conditioner will start operation automatically in the same mode as the one set with the remote controller just before the shutoff of the main power.

WHEN YOU THINK THAT TROUBLE HAS OCCURRED

Question	Answer (not a malfunction)
The PLASMA/WASH lamp remains blinking after cleaning.	<ul style="list-style-type: none"> • Press the WASH reset switch inside the front panel.
The indoor unit makes a small “hissing” sound.	<ul style="list-style-type: none"> • It is the sound of plasma discharge and is not a malfunction.
The PLASMA DEODORIZING/AIR PURIFYING filter units make a “crackling” sound.	<ul style="list-style-type: none"> • Are the PLASMA DEODORIZING/AIR PURIFYING filter units clogged with dust? Clean the PLASMA DEODORIZING/AIR PURIFYING filter units. • Are the PLASMA DEODORIZING/AIR PURIFYING filter units wet? Dry the PLASMA DEODORIZING/AIR PURIFYING filter units completely.

Question	Answer (not a malfunction)
The swing operation of the VERTICAL and HORIZONTAL VANE is suspended for a while then restarted.	<ul style="list-style-type: none"> • This is for the swing operation of the VERTICAL and HORIZONTAL VANE to be performed normally.
The auto front panel makes a “clanging” sound when opened or closed.	<ul style="list-style-type: none"> • The moving part of the auto front panel makes a sound when the panel is opened or closed. This is not a malfunction.
The auto front panel does not close.	<ul style="list-style-type: none"> • Are the PLASMA DEODORIZING/AIR PURIFYING filter units installed properly? • Are the anti-mold air filters installed properly? Install them securely.

Question	Answer (not a malfunction)
The auto front panel cannot be closed manually.	<ul style="list-style-type: none"> • When the auto front panel is opened manually while the air conditioner is off, the front panel is kept in the opened position. Disconnect the power supply plug and/or turn off the breaker and then connect the plug again and/or turn on the breaker. The auto front panel fully opens once and then closes.
Water drips from the indoor unit.	<ul style="list-style-type: none"> • If the auto front panel is not fully open, condensation may form on the panel while the air conditioner is operating and drip down. If this occurs, use the remote controller to turn the air conditioner OFF and ON. The auto front panel should close and then open fully.
After the auto front panel opens completely, a low clicking sound is heard. (Approximately 13 seconds maximum)	<ul style="list-style-type: none"> • If the auto front panel is opened while the indoor unit is stopped during maintenance, etc., this sound is produced when the position of the auto front panel is determined when the indoor unit starts operating. This is not a malfunction. • If the indoor unit stops during a power failure, etc., with the auto front panel open, this sound is produced when the position of the auto front panel is determined when the indoor unit starts operating again. This is not a malfunction.

INSTALLATION, RELOCATION AND INSPECTION

Installation place

Avoid installing the air conditioner in the following places.

- Where flammable gas could leak.

⚠ CAUTION:

Do not install the unit where flammable gas could leak. If gas leaks and collects around the unit, it may cause an explosion.

- Where there is much machine oil.
- Salty places such as the seaside.
- Where sulfide gas is generated such as a hot spring.
- Where oil is splashed or where the area is filled with oily smoke.
- Where there is high-frequency or wireless equipment.

⚠ WARNING :

If the air conditioner operates but does not cool or heat (depending on model) the room, consult your dealer since there may be a refrigerant leak. Be sure to ask the service representative whether there is refrigerant leakage or not when repairs are carried out.

The refrigerant charged in the air conditioner is safe. Refrigerant normally does not leak, however, if refrigerant gas leaks indoors, and comes into contact with the fire of a fan heater, space heater, stove, etc., harmful substances will be generated.

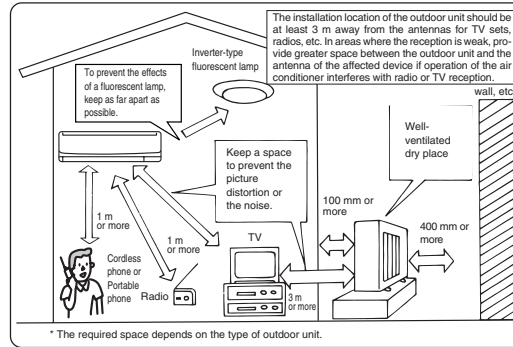

Electrical work

- Provide an exclusive circuit for the power supply of the air conditioner.
- Be sure to observe the breaker capacity.

⚠ WARNING :

- **The customer should not install this unit. If installation is done incorrectly, it may cause a fire, an electric shock, or injury from the unit falling, water leaking, etc.**
- **Do not use intermediate connection of the power supply cord or the extension cord and do not connect many devices to one AC outlet. A fire or an electric shock may result from poor contact, poor insulation, exceeding the permissible current, etc. Consult your dealer.**

Guaranteed operating range

		Indoor	Outdoor
Cooling	Upper limit	32°C DB 23°C WB	46°C DB —
	Lower limit	21°C DB 15°C WB	-10°C DB —
Heating	Upper limit	27°C DB —	24°C DB 18°C WB
	Lower limit	20°C DB —	-10°C DB -11°C WB

⚠ CAUTION:

- **Earth the unit.**

Do not connect the earth to a gas pipe, water pipe, lightning rod or the earth of a telephone. If the earthing is incorrect, it may cause an electric shock.

- **Install an earth leakage breaker depending on the place where the air conditioner is to be installed (humid places, etc.).**
- If the earth leakage breaker is not installed, it may cause an electric shock.**

Inspection and maintenance

- When the air conditioner is used for several seasons, the capacity may be lowered due to dirt inside the unit.
- Depending on the condition, an odor may be generated or dehumidified water may not drain out smoothly due to dirt, dust, etc.
- It is recommended that the unit be inspected and maintained (charged) by specialist in addition to normal maintenance. Consult your dealer.

Operating sound considerations

- Do not put an object around the air outlet of the outdoor unit. This may lower the capacity or increase the volume of the operating sound.
- If an abnormal sound is heard during operation, consult your dealer.

Relocation

- When the air conditioner is to be removed or re-installed because of rebuilding, moving, etc., special techniques and work are required.

⚠ WARNING :

Repairs or relocation should not be done by the customer.

If this is done incorrectly, it may cause a fire, an electric shock, or an injury from the unit falling, water leaking, etc. Consult your dealer.

Disposal

To dispose of this product, consult your dealer.

If you have any questions, consult your dealer.

