

Operating Instructions for Compact Disinfector G 7783 CD MIELABOR Laboratory Glasswasher

It is **essential** to read these Operating Instructions before installing or using the machine, to avoid the risk of accident, or damage to the machine.



M.-Nr. 04 195 811

Contents

Guide to the machine	3
Warning and safety instructions	5
Warning and safety instructions (detachable)	Centre pages
Description of the machine	9
Setting the water softener	10
Opening and closing the door	12
Applications and loading	13
Rinsing agent	17
Setting the dosage	17
Adding neutralising agent and (liquid) detergent	18
Venting the liquid dispensing system / Maintenance	19
Adding powder detergent	20
Programme selection	21
Programme chart	22
Switching the machine on and off	24
Selecting a programme	24
Selecting an additional programme	24
Programme sequence indicator	26
Interrupting a programme	26
Programming special functions	28
Reactivating the water softener	29
Cleaning and care	31
Drying unit (TA) cleaning and care	33
Changing the Coarse Filter	33
Exchanging the S-class particle filter	33
Correcting minor faults	34
Installation	35
Electrical connection	37
Plumbing	39
Caring for the environment	42
Technical Data	43

Guide to the machine

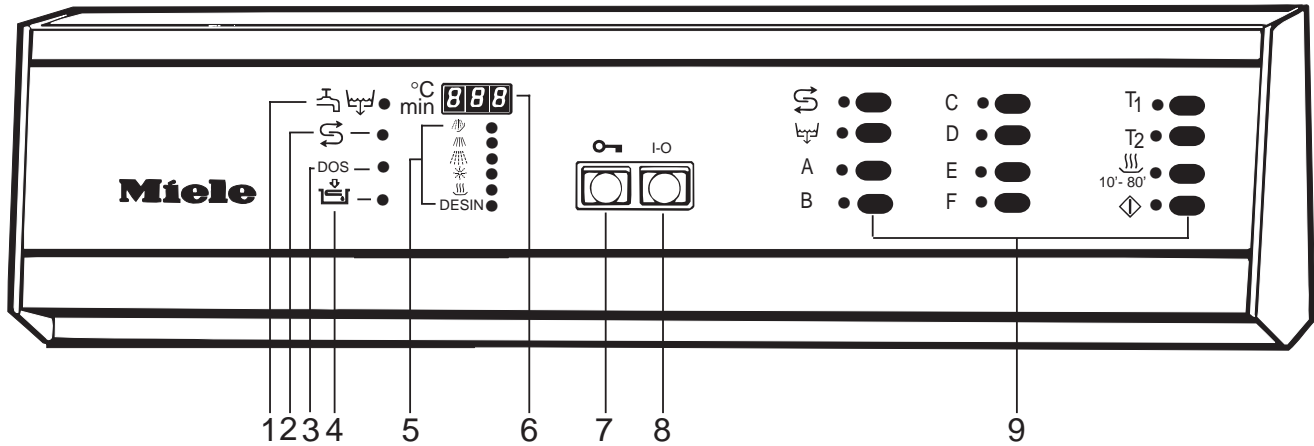

- | | |
|--|--------------------------------|
| 1 "Check water inlet/outlet" check light | 5 Programme sequence indicator |
| 2 "Reactivate softener" indicator light | 6 Display |
| 3 Add (liquid) detergent indicator light | 7 Door release |
| 4 "Add neutralising agent" indicator light | 8 ON-OFF Button (I-O) |
| | 9 Programme touch controls |

Guide to the machine

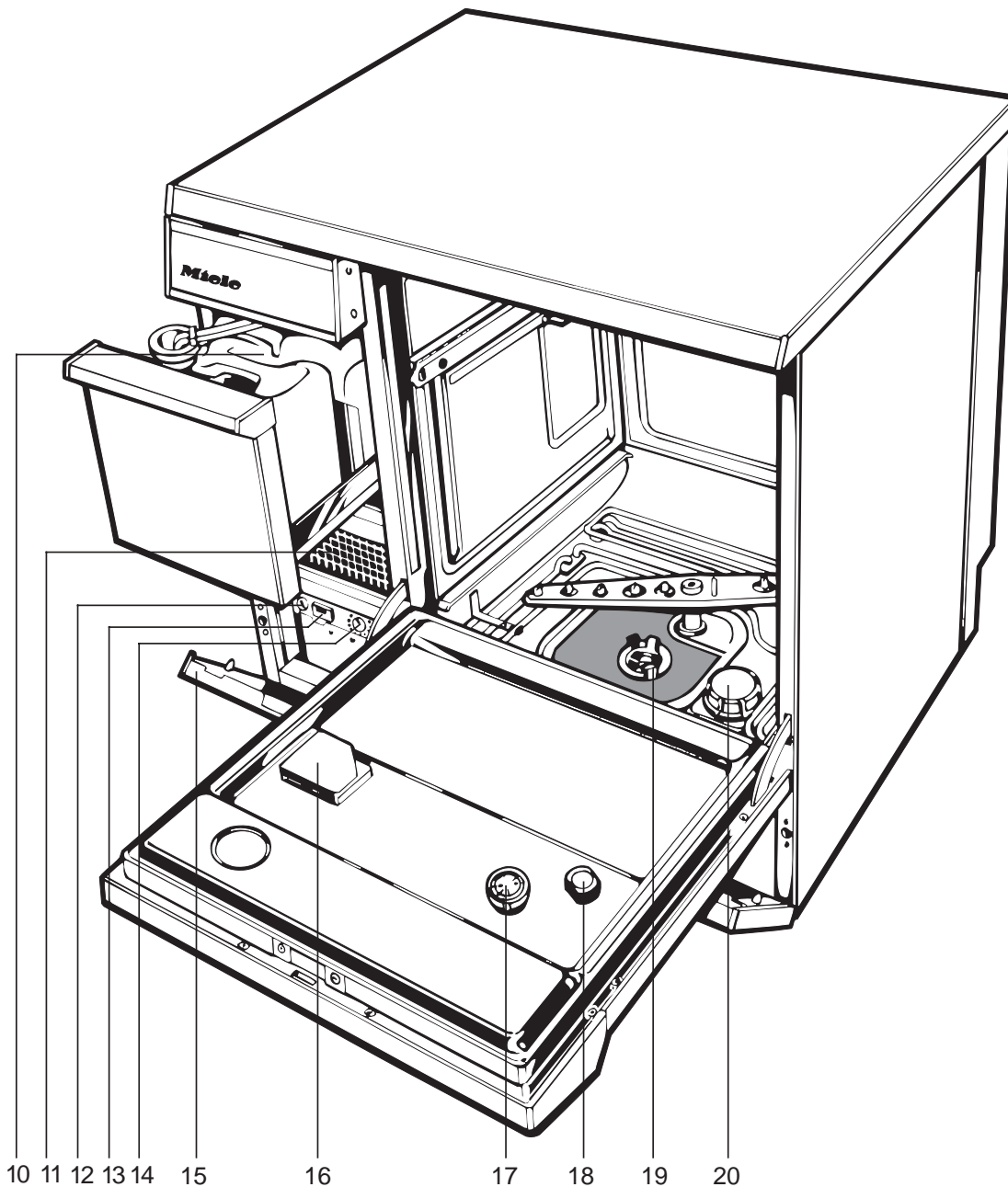

- | | |
|--|---|
| 10 Dispenser for neutralising agent (DOS 10 - red) and <u>liquid</u> detergent (DOS 60 - blue) | 15 Service panel |
| 11 Drying unit (TA) | 16 Dispenser for powder detergent |
| 12 Safety fuse for TA Drying Unit | 17 Dispenser for <u>liquid</u> rinsing agent with dosage selector |
| 13 Time counter for TA Drying Unit | 18 Level indicator |
| 14 Temperature selector for TA Drying Unit | 19 Filter combination |
| | 20 Connection socket for salt container (water softener) |

Warning and safety instructions

This machine conforms to current safety requirements. Inappropriate use can however lead to personal injury and damage to property. Read the operating instructions carefully before starting to use this machine. This way you will avoid the risk of accidents, and damage to the machine. Keep these instructions in a safe place, and make them available to future users.

Correct usage

■ This machine is designed for commercial use and for specialised applications only, as described in these Operating Instructions. Using it for purposes other than those for which it was designed would be unauthorised and could cause harm.

The manufacturer cannot be held responsible for damage caused by improper use.

Please pay attention to the following notes, to maintain safe procedures.

■ The machine should be commissioned and then maintained only by the Miele Service Department, an authorised Miele Service Dealer or other approved competent person.

■ Do not install the machine in an area where a danger of explosion may be present.

■ The electrical safety of this machine can only be guaranteed if connected to a correctly installed earthing system on site. It is most important that this basic safety requirement is met and complies with local and national regulations. It should be checked by an expert if necessary. The manufacturer cannot be held responsible for damage caused by missing or defective earthing, such as electric shock.

■ A damaged machine is dangerous. Switch off at the mains immediately and call an authorised Miele service dealer, or suitably competent engineer.

■ Repair work may only be carried out by an authorised, suitably competent person. Repairs by unqualified persons could be dangerous.

■ Personnel operating the machine should be trained regularly. Children and untrained personnel should not be allowed access to the machine or its controls.

Warning and safety instructions

Take care when handling liquids such as detergents, wetting agents, or neutralising agents. These may contain irritant or corrosive ingredients, acids or alkalis. On no account use any organic solvent, as there may be the danger of an explosion occurring.

Follow the instructions and relevant safety procedures carefully. Wear protective gloves and goggles.

Avoid inhalation of powder cleaners. They can cause burning in the mouth and throat if swallowed, or inhibit breathing.

The water in the machine must not be used as drinking water.

Do not sit or lean on the open door, or rest objects on it. This could cause the machine to tip and be damaged.

Be careful when sorting items with sharp pointed ends and positioning them in the machine that you do not hurt yourself or create danger for other operators.

When using this machine in the temperature ranges from 70 to 95°C be especially careful not to scald or burn yourself. Baskets and inserts must first cool down. Any water which may remain in containers will be very hot and must be emptied into the wash cabinet.

After drying with the TA drying unit then open the door to allow the items and inserts to cool down.

Do not touch the heating elements during or directly after the end of a programme, you could burn yourself.

Never use an ordinary or a high pressure hose on or in the vicinity of the machine.

Before any maintenance or repair work is undertaken, the machine must be disconnected from the mains supply, by switching off at the mains isolator, or withdrawing the mains fuse.

The following points should be observed to avoid damage to the machine and the loads being cleaned.

The standard of disinfection in the Disinfection programmes must be confirmed by the user as a routine matter. The process should be regularly checked using chemical indicators, and bacteriologically at intervals using bio-indicators, with full documentation. Proceed according to local health authority regulations.

Disinfection programmes must not be interrupted, as this can have a limiting effect on the disinfection result. However, should an interruption be necessary, the complete programme must be repeated.

Only use cleaning agents formulated for special processes and approved by Miele for use with this machine. Use of unsuitable cleaning agents could adversely affect the load or the machine.

Warning and safety instructions

■ For pre-treatment and / or cleaning only use low-foaming detergents and disinfecting agents which have been approved by Miele. Foam can have an adverse effect on the disinfection and cleaning process.

■ Where a chemical additive is recommended on technical application grounds (for example with a cleaning agent), this does not imply that the manufacturer of the machine takes responsibility for the effect of the chemical on the material of the items being cleaned. Please be aware that changes in formulation, storage conditions etc, which may not be publicised by the chemical producer, can have a negative effect on the cleaning result.

■ When using cleaning agents and specialised products it is essential that the manufacturer's instructions are followed. Only use the product for the application described by the manufacturer, to avoid any material damage or the occurrence of strong chemical reactions such as oxyhydrogen.

■ The machine is designed only for operation with water and additive cleaning agents. Organic solvents must not be used in the machine, as there is the danger under certain circumstances of explosion. Although this is not the case with all organic solvents, other problems could arise with their use, for example damage to rubber and synthetic materials.

■ In critical applications where very stringent requirements have to be met, it is strongly recommended that all the relevant factors for the process, such as cleaning agent, quality of water are discussed with the Miele Application Technology specialists.

If the cleaning result is subject to these particularly stringent requirements (e.g. chemical analysis, specialised processes), a regular quality control test should be carried out by the user to ensure that required standards of cleanliness are being achieved.

■ Please follow the advice on installation in these instructions and the separate Installation Instructions.

■ Empty any containers or utensils before arranging them in the machine.

■ Do not allow any remains of acids or solvents, or chloride solutions to get into the wash cabinet. Similarly avoid any materials with a corrosive effect.

The presence in compounds of any solvents should be minimal, (especially those in hazard class A1).

■ Ensure that solutions or steam containing acid salts do not come into contact with the steel outer casing of the machine, to avoid any corrosion damage.

Warning and safety instructions

Accessories

- Use special inserts in accordance with the instructions provided.
- The only accessories to be used with the special commercial machine must be those supplied or approved by MIELE for the specific application. Consult your dealer or the Miele Professional department for advice.

The manufacturer cannot be held responsible for any damage caused through non-observance of these Warning and Safety instructions.

Disposal of an old machine

■ When disposing of an old machine first make it unusable. Disconnect, cut off the cable and any plug from the cable. For environmental and safety reasons ensure the machine is completely drained of any residue water and cleaning agent. (Observe safety regulations and wear safety goggles and gloves). Make the door lock inoperative, so that children cannot accidentally shut themselves in. The simplest way to do this is to remove the locking pin (2 philips screws above the door). Make appropriate arrangements for the safe disposal of the machine. For tank system machines ensure that any water is emptied out of the tank.

■ In countries where there are areas which may be subject to infestation by cockroaches or other vermin, pay particular attention to keeping the machine and its surroundings in a clean condition at all times. Any damage which may be caused by cockroaches or other vermin will not be covered by the machine guarantee.

Description of the machine

The G 7783 CD is a front-loading automatic machine for the efficient washing - neutralising - rinsing - final rinsing of laboratory glassware. It can be operated on normal water supply. There are "AD" (aqua destillata) programmes with final rinses using purified water (distilled, R.O., or de-ionised).

On completion of the automatic programme sequence, laboratory glassware is cleaned to the standard required for analysis.

The electronic control unit offers a choice of temperatures for the cleaning and final rinsing phases. A combination often preferred is cleaning - T₁ 85° C and final rinse T₂ 70 °C.

With the SPECIAL "B" programme the machine can thermally disinfect at 90°C with relevant holding times.

"Instrument disinfection in automatic machines" is to be found under subsection 3.2.4. of paragraph 10c of BSeuchG, according to the German Federal Health Authority, Berlin (BGA). The disinfection parameters of between 90°C and 93°C held for 10 minutes apply to the effective areas A + B. Reduction factor 7 (by reduction factor $\sim 10^7$).

The effective areas are defined as follows:

A = Suitable for destruction of vegetative bacteria, including myco-bacteria and fungus and fungal spores.

B = Suitable for inactivation of viruses Including HBV and HIV).

The SPECIAL "B" programme operates at 90°C with 10 minutes holding time.

This machine is fitted with a TA drying unit and water softener as standard.

Available at extra cost:

- Machine lid

Setting the water softener

To avoid the build-up of calcium deposits on glassware and in the machine the water needs to be softened, where the supply hardness exceeds 107 ppm, (6°d).

To ensure a steady supply of soft water the water softener unit must always be:

1. correctly set
2. reactivated with "dishwasher" salt as soon as the  indicator light comes on.

The water softener must be set to correspond with the water hardness the first time the machine is used.

Your local water authority will advise you on the water hardness in your area.





Setting the WaterSoftener

The hardness range is divided into 18 "time" units and a zero position. The machine is set at the factory, corresponding to 339 ppm, (19°d).

If your water supply is harder or softer than this, then:

Use the touch pads on the control panel to change the time setting (see Table).

Time unit	°d	mmol/l	°f	°e	ppm CaCO ₃
18	6	1.07	10.7	7.5	107
17	7	1.25	12.5	8.8	125
16	8	1.42	14.3	10.0	143
15	9	1.60	16.0	11.3	160
14	10	1.78	17.9	12.5	179
13	11	1.96	19.6	13.8	196
12	12	2.14	21.4	15.0	214
11	13	2.31	23.2	16.3	232
10	15	2.67	26.8	18.8	268
9	17	3.03	30.4	21.3	304
8	19	3.38	33.9	23.8	339
7	22	3.92	39.3	27.5	393
6	24	4.27	42.8	30.0	428
5	28	4.98	50.0	35.0	500
4	32	5.70	57.1	40.0	571
3	38	6.76	67.8	47.6	678
2	48	8.54	85.7	60.1	857
1	71	12.64	126.7	88.9	1267
0					

- Press **T₁** and  touch pads simultaneously and, whilst depressed, switch the machine on, using the main switch "I-0".
- "P..." will appear in the display field (to indicate current programming status).
- Press touch pad . The "P" will disappear and setting "0" will appear in the display field. This setting "0" can now be changed if necessary. To do this:
 - Press touch pad  as many times as is necessary for the desired value to appear in the display field.
 - Press touch pad . "SP" appears.
 - Press  once more. The setting will now be stored. The display field clears.
- The machine is now ready for operation.

Setting the water softener

If the water hardness in your area is permanently below 107 ppm (6°d):

- Select setting "0". The control light  will not come on and the water softener does not need to be re-generated.

Reactivating the water softener, see page 29.

Opening and closing the door

To open the door

- Press the release catch as far as it will go and, at the same time, grasp the door grip and open the door.

The door should only be opened during operation for emergencies: e.g. if articles are knocking together (see interrupting a programme).

To close the door

- Lift the door upwards and push until it clicks into position. Do not press the release catch.

This laboratory glasswasher normally requires a top and a bottom basket.

Depending on the type and shape of the glassware, inserts can be supplied and there is a range of other baskets for special applications. The diversity of the inserts is so great that it is not possible to illustrate them all or give detailed instructions on their use here. As an example there are inserts for direct injection spraying of volumetric flasks, butyrometers, pipettes etc.

General glassware used in laboratories, e.g. beakers, conical flasks, test tubes, etc., can be arranged in full-size, half or quarter inserts in top or bottom baskets. Your Miele laboratory dealer will advise on specific requirements.

The following instructions relate only to basic preparation and loading of glassware.

Loading the machine

Removing excess soils

- Empty all glassware before loading into the machine. Take any hygiene measures necessary against infection.

Ensure that no acid or solvent residues, especially hydrochloric acid or chlorides get into the wash cabinet.

- Remove all agar residues from petri dishes.
- Remove blood clots and residues from test tubes, etc.
- Remove all stoppers, corks, labels, sealing wax residues, etc.

Notes

- Load the glassware so that water will come into contact with all surfaces. This ensures that they will be properly cleaned.
- Do not place items to be cleaned inside other pieces where they may be concealed.
- Hollow vessels such as beakers, measuring cylinders, flasks, etc. should be inverted and placed in the correct inserts. A cover net can be used to reduce the risk of movement during the wash process.
- Petri dishes and similar should be placed in the correct insert with the soiled side facing the centre.
- Pipettes should be placed with the mouthpiece facing upwards.
- Deep based items should be placed at enough of an angle for water to run off them freely.
- Tall, narrow, hollow pieces should be placed in the centre of the basket to ensure good coverage of water.
- Do not cover the funnel in the middle of the top basket. Mobile injector units or baskets with an adapter must engage correctly, (see below).

Applications and loading

- The spray arms must not be blocked by items which are too tall for the basket or which hang down. Rotate the arms manually to test.

Important

Make sure that the spring adapter for water connection engages correctly when a basket, injector or mobile unit is inserted into the machine. It must be 4 - 5 mm higher than the water connection inlet in the roof of the cabinet. If it is not, adjust the adapter accordingly.

- Loosen the lock ring.
- Push up the adapter (4-5 mm higher than the water connection inlet) and tighten the lock ring.

Select baskets and inserts which are appropriate for the application.

Loading example:

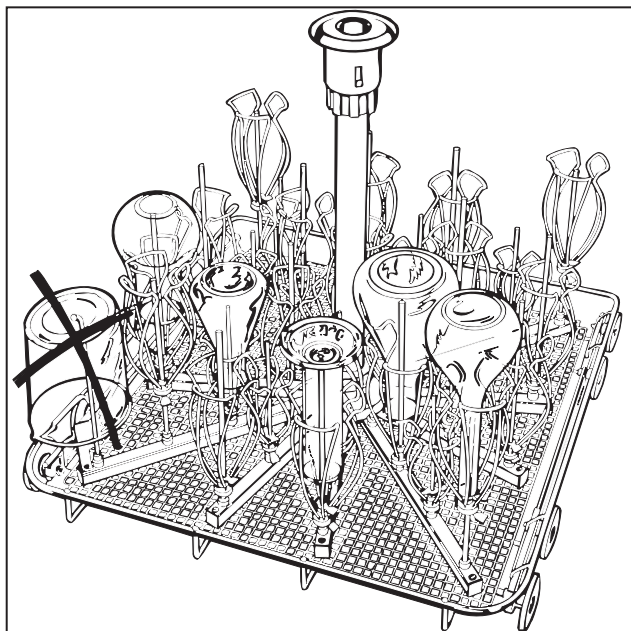

E 380 "Intermiel" Injector mobile unit (with TA connection)

For narrow necked glassware, complete with 15 nozzles 4x1 mm/160 mm high, 18 nozzles 6x1 mm/220 mm high with 33 "Mielava" clips.

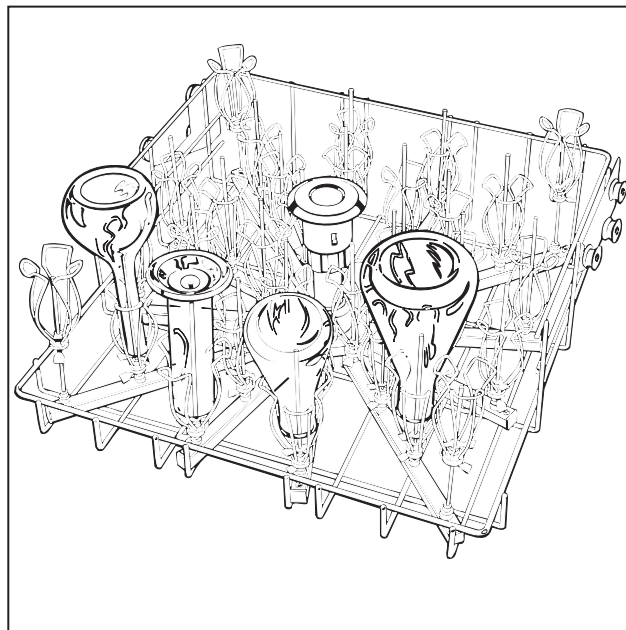

O 175 Injector mobile unit (with (TA) Drying unit connection)

(top basket) for direct injection of narrow necked glassware, 34 nozzles 4x1 mm/ 160 mm high with "Mielava" clips.

Please note:

powder detergent can only be placed in the inner side of the door when using the O 175 unit .

Applications and loading

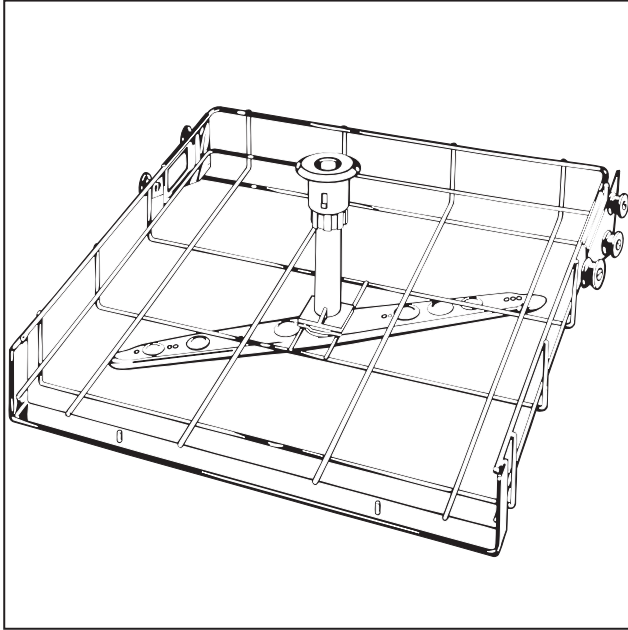

O 188 top basket frame
can take various inserts.

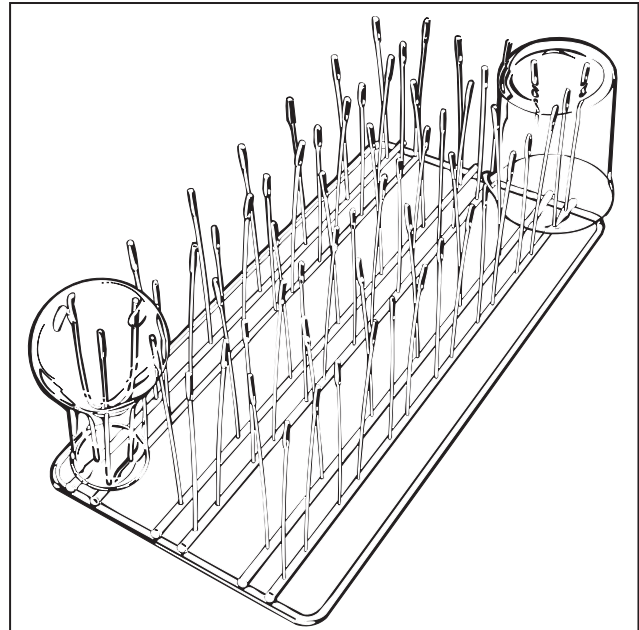

E 109
Half insert, stainless steel, with 21 glass beakers up to 250 cm³, round and conical flasks etc.

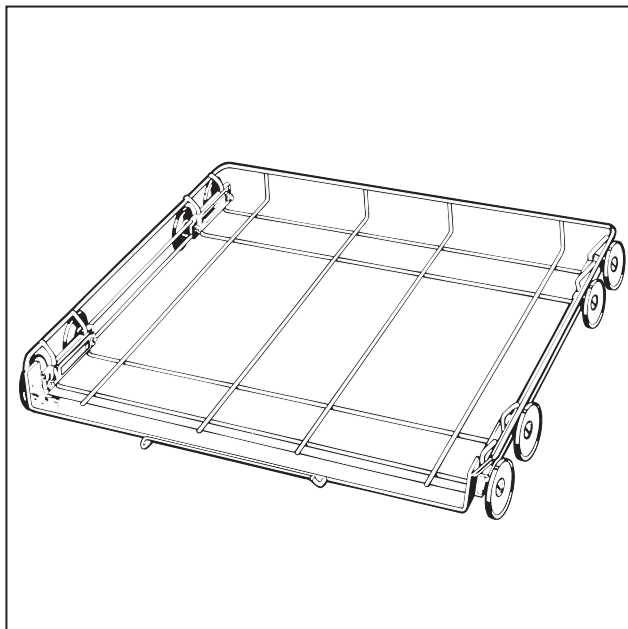

U 174 bottom basket frame
can take various inserts.

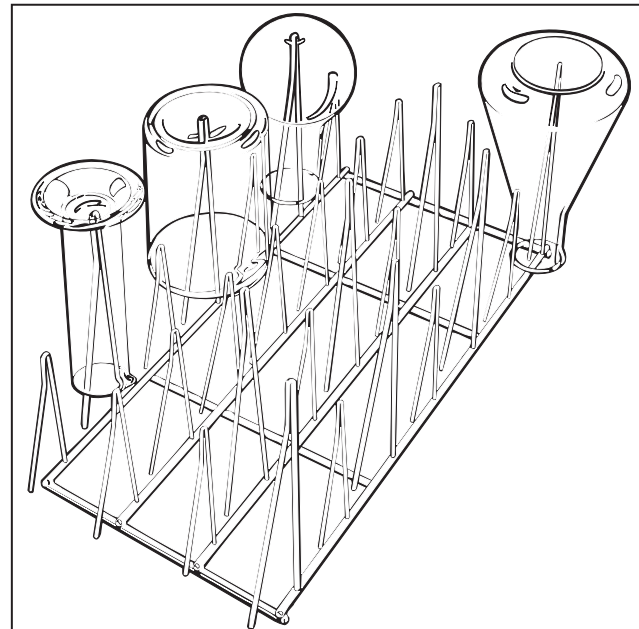

E 106
Half insert, stainless steel, with 28 spring hooks at two heights for glassware, such as narrow necked bottles, measuring cylinders, medicine bottles etc.

Applications and loading

Adjusting the top basket

Adjustable top baskets can be used in this machine, They can be adjusted up or down by 2 cm from the middle position set on delivery.

The top basket will accommodate:

- Vessels and glassware up to 19 cm in height.

The bottom basket will accommodate:

- Vessels and glasses up to 25 cm in height.

Top basket position	Top basket height (cm)	Bottom basket height (cm)
Top	17	27
Middle	19	25
Bottom	21	23

To adjust the top basket

- Pull out the top basket until a resistance is felt, lift from the runners and remove.
- Unscrew the roller supports on both sides of the basket with a 7 mm spanner, reposition as required and re-tighten.

A liquid storage container incorporated in the door has a capacity of approximately 200 ml. The required amount of appropriate liquid rinsing agent (e.g. Mielclear, in those countries where available), is dispensed automatically from this container.

Adding Rinsing agent

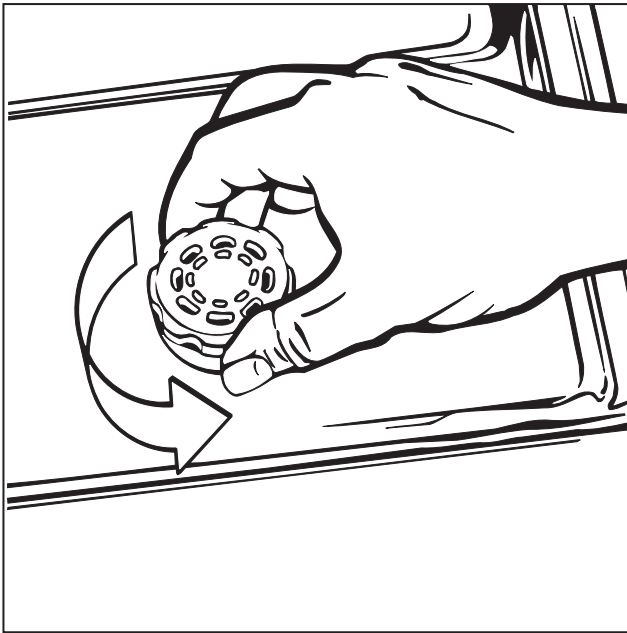

- Undo the screw cap.

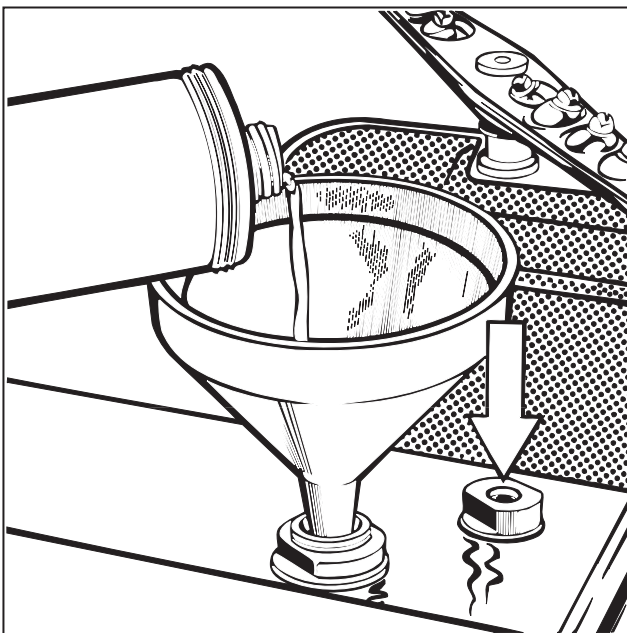

- Pour rinsing agent into the storage container until the level indicator is dark (see arrow in illustration). Use a funnel if necessary.
- Firmly tighten the screw cap. Clean up any spillage.

Refilling with rinsing agent

The level indicator shows how much rinsing agent is left in the container. When there is no dark colouring visible in the level indicator, the container needs to be refilled.

Setting the dosage

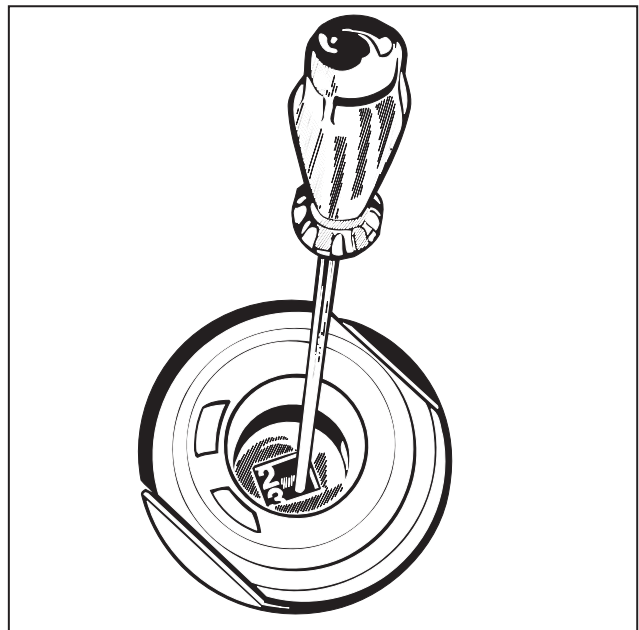

The dosage adjuster in the opening has settings from 1-6 (1-6 ml). It is set to "3" (3 ml) at the factory.

- Use a higher setting if spots are left after drying.
- If smearing appears, use a lower setting.

Adding neutralising agent and (liquid) detergent

Adding neutralising agent

To reduce the pH to neutral after alkaline cleaning, special neutralising acids can be used in programme stage 4.

Important "Special functions" must first be used to set the programme to dispense neutralising agent in stage 4, instead of rinsing agent.

When the  indicator light on the control panel lights up:

- Fill the container DOS 10 (red markings) with neutralising agent, or change containers, and then:



- Place the siphon tube firmly in the opening of the free-standing container (pay attention to colour coding).

Re-fill the container in good time, it should never be allowed to empty completely.

Adding detergents

Detergent can be added in either liquid or powder form (for powder detergent, see relevant section, p. 18)

When the indicator light "DOS" on the control panel lights up:

- Fill the container DOS 60 (blue markings) with liquid detergent, or change containers, and then:
- Place the siphon tube firmly in the opening of the free-standing container (pay attention to colour coding).

Re-fill the container in good time, it should never be allowed to empty completely.

Note: If adding an extra dose of detergent in the pre-wash of programmes **E** and **F** (see "Programme chart"), only powder detergent can be used.

Venting the liquid dispensing system / Maintenance

Venting the liquid dispensing system

Before using the machine for the first time, or if the container had not been filled in time and allowed to empty, the dispensing system for liquid agents (apart from rinsing agent) must be vented.

Proceed as follows:

- Press the I-0 (ON-Off) button.

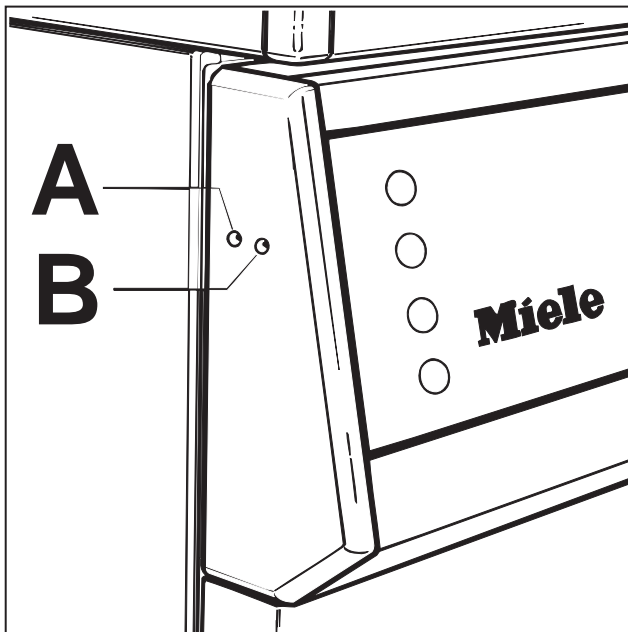

Switch "A":

Dispensing system for neutralising agent.

Switch "B":

Dispensing system for detergent (if using liquid detergent).

- Use a pointed object to press in switch "A" and/or "B" at the left hand side end of the control panel for three and a half minutes.

Each time the system is vented any liquid which runs into the wash cabinet must be washed out as follows:

- Select programme "A" (Cold).

After this has run the dispensing system is filled and ready for use.

Checking the dispensing system

To maintain the performance of the dispensing system, it should be serviced at regular intervals.

This work should only be carried out by suitably qualified people or by a MIELE Service Engineer.

Every 12-18 months

- Replace the dispensing hoses in either the dispensing systems or the DOS modules.

Adding powder detergent

Only use specific detergents for special cleaning applications. Do not use domestic dishwasher detergents.

If not using liquid, fill dispenser in the door with powder detergent before each programme (See "Programme 'B' and..." for exceptions).

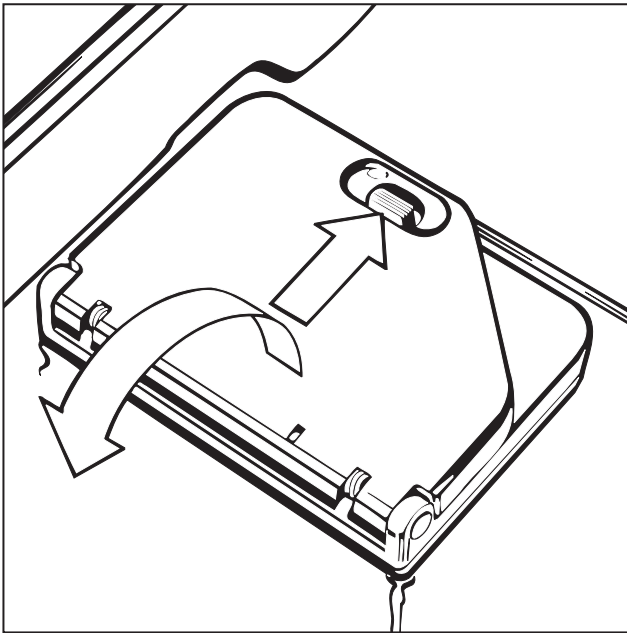

- Press the opening catch on the container flap forwards (see arrow). The flap will spring open. (The flap will be open at the end of a programme).

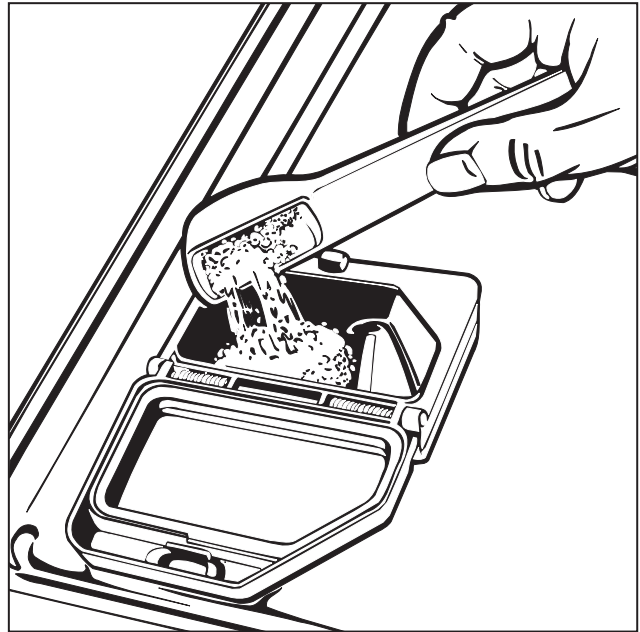

- Fill the dispenser with the appropriate amount.

Dosage: approximately 3 g/l, corresponding to approximately 30 g per load.

Follow manufacturer's instructions.

- Close the dispenser lid.

Programme "B", and when using O-175 or a pipette plate

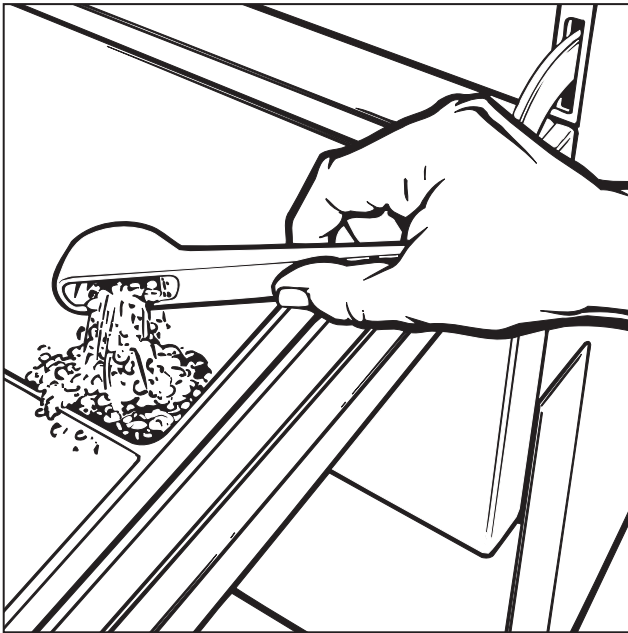

- Add powder detergent directly to the inside of the door or dispense liquid detergent via DOS 60.

An additional dose of powder detergent can be added to the inside of the door where required in applications **E** and **F** (see Programme chart).

When selecting a cleaning agent please bear in mind the ecological effects, in particular the following considerations:

- How much alkalinity is needed to do the required cleaning?
- Is bleach required for disinfection or stain removal?
- Are tensides at all necessary for dispersal or emulsification?

- The thermal disinfection programme requires the use of a suitable mildly alkaline or active chlorine-free cleaner.

Under certain circumstances, i.e. special soiling, different combinations of detergents and other additives may be necessary. Consult your Miele laboratory dealer.

Take care when handling liquids such as detergents, disinfecting and neutralising agents. These may contain acids, alkalis or disinfectants. Follow the relevant safety procedures and the instructions on the packaging carefully. Wear protective gloves and goggles if necessary.

Programme selection

Choose your programme according to the type of glassware and the degree of soiling.

The different programmes and their applications are described overleaf in the "**Programme chart**".

Programme chart

Programme	When to use	Detergent (when not using liquid detergent)
		follow manufacturer's instructions
A = COLD	For the quick removal of chemicals which cause problems for washing technology or can damage the machine.	
B = SPECIAL	Thermal disinfection to BGA standard. Cleaing of particularly stubborn soil.	30 grammes <u>on to the right hand side door interior</u>
C = MINI	For lightly soiled items without AD rinsing.	30 grammes in the powder dispenser
D = STANDARD	A wash programme with two AD rinses, where the items are intended for analytical use.	30 grammes in the powder dispenser
E = UNIVERSAL	Programme with two AD rinses for items, intended for analytical use, which are more heavily soiled with for example oil and grease residues. (Connect the cold water inlet to hot water if residues to be dispersed are oil based).	30 grammes in the powder dispenser (and also 30 grammes on the right hand side door interior if needed)
F = INTENSIVE-PLUS	For particularly encrusted residues (agar etc.).	30 grammes in the powder dispenser (and also 30 grammes on the right hand side door interior if needed)

Instructions for the operator:

- Remove these pages and ensure that they are fixed in a position clearly visible to the system operator in direct proximity to the installation site.
- Instruct and encourage operating personnel to heed the warning and safety instructions.

This machine conforms to current safety requirements. Inappropriate use can however lead to personal injury and damage to property. Read the operating instructions carefully before starting to use this machine. This way you will avoid the risk of accidents, and damage to the machine. Keep these instructions in a safe place, and make them available to future users.

Correct usage

■ This machine is designed for commercial use and for specialised applications only, as described in these Operating Instructions. Using it for purposes other than those for which it was designed would be unauthorised and could cause harm.

The manufacturer cannot be held responsible for damage caused by improper use.

Please pay attention to the following notes, to maintain safe procedures.

■ The machine should be commissioned and then maintained only by the Miele Service Department, an authorised Miele Service Dealer or other approved competent person.

■ Do not install the machine in an area where a danger of explosion may be present.

■ The electrical safety of this machine can only be guaranteed if connected to a correctly installed earthing system on site. It is most important that this basic safety requirement is met and complies with local and national regulations. It should be checked by an expert if necessary.

The manufacturer cannot be held responsible for damage caused by missing or defective earthing, such as electric shock.

■ A damaged machine is dangerous. Switch off at the mains immediately and call an authorised Miele service dealer, or suitably competent engineer.

■ Repair work may only be carried out by an authorised, suitably competent person. Repairs by unqualified persons could be dangerous.

■ Personnel operating the machine should be trained regularly. Children and untrained personnel should not be allowed access to the machine or its controls.

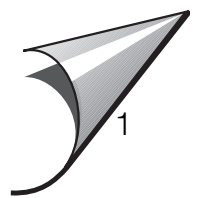

Warning and safety instructions

Take care when handling liquids such as detergents, wetting agents, or neutralising agents. These may contain irritant or corrosive ingredients, acids or alkalis. On no account use any organic solvent, as there may be the danger of an explosion occurring.

Follow the instructions and relevant safety procedures carefully. Wear protective gloves and goggles.

Avoid inhalation of powder cleaners. They can cause burning in the mouth and throat if swallowed, or inhibit breathing.

The water in the machine must not be used as drinking water.

Do not sit or lean on the open door, or rest objects on it. This could cause the machine to tip and be damaged.

Be careful when sorting items with sharp pointed ends and positioning them in the machine that you do not hurt yourself or create danger for other operators.

When using this machine in the temperature ranges from 70 to 95°C be especially careful not to scald or burn yourself. Baskets and inserts must first cool down. Any water which may remain in containers will be very hot and must be emptied into the wash cabinet.

After drying with the TA drying unit then open the door to allow the items and inserts to cool down.

Do not touch the heating elements during or directly after the end of a programme, you could burn yourself.

Never use an ordinary or a high pressure hose on or in the vicinity of the machine.

Before any maintenance or repair work is undertaken, the machine must be disconnected from the mains supply, by switching off at the mains isolator, or withdrawing the mains fuse.

The following points should be observed to avoid damage to the machine and the loads being cleaned.

The standard of disinfection in the Disinfection programmes must be confirmed by the user as a routine matter. The process should be regularly checked using chemical indicators, and bacteriologically at intervals using bio-indicators, with full documentation. Proceed according to local health authority regulations.

Disinfection programmes must not be interrupted, as this can have a limiting effect on the disinfection result. However, should an interruption be necessary, the complete programme must be repeated.

Only use cleaning agents formulated for special processes and approved by Miele for use with this machine. Use of unsuitable cleaning agents could adversely affect the load or the machine.

Warning and safety instructions

■ For pre-treatment and / or cleaning only use low-foaming detergents and disinfecting agents which have been approved by Miele. Foam can have an adverse effect on the disinfection and cleaning process.

■ Where a chemical additive is recommended on technical application grounds (for example with a cleaning agent), this does not imply that the manufacturer of the machine takes responsibility for the effect of the chemical on the material of the items being cleaned. Please be aware that changes in formulation, storage conditions etc, which may not be publicised by the chemical producer, can have a negative effect on the cleaning result.

■ When using cleaning agents and specialised products it is essential that the manufacturer's instructions are followed. Only use the product for the application described by the manufacturer, to avoid any material damage or the occurrence of strong chemical reactions such as oxyhydrogen.

■ The machine is designed only for operation with water and additive cleaning agents. Organic solvents must not be used in the machine, as there is the danger under certain circumstances of explosion. Although this is not the case with all organic solvents, other problems could arise with their use, for example damage to rubber and synthetic materials.

■ In critical applications where very stringent requirements have to be met, it is strongly recommended that all the relevant factors for the process, such as cleaning agent, quality of water are discussed with the Miele Application Technology specialists.

■ If the cleaning result is subject to these particularly stringent requirements (e.g. chemical analysis, specialised processes), a regular quality control test should be carried out by the user to ensure that required standards of cleanliness are being achieved.

■ Please follow the advice on installation in these instructions and the separate Installation Instructions.

■ Empty any containers or utensils before arranging them in the machine.

■ Do not allow any remains of acids or solvents, or chloride solutions to get into the wash cabinet. Similarly avoid any materials with a corrosive effect.

The presence in compounds of any solvents should be minimal, (especially those in hazard class A1).

■ Ensure that solutions or steam containing acid salts do not come into contact with the steel outer casing of the machine, to avoid any corrosion damage.

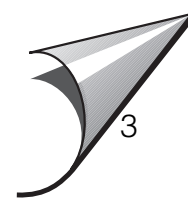

Warning and safety instructions

Accessories

- Use special inserts in accordance with the instructions provided.
- The only accessories to be used with the special commercial machine must be those supplied or approved by MIELE for the specific application. Consult your dealer or the Miele Professional department for advice.

The manufacturer cannot be held responsible for any damage caused through non-observance of these Warning and Safety instructions.

Disposal of an old machine

■ When disposing of an old machine first make it unusable. Disconnect, cut off the cable and any plug from the cable. For environmental and safety reasons ensure the machine is completely drained of any residue water and cleaning agent. (Observe safety regulations and wear safety goggles and gloves). Make the door lock inoperative, so that children cannot accidentally shut themselves in. The simplest way to do this is to remove the locking pin (2 philips screws above the door). Make appropriate arrangements for the safe disposal of the machine. For tank system machines ensure that any water is emptied out of the tank.

■ In countries where there are areas which may be subject to infestation by cockroaches or other vermin, pay particular attention to keeping the machine and its surroundings in a clean condition at all times. Any damage which may be caused by cockroaches or other vermin will not be covered by the machine guarantee.

Programme cycle								Miscellaneous
1. Preliminary pre-wash	2. Prewash II	3. Main wash & possibly thermal disinfection	4. Interim rinse I and possibly neutralisation*)	5. Interim rinse II	6. Interim rinse III	7. Final rinse	8. Drying phase (extra prog)	*) see "Programming special functions"
X								
		X 93°C **)	X	X		X 70°C AD	(X)	**) Increase in temp. holding time see "Special functions".
	X	X 60°C	X	X		X 60°C	(X)	
		X 85°C	X	X	X AD	X 70°C AD	(X)	
X		X 85°C	X	X	X AD	X 70°C AD	(X)	
X	X	X 85°C	X	X AD	X AD	X 70°C AD	(X)	

AD (Aqua destillata) = purified water, "H₂O", (distilled, R.O., or de-ionised).

X = sections included in standard programmes

Switching the machine on and off

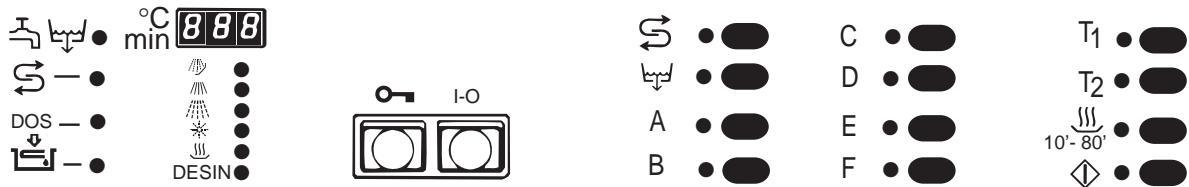

1. Switching on

- Press the I-O button.

2. Selecting a programme

After switching on the machine the indicator lights next to the selectors will light up to show the programmes available.

- Press the programme selector for the required programme. The wash temperature of the programme selected will show up in the display field.
- Select additional programme **T₁ / T₂** "TEMPERATURE" and/or "DRYING" (see "Selecting an additional programme").
- Press the "Start" touch pad.. The display panel will now show the running time in ascending minutes for the selected programme.

During the heat-up stage in "Washing/disinfecting" and "Final rinse" the end temperature will be displayed in the panel.

All other programmes are automatically blocked and only the lights for the programme selected stay on.

Programme Changes

Provided the "Start" touch pad has not yet been pressed, a wrongly selected programme may be changed as follows:

- Press the appropriate touch pad to select the required programme.
- Press the "Start" touch pad.
- Otherwise "Interrupt programme" (see page after next).

3. Selecting an additional programme

The following additional programmes are available:

T₁ TEMPERATURE FOR WASHING
T₂ TEMPERATURE FOR FINAL RINSING

Immediately after the selection of a washing programme the temperature for washing and for final rinsing can be altered through the additional programme "Temperature". Press on the appropriate touch pad T₁ or T₂ for as many times as necessary to change the temperature step by step (40°C / 50°C / 60°C / 70°C / 85°C / 93°C). The last temperature chosen will be stored for the following wash/rinse cycles, and will be shown in the display field.

Switching the machine on and off

DRYING

The additional programme "DRYING" can be selected for 10 minutes steps up to a total of 80 minutes immediately after the selection of a cleaning programme except for (except **A** "COLD").

Selecting the drying time

- Press  as many times as necessary to change the drying time step by step until the desired time is displayed (shown in the display field). For example:
Press once - 10 mins
Press twice - 20 mins and so on.

The drying cycle will automatically begin 10 minutes after the final rinse. The drying time display will then count down as time goes on.

Selecting the Drying Temperature

The drying temperature is set using the temperature selector for the (TA) Drying Unit.

To do this:

- Take off the service panel (see "Electrical Connection").

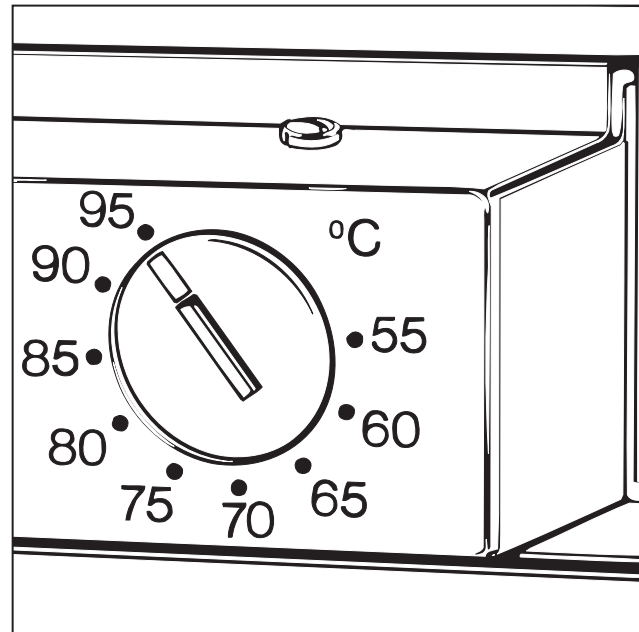



- Check the setting of the TA temperature selector. the temperature can be freely set between 55°C and 95°C and is electronically controlled.
 - approx. 95°C (max. temperature) for normal items (set ex-works),
 - approx. 70°C for items with parts made of rubber, latex or plastics, with a specified temperature tolerance,
 - approx. 55°C for items which are particularly heat-sensitive.

Please use the key supplied to switch over.

Note:

If on completion of a programme subsequent drying is necessary:

- Select the programme  DRAIN (running time only approx. 1 minute) with the additional programme  DRYING (see above).

Switching the machine on and off

§ REACTIVATION

(see "Reactivating water softener").





🌀 DRAIN,

if for example the programme has been interrupted (n.b. observe preventive measures to avoid infection):

- Press the I-O button.
- Press the 🌀 programme touchpad.
- Press the "Start"-button ◊.

Programme sequence indicator

When a washing programme has been selected, the indicator lights in the display will show the programme sequence.

-  Pre-wash
-  Wash/possibly disinfecting
-  Interim rinse
-  Final rinse
-  Drying (additional programme)

DESIN Disinfection
(Only with the "B" SPECIAL programme maintaining parameters 90-93 °C - 10', 90-93 °C - 25', 85 °C - 10', or 85 °C - 25')

When part of a programme is complete, the corresponding indicator light goes out.

The programme is completed when no indicator lights are left on (except for "DESIN" for the "B" SPECIAL programme) and when the "Start" ◊.light goes out. The display panel will show the total running time of the programme.

Switching off

- Press the I-O switch and let it spring out.

The machine can now be opened and unloaded.

Interrupting a programme

Once a programme is running it should only be interrupted in extreme cases, e.g.: when articles in the machine rattle or bump against each other and have to be rearranged.

The machine must then be switched off, the water drained and the programme restarted:

- Switch the machine on and off again with the I-O switch.
- Select the "DRAIN" programme (Additional programmes)
- On completion, open the door and replace the items securely and correctly. Take any hygiene measures necessary against infection and wear protective gloves where necessary.
- Replenish the powder detergent dispenser in the door if necessary.
- Close the door.
- Reselect the programme.

Switching the machine on and off

The following special functions can be programmed where appropriate:





1. Setting water inlet to level plus time control instead of timed inlet (60 secs).

If the inlet water pressure is lower than 2.5 bar, too little water will flow into the wash cabinet. By selecting level plus time control flow, more water will flow into the wash cabinet, if there is an inlet water pressure between 1 and 2.5 bar.





The setting is adjusted separately for cold, hot and AD-water.

- Switch off the machine.



1a. Cold water connection

- Press **T₁** and  at the same time, hold them in and also switch on the machine with "I-0".
The current programme status "P.." appears in the display.
- Press **F**. "10" or "11" will appear in the display.
"10" = Cold water connection time control (60 secs)
"11" = **Cold** water connection level plus time control
- Press  to change from "10" to "11" or vice versa.
- Press . "SP" appears.
- Press  again. The change has been recorded and the display field clears.

1b. Hot water connection

- Switch off the machine.
- Press **T₁** and  at the same time, hold them in and also switch on the machine with "I-0".
The current programme status "P.." appears in the display.
- Press **E**. "20" or "21" will appear in the display.
"20" = **Hot** water connection time control (60 secs).
"21" = **Hot** water connection level plus time control
- Press  to change from "20" to "21" or vice versa.
- Press . "SP" appears.
- Press  again. The change has been recorded and the display field clears.

1c. AD water connection

- Switch off the machine.
- Press **T₁** and  at the same time, hold them in and also switch on the machine with "I-0". The current programme status "P.." appears in the display.
- Press **D**. "30" or "31" will appear in the display.
"30" = **AD** water inflow time control (60 secs)
"31" = **AD** water inflow level plus time control.
- Press  to change from "30" to "31" or vice versa.

Programming special functions

- Press \diamond . "SP" appears in the display.
- Press \diamond again. The change has been recorded and the display field clears.

2. Increasing the temperature holding from 10 to 25 minutes in the "Wash" part of the programme, (only in the "B" SPECIAL programme).

- Switch off the machine.
- Press **T₁** and $\underbrace{\text{|||}}_{\text{}}_{\text{}}$ at the same time, hold them in and also switch on the machine with "I-0". The current programme status "P.." appears in the display.
- Press **C**. "40" or "41" will appear in the display.
"40" = Temp. holding time 10 mins.
"41" = Temp. holding time 25 mins.
- Press $\underbrace{\text{|||}}_{\text{}}_{\text{}}$ to change from "40" to "41" or vice versa..
- Press \diamond . "SP" appears in the display.
- Press \diamond again. The change has been recorded and the display field clears.

Note:

The temperature **T₁** must not exceed 85 °C, (see "Selecting additional programmes").

3. Adding neutralising agent in the "Interim rinse 1" part of the programme.

The machine is set at the factory for rinsing agent to be dispensed in the "Final rinse" part of the programme. If neutralising agent is to be dispensed instead make the following adjustment:

- Switch off the machine.
- Press **T₁** and $\underbrace{\text{|||}}_{\text{}}_{\text{}}$ at the same time, hold them in and also switch on the machine with "I-0". The current programme status "P.." appears in the display.
- Press **B**. "50" or "51" will appear in the display.
"50" = Rinsing agent dosage
"51" = Neutralising agent dosage.
- Press $\underbrace{\text{|||}}_{\text{}}_{\text{}}$ to change from "50" to "51" or vice versa..
- Press \diamond . "SP" appears in the display.
- Press \diamond again. The change has been recorded and the display field clears.

Reactivating the water softener

When the **S** indicator light on the left hand side of the control panel comes on during a programme the built-in water softener is depleted and cannot supply any more softened water. It must therefore be reactivated with **dish-washer salt** as soon as the programme has finished.

If this cannot be done immediately, and further batches have been washed, then the reactivation process must be carried out **twice** in succession.

Only use special course grained dish-washer salt (granule size approx. 1-4 mm), for reactivation, as other salts may contain insoluble impurities or additives which can impair the functioning of the softener.

The salt container holds approx. 2 kg salt.

Important

If the only reactivation salt available is fine grain, please consult your Miele service representative.

Reactivation salt with granules larger than 4 mm cannot be used.

Never fill the salt reservoir with dishwasher cleaning agent

this can lead to

- damage to the water softener and
- blockage of the salt container filter insert, resulting in a build up of pressure in the salt reservoir.

The irritant alkali solution could be a hazard and personal injury could be caused when the salt container is removed.

Make sure that you have picked up the right packet of dishwasher salt before filling the salt container.

Filling the salt container

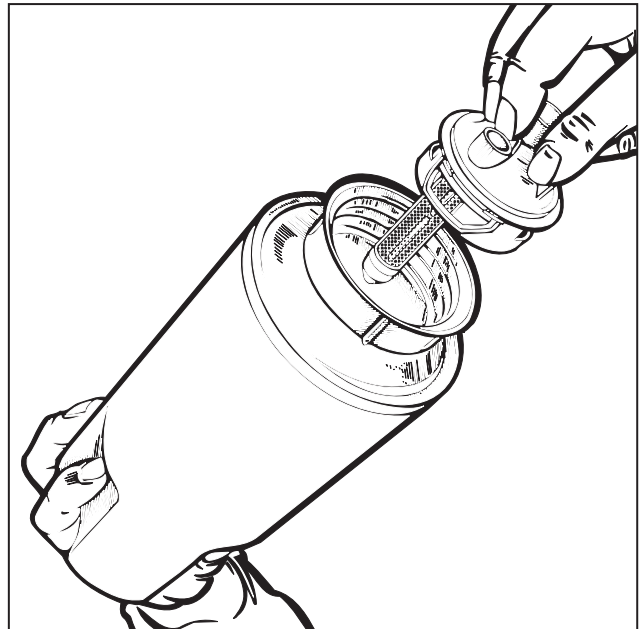

- Unscrew the filter insert from the salt container and remove.
- Fill the salt container **with granular dishwasher salt** and screw the filter insert back in place.

Reactivating the water softener

Position the salt container as follows:

- Remove the bottom basket from the machine.

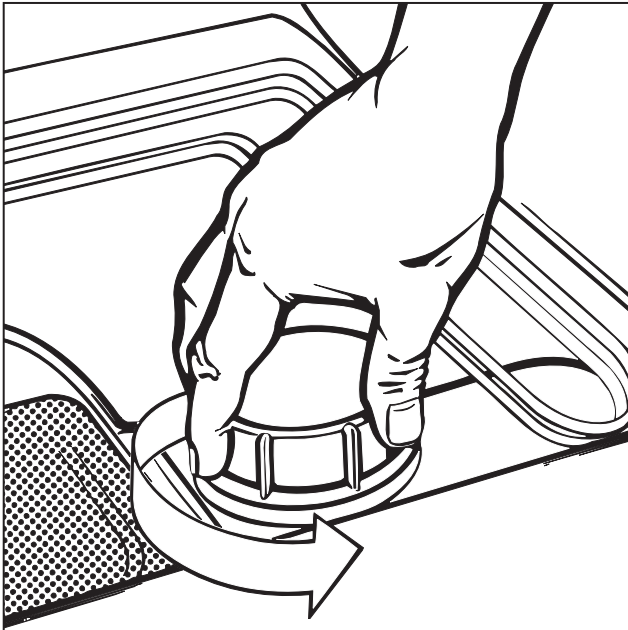

- Unscrew the plastic cap in the base of the wash cabinet.

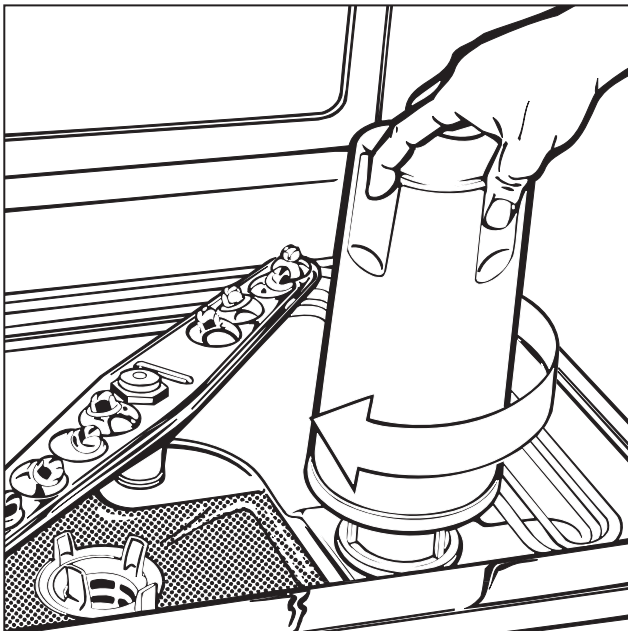

- Place the salt container on the reactivation socket and screw firmly into place.

Switch on the machine

- Open the stopcocks if previously closed.
- Close the door.
- Press I-0.
- Press the S touch pad.
- Press the "Start" \diamond touch pad.

The reactivation programme proceeds automatically and finishes when the indicator light S at the left hand side of the control panel and the "Start" indicator light \diamond have gone out.

Then:

- Switch off the machine.
- Unscrew the salt container carefully, so that any water pressure that has built up can be released. Do not use force. If you cannot uncrew the salt container by hand, contact the Miele Service department.
- Screw the plastic lid back on the socket.
- Reposition bottom basket.
- Rinse the salt container and filter insert thoroughly.
- Turn off the stopcocks if the machine is not to be used again for some time.

Important

The water pressure (flow pressure at the take off point) must be at least 2.5 bar. If it is less than this see "Programming special functions".

If the flow pressure is below 2.5 bar, or if it fluctuates, the water softener cannot be reactivated in the normal way. After reactivation, salt remains may still be found in the salt container.

To use up the salt remains and to wash out the water softener, the "reactivate softener" programme must be switched on again.

Cleaning the filters in the water cabinet

The filter combination in the base of the cabinet should be inspected regularly and cleaned if necessary.

Caution!

Watch out for glass splinters which could cause injury.

Cleaning the coarse filter

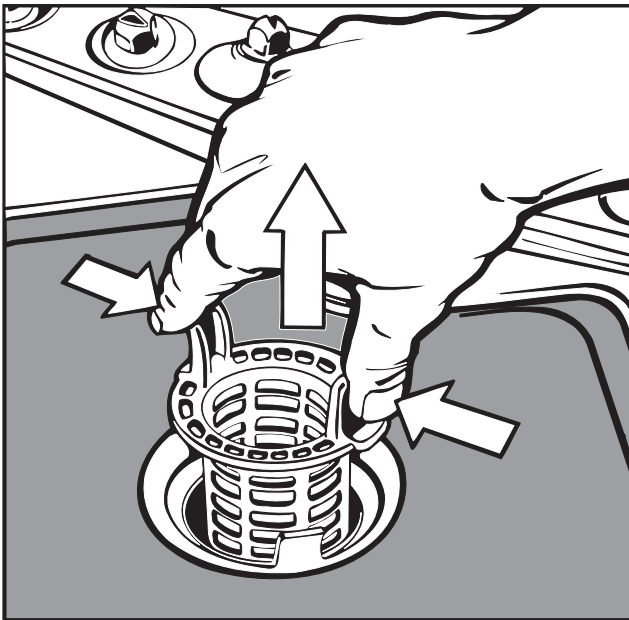

- Press the 2 lugs together, remove and clean the filter.
- Put the clean filter back in position and press until it clicks in place.

Cleaning the fine, flat and micro-fine filters

- Remove the coarse filter
- Remove the fine filter (if fitted) from between the flat and micro-fine filters.

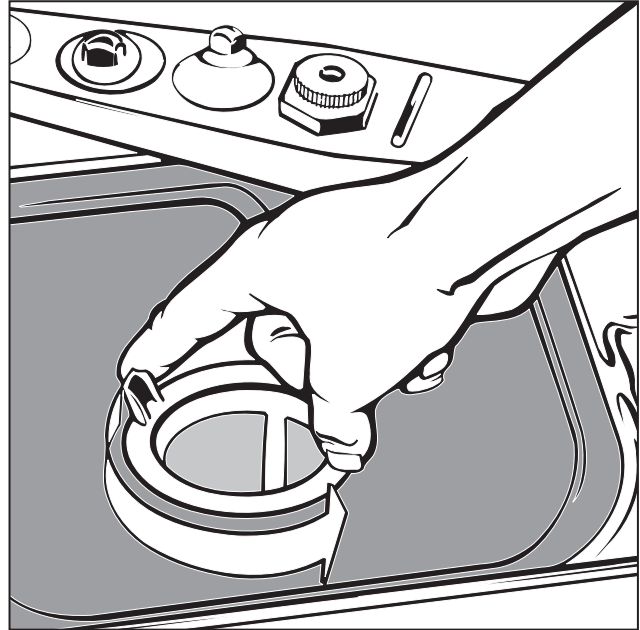

- To unscrew the micro-fine filter, take hold of the two lugs, turn twice in an anti-clockwise direction.

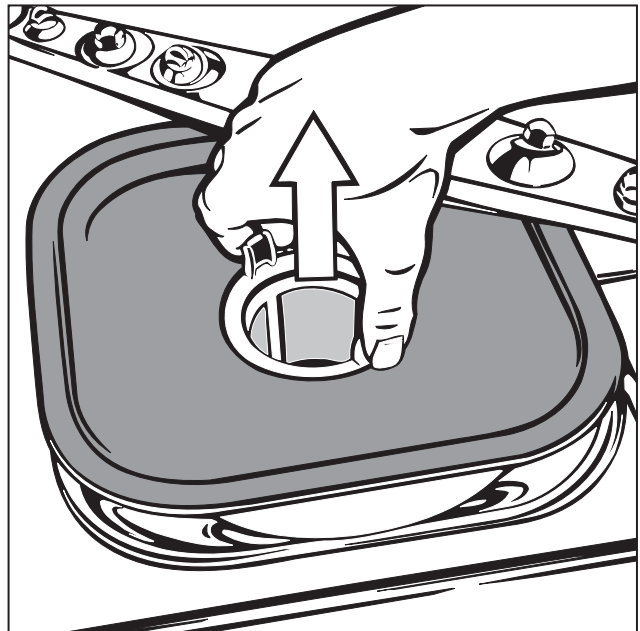

- Remove, together with the flat filter.
- Clean the filters.
- The filter combination is then replaced in the reverse order to which it was removed.

The machine must not be used without all the filters in place.

Cleaning and care

Cleaning the filters in the water inlet

For the protection of the inlet valve(s), filters are incorporated in the screw connection of the water inlet hose. The filters must be cleaned when dirty, otherwise insufficient water flows into the wash cabinet.

- Turn off stopcocks.
- Unscrew the water inlet hoses.

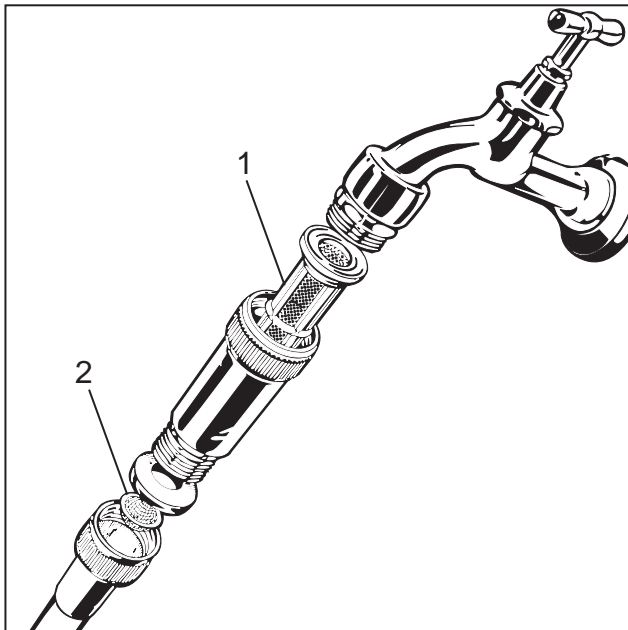

- Clean large area filter (1) and fine filter (2) or replace if necessary.
- After reconnection, turn on the stopcock to test for leaks.

There is a further filter in front of the water inlet valve which must only be cleaned or replaced by a suitably qualified and competent person.

Drying unit (TA) cleaning and care

Changing the Coarse Filter

The coarse filter should be changed when it is soiled or after approx. 100 operating hours, (see time counter on the TA unit).

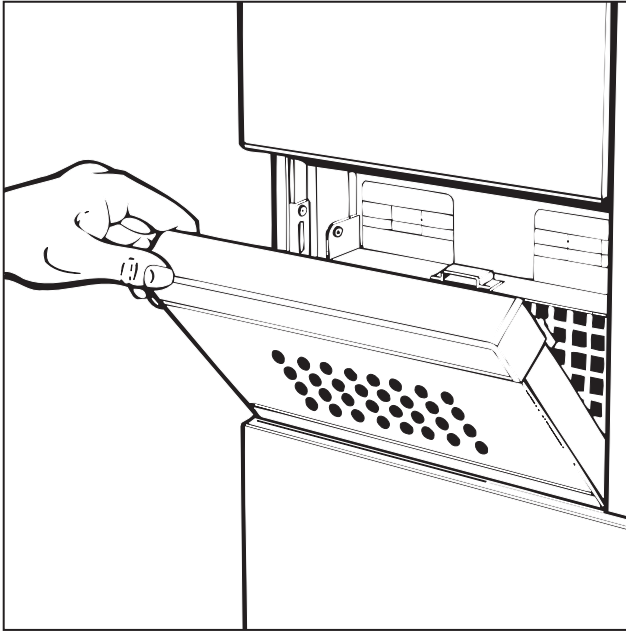

- Grip the inlet grille to the right and the left and pull up out of the retainers and then downwards and off.

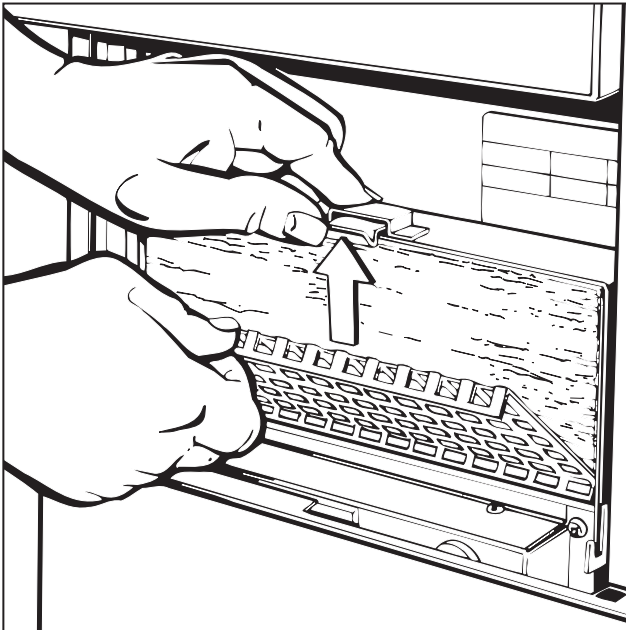

- Take out the perforated plate.

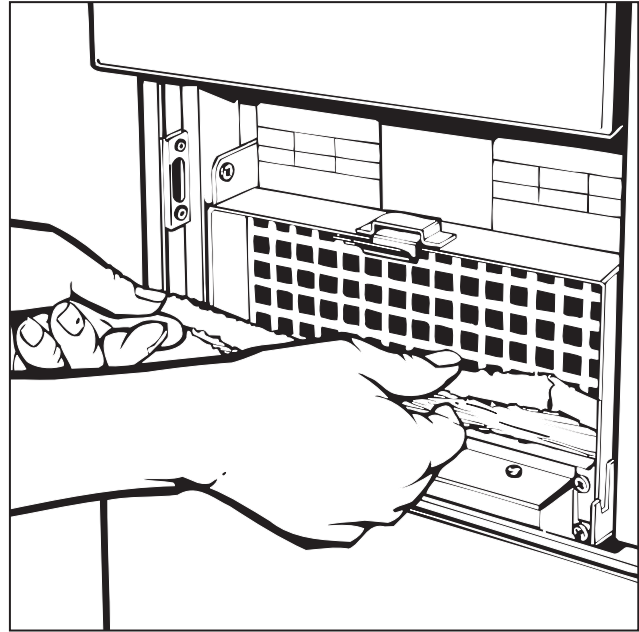

- Change the coarse filter.
 - The smooth side of the filter must face the rear.
- Position the perforated plate at the base and press into place at the top.
 - The edge surround should face forward.
- When putting back the inlet grille, it should audibly click into place.

Exchanging the S-class particle filter

It is advisable for this filter to be replaced after approx. 500 operating hours (see the time counter on the TA control unit).

This filter should only be changed by an authorised Service Dealer or the MIELE Service department.

The effective operating of the machine can only be achieved if original "Miele" S - class particle filters are used.

Correcting minor faults

With the aid of the following explanatory notes, minor faults can usually be corrected without contacting the Miele Service Department.

Any work on the electrical components of the machine should only be carried out by a suitably qualified and competent person.

Faults/Possible Causes

The machine does not start

- Check that the door is properly shut.
- Check the plug connection or isolator.
- Check the fuses.

A few minutes after switching on, the indicator light flashes.

- The stopcocks are closed.
- The water inlet hose filters are dirty.
- Switch off the machine.
- Open the stopcocks or clean the filters (see "Cleaning and care").
- Switch on the machine again and re-select the programme.

The wash cycle finishes too early and the indicator light flashes

- The drain hose is kinked.
- The door was opened and closed during the programme.
- There was an interruption to the power supply.
- Correct the fault
- Pump away the water and start the programme again (see procedure under "Interrupting a programme").

The water in the wash cabinet is not heated; the programme sequence lasts too long.

This machine has a resettable heater limiter which will switch off the heaters in the case of over-heating. This could be caused for example, if large articles obscure the heating elements or if the filters in the wash cabinet are blocked.

- Remove cause of fault.
- Take off service panel (see under "Electrical connection").

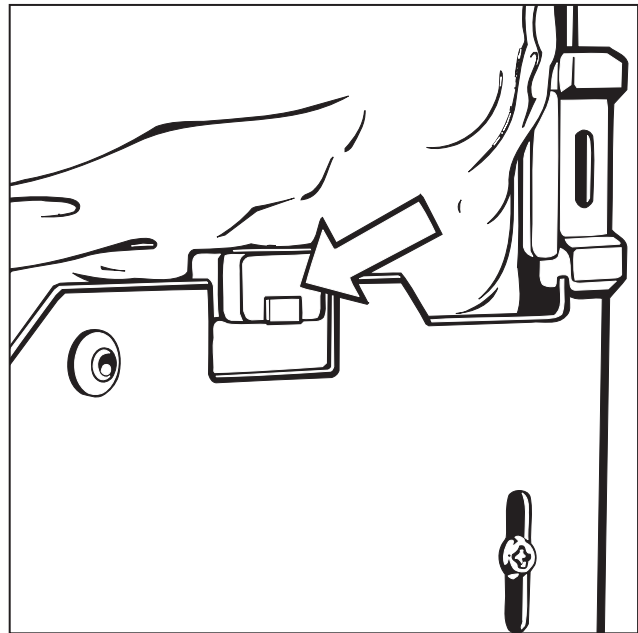

- Press in the re-set button (blue) on the heater limiter.

If this switch trips repeatedly, your Service Dealer or the Miele Service Department must be contacted.

In the event of any faults which cannot be remedied, please contact your Service Dealer or the Miele Service Department.

Please refer to the Installation diagram supplied with the machine.

The machine must be installed correctly and levelled.

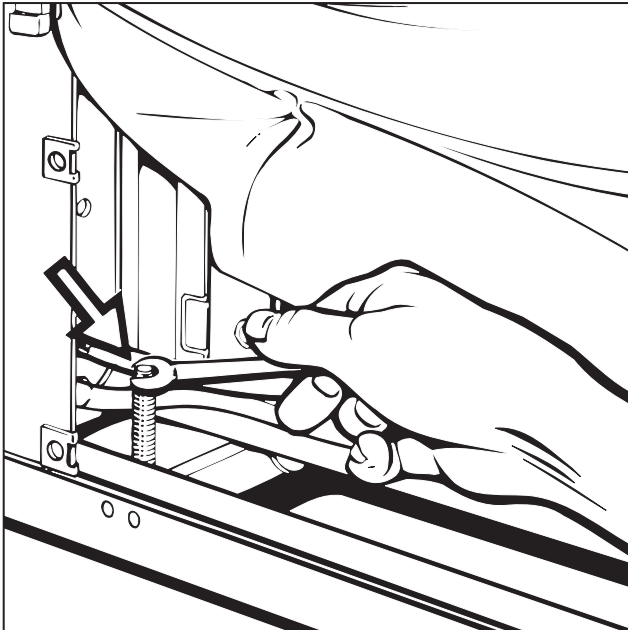

Any unevenness in the floor level can be compensated by adjusting the screw feet on the right and left hand sides at the front of the machine.

The service panel must first be lifted off and the cover plate must be unscrewed (see under "Electrical Connection").

When the screw feet are screwed in, the disinfector can be moved backwards or forwards on its rollers.

The machine can be installed in the following ways:

- Free-standing *)
- Slot-in or at the end of a row: *)

The machine can be installed adjacent to other equipment or furniture or in a recess at least 90 cm wide and 70 cm deep.

*) A machine lid is essential with this type of installation (available as a special accessory).

- Building under:

The machine should be positioned under a continuous worktop. The niche dimensions must be at least 90 cm wide, 70 cm deep and 82 cm high.

Important for machines with DHK steam condensor:

To avoid steam damage to the worktop the self-adhesive protective sheet supplied (25 x 58 cm) should be stuck under the worktop in the area of the condensor.

Position and secure the machine

To guarantee stability the machine must first be aligned and then screwed to the worktop.

Installation

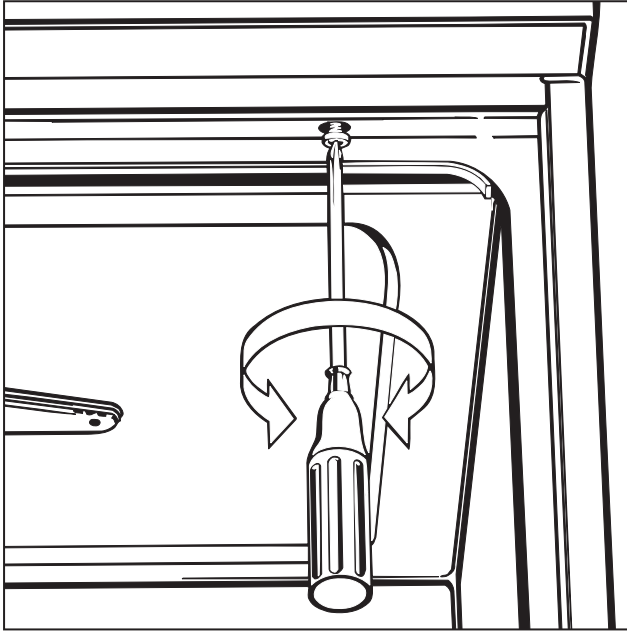

- Open the door. Through each of the two holes in the front rim, left and right, screw the machine to the front edge of the continuous worktop.
- Do not use silicone sealant to seal the gaps between the machine and any neighbouring units as this would hinder ventilation to the circulation pump.

Depending on the various requirements for building under, the following kit may also be required:

Cover plate (worktop protection)

The underside of the work surface is protected from steam damage by a plate of stainless steel.

Electrical connection

All electrical connection work must be carried out by a qualified electrician in compliance with local and national regulations.

- Connection should be made via a suitable isolator, with an on-off switch which should be easily accessible for servicing.
- For extra safety it is advisable to install a residual current device (RCD) with a trip current of 30 mA (DIN VDE 0664).

WARNING **THIS APPLIANCE MUST BE** **EARTHED**

- For technical data see data plate or wiring diagram supplied.

The machine must only be operated with the voltage, frequency and fusing shown on the data plate.

The machine is **not convertible**.

The wiring diagram is to be found behind the cover plate on the left hand side, attached to the floor of the machine.

The data plate with test certification is on the rear of the machine, and on the cover plate (behind the service panel).

To remove service panel and cover plate

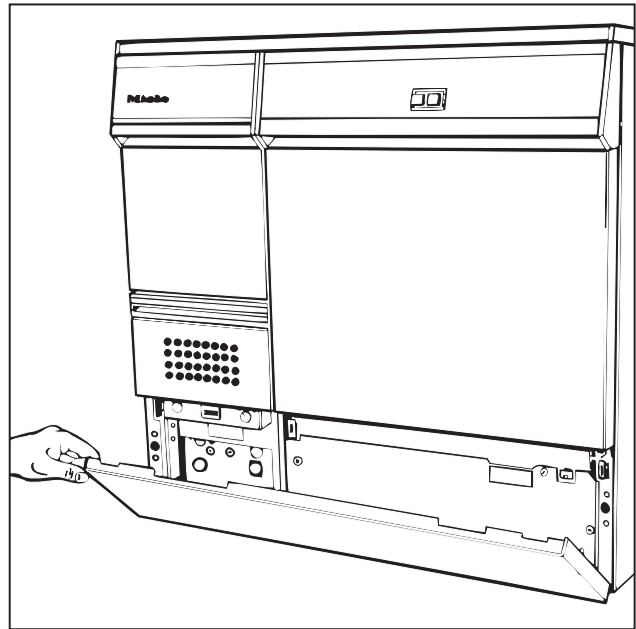

- Holding the service panel at the top right and bottom left hand corners, pull up out of its retainers and lift out at the bottom.

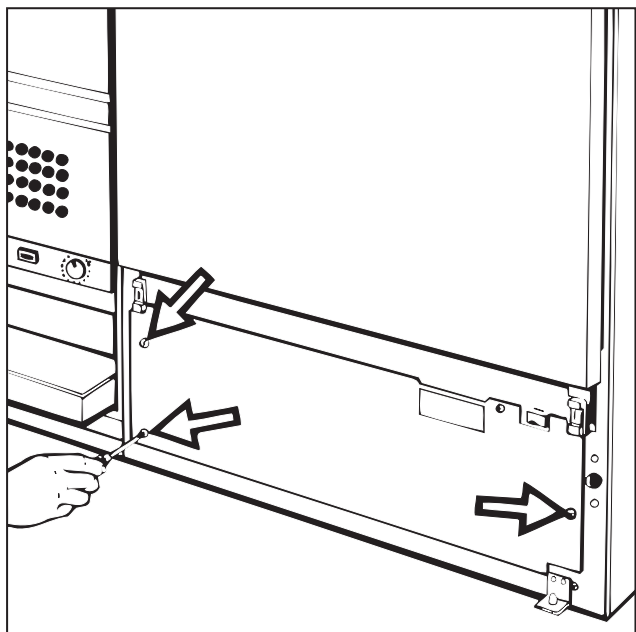

Isolate the machine from the power supply.

- Unscrew the cover plate.
- Pull off earth lead if necessary.

Electrical connection

- Remove the plastic protective cap.

To re-assemble:

- Refit plastic protective cap, cover plate and service panel in the reverse order to which they were removed.

Make certain that the earth lead is reconnected.

Consult the Installation Instructions supplied.

Connection to the water inlet

- The machine must be connected to the water supply in accordance with the local and national regulations, (NWC in GB).
- The machine is constructed to comply with DVGW regulations, in such a way that an external non return valve is not required.
- The water pressure (flow rate) must be between 2.5 and 10 bar. If the water pressure is not within this range, the Customer Service Department will advise you of the measures to take (see also "Programming special functions").
- The machine is supplied as standard for connection to cold (blue markings) and hot (red markings) water supply to max. 70°C. See next page for AD connection to purified water (H₂O pure).
The inlet hoses should be connected to the respective cold and hot water stopcocks.
If no hot water supply is available, the hose for hot water (red marking) must also be connected to the cold water supply. In this case both hoses must be connected to the cold water supply.
In special cases, see Programme E in the chart, connection of both hoses to hot water is recommended. In order to prolong its life, the hose marked 90°C should only be used on a hot water connection supplying water no hotter than 70°C.

- Stopcocks with 3/4 BSP male thread to be provided on site. They should be easily accessible because the water supply must be turned off when the machine is not in use.
- The DN 10 inlet pressure hoses are approximately 1.7 m long and terminate in a 3/4" female thread. On no account must the inlet filters be removed.
- For additional protection of the solenoid valve against impurities in the water supply, large surface area filters are enclosed in the kit supplied with the machine (see illustration in "Cleaning and care, water inlet"). The filter for AD purified water (H₂O pure) is made from chrome-nickel steel and has a matt upper surface.

Consult the installation instructions supplied.

The water in the machine is not suitable for drinking.

Plumbing

AD connection to purified water, pressurised, (1.5 - 10 bar)

The machine is delivered from the factory ready for connection to a pressurised system, 1.5 - 10 bar.

- The AD pressure tested hose, marked H₂O pure, with 3/4" thread must be connected to the on-site AD stopcock for purified water.

Connection to purified water non-pressurised (0 - 1.5 bar)

For connection to a supply of 0 - 0.3 bar, or 0.3 - 1.5 bar the machine must be converted, if not supplied converted ex-works. An "ADP" booster pump can only be fitted. This is only possible when the machine has no DHK steam condensor. As this work requires specialised knowledge, it should only be carried out by a Miele approved engineer.

The outlet of the purified water container (non-pressurised) must be at least at the height of the upper edge of the machine. (see "Installation instructions").

- Connect the non-pressurised AD water hose to the purified water container

If the AD connection to purified water is not being used (or if it should not be used) then the machine must be converted by a Miele trained or approved engineer.

Drainage

- The drainage system is fitted with a non-return valve which prevents dirty water from flowing back into the machine via the drain hose.
- The machine should preferably be connected to a separate drainage system on site. If no separate drainage system is available, seek professional advice.
- The machine is supplied with flexible drain hoses with an internal diameter of 22 mm and approx. 1.5 m long. The drain hose must not be shortened. Hose clamps for connection are supplied.
- Longer drain hoses (up to 4 m) are available if required. Contact the Miele Service Department.
- The drainage system must not exceed 4 metres and the drain pump has a maximum delivery head of 1 metre.

Ventilation of the wash cabinet at rear

For machines without DHK Steam condensor, the rear ventilation of the wash cabinet should be connected to an on-site venting system.

Please refer to the Installation Instructions provided.

Caring for the environment

Disposal of the packing material

The transport and protective packing has been selected from materials which are environmentally friendly for disposal and can normally be recycled.

Rather than just throwing these materials away, please ensure they are offered for recycling.

Disposal of your old machine

Old machines contain materials which can be re-cycled. Please contact your local authorities or scrap merchant about potential recycling schemes, before disposing of the machine.

When disposing of an old machine first make it unusable. Disconnect, cut off the cable and any plug from the cable. For environmental and safety reasons ensure the machine is completely drained of any residue water and cleaning agent. (Observe safety regulations and wear safety goggles and gloves). Make the door lock inoperative, so that children cannot accidentally shut themselves in. The simplest way to do this is to remove the locking pin (2 screws above the door). Make appropriate arrangements for the safe disposal of the machine. For tank system machines ensure that any water is emptied out of the tank.

Noise emission in dB (A)

Measurement of noise: 65

Miele

United Kingdom

Miele Co. Ltd.

Fairacres, Marcham Road, Abingdon, Oxon, OX14 1TW

tel. Abingdon (01235) 554455 - fax (01235) 554477

Service Office, tel. Abingdon (01235) 554466

Ireland:

Miele Ireland Ltd.

Wilton House, Naas Road, Dublin 22

Tel. (01) 4504024, Fax (01) 4504037