

FAVORIT 80820

Dishwasher

User Instructions



Dear customer,

Please read these user instructions carefully.

Please observe the safety instructions on the first few pages of these user instructions! Please keep these user instructions for later reference. Pass them on to any subsequent owner of the appliance.



The warning triangle and/or specific words (**Warning!**, **Caution!**, **Important!**) are used to highlight instructions that are important for your safety or for the function of the appliance. It is imperative that these instructions are observed.



This symbol or numbered instruction steps lead you step by step through the operation of the appliance.



Next to this symbol you receive additional information and practical tips on using the appliance.



Tips and instructions for the economical and environmentally conscious use of the appliance are marked with a clover leaf.

In the event of a malfunction, these operating instructions contain information on how to rectify faults yourself, see the "What to do, if..." section.

If these instructions are insufficient, please contact your AEG Service Force Centre.

In this respect please read the chapter "Service & Spare Parts".

Printed on paper manufactured with environmentally sound processes.
He who thinks ecologically acts accordingly ...

CONTENTS

Operating Instructions	5
Safety Instructions	5
Disposal	7
Economical and Ecological Dishwashing	7
Appliance Features and Control Panel	8
Control Panel	9
Prior to using for the first time	10
Adjusting the Water Softener	11
Filling with Salt for the Water Softener	13
Rinse Aid	14
Switching Rinse Aid Supply On and Off	14
Filling with Rinse Aid	15
Adjusting Rinse Aid Dosing	16
Switching the Acoustic Signal for the End of the Wash Programme On and Off	16
In Daily Use	17
Loading Cutlery and Dishes	17
Loading Cutlery	18
Loading Pans, Frying Pans and Large Plates	19
Loading Cups, Glasses and Coffee Services	21
Adjusting the Height of the Upper Basket	22
Filling with Detergent	23
Use of "3 in 1"/ Combi Detergent Tablets	24
Concentrated Detergent	25
Detergent tablets	25
Automatic Wash Programmes	25
Selecting the Wash Programme (Programme Table)	26
Starting the Wash Programme	28
Changing/Interrupting/Canceling the Wash Programme	28
Pause Function	29
Setting or Changing the Delay Start Timer	29
Load Sensing – Sensor Logic	30
Switching Off the Dishwasher	30
Emptying the Dishwasher	30

Care and Cleaning	31
Cleaning the Filter	31
What to do, if	33
...Error messages	33
...there are problems with the operation of the dishwasher.	35
...the wash result is not satisfactory.	35
Technical Data	36
Notes for Test Institutes	37
Installation and Connection Instructions	38
Installing the Dishwasher	38
Built-Under Dishwasher	38
Free-Standing Appliances	38
Connecting the Dishwasher	40
Water Connection	40
Permitted water pressure	40
Connect the inlet hose	40
Water drain	42
Leak Prevention System	43
Electrical Connection	44
Connections	45
Guarantee Conditions	46
Service and Spare parts	47

OPERATING INSTRUCTIONS



Safety Instructions

The safety aspects of AEG electrical appliances comply with accepted technical standards and the German Appliance Safety Law. Nevertheless, as a manufacturer we consider it our obligation to make you aware of the following safety information:

Installation, Connection and Placing into Operation

- The dishwasher may only be transported upright.
- Check the dishwasher for transport damage. Do not in any circumstances connect an appliance that is damaged. In the case of damage, please contact your retailer.
- Before installing the appliance, ensure that the nominal voltage and type of supply on the rating plate match that of the supply where the appliance is to be installed. The fuse rating is also to be found on the rating plate.
- For information on how to correctly install and connect up your dishwasher, please read the "Installation" section. Adaptors / connectors and extension cables must not be used.

Child Safety

- This appliance is designed to be operated by adults. Children should not be allowed to tamper with the controls or play with the product.
- Keep all packaging away from children.
- Keep all detergents in a safe place out of children's reach.
- The water in your dishwasher is not suitable for drinking. If there are still remnants of detergent in the appliance, there is a risk of burns!
- When disposing of an old appliance, cut off the power supply cable and remove any door catches, to prevent young children being trapped inside.

General Safety

- Repairs to the dishwasher are only to be carried out by qualified service engineers. Improper repairs can give rise to significant hazards for the user. If your appliance needs repairing, please contact your local AEG Service Force Centre.

- Never place the dishwasher in operation if the mains cable, water inlet or drain hose is damaged; or the control panel, work top or plinth area is damaged such that the inside of the appliance is freely accessible.
- If the mains lead is damaged, or is to be replaced for a longer lead, the cable (obtainable from AEG Service Force) must be changed by a service engineer authorised by AEG.
- Never unplug the appliance by pulling on the cable, always pull the plug.
- Additions or modifications to the dishwasher are not permitted for safety reasons.
- Ensure that the door of the dishwasher is always closed when it is not being loaded or unloaded. In this way you will avoid anybody tripping over the open door and hurting themselves.
- Long bladed knives stored in an upright position are a potential hazard.
- Sharp knives and items of cutlery with sharp edges must be placed in the cutlery tray or in the upper basket.
- When finished loading or unloading, close the door as an open door can be a hazard.

Correct Use

- Only wash household dishes using the dishwasher. If the appliance is used for other purposes, or is used incorrectly, the manufacturer cannot accept any liability for any damage caused.
- Only use detergents specifically designed for use in domestic dishwashers.
- Do not put any solvents in the dishwasher. There is a risk of an explosion!
- The anti-flood system provides dependable protection against damage due to leaks. For this system to function correctly, the following preconditions must be met:
 - The appliance must remain connected to the mains even when it is switched off.
 - The dishwasher must be correctly installed.
 - Always shut off the water supply at the tap when the dishwasher is not to be used for longer periods, e.g. when you are away on holiday.
- Do not sit or stand on the open door, the appliance may tip over.

- In the event of a fault, first close the tap, then switch off the appliance and unplug it from the mains. If the appliance is permanently wired to the mains: remove the fuse.



Disposal

Disposing of the Packaging Material

Dispose of the dishwasher packaging material correctly. All the packaging materials used are harmless to the environment and can be recycled.

- Plastic parts are marked with standard international abbreviations:
 - >PE< for polyethylene, e.g. sheet wrapping material
 - >PS< for polystyrene, e.g. padding material (always CFC-free)
 - >POM< for polyoxymethylene, e.g. plastic clips
- Cardboard packaging is manufactured from recycled paper and should be deposited in the waste paper collection for recycling.

Disposal of Old Appliances

When disposing of old appliances, remove the plug and ensure that any locks or catches are removed to prevent young children becoming trapped inside.

Use an authorised disposal site.



Economical and Ecological Dishwashing

- Ensure that the water softener is correctly adjusted.
- Do not pre-rinse dishes under running water.
- If you wash a small load, the load sensor calculates the amount of water necessary and shortens the programme. It is more economical to always wash with a full load.
- Select the wash programme to suit the nature and degree of the soiling on the dishes.
- Do not use more detergent, special salt or rinse aid than is recommended in these operating instructions and by the detergent manufacturer.
- The dishwasher's interior light is always switched on as long as the door of the appliance is open. To save energy you should therefore always close the door of the dishwasher after loading or removing dishes.

Appliance Features and Control Panel

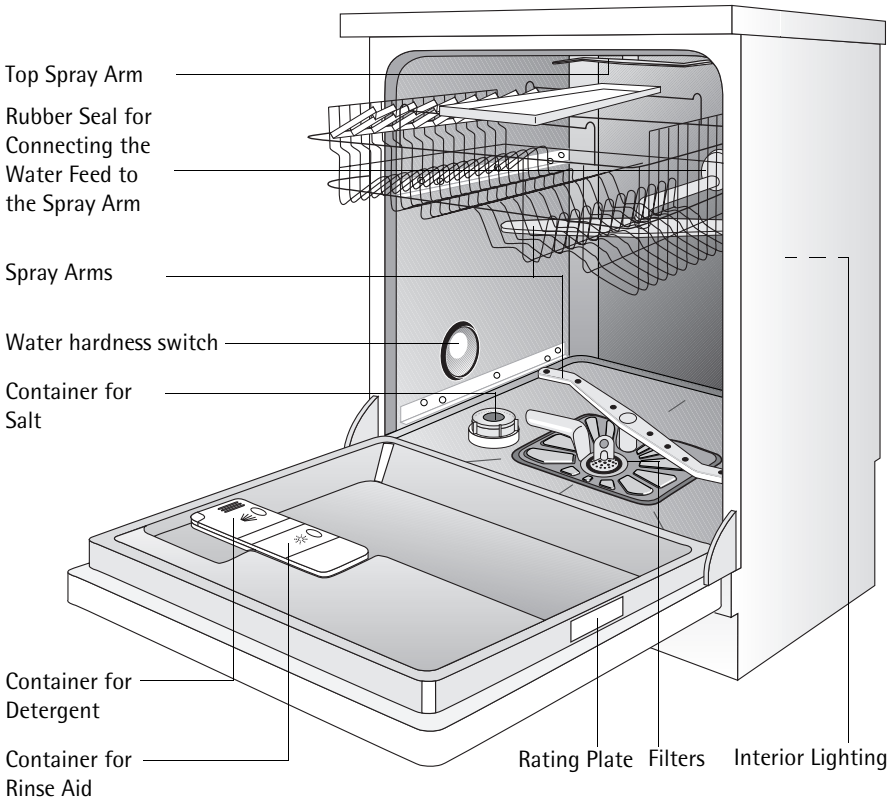

Control Panel

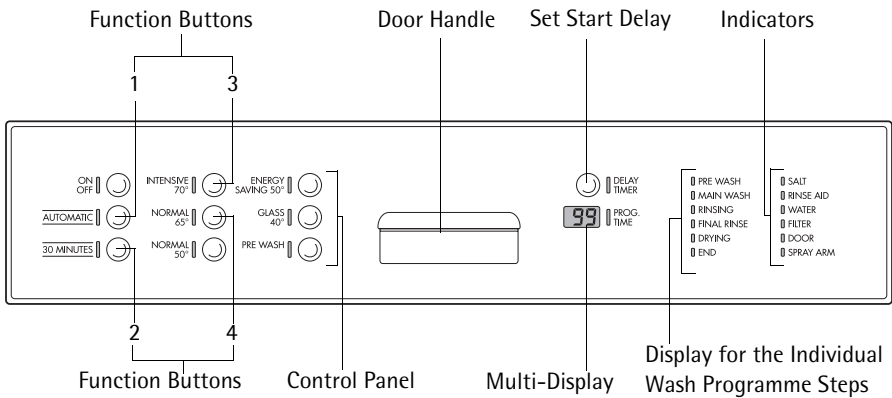

The **control panel** consists of the ON/OFF button and the programme buttons with LED displays.

Function buttons: In addition to the stated wash programme the following functions can also be set using these buttons:

Function Button 1	Switch acoustic signal on and off
Function Button 2	Adjust the water softener
Function Button 3	Switch rinse aid supply on and off
Function Button 4	- is not occupied -

The Multi-Display can display,

- the hardness setting to which the water softener is set.
- whether the signal tone is switched on or off.
- whether the rinse aid supply is switched on/off.
- the start delay that is set.
- how long the current wash programme can be expected to last.
- which fault has occurred on the dishwasher.

Cycle progress display: The current stage of the programme will always be shown in the cycle progress display.

Indicators have the following significance:

SALT	Refill with special salt
RINSE AID	Refill with rinse aid
WATER	Open the tap
FILTER	Clean the dishwasher's filter system
DOOR	The dishwasher door is open
SPRAY ARM	The middle spray arm is jammed



The **FILTER** indicator is intended to remind you to check the filters in the dishwasher from time to time and, if necessary, to clean it. The indicator illuminates at regular intervals, independent of the amount of soiling of the filters.

Prior to using for the first time

Prior to using for the first time, remove all the clips with which the baskets are secured for transport.

Then perform the following steps:

-  **1.** Adjust the water softener
- 2.** Fill with Salt for the Water Softener
- 3.** Fill with Rinse Aid

Adjusting the Water Softener

To prevent the build up of scale on dishes and in the dishwasher, the dishes must be washed with soft, i.e. low lime content water. For this reason the dishwasher is fitted with a water softener in which tap water from a hardness of 4 °d (German degree) is softened with the aid of special salt.



Your local water authority can advise you on the hardness of the water in your area.



Adjust the water softener as stated in the table to the setting that corresponds to the hardness of the water in your area. The water softener can be set manually using the water hardness switch and also electronically using the buttons on the control panel.

Water Hardness			Hardness Setting		Display in the Multi-display
in °d ¹⁾	in ppm ²⁾	Range	Manual	Electronic	
51 - 70	9,0 - 12,5	IV	1	9	H 9
43 - 50	7,6 - 8,9			8	H 8
37 - 42	6,5 - 7,5			7	H 7
29 - 36	5,1 - 6,4			6	H 6
23 - 28	4,0 - 5,0			5	H 5
19 - 22	3,3 - 3,9	III	0*	4	H 4
15 - 18	2,6 - 3,2			3*	H 3
11 - 14	1,9 - 2,5	II		2	H 2
4 - 10	0,7 - 1,8	I/II		1	H 1
under 4	under 0.7	I		0 no salt necessary	H 0

1)(°d) German degrees, a measure of water hardness

2)(ppm), Parts Per Million

*factory setting

Adjust the water softener to the hardness of the water in your area as stated in the table:

 **1.** The dishwasher must be switched off.

2. Manual adjustment:

Open the dishwasher door.

3. Remove the lower basket from the dishwasher.

4. Turn the water hardness switch to 0 or 1.

5. Re-position the lower basket.

6. Electronic adjustment:

Simultaneously press and hold down function buttons **1** and **2**.

7. Press the ON/OFF button.

The LED displays for the engaged function buttons will flash.

8. Press function button **2** again.

The multi-display will show which hardness setting has been set.

9. Pressing function button **2** increases the hardness setting by 1.
(Exception: hardness setting 0 follows hardness setting 9).

10. Once the hardness setting is set correctly, press the ON/OFF switch.
The hardness setting is then saved.

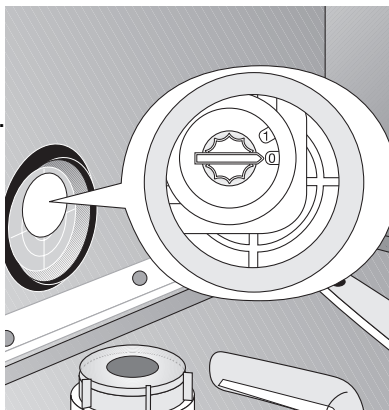

Filling with Salt for the Water Softener



Use only special salt for dishwashers. Never fill the salt container with any another type of salt (e.g. culinary salt) or dishwasher detergent, as this would irreparably damage the water softener.

Prior to filling with salt, please check each time that you really do have a packet of dishwasher salt in your hand.

Fill with dishwasher salt:

- Prior to using the dishwasher for the first time
- When the **SALT** indicator on the control panel is illuminated.



If the water hardness in your area is less than 4 °d, you do not need to use dishwasher salt.



1. Open the door, remove the lower basket.
2. Undo the lid on the salt container by turning it anticlockwise.
3. **When using for the first time:** fill the salt container with water.
4. Place the funnel supplied on the container opening.
Fill the container with salt through the funnel; the capacity of the container is approx. 1.0-1.5 kg depending on the grain size. Do not overfill the salt container with salt.

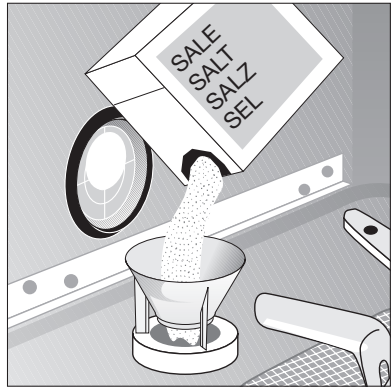

The water expelled by filling the salt container with special salt runs out of the salt container onto the base of the washing compartment. This is not a cause for concern, the water will be pumped out at the start of the next wash programme.

5. Clean any salt remnants on the container opening.
6. Turn the lid clockwise to the stop, otherwise dishwasher salt will leak into the wash water, this could lead to poor wash results. To avoid this run a rinse programme after filling the salt container with special salt. This will wash away salt water and any salt crystals that have been spilt.



Depending on the size of the salt grains, it can take several hours for the salt to dissolve in the water and for the SALT indicator to extinguish.

The setting of the water softener and thus the consumption of salt are dependent on the hardness of the local water.

Rinse Aid

Rinse aid ensures that dishes emerge thoroughly rinsed and spot free while glasses are clear and shining.

There are two ways to add rinse aid:

- If you use detergent that already contains rinse aid, the detergent and rinse aid are placed in the detergent container.
 - In this case the rinse aid supply from the rinse aid container must be **switched off** to avoid double dosing.
- If you use separate detergent and rinse aid, the rinse aid is placed in the rinse aid container.
 - In this case the rinse aid supply from the rinse aid container must be **switched on**.
 - Rinse aid dosing levels need to be set.



Only use rinse aid specifically designed for domestic dishwashers. Never fill the rinse aid container with any other substance (e.g., vinegar concentrate or dishwasher cleaning agent) as this would damage the appliance.

Switching Rinse Aid Supply On and Off

1. The appliance must be switched off.
2. Simultaneously press and hold down function buttons **1** and **2**.
3. Press the ON/OFF switch.
The LED displays for the engaged function buttons will flash.
4. Press function button **3**.
The multidisplay shows the current setting:

d 0	Rinse aid supply switched off
d 1	Rinse aid supply switched on (factory setting)

5. Pressing function button **3** changes the setting.
6. Once the multi-display shows the required setting, press the ON/OFF button. The setting is then saved.

Filling with Rinse Aid

If you use separate detergent and rinse aid, fill up with rinse aid:

- prior to using the dishwasher for the first time
- when the **RINSE AID** indicator on the control panel is illuminated.

The rinse aid compartment is on the inside of the dishwasher door.

1. Open the door.
2. Press the rinse aid compartment release button with your finger.
3. Fully open the rinse aid compartment lid.

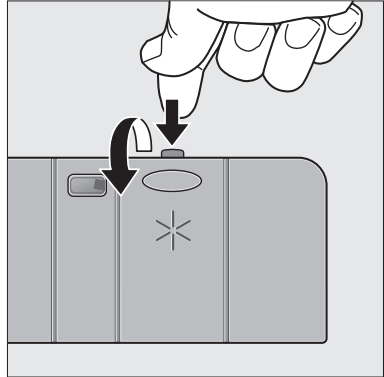

4. Fill with rinse aid exactly up to the level marked "max"; this corresponds to a quantity of approx. 140 ml.
5. Close the lid and press until it locks into place.
6. Wipe up any spilt rinse aid with a cloth. Otherwise too much foam will be formed during the wash.

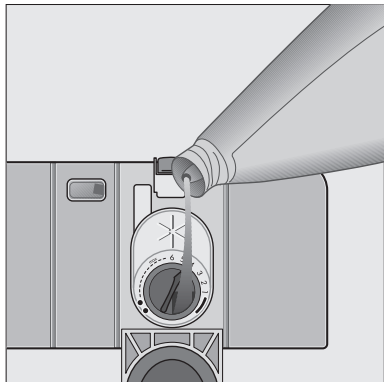

Adjusting Rinse Aid Dosing



As the dishes are washed rinse aid is released from the dispenser into the wash water. The dose is factory set at 4, and can be adjusted from 1 to 6. Only change the setting if streaks, milky spots or dried on water marks are visible on glasses or crockery.

1. Open the door of the dishwasher.
2. Press the rinse aid compartment release button with your finger.
3. Fully open the rinse aid compartment lid.
4. Set the dose level.
5. Close the lid and press until it locks into place.
6. If rinse aid has spilt, wipe up with a cloth.

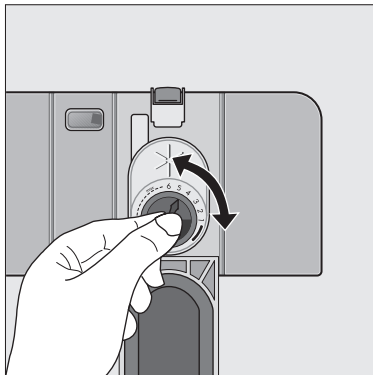

Switching the Acoustic Signal for the End of the Wash Programme On and Off

In addition to the visual indication the dishwasher can be set to emit an audible signal at the end of a wash cycle.

1. The dishwasher must be switched off.
2. Simultaneously press and hold down function buttons **1** and **2**.
3. Press the ON/OFF button. The LED displays for the engaged function buttons will flash.
4. Press function button **1**.
The multidisplay shows the current setting:

b 0	Acoustic signal switched off
b 1	Acoustic signal switched on (factory setting)

5. Pressing function button **1** changes the setting.
6. Once the multidisplay shows the required setting, press the ON/OFF button. The setting is then saved.

In Daily Use

- Check the salt and rinse aid levels.
- Load cutlery and dishes into the dishwasher
- Fill with dishwasher detergent
- Select a wash programme suitable for the cutlery and dishes
- Start the wash programme

Loading Cutlery and Dishes



Sponges, household cloths and any object that can absorb water should not be washed in the dishwasher.





For washing in the dishwasher the following cutlery/dishes

are not suitable:	are of limited suitability:
<ul style="list-style-type: none"> • Cutlery with wooden, horn, china or mother of pearl handles • Plastic items that are not heat resistant • Older cutlery with glued parts that is not temperature resistant • Bonded cutlery items or dishes • Pewter or copper items • Lead crystal glass • Steel items subject to rusting • Wooden platters • Items made from synthetic fibres 	<ul style="list-style-type: none"> • Only wash stoneware in the dishwasher if it is specifically marked as being dishwasher-safe by the manufacturer. • Glazed patterns may fade if machine washed frequently. • Silver and aluminium parts have a tendency to discolour during washing. Left-overs, e.g. egg white, egg yolk and mustard often cause discolouring and staining on silver. Therefore always clean left-overs from silver immediately, if it is not to be washed straight after use. • Some types of glass can become dull after a large number of washes.

- Before loading the dishes, you should:
 - Remove all scraps of food.
 - Soften remnants of burnt food in pans.
- When loading the dishes and cutlery, please note:
 - Dishes and cutlery must not impede the rotation of the spray arms.
 - Load hollow items such as cups, glasses, pans, etc. with the opening downwards so that water cannot collect in the container or a deep base.
 - Dishes and items of cutlery must not lie inside one another, or cover each other

- To avoid damage to glasses, they must not touch
- Do not lay small objects (e.g. lids) in the cutlery rack

Loading Cutlery

-  Long bladed knives stored in an upright position are a potential hazard.
-  Long and/or sharp items of cutlery such as carving knives must be positioned horizontally in the upper basket.
-  Take care when loading or unloading sharp items such as knives.
-  Place knives, small spoons and small forks in the cutlery tray.

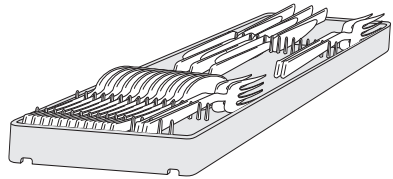

Place forks and spoons that do not fit in the cutlery tray in the cutlery basket.

To ensure that all items of cutlery in the cutlery basket are properly washed, you should

-  **1.** Place the grid insert on the cutlery rack
- 2.** Place forks and spoons in the grid insert on the cutlery basket with the handle downwards.
- 3.** For larger items of cutlery, e.g. a whisk, half of the top for the cutlery basket can be left off.

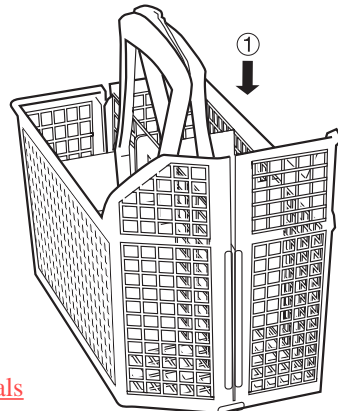
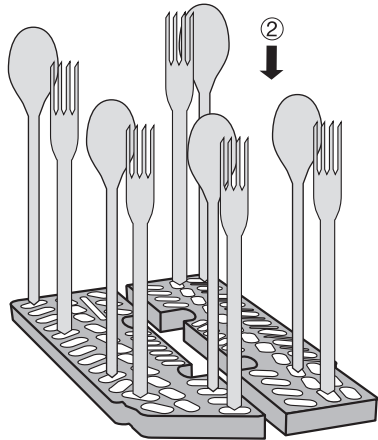

On some models of dishwasher it is possible to open the cutlery basket.



To ensure that the cutlery basket cannot open on removal from the appliance, you should always hold both parts of the two part handle.

1. Place the cutlery basket on a table or work surface
2. Open the two part handle
3. Remove cutlery
4. Close the two part handle.

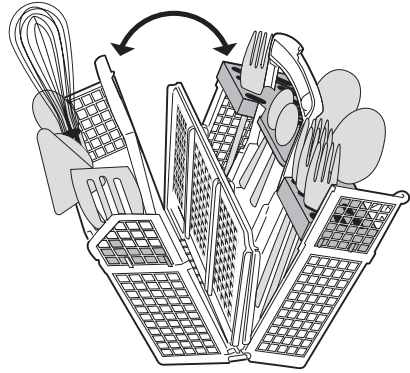

Loading Pans, Frying Pans and Large Plates

Load large and heavily soiled dishes in the lower basket (Plates up to 29cm in diameter).

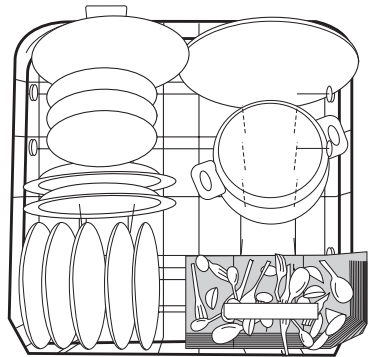

Your dishwasher has one of the following four types of lower basket:

Type 1: None of the plate inserts in the lower basket can be removed

Type 2: The right-hand plate inserts in the lower basket can be folded over to the left

i To ease the loading of large items, the two right-hand plate inserts in the lower basket can be folded over to the left

1. Slightly lift the right plate inserts.

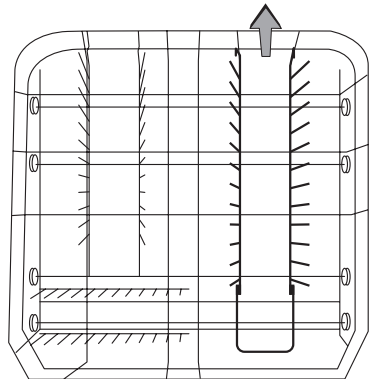

2. Fold the plate inserts to the left.

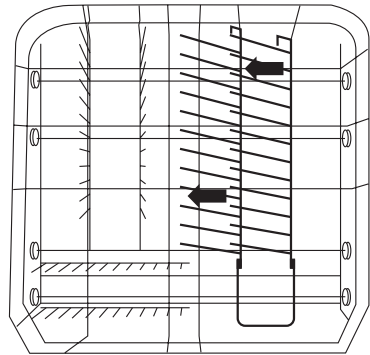

Type 3: The right-hand plate inserts in the lower basket can be folded across one another

i To ease the loading of large items, the two right-hand plate inserts in the lower basket can be folded across one another.

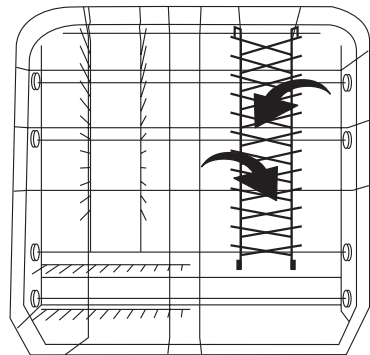

Type 4: The two rear plate inserts in the lower basket can be folded across one another



To ease the loading of large items, the two rear plate inserts in the lower baskets can be folded across one another.

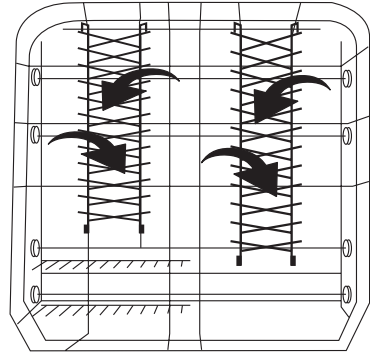

Loading Cups, Glasses and Coffee Services

Load small, delicate items and long pointed cutlery in the upper basket.

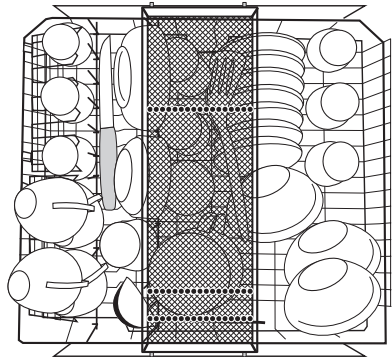

- Arrange items of crockery on the folding cups racks so that they are offset from each other and water can reach all items.
- The cup racks can be folded up out of the way for tall items.
- Lay or hang wine, champagne, and brandy glasses in the cut outs on the cup racks.
- Glasses, beakers, etc. can also be placed on the two rows of prongs on the left of the upper basket.

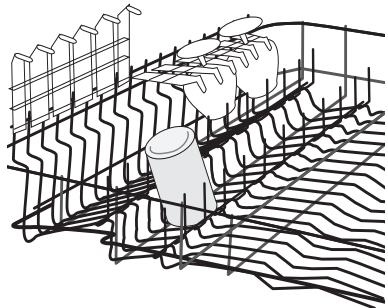

Adjusting the Height of the Upper Basket

	Maximum Height of the Dishes in the	
	Upper Basket	Lower Basket
With upper basket raised	22 cm	31 cm
With upper basket lowered	24 cm	29 cm

i The height of the basket can also be adjusted when it is loaded.

Lowering the Upper Basket:

- 1.** Pull the upper basket out completely.
- 2.** Holding the upper basket at the rear right, lift it as far as it will go and then lower it vertically. The upper basket will engage in the lower position.

Raising the Upper Basket:

- 1.** Pull the upper basket out completely.
- 2.** Holding the upper basket at the rear right, lift it as far as it will go and then lower it vertically. The upper basket will engage in the higher position.

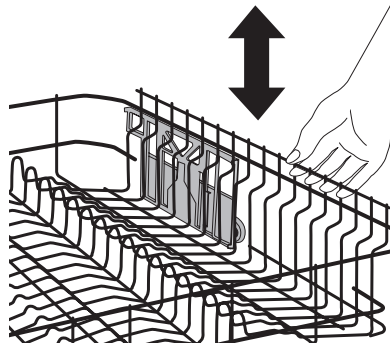

Filling with Detergent



Only use dishwasher detergent.

Fill with detergent:

– Prior to the start of a wash programme (not for the pre wash programme). The detergent is released into the wash water during the programme.



Please observe the manufacturer's dosing and storage recommendations as stated on the detergent packaging.

The detergent compartment is on the inside of the dishwasher door.



1. If the lid is closed: press release button (1). The lid springs open.

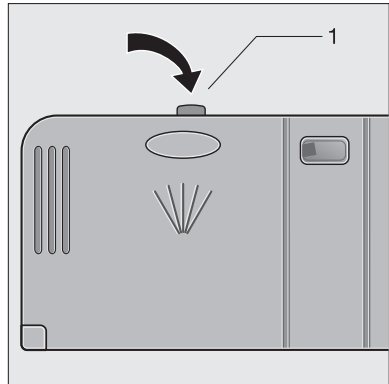

2. Fill the detergent dispenser with detergent. The markings indicate the dosing levels: "20" corresponds to approx. 20 ml of detergent, "30" corresponds to approx. 30 ml of detergent.
3. Close the lid and press until it locks into place.



If the dishes are very heavily soiled put additional detergent into the adjacent chamber (2). This detergent will take effect during the pre wash.

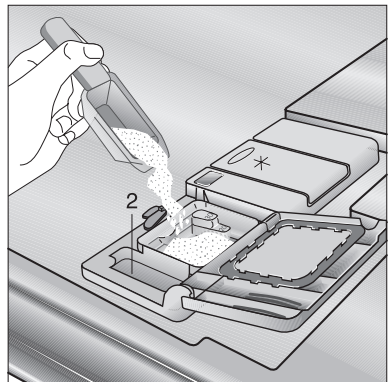

Use of "3 in 1"/ Combi Detergent Tablets

General Advice

These products are tablets with combined detergent/rinse-aid and salt functions.

-  1. Before using these products you should first check that the water hardness in your supply is compatible with the use of these products as per the detergent manufacturers instructions (on the product packaging).
2. These products should be strictly used according to the detergent manufacturers instructions.



Do not place the tablets in the tub or the cutlery basket as this will result in poorer wash results. The tablets should be placed in the detergent doser.

3. If you encounter problems when using "3 in 1" products for the first time then please contact the detergent manufacturers care line (the telephone number is given on the product packaging).

Special Advice

When using combination products, the rinse-aid and salt lights are no longer useful. It may be helpful therefore to switch the rinse aid off - please note that only some dishwashers have this facility - and selecting the lowest possible setting for water hardness.

For more information please refer to your instruction manual.

If you decide to switch to the use of a standard detergent system we advise that you:

- Refill both the salt and rinse aid compartments.
- Switch the waterhardness setting to the highest possible position and run for three normal cycles without a load.
- Readjust the waterhardness setting again according to the conditions for your region (as per the instruction manual).

Concentrated Detergent

Based on their chemical composition, dishwasher detergents can be split into two basic types:

- **conventional**, alkaline **detergents** with caustic components
- low alkaline **concentrated detergents** with natural enzymes.



The use of 50 °C wash programmes in conjunction with concentrated detergents reduces pollution and is good for your dishes; these wash programmes are specially matched to the dirt-dissolving properties of the enzymes in the concentrated detergent. For this reason 50 °C wash programmes in which concentrated detergents are used can achieve the same results that can otherwise only be achieved using 65 °C programmes.

Detergent tablets



Detergent tablets of different makes dissolve at different speeds. For this reason some detergent tablets cannot develop their full cleaning power during short programmes. Therefore please use wash programmes with pre wash when using detergent tablets.

Automatic Wash Programmes

During the AUTOMATIC programmes the amount of soiling on the dishes is determined by how cloudy the water is.

If the appliance is partially loaded and the dishes lightly soiled, the "pre wash", "main wash" and "rinsing" elements of the programme are shorter and the water consumption level is lower.

If the appliance is fully loaded and the dishes heavily soiled, the "pre wash", "main wash" and "rinsing" elements of the programme are longer and the water consumption level is higher.

For this reason the programme duration, water and energy consumption levels can vary within the stated range for AUTOMATIC programmes (see Programme Table).

In this way, the dishes are always optimally washed while water and electricity consumption are kept low.

During AUTOMATIC programmes the temperature of the wash water is also automatically adjusted to between 50 °C and 65 °C depending on the amount of soiling on the dishes.

Selecting the Wash Programme (Programme Table)

Choose the most suitable wash programme with the aid of this table:

Type of Dishes	Dinner Service and Cooking Utensils			
In Addition	-	-	-	-
Type of Soiling	<ul style="list-style-type: none"> heavily to lightly soiled dried leftovers 	<ul style="list-style-type: none"> just used, average to slightly soiled particularly suited to the use of concentrated detergents. 	<ul style="list-style-type: none"> heavily soiled dried on leftovers, particularly egg white and thickeners 	<ul style="list-style-type: none"> normally soiled dried leftovers
Suitable Wash Programme:	↓	↓	↓	↓
	AUTOMATIC	30 MINUTES¹⁾	INTENSIVE 70 °C	NORMAL 65 °C
Programme Sequence²⁾	Pre Wash Main Wash Rinsing Final Rinse Drying	- Main wash - Final rinse -	Pre Wash Main Wash 2x Rinsing Final Rinse Drying	Pre Wash Main Wash Rinsing Final Rinse Drying
Consumption Figures:³⁾	↓	↓	↓	↓
Duration	95 - 115 minutes	30 min.	110 - 120 minutes	89 - 99 minutes
Energy	1,10 - 1.35 kWh	0.8 kWh	1.75 - 1.95 kWh	1.05 - 1.25 kWh
Water	11,5 - 19 litres	8 litres	19 - 21 litres	14 - 16 litres

¹⁾ This programme is not suitable when left-overs have dried on.

²⁾ The various stages in the wash programme have different sounds; this is because the dishes are washed more intensely for short periods during certain stages of the wash programme to improve cleaning.

³⁾ The consumption figures were measured under standard conditions. They are intended as a guide only as variations can occur during normal usage.

Type of Dishes	Dinner Service and Cooking Utensils		Dessert Dishes and Coffee Service	All Types of Dishes
In Addition	with non-temperature resistant dishes		with delicate glasses	-
Type of Soiling	<ul style="list-style-type: none"> normally soiled <p style="text-align: center;">particularly suited to the use of concentrated detergents.</p>		<ul style="list-style-type: none"> lightly soiled 	Used dishes that are collected in the dishwasher and are to be washed at a later point in time.
Suitable Wash Programme:	↓	↓	↓	↓
	NORMAL 50 °C	ENERGY SAVING 50 °C ^{4) 5)}	GLASS 40 °C	PRE WASH
Programme Sequence ²⁾	Pre Wash Main Wash Rinsing Final Rinse Drying	Pre Wash Main Wash Rinsing Final Rinse Drying	- Main Wash Rinsing Final Rinse -	Pre Wash - - - -
Consumption Figures: ³⁾	↓	↓	↓	↓
Duration	84 - 94 minutes	130 - 150 minutes	35 minutes	12 minutes
Energy	1.05 - 1.15 kWh	0.95 - 1.05 kWh	0.7 kWh	< 0.1 kWh
Water	14 - 65 litres	12 - 14 litres	11 litres	4 litres

⁴⁾ The "ENERGY SAVING" wash programme washes normally soiled dishes with a very low electricity consumption. If the dishes need to be washed more quickly, as an alternative you can use the "NORMAL 50" wash programme.

⁵⁾ Test programme for test institutes.

Starting the Wash Programme

-  **1.** Check that when the dishes and cutlery are loaded into the dishwasher the spray arms are free to rotate.
- 2.** Open the tap fully.
- 3.** Shut the door.
- 4.** Press the ON/OFF button The ON/OFF button indicator illuminates.
- 5.** Press the button for the programme required (see "Programme Table"). The programme indicator and the associated wash programme steps in the programme progress display illuminate. After around 6 seconds, the wash programme selected starts. The remaining time for the programme calculated from quantity of dishes loaded is displayed in the multi-display. With automatic programme adjustment this residual time count can be stopped or corrected if necessary (load quantity, degree of dirtiness, etc.) using the dishwasher control. The current programme step is also displayed in the programme progress display.

 If fault messages are displayed on the multi-display after the start of the programme, please read the "What to do, if..." section.

Changing/Interrupting/Cancelling the Wash Programme

Changing the wash programme

 To change the wash programme within the first 6 seconds after the selection of the programme, briefly press the button for the required programme.

To change the wash programme at a later point in time, use the following procedure:

-  **1.** Press the button for the new wash programme and keep it pressed. The indicators for both wash programmes now flash.
- 2.** After a few seconds, only the display for the new wash programme flashes. Release the programme button, the new wash programme is now carried out.

Interrupting the wash programme by opening the door of the dishwasher



Hot steam may escape when the door is opened. Open the door carefully.

1. Open the door of the dishwasher. The wash programme stops.
2. Shut the door. The wash programme continues.

Canceling the wash programme

1. Press the button for the wash programme in progress and keep it pressed. The programme indicator for the wash programme in progress flashes for a few seconds and then goes out.
2. Release the programme button, the wash programme is stopped.

Pause Function

The wash programme can be interrupted for a short period by using the Pause function:

1. Press the ON/OFF button. The wash programme stops.
2. All indicators go out.
3. If after a short period the wash programme is to be continued, press the ON/OFF button again. The wash programme continues.



The wash programme should not be interrupted for an extended period of time, as otherwise the wash water will cool down and need to be reheated thus increasing the electricity consumption.

Setting or Changing the Delay Start Timer

Using the delay start timer you can:

1. Press the ON/OFF button.
2. Press the DELAY TIMER button until the required delay (in hours) is flashing on the multi-display.
3. Press the button for the desired wash programme. The multi-display now displays the number of hours until the wash programme starts.
4. The wash programme starts automatically at the end of the time delay set.

Changing the delay start:

As long as the wash programme has not started, you can change the delay start set by pressing the DELAY TIMER button.

Load Sensing – Sensor Logic

If a wash programme is started even though there are only a few dishes in the upper and/or lower basket, an intelligent electronic system adjusts the amount of water and the duration of the wash programme to the number of dishes. By this means it is possible to wash only a few dishes quickly and economically. At half load (6 place settings), up to 2 litres of water and 0.2 kWh of electricity are saved.

Switching Off the Dishwasher

Switch the dishwasher off when the multi-display indicates "0" for the remaining programme time and **END** is illuminated on the programme progress display.

If the acoustic signal has been switched on there will be a continuous signal for 5 seconds at the end of the wash programme.

-  **1.** Press the ON/OFF button.
All indicators will go out.



Hot steam may escape if the door is opened immediately after the end of the programme.

- 2.** Open the door carefully, as steam may escape.

If the dishwasher is not switched off, the acoustic signal is repeated after 10 minutes.

Emptying the Dishwasher



- Hot dishes can be sensitive to knocks. The dishes should therefore be allowed to cool down before removing them from the appliance.
- Leave the dishes in the dishwasher for approx. 15 minutes after the end of the programme so that they dry better and can cool down.
- Empty the lower rack first, then the upper rack. This will avoid any water left on the upper rack dripping onto the dishes in the lower rack and causing water spots.

Care and Cleaning



Do not under any circumstances use furniture care products or aggressive cleaners.

- If necessary, clean the controls only with a soft cloth and pure warm water.
- Occasionally check the internal containers, door seal, and water inlet for soiling, clean if necessary.

Cleaning the Filter



The filters should be checked and cleaned regularly. Dirty filters will give poor wash results.



1. Open the door, remove the lower basket.
2. The dishwasher filter system comprises a coarse/fine filter, microfilter and a flat filter. Unlock the filter system using the handle on the microfilter, and remove.
3. Turn the handle about $\frac{1}{4}$ a turn anti-clockwise and remove.
4. Take hold of the coarse/fine filter (1/2) by the handle with the hole and remove from the microfilter (3)
5. Clean all filters thoroughly under running water.
6. Remove the flat filter (4) from the base of the washing compartment and clean both faces thoroughly

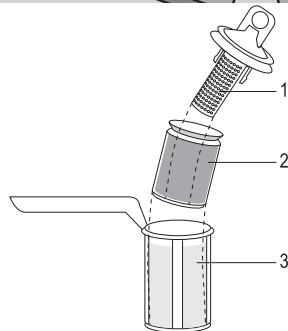
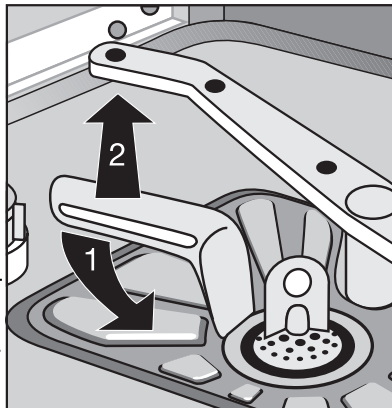

7. Put the flat filter back in the base of the washing compartment
8. Place the coarse/fine filter in the microfilter and press together.
9. Put the filter combination in place and lock by turning the handle clockwise to the stop. During this process ensure that the flat filter does not protrude above the base of the washing compartment.



The dishwasher must not be used without filters under any circumstances.

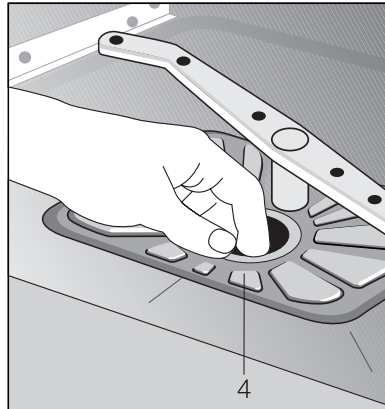

What to do, if ...

Try to rectify minor faults on the dishwasher with the aid of the instructions given here. If you call an engineer to resolve a of fault listed here, or to repair a fault caused by incorrect use or installation, a charge will be made even if the appliance is in guarantee.

...Error messages

- If the multi-display indicates the fault code **E2**, or the **WATER**, **DOOR** or **SPRAY ARM** indicator illuminates, you can probably rectify the fault yourself. After rectifying a **E2** fault or a fault related to the **WATER** indicator, press the button for the wash programme that has been started. The wash programme should continue. If the fault code is displayed again, contact AEG Service Force.
- For all other faults that are indicated, please contact AEG Service Force stating the fault code.

Symptom	Possible Cause	Solution
The programme indicator for the programme selected is flashing, the WATER indicator is illuminated and 1 warning tone can be heard that is continually repeated: no water is running into the dishwasher.	Tap is blocked or furred with lime-scale.	Clean tap.
	The filter (where present) in the threaded hose fitting is blocked.	Clean the filter in the threaded hose fitting.
	The water inlet hose is not correctly laid.	Check hose installation.
The programme indicator for the selected programme is flashing, the multi-display is indicating the fault code E2 and 2 warning tones can be heard that are continually repeated.	The sink outlet is blocked.	Clean the sink outlet.
	The water drain hose is not correctly laid.	Check hose installation.
The multi-display is indicating the fault code E3 and 3 warning tones can be heard that are continually repeated.	The anti-flood system has been triggered.	Close the tap and contact your local AEG Service Force Centre.

Symptom	Possible Cause	Solution
During a wash programme the SPRAY ARM indicator illuminates at irregular intervals and 1 longer warning tone can be heard at the same time.	The middle spray arm is jammed.	Open the door carefully , as hot steam can escape when the door is opened. There is a risk of scolding! Place the dishes and cutlery in the lower basket in such a way that the middle spray arm can rotate freely. Close the door of the dishwasher.
The DOOR indicator is illuminated	The door of the dishwasher is open.	Close the door of the dishwasher.
The FILTER indicator is illuminated.	The FILTER indicator illuminates at regular intervals to remind you to check and clean the filter in the dishwasher from time.	The indicator goes out automatically on the start of the next wash programme.

...there are problems with the operation of the dishwasher.

Symptom	Possible Cause	Solution
The programme does not start.	The door of the dishwasher is not closed properly.	Shut the door.
	Mains plug is not plugged in.	Insert mains plug.
	House fuse is defective.	Replace fuse.
	A delay start is selected.	If the dishes are to be washed immediately, set the delay start to 0 hours
Rust spots are visible in the washing compartment.	The washing compartment is made of corrosion-resistant stainless steel. Rust spots in the washing compartment are from particles from outside the appliance (rust particles from the water pipe, from pans, cutlery, etc.). Remove such spots with a commercially available stainless steel cleaner.	Only wash cutlery and dishes that are suitable for dishwasher use. Close the lid of the special salt container securely.
There is a whistling noise during washing.	The whistling is not a cause for concern.	Use a different brand of detergent.
Dishwasher interior lighting does not work.	Mains plug is not plugged in.	Insert mains plug.
	Light bulb for the interior lighting is defective.	Contact AEG Service Force.

...the wash result is not satisfactory.

The dishes are still dirty.

- The wrong wash programme was selected.
- The dishes were arranged in such a manner that water has not reached all parts. The dish racks must not be overloaded.
- The filter in the base of the washing compartment is dirty or incorrectly positioned.
- Detergent was not used or too little was used.
- In the case of scale deposits on the dishes: the special salt container is empty or the water softener is incorrectly adjusted.
- The drain hose is incorrectly laid.

The dishes are wet and dull.

- Rinse aid was not used.
- The rinse aid container is empty.

There are streaks, milky spots or a bluish coating on glasses and dishes.

- Decrease rinse aid dosing.

There are dried water drops on the glasses and dishes.

- Increase rinse aid dosing.
- The detergent may be the cause. Contact the detergent manufacturer's consumer advisor.

Technical Data

Capacity:	12 place settings including serving dishes
Permitted Water Pressure:	1-10 bar (=10-100 N/cm ² = 0.1-1.0 MPa)
Electrical Connection:	Information on the electrical connection is given on the rating plate on the inner edge of the dishwasher door on the right.

Dishwasher: Free-Standing Appliances

Dimensions:	850 x 600 x 600 (H x W x D in mm)
Max. Weight:	54 Kg

Dishwashers that Can Be Integrated, Built-In Dishwashers

Dimensions:	820 – 880 x 596 x 570 (H x W x D in mm)
Max. Weight:	50 Kg

Dishwashers that Can Be Fully Integrated

Dimensions:	820 – 880 x 596 x 546 – 550 (H x W x D in mm)
Max. Weight:	50 Kg

CE This appliance conforms with the following EU Directives:

- 73/23/EEG dated 19. 02. 1973 – Low Voltage Directive
- 89/336/EEG dated 03. 05. 1989
(including Directive Amendment 92/31/EEG) – EMC Directive

Notes for Test Institutes

Testing in accordance with EN 60704 must be carried out with the appliance fully loaded and using the test programme (see Programme Table).

Tests in accordance with EN 50242 must be carried out when the salt dispenser and rinse aid container have been filled with salt and rinse aid respectively and using the test programme (see Programme Table).

	Full Load: 12 place settings incl. serving dishes	Half Load: 6 place settings incl. serving dishes, leaving alternate positions free
Detergent Dosing:	5g + 25g (Type B)	20g (Type B)
Rinse Aid Setting:	4 (Type III)	4 (Type III)

Sample loading arrangements:

Upper basket without cutlery tray

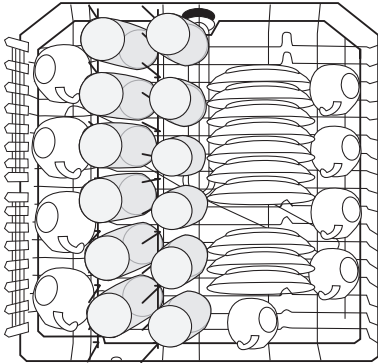

Upper basket with cutlery tray

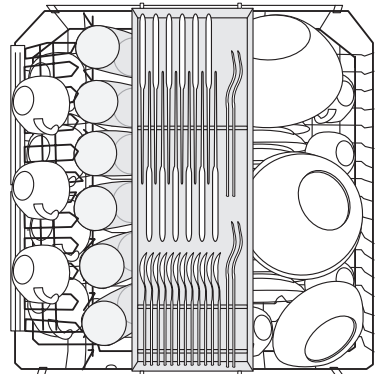

Lower basket with cutlery basket

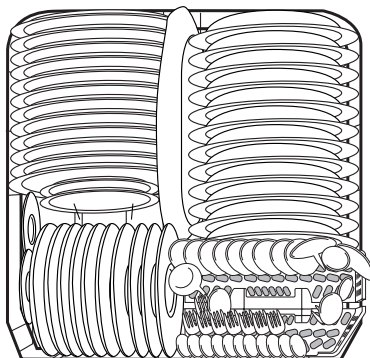

Cutlery basket

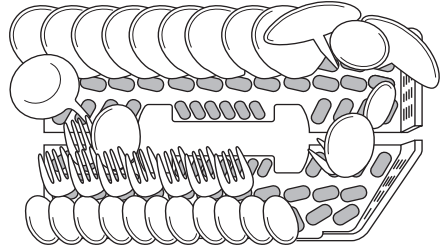

INSTALLATION AND CONNECTION INSTRUCTIONS

Installing the Dishwasher

- The dishwasher must be installed on a firm floor and adjusted such that it is stable and level.
- To compensate for unevenness in the floor and to match the height of the appliance to that of surrounding units extend the threaded feet by unscrewing:
 - use a screwdriver.

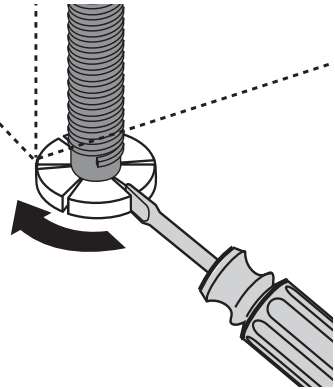

- For built-in dishwashers the rear feet should be adjusted from the front of the appliance using a screwdriver.
- The drain hose, inlet hose and mains cable must be laid such that they are free to move in the rear of the plinth recess, so that they cannot be kinked or crushed.

Built-Under Dishwasher

(see enclosed installation instructions)

Free-Standing Appliances

can be set up as stand-alone without additional installation.



If the dishwasher is set up next to a gas or coal cooker, a heat-insulating, non-flammable plate must be mounted between the dishwasher and the cooker, flush to the top edge of the work surface (depth 57.5 cm). The plate should have aluminium foil on the side facing the cooker.

If the dishwasher is installed underneath a kitchen work surface, the original work surface of the dishwasher is to be removed as follows:

-  **1.** Unscrew the screws from the positioning plates on the back (1).

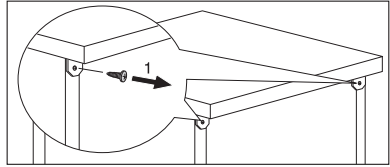

- 2.** Slide the appliance's work surface approx. 1 cm to the rear (2).

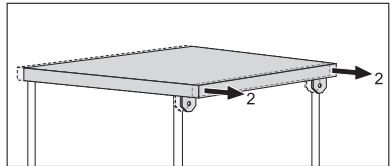

- 3.** Lift the work surface at the front (3) and remove.

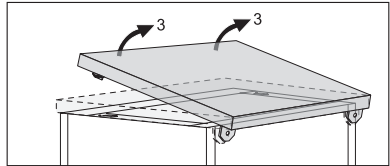

If the dishwasher is later used as a free-standing appliance, the original work surface must be re-mounted.



The plinth on free-standing appliances is not adjustable.

Connecting the Dishwasher

Water Connection

The dishwasher is fitted with safety devices that prevent the wash water returning into the drinking water system and comply with the applicable plumbing regulations.

- The dishwasher must be connected to a cold water supply.
- The dishwasher **must not** be connected to open hot water appliances or instantaneous water heaters.

Permitted water pressure

Lowest permitted water pressure: 1 bar (=10 N/cm ² =100 kPa)	Consult your installer if the water pressure is less than 1 bar.
Highest permitted water pressure: 10 bar (=100 N/cm ² =1 MPa)	In the case of a water pressure greater than 10 bar, a pressure reduction valve must be used (available from your dealer).

Connect the inlet hose



The water inlet hose must not be kinked, crushed or entangled when it is being connected up.



Connect the threaded hose fitting (ISO 228-1:2000) on the water inlet hose to a tap with an external thread (3/4 inch). Tighten the threaded hose fitting **hand tight only**.



- In order that access to the tap in the kitchen is not limited by the use of the dishwasher, we recommend the installation of an additional tap, or fitting a two way adapter to the existing tap.
- If you need a longer water inlet hose than that supplied, VDE approved complete hose sets are to be used. These are available from your local Service Force Centre.
- Do not use, for connection, old hoses which have been used for another appliance.



The following section is only applicable to dishwashers that have a safety valve on the threaded hose fitting for the tap:

Water inlet hose with safety valve

After connecting the double-walled water inlet hose, the safety valve is next to the tap. Therefore the water inlet hose is only under pressure while the water is running. If the water inlet hose starts to leak during this operation, the safety valve cuts off the running water and the draining pump in the dishwasher is switched on.



Please take care when installing the water inlet hose:

- The distance between the bottom edge of the safety valve and the floor on which the dishwasher is standing must be at least 30 cm:
- The electrical cable for the safety valve is in the double-walled water inlet hose. Do not immerse the water inlet hose or the safety valve in water.
- If the water inlet hose or the safety valve is damaged, remove the mains plug immediately.
- A water inlet hose with safety valve must only be replaced by your local Service Force Centre.
- Place the water inlet hose in such a way that it is never higher than the bottom edge of the safety valve.

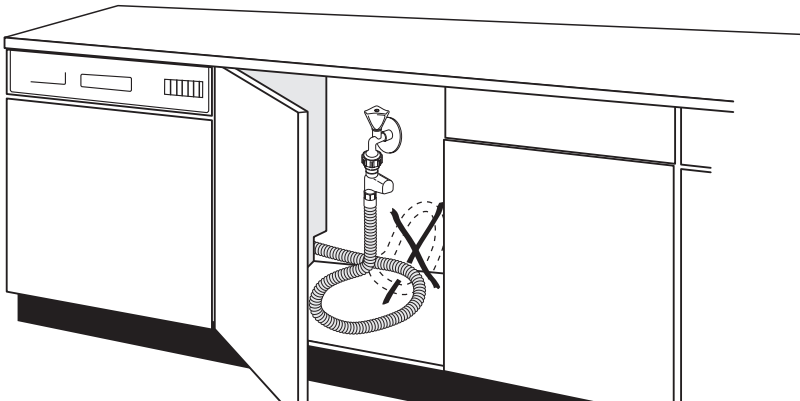
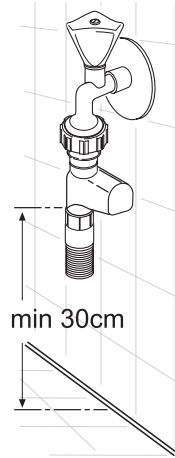

Water drain

Drain hose



The drain hose must not be kinked, crushed or entangled.

- Connecting the drain hose:
 - Maximum permitted height: 1 metre.
 - Minimum required height 40 cm above the lower edge of the machine.

Extension hoses

- Extension hoses are available from AEG Service Force. The internal diameter of the extension hoses must be 19 mm to ensure that the function of the appliance is not impeded.
- Hoses may be laid a maximum of 3 metres horizontally; the maximum permitted height for the connection for the drain hose is then 85 cm.

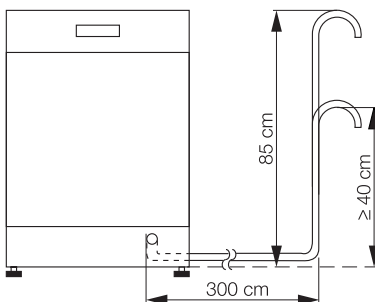

Sink outlet connection

- The outlet of the drain hose (\varnothing 19 mm) fits all commonly available sink outlet spigot types. The outer diameter of the spigot connection must be at least 15 mm.
- The drain hose must be fixed to the sink outlet connection using the hose clamp supplied.

If the dishwasher is fitted at a high position

If the dishwasher is installed at a high level, and the drain hose connection is less than 30 cm from the bottom of the appliance, adapter kit ET 111099520 must be fitted. This is available from Customer Service.

Discharging into a standpipe

When discharging into a standpipe, the upright standpipe should have a minimum, length of 30 cm (12") from the bottom of the elbow to the top of the pipe (see diagram). Make sure that it is designed in such a way that the end of the drain hose cannot be covered with water.

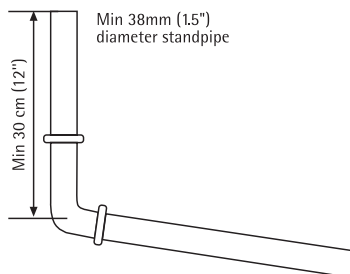

Leak Prevention System

For protection from damage due to water leaks, the dishwasher is equipped with a leak prevention system, the AQUA CONTROL SYSTEM. In the event of a fault, the safety valve immediately interrupts the supply of water to the appliance and the drain pump switches on. It is thus not possible for water to either leak or overflow. Any water left in the appliance is automatically pumped out.



The AQUA CONTROL SYSTEM also works when the appliance is switched off – the appliance must however **not** be disconnected from the mains. When the appliance is switched on, a buzzing tone can also be heard.

Electrical Connection

Any electrical work required to install this appliance should be carried out by a qualified electrician or competent person.



WARNING - This appliance must be earthed.
The manufacturer declines any responsibility should these safety measures not be observed.

Before switching on make sure the electricity supply voltage is the same as that indicated on the appliance rating plate.

To isolate the dishwasher from the mains, remove the mains plug.

Important: The plug must still be accessible after the appliance has been installed.

Changing a fuse

The appliance is supplied with a 13amp plug fitted. In the event of having to change the fuse in the plug supplied, a 13amp ASTA approved (BS 1363A) fuse must be used.

Should the plug need to be replaced for any reason, proceed as described below.

The wires on the mains lead are coloured in accordance with the following code.

Green and Yellow : Earth
Blue : Neutral
Brown : Live

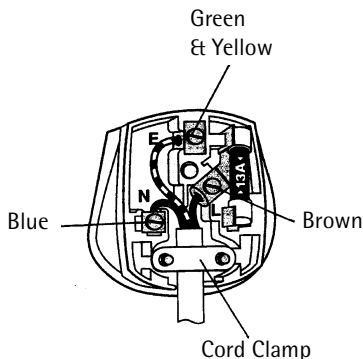

- The wire coloured green and yellow must be connected to the terminal marked with the letter "E" or by the earth symbol \oplus or coloured green and yellow.
- The wire coloured blue must be connected to the terminal "N" or coloured black.
- The wire coloured brown must be connected to the terminal marked "L" or coloured red.
- Upon completion there must be no cut, or stray strands of wire present and the cord clamp must be secure over the outer sheath.



WARNING! A cut off plug inserted into a 13 amp socket is a serious safety (shock) hazard. Ensure that, if it is necessary to cut off the plug, it is disposed of safely and not retained.

Connections

The water inlet and drain hoses, as well as the mains cable must be connected beside the dishwasher as there is insufficient space behind the appliance.

The plumbing and electrical installation example given below can only be regarded as a recommendation.

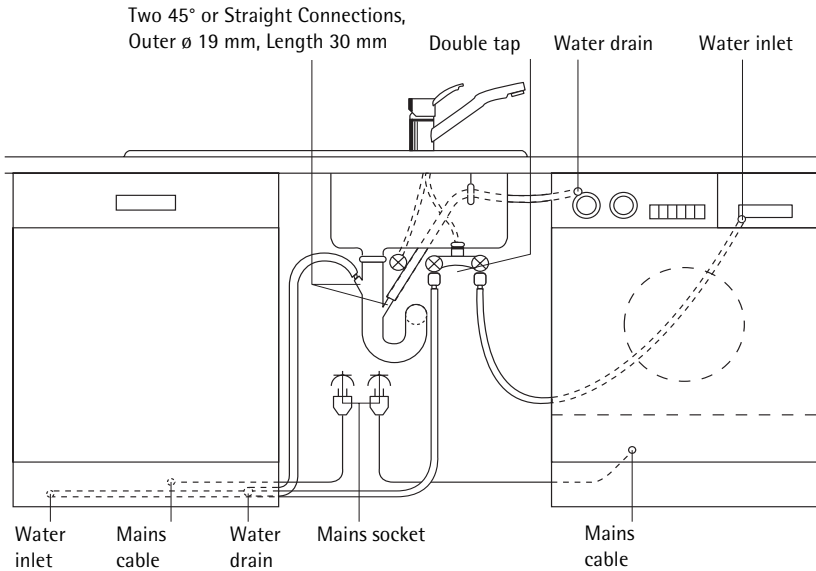

GUARANTEE CONDITIONS

Standard guarantee conditions

We, AEG, undertake that if within 12 months of the date of the purchase this AEG appliance or any part thereof is proved to be defective by reason only of faulty workmanship or materials, we will, at our discretion repair or replace the same FREE OF CHARGE for labour, materials or carriage on condition that:

- The appliance has been correctly installed and used only on the electricity or gas supply stated on the rating plate.
- The appliance has been used for normal domestic purposes only, and in accordance with the manufacturer's operating and maintenance instructions.
- The appliance has not been serviced, maintained, repaired, taken apart or tampered with by any person not authorised by us.
- All service work under this guarantee must be undertaken by a Service Force Centre. Any appliance or defective part replaced shall become the Company's property.
- This guarantee is in addition to your statutory and other legal rights.
- Home visits are made between 8.30am and 5.30pm Monday to Friday. Visits may be available outside these hours in which case a premium will be charged.

Exclusions

This guarantee does not cover:

- Damage or calls resulting from transportation, improper use or neglect, the replacement of any light bulbs or removable parts of glass or plastic.
- Costs incurred for calls to put right an appliance which is improperly installed or calls to appliances outside the United Kingdom.
- Appliances found to be in use within a commercial environment, plus those which are subject to rental agreements.
- Products of AEG manufacture which are not marketed by AEG.

European Guarantee

If you should move to another country within Europe then your guarantee moves with you to your new home subject to the following qualifications:

- The guarantee starts from the date you first purchased your product.
- The guarantee is for the same period and to the same extent for labour and parts as exists in the new country of use for this brand or range of products.
- This guarantee relates to you and cannot be transferred to another user.
- Your new home is within the European Community (EC) or European Free Trade Area.
- The product is installed and used in accordance with our instructions and is only used domestically, i.e. a normal household.
- The product is installed taking into account regulations in your new country.

Before you move please contact your nearest Customer Care centre, listed below, to give them details of your new home. They will then ensure that the local Service Organisation is aware of your move and able to look after you and your appliances..

France	Senlis	+33 (0) 3 44 62 29 29
Germany	Nürnberg	+49 (0) 800 234 7378
Italy	Pordenone	+39 (0) 800 117511
Sweden	Stockholm	+46 (0) 8 672 5360
UK	Slough	+44 (0) 1753 219899

SERVICE AND SPARE PARTS

In the event of your appliance requiring service, or if you wish to purchase spare parts, please contact Service Force by telephoning:

08705 929 929

Your telephone call will be automatically routed to the Service Force Centre covering your post code area.

For the address of your local Service Force Centre and further information about Service Force, please visit the website at www.serviceforce.co.uk

Before calling out an engineer, please ensure you have read the details under the heading „What to do if....“

When you contact the Service Force Centre you will need to give the following details:

1. Your name, address and post code.
2. Your telephone number
3. Clear and concise details of the fault.
4. The model and serial number of the appliance (found on the rating plate).

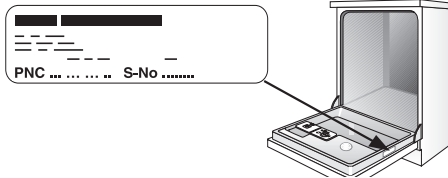

5. The purchase date

Please note that a valid purchase receipt or guarantee documentation is required for in-guarantee service calls.

Customer Care

For general enquiries concerning your AEG appliance or for further information on AEG products please contact our Customer Care Department by letter or telephone at the address below or visit our website at www.aeg.co.uk.

Customer Care Department
 AEG Domestic Appliances
 55-77 High Street
 Slough
 Berkshire, SL1 1DZ
 Tel. 08705 350350 (*)

(*) Calls may be recorded for training purposes

 **From the Electrolux Group. The world's No. 1 choice.**

The Electrolux Group is the world's largest producer of powered appliances for kitchen, cleaning and outdoor use. More than 55 million Electrolux Group products (such as refrigerators, cookers, washing machines, vacuum cleaners, chain saws and lawn mowers) are sold each year to a value of approx. USD 14 billion in more than 150 countries around the world.

AEG Hausgeräte GmbH
Postfach 1036
D-90327 Nürnberg

<http://www.aeg.hausgeraete.de>

© Copyright by AEG

822 946 398 -00- 0303

Subject to change without notice

[Downloaded from DishWasher-Manual.com Manuals](#)