

# OxyBalance

## Oxygen Display and Averaging System





# Table of Contents

	Essential Instructions . . . . .	i
	Preface . . . . .	ii
	Definitions . . . . .	ii
	Symbols . . . . .	ii
<b>SECTION 1</b>		
<b>Description</b>	Component Checklist . . . . .	1-1
	Part Numbers . . . . .	1-1
	System Overview . . . . .	1-2
	General . . . . .	1-2
	OxyBalance System Features . . . . .	1-2
	Physical Description . . . . .	1-3
	Specifications . . . . .	1-5
<b>SECTION 2</b>		
<b>Installation</b>	Overview . . . . .	2-1
	System Considerations . . . . .	2-1
	Mounting . . . . .	2-2
	Wiring Connections . . . . .	2-2
	Setup . . . . .	2-2
	. . . . .	2-4
<b>SECTION 3</b>		
<b>Setup</b>	Overview . . . . .	3-1
	Setup . . . . .	3-1
	Login . . . . .	3-2
	Setup . . . . .	3-4
	Current . . . . .	3-7
	Trend . . . . .	3-9
	Alarm . . . . .	3-10
<b>SECTION 4</b>		
<b>Calibration</b>	OxyBalance Calibration . . . . .	4-1
<b>SECTION 5</b>		
<b>Maintenance and Service</b>	Overview . . . . .	5-1
	PanelView Plus 600 . . . . .	5-1
	PanelView Removal . . . . .	5-2
	PanelView Installation . . . . .	5-4
	MicroLogix 1200 Programmable Controllers . . . . .	5-6
	PLC Removal . . . . .	5-6
	PLC Replacement . . . . .	5-8
	I/O Module Removal . . . . .	5-9
	I/O Module Replacement . . . . .	5-9
<b>SECTION 6</b>		
<b>Troubleshooting</b>	Overview . . . . .	6-1
	Probe Failure . . . . .	6-1

<b>SECTION 7</b> <b>Recommended Spare Parts</b>	Spare Parts Listing . . . . .	7-1
<b>SECTION 8</b> <b>Optional Accessories</b>		
<b>APPENDIX A</b> <b>Safety Data</b>	Safety Instructions . . . . .	A-2
<b>SECTION B</b> <b>Returning Equipment to the Factory</b>	Returning Material . . . . .	B-1

## OxyBalance

### Oxygen Display and Averaging System

#### READ THIS PAGE BEFORE PROCEEDING!

#### ESSENTIAL INSTRUCTIONS

Emerson process Management designs, manufactures and tests its products to meet many national and international standards. Because these instruments are sophisticated technical products, **you MUST properly install, use, and maintain them** to ensure they continue to operate within their normal specifications. The following instructions **MUST be adhered to** and integrated into your safety program when installing, using, and maintaining Rosemount Analytical products. Failure to follow the proper instructions may cause any one of the following situations to occur: Loss of life; personal injury; property damage; damage to this instrument; and warranty invalidation.

- **Read all instructions** prior to installing, operating, and servicing the product.
- If you do not understand any of the instructions, **contact your Rosemount Analytical representative** for clarification.
- **Follow all warnings, cautions, and instructions** marked on and supplied with the product.
- **Inform and educate your personnel in the proper installation, operation, and maintenance of the product.**
- **Install your equipment as specified in the Installation Instructions of the appropriate Instruction Manual and per applicable local and national codes.** Connect all products to the proper electrical and pressure sources.
- To ensure proper performance, **use qualified personnel** to install, operate, update, program, and maintain the product.
- When replacement parts are required, ensure that qualified people use replacement parts specified by Rosemount Analytical. Unauthorized parts and procedures can affect the product's performance, place the safe operation of your process at risk, **and VOID YOUR WARRANTY.** Look-alike substitutions may result in fire, electrical hazards, or improper operation.
- **Ensure that all equipment doors are closed and protective covers are in place, except when maintenance is being performed by qualified persons, to prevent electrical shock and personal injury.**

The information contained in this document is subject to change without notice.

## CAUTION

If a Model 275/375 Universal HART® Communicator is used with this unit, the software within the Model 275/375 may require modification. If a software modification is required, please contact your local Emerson process Management Service Group or National Response Center at 1-800-433-6076 or 1-888-433-6829.

## PREFACE

The purpose of this manual is to provide information concerning the components, functions, installation and maintenance of the OxyBalance Oxygen Display and Average System.

Some sections may describe equipment not used in your configuration. The user should become thoroughly familiar with the operation of this module before operating it. Read this instruction manual completely.

## DEFINITIONS

The following definitions apply to WARNINGS, CAUTIONS, and NOTES found throughout this publication.

## WARNING

Highlights an operation or maintenance procedure, practice, condition, statement, etc. If not strictly observed, could result in injury, death, or long-term health hazards of personnel.





## CAUTION

Highlights an operation or maintenance procedure, practice, condition, statement, etc. If not strictly observed, could result in damage to or destruction of equipment, or loss of effectiveness.

## NOTE

Highlights an essential operating procedure, condition, or statement.

## SYMBOLS

-  : EARTH (GROUND) TERMINAL
-  : PROTECTIVE CONDUCT OR TERMINAL
-  : RISK OF ELECTRICAL SHOCK
-  : WARNING: REFER TO INSTRUCTION MANUAL

## NOTE TO USERS

The number in the lower right corner of each illustration in this publication is a manual illustration number. It is not a part number, and is not related to the illustration in any technical manner.

## Section 1 Description

<b>Component Checklist</b> .....	<b>page 1-1</b>
<b>Part Numbers</b> .....	<b>page 1-1</b>
<b>System Overview</b> .....	<b>page 1-2</b>
<b>Specifications</b> .....	<b>page 1-5</b>

### COMPONENT CHECKLIST

A typical Rosemount Analytical OxyBalance Oxygen Display and Averaging System package should contain the items shown in Figure 1-1.

### PART NUMBERS

Use the part numbers listed in Table 1-1 to verify your OxyBalance system part number. Copy the part number and serial number from the OxyBalance unit into the chart on the back cover of this manual. Refer to this complete part number for any correspondence with Emerson Process Management.

Table 1-1. OxyBalance System Part Numbers

Part Number	Description
6A00203G01	1-4 probes, NEMA 4X enclosure
6A00203G02	5-8 probes, NEMA 4X enclosure
6A00203G03	1-4 probes, plate mounted
6A00203G04	5-8 probes, plate mounted

Figure 1-1. Typical System Package

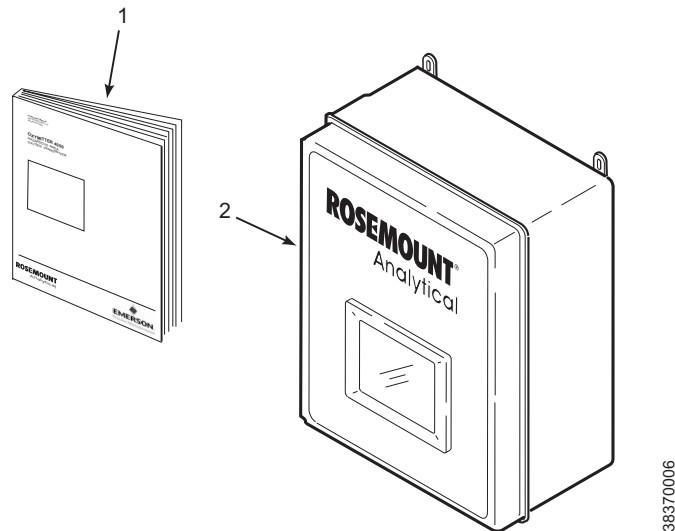

1. Instruction Manual
2. OxyBalance Oxygen Display and Averaging System

## SYSTEM OVERVIEW

### General

The OxyBalance is a display and averaging system that augments the Oxymitter O<sub>2</sub> probe product line. It receives up to (8) 4-20 mA signals from Rosemount, Westinghouse, or other O<sub>2</sub> probes, and calculates and transmits up to 4 additional programmable averages (again 4-20 mA). The OxyBalance system also displays the individual and averaged outputs on a color touch screen graphic panel. Trend screens, bar graphs (individual probes only), and alarming indications are provided when a probe goes off line.

The OxyBalance system replaces much of the functionality of older averaging systems offered by Westinghouse and Rosemount - the Control Room Electronics (CRE), 1500 Controller-based averaging systems, and the Veritrak-based 1290 systems. It should be noted, however, that the heater control and signal conditioning for each individual probe is executed within separate electronics for each probe. Unlike past averaging systems, and most current competitive averaging systems, there is no component failure in the OxyBalance system that will cause the loss of individual probe signals.

The OxyBalance system senses 4-20 mA inputs automatically. Averages are very easy to set up. Any probes that may fail will default to a 3.5 mA signal level, indicate in red, and the OxyBalance system will remove these probes from the average. Likewise, probes that are in calibration will indicate blue, and provide a contact closure to the OxyBalance system to remove them from the average while calibrating.

Trends offer adjustable scaling, three time spans (5 min., 8 hrs., and 24 hrs.), and panning capability back and forth in history.

### OxyBalance System Features

The standard OxyBalance system includes the following features:

- Graphically displays and trends from 1 to 8 O<sub>2</sub> measurements.
- Probe inputs may be from Rosemount Analytical, Westinghouse or any competitive O<sub>2</sub> probe with a 4-20 mA signal output.
- Generates up to four 4-20 mA signals as programmable averages.
- Failed or calibrating probes are automatically removed from the average
- Individual probe readings remain autonomous and are unaffected by any potential failure of the OxyBalance system.
- Variable time scale trends for each individual probe value, as well as for up to 4 averages.
- Password protection for set up menus.



## Physical Description

Aside from the PanelView Plus 600, the OxyBalance system consists of additional components mounted on three DIN rails. The main components are shown in Figure 1-2.

### PanelView Plus 600

The PanelView Plus 600 is the touch screen interface located on the front of the OxyBalance system, all probe readings and averages are displayed through this interface. There is also a power cord and communications cord that connect to this module.

### MicroLogix 1200 Programmable Logic Controller

#### PLC

The PLC process the raw data received by the OxyBalance. The processed data is transmitted to the PanelView Plus 600, where it is displayed on the touch screen interface.

#### I/O Modules

Also known as the expansion I/O, these modules act as part of the controller system and are located on the right side of the PLC unit.

### Input Terminals

This row of terminals receives the 4-20 mA signals from the O<sub>2</sub> probes.

Figure 1-2. OxyBalance Components

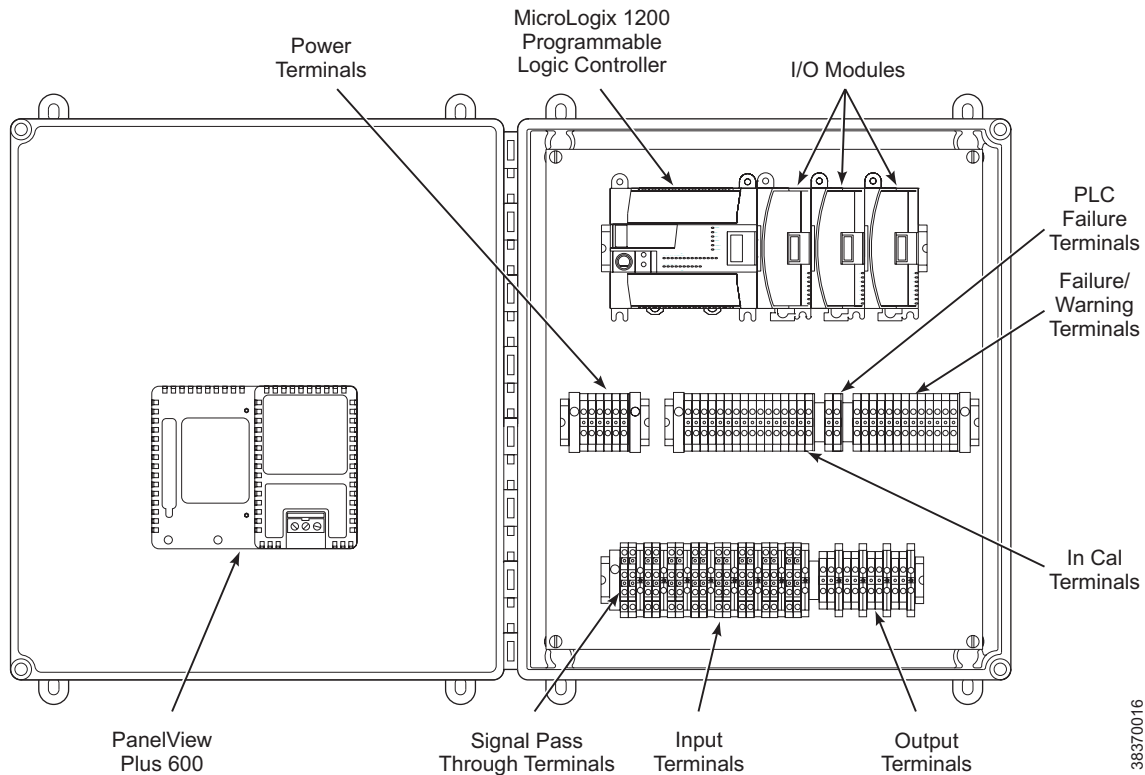

## **Signal Pass Through Terminals**

The pass through terminals are located on the input terminals. These terminals provide connection points for passing on the incoming O<sub>2</sub> signal to other devices.

## **Output (Average) Terminals**

These terminals provide a connection point for the average O<sub>2</sub>% 4-20 mA signals.

## **Failure / Warning Terminals**

These terminals provide connection points for the output signal warning and failure contacts.

## **In Cal Terminals**

These terminals provide connection points for In Cal signals from the individual oxygen probes. When a probe is in calibration, it is removed from any average calculations.

## **Power Terminals**

This terminal provides wire contacts for power distribution in the OxyBalance system.

OxyBalance operating specifications are listed in Table 1-2.

## SPECIFICATIONS

Specifications for the OxyBalance system are listed in Table 1-2.

Table 1-2. OxyBalance Specifications

<b>SPECIFICATIONS<sup>(1)</sup></b>	
<b>Ambient Environment</b>	
Temperature specification	23°F to 149°F (-5°C to 65°C)
Ambient temperature effect on electronics	Less than .01% of reading per 10°C
Vibration	IEC 68-2-6 and ISA S37.3
Shock	IEC 68-2-31 and ISA S37.3
Enclosure	NEMA 4X
Area Classification	General Purpose
<b>Power Requirements</b>	100-240 VAC, 50/60 Hz
<b>MicroLogix 1200</b>	
Resistive Load on Current Output	0 to 500 Ohms (includes wire resistance)
Input Impedance for Current Terminal	275 Ohms
<b>PanelView Plus 600</b>	
Minimum On-State Current	2.0 mA at 10V dc
Nominal On-State Current	8.9 mA at 24V dc
Maximum On-State Current	12. mA at 30V dc
Current per Group Common	8A
240V ac (Maximum Volts)	2.5A <sup>(2)</sup> (Amperes Continuous)
120V ac (Maximum Volts)	2.5A <sup>(2)</sup> (Amperes Continuous)
125V dc (Maximum Volts)	1.0A (Amperes Continuous)
24V dc (Maximum Volts)	2.0A (Amperes Continuous)
<b>I/O</b>	
Signal Inputs	4-20 mA (qty. 1 to 8 O <sub>2</sub> probes)
Signal Outputs	4-20 mA (qty. 1 to 8 pass through each probe, qty. 4 programmable averages)
Signal Output Resolution (for averages)	12 bit
Signal Output Resistive Load	Less than 500 ohms
Discrete Inputs	"IN CAL" (qty. 2 to 8 from individual probes)
Relay Outputs	"LOSS OF PLC" "AVERAGE WARN" if one or more probes drop out of an average. "AVERAGE FAILED" for each average when only one probe in the average remains valid.
Architecture	Each probe utilizes its own autonomous conditioning electronics, including its own power supply. Any failure in the OxyBalance system will not affect the individual 4-20 mA signals going to the control room for each probe.
<b>Logic</b>	4 programmable averages from 2-8 probes
Individual probes removed from average if	1.) Probe fails (4-20 mA to default condition of 3.5 mA or 21 mA 2.) Probe is in cal (SPS / IMPS contact, must share with control room)
<b>Signal Security</b>	4-20 mA signals to be wired in series to the PLC and to the DCS I/O marshalling panel such that the loss of the PLC will not affect the transmission of the individual probe signals to the DCS. If PLC power, I/O cards or processor card(s) are lost, 4-20 mA signals from the probes are still transmitted to the control room.
<b>Personnel Security</b>	Password protection configuration changes in programmable averages.
<b>Color Graphic Display</b>	
Size	6" diagonal
Type	Color Active Matrix, TFT LCD
Resolution	320 by 240 min. Touch screen operator interface

<sup>(1)</sup>Specifications are subject to change without notification. Our policy is one of continuous improvement and we reserve the right to change specifications.

<sup>(2)</sup>1.5A above 40°C.

# OxyBalance Oxygen Display and Averaging System

---

**Instruction Manual**  
IM-106-4050 Original Issue  
March 2006

## Section 2 Installation

---

Overview .....	page 2-1
System Considerations .....	page 2-1
Mounting .....	page 2-2
Wiring Connections .....	page 2-2
Setup .....	page 2-2

---

**⚠ WARNING**

Before starting to install this equipment, read the "Safety Instructions" in Appendix A: Safety Data. Failure to follow the safety instructions could result in serious injury or death.

**⚠ WARNING**

Disconnect all power before installing or replacing components. Failure to disconnect power may result in electrical shock and/or damage to the terminal.

**⚠ WARNING**

Install all protective equipment covers and safety ground leads after installation. Failure to secure covers and ground leads could result in serious injury or death.

### OVERVIEW

This section describes:

1. Wall-mounting of the OxyBalance system.
2. The necessary wiring schematics for proper connection of the OxyBalance system.
3. Setup procedures conducted through the PanelView Plus 600 on how to configure, assign nomenclature, change/update display settings, and assigning the O<sub>2</sub> probes to the average outputs.

### SYSTEM CONSIDERATIONS

Prior to installation of the OxyBalance system, check for all components necessary to install the system completely. When selecting a mounting location, determine where the OxyBalance system will be placed in terms of serviceability, ambient temperatures, environmental considerations, and convenience.

## MOUNTING

The OxyBalance Oxygen Display and Averaging System was designed to be wall-mounted or simply placed on a table. Locate the unit where the ambient temperature is between 23°F to 149°F (-5°C to 65°C).

The outline drawing in Figure 2-1 shows mounting dimensions of the OxyBalance system.

Figure 2-1. Mounting Dimensions

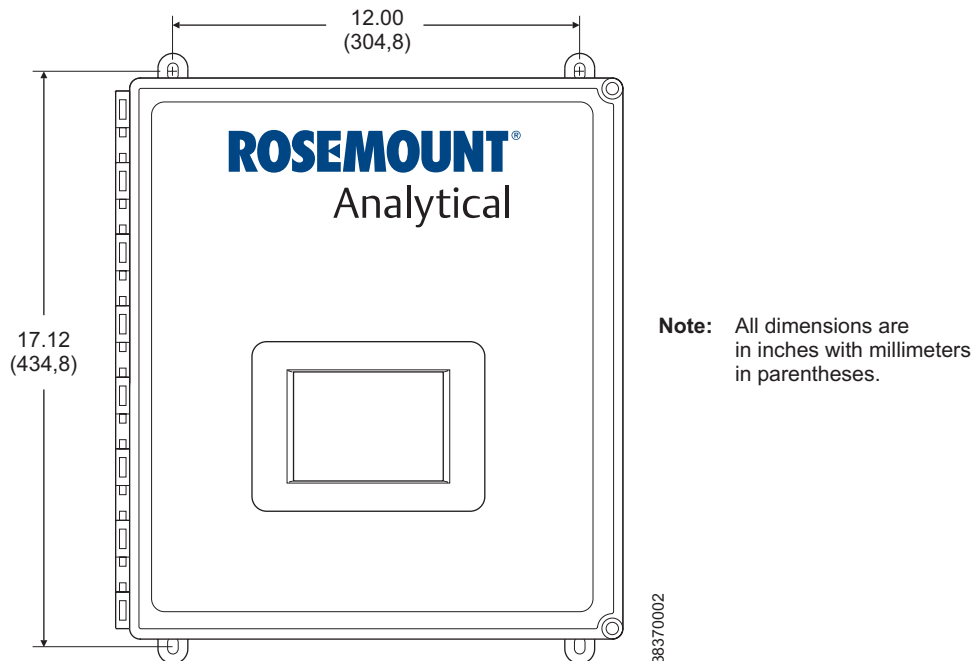

## WIRING CONNECTIONS

Refer to Figure 2-2 and connect the input and output signal wiring to the OxyBalance as follows:

1. Connect the incoming 4-20mA signals to the input signal terminals.
2. Connect the 4-20mA average O<sub>2</sub> signals to the output signal terminals.
3. Connect the In Cal input signals to the in cal signal terminals.
4. Connect the warning and failure signal output wiring to the warning and failure signal terminals.
5. If the signal pass-through feature for the incoming O<sub>2</sub> signals will be used, remove the jumpers from the pass-through terminals. Connect the outgoing O<sub>2</sub> signal wires to the raised output signal terminals. Refer to Figure 2-3.
6. Connect 90-240Vac, 50/60 Hz input power to the power input terminals.

## SETUP

For setup information, refer to Section 3, Setup.

# OxyBalance Oxygen Display and Averaging System

**Instruction Manual**  
 IM-106-4050 Original Issue  
 March 2006

Figure 2-2. Installation Wiring Schematic

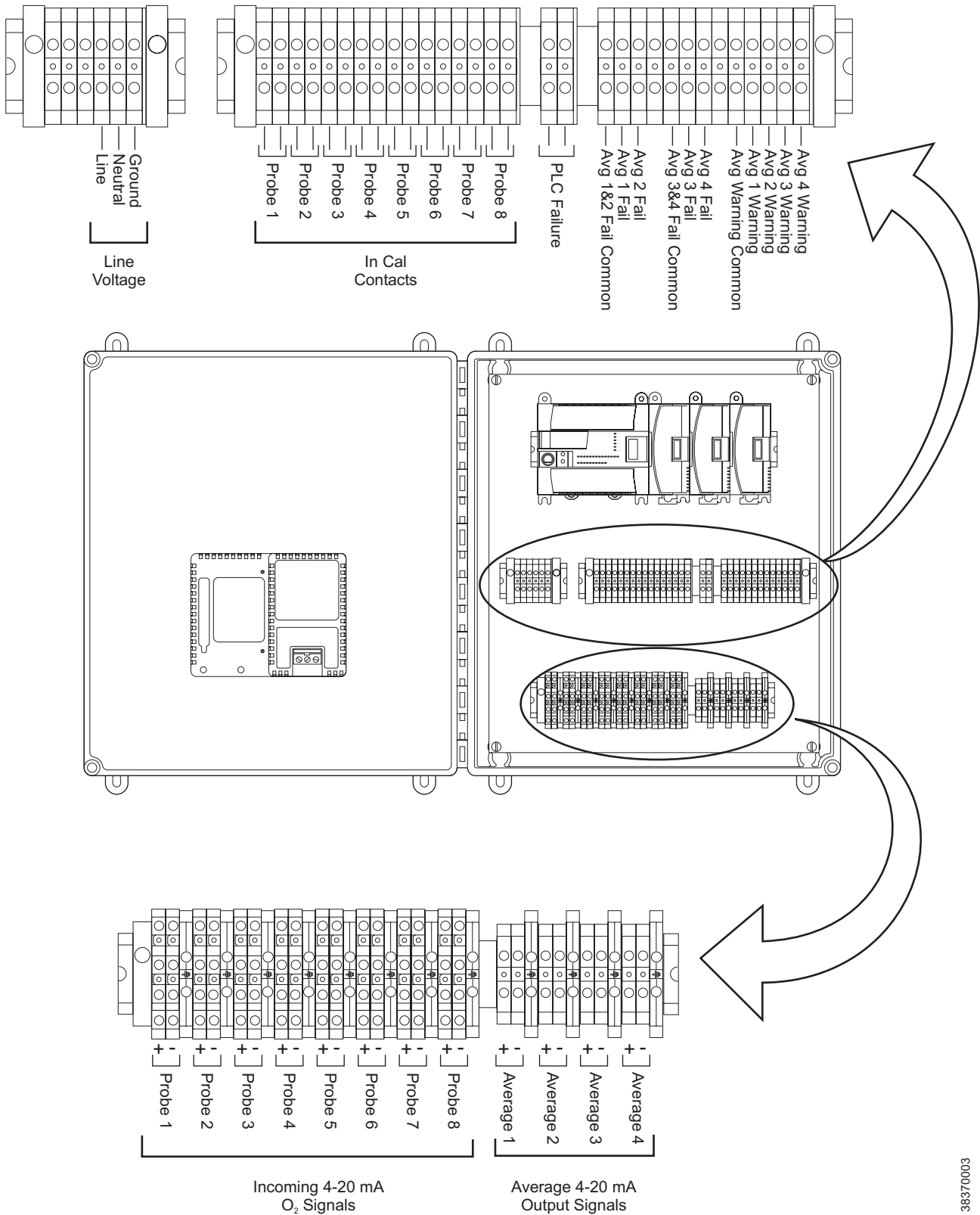

300070003

Figure 2-3. Pass-Through Terminals

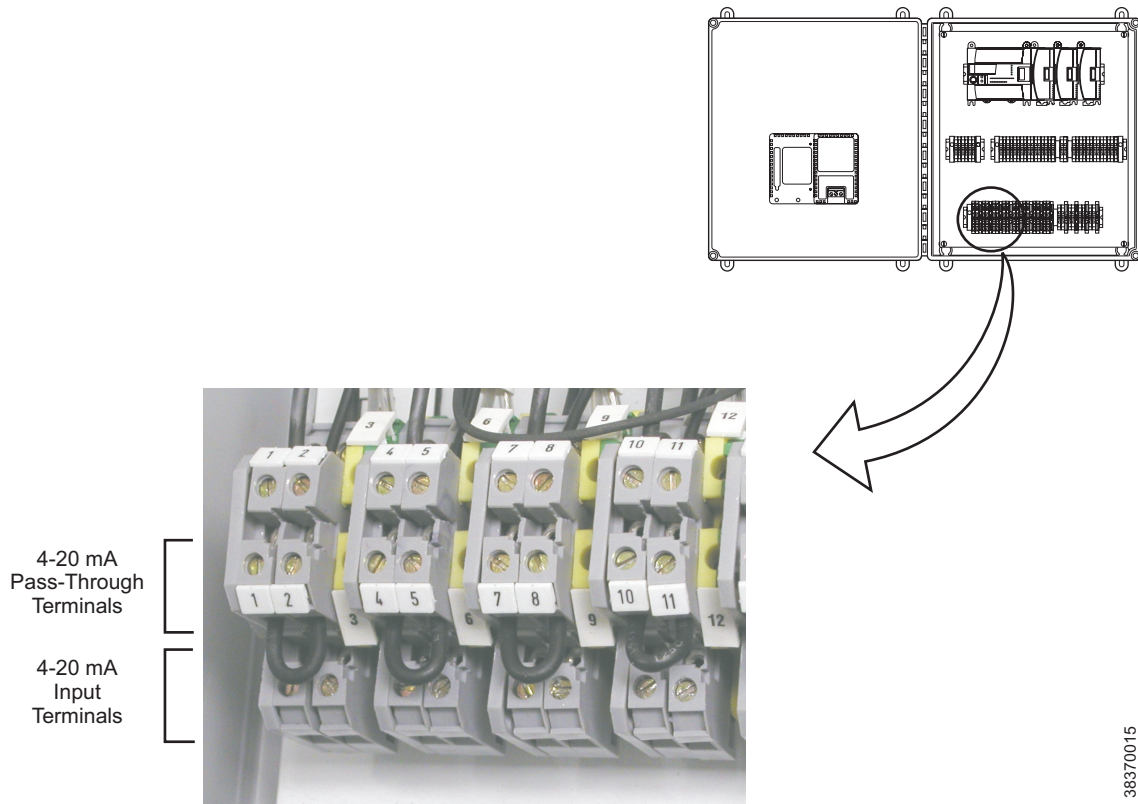



# Section 3 Setup

Overview ..... page 3-1  
 Setup ..... page 3-1

**⚠ WARNING**

Before starting to install this equipment, read the "Safety Instructions" in Appendix A: Safety Data. Failure to follow the safety instructions could result in serious injury or death.

**⚠ WARNING**

Disconnect all power before installing or replacing components. Failure to disconnect power may result in electrical shock and/or damage to the equipment.

## OVERVIEW

This section provides information on setup and configuration of the OxyBalance Oxygen Display and Averaging System

## SETUP

Each O<sub>2</sub> probe generates a 4-20 mA output signal that is received by the OxyBalance system. When a probe channel detects a current signal greater than 3.5 mA, that probe is considered active, and is automatically made available. It is not necessary to tell the OxyBalance that a probe is present. It is automatically detected and used. Table 3-1 shows how the OxyBalance system interprets and displays these signals.

Table 3-1. Signal Interpretation

4-20 mA Signal Value	Status	Display Color
<3.5 mA	Probe Inactive	Not Shown
3.5 mA to 3.6 mA	Probe Failed	Red
3.6 mA to 3.8 mA	Reading Under Range	Yellow
3.8 mA to 20.5 mA	Good Reading	Green
20.5 mA to 21 mA	Reading Over Range	Yellow
>21 mA	Probe Failed	Red

After these signals are converted into an O<sub>2</sub> % they are displayed on the touch screen interface. The rest of this section will outline the necessary steps to configure and operate the OxyBalance system through the touch screen interface.

All of the operations that are conducted through the touch screen interface, are conducted through five subject tabs that appear on the right hand side of the interface.

- Current
- Trend
- Login
- Setup
- Alarm

## Login

The operation of the interface can be password protected, so either the Login Required, or Login Not Required screen will be displayed once the Login tab has been pressed, Refer to Figure 3-1 and Figure 3-2.

Figure 3-1. Login Required Screen

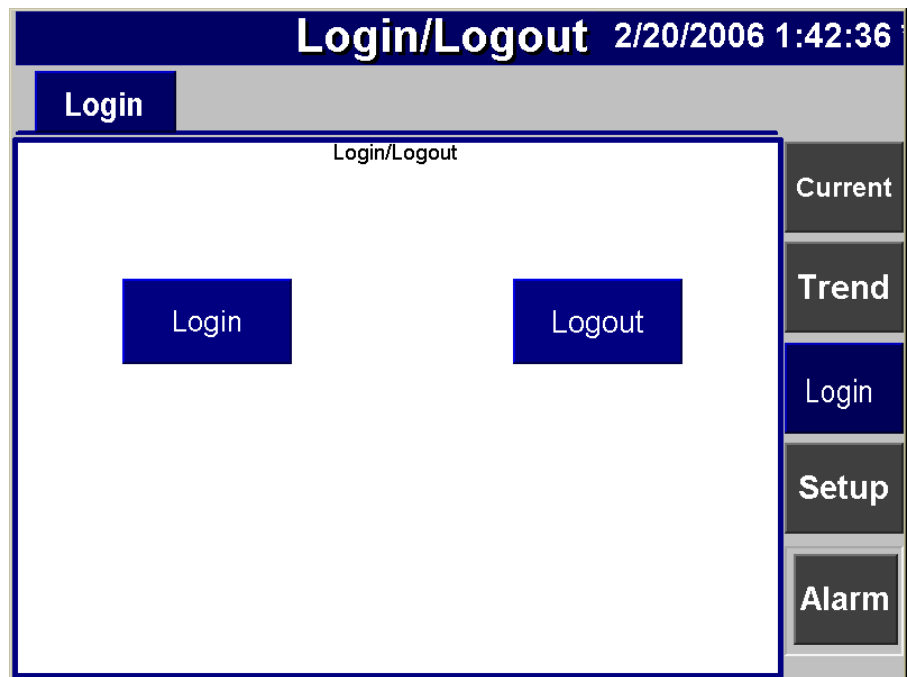
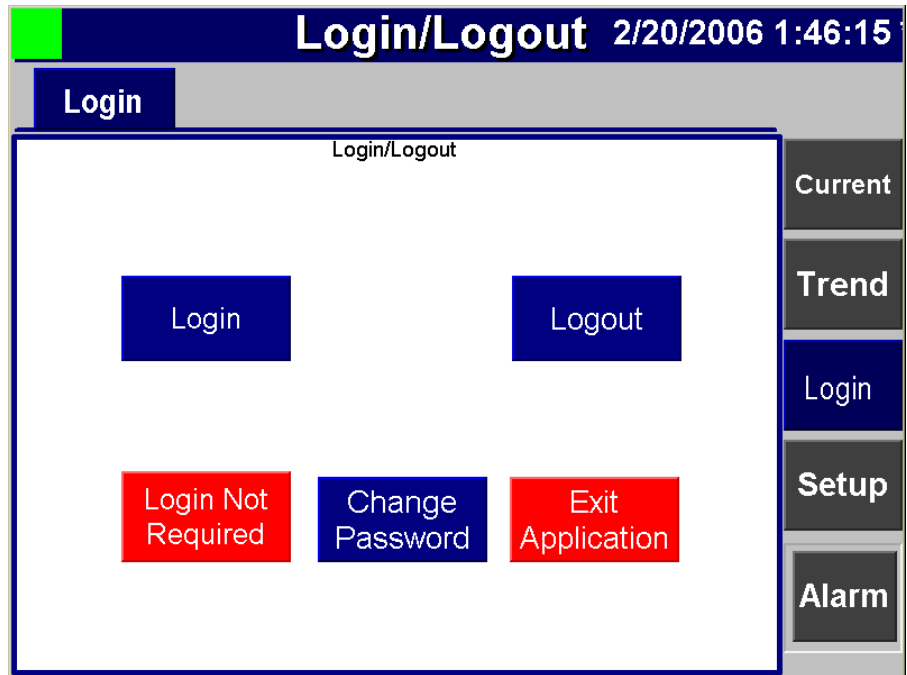

Figure 3-2. Login Not  
Required Screen



## Setup

The Setup tab contains five sub-tabs displayed along the top of the screen; a General tab, and one tab for each of the four averages.

### General

#### Scale Values

Under this tab the values for the Analog full scale, Trend min value and Trend max value, can be changed to represent more of an applicable scale when displaying the probe or average outputs. See Figure 3-3.

- Analog full scale - This setting controls the O<sub>2</sub> % value represented by the incoming 4-20 mA signals, and the average O<sub>2</sub> % output signals. All input signals must represent the same full scale value.
- Trend min value - This values allows the adjustment of the minimum value displayed on the trend graphs on the touch screen display, allowing the display to zoom in on the range of interest. This setting only affects the displayed values. It has no affect on the average O<sub>2</sub> % output signals.
- Trend max value - This values allows the adjustment of the maximum value displayed on the trend graphs on the touch screen display, allowing the display to zoom in on the range of interest. This setting only affects the displayed values. It has no affect on the average O<sub>2</sub> % output signals.

Figure 3-3. Scale Values Setup

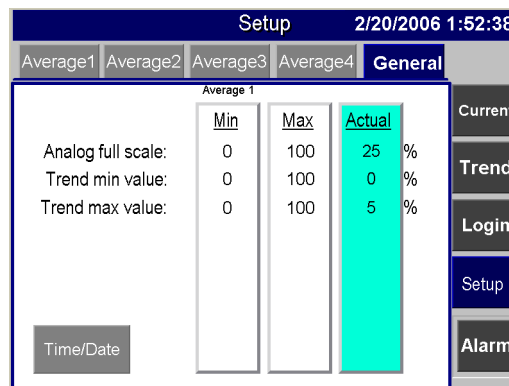

### Time and Date

To set the time and date press the "Time/Date" button shown on the General tab of the Setup screen. A new screen will be shown. See Figure 3-4. Touch any value in the Actual column to change that value. Once the new value has been entered, hold the "Hold To Set Clock" button until the time and date has been updated in the upper right hand corner of the screen.

Figure 3-4. Time and Date Setup

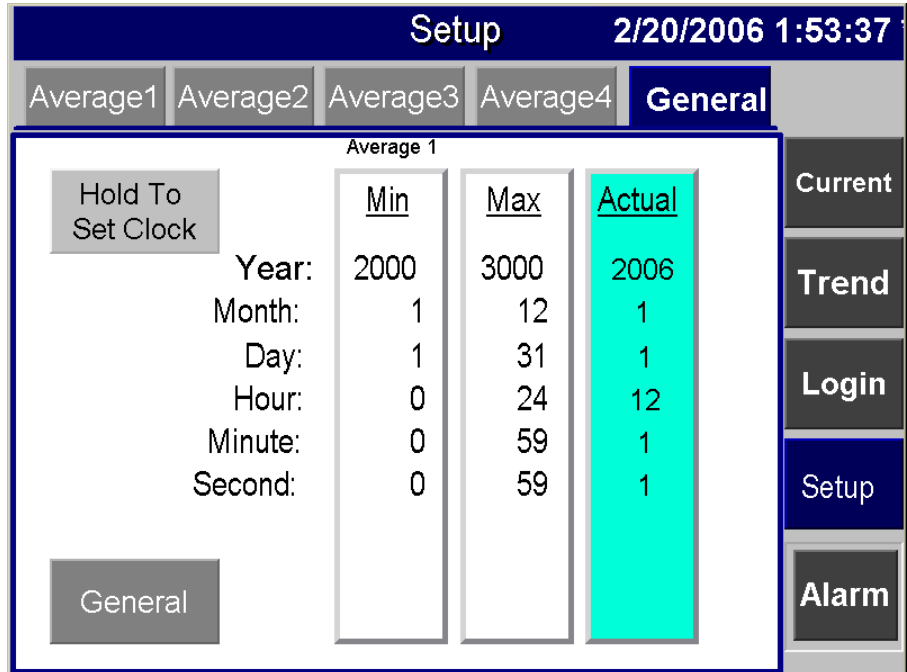

## Average1 - Average4

The four Average tabs across the top of the Setup screen represent the four output signals generated by the Oxybalance system. Each of these four tabs displays all eight possible input signals, whether or not the probes are active, and whether or not they have been selected to be part of the average for the selected output channel. In Figure 3-5 the information for Average2 is shown.

In Figure 3-5, this channel has been named "Duct B". This name can be changed by pressing the name on the screen. Probes 2 through 8 are active. Probes 4, 5 and 6 have been selected to be included in this channel average. Pressing on any of the active probes will toggle the probe between being included and not included in this channel average. Once a probe is assigned to the displayed average group, the background for that probe is shown in green. Two to eight probes can be assigned to any of the average groups, in any combination.

Figure 3-5. Average Setup

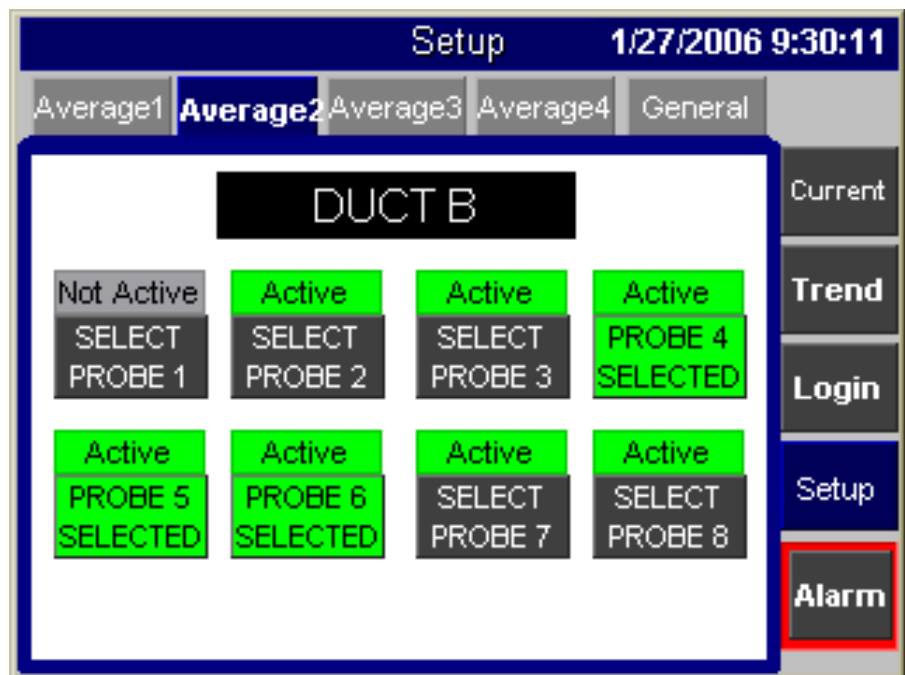

## Current

Selecting the Current tab on the right side of the touch screen will display the Current screen. The two tabs at the top of the screen will display the Probes and Averages information.

### Probes

The Probes tab, shown in Figure 3-6, displays the status and the oxygen percentage for each of the eight possible probes. The color of the bar denotes the status of the probe signal.

- Green = Probe is OK
- Blue = Probe is in calibration
- Red = Probe has failed
- Yellow = Analog input signal is outside the normal range, but not far enough to be considered failed.

### NOTE

If a probe signal level is not shown in green, then it is not being used in any average calculations.

Figure 3-6 provides an example of a Probes tab with probes in several of these conditions. Probe 1 is in Fault condition, and probe 5 is in calibration. Neither of these probes will be used in any average calculations.

Figure 3-6. Probes Tab

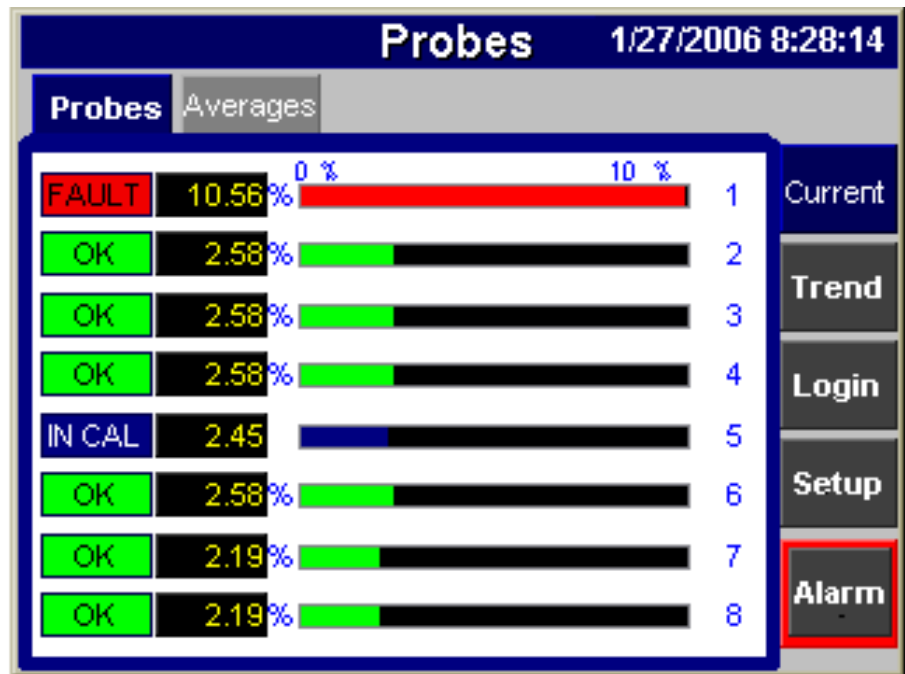

## Averages

The Averages tab of the Current screen, shown in Figure 3-7, displays the average oxygen percentage for each probe grouping. Each of these four averages are represented by either a green or red status tag and bar. Green signifies that the average is OK, red means that the reading is either in a fault or warning condition.

### Fault Condition

A Fault condition is indicated when one or more probes included in an average has failed. The failed probes are not included in the average calculation for that average.

### Warning Condition

A warning condition occurs for an average when only all but one channel included in an average is in a failed state. In this state, an "average" cannot be calculated, and the channel will output the value of the remaining functional probe.

Figure 3-7. Average Current

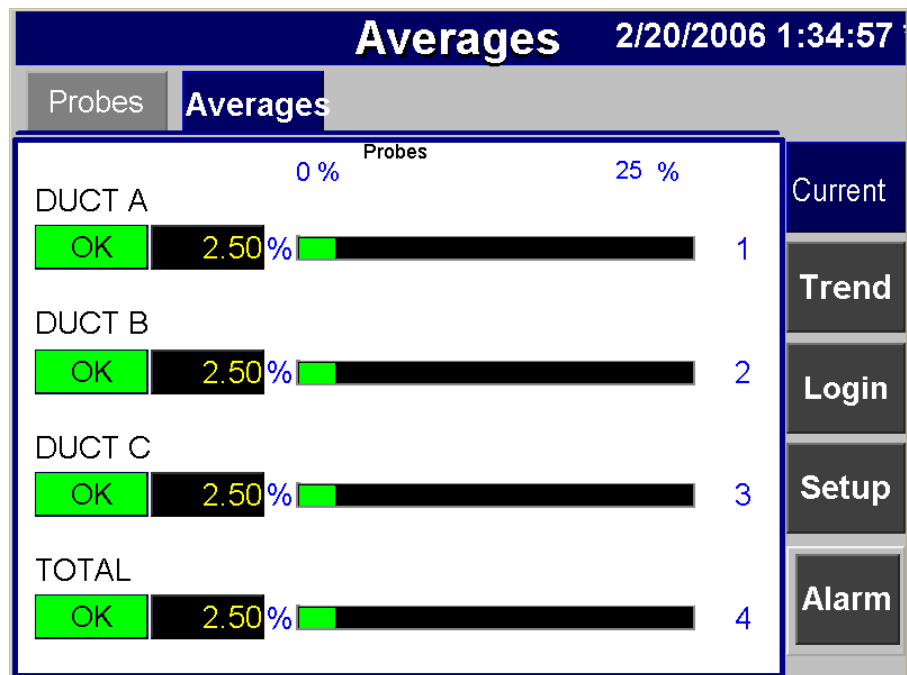



## Trend

The Trend tab represents a graphical trend analysis of the oxygen percentage for all eight probes, and the oxygen percentage for all four averages.

The LEFT and RIGHT buttons at the bottom of the screen scroll the trend graph, allowing access to historical data.

The button labeled 5 min in the top right corner changes the display scale between 5 minutes, 1 hour, and 24 hours. Pressing the button cycles through the available options.

### All

The "All" tab graphically represents each of the four averages, all signified in a different color for display purposes only.

### Average1- Average4

Each of these four tabs shows a single average channel, and all of the probes included in that average.

Figure 3-8 shows the Average4 tab. This average grouping has been named Total, and shows the readings for all eight probes, which are represented on the trend graph by a separate color for each probe. The average for this channel is shown above the trend graph, to the left of the channel name.

The LEFT and RIGHT buttons scroll the trend graph, allowing access to historical data.

The button labeled 5 min in the top right corner changes the display scale between 5 minutes, 1 hour, and 24 hours. Pressing the button cycles through the available options.

Figure 3-8. Probe Trend

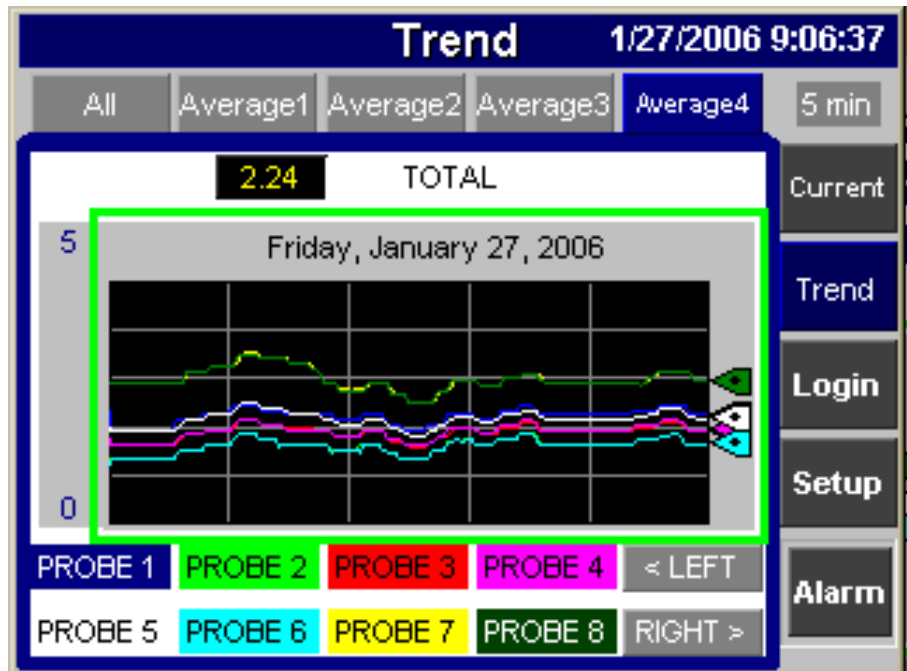

## Alarm

There are two divisions of the Alarm tab: Active Alarms and Alarm History, shown in Figure 3-9 and Figure 3-10.

There are four possible reports that can be displayed.

### **Average # 1-4 warning**

This appears when one of the probes fails or is in calibration. When this Alarm appears, the average channel will still display an average O<sub>2</sub> % for the remaining probes in the group.

### **Average # 1-4 failed**

This appears when less than 2 probes in the group are transmitting data for the average calculation. No average percentage will be calculated.

### **Probe # 1-8 calibration in progress**

This means that the probe is calibrating and will automatically join its specified group when the calibration is complete. Probes in calibration are not factored into the channel average.

### **Probe #1-8 failed**

This means the probe has failed and needs to be checked. Refer to Section 6, Troubleshooting.

Figure 3-9. Active Alarms

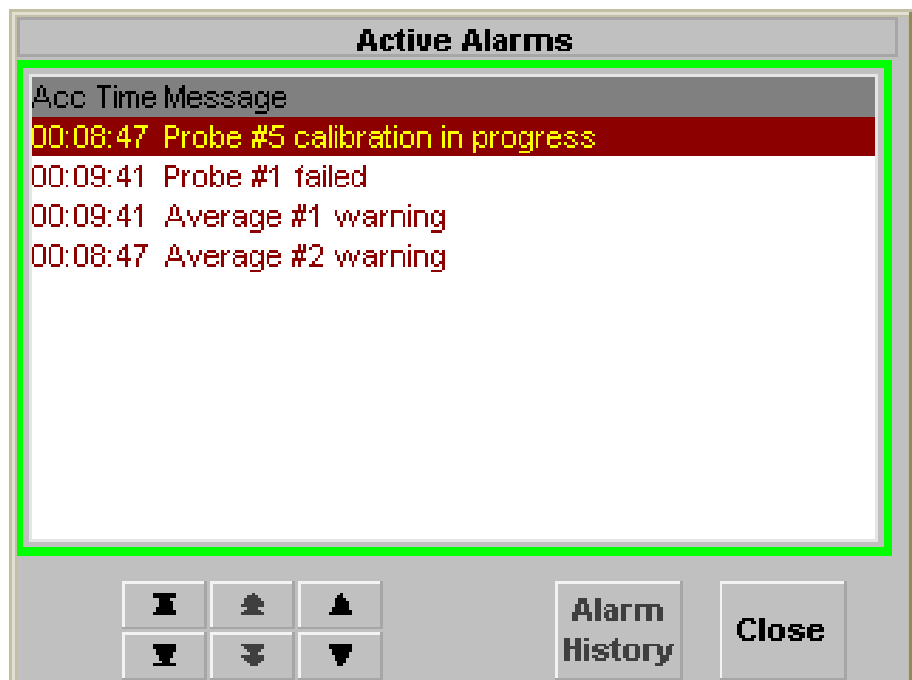

Figure 3-10. Alarm History

Alarm time	Message
* 2/20/2006 1:57:19 PM	Average #4 warning
* 2/20/2006 1:57:19 PM	Average #4 failed
* 2/20/2006 1:57:19 PM	Average #3 warning
* 2/20/2006 1:57:19 PM	Average #3 failed
* 2/20/2006 1:57:19 PM	Average #2 warning
* 2/20/2006 1:57:19 PM	Average #2 failed
* 2/20/2006 1:57:19 PM	Average #1 warning
* 2/20/2006 1:57:19 PM	Average #1 failed
* 2/20/2006 1:57:19 PM	Probe #1 failed
* 2/20/2006 1:57:17 PM	Average #4 warning
* 2/20/2006 1:57:17 PM	Average #4 failed

Buttons: Ack Alm, Ack All, Clear All, navigation arrows (left, right, up, down), Active Alarms, Close

On the Alarm History page, shown in Figure 3-10, there are three sets of arrows used for selecting the alarms. These are located in the bottom center portion of the screen. To scroll between individual alarms use the set of arrows on the right. To jump to the next or previous page of alarms use the middle set of arrows. To jump to the top or bottom of the list, use the set of arrows on the left side. These are also shown on the Active Alarms page.

The Ack Alm and Ack All buttons are used to acknowledge the alarms. Acknowledging alarms has no effect on the operation of the system. It is an aide for determining which alarms have and have not been seen. Once an alarm has been acknowledged, by using either the Ack Alarm or Ack All button, an asterisk appears next to the date and time of the alarm.

# OxyBalance Oxygen Display and Averaging System

---

**Instruction Manual**  
IM-106-4050 Original Issue  
March 2006

---

## Section 4      Calibration

---

OxyBalance Calibration .....	page 4-1
------------------------------	----------

---

### **OXYBALANCE CALIBRATION**

There is no calibration required for the OxyBalance Oxygen Display and Averaging System.

# OxyBalance Oxygen Display and Averaging System

---

**Instruction Manual**  
IM-106-4050 Original Issue  
March 2006

## Section 5 Maintenance and Service

---

Overview .....	page 5-1
PanelView Plus 600 .....	page 5-1
MicroLogix 1200 Programmable Controllers .....	page 5-6

---

### WARNING

Before starting to install this equipment, read the "Safety Instructions" in Appendix A: Safety Data. Failure to follow the safety instructions could result in serious injury or death.

### WARNING

Disconnect all power before installing or replacing components. Failure to disconnect power may result in electrical shock and/or damage to the equipment.

### WARNING

Install all protective equipment covers and safety ground leads after installation. Failure to secure covers and ground leads could result in serious injury or death.

### OVERVIEW

This section describes the removal and replacement of the PanelView Plus 600 and the MicroLogix 1200 Programmable Controllers.

### PANELVIEW PLUS 600

The PanelView Plus 600 touch screen interface is visible through the front panel cutout. The internal circuitry is housed inside the NEMA 4X protective enclosure.

The PanelView comes equipped with the following features:

- AC or DC power connection and cord
- Mounting lever slots
- RS-232 and USB ports
- Touch screen interface
- Communication module and cord
- Compact flash memory card slot

## PanelView Removal

### **⚠ WARNING**

Disconnect all power before installing or replacing components. Failure to disconnect power may result in electrical shock and/or damage to the equipment.

### **NOTE**

Make sure to record the wiring connections and locations before disconnecting any wiring. This will aid in the installation of the unit.

1. Disconnect the three power wires from the wire contacts (L1, L2N, and ground) of the PanelView Plus 600, see Figure 5-1.
2. Remove the communications cord from the PanelView Plus 600.
3. Turn mounting levers to the unlocked position, and remove the mounting levers from the mounting lever slots. See Figure 5-3.
4. Carefully slide the PanelView Plus 600 unit through the front of the panel cutout.

Figure 5-1. PanelView System  
Wiring

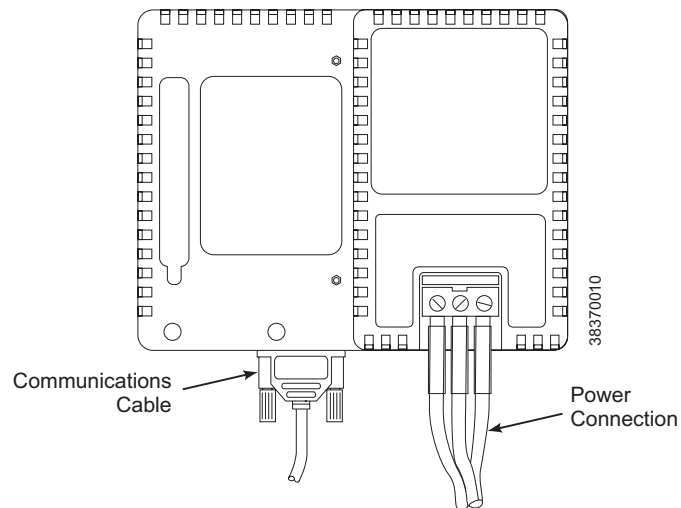
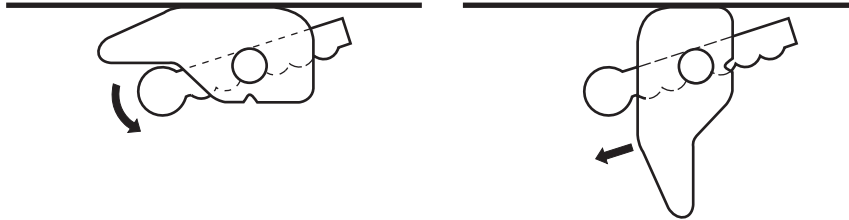
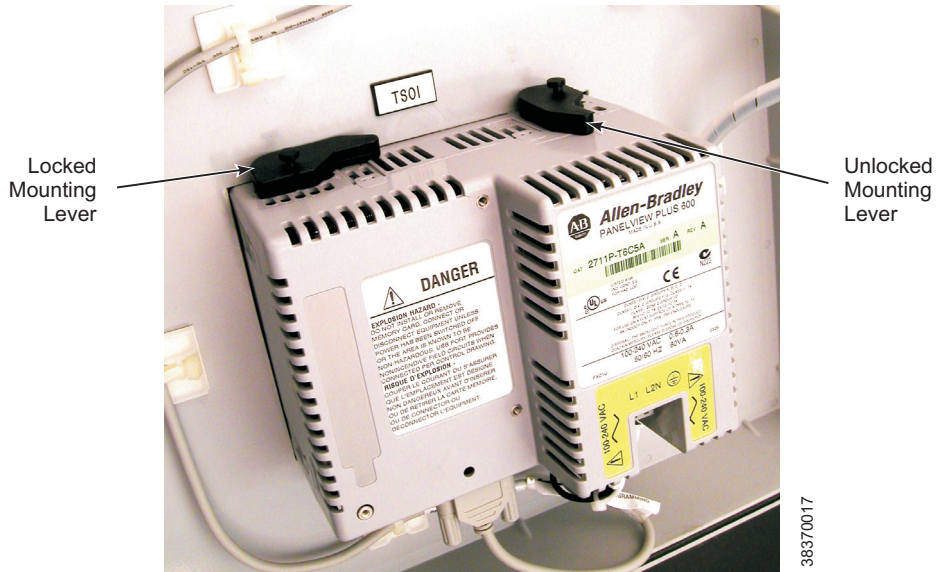



Figure 5-2. Mounting Lever Removal



## PanelView Installation

### **WARNING**

This equipment is intended for use in clean, dry environments where only non-conductive pollution occurs (except occasionally a temporary conductivity caused by condensation), and with circuits not exceeding Over Voltage Category II (IEC 60664-1).

### **WARNING**

Disconnect all power before installing or replacing components. Failure to disconnect power may result in electrical shock and/or damage to the equipment.

## Mounting Procedures

### **NOTE**

If a communication module is ordered separately, make sure to attach the module to the base unit before panel installation. Refer to the PanelView Plus 600 manual for information on communication modules.

### **NOTE**

Make sure the sealing gasket is properly positioned on the PanelView Plus 600. This gasket forms a compression seal. DO NOT use sealing compounds.

1. Insert the PanelView Plus 600 through the panel cutout on the front of the NEMA 4X protective enclosure front panel. Make sure to align the unit with the center of the panel cutout for adequate gasket sealing.
2. Insert the four mounting levers into the mounting slots on the unit, see Figure 5-3. Slide each lever until the flat side of the lever touches the surface of the panel.
3. Once all levers are in place, slide each lever an additional notch or two until you hear a click.
4. Rotate each lever in the direction indicated until it is in the final latch position.
5. Connect the power wires to the three wire contacts (L1, L2N, and ground) on the PanelView Plus 600. see Figure 5-1.
6. Connect the communication cord to the PanelView Plus 600.

Figure 5-3. Mounting Levers Installation

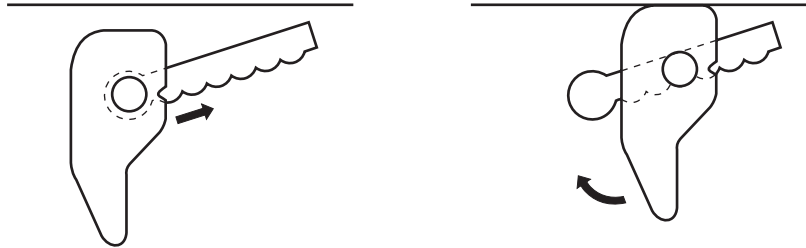
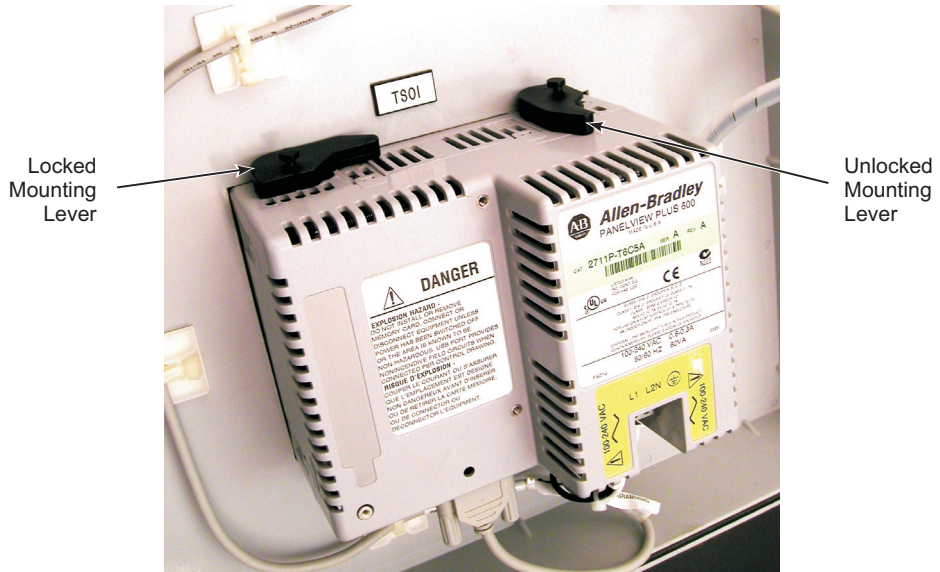

38370011

## **MICROLOGIX 1200 PROGRAMMABLE CONTROLLERS**

The MicroLogix 1200 Programmable Controllers consist of one PLC unit and three I/O modules. The PLC mounts horizontally with the expansion I/O modules extending to the right of the controller.

### **⚠ WARNING**

This equipment is intended for use in clean, dry environments where only non-conductive pollution occurs (except occasionally a temporary conductivity caused by condensation), and with circuits not exceeding Over Voltage Category II (IEC 60664-1).

### **⚠ WARNING**

Electrostatic discharge can damage semiconductor devices inside the controller. Do not touch connector pins and other sensitive areas.

## **PLC Removal**

### **⚠ WARNING**

Disconnect all power before installing or replacing components. Failure to disconnect power may result in electrical shock and/or damage to the equipment.

### **NOTE**

Make sure to carefully record the wiring connections and locations before disconnecting. This will aid in the installation of the unit.

1. Tag and disconnect all wiring from the MicroLogix PLC.
2. Remove the cover from the ribbon cable connector on the PLC. Use the pull loop on the connector to disconnect the ribbon cable from the PLC. Do not pull on the ribbon cable. See Figure 5-4.
3. Place a flat-blade screw driver in the DIN rail tab at the bottom of the controller, see Figure 5-5. Holding the PLC, pry downward on the tab until the tab locks in the open position.
4. Repeat step 3 for the second DIN rail tab.
5. Pull the bottom of the PLC out and away from DIN Rail, as shown in Figure 5-6. When the bottom of the PLC is free from the DIN rail, lift up on the PLC until the top is also free of the DIN rail. Remove the PLC from the OxyBalance enclosure.

Figure 5-4. Ribbon Cable and Pull Loop

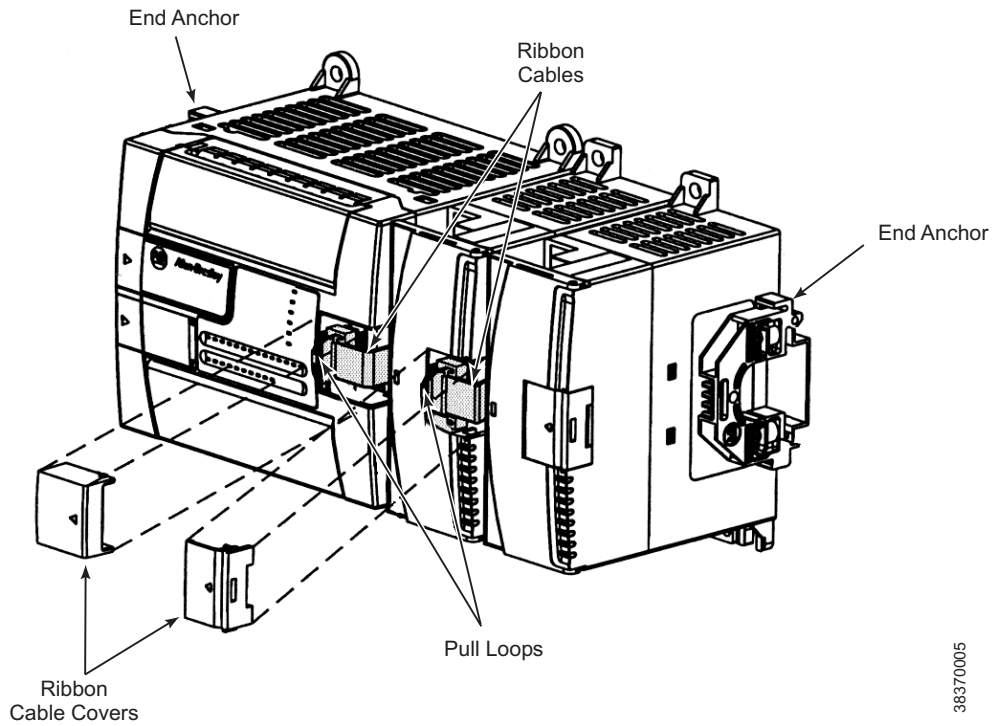

38370005

Figure 5-5. DIN Tabs

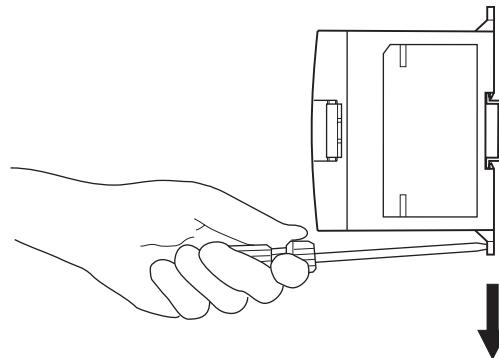
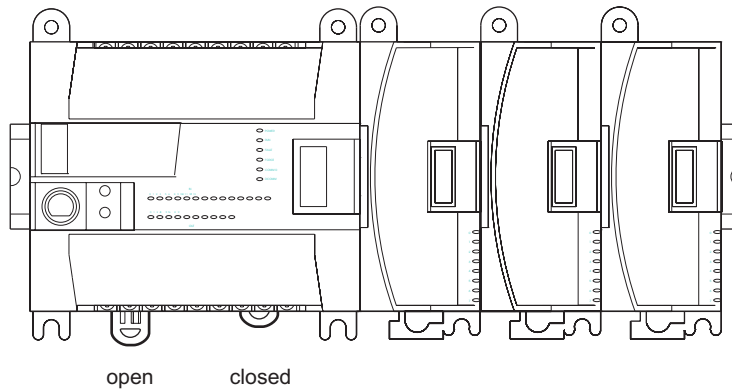

38370008

Figure 5-6. Removal from  
DIN Rail

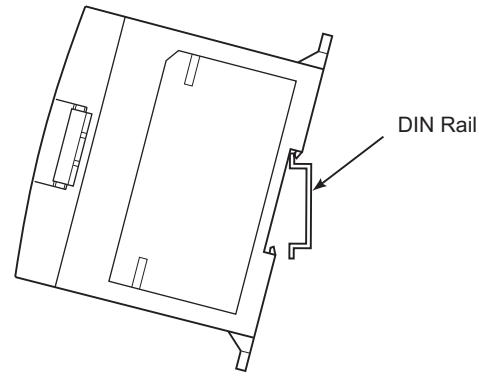

## PLC Replacement

### Mounting Procedures

1. Place the top of the MicroLogix PLC over the top of the DIN rail, with the bottom of the PLC tilted away from the DIN rail. See Figure 5-6
2. When the top of the PLC engages the DIN rail, pivot the bottom of the PLC in toward the DIN rail.
3. Using a screwdriver, push the DIN tabs up until they snap into position, holding the PLC tight against the DIN rail. See Figure 5-5/
4. Attach the flat ribbon cable from the I/O modules to the PLC. See Figure 5-4. Install the ribbon cable cover.
5. Ensure the end anchors are tight
6. Connect the wiring to the PLC that was removed in step 1 of "PLC Removal".

### **⚠ WARNING**

Failure to remove protective debris shield before operating can cause overheating.

7. Remove the debris shield from the PLC.

## I/O Module Removal

### **WARNING**

Disconnect all power before installing or replacing components. Failure to disconnect power may result in electrical shock and/or damage to the equipment.

### **NOTE**

Make sure to carefully record the wiring connections and locations before disconnecting. This will aid in the installation of the unit.

1. Tag and disconnect all wiring from the I/O module.
2. Remove the cover from the ribbon cable connector on the module to the left of the module to be removed. Use the pull loop on the connector to disconnect the ribbon cable from that module. Do not pull on the ribbon cable. See Figure 5-4.
3. If necessary, remove the cover from the ribbon cable connector on the module to be removed. Use the pull loop on the connector to disconnect the ribbon cable. Do not pull on the ribbon cable.
4. Place a flat-blade screw driver in the DIN rail tab at the bottom of the I/O module. Holding the module, pry downward on the tab until the tab locks in the open position.
5. Pull the bottom of the I/O module out and away from the mounting plate inside the enclosure. When the bottom of the module is free from the DIN rail, lift up on the module until the top is also free of the DIN rail. Remove the module from the OxyBalance enclosure.

## I/O Module Replacement

### **Mounting Procedures**

1. Place the top of the I/O module over the top of the DIN rail, with the bottom of the module tilted away from the DIN rail.
2. When the top of the module engages the DIN rail, pivot the bottom of the module in toward the DIN rail.
3. Using a screwdriver, push the DIN tab up until it snaps into position, holding the module tight against the DIN rail.
4. Attach the flat ribbon cable from the I/O module to the PLC or module to the left. Install the ribbon cable cover.
5. If necessary, attach the ribbon cable from the I/O module to the right, to the module being installed. Install the ribbon cable cover.
6. Ensure the end anchors are tight
7. Connect the wiring to the I/O Module that was removed in step 1 of "I/O Module Removal".

# OxyBalance Oxygen Display and Averaging System

---

**Instruction Manual**  
IM-106-4050 Original Issue  
March 2006



---

## Section 6 Troubleshooting

---

Overview .....	page 6-1
Probe Failure .....	page 6-1

---

### OVERVIEW

This section describes troubleshooting procedures for probe failure in the OxyBalance system.

Refer to the PanelView Plus 400 and 600 Terminals Installation Instructions or the MicroLogix 1200 Programmable Controllers User Manual for any troubleshooting problems concerning these units.

### PROBE FAILURE

If the one of the O<sub>2</sub> sensing probe is in failure, make sure to check that:

1. All wiring is secure and properly connected to the O<sub>2</sub> probe.
2. All wiring is secure and connected to the proper contacts inside the OxyBalance system.
3. O<sub>2</sub> probe is set to transmit a 4-20 mA signal and not set on a different range , such as 0-20 mA or voltage.
4. All O<sub>2</sub> probes are set to output the same O<sub>2</sub> range, such as 0-10%.
5. The O<sub>2</sub> probe is providing power for the current loop.

# OxyBalance Oxygen Display and Averaging System

---

**Instruction Manual**  
IM-106-4050 Original Issue  
March 2006

# Section 7 Recommended Spare Parts

Spare Parts Listing ..... page 7-1

## SPARE PARTS LISTING

Table 7-1. Recommended Spare Parts for the OxyBalance Oxygen Display and Averaging System

FIGURE and INDEX No.	PART NUMBER	DESCRIPTION	QUANTITY
		MicroLogix 1200 PLC	1
		PanelView Plus 600	1
		Memory Card loaded with PLC and PanelView programs	1

*Refer to the MicroLogix 1200 Programmable Controllers User Manual for replacement parts for the PLC.*

# OxyBalance Oxygen Display and Averaging System

---

**Instruction Manual**  
IM-106-4050 Original Issue  
March 2006

## **Section 8      Optional Accessories**

Refer to the PanelView Plus 400 and 600 Terminals Installation Instructions or the MicroLogix 1200 Programmable Controllers User Manual for optional accessories concerning these units.

# OxyBalance Oxygen Display and Averaging System

---

**Instruction Manual**  
IM-106-4050 Original Issue  
March 2006

---

# Appendix A      Safety Data

---

Safety Instructions .....	page A-2
---------------------------	----------

---

## SAFETY INSTRUCTIONS

## IMPORTANT

### SAFETY INSTRUCTIONS FOR THE WIRING AND INSTALLATION OF THIS APPARATUS

The following safety instructions apply specifically to all EU member states. They should be strictly adhered to in order to assure compliance with the Low Voltage Directive. Non-EU states should also comply with the following unless superseded by local or National Standards.

1. Adequate earth connections should be made to all earthing points, internal and external, where provided.
2. After installation or troubleshooting, all safety covers and safety grounds must be replaced. The integrity of all earth terminals must be maintained at all times.
3. Mains supply cords should comply with the requirements of IEC227 or IEC245.
4. All wiring shall be suitable for use in an ambient temperature of greater than 75°C.
5. All cable glands used should be of such internal dimensions as to provide adequate cable anchorage.
6. To ensure safe operation of this equipment, connection to the mains supply should only be made through a circuit breaker which will disconnect all circuits carrying conductors during a fault situation. The circuit breaker may also include a mechanically operated isolating switch. If not, then another means of disconnecting the equipment from the supply must be provided and clearly marked as such. Circuit breakers or switches must comply with a recognized standard such as IEC947. All wiring must conform with any local standards.
7. Where equipment or covers are marked with the symbol to the right, hazardous voltages are likely to be present beneath. These covers should only be removed when power is removed from the equipment - and then only by trained service personnel.
8. Where equipment or covers are marked with the symbol to the right, there is a danger from hot surfaces beneath. These covers should only be removed by trained service personnel when power is removed from the equipment. Certain surfaces may remain hot to the touch.
9. Where equipment or covers are marked with the symbol to the right, refer to the Operator Manual for instructions.
10. All graphical symbols used in this product are from one or more of the following standards: EN61010-1, IEC417, and ISO3864.







## **BELANGRIJK**

**Veiligheidsvoorschriften voor de aansluiting en installatie van dit toestel.**



**De hierna volgende veiligheidsvoorschriften zijn vooral bedoeld voor de EU lidstaten. Hier moet aan gehouden worden om de onderworpenheid aan de Laag Spannings Richtlijn (Low Voltage Directive) te verzekeren. Niet EU staten zouden deze richtlijnen moeten volgen tenzij zij reeds achterhaald zouden zijn door plaatselijke of nationale voorschriften.**

1. Degelijke aardingsaansluitingen moeten gemaakt worden naar alle voorziene aardpunten, intern en extern.
2. Na installatie of controle moeten alle veiligheidsdeksels en -aarding terug geplaatst worden. Ten alle tijde moet de betrouwbaarheid van de aarding behouden blijven.
3. Voedingskabels moeten onderworpen zijn aan de IEC227 of de IEC245 voorschriften.
4. Alle bekabeling moet geschikt zijn voor het gebruik in omgevingstemperaturen, hoger dan 75°C.
5. Alle wartels moeten zo gedimensioneerd zijn dat een degelijke kabel bevestiging verzekerd is.
6. Om de veilige werking van dit toestel te verzekeren, moet de voeding door een stroomonderbreker gevoerd worden (min 10A) welke alle draden van de voeding moet onderbreken. De stroomonderbreker mag een mechanische schakelaar bevatten. Zoniet moet een andere mogelijkheid bestaan om de voedingsspanning van het toestel te halen en ook duidelijk zo zijn aangegeven. Stroomonderbrekers of schakelaars moeten onderworpen zijn aan een erkende standaard zoals IEC947.
7. Waar toestellen of deksels aangegeven staan met het symbool is er meestal hoogspanning aanwezig. Deze deksels mogen enkel verwijderd worden nadat de voedingsspanning werd afgelegd en enkel door getraind onderhoudspersoneel. 
8. Waar toestellen of deksels aangegeven staan met het symbool is er gevaar voor hete oppervlakken. Deze deksels mogen enkel verwijderd worden door getraind onderhoudspersoneel nadat de voedingsspanning verwijderd werd. Sommige oppervlakken kunnen 45 minuten later nog steeds heet aanvoelen. 
9. Waar toestellen of deksels aangegeven staan met het symbool gelieve het handboek te raadplegen. 
10. Alle grafische symbolen gebruikt in dit produkt, zijn afkomstig uit een of meer van devolgende standards: EN61010-1, IEC417 en ISO3864.

## **VIGTIGT**

### **Sikkerhedsinstruktion for tilslutning og installation af dette udstyr.**



**Følgende sikkerhedsinstruktioner gælder specifikt i alle EU-medlemslande. Instruktionerne skal nøje følges for overholdelse af Lavspændingsdirektivet og bør også følges i ikke EU-lande medmindre andet er specificeret af lokale eller nationale standarder.**

1. Passende jordforbindelser skal tilsluttes alle jordklemmer, interne og eksterne, hvor disse forefindes.
2. Efter installation eller fejlfinding skal alle sikkerhedsdæksler og jordforbindelser reetableres.
3. Forsyningskabler skal opfylde krav specificeret i IEC227 eller IEC245.
4. Alle ledningstilslutninger skal være konstrueret til omgivelsestemperatur højere end 75°C.
5. Alle benyttede kabelforskrutninger skal have en intern dimension, så passende kabelafastning kan etableres.
6. For opnåelse af sikker drift og betjening skal der skabes beskyttelse mod indirekte berøring gennem afbryder (min. 10A), som vil afbryde alle kredsløb med elektriske ledere i fejlsituation. Afbryderen skal indholde en mekanisk betjent kontakt. Hvis ikke skal anden form for afbryder mellem forsyning og udstyr benyttes og mærkes som sådan. Afbrydere eller kontakter skal overholde en kendt standard som IEC947.
7. Hvor udstyr eller dæksler er mærket med dette symbol, er farlige spændinger normalt forekommende bagved. Disse dæksler bør kun afmonteres, når forsyningsspændingen er frakoblet - og da kun af instrueret servicepersonale. 
8. Hvor udstyr eller dæksler er mærket med dette symbol, forefindes meget varme overflader bagved. Disse dæksler bør kun afmonteres af instrueret servicepersonale, når forsyningsspænding er frakoblet. Visse overflader vil stadig være for varme at berøre i op til 45 minutter efter frakobling. 
9. Hvor udstyr eller dæksler er mærket med dette symbol, se da i betjeningsmanual for instruktion. 
10. Alle benyttede grafiske symboler i dette udstyr findes i én eller flere af følgende standarder:- EN61010-1, IEC417 & ISO3864.

## **BELANGRIJK**

**Veiligheidsinstructies voor de bedrading en installatie van dit apparaat.**



**Voor alle EU lidstaten zijn de volgende veiligheidsinstructies van toepassing. Om aan de geldende richtlijnen voor laagspanning te voldoen dient men zich hieraan strikt te houden. Ook niet EU lidstaten dienen zich aan het volgende te houden, tenzij de lokale wetgeving anders voorschrijft.**

1. Alle voorziene interne- en externe aardaansluitingen dienen op adequate wijze aangesloten te worden.
2. Na installatie, onderhouds- of reparatie werkzaamheden dienen alle beschermdeksels /kappen en aarding om reden van veiligheid weer aangebracht te worden.
3. Voedingskabels dienen te voldoen aan de vereisten van de normen IEC 227 of IEC 245.
4. Alle bedrading dient geschikt te zijn voor gebruik bij een omgevings temperatuur boven 75°C.
5. Alle gebruikte kabelwartels dienen dusdanige inwendige afmetingen te hebben dat een adequate verankering van de kabel wordt verkregen.
6. Om een veilige werking van de apparatuur te waarborgen dient de voeding uitsluitend plaats te vinden via een meerpoleige automatische zekering (min.10A) die alle spanningvoerende geleiders verbreekt indien een foutconditie optreedt. Deze automatische zekering mag ook voorzien zijn van een mechanisch bediende schakelaar. Bij het ontbreken van deze voorziening dient een andere als zodanig duidelijk aangegeven mogelijkheid aanwezig te zijn om de spanning van de apparatuur af te schakelen. Zekeringen en schakelaars dienen te voldoen aan een erkende standaard zoals IEC 947.
7. Waar de apparatuur of de beschermdeksels/kappen gemarkeerd zijn met het volgende symbool, kunnen zich hieronder spanning voerende delen bevinden die gevaar op kunnen leveren. Deze beschermdeksels/kappen mogen uitsluitend verwijderd worden door getraind personeel als de spanning is afgeschakeld. 
8. Waar de apparatuur of de beschermdeksels/kappen gemarkeerd zijn met het volgende symbool, kunnen zich hieronder hete oppervlakken of onderdelen bevinden. Bepaalde delen kunnen mogelijk na 45 min. nog te heet zijn om aan te raken. 
9. Waar de apparatuur of de beschermdeksels/kappen gemarkeerd zijn met het volgende symbool, dient men de bedieningshandleiding te raadplegen. 
10. Alle grafische symbolen gebruikt bij dit produkt zijn volgens een of meer van de volgende standaarden: EN 61010-1, IEC 417 & ISO 3864.

## **TÄRKEÄÄ**

**Turvallisuusohje, jota on noudatettava tämän laitteen asentamisessa ja kaapeloinnissa.**

**Seuraavat ohjeet pätevät erityisesti EU:n jäsenvaltioissa. Niitä täytyy ehdottomasti noudattaa jotta täytettäisiin EU:n matalajännittdirektiivin (Low Voltage Directive) yhteensopivuus. Myös EU:hun kuulumattomien valtioiden tulee noudattaa tätä ohjetta, elleivät kansalliset standardit estä sitä.**

1. Riittävät maadoituskytkennät on tehtävä kaikkiin maadoituspisteisiin, sisäisiin ja ulkoisiin.
2. Asennuksen ja vianetsinnän jälkeen on kaikki suojat ja suojamaat asennettava takaisin paikoilleen. Maadoitusliittimen kunnollinen toiminta täytyy aina ylläpitää.
3. Jännitesyöttöjohtimien täytyy täyttää IEC227 ja IEC245 vaatimukset.
4. Kaikkien johdotuksien tulee toimia >75°C lämpötiloissa.
5. Kaikkien läpivientiholkkien sisähalkaisijan täytyy olla sellainen että kaapeli lukkiutuu kun-nolla kiinni.
6. Turvallisen toiminnan varmistamiseksi täytyy jännitesyöttö varustaa turvakytkimellä (min 10A), joka kytkee irti kaikki jännitesyöttöjohtimet vikatilanteessa. Suojaan täytyy myös sisältyä mekaaninen erotuskytkin. Jos ei, niin jännitesyöttö on pystyttävä katkaisemaan muilla keinoilla ja merkittävä siten että se tunnistetaan sellaiseksi. Turvakytkimien tai katkaisimien täytyy täyttää IEC947 standardin vaatimukset näkyvyydestä.
7. Mikäli laite tai kosketussuoja on merkitty tällä merkillä on merkinnän takana tai alla hengenvaarallisen suuruinen jännite. Suojaa ei saa poistaa jänniteen ollessa kytkettynä laitteeseen ja poistamisen saa suorittaa vain alan asian-tuntija. 
8. Mikäli laite tai kosketussuoja on merkitty tällä merkillä on merkinnän takana tai alla kuuma pinta. Suojan saa poistaa vain alan asiantuntija kun jännite-syöttö on katkaistu. Tällainen pinta voi säilyä kosketuskuumana jopa 45 mi-nuuttia. 
9. Mikäli laite tai kosketussuoja on merkitty tällä merkillä katso lisäohjeita käyt-töohjekirjasta. 
10. Kaikki tässä tuotteessa käytetyt graafiset symbolit ovat yhdestä tai useammasta seuraavista standardeista: EN61010-1, IEC417 & ISO3864.

## **IMPORTANT**

**Consignes de sécurité concernant le raccordement et l'installation de cet appareil.**

**Les consignes de sécurité ci-dessous s'adressent particulièrement à tous les états membres de la communauté européenne. Elles doivent être strictement appliquées afin de satisfaire aux directives concernant la basse tension. Les états non membres de la communauté européenne doivent également appliquer ces consignes sauf si elles sont en contradiction avec les standards locaux ou nationaux.**

1. Un raccordement adéquat à la terre doit être effectuée à chaque borne de mise à la terre, interne et externe.
2. Après installation ou dépannage, tous les capots de protection et toutes les prises de terre doivent être remis en place, toutes les prises de terre doivent être respectées en permanence.
3. Les câbles d'alimentation électrique doivent être conformes aux normes IEC227 ou IEC245.
4. Tous les raccordements doivent pouvoir supporter une température ambiante supérieure à 75°C.
5. Tous les presse-étoupes utilisés doivent avoir un diamètre interne en rapport avec les câbles afin d'assurer un serrage correct sur ces derniers.
6. Afin de garantir la sécurité du fonctionnement de cet appareil, le raccordement à l'alimentation électrique doit être réalisé exclusivement au travers d'un disjoncteur (minimum 10A.) isolant tous les conducteurs en cas d'anomalie. Ce disjoncteur doit également pouvoir être actionné manuellement, de façon mécanique. Dans le cas contraire, un autre système doit être mis en place afin de pouvoir isoler l'appareil et doit être signalisé comme tel. Disjoncteurs et interrupteurs doivent être conformes à une norme reconnue telle IEC947.
7. Lorsque les équipements ou les capots affichent le symbole suivant, cela signifie que des tensions dangereuses sont présentes. Ces capots ne doivent être démontés que lorsque l'alimentation est coupée, et uniquement par un personnel compétent.
8. Lorsque les équipements ou les capots affichent le symbole suivant, cela signifie que des surfaces dangereusement chaudes sont présentes. Ces capots ne doivent être démontés que lorsque l'alimentation est coupée, et uniquement par un personnel compétent. Certaines surfaces peuvent rester chaudes jusqu'à 45 mn.
9. Lorsque les équipements ou les capots affichent le symbole suivant, se reporter au manuel d'instructions.
10. Tous les symboles graphiques utilisés dans ce produit sont conformes à un ou plusieurs des standards suivants: EN61010-1, IEC417 & ISO3864.



## **WICHTIG**

### **Sicherheitshinweise für den Anschluß und die Installation dieser Geräte.**

**Die folgenden Sicherheitshinweise sind in allen Mitgliederstaaten der europäischen Gemeinschaft gültig. Sie müssen strikt eingehalten werden, um der Niederspannungsrichtlinie zu genügen. Nichtmitgliedstaaten der europäischen Gemeinschaft sollten die national gültigen Normen und Richtlinien einhalten.**



1. Alle intern und extern vorgesehene Erdungen der Geräte müssen ausgeführt werden.
2. Nach Installation, Reparatur oder sonstigen Eingriffen in das Gerät müssen alle Sicherheitsabdeckungen und Erdungen wieder installiert werden. Die Funktion aller Erdverbindungen darf zu keinem Zeitpunkt gestört sein.
3. Die Netzspannungsversorgung muß den Anforderungen der IEC227 oder IEC245 genügen.
4. Alle Verdrahtungen sollten mindestens bis 75°C ihre Funktion dauerhaft erfüllen.
5. Alle Kabeldurchführungen und Kabelverschraubungen sollten in Ihrer Dimensionierung so gewählt werden, daß diese eine sichere Verkabelung des Gerätes ermöglichen.
6. Um eine sichere Funktion des Gerätes zu gewährleisten, muß die Spannungsversorgung über mindestens 10 A abgesichert sein. Im Fehlerfall muß dadurch gewährleistet sein, daß die Spannungsversorgung zum Gerät bzw. zu den Geräten unterbrochen wird. Ein mechanischer Schutzschalter kann in dieses System integriert werden. Falls eine derartige Vorrichtung nicht vorhanden ist, muß eine andere Möglichkeit zur Unterbrechung der Spannungszufuhr gewährleistet werden mit Hinweisen deutlich gekennzeichnet werden. Ein solcher Mechanismus zur Spannungsunterbrechung muß mit den Normen und Richtlinien für die allgemeine Installation von Elektrogeräten, wie zum Beispiel der IEC947, übereinstimmen.
7. Mit dem Symbol sind Geräte oder Abdeckungen gekennzeichnet, die eine gefährliche (Netzspannung) Spannung führen. Die Abdeckungen dürfen nur entfernt werden, wenn die Versorgungsspannung unterbrochen wurde. Nur geschultes Personal darf an diesen Geräten Arbeiten ausführen.
8. Mit dem Symbol sind Geräte oder Abdeckungen gekennzeichnet, in bzw. unter denen heiße Teile vorhanden sind. Die Abdeckungen dürfen nur entfernt werden, wenn die Versorgungsspannung unterbrochen wurde. Nur geschultes Personal darf an diesen Geräten Arbeiten ausführen. Bis 45 Minuten nach dem Unterbrechen der Netzzufuhr können derartig Teile noch über eine erhöhte Temperatur verfügen.
9. Mit dem Symbol sind Geräte oder Abdeckungen gekennzeichnet, bei denen vor dem Eingriff die entsprechenden Kapitel im Handbuch sorgfältig durchgelesen werden müssen.
10. Alle in diesem Gerät verwendeten graphischen Symbole entspringen einem oder mehreren der nachfolgend aufgeführten Standards: EN61010-1, IEC417 & ISO3864.



## **IMPORTANTE**

**Norme di sicurezza per il cablaggio e l'installazione dello strumento.**



**Le seguenti norme di sicurezza si applicano specificatamente agli stati membri dell'Unione Europea, la cui stretta osservanza è richiesta per garantire conformità alla Direttiva del Basso Voltaggio. Esse si applicano anche agli stati non appartenenti all'Unione Europea, salvo quanto disposto dalle vigenti normative locali o nazionali.**

1. Collegamenti di terra idonei devono essere eseguiti per tutti i punti di messa a terra interni ed esterni, dove previsti.
2. Dopo l'installazione o la localizzazione dei guasti, assicurarsi che tutti i coperchi di protezione siano stati collocati e le messa a terra siano collegate. L'integrità di ciascun morsetto di terra deve essere costantemente garantita.
3. I cavi di alimentazione della rete devono essere secondo disposizioni IEC227 o IEC245.
4. L'intero impianto elettrico deve essere adatto per uso in ambiente con temperature superiore a 75°C.
5. Le dimensioni di tutti i connettori dei cavi utilizzati devono essere tali da consentire un adeguato ancoraggio al cavo.
6. Per garantire un sicuro funzionamento dello strumento il collegamento alla rete di alimentazione principale dovrà essere eseguita tramite interruttore automatico (min.10A), in grado di disattivare tutti i conduttori di circuito in caso di guasto. Tale interruttore dovrà inoltre prevedere un sezionatore manuale o altro dispositivo di interruzione dell'alimentazione, chiaramente identificabile. Gli interruttori dovranno essere conformi agli standard riconosciuti, quali IEC947.
7. Il simbolo riportato sullo strumento o sui coperchi di protezione indica probabile presenza di elevati voltaggi. Tali coperchi di protezione devono essere rimossi esclusivamente da personale qualificato, dopo aver tolto alimentazione allo strumento. 
8. Il simbolo riportato sullo strumento o sui coperchi di protezione indica rischio di contatto con superfici ad alta temperatura. Tali coperchi di protezione devono essere rimossi esclusivamente da personale qualificato, dopo aver tolto alimentazione allo strumento. Alcune superfici possono mantenere temperature elevate per oltre 45 minuti. 
9. Se lo strumento o il coperchio di protezione riportano il simbolo, fare riferimento alle istruzioni del manuale Operatore. 
10. Tutti i simboli grafici utilizzati in questo prodotto sono previsti da uno o più dei seguenti standard: EN61010-1, IEC417 e ISO3864.

## **VIKTIG**

### **Sikkerhetsinstruks for tilkobling og installasjon av dette utstyret.**

**Følgende sikkerhetsinstruksjoner gjelder spesifikt alle EU medlemsland og land med i EØS-avtalen. Instruksjonene skal følges nøye slik at installasjonen blir i henhold til lavspenningsdirektivet. Den bør også følges i andre land, med mindre annet er spesifisert av lokale- eller nasjonale standarder.**



1. Passende jordforbindelser må tilkobles alle jordingspunkter, interne og eksterne hvor disse forefinnes.
2. Etter installasjon eller feilsøking skal alle sikkerhetsdeksler og jordforbindelser reetableres. Jordingsforbindelsene må alltid holdes i god stand.
3. Kabler fra spenningsforsyning skal oppfylle kravene spesifisert i IEC227 eller IEC245.
4. Alle ledningsforbindelser skal være konstruert for en omgivelsestemperatur høyere en 750°C.
5. Alle kabelforskrivninger som benyttes skal ha en indre dimensjon slik at tilstrekkelig avlastning oppnåes.
6. For å oppnå sikker drift og betjening skal forbindelsen til spenningsforsyningen bare skje gjennom en strømbryter (minimum 10A) som vil bryte spenningsforsyningen til alle elektriske kretser ved en feilsituasjon. Strømbryteren kan også inneholde en mekanisk operert bryter for å isolere instrumentet fra spenningsforsyningen. Dersom det ikke er en mekanisk operert bryter installert, må det være en annen måte å isolere utstyret fra spenningsforsyningen, og denne måten må være tydelig merket. Kretsbytere eller kontakter skal oppfylle kravene i en annerkjent standard av typen IEC947 eller tilsvarende.
7. Der hvor utstyr eller deksler er merket med symbol for farlig spenning, er det sannsynlig at disse er tilstede bak dekslet. Disse dekslene må bare fjernes når spenningsforsyning er frakoblet utstyret, og da bare av trenet servicepersonell. 
8. Der hvor utstyr eller deksler er merket med symbol for meget varm overflate, er det sannsynlig at disse er tilstede bak dekslet. Disse dekslene må bare fjernes når spenningsforsyning er frakoblet utstyret, og da bare av trenet servicepersonell. Noen overflater kan være for varme til å berøres i opp til 45 minutter etter spenningsforsyning frakoblet. 
9. Der hvor utstyret eller deksler er merket med symbol, vennligst referer til instruksjonsmanualen for instruksjer. 
10. Alle grafiske symboler brukt i dette produktet er fra en eller flere av følgende standarder: EN61010-1, IEC417 & ISO3864.



## **IMPORTANTE**

**Instruções de segurança para ligação e instalação deste aparelho.**

**As seguintes instruções de segurança aplicam-se especificamente a todos os estados membros da UE. Devem ser observadas rigidamente por forma a garantir o cumprimento da Directiva sobre Baixa Tensão. Relativamente aos estados que não pertençam à UE, deverão cumprir igualmente a referida directiva, exceptuando os casos em que a legislação local a tiver substituído.**

1. Devem ser feitas ligações de terra apropriadas a todos os pontos de terra, internos ou externos.
2. Após a instalação ou eventual reparação, devem ser recolocadas todas as tampas de segurança e terras de protecção. Deve manter-se sempre a integridade de todos os terminais de terra.
3. Os cabos de alimentação eléctrica devem obedecer às exigências das normas IEC227 ou IEC245.
4. Os cabos e fios utilizados nas ligações eléctricas devem ser adequados para utilização a uma temperatura ambiente até 75°C.
5. As dimensões internas dos buçins dos cabos devem ser adequadas a uma boa fixação dos cabos.
6. Para assegurar um funcionamento seguro deste equipamento, a ligação ao cabo de alimentação eléctrica deve ser feita através de um disjuntor (min. 10A) que desligará todos os condutores de circuitos durante uma avaria. O disjuntor poderá também conter um interruptor de isolamento accionado manualmente. Caso contrário, deverá ser instalado qualquer outro meio para desligar o equipamento da energia eléctrica, devendo ser assinalado convenientemente. Os disjuntores ou interruptores devem obedecer a uma norma reconhecida, tipo IEC947.
7. Sempre que o equipamento ou as tampas contiverem o símbolo, é provável a existência de tensões perigosas. Estas tampas só devem ser retiradas quando a energia eléctrica tiver sido desligada e por Pessoal da Assistência devidamente treinado. 
8. Sempre que o equipamento ou as tampas contiverem o símbolo, há perigo de existência de superfícies quentes. Estas tampas só devem ser retiradas por Pessoal da Assistência devidamente treinado e depois de a energia eléctrica ter sido desligada. Algumas superfícies permanecem quentes até 45 minutos depois. 
9. Sempre que o equipamento ou as tampas contiverem o símbolo, o Manual de Funcionamento deve ser consultado para obtenção das necessárias instruções. 
10. Todos os símbolos gráficos utilizados neste produto baseiam-se em uma ou mais das seguintes normas: EN61010-1, IEC417 e ISO3864.

## **IMPORTANTE**

**Instrucciones de seguridad para el montaje y cableado de este aparato.**

**Las siguientes instrucciones de seguridad, son de aplicacion especifica a todos los miembros de la UE y se adjuntaran para cumplir la normativa europea de baja tension.**



1. Se deben preveer conexiones a tierra del equipo, tanto externa como internamente, en aquellos terminales previstos al efecto.
2. Una vez finalizada las operaciones de mantenimiento del equipo, se deben volver a colocar las cubiertas de seguridad aasi como los terminales de tierra. Se debe comprobar la integridad de cada terminal.
3. Los cables de alimentacion electrica cumplan con las normas IEC 227 o IEC 245.
4. Todo el cableado sera adecuado para una temperatura ambiental de 75°C.
5. Todos los prensaestopas seran adecuados para una fijacion adecuada de los cables.
6. Para un manejo seguro del equipo, la alimentacion electrica se realizara a traves de un interruptor magnetotermico ( min 10 A ), el cual desconectara la alimentacion electrica al equipo en todas sus fases durante un fallo. Los interruptores estaran de acuerdo a la norma IEC 947 u otra de reconocido prestigio.
7. Cuando las tapas o el equipo lleve impreso el simbolo de tension electrica peligrosa, dicho alojamiento solamente se abra una vez que se haya interrumpido la alimentacion electrica al equipo asimismo la intervencion sera llevada a cabo por personal entrenado para estas labores.
8. Cuando las tapas o el equipo lleve impreso el simbolo, hay superficies con alta temperatura, por tanto se abra una vez que se haya interrumpido la alimentacion electrica al equipo por personal entrenado para estas labores, y al menos se esperara unos 45 minutos para enfriar las superficies calientes.
9. Cuando el equipo o la tapa lleve impreso el simbolo, se consultara el manual de instrucciones.
10. Todos los simbolos graficos usados en esta hoja, estan de acuerdo a las siguientes normas EN61010-1, IEC417 & ISO 3864.



## **VIKTIGT**

**Säkerhetsföreskrifter för kablage och installation av denna apparat.**



**Följande säkerhetsföreskrifter är tillämpliga för samtliga EU-medlemsländer. De skall följas i varje avseende för att överensstämja med Lågspännings direktivet. Icke EU medlemsländer skall också följa nedanstående punkter, såvida de inte övergrips av lokala eller nationella föreskrifter.**

1. Tillämplig jordkontakt skall utföras till alla jordade punkter, såväl internt som externt där så erfordras.
2. Efter installation eller felsökning skall samtliga säkerhetshöljen och säkerhetsjord återplaceras. Samtliga jordterminaler måste hållas obrutna hela tiden.
3. Matningsspänningens kabel måste överensstämja med föreskrifterna i IEC227 eller IEC245.
4. Allt kablage skall vara lämpligt för användning i en omgivningstemperatur högre än 75°C.
5. Alla kabelförskruvningar som används skall ha inre dimensioner som motsvarar adekvat kabelförankring.
6. För att säkerställa säker drift av denna utrustning skall anslutning till huvudströmmen endast göras genom en säkring (min 10A) som skall fränkoppla alla strömförande kretsar när något fel uppstår. Säkringen kan även ha en mekanisk fränskiljare. Om så inte är fallet, måste ett annat förfarande för att fränskilja utrustningen från strömförsörjning tillhandahållas och klart framgå genom markering. Säkring eller omkopplare måste överensstämja med en gällande standard såsom t ex IEC947.
7. Där utrustning eller hölje är markerad med vidstående symbol föreligger risk för livsfarlig spänning i närheten. Dessa höljen får endast avlägsnas när strömmen ej är ansluten till utrustningen - och då endast av utbildad servicepersonal. 
8. När utrustning eller hölje är markerad med vidstående symbol föreligger risk för brännskada vid kontakt med uppvärmd yta. Dessa höljen får endast avlägsnas av utbildad servicepersonal, när strömmen kopplats från utrustningen. Vissa ytor kan vara mycket varma att vidröra även upp till 45 minuter efter avstängning av strömmen. 
9. När utrustning eller hölje markerats med vidstående symbol bör instruktionsmanualen studeras för information. 
10. Samtliga grafiska symboler som förekommer i denna produkt finns angivna i en eller flera av följande föreskrifter:- EN61010-1, IEC417 & ISO3864.

## ΠΡΟΣΟΧΗ

### **Οδηγίες ασφαλείας για την καλωδίωση και εγκατάσταση της συσκευής.**

**Οι ακόλουθες οδηγίες ασφαλείας εφαρμόζονται ειδικά σε όλες τις χώρες μέλη της Ευρωπαϊκής Κοινότητας. Θα πρέπει να ακολουθούνται αυστηρά ώστε να εξασφαλιστεί η συμβατότητα με τις οδηγίες για τη Χαμηλή Τάση. Χώρες που δεν είναι μέλη της Ευρωπαϊκής Κοινότητας θα πρέπει επίσης να ακολουθούν τις οδηγίες εκτός εάν αντικαθίστανται από τα Τοπικά ή Εθνικά Πρότυπα.**

1. Επαρκείς συνδέσεις γείωσης θα πρέπει να γίνονται σε όλα τα σημεία γείωσης, εσωτερικά και εξωτερικά όπου υπάρχουν.
2. Μετά την εγκατάσταση ή την εκσφαλμάτωση όλα τα καλύματα ασφαλείας και οι γειώσεις ασφαλείας πρέπει να επανεγκαθίστανται. Η καλή κατάσταση όλων των ακροδεκτών γείωσης πρέπει να ελέγχεται και να συντηρείται διαρκώς.
3. Τα καλώδια τροφοδοσίας πρέπει να πληρούν τις απαιτήσεις των IEC227 ή IEC245.
4. Όλες οι καλωδιώσεις θα πρέπει να είναι κατάλληλες για χρήση σε ατμοσφαιρική θερμοκρασία χώρου υψηλότερη από 75°C.
5. Όλοι οι στυπιοθλίπτες θα πρέπει να είναι τέτοιων εσωτερικών διαστάσεων ώστε να παρέχουν επαρκή στερέωση των καλωδίων.
6. Για τη διασφάλιση ασφαλούς λειτουργίας της σύνδεσης τροφοδοσίας αυτής της συσκευής θα πρέπει να γίνεται μόνο μέσω ασφαλειοδιακόπτη (ελάχιστο 10A) ο οποίος θα αποσυνδέει όλους του ηλεκτροφόρους αγωγούς στη διάρκεια κατάστασης σφάλματος.  
Ο ασφαλειοδιακόπτης μπορεί επίσης να περιλαμβάνει μηχανικό διακόπτη απομόνωσης. Εάν δεν περιλαμβάνει, τότε άλλα μέσα αποσύνδεσης της συσκευής από την τροφοδοσία πρέπει να παροχρηθούν και σαφώς να σημειθούν σαν τέτοια. Οι ασφαλειοδιακόπτες ή διακόπτες πρέπει να συμφωνούν με αναγνωρισμένα πρότυπα όπως το IEC947.
7. Οπου συσκευές ή καλύματα είναι σημασμένα με το σύμβολο επικίνδυνες τάσεις ενυπάρχουν κάτω από αυτά. Αυτά τα καλύματα θα πρέπει να αφαιρούνται μόνο όταν έχει αφαιρεθεί η τροφοδοσία από τη συσκευή και τότε μόνο από ειδικευμένο τεχνικό προσωπικό.
8. Οπου συσκευές ή καλύματα είναι σημασμένα με το σύμβολο υπάρχει κίνδυνος από καυτές επιφάνειες κάτω από αυτά. Αυτά τα καλύματα θα πρέπει να αφαιρούνται μόνο από ειδικευμένο τεχνικό προσωπικό, όταν η τροφοδοσία έχει αφαιρεθεί από τη συσκευή. Τέτοιες επιφάνειες μπορούν να παραμείνουν ζεστές στην αφή έως και 45 λεπτά αργότερα.
9. Οπου συσκευές ή καλύματα είναι σημασμένα με το σύμβολο αναφερθείται στις οδηγίες χρήσης της συσκευής.
10. Όλα τα γραφικά σύμβολα που χρησιμοποιούνται σε αυτό το προϊόν είναι από ένα ή περισσότερα από τα έξης πρότυπα: EN61010-1, IEC417 και ISO3864.

---

# Appendix B      Returning Equipment to the Factory

---

Returning Material ..... page B-1

---

## RETURNING MATERIAL

If factory repair of defective equipment is required proceed as follows:

1. Secure a return authorization from an Emerson Process Management Sales Office or Representative before returning the equipment. Equipment must be returned with complete identification in accordance with Emerson Process Management instructions or it will not be accepted.

In no event will Emerson Process Management be responsible for equipment without proper authorization and identification.

2. Carefully pack defective unit in a sturdy box with sufficient shock absorbing material to ensure no additional damage will occur during shipping.
3. In a cover letter describe completely:
  - a. The symptoms that determined the equipment is faulty.
  - b. The environment in which the equipment was operating (housing, weather, vibration, dust, etc.).
  - c. Site from which equipment was removed.
  - d. Whether warranty service or nonwarranty service is requested.
  - e. Complete shipping instructions for the return of the equipment.
  - f. Reference the return authorization number.
4. Enclose a cover letter and purchase order and ship the defective equipment according to instructions provided in an Emerson Process Management Return Authorization, prepaid, to:

Emerson Process Management  
RMR Department  
6565P Davis Industrial Parkway  
Solon, Ohio 44139

If warranty service is requested, the defective unit will be carefully inspected and tested at the factory. If failure was due to conditions listed in the standard Emerson Process Management warranty, the defective unit will be repaired or replaced at Emerson Process Management's option, and an operating unit will be returned to the customer in accordance with shipping instructions furnished in the cover letter.

# OxyBalance Oxygen Display and Averaging System

**Instruction Manual**  
IM-106-4050 Original Issue  
March 2006

---

For equipment no longer under warranty, the equipment will be repaired at the factory and returned as directed by the purchase order and shipping instructions.

## **WARRANTY**

Emerson Process Management warrants that the equipment manufactured and sold by it will, upon shipment, be free of defects in workmanship or material. Should any failure to conform to this warranty become apparent during a period of one year after the date of shipment, Emerson Process Management shall, upon prompt written notice from the purchaser, correct such nonconformity by repair or replacement, F.O.B. factory of the defective part or parts. Correction in the manner provided above shall constitute a fulfillment of all liabilities of Emerson Process Management with respect to the quality of the equipment.

**THE FOREGOING WARRANTY IS EXCLUSIVE AND IN LIEU OF ALL OTHER WARRANTIES OF QUALITY WHETHER WRITTEN, ORAL, OR IMPLIED (INCLUDING ANY WARRANTY OF MERCHANTABILITY OF FITNESS FOR PURPOSE).**

The remedy(ies) provided above shall be purchaser's sole remedy(ies) for any failure of Emerson Process Management to comply with the warranty provisions, whether claims by the purchaser are based in contract or in tort (including negligence).

Emerson Process Management does not warrant equipment against normal deterioration due to environment. Factors such as corrosive gases and solid particulates can be detrimental and can create the need for repair or replacement as part of normal wear and tear during the warranty period.

Equipment supplied by Emerson Process Management but not manufactured by it will be subject to the same warranty as is extended to Emerson Process Management by the original manufacturer.

At the time of installation it is important that the required services are supplied to the system and that the electronic controller is set up at least to the point where it is controlling the sensor heater. This will ensure, that should there be a delay between installation and full commissioning that the sensor being supplied with ac power and reference air will not be subjected to component deterioration.

*Rosemount Analytical and the Rosemount Analytical logotype are registered trademarks of Rosemount Analytical Inc.  
HART is a registered trademark of the HART Communications Foundation.  
All other marks are the property of their respective owners.*

## **Emerson Process Management**

**Rosemount Analytical Inc.  
Process Analytic Division**  
6565P Davis Industrial Parkway  
Solon, OH 44139  
T (440) 914 1261  
F (440) 914 1271  
E [gas.csc@emersonprocess.com](mailto:gas.csc@emersonprocess.com)

**Fisher-Rosemount GmbH & Co.**  
Industriestrasse 1  
63594 Hasselroth  
Germany  
T +49 (0) 6055 884-0  
F +49 (0) 6055 884-209  
E [info.de@emersonprocess.com](mailto:info.de@emersonprocess.com)

**EUROPE, MIDDLE EAST,  
AFRICA**  
**Fisher-Rosemount Ltd.**  
Heath Place  
Bognor Regis  
West Sussex PO22 9SH  
England  
T 44-1243-863121  
F 44-1243-845354

**LATIN AMERICA**  
**Fisher - Rosemount**  
Av. das Americas  
Rio de Janeiro, RJ  
Brazil 22631-003  
T 55-21-2431-1882

**ASIA - PACIFIC**  
**Fisher-Rosemount  
Singapore Private Ltd.**  
1 Pandan Crescent  
Singapore 128461  
Republic of Singapore  
T +65 6777-8211  
F +65 6777-0947  
E [AP.RMT-Specialist@emersonprocess.com](mailto:AP.RMT-Specialist@emersonprocess.com)

<http://www.raihome.com>