

Instructional & Operating Manual

WAECO
mobile solutions

› **For CoolFreeze™ Series**
Portable Refrigerators/Freezers
CF-18, CF-25, CF-35,
CF-40, CF-50, CF-80, CF-110

 Safety indications in the text are marked with this symbol:

SAFETY INSTRUCTIONS

- **DANGER!** Never touch uninsulated cables with bare hands. This applies especially to handling AC cables.
- **DANGER!** When installed in a boat, and the device is operated with power cords, it is necessary that the system is protected by a fuse and an earth leakage protection device.
- Installation of AC in a boat/vehicle should be completed by a qualified technician.
- Always ensure that your refrigerator is disconnected from the battery before using a high-speed battery charger.
- Always ensure that the correct voltage is applied to the refrigerator, the voltage is stated on the refrigerator or cooling unit's data plate.
- Never open the cooling circuit.
- Always be aware that batteries contain corrosive acid and therefore should be treated with extreme care.
- The cooling device is not appropriate for transporting corrosive or solvent-comprising substances.
- Never obstruct vents to the refrigerator's compressor.
- Defrost the refrigerator on a regular basis.
- Never use hard or sharp instruments to remove ice from the liner.
- Never use abrasive or solvent based materials when cleaning the liner.
- When the refrigerator or cooling device comes to the end of its working life, it should be disposed of by appropriate person to ensure that it does not contaminate the environment.
- Do not use any electric appliance inside the cooling compartment.

GENERAL

APPLICATION AND OPERATIVE RANGE

The coolbox contains compartments with different temperature zones. The values for inside temperature are related to the middle of the box. Your cooler is designed to refrigerate or freeze food. The unit may also be used for remote purposes. If you wish to refrigerate medicines, first check if the refrigerator's cooling capacity meets the demands of the respective medicines. The refrigerator is designed to operate in ambient temperatures between 14°–120°F in a maximum air humidity of 90%. The refrigerator can operate continuously at an angle of 30° maximum. All materials which have been used in the manufacture of these appliances are generally recognized as fit for purpose. The refrigerant charge used in the cooling circuit is CFC-free.

INSTALLATION

After unpacking the device check that no parts are missing or the device has not been damaged. Place the cooling device in a dry place that is protected against splashing water. Devices equipped with a AC power pack must not be exposed to wet conditions. Assure that the appliance does not get wet. These units consist of two connections: for the (1) 12/24V DC and (2) 110/240V AC.

The unit should not be placed directly adjacent to sources of heat such as heating, gas ovens, hot water, pipes or under the blazing sun. The cooling unit must be installed in such a way that the air warmed up through the condenser can escape without problems.

BATTERY OPERATION

Your cooling device can be operated with 12V or 24V direct voltage. Prior to connection, check whether the voltage indication on the type plate is in accordance with the battery voltage.

Connect your cooling device as directly as possible to the poles of the battery or to a plug connection with at least 15 A fuse.

Pay attention that the plus-wire is connected on to the positive pole and the minus-one to the negative pole. In order to avoid loss of voltage and thus decrease of performance, the cable should be as short as possible and not interrupted. For this reason, avoid additional switches plugs or feeder boxes.

A fuse is located in the plug of the power cord.

If the connecting cable is too short or does not adhere to requirements of your model, you will need to purchase a suitable cable or an extension from a WAECO specialized dealer. Determine the required wire gauge by means of the following outline.

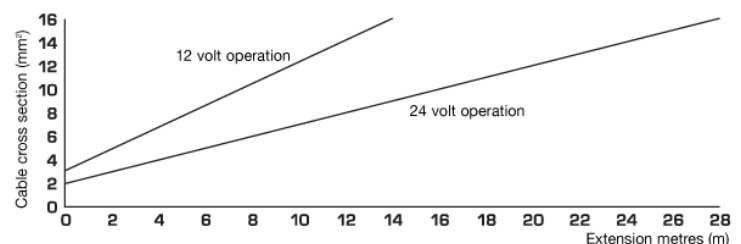

 **NOTE:** High-speed battery charges may only be connected to the battery after the cooling device and all other consumables have been disconnected from the battery.

 **NOTE:** Over-voltage may cause damage to the electronics of the unit.

The appliance consumes a small amount of idle current. Always disconnect it from the energy source when not in use. Your cooling device is equipped with a reverse polarity protection. It protects your cooling device against reverse polarity and against a short circuit. As a protection for your battery, the cooling device switches off automatically if the voltage is not sufficient. You will find the cut-out/cut-in voltages in the technical data.

OPERATION FROM HOUSEHOLD CURRENT: AC

CF-18, 25:

If you prefer to operate your CF unit from 110V AC household current, please use a WAECO AC adapter: MPS-50.

CF-35, 40, 50, 80, 110:

Your refrigerator/freezer is equipped with an integrated multi-voltage power supply (110-240V) and can be connected directly to alternating current. The integrated power supply is equipped with an automatic switchover to AC operation when the unit is connected to household current—although the DC cable is still connected. That is why the socket should be installed close to the unit and be easily accessible. After the security device is active, parts of the equipment still may be under voltage. During the switching process the red LED might blink for a few minutes.

 **ATTENTION, DANGER!:** Never manipulate plugs or switches with wet hands or when your feet are in contact with water! If you operate your cooling device on board a boat by means of shore connection to 110V, it will require the installation of an AC outlet if not already available.

CLEANING

Your cooling device will be delivered clean from the factory—but nonetheless you should clean prior to initial use. Take a cloth which has been slightly moistened with lukewarm water. Pay attention that no water falls into the seals and possibly damages the electronics. Dry off the cooling device with cloth after cleaning. Clean the device periodically or as soon as it is dirty.

 **ATTENTION:** Never use solvents or agents with sand or acid for cleaning the liner. Never use brushes, hard or sharp tools.

TURNING ON THE UNIT

Switch on the coolbox by pressing the “ON” button or pushing the slide switch to “high” for operation at a starter battery (or to “low” for the operation at a server battery). The LED near the switch “ON” button is a flashing light and flashes only if the

battery power is insufficient for supply of the coolbox. If this is the case, check your battery.

TURNING OFF THE UNIT

If you wish to turn off the cooling device for a longer period, remove the plug from the AC line or disconnect the cooling device cable from the battery. Clean the cooling device and leave the lid slightly open. The opened lid will prevent the formation of mold.

DEFROSTING

Air humidity can deposit on the evaporator or in the interior of the cooling device as frost thus reducing the refrigerating performance. Do not use hard or sharp tools to remove the frost. Doing so may damage the plastic or evaporator.

Allow ample time to defrost the unit. Take out the refrigerate products and store them in another cooling device so that they remain refrigerated. Switch off the unit and leave the lid open. Wipe any condensed water or empty the drip basin.

CHANGING THE LIGHT BULB

In case your coolbox is equipped with an interior light, the light bulb may be exchanged.

The transparent part of the lamp separates from the housing. Gently pry the transparent light cover off to expose the light bulb. Now you can exchange the bulb and put the lamp back into the housing.

TIPS FOR ENERGY SAVING

- Mount the refrigerator in a cool, dry place away from direct sunlight.
- Always allow food to cool before storing in the refrigerator.
- Defrost your refrigerator periodically or when the liner is covered with thick layer of ice.
- Do not set the thermostat colder than the required temperature.
- Do not leave the lid or the door open any longer than necessary.
- Always ensure that the compressor and condenser are in a well ventilated area.

STANDARDS, DIRECTIVES

These appliances meet the following directives.

72/23/EEG - Low Voltage Directive

89/336/EEG - EMU directive

95/54/EEG

CF Series with automatic

AC/DC operation are UL listed.

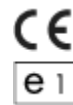

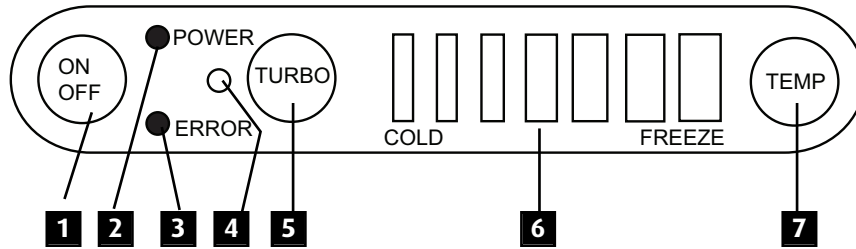

**OPERATOR CONTROL PANEL FOR:
CF-25, CF-35, CF-40, CF-50, CF-80, CF-110**

- 1.) **Power Switch.** Press for ON or OFF
- 2.) **Power Control LED.** Green LED is lit when the appliance is ON. Yellow LED is lit when the preset temperature is reached.
- 3.) **Error LED.** Flashes red in case system is not ready to operate.
- 4.) **Turbo Control LED.** Lights yellow to indicate the turbo mode is switched on.
- 5.) **Turbo Switch.** Press for fast cooling. Will switch off when preset temperature is reached. Press to switch off.
- 6.) **Temperature LEDs.** Seven LEDs indicate a temperature range from +50°F to 0°F.
- 7.) **Temperature Switch.** Press once to activate next LED. Hold to cycle all available settings.

OPERATOR CONTROL PANEL FOR: CF-18

Temperature control by rotational electronic thermostat. Power LED switches from green to yellow when preset temperature is reached.

**CONNECTOR PANEL
(EQUIPMENT DEPENDING ON APPLIANCE TYPE)**

- 1.) **Socket for AC power.** Not available on CF-18 or CF-25.
- 2.) **Fuse.**
- 3.) **Switch for setting battery voltage.** Values according to specification table.
- 4.) **Emergency Switch.** Should be in "OFF" position for normal operation. "ON" position keeps cooling function running continuously and bypasses the control panel in case of electronic defect. (not on CF-18)
- 5.) **Socket for DC supply.**

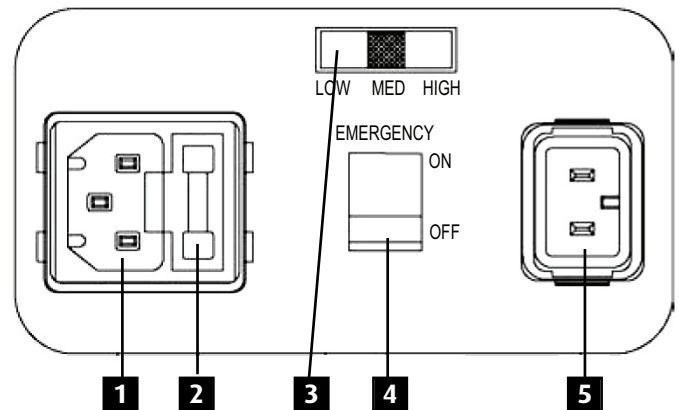

CF SERIES • COOLFREEZE™							
SPECIFICATIONS	CF-18	CF-25	CF-35	CF-40	CF-50	CF-80	CF-110
CAPACITY	.7 Cu. Ft.	.9 Cu. Ft.	1.1 Cu. Ft.	1.3 Cu. Ft.	1.7 Cu. Ft.	2.8 Cu. Ft.	3.7 Cu. Ft.
SYSTEM	Direct Evaporator						
TEMPERATURE	+50°F to 0°F						
WEIGHT	27 lbs.	26.5 lbs.	33 lbs.	37 lbs.	44 lbs.	62 lbs.	73 lbs.
POWER CONSUMPTION	power input x running time per hour						
RUNNING TIME PER HOUR							
Ti = 41°F, Ta = 68°F	9%	11%	12%	13%	10%	25%	30%
Ti = 41°F, Ta = 89°F	13%	16%	17%	18%	15%	35%	40%
NOMINAL 12V DC CURRENT	3.1 A	6.8 A	6.0 A	6.0 A	7.0 A	7.5 A	7.5 A
24V DC	1.9 A	3.0 A	3.0 A	3.0 A	3.0 A	3.5 A	3.5 A
110V AC			1.3-0.7 A	1.3 - 0.7 A	1.3 - 0.7 A	1.3 - 0.7 A	1.3 - 0.7 A
MATERIALS	Injection molded housing with integrated rollbond evaporator; blow molded lid; PU foam insulation						
COMPRESSOR	Fully hermetical Danfoss BD35F compressor with control electronics and integrated low voltage protection for 12V and 24V DC. Dynamic ventilated condenser, aluminum rollbond evaporator, electronics reverse polarity protection, adjustable electronic thermostat						
BATTERY CONTROLLER	The coolbox is equipped with a battery controller cutting the compressor in or out in order to protect the battery and the compressor.						
CUT OUT VOLTAGE	low	high		low	med	high	
12V	10.4	11.5		10.4	11.0	12.0	
24V	22.1	24.0		24.6	23.3	25.0	
CUT IN VOLTAGE	low	high		low	med	high	
12V	11.5	12.5		11.2	1.0	12.9	
24V	23.6	25.4		23.0	24.5	26.3	

CF-18

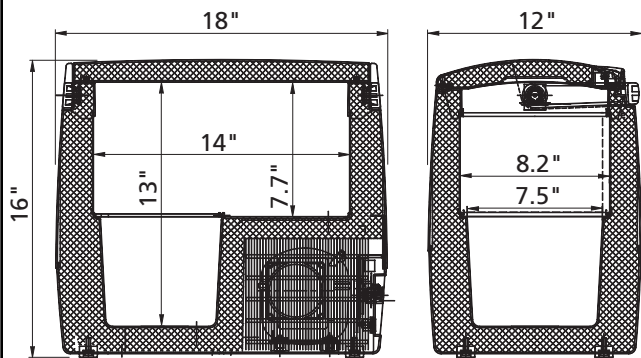

CF-25

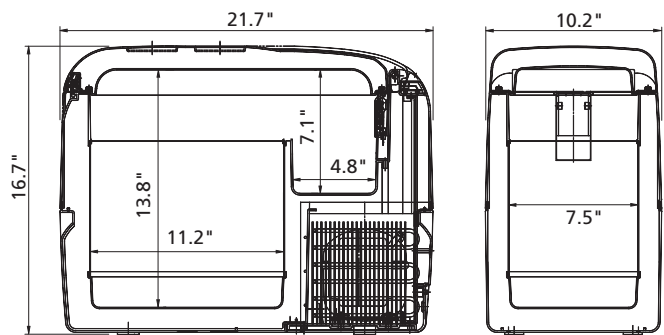

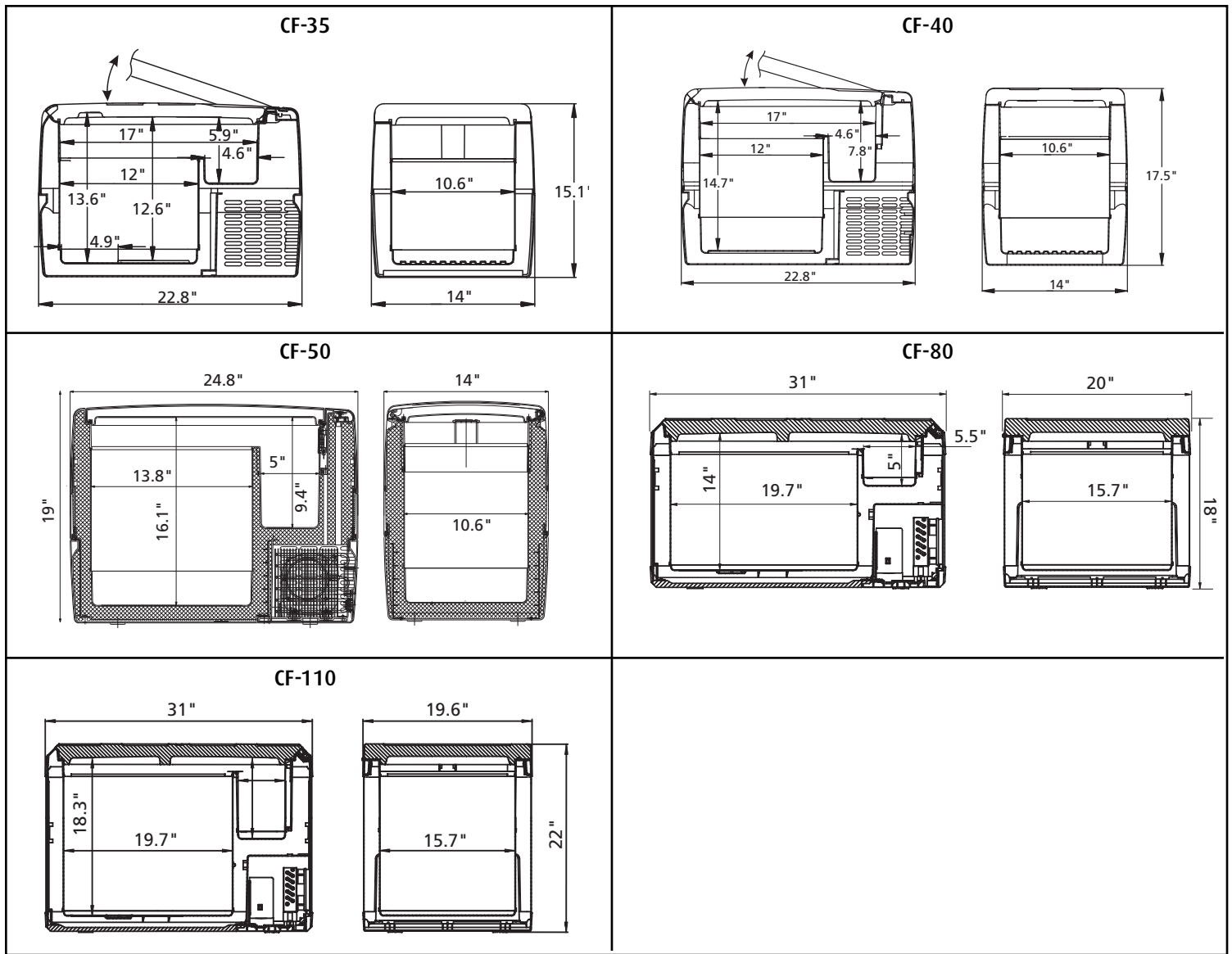

IMPORTANT INFORMATION • LIMITED WARRANTY

WAECO USA LIMITED WARRANTY

WAECO USA, Inc. warrants its products to be free of defects in materials and workmanship for the periods specified below subject to the specified conditions and limitations. *What WAECO Will Do:* Repair or replace (choice of remedy at Company's discretion) goods or parts that prove to be defective in materials or workmanship after examination by a factory representative or authorized service dealer.

How long Coverage Lasts: COMPRESSOR PRODUCTS

Labor: WAECO will pay for necessary labor from an authorized service agent for one year from date of purchase or third party installation. For OEM factory installed products the duration is one year from the date of purchase of the vehicle (vessel).

Parts: WAECO will pay for necessary parts for two years from the date of purchase or third party installation. For OEM factory installed products the duration is two years from the date of purchase of the vehicle (vessel).

What is Not Covered:

1. Damages due to accident, misuse, abuse, normal wear, improper installation, lack of reasonable and necessary maintenance, transportation, corrosion, tampering, improper repair, unusual physical or electrical stress or recharging of the coolant.
2. Electric light bulbs or replaceable fuses.
3. Failures due to use of the products in applications for which they are not intended.
4. Warranty coverage following unauthorized service.
5. Warranty coverage following transfer of ownership.

How State Law Relates to this Warranty:

This warranty gives you specific legal rights, and you also have other rights, which vary from State to State.

THERE ARE NO OTHER WARRANTIES OF MERCHANTABILITY, FITNESS FOR PURPOSE OR ANY OTHER KIND. ANY EXPRESSED OR IMPLIED ARE HEREBY DISCLAIMED AND EXCLUDED. THE COMPANY SHALL NOT BE LIABLE FOR CONSEQUENTIAL DAMAGES TO YACHTS, EQUIPMENT OR OTHER PROPERTY OR PERSONS DUE TO ANY FAILURE OF WAECO USA PRODUCTS. THIS WARRANTY IS EXPRESSLY PROVIDED IN LIEU OF ALL OTHER WARRANTIES EITHER EXPRESSED OR IMPLIED.