

SIEMENS

RUGGEDCOM RS8000

Installation Guide

Preface

Introduction

1

Installing the Device

2

Communication Ports

3

Technical Specifications

4

Dimension Drawings

5

Certification

6

Copyright © 2014 Siemens Canada Ltd.

All rights reserved. Dissemination or reproduction of this document, or evaluation and communication of its contents, is not authorized except where expressly permitted. Violations are liable for damages. All rights reserved, particularly for the purposes of patent application or trademark registration.

This document contains proprietary information, which is protected by copyright. All rights are reserved. No part of this document may be photocopied, reproduced or translated to another language without the prior written consent of Siemens Canada Ltd..

Disclaimer Of Liability

Siemens has verified the contents of this manual against the hardware and/or software described. However, deviations between the product and the documentation may exist.

Siemens shall not be liable for any errors or omissions contained herein or for consequential damages in connection with the furnishing, performance, or use of this material.

The information given in this document is reviewed regularly and any necessary corrections will be included in subsequent editions. We appreciate any suggested improvements. We reserve the right to make technical improvements without notice.

Registered Trademarks

ROX™, Rugged Operating System On Linux™, CrossBow™ and eLAN™ are trademarks of Siemens Canada Ltd.. ROS® is a registered trademark of Siemens Canada Ltd..

Other designations in this manual might be trademarks whose use by third parties for their own purposes would infringe the rights of the owner.

Third Party Copyrights

Siemens recognizes the following third party copyrights:

- Copyright © 2004 GoAhead Software, Inc. All Rights Reserved.

Security Information

Siemens provides products and solutions with industrial security functions that support the secure operation of plants, machines, equipment and/or networks. They are important components in a holistic industrial security concept. With this in mind, Siemens' products and solutions undergo continuous development. Siemens recommends strongly that you regularly check for product updates.

For the secure operation of Siemens products and solutions, it is necessary to take suitable preventive action (e.g. cell protection concept) and integrate each component into a holistic, state-of-the-art industrial security concept. Third-party products that may be in use should also be considered. For more information about industrial security, visit <http://www.siemens.com/industrialsecurity>.

To stay informed about product updates as they occur, sign up for a product-specific newsletter. For more information, visit <http://support.automation.siemens.com>.

Warranty

Siemens warrants this product for a period of five (5) years from the date of purchase, conditional upon the return to factory for maintenance during the warranty term. This product contains no user-serviceable parts. Attempted service by unauthorized personnel shall render all warranties null and void. The warranties set forth in this article are exclusive and are in lieu of all other warranties, performance guarantees and conditions whether written or oral, statutory, express or implied (including all warranties and conditions of merchantability and fitness for a particular purpose, and all warranties and conditions arising from course of dealing or usage or trade). Correction of nonconformities in the manner and for the period of time provided above shall constitute the Seller's sole liability and the Customer's exclusive remedy for defective or nonconforming goods or services whether claims of the Customer are based in contract (including fundamental breach), in tort (including negligence and strict liability) or otherwise.

For warranty details, visit www.siemens.com/ruggedcom or contact a Siemens customer service representative.

Contacting Siemens

Address

Siemens Canada Ltd.
Industry Sector
300 Applewood Crescent
Concord, Ontario
Canada, L4K 5C7

Telephone

Toll-free: 1 888 264 0006
Tel: +1 905 856 5288
Fax: +1 905 856 1995

E-mail

ruggedcom.info.i-ia@siemens.com

Web

www.siemens.com/ruggedcom

Table of Contents

Preface	v
Alerts	v
Related Documents	v
Accessing Documentation	v
Training	vi
Customer Support	vi
 Chapter 1	
Introduction	1
1.1 Feature Highlights	1
1.2 Ports, Controls and Indicator LEDs	2
 Chapter 2	
Installing the Device	5
2.1 Mounting the Device	5
2.1.1 Mounting the Device on a DIN Rail	6
2.1.2 Mounting the Device to a Rack	6
2.1.3 Mounting the Device to a Panel	7
2.2 Connecting Power	8
2.2.1 Connecting AC Power	9
2.2.2 Connecting DC Power	9
2.3 Connecting the Failsafe Alarm Relay	10
2.4 Grounding the Device	11
2.5 Connecting to the Device	11
2.6 Cabling Recommendations	12
 Chapter 3	
Communication Ports	13
 Chapter 4	
Technical Specifications	15
4.1 Power Supply Specifications	15
4.2 Failsafe Relay Specifications	15
4.3 Fiber Optic Ethernet Port Specifications	16
4.4 Operating Environment	16
4.5 Mechanical Specifications	16

Chapter 5
Dimension Drawings 17

Chapter 6
Certification 19

- 6.1 Agency Approvals 19
- 6.2 FCC Compliance 19
- 6.3 Industry Canada Compliance 19
- 6.4 EMI and Environmental Type Tests 20

Preface

This guide describes the RUGGEDCOM RS8000. It describes the major features of the device, installation, commissioning and important technical specifications.

It is intended for use by network technical support personnel who are responsible for the installation, commissioning and maintenance of the device. It is also recommended for use by network and system planners, system programmers, and line technicians.

Alerts

The following types of alerts are used when necessary to highlight important information.



DANGER!

DANGER alerts describe imminently hazardous situations that, if not avoided, will result in death or serious injury.



WARNING!

WARNING alerts describe hazardous situations that, if not avoided, may result in serious injury and/or equipment damage.



CAUTION!

CAUTION alerts describe hazardous situations that, if not avoided, may result in equipment damage.



IMPORTANT!

IMPORTANT alerts provide important information that should be known before performing a procedure or step, or using a feature.



NOTE

NOTE alerts provide additional information, such as facts, tips and details.

Related Documents

Other documents that may be of interest include:

- *ROS User Guide for the RS8000*

Accessing Documentation

The latest Hardware Installation Guides and Software User Guides for most RUGGEDCOM products are available online at www.siemens.com/ruggedcom.

For any questions about the documentation or for assistance finding a specific document, contact a Siemens sales representative.

Training

Siemens offers a wide range of educational services ranging from in-house training of standard courses on networking, Ethernet switches and routers, to on-site customized courses tailored to the customer's needs, experience and application.

Siemens' Educational Services team thrives on providing our customers with the essential practical skills to make sure users have the right knowledge and expertise to understand the various technologies associated with critical communications network infrastructure technologies.

Siemens' unique mix of IT/Telecommunications expertise combined with domain knowledge in the utility, transportation and industrial markets, allows Siemens to provide training specific to the customer's application.

For more information about training services and course availability, visit www.siemens.com/ruggedcom or contact a Siemens sales representative.

Customer Support

Customer support is available 24 hours, 7 days a week for all Siemens customers. For technical support or general information, please contact Siemens Customer Support through any of the following methods:

- **Online**

Visit <http://www.siemens.com/automation/support-request> to submit a Support Request (SR) or check on the status of an existing SR.

- **Telephone**

Call a local hotline center to submit a Support Request (SR). To locate a local hotline center, visit <http://www.automation.siemens.com/mcms/aspa-db/en/automation-technology/Pages/default.aspx>.

- **Mobile App**

Install the Industry Online Support app by Siemens AG on any Android, Apple iOS or Windows mobile device and be able to:

- Access Siemens's extensive library of support documentation, including FAQs, manuals, and much more
- Submit SRs or check on the status of an existing SR
- Find and contact a local contact person
- Ask questions or share knowledge with fellow Siemens customers and the support community via the forum
- And much more...

Introduction

The RUGGEDCOM RS8000 provides substation hardened, fully managed, Ethernet switches specifically designed to operate reliably in electrically and environmentally harsh environments.

The RS8000's Zero-Packet-Loss technology provides a high level of immunity to electromagnetic interference (EMI) and heavy electrical surges typical of environments found in electric utility substations, industrial plant floors or in curb side traffic control cabinets. The RS8000 model provides IEEE 1613 Class 2 error-free communications performance under EMI stress. An operating temperature range of -40 to 85 °C (-40 to 185 °F) allows the RS8000 to be placed in almost any location.

The RS8000 provides a wide range of power supply options suitable for multiple industries and for worldwide operability. Options include 24 VDC, 48 VDC, and HI (88-300 VDC or 85-264 VAC)

The RS8000 offers advanced Layer 2 and 3 networking features and network management via the Rugged Operating System (ROS). A unique feature of ROS is the performance of its IEEE 802.1w Rapid Spanning Tree Protocol (RSTP) used for implementing fault tolerant ring and mesh network architectures. The protocol has been optimized to support ring sizes of up to 160 switches and fault recovery times in the order of less than 5 ms per switch.

The RS8000's superior ruggedized design coupled with the Rugged Operating System (ROS) provides improved system reliability and advanced networking features making it ideally suited for creating Ethernet networks for mission-critical, real-time control applications.

Section 1.1

Feature Highlights

Ethernet Ports

- Eight 100Base-FX
- Multi-mode and single-mode optical transceivers
- Industry standard fiber optical connectors: MTRJ, LC

Rated for Reliability in Harsh Environments

- Immunity to EMI and heavy electrical surges
 - Zero-Packet-Loss™ Technology
 - Meets IEEE 1613 Class 2 (electric utility substations)
 - Exceeds IEC 61850-3 (electric utility substations)
 - Exceeds IEC 61800-3 (variable speed drive systems)
 - Exceeds IEC 61000-6-2 (generic industrial)
 - Exceeds NEMA TS-2 (traffic control equipment)
- -40 to 85 °C (-40 to 185 °F) operating temperature (no fans)
- Failsafe Output Relay: For critical failure or error alarming
- Conformal coated printed circuit boards (optional)

Cyber Security Features

- Multi-level user passwords
- SSH/SSL (128-bit encryption)
- Enable/disable ports, MAC based port security
- Port based network access control (802.1x)
- VLAN (802.1Q) to segregate and secure network traffic
- RADIUS centralized password management
- SNMPv3 authentication and 56-bit encryption

Management Tools

- Web-based, Telnet, CLI management interfaces
- SNMP v1/v2/v3 (56-bit encryption)
- Remote Monitoring (RMON)
- Rich set of diagnostics with logging and alarms

Universal Power Supply Options

- Universal high-voltage range: 88-300 VDC or 85-264 VAC
- Popular low voltage ranges: 24 VDC (10-36 VDC), 48 VDC (36-59 VDC)
- Terminal blocks for reliable maintenance free connections
- CSA/UL 60950 safety approved to 85 °C (185 °F)

Section 1.2

Ports, Controls and Indicator LEDs

The RS8000 features various ports, controls and indicator LEDs on the front and rear panels for configuring and troubleshooting the device.

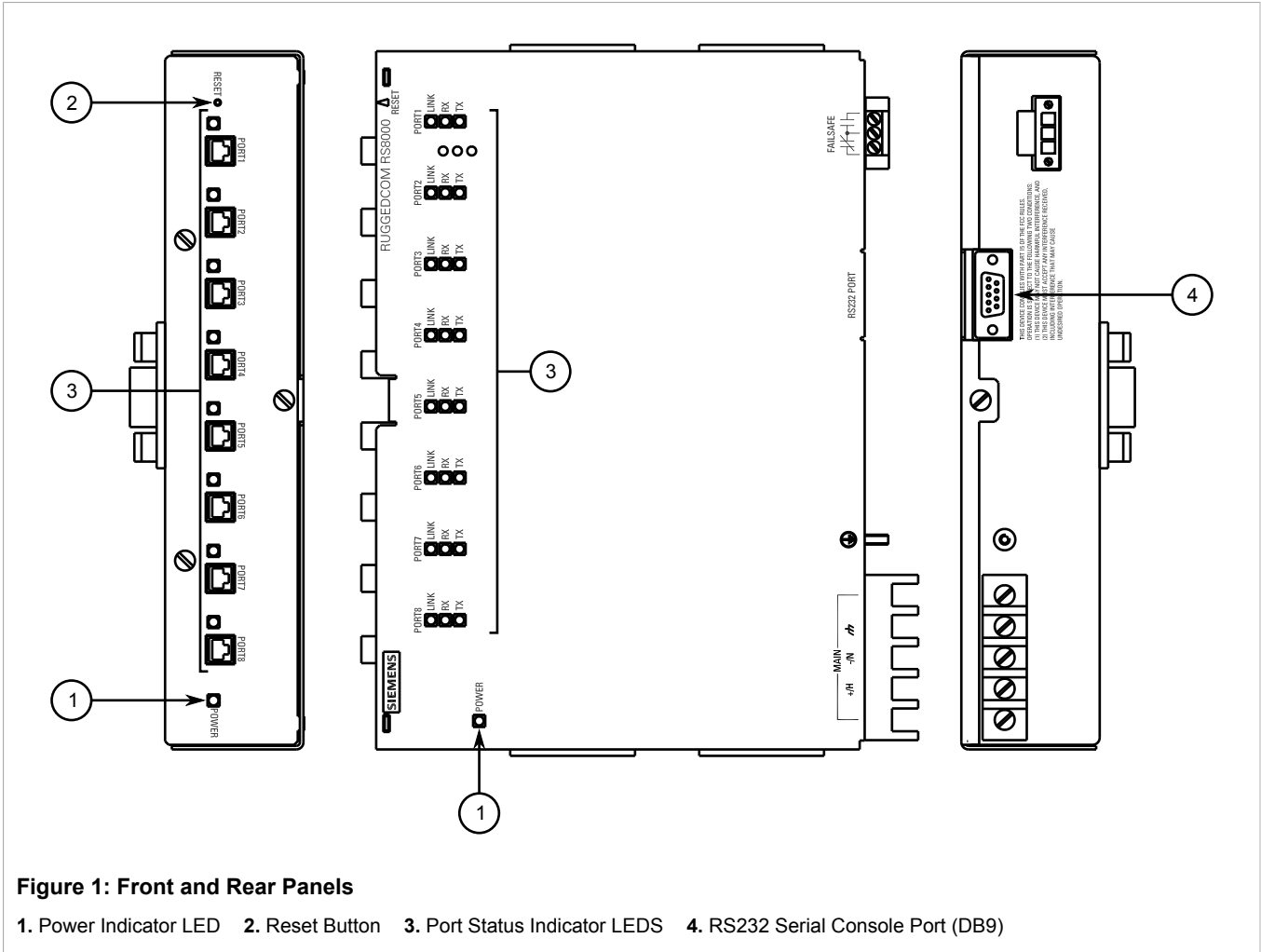

Figure 1: Front and Rear Panels

1. Power Indicator LED 2. Reset Button 3. Port Status Indicator LEDs 4. RS232 Serial Console Port (DB9)

Power Indicator LED

This LED indicates the status of the power supply.

- Green = The power supply is supplying power
- Off = Power is off

Reset Button

The reset button shuts down and restarts the device.

Port Status Indicator LEDs

These LEDs indicate when serial ports are active.

LED	State	Meaning
Link	Solid	Link detected
	Off	No link detected
RX	Blinking	Link activity (receiving)
	Off	No link activity
TX	Blinking	Link activity (transmitting)
	Off	No link activity

RS232 Serial Console Port

This port is for interfacing directly with the device and accessing initial management functions.

2 Installing the Device

The following sections describe how to install the device, including mounting the device, installing/removing modules, connecting power, and connecting the device to the network.



DANGER!

Electrocution hazard – risk of serious personal injury and/or damage to equipment. Before performing any maintenance tasks, make sure all power to the device has been disconnected and wait approximately two minutes for any remaining energy to dissipate.



IMPORTANT!

This product contains no user-serviceable parts. Attempted service by unauthorized personnel shall render all warranties null and void.

Changes or modifications not expressly approved by Siemens Canada Ltd. could invalidate specifications, test results, and agency approvals, and void the user's authority to operate the equipment.



IMPORTANT!

This product should be installed in a restricted access location where access can only be gained by authorized personnel who have been informed of the restrictions and any precautions that must be taken. Access must only be possible through the use of a tool, lock and key, or other means of security, and controlled by the authority responsible for the location.

- [Section 2.1, “Mounting the Device”](#)
- [Section 2.2, “Connecting Power”](#)
- [Section 2.3, “Connecting the Failsafe Alarm Relay”](#)
- [Section 2.4, “Grounding the Device”](#)
- [Section 2.5, “Connecting to the Device”](#)
- [Section 2.6, “Cabling Recommendations”](#)

Section 2.1

Mounting the Device

The RS8000 is designed for maximum mounting and display flexibility. It can be equipped with connectors that allow it to be installed in a 48 cm (19 in) rack, 35 mm (1.4 in) DIN rail, or directly on a panel.



NOTE

For detailed dimensions of the device with either rack, DIN rail or panel hardware installed, refer to [Chapter 5, Dimension Drawings](#).

The following sections describe the various methods of mounting the device:

- [Section 2.1.1, “Mounting the Device on a DIN Rail”](#)
- [Section 2.1.2, “Mounting the Device to a Rack”](#)

- Section 2.1.3, “Mounting the Device to a Panel”

Section 2.1.1

Mounting the Device on a DIN Rail

To mount the device to a standard 35 mm (1.4 in) DIN rail, do the following:

1. Align the adapters with the DIN rails and slide the device into place.

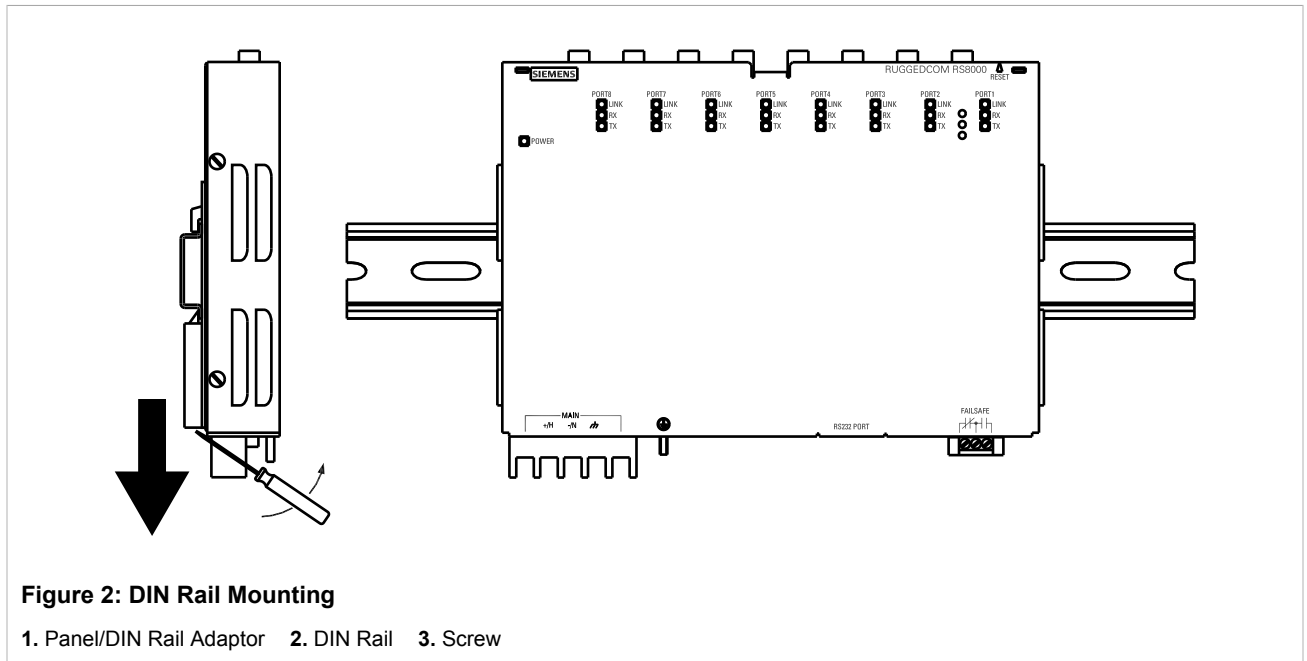

Figure 2: DIN Rail Mounting

1. Panel/DIN Rail Adaptor 2. DIN Rail 3. Screw

2. Install one of the supplied screws on either side of the device to secure the adapters to the DIN rails.

Section 2.1.2

Mounting the Device to a Rack

To secure the device to a standard 48 cm (19 in) rack, do the following:

1. Remove the four screws from the side of the device.
2. Insert the device into rack mount adapter and use the screws to secure it.



NOTE

The device can be installed with the communication ports facing the front or rear of the rack, depending on the desired orientation.

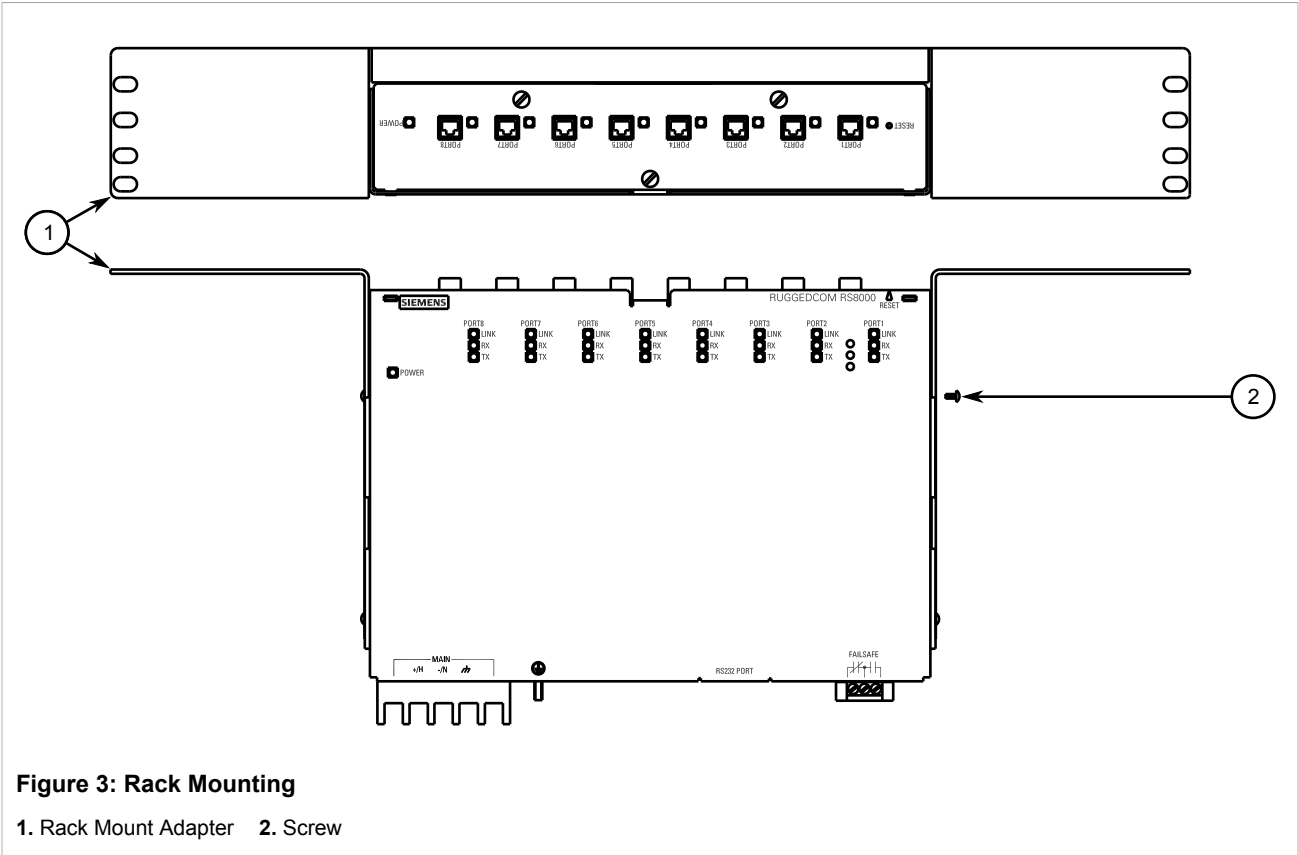

3. Insert the rack mount adapter and device assembly into the rack.



NOTE

Since heat within the device is channelled to the enclosure, it is recommended that 1 rack-unit of space, or 44 mm (1.75 in), be kept empty above the device. This allows a small amount of convectional airflow.

Forced airflow is not required. However, any increase in airflow will result in a reduction of ambient temperature and improve the long-term reliability of all equipment mounted in the rack space.

4. Secure the adapter to the rack using the supplied hardware.

Section 2.1.3

Mounting the Device to a Panel

To mount the device to a panel, do the following:

1. Place the device against the panel and align the adapters with the mounting holes.

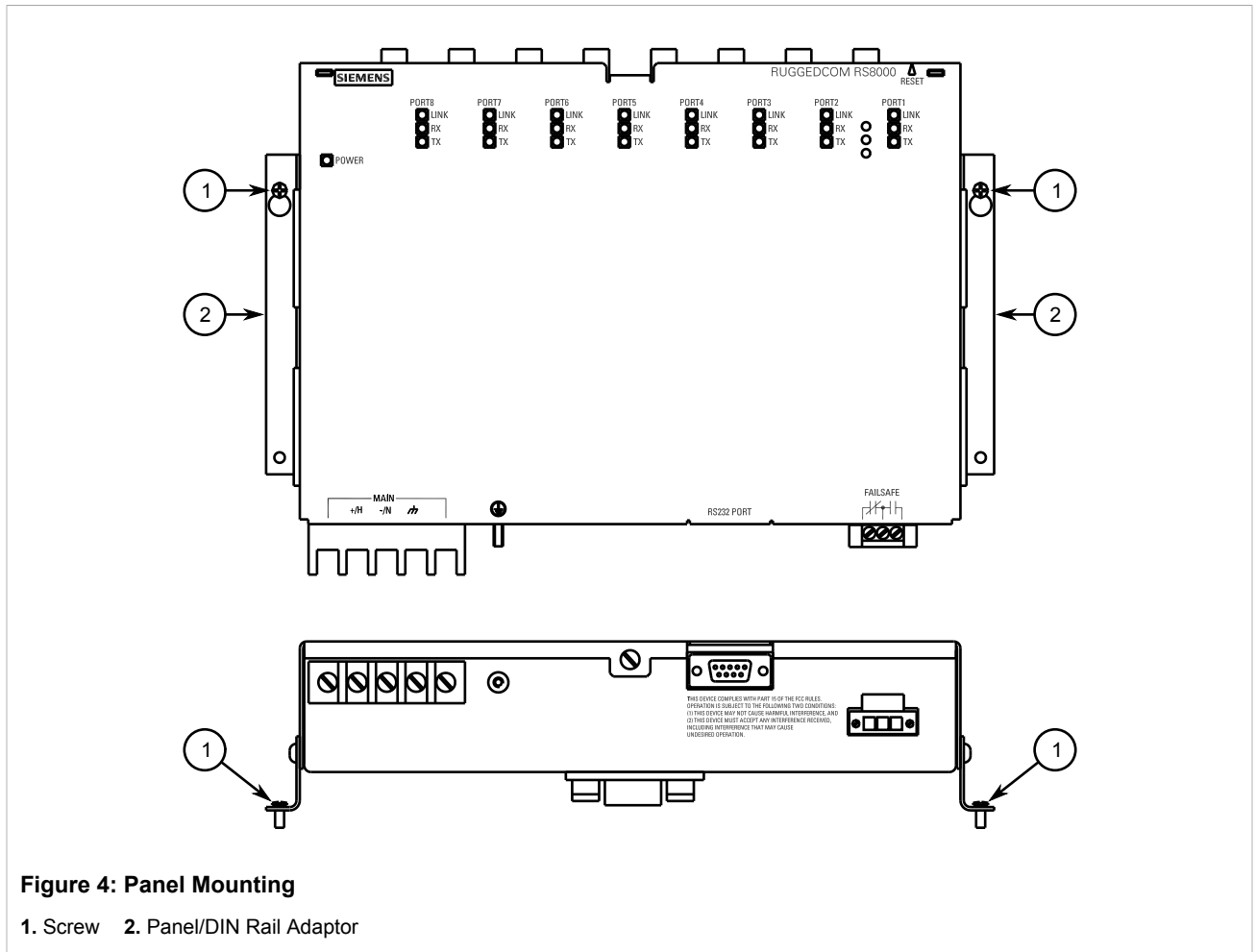

Figure 4: Panel Mounting

1. Screw 2. Panel/DIN Rail Adaptor

2. Install the supplied screws to secure the adaptors to the panel.

Section 2.2

Connecting Power

The RS8000 supports a single integrated high AC/DC or low DC power supply



IMPORTANT!

- For 88-300 VDC rated equipment, an appropriately rated circuit breaker must be installed.
- For 100-240 VAC rated equipment, an appropriately rated circuit breaker must be installed.
- Use only #16 gage wiring when connecting terminal blocks.
- A circuit breaker is not required for 12, 24 or 48 VDC rated equipment.
- Power input terminals have reverse polarity protection for 12, 24 and 48 VDC rated equipment.
- Equipment must be installed according to applicable local wiring codes and standards.

The following sections describe how to connect power to the device:

- [Section 2.2.1, “Connecting AC Power”](#)
- [Section 2.2.2, “Connecting DC Power”](#)

Section 2.2.1

Connecting AC Power

To connect a high AC power supply to the device, do the following:



CAUTION!

Electrical hazard – risk of damage to equipment. Before testing the dielectric strength (HIPOT) in the field, remove the braided ground cable connected to the surge ground terminal and chassis ground. This cable connects transient suppression circuitry to chassis ground and must be removed in order to avoid damage to transient suppression circuitry during testing.

1. Connect the positive wire from the power source to the positive/hot (+/H) terminal on the terminal block.

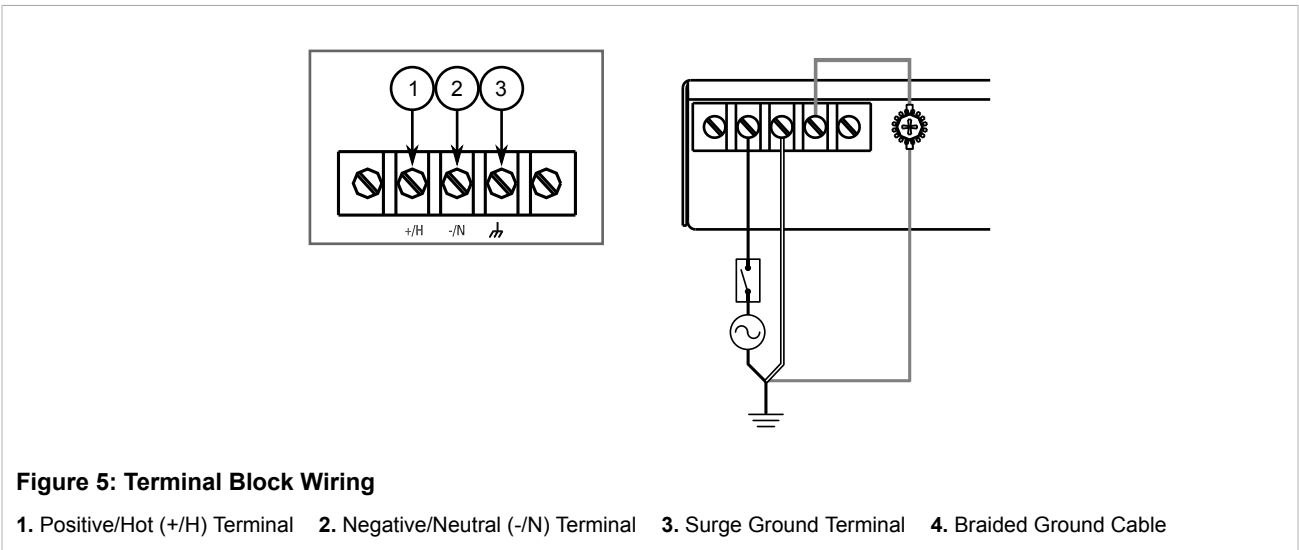

2. Connect the negative wire from the power source to the negative/neutral (-/N) terminal on the terminal block.
3. Using a braided wire or other appropriate grounding wire, connect the surge ground terminal to the chassis ground connection. The surge ground terminal is used as the ground conductor for all surge and transient suppression circuitry internal to the unit.
4. Connect the ground terminal on the power source to the chassis ground terminal on the device. For more information, refer to [Section 2.4, “Grounding the Device”](#).

Section 2.2.2

Connecting DC Power

To connect a high or low DC power supply to the device, do the following:



CAUTION!

Electrical hazard – risk of damage to equipment. Before testing the dielectric strength (HIPOT) in the field, remove the braided ground cable connected to the surge ground terminal and chassis ground.

This cable connects transient suppression circuitry to chassis ground and must be removed in order to avoid damage to transient suppression circuitry during testing.

1. Connect the positive wire from the power source to the positive/hot (+/L) terminal on the terminal block.

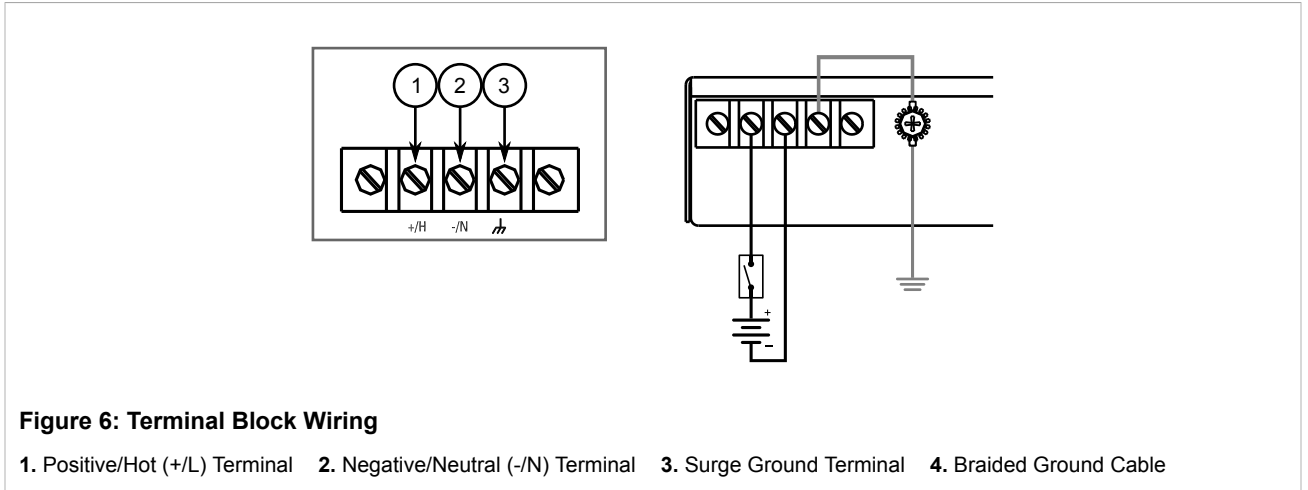

2. Connect the negative wire from the power source to the negative/neutral (-/N) on the terminal block.
3. Using a braided wire or other appropriate grounding wire, connect the surge ground terminal to the chassis ground connection. The surge ground terminal is used as the ground conductor for all surge and transient suppression circuitry internal to the unit.
4. Connect the ground terminal on the power source to the chassis ground terminal on the device. For more information, refer to [Section 2.4, "Grounding the Device"](#).

Section 2.3

Connecting the Failsafe Alarm Relay

The failsafe relay can be configured to latch based on alarm conditions. The NO (Normally Open) contact is closed when the unit is powered and there are no active alarms. If the device is not powered or if an active alarm is configured, the relay opens the NO contact and closes the NC (Normally Closed) contact.



NOTE

Control of the failsafe relay output is configurable through ROS. One common application for this relay is to signal an alarm if a power failure occurs. For more information, refer to the ROS User Guide for the RS8000.

The following shows the proper relay connections.

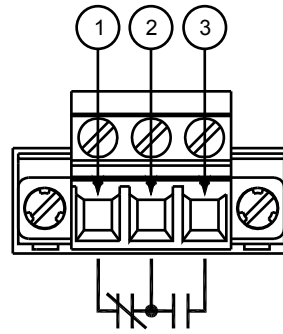

Figure 7: Failsafe Alarm Relay Wiring

1. Normally Closed 2. Common 3. Normally Open

Section 2.4

Grounding the Device

The RS8000 chassis ground terminal uses a #6-32 screw. It is recommended to terminate the ground connection with a #6 ring lug and torque it to 1.7 N·m (15 lbf·in).

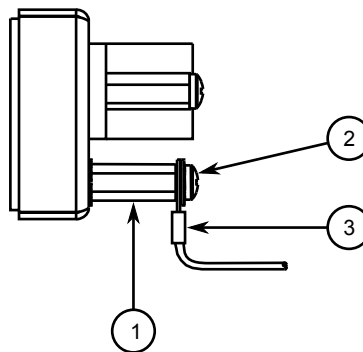

Figure 8: Chassis Ground Connection

1. Stainless Steel Stud 2. #6-32 Screw 3. #6 Ring Lug

Section 2.5

Connecting to the Device

The following describes the various methods for accessing the ROS console and Web interfaces on the device. For more detailed instructions, refer to the *ROS User Guide* for the RS8000.

Serial Console Port

Connect a PC or terminal directly to the serial console port to access the boot-time control and ROS console interface.



IMPORTANT!

The serial console port is intended to be used only as temporary connections during initial configuration or troubleshooting.

The serial console port implements RS232 DCE (Data Communication Equipment) on a DB9 connector. The following is the pin-out for the port:

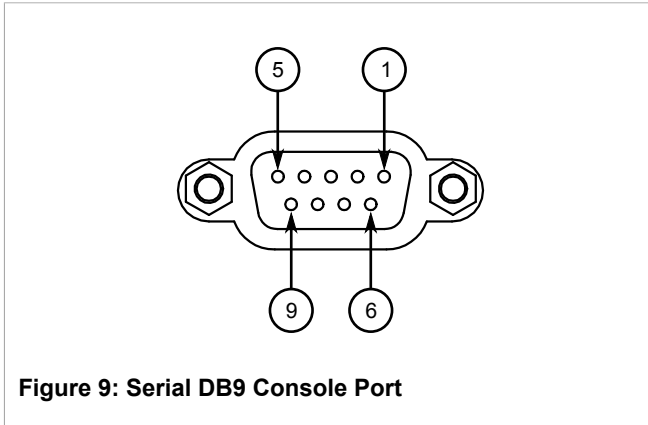

Pin	Name	Description
1	DCD	Data Carrier Detect
2	RX	Receive Data
3	TX	Transmit Data
4	DTR	Data Terminal Ready
5	GND	Signal Ground
6	DSR	Data Set Ready
7	RTS	Request to Send
8	CTS	Clear To Send
9		Reserved (Do Not Connect)

Figure 9: Serial DB9 Console Port

Communication Ports

Connect any of the available Ethernet ports on the device to a management switch and access the ROS console and Web interfaces via the device's IP address. For more information about available ports, refer to [Chapter 3, Communication Ports](#).

Section 2.6

Cabling Recommendations

Siemens does not recommend the use of copper cabling of any length for critical, real-time substation automation applications. All copper Ethernet ports on RUGGEDCOM products include transient suppression circuitry to protect against damage from electrical transients and conform with IEC 61850-3 and IEEE 1613 Class 1 standards. This means that during a transient electrical event, communications errors or interruptions may occur, but recovery is automatic.

Siemens also does not recommend using copper Ethernet ports to interface with devices in the field across distances that could produce high levels of ground potential rise (i.e. greater than 2500 V), during line-to-ground fault conditions.

3 Communication Ports

Fiber optic Ethernet ports are available with either MTRJ (Mechanical Transfer Registered Jack) or LC (Lucent Connector) connectors. Make sure the Transmit (Tx) and Receive (Rx) connections of each port are properly connected and matched to establish a proper link.

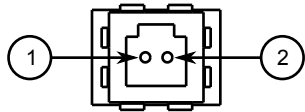

Figure 10: MTRJ Port

1. Tx Connector 2. Rx Connector

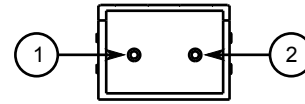

Figure 11: LC Port

1. Tx Connector 2. Rx Connector

For specifications on the available fiber optic Ethernet ports, refer to [Section 4.3, "Fiber Optic Ethernet Port Specifications"](#).

4 Technical Specifications

The following sections provide important technical specifications related to the device and available modules:

- [Section 4.1, “Power Supply Specifications”](#)
- [Section 4.2, “Failsafe Relay Specifications”](#)
- [Section 4.3, “Fiber Optic Ethernet Port Specifications”](#)
- [Section 4.4, “Operating Environment”](#)
- [Section 4.5, “Mechanical Specifications”](#)

Section 4.1

Power Supply Specifications

Power Supply Type	Input Range		Internal Fuse Rating ^{ab}	Maximum Power Consumption ^c
	Minimum	Maximum		
12-24 VDC	10 VDC	36 VDC	6.3 A(F)	15 W
24 VDC	18 VDC	36 VDC	5 A(F)	
48 VDC	36 VDC	59 VDC	3.15 A(T)	
HI (125/250 VDC) ^d	88 VDC	300 VDC	3.15 A(T)	
HI (110/230 VAC) ^d	85 VAC	265 VAC	3.15 A(T)	

^a (F) denotes fast-acting fuse

^b (T) denotes time-delay fuse.

^c Power consumption varies based on configuration. 10/100Base-TX ports consume roughly 1 W less than fiber optic ports.

^d This is the same power supply for both AC and DC.

Section 4.2

Failsafe Relay Specifications

Voltage	Current
30 VAC	0.3 A
30 VDC	1 A
80 VDC	0.3 A

Section 4.3

Fiber Optic Ethernet Port Specifications

The following details the specifications for fiber optic Ethernet ports that can be ordered with the RS8000.

Mode ^e	Connector Type	Cable Type (µm)	Tx λ (typ.) (nm)	Tx min. (dBm)	Tx max. (dBm)	Rx Sensitivity (dBm)	Rx Saturation (dBm)	Distance (typ.) (km)	Power Budget (dB)
MM	MTRJ	50/125	1310	-16	-11	-33.5	-11	2	17
SM	LC	9/125	1310	-15	-8	-31	-5	15	16.5

^e MM = Multi-Mode, SM = Single-Mode

Section 4.4

Operating Environment

Parameter	Range	Comments
Ambient Operating Temperature	-40 to 85°C	Ambient Temperature as measured from a 30 cm radius surrounding the center of the enclosure.
Ambient Relative Humidity	5% to 95%	Non-condensing
Ambient Storage Temperature	-40 to 85°C	

Section 4.5

Mechanical Specifications

Parameter	Value
Dimensions	Refer to Chapter 5, Dimension Drawings
Weight	2.25 kg (5 lbs)
Ingress Protection	IP40 (1 mm or 0.04 in objects)
Enclosure	18 AWG Galvanized Steel

5 Dimension Drawings



NOTE

All dimensions are in millimeters, unless otherwise stated.

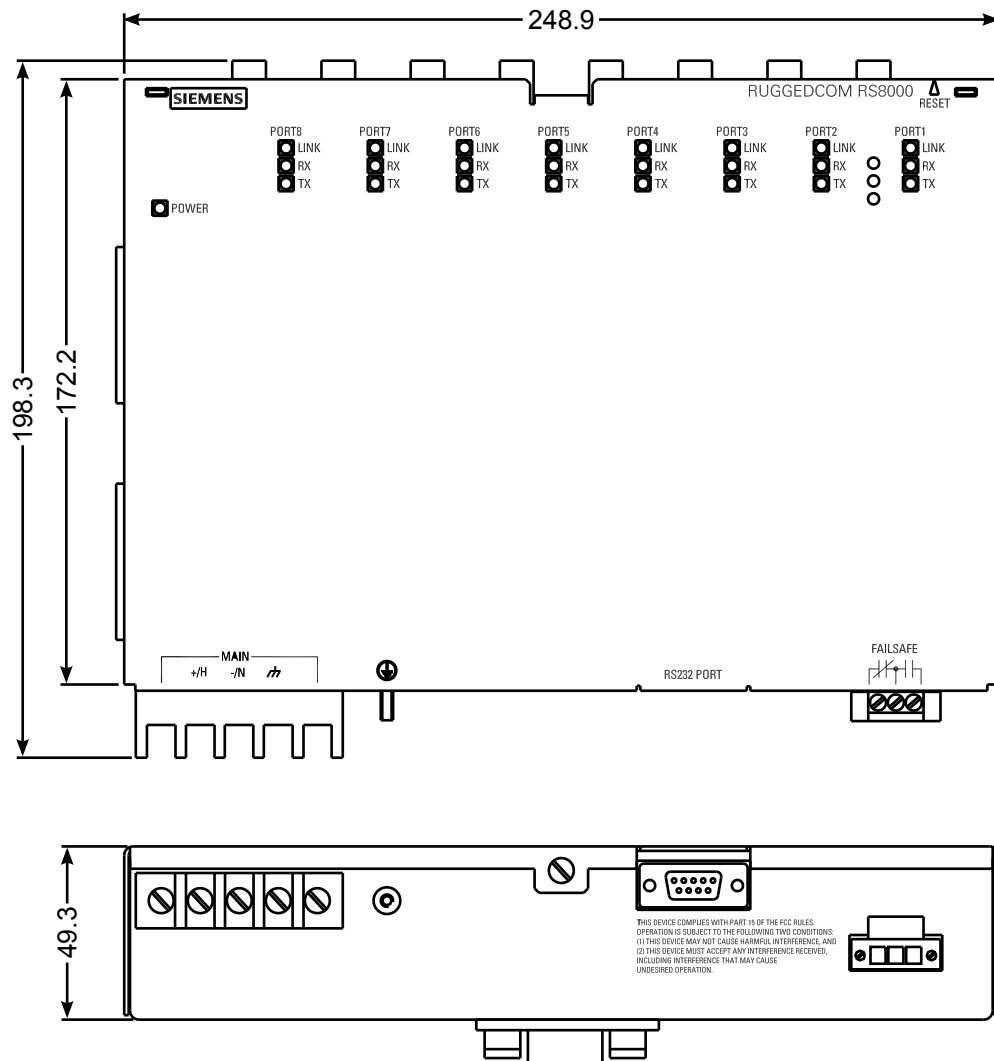

Figure 12: Overall Dimensions

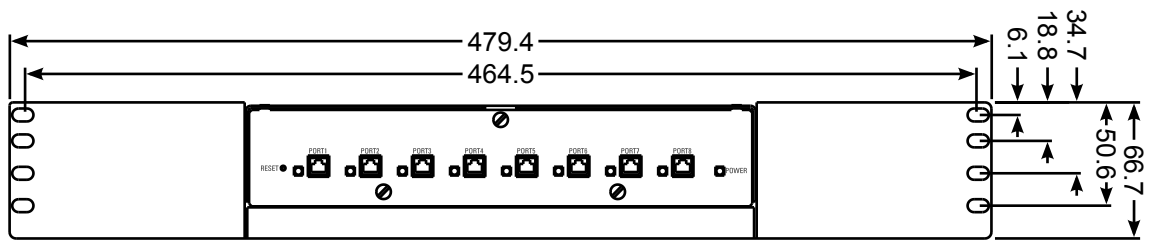

Figure 13: Rack Mount Dimensions

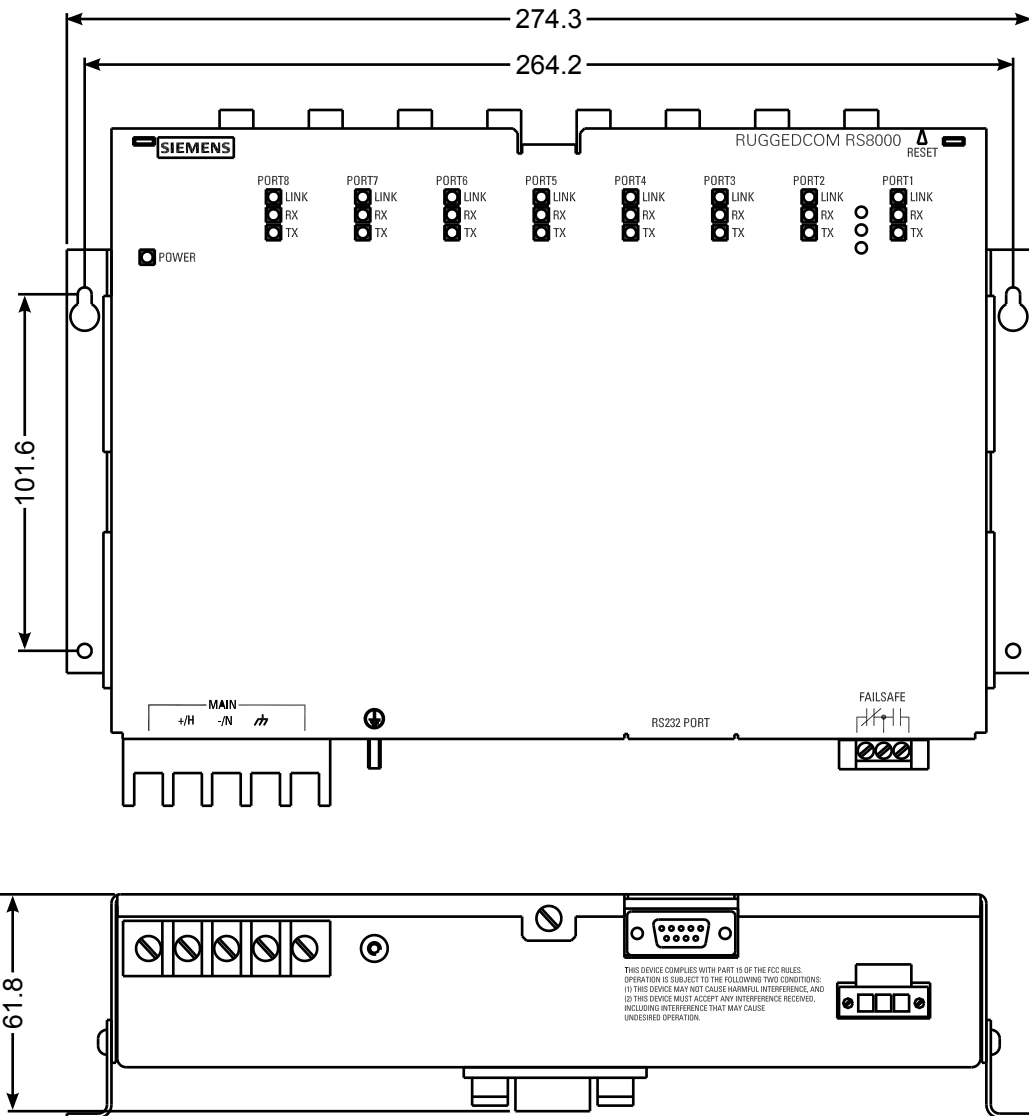

Figure 14: Panel and Din Rail Mount Dimensions

6 Certification

The RS8000 device has been thoroughly tested to guarantee its conformance with recognized standards and has received approval from recognized regulatory agencies.

- [Section 6.1, “Agency Approvals”](#)
- [Section 6.2, “FCC Compliance”](#)
- [Section 6.3, “Industry Canada Compliance”](#)
- [Section 6.4, “EMI and Environmental Type Tests”](#)

Section 6.1

Agency Approvals

The RS8000 has received approval from various agencies.

Agency	Standards	Comments
CSA	CSA C22.2 No. 60950-1, UL 60950-1	Approved
CE	EN 60950-1, EN 61000-6-2, EN 50581, EN 55022, EN 60825-1	CE Compliance is claimed via Declaration of Self Conformity Route
FCC	FCC Part 15, Class A	Approved

Section 6.2

FCC Compliance

This equipment has been tested and found to comply with the limits for a Class A digital device pursuant to Part 15 of the FCC Rules. These limits are designed to provide reasonable protection against harmful interference when the equipment is operated in a commercial environment.

This equipment generates, uses and can radiate radio frequency energy and, if not installed and used in accordance with the instruction manual, may cause harmful interference to radio communications. Operation of this equipment in a residential area is likely to cause harmful interference in which case the user will be required to correct the interference on his own expense.

Section 6.3

Industry Canada Compliance

CAN ICES-3 (A) / NMB-3 (A)

Section 6.4

EMI and Environmental Type Tests

The RS8000 has passed the following EMI and environmental tests.

IEC 61850-3 Type Tests

Test	Description	Test Levels	Severity Levels	
IEC 61000-4-2	ESD	Enclosure Contact	+/- 8 kV	4
		Enclosure Air	+/- 15 kV	4
IEC 61000-4-3	Radiated RFI	Enclosure ports	20 V/m	x
IEC 61000-4-4	Burst (Fast Transient)	Signal ports	+/- 4 kV @ 2.5 kHz	x
		DC Power ports	+/- 4 kV	4
		AC Power ports	+/- 4 kV	4
		Earth ground ports	+/- 4 kV	4
IEC 61000-4-5	Surge	Signal ports	+/- 4 kV line-to-earth, +/- 2 kV line-to-line	4
		DC Power ports	+/- 2 kV line-to-earth, +/- 1 kV line-to-line	3
		AC Power ports	+/- 4 kV line-to-earth, +/- 2 kV line-to-line	4
IEC 61000-4-6	Induced (Conducted) RFI	Signal ports	10 V	3
		DC Power ports	10 V	3
		AC Power ports	10 V	3
		Earth ground ports	10 V	3
IEC 61000-4-8	Magnetic Field	Enclosure ports	40 A/m continuous, 1000 A/m for 1 s	
IEC 61000-4-29	Voltage Dips and Interrupts	DC Power ports	30% for 0.1 s, 60% for 0.1 s, 100% for 0.05 s	
		AC Power ports	30% for 1 period, 60% for 50 periods	
IEC 61000-4-11			100% for 5 periods, 100% for 50 periods	
IEC 61000-4-12	Damped Oscillatory	Signal ports	2.5 kV common, 1 kV differential mode @ 1 MHz	3
		DC Power ports	2.5 kV common, 1 kV differential mode @ 1 MHz	3
		AC Power ports	2.5 kV common, 1 kV differential mode @ 1 MHz	3
IEC 61000-4-16	Mains Frequency Voltage	Signal ports	30 V Continuous, 300 V for 1 s	4
		DC Power ports	30 V Continuous, 300 V for 1 s	4
IEC 61000-4-17	Ripple on DC Power Supply	DC Power ports	10%	3

Test	Description		Test Levels	Severity Levels
IEC 60255-5	Dielectric Strength	Signal ports	2 kVAC (Fail-Safe Relay output)	
		DC Power ports	1.5 kVDC	
		AC Power ports	2 kVDC	
	HV Impulse	Signal ports	5 kV (Fail-Safe Relay Output)	
		DC Power ports	5 kV	
		AC Power ports	5 kV	

IEEE 1613 (C37.90.x) EMI Immunity Type Tests



NOTE

The RS8000 meets Class 2 requirements for an all-fiber configuration and Class 1 requirements for copper ports.

IEEE Test	IEEE 1613 Clause	Description		Test Levels
C37.90.3	9	ESD	Enclosure Contact	+/- 8 kV
			Enclosure Air	+/- 15 kV
C37.90.2	8	Radiated RFI	Enclosure ports	35 V/m
C37.90.1	7	Fast Transient	Signal ports	+/- 4 kV @ 2.5 kHz
			DC Power ports	+/- 4 kV
			AC Power ports	+/- 4 kV
			Earth ground ports	+/- 4 kV
		Oscillatory	Signal ports	2.5 kV common mode @ 1MHz
			DC Power ports	2.5 kV common and differential mode @ 1MHz
C37.90	6	HV Impulse	Signal ports	5 kV (Failsafe Relay)
			DC Power ports	5 kV
			AC Power ports	5 kV
		Dielectric Strength	Signal ports	2 kVAC (Failsafe Relay)
			DC Power ports	1.5 kVDC
			AC Power ports	2 kVAC

Environmental Type Tests

Test	Description		Test Levels	Severity Levels
IEC 60068-2-1	Cold Temperature	Test Ad	-40 °C (-40 °F), 16 Hours	
IEC 60068-2-2	Dry Heat	Test Bd	85 °C (185 °F), 16 Hours	

Test	Description		Test Levels	Severity Levels
IEC 60068-2-30	Humidity (Damp Heat, Cyclic)	Test Db	95% (non-condensing), 55 °C (131 °F), 6 cycles	
IEC 60255-21-1	Vibration		2 g @ 10-150 Hz	Class 2
IEC 60255-21-2	Shock		30 g @ 11 ms	Class 2