



magicolor[®] 2490MF Facsimile User's Guide

4556-9598-02A

1800799-001C

Thank You

Thank you for purchasing a magicolor 2490MF. You have made an excellent choice. This User's Guide describes operating procedures and precautions for the use of the Fax functions. Be sure to read this User's Guide before starting any machine operations.

In order to ensure correct use of the Fax functions, read this User's Guide, and then store it where it can immediately be referred to when necessary.

Trademarks

KONICA MINOLTA and the KONICA MINOLTA logo are trademarks or registered trademarks of KONICA MINOLTA HOLDINGS, INC.

magicolor and PageScope are trademarks or registered trademarks of KONICA MINOLTA BUSINESS TECHNOLOGIES, INC.

All other trademarks and registered trademarks are the property of their respective owners.

Copyright Notice

Copyright © 2006 KONICA MINOLTA BUSINESS TECHNOLOGIES, INC., Marunouchi Center Building, 1-6-1 Marunouchi, Chiyoda-ku, Tokyo, 100-0005, Japan. All Rights Reserved. This document may not be copied, in whole or part, nor transferred to any other media or language, without written permission of KONICA MINOLTA BUSINESS TECHNOLOGIES, INC.

Manual Notice

KONICA MINOLTA BUSINESS TECHNOLOGIES, INC. reserves the right to make changes to this guide and to the equipment described herein without notice. Considerable effort has been made to ensure that this guide is free of inaccuracies and omissions. However, KONICA MINOLTA BUSINESS TECHNOLOGIES, INC. makes no warranty of any kind including, but not limited to, any implied warranties of merchantability and fitness for a particular purpose with regard to this guide. KONICA MINOLTA BUSINESS TECHNOLOGIES, INC. assumes no responsibility for, or liability for, errors contained in this guide or for incidental, special, or consequential damages arising out of the furnishing of this guide, or the use of this guide in operating the equipment, or in connection with the performance of the equipment when so operated.

Contents

1 Introduction	1
Machine Parts 2	
Front View 2	
Rear View 3	
2 Control Panel and Configuration Menu	5
About the Control Panel 6	
Fax Mode Screen 10	
About the Fax Mode Screen 10	
About the Function Mode Screen 10	
Entering Fax Mode 11	
Symbol list 11	
Configuration Menu Overview 12	
Configuration Menu 17	
MACHINE SETTING 18	
FAX REGISTRATION 19	
TX SETTING 20	
RX SETTING 21	
COMM. SETTING 23	
REPORTING 24	

USER SETTING 25

Specifying Settings in Configuration Menu 26

General Procedure for Specifying Settings in Configuration Menu 26

Memory Reception 27

Setting Up the Memory RX Mode 27

Turning Off the Memory RX Mode 28

3 Sending Faxes29

Basic Fax Operation 30

Sending a Fax Using the ADF 30

Sending a Fax Using the Original Glass 32

Improving Resolution 34

Specifying a Recipient 34

Directly Entering a Fax Number 35

Using a One-Touch Dial Key 35

Using the Speed Dial Function 36

Using the List Function of the Phone Book 36

Using the Search Function of the Phone Book 37

Using the Redial Function 38

Specifying Multiple Recipients 38

Sending a Fax to Multiple Recipients (Broadcast Transmission) 38

Sending a Fax at a Specified Time (Timer Transmission) 40

Sending a Fax Manually 41

Sending a Fax Manually After Using the Telephone 41

Sending a Fax Manually Using the On Hook Key 41

Canceling (Deleting) a Document Queued in Memory for Transmission 42

About the Fax Header 43

4 Receiving Faxes45

Receiving Faxes Automatically 46

Receiving Faxes Manually 46

Printing Received Faxes 47

What Is the Guaranteed Imageable (Printable) Area? 47

Adding the Sender's Information When Printing Faxes 48

5 Registering Recipients49

About the FAX REGISTRATION Function 50

One-Touch Dialing 50

Programming a One-Touch Dial Key 50

Changing/Deleting One-Touch Dial Information 52

Speed Dialing 53

Programming a Speed Dial Number 53

Changing/Deleting Speed Dial Information 54

Group Dialing 55

Programming Group Dialing 55

Changing/Deleting Group Dialing Information 56

6	Confirmation Mode	59
	About the Machine's Counters 60	
	Checking the Counter for Fax Printing 60	
	Checking the Counter for Total Scans 60	
	Checking the Transmission/Reception Result From the Message Window 61	
	About the Reports and Lists 61	
	Printing the Reports and Lists 61	
	TX RESULT REPORT 61	
	RX RESULT REPORT 62	
	ACTIVITY REPORT 62	
	MEMORY DATA LIST 63	
	MEMORY IMAGE PRINT 63	
	ONE TOUCH LIST 63	
	SPEED DIAL LIST 63	
	GROUP DIAL LIST 64	
7	Troubleshooting	65
	Problems When Sending Faxes 66	
	Problems When Receiving Faxes 67	
	Error Messages on the Message Window 69	
8	Appendix	71
	Technical Specifications 72	
	Entering Text 73	
	Key Operation 73	
	Entering Fax Numbers 73	
	Entering Names 74	
	Entering Email Addresses 74	
	Changing Input Mode 75	
	Inputting Example 75	
	Correcting Text And Input Precautions 76	

Introduction

1

Machine Parts

The parts of the machine referred to throughout this manual are illustrated below. Please take some time to become familiar with them.

Front View

1—Automatic document feeder (ADF)

1a—Document guide

1b—Document feed tray

1c—Document output tray

2—Control panel

3—Output tray

4—Tray 1 (Multipurpose tray)

5—Tray 2

6—Original glass



The ADF may appear as “document cover” in some status and error messages.

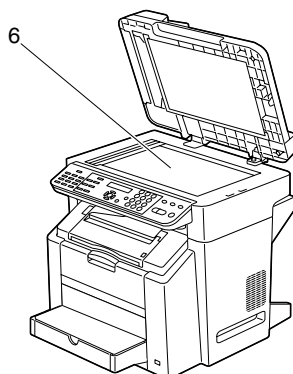
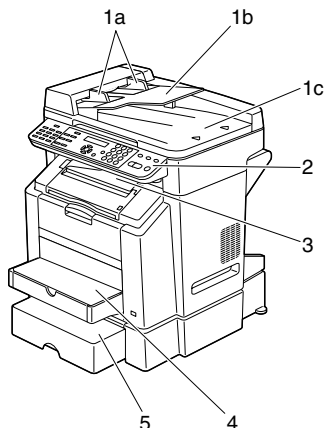

Rear View

- 1-TEL (telephone) jack
- 2-LINE (telephone line) jack
- 3-10Base-T/100Base-TX (IEEE 802.3) Ethernet interface port

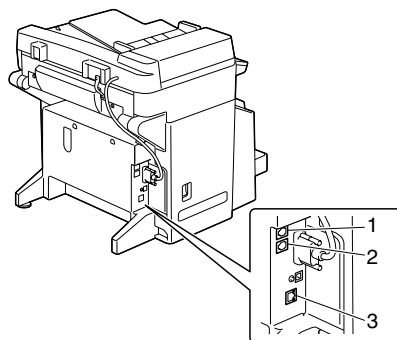

***Control Panel and
Configuration
Menu***

2

About the Control Panel

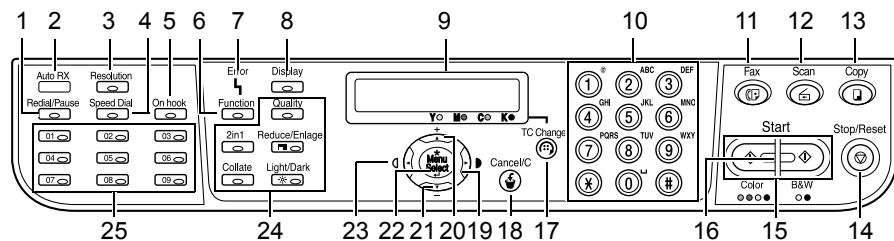

No.	Part Name	Description
1	Redial/Pause key	<p>Recalls the last number dialed.</p> <p>Inserts a pause when a number is dialed.</p> <p>For details, refer to “Using the Redial Function” on page 38.</p>
2	Auto RX indicator	<p>Lights up when the automatic reception function is selected.</p> <p>For details, refer to “Receiving Faxes Automatically” on page 46.</p>
3	Resolution key	<p>Adjusts the image quality of the fax documents.</p> <p>For details, refer to “Improving Resolution” on page 34.</p>
4	Speed Dial key	<p>Recalls a speed dial number.</p> <p>For details, refer to “Using the Speed Dial Function” on page 36.</p>
5	On hook key	<p>Sends and receives transmissions with the receiver on the hook.</p> <p>For details, refer to “Sending a Fax Manually Using the On Hook Key” on page 41 or “Receiving Faxes Manually” on page 46.</p>

6	Function key	<p>Enters Function mode and displays the first menu that is available.</p> <p>For details, refer to “Sending a Fax to Multiple Recipients (Broadcast Transmission)” on page 38, “Sending a Fax at a Specified Time (Timer Transmission)” on page 40, or “Canceling (Deleting) a Document Queued in Memory for Transmission” on page 42.</p>
7	Error indicator	<p>Flashes in orange when an error has occurred.</p> <p>For details, refer to “Error Messages on the Message Window” on page 69.</p>
8	Display key	<p>Used to view the transmission results, the counters or the amount of toner remaining, or to print reports and lists.</p> <p>For details, refer to “Confirmation Mode” on page 59.</p>
9	Message window	<p>Displays settings and messages.</p> <p>For details, refer to “Fax Mode Screen” on page 10.</p>
10	Keypad	<p>Used to enter numbers such as fax numbers and letters such as names.</p> <p>For details on dialing a destination, refer to “Specifying a Recipient” on page 34. For details on entering text, refer to “Entering Text” on page 73.</p>
11	Fax key	<p>Enters Fax mode.</p> <p>Lights up in green to indicate that the machine is in Fax mode.</p> <p>For details, refer to “Fax Mode Screen” on page 10.</p>
12	Scan key	<p>Enters Scan mode.</p> <p>Lights up in green to indicate that the machine is in Scan mode.</p> <p>For details, refer to the Printer/Copier/Scanner User’s Guide.</p>

13	Copy key	<p>Enters Copy mode.</p> <p>Lights up in green to indicate that the machine is in Copy mode.</p> <p>For details, refer to the Printer/Copier/Scanner User's Guide.</p>
14	Stop/Reset key	<p>Stops an operation at any time.</p> <p>Exits the menu.</p> <p>Cancels scanning, transmission, reception, and printing, and returns them to their default settings.</p> <p>For details, refer to "Basic Fax Operation" on page 30.</p>
15	Start key	<p>Starts a fax transmission or reception.</p> <p>For details, refer to "Basic Fax Operation" on page 30 or "Receiving Faxes Manually" on page 46.</p>
16	Start indicator	<p>Lights up in green to indicate that the machine is ready to start transmitting.</p> <p>Lights up in orange to indicate that the machine is not ready to start transmitting.</p>
17	TC Change key	<p>Press when replacing the toner. For details, refer to the Printer/Copier/Scanner User's Guide.</p>
18	Cancel/C key	<p>Cancels the setting or returns to the previous menu level.</p> <p>For details, refer to "Specifying Settings in Configuration Menu" on page 26 or "Entering Text" on page 73.</p>
19	▶	<p>Moves right through the available menu choices.</p> <p>Sets the current character and moves the cursor to the right when entering text.</p> <p>For details, refer to "Specifying Settings in Configuration Menu" on page 26.</p>
20	▲	<p>Moves up in the menu structure.</p> <p>Scrolls upward through the available menu choices.</p> <p>For details, refer to "Specifying Settings in Configuration Menu" on page 26.</p>

21	▼	<p>Moves down in the menu structure.</p> <p>Scrolls downward through the available menu choices.</p> <p>For details, refer to “Specifying Settings in Configuration Menu” on page 26.</p>
22	Menu Select key	<p>Enters the menu structure.</p> <p>Moves down in the menu structure.</p> <p>Selects the displayed menu choice.</p> <p>For details, refer to “Specifying Settings in Configuration Menu” on page 26.</p>
23	◀	<p>Moves left through the available menu choices.</p> <p>Sets the current character and moves the cursor to the left when entering text.</p> <p>For details, refer to “Specifying Settings in Configuration Menu” on page 26.</p>
24	Copy operations key	<p>Provides copy operations.</p> <p>For details, refer to the Printer/Copier/Scanner User’s Guide.</p> <p> <i>If a copy operations key is pressed in Fax mode, the machine enters Copy mode. For details, refer to the Printer/Copier/Scanner User’s Guide.</i></p>
25	One-touch dial keys	<p>Registers and recalls one-touch dial numbers.</p> <p>For details, refer to “Using a One-Touch Dial Key” on page 35 or “One-Touch Dialing” on page 50.</p>

Fax Mode Screen

About the Fax Mode Screen

Press the **Fax** key to display the Fax mode screen.

The following appear in the Fax mode screen.

Position	Part Name	Description
Upper	Mode or function name	<ul style="list-style-type: none">■ Indicates the currently selected mode or function settings.■ Displays the current menu, function or settings.■ Error messages are displayed when errors occur.■ The current time and remaining amount of memory is displayed during standby.
Lower	Messages	Displays messages such as operating instructions.

About the Function Mode Screen

Press the **Function** key to display the Function mode screen.

The following appear in the Function mode screen.









Position	Part Name	Description
Upper	Function name	<ul style="list-style-type: none">■ BROADCAST A fax can be sent to multiple recipients in a single transmission. For details, refer to "Sending a Fax to Multiple Recipients (Broadcast Transmission)" on page 38.■ TIMER TX A document can be scanned and stored in the memory to be sent at a specified time. For details, refer to "Sending a Fax at a Specified Time (Timer Transmission)" on page 40.■ CANCEL RESERV. Of the documents stored in the memory and waiting to be sent, a specific document can be selected and delete. For details, refer to "Canceling (Deleting) a Document Queued in Memory for Transmission" on page 42.
Lower	Messages	Displays messages such as operating instructions.

Entering Fax Mode

Before using a Fax function, make sure that the **Fax** key is lit in green. Otherwise, press it to enter Fax mode.

Pressing the **Speed Dial** key, **Redial/Pause** key or a one-touch dial key switches the machine to Fax mode when it is in any mode other than Fax mode.

Symbol list

Symbol		Description
	Dialing	A fax number is being dialed.
	Ringing	The machine is being called.
	Sending	The document is being sent.
	Receiving	A document is being received.
	Number of scanned document pages	The number of scanned document pages appears beside the icon.
	Tone	If pulse dialing is being used, push-button tones are sent.
	Pause	A pause is inserted.
	In standby for timer transmission	A document is queued for timer transmission.
	In standby for memory reception	A document is queued for memory reception.

Configuration Menu Overview

The magicolor 2490MF configuration menu accessible from the control panel is structured as shown below.



Press the **Menu Select** key to enter the configuration menu.

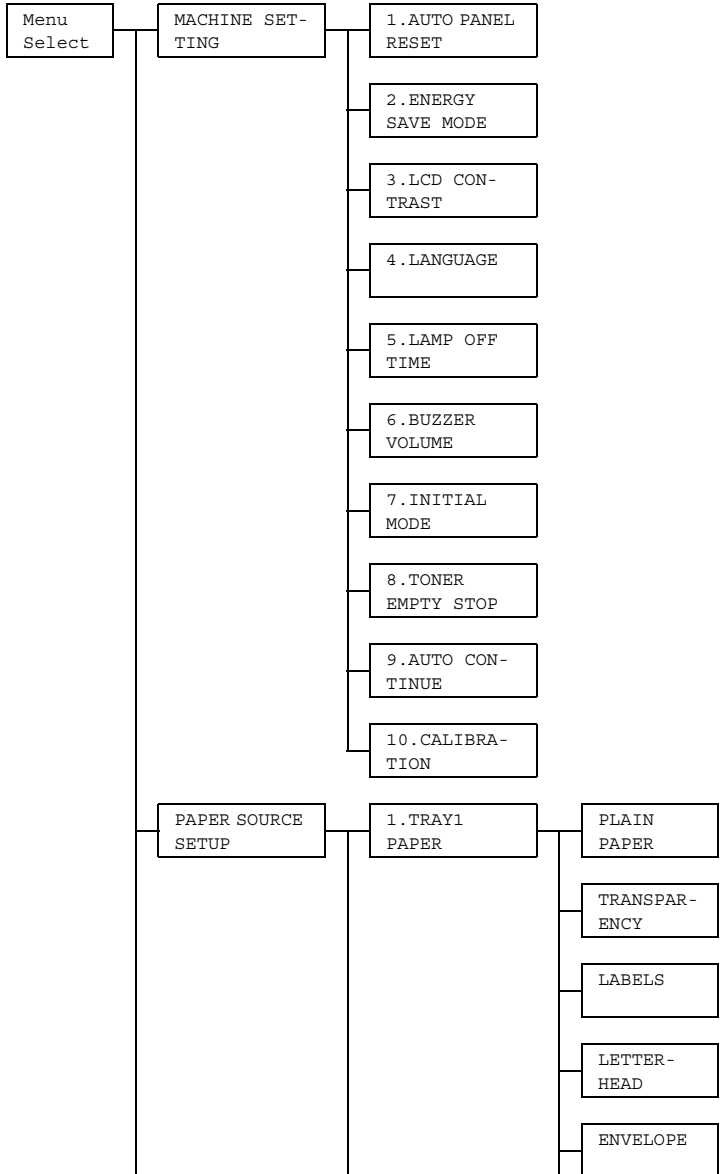

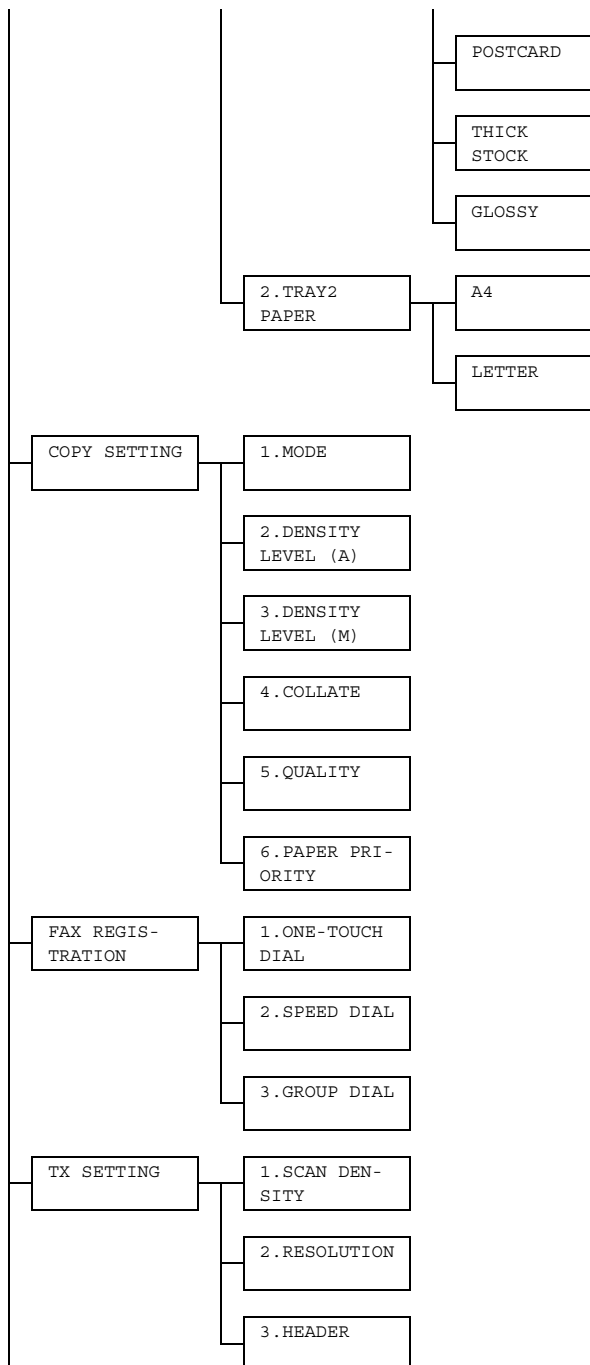

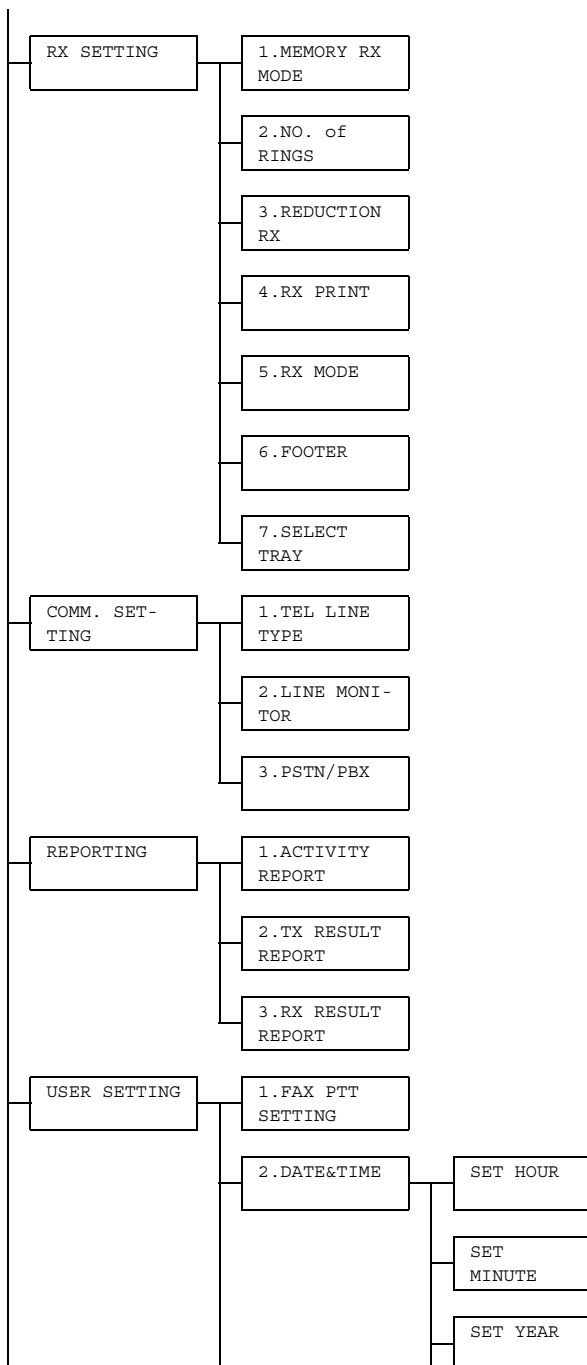

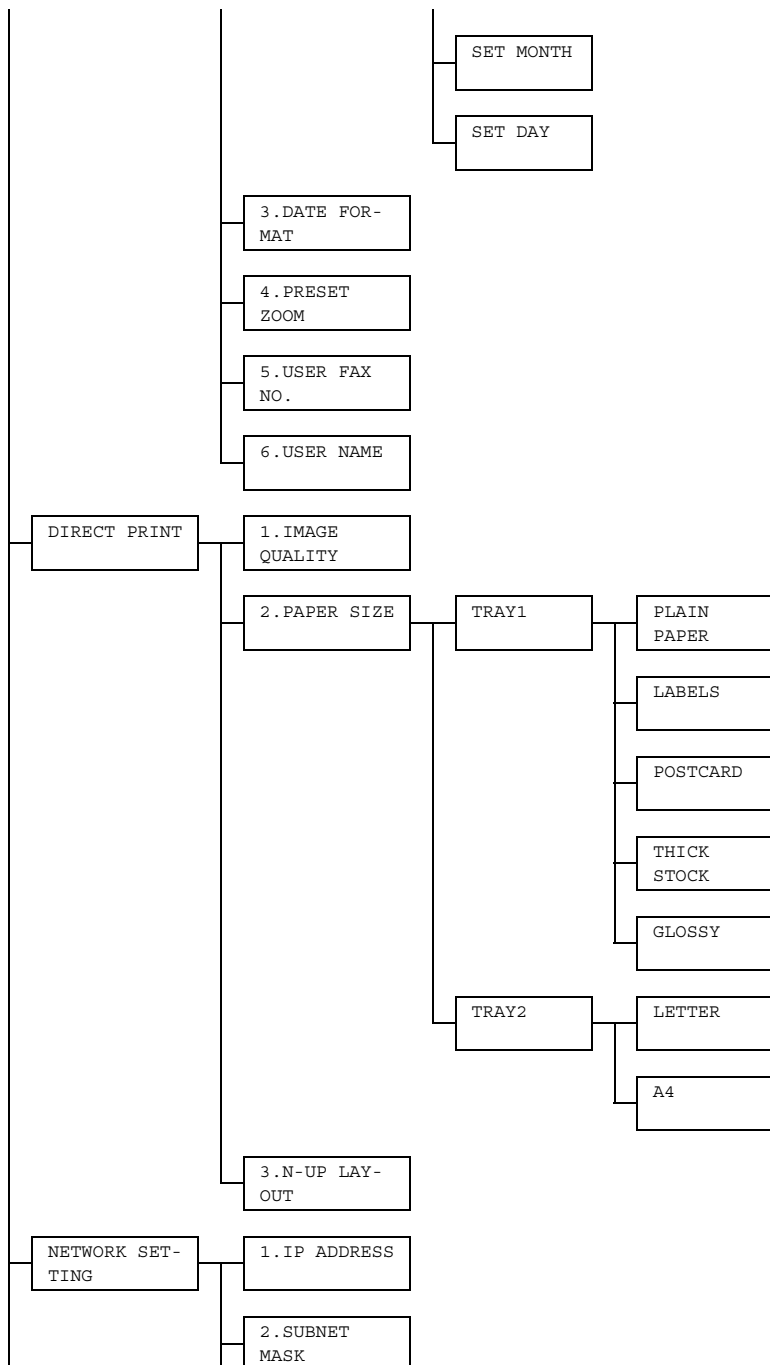

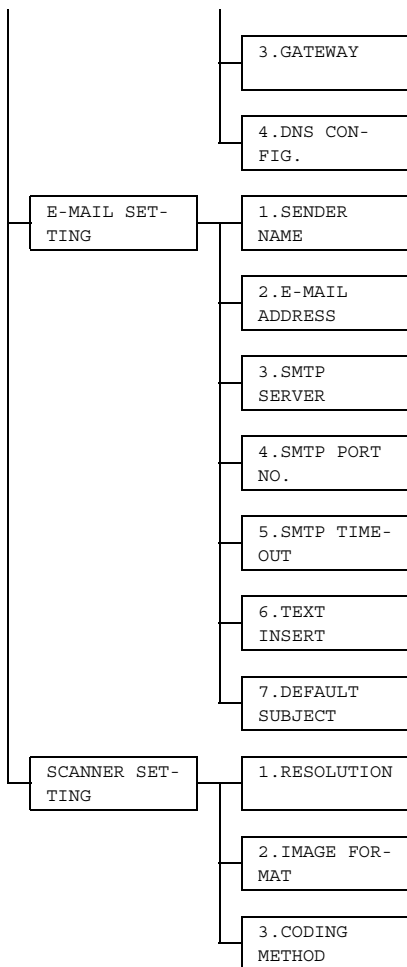

Configuration Menu

The machine settings can be changed according to the desired normal operations.



All factory default values are shown in bold.



For details on specifying settings on the configuration menu, refer to “Specifying Settings in Configuration Menu” on page 26.



For details on specifying settings for options in the Paper Source Setup, Copy Setting and Direct Print menus and for some options in the Machine Setting menu, refer to the Printer/Copier/Scanner User’s Guide.



MACHINE SETTING

1. AUTO PANEL RESET	For details on specifying settings, refer to the Printer/Copier/Scanner User's Guide.	
2. ENERGY SAVE MODE		
3. LCD CONTRAST		
4. LANGUAGE		
5. LAMP OFF TIME		
6. BUZZER VOLUME	Settings	HIGH / LOW / OFF
	Select the volume of alarms and the beep that sounds when a key is pressed.	
7. INITIAL MODE	Settings	COPY / FAX
	Select the mode that the machine starts up in or returns to after the automatic reset.	
8. TONER EMPTY STOP	Settings	ON / ON (FAX) / OFF
	<p>Select whether or not printing stops when the toner has run out.</p> <p>If a fax is received while printing is stopped, the received fax is saved in the memory and automatically printed after the error is corrected.</p> <ul style="list-style-type: none"> ■ ON: All printing stops when the machine has detected that the toner has run out. ■ ON (FAX): Only fax printing stops when the machine has detected that the toner has run out, and a message appears in the message window. ■ OFF: Printing does not stop when the machine has detected that the toner has run out, and a message appears in the message window. 	
9. AUTO CONTINUE	Settings	ON / OFF
	Select whether or not to perform image stabilization. If ON is selected, image stabilization is started.	
10. CALIBRATION	For details on specifying settings, refer to the Printer/Copier/Scanner User's Guide.	

FAX REGISTRATION

1 . ONE - TOUCH DIAL	<p>Program one-touch dial keys with fax numbers, allowing the recipient to be specified easily and accurately without the need to manually enter the number using the keypad.</p> <p>A maximum of nine one-touch dial keys can be programmed. This dialing method is convenient for programming numbers that faxes are frequently sent to. For details on specifying one-touch dial keys, refer to “One-Touch Dialing” on page 50.</p>
2 . SPEED DIAL	<p>Program speed dial numbers with fax numbers, allowing the recipient to be specified easily and accurately without the need to manually enter the number using the keypad.</p> <p>A maximum of 100 fax numbers can be programmed.</p> <p>For details on specifying speed dial numbers, refer to “Speed Dialing” on page 53.</p>
3 . GROUP DIAL	<p>Program a single one-touch dial key with a maximum of 50 different fax numbers as one group. Programming a one-touch dial key with a group of fax numbers is convenient when documents are frequently sent to a set group of multiple recipients.</p> <p>For details on specifying group dialing, refer to “Group Dialing” on page 55.</p>

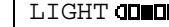
TX SETTING



1. SCAN DEN- SITY	Settings	LIGHT  DARK
	Specify the density for scanning a document.	
2. RESOLUTION	Settings	STD / FINE / S/F / H/T
	<p>Select the default scanning resolution (image quality).</p> <ul style="list-style-type: none"> ■ STD: For documents containing normal text (such as handwriting) (Standard) ■ FINE: For documents containing small text ■ S/F: For documents such as newspapers or those containing detailed illustrations (Super Fine) ■ H/T : For documents with shades, such as photos (Half Tone) If H/T was selected, a screen appears, allowing you to select a detailed setting (STD, FINE or S/F). <p>To change the resolution from the default setting before transmission, press the Resolution key.</p>	
3. HEADER	Settings	ON / OFF
	<p>Select whether or not the transmission information (date sent, sender's name, fax number, etc.) is printed on sent faxes.</p> <p> <i>On models for the USA, Canada and Korea, OFF cannot be selected.</i></p>	

RX SETTING

1. MEMORY RX MODE	Settings	ON / OFF
	<p>Select whether to allow (ON) memory reception or not (OFF). In cases when confidential faxes are being received, the received document can be stored in the memory and printed at a specified time or when memory reception is turned off (this function is set to OFF).</p> <p>A password can be set to specify the starting time or ending time of memory reception, or to cancel the function. The set starting time and ending time are valid every day until memory reception is turned off.</p> <p>For details on specifying settings, refer to "Setting Up the Memory RX Mode" on page 27.</p>	
2. NO. of RINGS	Settings	1-16 (Default : Depends on the sales region)
	Enter the number of rings between 1 and 16 until the call is answered.	
3. REDUCTION RX	Settings	ON / OFF / CUT
	<p>Select whether documents longer than the paper are printed reduced, split, or discarded.</p> <ul style="list-style-type: none"> ■ ON: The document is printed at a reduced size. ■ OFF: The document is printed at full size and split onto multiple pages. ■ CUT: The document is printed, but any part that does not fit within the page is erased. However, when sending a document more than 24 mm (1 inch) longer than the paper, the document is split. 	
4. RX PRINT	Settings	MEMORY RX / PRINT RX
	<p>Select whether the fax is printed only after all document pages have been received or printing begins as soon as the first page of the document is received.</p> <ul style="list-style-type: none"> ■ MEMORY RX: Printing begins after all pages have been received. ■ PRINT RX: Printing begins after the first page has been received. 	

5. RX MODE	Settings	AUTO RX / MANUAL RX
	<p>Select whether the reception mode is set to automatic reception or manual reception.</p> <ul style="list-style-type: none"> ■ AUTO RX: Automatically begins receiving the fax after the set number of rings. ■ MANUAL RX: Does not automatically receive the fax. Reception begins after making a connection by picking up the telephone receiver or pressing the On hook key, then pressing the Start key. <p>For details on manual reception, refer to “Receiving Faxes Manually” on page 46.</p>	
6. FOOTER	Settings	ON / OFF
	<p>Select whether or not the reception information (date received, number of pages, etc.) is printed at the bottom of each received document.</p>	
7. SELECT TRAY	Settings	TRAY1: DISABLE / ENABLE TRAY2: DISABLE / ENABLE
	<p>Select which paper tray can be used to supply paper when printing received documents or transmission reports. A paper tray that cannot be used for supplying paper can also be specified.</p> <p> <i>If the tray2 is not installed, TRAY2 does not appear.</i></p>	

COMM. SETTING

1. TEL LINE TYPE	Settings	TONE / PULSE
	<p>Select the dialing system. If this function is not correctly set to the type of dialing system used, faxes cannot be sent.</p> <p>Select the correct setting after checking which type of dialing system is used by your telephone line.</p> <p> <i>If the FAX PTT SETTING in the USER SETTING menu is set to USA, the settings cannot be changed.</i></p>	
2. LINE MONI- TOR	Settings	HIGH / LOW / OFF
	<p>Select the volume of the monitoring sound of the transmission signal.</p> <p> <i>Even when OFF is selected, the monitoring sound can be heard when the On hook key is pressed.</i></p>	
3. PSTN/PBX	Settings	PSTN / PBX
	<p>Select whether the connected telephone wiring is a public switched telephone network (PSTN) or a private branch exchange (PBX).</p> <p>For a PBX system, the prefix number (outside line access number (or extension number)) can be specified.</p>	

REPORTING

1. ACTIVITY REPORT	Settings	ON / OFF
2. TX RESULT REPORT	Settings	ON / ON (ERROR) / OFF
3. RX RESULT REPORT	Settings	ON / ON (ERROR) / OFF

After every 60 transmissions/receptions, a report can be printed to show the results of the transmissions/receptions. Select whether the report is printed automatically when the 60th transmission/reception is reached.

Select whether the report showing the result of a transmission is printed automatically after the transmission is finished.

- ON: Prints the report after each transmission.
- ON (ERROR) : Prints the report after a transmission only if an error occurred.
- OFF: Does not print the report after each transmission, even if an error has occurred.

Select whether the report showing the result of a reception is printed automatically after the reception is finished.

- ON: Prints the report after each reception.
- ON (ERROR) : Prints the report after a reception only if an error occurred.
- OFF: Does not print the report after each reception, even if an error has occurred.

USER SETTING

1 . FAX PTT SETTING	Settings	USA / UK / ARGENTINA / AUSTRALIA / AUSTRIA / BELGIUM / BRAZIL / CANADA / CHINA / CZECH / DENMARK / EUROPE / FINLAND / FRANCE / GERMANY / GREECE / HONG KONG / HUNGARY / IRELAND / ISRAEL / ITALY / JAPAN / KOREA / MALAYSIA / MEXICO / NETHERLANDS / NEW ZEALAND / NORWAY / PHILIPPINES / POLAND / PORTUGAL / RUSSIA / SAUDI ARABIA / SINGAPORE / SLOVAKIA / SOUTH AFRICA / SPAIN / SWEDEN / SWITZERLAND / TAIWAN / TURKEY
Select the country where this machine is installed.		
2 . DATE&TIME	Settings	SET HOUR: 00-23 SET MINUTE: 00-59 SET YEAR: 00-99 (2000-2099) SET MONTH: 01-12 SET DAY: 01-31
Enter the date and time for the machine using the keypad. If FAX PTT SETTING is set to USA or CANADA, the time changes automatically for daylight saving time. (Starts: First Sunday of April at 2 a.m.; Ends: Last Sunday in October at 2 a.m.)		
3 . DATE FORMAT	Settings	MM/DD/YY / DD/MM/YY / YY/MM/DD
Select the display format for reports and lists.		
4 . PRESET ZOOM	For details on specifying settings, refer to the Printer/Copier/Scanner User's Guide.	
5 . USER FAX NO .	Enter your fax number. A maximum of 50 characters (consisting of numbers, spaces, + and -) can be entered. The specified number is printed in the header of sent faxes.	
6 . USER NAME	Enter your name. A maximum of 20 characters can be entered. The specified name is printed in the header of sent faxes.	

Specifying Settings in Configuration Menu

General Procedure for Specifying Settings in Configuration Menu

- 1 With the Fax mode screen displayed, press the **Menu Select** key to enter the configuration menu.
- 2 Check the name of the menu in the upper line, and then press the **Menu Select** key to specify a setting for an option in the displayed menu.
OR
To select a different menu, press the ▲ or ▼ key to select the desired menu. Refer to the menu configuration on page 12 to display the desired menu. After the name of the desired menu is displayed, press the **Menu Select** key.



The desired menu can also be displayed by pressing the key in the keypad for the corresponding number.

Example: To display "Buzzer Volume", press the 6 key in the MACHINE SETTING screen.

For the number assigned to each menu option, refer to the menu configuration on page 12.

- 3 To select a setting, press the ◀ or ▶ key to move ✕ beside the desired setting.
If ▶ appears in the list of settings, more settings are available.
OR
If ▲ or ▼ appears in the screen displaying the settings, press the ▲ or ▼ key until the desired setting is displayed.
OR
To enter a setting, use the keypad to type in the number.
- 4 Press the **Menu Select** key.
The setting is applied, and the Fax mode screen appears again.



*To cancel the settings, press the **Cancel/C** key.*

Memory Reception

In cases when confidential faxes are being received, the received document can be stored in the memory and printed at a specified time or when memory reception is turned off.

Memory reception can be used with the following settings.

- Start/end time settings: Not set
“MEMORY RX MODE” is normally set to “ON”. To print a fax saved in the memory, set “MEMORY RX MODE” to “OFF”.
- Start/end time settings: Set
Memory reception mode begins and ends at the specified time.

Example 1: When “ON TIME” is set to 18:00 and “OFF TIME” is set to 8:00

The machine is in memory reception mode from 18:00 to 8:00 and in normal reception mode, where faxes are printed after being received, from 8:00 to 18:00.

Example 2: When “ON TIME” is set to 12:00 and “OFF TIME” is set to 12:00 (the start time and end time are the same)

“MEMORY RX MODE” is normally set to “ON”; however, faxes saved in the memory are printed at 12:00.

Setting Up the Memory RX Mode

- 1 With the Fax mode screen displayed, press the **Menu Select** key to enter Menu mode.
- 2 Press the ▲ or ▼ key to display the RX SETTING screen, and then press the **Menu Select** key.
- 3 Check that the MEMORY RX MODE screen appears, and then press the **Menu Select** key.
- 4 Using the ◀ and ▶ keys, select “ON”, and then press the **Menu Select** key.
The ON TIME screen appears.
- 5 Specify the time when memory reception mode begins, and then press the **Menu Select** key.

The OFF TIME screen appears.



*To specify no start time, press the **Menu Select** key without specifying a time.*

- 6 Specify the time when memory reception mode ends, and then press the **Menu Select** key.

The PASSWORD screen appears.



*If no start time was specified in step 5, press the **Menu Select** key without specifying an end time.*

- 7 Enter the password, and then press the **Menu/Select** key.

Memory reception mode is set.



The password is required for turning off memory reception mode or changing the start/end times. Enter a four-digit number.



*To specify no password, press the **Menu Select** key without specifying a password.*

Turning Off the Memory RX Mode

- 1 With the Fax mode screen displayed, press the **Menu Select** key to enter Menu mode.

- 2 Press the **▲** or **▼** key to display the RX SETTING screen, and then press the **Menu Select** key.

- 3 Check that the MEMORY RX MODE screen appears, and then press the **Menu Select** key.

- 4 Using the **◀** and **▶** keys, select "OFF", and then press the **Menu Select** key.

The PASSWORD screen appears.



If no password was specified, memory reception mode is canceled.

- 5 Enter the password, and then press the **Menu/Select** key.

Memory reception mode is canceled.



If faxes are saved in the memory, printing of the faxes begins.

Sending Faxes

3

Basic Fax Operation

This section contains basic information on sending faxes.



Only Statement(ST), Letter(LT), Legal(LG), A5, or A4 size documents can be sent as a fax.

Sending a Fax Using the ADF

If the ADF is used, original documents containing multiple pages can be automatically scanned.



Do not load original documents that are bound together, for example, with paper clips or staples.



Do not load more than 50 sheets; otherwise a original document misfeed or damage to the document or machine may occur.



If the original document is not loaded correctly, it may not be fed in straight, or an original document misfeed or damage to the document may occur.



Do not open the ADF cover while documents loaded into the ADF are being scanned.

- 1 Press the **Fax** key to enter Fax mode.
- 2 Make sure that there is no document on the original glass.
- 3 Put the document into the ADF document feed tray face up.

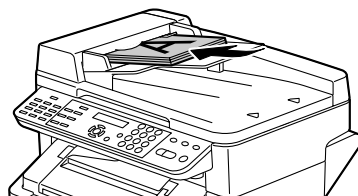

- 4 Adjust the document guides to the document size.
- 5 Press the **Resolution** key to specify the desired image quality.



*The document image quality can be adjusted by pressing the **Resolution** key. For details, refer to "Improving Resolution" on page 34.*

- 6 Specify the fax number of the recipient in one of the following ways:
 - Direct dialing
 - Using the one-touch dial key (including the group dial function)

- Using the Speed Dial function
- Using the Phone Book function
- Using the **Redial/Pause** key

 For details on specifying the recipient, refer to “Specifying a Recipient” on page 34. For details on using the **Redial/Pause** key, refer to “Using the Redial Function” on page 38.

 A transmission can also be sent to multiple recipients with the Broadcast function. For details on sending a broadcast transmission, refer to “Sending a Fax to Multiple Recipients (Broadcast Transmission)” on page 38.

7 Press the **Start** key.

The document is scanned, and then the fax is sent.

 To stop the transmission, press the **Stop/Reset** key. A message appears, requesting confirmation to cancel the setting. Select “Yes”, and then press the **Menu Select** key.

 If the fax could not be sent (for example, because the line was busy), the automatic redial function will try sending the transmission again. If the fax could not be sent with the automatic redial function, a TX Result Report can be printed. For details, refer to “TX RESULT REPORT” on page 61.

 If you want to cancel a scanned document queued for transmission or a fax waiting to be redialed, select “CANCEL RESERV.” from the Function menu. For details, refer to “Canceling (Deleting) a Document Queued in Memory for Transmission” on page 42.

 Since a document with multiple pages is saved in the memory while it is being sent, the document is scanned at high speed. A maximum of 512 pages can be stored in the memory. (If a high resolution is selected while scanning detailed documents, 512 pages may not be stored in the memory.) If the memory is nearly full, scanning of the document is stopped and a message appears, allowing you to select whether to start the transmission or cancel that transmission job. If the selection is made to cancel the job, the pages of the document that have been scanned for that job are deleted. If the selection is made to begin the transmission, scanning of the document is stopped and transmission begins. After the scanned pages have been sent, scanning of the document starts again.

Sending a Fax Using the Original Glass

1 Press the **Fax** key to enter Fax mode.

2 Remove all documents from the ADF.



If you are using the original glass to scan, do not load any documents into the ADF.

3 Lift open the ADF cover.

4 Place the original document face down on the original glass and align the document on the scales above and to the left of the original glass.

5 Gently close the ADF cover.



Closing it too quickly may cause the document to move on the original glass.

6 Press the **Resolution** key to specify the desired image quality.



*The document image quality can be adjusted by pressing the **Resolution** key. For details, refer to “Improving Resolution” on page 34.*

7 Specify the fax number of the recipient in one of the following ways:

- Direct dialing
- Using the one-touch dial keys (including group dialing)
- Using the speed dial numbers
- Using the phone book functions
- Using the **Redial/Pause** key



*For details on specifying the recipient, refer to “Specifying a Recipient” on page 34. For details on using the **Redial/Pause** key, refer to “Using the Redial Function” on page 38.*



A transmission can also be sent to multiple recipients with the Broadcast function. For details on sending a broadcast transmission, refer to “Sending a Fax to Multiple Recipients (Broadcast Transmission)” on page 38.

8 Press the **Start** key.

A screen appears, requesting confirmation of the scanning area.

9 To scan the displayed scanning area, press the **Menu Select** key. The document is scanned.

OR

To change the displayed scanning area, press the ▼ key, select the desired scanning area in the next screen that appears, and then press the **Menu Select** key. The document is scanned.

- 10 To scan multiple pages from the original glass, check that the message "NEXT PAGE?" appears, replace the document, and then press the **Menu Select** key.
OR
When scanning of the document is finished, press the **Start** key.
The document is scanned, and then the fax is sent.



To stop the transmission, press the **Stop/Reset** key. A message appears, requesting confirmation to cancel the setting. Select "Yes", and then press the **Menu Select** key.



If the fax could not be sent (for example, because the line was busy), the automatic redial function will try sending the transmission again. If the fax could not be sent with the automatic redial function, a TX Result Report can be printed. For details, refer to "TX RESULT REPORT" on page 61.



If you want to cancel a scanned document queued for transmission or a fax waiting to be redialed, select "CANCEL RESERV." from the Function menu. For details, refer to "Canceling (Deleting) a Document Queued in Memory for Transmission" on page 42.



Since a document with multiple pages is saved in the memory while it is being sent, the document is scanned at high speed. A maximum of 512 pages can be stored in the memory. (If a high resolution is selected while scanning detailed documents, 512 pages may not be stored in the memory.) If the memory is nearly full, scanning of the document is stopped and a message appears, allowing you to select whether to start the transmission or cancel that transmission job. If the selection is made to cancel the job, the pages of the document that have been scanned for that job are deleted. If the selection is made to begin the transmission, scanning of the document is stopped and transmission begins. After the scanned pages have been sent, scanning of the document starts again.

Improving Resolution

The image quality of a document can be adjusted before it is sent as a fax.

- 1 Press the **Resolution** key.
- 2 Using the ◀ and ▶ keys, select the fax resolution, and then press the **Menu Select** key.



Select the resolution appropriate for the document.

- **STD**: For documents containing normal text (such as handwriting) (Standard)

- **FINE**: For documents containing small text

- **S/F**: For documents such as newspapers or those containing detailed illustrations (Super Fine)

- **H/T**: For documents with shades, such as photos (Half Tone)

If "H/T" was selected, a screen appears, allowing you to select a detailed setting ("STD", "FINE" or "S/F").



The resolution returns to the default setting after the document is scanned with a normal transmission or after transmission after manual transmission. The default setting can be changed. This is useful for specifying a frequently used resolution setting as the default. For details, refer to "TX SETTING" on page 20.

Specifying a Recipient

The recipients can be specified in any of the following ways.

- Direct dialing: Directly type in the fax number.
- Using the one-touch dial key: Specify a recipient registered with a one-touch dial key.
- Using the Speed Dial function: Specify a recipient registered with a speed dial.
- Using the phone book functions: List or search for recipients registered as one-touch dial keys or speed dial numbers, and then select a recipient.
- Using the **Redial/Pause** key: Specify the number of the recipient dialed last.

Directly Entering a Fax Number

- 1 Use the numeric keypad to type in the fax number for the recipient.



The keys that can be used to enter the fax number are: the number keys (0 through 9), *, and #. If the **Redial/Pause** key is pressed while entering the fax number, a 2.5-second pause is added. A pause appears as "P" in the message window.



If the machine is connected to a PBX line and the prefix number (outside line access number) has been specified in the "COMM. SETTING" on page 23, enter "#" to dial the outside line access number automatically.



To erase the entered number, hold down the **Cancel/C** key for about one second, or press the **Stop/Reset** key.

Using a One-Touch Dial Key

If a recipient has been registered with a one-touch dial key, the recipient's fax number can be dialed simply by pressing the programmed one-touch dial key.



The recipient must have been registered with a one-touch dial key in advance. For details, refer to "Programming a One-Touch Dial Key" on page 50.

- 1 Press the desired one-touch dial key.



Press the one-touch dial key programmed with the group dial recipients to send a fax to multiple recipients.



If an incorrect recipient is selected, press the **Cancel/C** key.



If the one-touch dial key that is pressed is not registered with a fax number, the message "NOT FAX NO." appears. In addition, if the one-touch dial key that is pressed is not registered with a recipient, the message "NOT REGISTERED!" appears. Press a one-touch dial key registered with a fax number.

Using the Speed Dial Function

If a recipient has been registered with a speed dial number, the recipient's fax number can be dialed simply by pressing a speed dial number key.



The recipient must have been registered with a speed dial in advance. For details, refer to "Programming a Speed Dial Number" on page 53.

- 1 Press the **Speed Dial** key.
- 2 Use the keypad to enter the 3-digit speed dial number programmed with the desired recipient.

The recipient's name appears in the message window.



*If an incorrect recipient is selected, press the **Cancel/C** key.*



If the entered speed dial number is not registered with a fax number, the message "NOT FAX NO." appears. In addition, if the entered speed dial number is not registered with a recipient, the message "NOT REGISTERED!" appears. Enter a speed dial number registered with a fax number.

Using the List Function of the Phone Book

If a recipient is registered with a one-touch dial key or a speed dial number, the recipient can be found by using the List or Search function of the phone book.

Follow the procedure described below to search using the List function of the phone book.

- 1 Press the **Speed Dial** key twice.
- 2 Using the ◀ and ▶ keys, select "LIST", and then press the **Menu Select** key.
The list of programmed one-touch dial keys and speed dial numbers is displayed.
- 3 Using the ▲ and ▼ keys, select the desired recipient.
- 4 Press the **Start** key.
The document is scanned, and then the fax is sent.



*To stop the transmission, press the **Stop/Reset** key. A message appears, requesting confirmation to cancel the setting. Select "Yes", and then press the **Menu Select** key.*

Using the Search Function of the Phone Book

If a recipient is registered with a one-touch dial key and a speed dial number, the recipient can be found by using the List or Search function of the phone book.

Follow the procedure described below to search using the Search function of the phone book.

- 1 Press the **Speed Dial** key twice.
- 2 Using the ◀ and ▶ keys, select "SEARCH", and then press the **Menu Select** key.
A screen appears, allowing you to enter the text to be searched for.
- 3 Using the keypad, enter the first few characters of the name programmed for the desired recipient.



Enter the name programmed in the one-touch dial key or the speed dial number. For details on entering text, refer to "Entering Text" on page 73.



Text up to 10 characters long can be entered.

- 4 Press the **Menu Select** key.
The number of names beginning with the text entered in step 3 is displayed.



If there are no names programmed with one-touch dial keys or speed dial numbers beginning with the entered text, "(0)" is displayed, and then the screen allowing you to enter the search text appears.

- 5 To select a recipient from the displayed search results, skip to step 7.
OR
To narrow down the search results even further, press the **Menu Select** key, and then enter more search text.

- 6 Press the **Menu Select** key.

- 7 Using the ▲ and ▼ keys, select the desired recipient.



*If the desired recipient name does not appear in the search results, press the **Clear/C** key twice to return to the screen allowing you to enter the search text, and then try searching for different text.*

- 8 Press the **Start** key.
The document is scanned, and then the fax is sent.



*To stop the transmission, press the **Stop/Reset** key. A message appears, requesting confirmation to cancel the setting. Select "Yes", and then press the **Menu Select** key.*

Using the Redial Function

To send a fax to the last number dialed, press the **Redial/Pause** key to recall the fax number.

- 1 Press the **Redial/Pause** key. Check that the desired fax number appears in message window.

Specifying Multiple Recipients

A fax can be sent to multiple recipients in a single transmission. There are two methods for sending a fax to multiple recipients in a single transmission.

- Using group dial function
- Using Broadcast function

For details on specifying a recipient using group dialing, refer to “Using a One-Touch Dial Key” on page 35.

For details on sending a broadcast fax transmission, refer to the following section.

Sending a Fax to Multiple Recipients (Broadcast Transmission)

The recipients can be specified by using the one-touch dial keys, the speed dial numbers or group dialing, by selecting from the phone book, or by entering the fax number using the keypad.



A maximum of 125 recipients can be selected at one time. If recipients are selected by using one-touch dial keys, a maximum of 9 recipients can be specified. If recipients are selected by using speed dial numbers, a maximum of 100 recipients can be specified. A maximum of 16 recipients can be specified by entering the fax number using the keypad.



With the transmission result report, you can check whether the fax was sent to all recipients. For details on the transmission result report, refer to “Checking the Transmission/Reception Result From the Message Window” and “About the Reports and Lists” on page 61.

- 1 Position the document to be faxed.
- 2 If necessary, change the “Resolution” setting.



The document image quality can be adjusted by pressing the [Resolution] key. For details, refer to “Improving Resolution” on page 34.

- 3 Press the **Function** key.

- 4 Check that the BROADCAST screen appears, and then press the **Menu Select** key.
- 5 Specify the fax number of the recipient. Repeat the appropriate operations described below until all recipients have been specified.
 - Direct dialing: Enter the fax number of the recipient directly using the keypad. Press the **Menu Select** key, and then specify the next recipient.
 - Using the one-touch dial keys (including group dialing): Press the one-touch dial key programmed with the desired fax number. Press the **Menu Select** key, and then specify the next recipient.
 - Using the speed dial numbers: Press the **Speed Dial** key, and then use the keypad to enter the 3-digit speed dial number programmed with the desired fax number. Press the **Menu Select** key, and then specify the next recipient.
 - Using the phone book functions: Press the **Speed Dial** key twice, and then select either “LIST” or “SEARCH” to select the desired fax number. (Refer to “Using the List Function of the Phone Book” on page 36.) Press the **Menu Select** key, and then specify the next recipient.
- 6 Press the **Start** key.

A message appears, allowing you to select whether or not to check the recipients.
- 7 To check the recipients, press the **Menu Select** key.

The recipients specified in step 5 are displayed in the order that they were selected.



If you do not want to check the recipients, skip to step 10.

- 8 Check the recipient, and then press the **Menu Select** key. The next recipient is displayed.

OR

Check the recipients, and then if you want to delete the displayed recipient, press the **Cancel/C** key.
- 9 After all recipients have been checked, “Fin.=START” appears in the message window.
- 10 Press the **Start** key to begin scanning and sending the fax.



*To stop the transmission, press the **Stop/Reset** key. A message appears, requesting confirmation to cancel the setting. Select “Yes”, and then press the **Menu Select** key. If this is done, all selected recipients are cleared.*



During transmission, the message “SET DOCUMENT.” appears; however, the document is sent to all specified recipients after being scanned only once.

Sending a Fax at a Specified Time (Timer Transmission)

A document can be scanned and stored in the memory to be sent at a specified time. This feature is convenient for sending faxes at discounted calling times.



If the machine is not programmed with the current time, the fax cannot be sent at the specified time. For details on specifying the time, refer to “USER SETTING” on page 25.



Timer transmission can be combined with broadcast transmission.

- 1 Position the document to be faxed.
- 2 If necessary, change the “Resolution” setting.



The document image quality can be adjusted by pressing the [Resolution] key. For details, refer to “Improving Resolution” on page 34.

- 3 Press the **Function** key, then the ▼ key.
- 4 Check that the TIMER TX screen appears, and then press the **Menu Select** key.
- 5 Using the keypad, enter the desired transmission time, and then press the **Menu Select** key.



The time is set in the 24-hour format.



*If you want to correct the time, press the **Cancel/C** key, and then enter the correct time.*

- 6 Specify the fax number of the recipient.



Refer to “Specifying a Recipient” on page 34.



*To send a fax to multiple recipients using broadcast transmission, press the **Function** key, and then display the BROADCAST screen. After all recipients have been entered, press the **Start** key to begin scanning, and then the machine enters transmission standby mode. For details on broadcast transmissions, refer to “Sending a Fax to Multiple Recipients (Broadcast Transmission)” on page 38.*

- 7 Press the **Start** key to begin scanning, and then the machine enters transmission standby mode.



If you want to cancel a timer transmission, select “CANCEL RESERV.” from the FUNCTION menu. For details, refer to “Canceling (Deleting) a Document Queued in Memory for Transmission” on page 42.

Sending a Fax Manually

Sending a Fax Manually After Using the Telephone

If the machine is connected to a telephone and the same line is used for both phoning and faxing, the document can simply be sent after talking with the recipient over the phone.

This is useful, for example, if you want to tell the recipient that you are sending a fax.

- 1 Load the document into the ADF.
- 2 If necessary, change the "Resolution" setting.



The document image quality can be adjusted by pressing the [Resolution] key. For details, refer to "Improving Resolution" on page 34.

- 3 Pick up the telephone receiver and check that the dial tone can be heard.
- 4 Specify the fax number of the recipient by using the telephone to dial the fax number.
OR
The fax number of the recipient can also be specified using the keypad in the control panel of this machine.



*If Pulse is selected as the telephone line type, press the * key to temporarily change the line type to Tone.*

- 5 After finishing talking on the phone, the recipient should press the necessary key to start receiving the fax.
Once the recipient's fax machine is ready, a beep is sounded.
- 6 Press the **Start** key to begin scanning and sending the fax.
- 7 Replace the telephone receiver.



*To stop the transmission, press the **Stop/Reset** key. A message appears, requesting confirmation to cancel the setting. Select "Yes", and then press the **Menu Select** key.*

Sending a Fax Manually Using the On Hook Key

- 1 Load the document into the ADF.
- 2 If necessary, change the "Resolution" setting.



The document image quality can be adjusted by pressing the [Resolution] key. For details, refer to "Improving Resolution" on page 34.

- 3 Press the **On hook** key.

4 Specify the fax number of the recipient.



*If Pulse is selected as the telephone line type, press the * key to temporarily change the line type to Tone.*

5 Press the **Start** key to begin scanning and sending the fax.



*To stop the transmission, press the **Stop/Reset** key. A message appears, requesting confirmation to cancel the setting. Select "Yes", and then press the **Menu Select** key.*

Canceling (Deleting) a Document Queued in Memory for Transmission

Of the documents stored in the memory and waiting to be sent, a specific document can be selected and deleted.

1 Press the **Function** key, then the ▼ key twice.

2 Check that the CANCEL RESERV. screen appears, and then press the **Menu Select** key.

The details (specified transmission time and type of transmission) of the jobs queued in the memory are displayed.



If no jobs have been queued in the memory, the message "NONE" appears.

3 Using the ▲ and ▼ keys, select the job to be deleted.



The following types of job are displayed.

- MEMORY: Normal transmission queued in the memory (fax)
- B-CAST: Broadcast transmission (fax)
- TIMER: Timer transmission (fax)
- SCAN: Scan to email transmission



*To check the recipient of the currently displayed transmission job, press the ► key. After checking, press the **Menu Select** key to return to the previous screen.*

4 Press the **Menu Select** key to delete the displayed job.

5 To delete another queued job, repeat steps 2 and 4.

About the Fax Header

If transmission source information is set in Header setting to be printed, information such as the sender's name, fax number, transmission date/time, session number and page number can be printed by the recipient.

The following items in the header.

Element	Description
Transmission date/time	Shows the date/time that the fax was sent. The time is indicated in the 24-hour format.
Sender's name	Shows the sender's name.
Fax number	Shows the sender's fax number.
Session number	Shows the session number used to manage the sent fax.
Page number	Shows the page number. Shown as page number/total number of pages.  <i>For a transmission using the telephone or the On hook key, the total number of pages is not shown.</i>



To print the fax header on the sent fax, specify the transmission source information on the User Setting menu of the configuration menu, and then use Header to select whether or not the transmission source information is printed. For details, refer to "RX SETTING" on page 21.

Receiving Faxes

4

Receiving Faxes Automatically



When the machine is turned off, faxes cannot be received. Therefore, be sure to leave the machine turned on.



To print a received fax, change the paper type to PLAIN PAPER and the paper size to A4, LEGAL, LETTER or OFICIO(Mexico only).

If the RX Mode parameter on the RX Setting menu is set to “Auto RX”, no special operation is needed in order to receive the fax. Reception begins after the specified number of rings.



If the RX Mode parameter on the RX Setting menu is set “Manual RX”, the fax is not received automatically. For details, refer to “RX SETTING” on page 21.



If “Memory RX Mode” is set to “ON”, printing does not begin automatically after the fax is received. A received document is saved in the memory and is printed at the time specified for “Memory RX Mode”. In addition, if “Memory RX Mode” is set to “OFF”, the fax is printed. For details on “Memory RX Mode” in the configuration menu, refer to “RX SETTING” on page 21. For details on specifying the settings for “Memory RX Mode”, refer to “Setting Up the Memory RX Mode” on page 27.



This machine does not support polling reception.

Receiving Faxes Manually



When the machine is turned off, faxes cannot be received. Therefore, be sure to leave the machine turned on.



To print a received fax, change the paper type to PLAIN PAPER and the paper size to A4, LEGAL, LETTER or OFICIO(Mexico only).

If a telephone is connected to this machine and the same line is used for phoning and faxing, the fax can be received after picking up the telephone receiver.

1

After the telephone rings, pick up the receiver.



If the telephone receiver is not picked up, reception begins automatically, if the call is being received from a fax machine, after the number of rings specified by “NO. of RINGS” on the RX SETTING menu. If the call is being received from a telephone, the ringing will continue.

 If "RX MODE" on the RX SETTING menu is set to "Manual RX", the machine will continue ringing whether the call is being received from a fax machine or a telephone.

 If no telephone is connected to this machine, press the **On hook** key.

2 Press the **Start** key.

The machine starts receiving the fax.

 After completing the telephone conversation, press the **Start** key to begin receiving the fax.

 If the telephone receiver is picked up and the call is being received from a fax machine, press the **Start** key to begin receiving the fax.

3 Replace the telephone receiver.

Printing Received Faxes

What Is the Guaranteed Imageable (Printable) Area?

The printable area on all media sizes is up to 4 mm (0.157") from the edges of the media.

 The printable area of received faxes differs depending on the sender's scanning area.

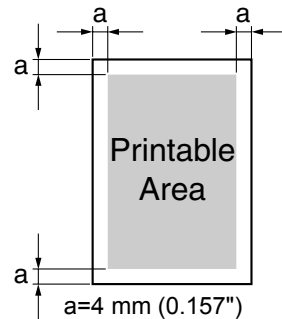

Adding the Sender's Information When Printing Faxes

If "Footer" in the configuration menu is set to "ON", information such as the sender's fax number, reception date/time, session number and page number can be printed 4 mm (0.157") from the bottom edge of the fax that is received and printed.

The following items in the footer.

Item	Description
This machine's fax number	Shows the fax number specified for this machine from the User Setting menu in the configuration menu.
Reception date/time	Shows the date/time that the fax was received. The time is indicated in the 24-hour format.
Sender's fax number	Shows the sender's fax number.
Session number	Shows the session number used to manage the received fax.
Page number	Shows the page number.



In order to print the footer, the Footer parameter on the RX Setting menu of the configuration menu must be set "ON". For details, refer to "RX SETTING" on page 21.

***Registering
Recipients***

5

About the FAX REGISTRATION Function

Frequently used fax numbers can be registered with the FAX REGISTRATION function so that the fax number can be easily accessed. In addition, this reduces input errors.

The following registration methods are available:

- **One-touch dial:** Register fax numbers with one-touch dial keys. Press a one-touch dial key to recall them. For details on specifying settings, refer to “One-Touch Dialing” on page 50.
- **Speed dial:** Register fax numbers with speed dial numbers, and then press a keypad to recall them. For details on specifying settings, refer to “Speed Dialing” on page 53.
- **Group dial:** Multiple recipients can be grouped and registered with a one-touch dial key. Press the one-touch dial key to recall the group. For details on specifying settings, refer to “Group Dialing” on page 55.



If a recipient is registered with a one-touch dial key or a speed dial number, the recipient can be searched for by using the phone book functions. For details on using the phone book functions, refer to “Using the List Function of the Phone Book” on page 36 and “Using the Search Function of the Phone Book” on page 37.

One-Touch Dialing

Programming a One-Touch Dial Key

Register frequently used fax numbers with one-touch dial keys (maximum 9). When sending a fax, press a one-touch dial key to recall them.



To register multiple recipients with a one-touch dial key, program it as a group dial. For details on programming group dialing, refer to “Group Dialing” on page 55.

- 1 Press the **Menu Select** key, then the ▼ key three times.
- 2 Check that the FAX REGISTRATION screen appears, and then press the **Menu Select** key.
- 3 Check that the ONE-TOUCH DIAL screen appears, and then press the **Menu Select** key.

4 Press the one-touch dial key that you want to program.



*If the one-touch dial key that is pressed is already registered with a recipient, the message "REGISTERED!" appears. Press the **Menu Select** key, and then press a one-touch dial key with no recipient registered.*

5 Enter the name of the one-touch dial to be programmed, and then press the **Menu Select** key.



Text up to 20 characters long can be entered for the name.



For details on entering/editing text and the characters that can be entered, refer to "Entering Text" on page 73.



*To cancel programming, press the **Cancel/C** key. (To cancel programming while the name is being entered, press the **Menu Select** key, and then press the **Cancel/C** key.)*

6 Using the keypad, enter the fax number of the recipient, and then press the **Menu Select** key.



The fax number can contain a maximum of 50 characters.



For details on entering/editing numbers, refer to "Entering Text" on page 73.



*To cancel programming, press the **Cancel/C** key. (To cancel programming while the number is being entered, press the **Menu Select** key, and then press the **Cancel/C** key.)*

7 Select the modem speed, and then press the **Menu/Select** key.

The entered information is programmed with the one-touch dial key, and the message "SELECT REGIST.KEY" appears.



If a transmission error occurs, select 14.4 or 9.6 for the modem speed.

8 To program another one-touch dial key, press the one-touch dial key, and then repeat the procedure starting from step 5.

OR

To finish the procedure and return to the Fax mode screen, continue pressing the **Cancel/C** key until the Fax mode screen is displayed.

Changing/Deleting One-Touch Dial Information

The registered one-touch dial information can be corrected.

- 1 Press the **Menu Select** key, then the ▼ key three times.
- 2 Check that the FAX REGISTRATION screen appears, and then press the **Menu Select** key.
- 3 Check that the ONE-TOUCH DIAL screen appears, and then press the **Menu Select** key.
- 4 Press the one-touch dial key that you want to change or delete.
- 5 Press the **Cancel/C** key.



*If a one-touch dial key programmed with a group of fax numbers is pressed, the message “GROUP” appears in the upper-right corner of the screen. To delete the group, press the **Cancel/C** Key.*



To change group dialing, refer to “Changing/Deleting Group Dialing Information” on page 56.

- 6 Using the ◀ and ▶ keys, select either “EDIT” or “DELETE”, and then press the **Menu Select** key.



If “EDIT” was selected, the name is displayed. (Continue with step 7.)



If “DELETE” was selected, the settings programmed for the one-touch dial key are deleted and the message “SELECT REGIST.KEY” appears again.



If a one-touch dial number used in group dialing is deleted, it is also deleted from the corresponding group dialing.

- 7 Change the name, fax number, modem speed as desired.



For details on changing the name, refer to “Entering Text” on page 73.



If you try to change the settings for a one-touch dial number used in group dialing, a confirmation message appears, asking whether or not to keep the changed one-touch dial number in the group dialing.

*If the **Menu Select** key is pressed, the corresponding one-touch dial number programmed in group dialing is kept.*

*If the **Cancel/C** key is pressed, the corresponding one-touch dial number programmed in group dialing is deleted.*

- 8 When you are finished making changes, press the **Menu Select** key. The message “SELECT REGIST. KEY” appears.

- 9 To change other one-touch dial information, press the one-touch dial key, and then repeat the procedure starting from step 5.
- OR
- To finish the procedure and return to the Fax mode screen, continue pressing the **Cancel/C** key until the Fax mode screen is displayed.

Speed Dialing

Programming a Speed Dial Number

Register frequently used fax numbers with speed dial numbers (maximum 100). Enter the speed dial number when sending a fax to recall the fax number.

- 1 Press the **Menu Select** key, then the ▼ key three times.
- 2 Check that the FAX REGISTRATION screen appears, then press the **Menu Select** key, and then press ▼ key.
- 3 Check that the SPEED DIAL screen appears, and then press the **Menu Select** key.
- 4 Using the keypad, enter the 3-digit speed dial number (ex. 011) that you want to program.



*If the speed dial number that is entered is already registered with a recipient, the message "REGISTERED!" appears. Press the **Menu Select** key, and then press a speed dial number with no recipient registered.*

- 5 Enter the name of the speed dial to be programmed, and then press the **Menu Select** key.



Text up to 20 characters long can be entered for the name.



For details on entering/editing text and the characters that can be entered, refer to "Entering Text" on page 73.



*To cancel programming, press the **Cancel/C** key. (To cancel programming while the name is being entered, press the **Menu Select** key, and then press the **Cancel/C** key.)*

- 6** Using the keypad, enter the fax number of the recipient and then press the **Menu Select** key.



The fax number can contain a maximum of 50 characters.



For details on entering/editing numbers, refer to “Entering Text” on page 73.



*To cancel programming, press the **Cancel/C** key. (To cancel programming while the number is being entered, press the **Menu Select** key, and then press the **Cancel/C** key.)*

- 7** Select the modem speed, and then press the **Menu/Select** key.

The entered information is registered with the speed dial number, and then the speed dial input screen appears.



If a transmission error occurs, select 14.4 or 9.6 for the modem speed.

- 8** To program another speed dial number, enter the speed dial number, and then repeat the procedure starting from step 5.

OR

To finish the procedure and return to the Fax mode screen, continue pressing the **Cancel/C** key until the Fax mode screen is displayed.

Changing/Deleting Speed Dial Information

The registered speed dial information can be corrected.

- 1** Press the **Menu Select** key, then the ▼ key three times.
- 2** Check that the FAX REGISTRATION screen appears, then press the **Menu Select** key, and then press the ▼ key.
- 3** Check that the SPEED DIAL screen appears, and then press the **Menu Select** key.
- 4** Using the keypad, enter the speed dial number that you want to change or delete.
- 5** Press the **Cancel /C** key.
- 6** Using the ◀ and ▶ keys, select either “EDIT” or “DELETE”, and then press the **Menu Select** key.



If “EDIT” was selected, the name is displayed. (Continue with step 7.)



If “DELETE” was selected, the settings programmed for the speed dial number are deleted and the speed dial input screen appears again.



If a speed dial number used in group dialing is deleted, it is also deleted from the corresponding group dialing.

7 Change the name, fax number, modem speed as desired.



If you try to change the settings for a speed dial number used in group dialing, a confirmation message appears, asking whether or not to keep the changed speed dial number in the group dialing.

*If the **Menu Select** key is pressed, the corresponding speed dial number programmed in group dialing is kept.*

*If the **Cancel/C** key is pressed, the corresponding speed dial number programmed in group dialing is deleted.*



For details on editing text, refer to "Entering Text" on page 73.

8 When you are finished making changes, press the **Menu Select** key. The speed dial input screen appears.

9 To change another speed dial number, enter the speed dial number, and then repeat the procedure starting from step 5.

OR

To finish the procedure and return to the Fax mode screen, continue pressing the **Cancel/C** key until the Fax mode screen is displayed.

Group Dialing

Programming Group Dialing

Register multiple frequently used fax numbers (maximum 50) together with one-touch dial keys and speed dial numbers. Press a one-touch dial key when sending a fax to recall them.

1 Press the **Menu Select** key, then the ▼ key three times.









2 Check that the FAX REGISTRATION screen appears, then press the **Menu Select** key, and then press the ▼ key twice.

3 Check that the GROUP DIAL screen appears, and then press the **Menu Select** key.

4 Press the one-touch dial key that you want to program.





*If the one-touch dial key that is pressed is already registered with a recipient, the message "REGISTERED!" appears. Press the **Menu Select** key, and then press a one-touch dial key with no recipient registered.*

- 5** Enter the name of the group, and then press the **Menu Select** key.
-  *Text up to 20 characters long can be entered for the name.*
 -  *For details on entering/editing text and the characters that can be entered, refer to “Entering Text” on page 73.*
 -  *To cancel programming, press the **Cancel/C** key. (To cancel programming while the name is being entered, press the **Menu Select** key, and then press the **Cancel/C** key.)*
- 6** By using the one-touch dial keys or the speed dial numbers, specify the recipients.
-  *To specify a speed dial number, press the **Speed Dial** key, and then enter the three-digit speed dial number.*
 -  *If you want to cancel the current selection, press the **Cancel/C** key, and then specify the correct recipient.*
- 7** Press the **Menu Select** key, and then specify another recipient.
-  *Repeat steps 6 and 7 until all recipients have been specified.*
 -  *A one-touch dial key programmed with a group can be specified as a recipient when programming a one-touch dial key for group dialing. In that case, all fax numbers programmed in the specified one-touch dial key (group dial key) are added.*
 -  *To cancel programming, press the **Cancel/C** until the message “FAX REGISTRATION?” is displayed.*
- 8** When you are finished specifying recipients, press the **Start** key. The entered information is programmed with the one-touch dial key, and the message “SELECT REGIST.KEY” appears.
- 9** To program other group dialing, press the one-touch dial key, and then repeat the procedure starting from step 5.
- OR
- To finish the procedure and return to the Fax mode screen, continue pressing the **Cancel/C** key until the Fax mode screen is displayed.

Changing/Deleting Group Dialing Information

The registered group dialing information can be corrected.

- 1** Press the **Menu Select** key, then the ▼ key three times.
- 2** Check that the FAX REGISTRATION screen appears, then press the **Menu Select** key, and then press the ▼ key twice.

- 3 Check that the GROUP DIAL screen appears, and then press the **Menu Select** key.
- 4 Press the one-touch dial key that you want to change or delete.
- 5 Press the **Cancel/C** key.
- 6 Using the ◀ and ▶ keys, select either “EDIT” or “DELETE”, and then press the **Menu Select** key.
 -  If “EDIT” was selected, the group name is displayed. (Continue with step 7.)
 -  If “DELETE” was selected, the group dialing settings are deleted and the message “SELECT REGIST.KEY” appears again.
- 7 If you want to change the name of the group, enter the new name, and then press the **Menu Select** key.
 -  For details on editing text, refer to “Entering Text” on page 73.
- 8 To delete the displayed recipient, press the **Cancel/C** key.
OR
To keep the displayed recipient, press the **Menu Select** key.
- 9 When you are finished making changes, press the **Start** key.
The entered information is programmed with the one-touch dial key, and the message “SELECT REGIST.KEY” appears.
- 10 To change other group dialing, press the one-touch dial key, and then repeat the procedure starting from step 5.
OR
To finish the procedure and return to the Fax mode screen, continue pressing the **Cancel/C** key until the Fax mode screen is displayed.

***Confirmation
Mode***

6

About the Machine's Counters

The number of operations performed since this machine was installed can be checked using the functions available when the **Display** key is pressed.

The following procedure describes how to check the fax/scanner-related counters.

Checking the Counter for Fax Printing

This counter shows the total number of fax prints made since this machine was installed.

- 1 Press the **Display** key, then the ▼ key.
- 2 Check that the TOTAL PAGE screen appears, and then press the **Menu Select** key.
- 3 Press the ▼ key four times.
The FAX PRINT screen appears so that the counter can be checked.
- 4 Press the **Menu Select** key.
The TOTAL PAGE screen appears.



*To return to the Fax mode screen, press the **Cancel/C** key.*

Checking the Counter for Total Scans

This counter shows the total number of scans made, excluding copies, since this machine was installed.

- 1 Press the **Display** key, then the ▼ key.
- 2 Check that the TOTAL PAGE screen appears, and then press the **Menu Select** key.
- 3 Press the ▼ key five times.
The TOTAL SCAN screen appears so that the counter can be checked.
- 4 Press the **Menu Select** key.
The TOTAL PAGE screen appears.



*To return to the Fax mode screen, press the **Cancel/C** key.*

Checking the Transmission/Reception Result From the Message Window

The transmission result information can be checked from the message window.

- 1 Press the **Display** key, then the **▼** key twice.
- 2 Check that the TX/RX RESULT screen appears, and then press the **Menu Select** key.
The TX/RX Result screen appears so that the information can be checked.



*When the **Start** key is pressed, details of the report displayed on the message window can be printed.*

- 3 To finish checking and return to the Fax mode screen, continue pressing the **Cancel/C** key until the Fax mode screen is displayed.

About the Reports and Lists

Reports on the status of fax transmissions and fax receptions and the contents of the one-touch dial keys, etc. can be printed with this machine.

The following reports and lists can be printed with this machine.



For details on printing the reports and the lists, refer to the following section.

Printing the Reports and Lists

- 1 Press the **Display** key, then the **▼** key three times.
- 2 Check that the PRINT REPORT screen appears, and then press the **Menu Select** key.
- 3 Using the **▲** and **▼** keys, select the desired report.
- 4 Press the **Menu Select** key.
The report is printed.

TX RESULT REPORT

The document number, recipient name, date sent, starting time of transmission, number of document pages, time required, mode, and transmission result are printed.



The machine can also be set to print this report with each transmission, only when an error occurs, or not at all. For details, refer to "REPORTING" on page 24.

SESSION	FUNCTION	NO.	DESTINATION STATION	DATE	TIME	PAGE	DURATION	MODE	RESULT
0001	TX	001	AAA NEWYORK 012345678	APR.19	18:00	010	00h02min21s	G3	NG
			NG PAGE:1,3,5,7						

RX RESULT REPORT

The document number, date received, starting time of reception, number of pages received, time required, mode, and reception result are printed.



The machine can also be set to print this report with each reception, only when an error occurs, or not at all. For details, refer to "REPORTING" on page 24.

SESSION	FUNCTION	NO.	DESTINATION STATION	DATE	TIME	PAGE	DURATION	MODE	RESULT
0001	RX	001	098765432	APR.19	18:00	001	00h02min21s	ECM	NG
			0014:ERROR DURING RX						

ACTIVITY REPORT

The operation number, document number, date of operation, starting time of transmission/reception, type of operation (transmission or reception), recipient name, number of pages sent/received, mode, and transmission/reception result are printed.



The machine can also be set to print this report automatically after every 60 transmissions/receptions. For details, refer to "REPORTING" on page 24.

NO.	SESSION	DATE	TIME	TX/RX	DESTINATION STATION	PAGE	DURATION	MODE	RESULT
01	0001	APR.19	16:32	TX---	AAA NEWYORK 012345678	006	00h01min16s	ECM	OK
02	0002	APR.19	18:00	---RX	098765432	001	00h02min21s	ECM	NG 0034
03	0003	APR.19	18:00	---RX	098765432	012	00h02min48s	ECM	OK
04	0004	APR.19	19:12	TX---	HEAD OFFICE 024682468	001	00h00min56s	ECM	OK

MEMORY DATA LIST

This is a list of documents waiting to be sent, and documents specified for timer transmission.

The document number, type of operation being performed, time, recipient name, and number of document pages are printed.

SESSION	FUNCTION	TIME	NO.	DESTINATION STATION	PAGE
0001	TX	18:00	001	OT-01 AAA NEWYORK 012345678	012

MEMORY IMAGE PRINT

A reduced image of the first page of the document waiting to be sent in addition to the document number, type of operation being performed, recipient name, date, time, and number of document pages are printed.

ONE TOUCH LIST

The recipients programmed in the one-touch dial keys are printed in numerical order of the keys.

OT-NO.	DESTINATION STATION	DESTINATION NUMBER	SPEED	SET DATE
OT-01	AAA NEWYORK	012345678	33.6	JAN.20.2006
OT-02	AAA TOKYO	098765432	33.6	JAN.20.2006
OT-03	HEAD OFFICE	024682468	33.6	FEB.12.2006
OT-04	NJ OFFICE	0P02345678	12.8	FEB.12.2006

SPEED DIAL LIST

The recipients programmed for the speed dial numbers are printed in numerical order.

SP-NO.	DESTINATION STATION	DESTINATION NUMBER	SPEED	SET DATE
SP-001	AMSTERDAM OFFICE	0P09876543	33.6	JAN.20.2006
SP-002	KOREA OFFICE	0P01357913	33.6	JAN.20.2006
SP-003	ABCDEF	024682468	33.6	FEB.12.2006
SP-004	POST OFFICE	0224466880	12.8	FEB.12.2006

GROUP DIAL LIST

The group dialing settings specified for one-touch dial keys are printed in numerical order of the keys.

KEY-NO.	NAME	NO.	DESTINATION STATION
OT-01	GROUP-01	01	OT-02 AAA TOKYO 098765432
		02	OT-04 NJ OFFICE 0P02345678
		03	SP-001 AMSTERDAM OFFICE 0P09876543

Troubleshooting

7

Problems When Sending Faxes

If the fax cannot be sent correctly, refer to the following table, and then perform the indicated operation. If the fax still cannot be sent correctly, even after performing the described operations, contact your technical representative.



For details on the error messages, refer to “Error Messages on the Message Window” on page 69. For details on troubleshooting procedures for document misfeeds, paper misfeeds, poor print quality, or empty consumables, refer to the Printer/Copier/Scanner User’s Guide.

Symptom	Cause	Solution
The document is not scanned.	The document is too thick, too thin or too small.	Use the original glass to send the fax.
The document is scanned at an angle.	The document guides are not adjusted to the width of the document.	Slide the document guides to fit the width of the document.
The fax received by the recipient is blurry.	The document is incorrectly positioned.	Position the document correctly.
	The original glass is dirty.	Clean the original glass.
	The text in the document is written too faint.	Adjust the resolution
	There may be a problem with the telephone connection.	Check the telephone line, and then try sending the fax again.
	There may be a problem with the recipient’s fax machine.	Make a copy to check that this machine is operating correctly, and then, if the copy was printed correctly, have the recipient check the condition of their fax machine.
The fax received by the recipient is blank.	The document was sent with the front side facing down (when the ADF is used).	Load the document to be faxed facing up.

Transmission is not possible.	The transmission procedure may have been performed incorrectly.	Check the transmission procedure, and then try sending the fax again.
	The fax number may be wrong.	Check the fax number.
	The one-touch dial key or speed dial may be incorrectly programmed.	Check that the keys were correctly programmed.
	The telephone line may be incorrectly connected.	Check the telephone line connection. If it is disconnected, connect it.
	There may be a problem with the recipient's fax machine (such as, no paper or turned off).	Contact the recipient.

Problems When Receiving Faxes

If the fax cannot be received correctly, refer to the following table, and then perform the indicated operation. If the fax still cannot be received correctly, even after performing the described operations, contact your technical representative.



For details on the error messages, refer to "Error Messages on the Message Window" on page 69. For details on troubleshooting procedures for document misfeeds, paper misfeeds, poor print quality, or empty toner, refer to the Printer/Copier/Scanner User's Guide.

Symptom	Cause	Solution
The received fax is blank.	There may be a problem with the telephone connection or with the caller's fax machine.	Check that the machine can make clean copies. If it can, have the caller send the fax again.
	The caller may have loaded the pages backward.	Contact the caller.

Faxes cannot be received automatically.	The machine is set to receive faxes manually.	Set the machine to automatic reception.
	The memory is full.	Load paper if it is empty, and then print the faxes stored in the memory.
	The telephone line is incorrectly connected.	Check the telephone line connection. If it is disconnected, connect it.
	There may be a problem with the caller's fax machine.	Make a copy to check that this machine is operating correctly, and then, if the copy was printed correctly, have the recipient check the condition of their fax machine.

Error Messages on the Message Window

Error message	Cause	Solution
LINE PROBLEM ⬆ (Flashing alternately) CHECK LINE	<ul style="list-style-type: none"> ■ The telephone dialing system or telephone wiring system is not set correctly. ■ The telephone cable is not attached correctly. 	<ul style="list-style-type: none"> ■ Check the telephone dialing system or telephone wiring system and use the appropriate configuration menu to make the correct settings. ■ Correctly connect the telephone cable.
COMM.ERROR (####)	<ul style="list-style-type: none"> ■ Communication is not possible because of some problem in the machine. ■ Communication is not possible because of a problem with the recipient/caller's fax machine. 	Check the transmission results.
REDIAL ALL FAILED	All redial attempts failed because either the recipient's line is busy or there was no answer.	Check the condition of the recipient's line, and then try sending the fax again.
MEM.FULL/TX CANCEL	While sending a fax, the size of the data for the scanned image has exceeded the capacity of the memory.	<p>Retrieve all received faxes stored in the memory.</p> <p>Send the fax by direct transmission.</p> <p>To print an error report, press the Cancel/C key while an error message is displayed.</p>
MEM.FULL/RX CANCEL	While receiving a fax, the size of the data for the scanned image has exceeded the capacity of the memory.	<p>Retrieve all received faxes stored in the memory.</p> <p>To print an error report, press the Cancel/C key while an error message is displayed.</p>
HANG UP THE PHONE	The receiver of the connected telephone is lifted.	Replace the receiver of the connected telephone on the hook.

Error message	Cause	Solution
TEXT x1.00 1 Ⓚ[A] #XXX Warn Fax	A fax error occurred while an operation was being performed in Copy mode.	Press the Fax key to check the error condition, and take appropriate measures.
TEXT x1.00 1 Ⓚ[A] #XXX Comm. Err	A fax transmission error occurred while an operation was being performed in Copy mode.	Press the Fax key to check the error condition, and take appropriate measures.
PLEASE WAIT! ADMINISTERED BY PC	This machine is accessing LSU or the Admin. Mode of PageScope Web Connection.	<ul style="list-style-type: none"> ■ Log off from PageScope Web Connection. ■ Exit LSU. ■ If no operation is performed for 600 seconds, the main screen appears.

Appendix

A

Technical Specifications

Compatible lines	PSTN (Public Switched Telephone Network), PBX (Private Branch eXchange)
Compatibility	ECM/Super G3
Modem speed	33600, 31200, 28800, 26400, 24000, 21600, 19200, 16800, 14400, 12000, 9600, 7200, 4800, 2400 (bps)
Fax transmission speed	3 sec/page (at V.34)
Coding method	MH, MR, MMR, JBIG
Memory for receiving	4 MB (approx. 250 pages)
Original	<ul style="list-style-type: none">■ ADF Maximum size: Legal <input type="checkbox"/> Width: 140 to 216 mm Length: 148 to 500 mm (500 mm: Tx only)■ Original Glass Maximum size: Legal <input type="checkbox"/>
Paper size	Maximum Legal <input type="checkbox"/>
Edge erase	4 mm (top, bottom, left, right)
Scanning density	Main scanning direction: 8 dots Sub-scanning direction: 3.85 dots (STD) 7.7 dots (FINE) 15.4 dots (S-Fine)



For details on other specifications, refer to the Printer/Copier/Scanner User's Guide.

Entering Text

When specifying the user name or programming the recipient name with one-touch dial keys, letters, accented characters, numbers and symbols can be entered.

Key Operation

Use the keypad to enter numbers, letters, and symbols.

List of characters available with each key of the keypad

Entering Fax Numbers

Keypad Key	Available characters	Available characters (Registration of USER FAX NO.) *	
	[1]	[1]	[A]
1	1	1	-1
2	2	2	2
3	3	3	3
4	4	4	4
5	5	5	5
6	6	6	6
7	7	7	7
8	8	8	8
9	9	9	9
0	0	0	(space)0
* ✳	*		
#	#		+

* To display your fax number, select USER FAX NO. in the USER SETTING menu.

Entering Names

Keypad Key	Available characters	
	[1]	[A]
1	1	.,'?¿! "1-()@/;:_
2	2	ABC2abcÆÇàáâãäåæç
3	3	DEF3defÐèéëèð
4	4	GHI4ghiiïfir
5	5	JKL5jkl€£¢
6	6	MNO6mnoØŒñòóôõöøœ°
7	7	PQRS7pqrsß\$
8	8	TUV8tuvùúûü
9	9	WXYZ9wxyzþÿþ
0	0	(space)0
*		
#	#	*+x÷=#%&<>[]{} μ^~

Entering Email Addresses

Keypad Key	Available characters	
	[1]	[A]
1	1	._@_-1
2	2	ABC2abc
3	3	DEF3def
4	4	GHI4ghi
5	5	JKL5jkl
6	6	MNO6mno
7	7	PQRS7pqrs
8	8	TUV8tuv
9	9	WXYZ9wxyz
0	0	(space)0
*		
#	#	+&/!*=?()%)%[]^`'{} ~\$

Changing Input Mode

Each press of the \times key switches the input mode between numbers and letters.

[1]: Numbers can be typed in.

[A]: Letters can be typed in.

Inputting Example

The procedure for entering text is described below, using "NJ Office" as an example.

- 1 Press the \times key to change the input mode so that letters can be entered.
- 2 Press the **6** key twice.
"N" is entered.
- 3 Press the **5** key once.
"J" is entered.
- 4 Press the **0** key once.
A space is entered.
- 5 Press the **6** key three times.
"O" is entered.
- 6 Press the **3** key seven times.
"r" is entered.
- 7 Press the **▶** key.
The cursor moves to the right.
- 8 Press the **3** key seven times.
"r" is entered.
- 9 Press the **4** key seven times.
"i" is entered.
- 10 Press the **2** key seven times.
"c" is entered.
- 11 Press the **3** key six times.
"e" is entered.

Correcting Text And Input Precautions

- To erase all entered text, hold down the **Cancel/C** key.
- To delete only part of the entered text, use the ◀ and ▶ keys to move the cursor () to the character that you want to delete, and then press the **Cancel/C** key.
- If multiple characters are assigned to a single key, "OK=▶" appears at the bottom of the screen.
- If the same key is to be used to enter two characters in a row, press the ▶ key after selecting the first character. (Refer to the above inputting example.)
- To enter a space, press the **0** key.

Index

A

ADF 2

C

Canceling

Memory 42

Confirm 59

Control panel 2, 6

Counter

Total scans 60

Counters 60

Fax printing 60

D

Deleting

Memory 42

Dialing, direct 35

E

Entering text 73

Correcting text 76

Input mode 75

Input precautions 76

Error messages 69

F

Fax mode screen 10

Footer 48

G

Group dial

Changing/Deleting 56

Programming 55

H

Header 43

I
Imageable area 47
Input mode 75

K
Key operation 73
Keypad 6

L
Lists 61

GROUP DIAL LIST 64
MEMORY DATA LIST 63
ONE TOUCH LIST 63
Printing 61
SPEED DIAL LIST 63

M
Manual
Reception 46
Transmission 41
Memory
Cancel/delete 42
Queue 42
Memory reception 27
Memory RX mode 27
Setting up 27
Turning off 28

Menu
COMM. SETTING 23
FAX REGISTRATION 19
MACHINE SETTING 18
Overview 12
REPORTING 24
RX SETTING 21
Specifying Settings 26
TX SETTING 20
USER SETTING 25
Multiple recipients
Broadcast 38
Group dial 35

O
One-touch dial key 6

Changing/Deleting 52
Programming 50
Specifying a recipient 35

P
Parts 2
Phone book
List 36
Search 37
Printable area 47

R
Receiving faxes
Automatic reception 46
Manual reception 46
Memory reception 27
Printing 47
Reception result 61, 62
Recipients
Multiple recipients 38
Registering 49

Redial 38
Registering recipients 49
Group dial 55
One-touch dial 50
Speed dial 53

Reports 61
ACTIVITY REPORT 62
MEMORY IMAGE PRINT 63
Printing 61
RX RESULT REPORT 62
TX RESULT REPORT 61

Resolution
Improving fax resolution 34

S
Sending faxes
Basic fax operation 30
Manual transmission 41
Redial 38
Timer 40

Specifications 72
Specifying a recipient
Direct dialing 35

One-touch dial key 35

Speed dial 36

Specifying recipient 34

List 36

Phone book 36, 37

Search 37

Speed dial

Changing/deleting 54

Programming 53

Specifying recipient 36

T

Timer transmission 40

Transmission result 61

Troubleshooting 65

Receiving faxes 67

Sending faxes 66

