



BigTel 480

Bedienungsanleitung

User manual

Mode d'emploi



DE

GB

FR



1	Safety Information	30
2	Preparing the Telephone	32
3	Operating Elements	34
4	Preliminary Information	35
5	Telephoning	36
6	Other features	38
7	Call list / Redial	40
8	Phone book / Direct call keys	41
9	Setting the telephone	44
10	Answering machine	49
11	Registering/de-registering handsets	53
12	PBX / Supplementary Services	54
13	Appendix	55

1 Safety Information

Please read this operating instruction manual thoroughly.

Intended use

The telephone is suitable for telephoning within a public telephone network system. Any other use is considered unintended use. Unauthorised modification or reconstruction is not permitted. Under no circumstances open the device or complete any repair work yourself.

Installation location

Prevent excessive exposure to smoke, dust, vibration, chemicals, moisture, heat and direct sunlight.

Do not use the handset in potentially explosive areas.

Power adapter plug

⚠ Attention: Only use the power adapter plug supplied because other power supplies could damage the telephone.
The socket outlet should be installed near the equipment and you should ensure access to the power adapter plug is not obstructed by furniture or such.

Rechargeable batteries

⚠ Attention: Never throw batteries into a fire.
Only use batteries of the same type. Pay attention to the correct polarity. Incorrect polarity of the batteries represents a risk of explosion during charging.

Power failure

In case of a power failure you can only use the desktop telephone to make calls. Functions like hands-free, Boost etc, which depend on an external power supply will not work.

Medical equipment

 **Attention:** Never use the telephone in the vicinity of medical equipment. Effects on such equipment cannot be fully ruled out. It is recommended that if you have a pacemaker fitted you check with a medical expert or your health adviser before using this product.

DECT¹ telephones can cause an unpleasant humming sound in hearing aids.

Earpiece Volume

Your telephone has an amplifying key, which amplifies the earpiece volume significant if it is pressed. In the display "Boost On" is flashing. To switch off the activated amplification press the key again. "Boost On" disappears. You can switch on the boost function permanently via the menu (handset: Boost On -> On / desktop telephone: Settings -> Boost on -> On). On the handset's display "Boost On", and on the desktop telephone's display the icon  appears. By pressing the amplifying key you can switch off the amplification for the present call. For the next call it will be on again.

Caution: This telephone is capable of producing very high volume levels when the amplification is turned on (amplification key + earpiece volume setting level 5 = +30 dB). Extreme caution should be taken if the handset is to be shared between users with normal hearing and those with hearing impairment.

¹ DECT: Digital Enhanced Cordless Telecommunication = Standard for cordless telephones

Disposal

In order to dispose of your device, take it to a collection point provided by your local public waste authorities (e.g. recycling centre). According to laws on the disposal of **electronic and electrical devices**, owners are obliged to dispose of old electronic and electrical devices in a separate waste container.

The adjacent symbol indicates that the device must not be disposed of in normal domestic waste!

Batteries represent a hazard to both health and the environment! Never open, damage or swallow batteries, nor allow them to get into the environment.

They may contain toxic and ecologically hazardous heavy metals. You are legally obliged to dispose of batteries at the point of sale or at appropriate collection points provided by your local public waste authorities. Disposal is free of charge. The adjacent symbols indicate that batteries must not be disposed of in normal domestic waste and but at authorised collection points.

Packaging materials must be disposed of according to local regulations.



2 Preparing the Telephone

Safety information

⚠ Attention: It is essential to read the Safety Information in Chapter 1 before starting up.

Checking the package contents

- 1 Desktop telephone
- 1 Power supply for desktop telephone
- 1 Charging station with power adapter plug
- 1 Handset
- 1 Telephone connection cable
- 3 Rechargeable batteries
- 1 Operating instructions



The power adapter plugs supplied fulfils the eco-design directive of the European Council (Directive 2005/32/EC).

This means that power consumption is considerably lower than power adapter plugs of an earlier design both in operating and idling modes.

Connecting the desktop telephone

⚠ Attention: Position the desktop telephone at least 1 m away from other electronic devices, otherwise there is a risk of mutual interference.

Connect the desktop telephone as illustrated in the diagram. For reasons of safety, only use the power adapter plug and telephone connection line supplied.

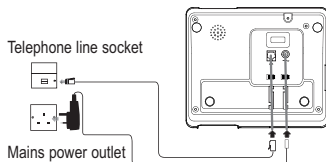

⚠ Attention: You should ensure access to the power adapter plug is not obstructed by furniture or such.

Connecting the charging station

Connect the charging station to a mains power outlet.

⚠ Attention: You should ensure access to the power adapter plug is not obstructed by furniture or such.

Inserting the batteries

Open the battery compartment cover. Put in the batteries. Close the battery compartment cover.

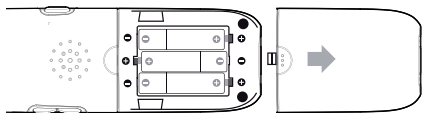

⚠ Attention: Use only type AAA NiMH rechargeable batteries, 1.2 V, 600 mAh. Never use normal batteries / primary cell batteries. Observe the correct polarity!

Charging the batteries

 Before the handset is used for the first time, insert it in the charging station for at least 16 hours.

The handset warms up during the charging process. This is normal and does not represent a risk. Use only the adapter plug unit provided for the charging station. The battery status is shown on the display. When the battery capacity is nearly exhausted, the battery symbol () will flash and "Battery Low" will appear in the display). You should now put the handset for charging into the charging station.

Setting the time and date

At initial operation the telephone does not have the correct time (e.g. for entries in the call list). The display shows "12:00". You only have to do this setting on one of the devices; the other one will take date and time from that one.

Date and time are set in the menu (handset: Time -> Date and Time / desktop telephone: Time -> Date & Time). In the case of mains failure for the desktop telephone these settings will be lost.

Setting the display language

The display language is available in different languages. The default setting is "English". Set the language using the menu (handset: Handset -> Language / desktop telephone: Display -> Language). The amendment applies only for the desktop telephone or the handset.

Auto Answer (handset only)



If this function is activated, an incoming call is taken when the handset is removed from the charging station. The automatic answering function is activated and deactivated using the menu item "Handset / Auto Talk".

Hands-free operation (desktop telephone only)

The hands-free function only works if the receiver is placed on the device.

If you have taken a call by pressing the hands-free button and then lift the receiver, the loudspeaker will be switched off. The icon  disappears from the display.

If you now replace the receiver the call will be ended.

To switch hands-free on again, press the hands-free button . The icon  lights up again and you can hang up the phone and proceed in hands-free mode.

Press the hands-free button  to end the call.

3 Operating Elements

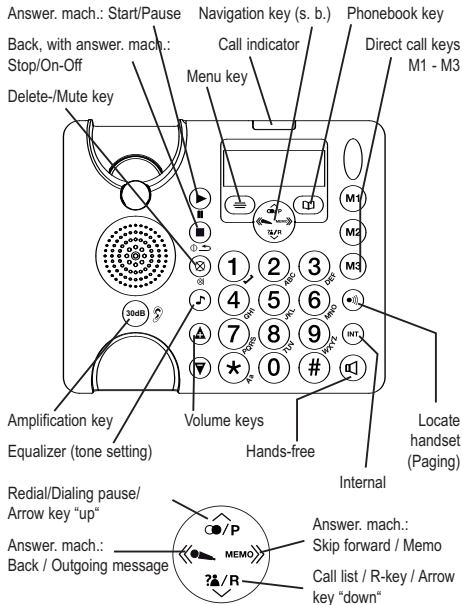
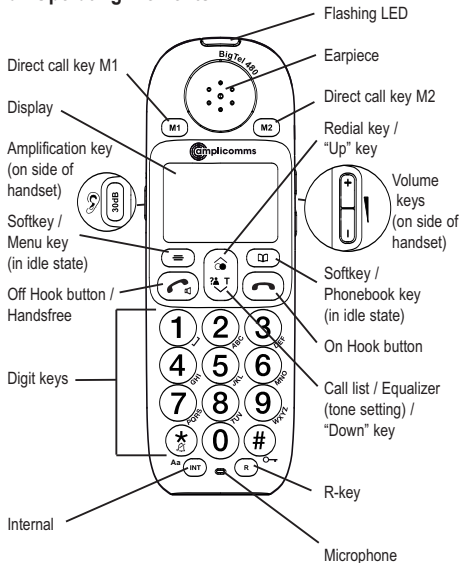

4 Preliminary Information





Standby mode

All descriptions in this operating manual assume that the desktop telephone and the handset are in Standby mode. The system switches to Standby mode by replacing the receiver on the desktop telephone or pressing the button  on the handset.





Navigating in the menu

All the functions can be accessed via the menu. The entire menu structure can be found in the appendix.







Handset













The menu is opened in idle mode with the key .
Use the arrow keys  and  to move within the menu.
Press the softkey under  to open a sub menu.
To return to the main menu press the softkey under .

Desktop telephone

The menu is opened in idle mode with the key .
Use the arrow keys  and  to move within the menu.
Press the menu key  to open a sub menu.
To return to the main menu press the key .

Display icons

-  You are in an external call.
-  You are in an internal call.
-  Hands-free is activated (refer to the note on page 33).
-  The phone book is open
-  The key lock is activated (handset only).
-  The microphone is muted (handset).



-  The microphone is muted (desktop telephone).
-  There are entries in the call list. Flashes, if there are new entries (handset).
- CLIP** Flashes, if there are new entries in the call list. Steady on, if the call list is open (desktop telephone).
-  You have a message waiting on the network (depending on your provider). Please contact your provider for information.
-  The ringer is set to "Off".
-  An alarm is set (handset only).
-  Steady on: handset within range of the base station/desktop telephone (handset only).
-  Flashing: handset out of range (handset only).
-  The answering machine is switched on (handset only).
-  Amplification is permanently on (desktop telephone only).
-  Batteries 100% full (handset only).
-  Batteries approx. 50% full (handset only).
-  Batteries nearly empty / recharge batteries (handset only). During charging the icon is animated.

5 Telephoning

Taking a call

  Your phone is ringing.

On the desktop telephone

 /  Lift the handset or press the handsfree button.

On the handset

If the handset is **not** in the charging station:

 Press the Off Hook button. To activate Handsfree press the Off Hook button once again.

If the handset is in the charging station and **Auto Talk** is **not** activated:

 Press the Off Hook button. To activate Handsfree press the Off Hook button once again.

If the handset is in the charging station and **Auto Talk** is activated:

 Remove the handset from the charging station - the call will be taken automatically.

Making a call

On the desktop telephone

 Enter the telephone number.

Delete wrong characters pressing .

 /  Lift the handset or press the handsfree button.

On the handset



 Enter the telephone number.

Delete wrong characters pressing the softkey under .

 Press the Off Hook button.





 You can also press the Off Hook button or lift the receiver and you will hear the dialling tone.
The entered number will be dialled immediately. It is not possible to correct wrong digits individually using this dialling procedure.

Ending a call

 /  Press the On Hook button or replace the handset in the charging station or replace the receiver or press the handsfree button.





Redial

 Your telephone saves the last 10 dialled telephone numbers. If a caller is stored in your phone book, the name will be displayed.

 Open the redial list.
 /  Select an entry.
 /  Press the Off Hook button or lift the receiver or press the handsfree button.

Making a call from the call list

 Your telephone saves the numbers of the last 30 incoming calls in the call list. If a caller is stored in your phone book, the name will be displayed.
Saving can only take place if the function "Phone number transmission (CLIP)" is available at your connection and caller ID is not suppressed by the caller or was not transmitted for any other reason.

 Open the call list.
 /  Select an entry.
 /  Press the Off Hook button or lift the receiver or press the handsfree button.

Making a call from the phone book

 You can store up to 50 entries in the phone book.
For creating entries see section "Phone book", page 41.



Open the telephone book.



Select an entry.



Press the Off Hook button or lift the receiver or press the handsfree button.

Making a call using the direct call keys

 Your handset provides two, your desktop telephone three direct call keys M1, M2, M3. For storing and editing entries see section "Direct call keys", page 42.

M1 / M2 / M3 Press one of the direct call keys.





Press the Off Hook button or lift the receiver or press the handsfree button.

Call timer

Your handset automatically times the duration of every call in minutes and seconds.

Muting the microphone

During a call you can switch the microphone off.

On the handset press the softkey under , on the desktop telephone press .

To unmute on the handset press the softkey under **Off**, and on the desktop telephone press  again.

Internal calls

Making an internal call



Press the **INT** key. Enter the internal number of the desired handset or "0" for the desktop telephone.

Transferring an external call

During an external call . . .



Press the **INT** key.







Enter the internal number of the desired handset or "0" for the desktop telephone.

The external call is put on hold.

When the called device answers you can announce the call transfer.



Press the On-Hook key or replace the receiver. The call will be transferred.

  If the called handset does not answer you will get back to the external call by pressing the  key (on the handset) or the key  (on the desktop telephone).

3-Party Conference

During an external call . . .



Press the **INT** key.



Enter the internal number of the desired handset or "0" for the desktop telephone.

When the called device answers press the softkey under **Conf.** (on the handset) or press and hold the key  for approx. 2 s. (on the desktop telephone).

The 3-party conference is established.

 If any handset hangs up during a conference call will leave the other handset still in connection with the external call.

External call during an internal connection

When you are on an internal call the display on the desktop telephone and an attention tone in the ear-piece of the handset will announce an incoming external call.



Press the On-Hook key or replace the receiver. The internal call will be ended. The external call will be signalled.



Press the Off Hook key or lift the receiver or press the handsfree button to take the external call.

6 Other features

Key lock (handset only)

The key lock prevents functions assigned to buttons being activated inadvertently. Incoming calls can still be taken in the normal way even when the key lock function is activated.



Press and hold down the #-key until **Keypad Locked** appears in the display.



For unlocking the keypad again press the softkey under **Unlock** and subsequently the #-key briefly. **Keypad Unlocked** appears in the display.

Switching the ringer on/off

On the desktop telephone



Press the  key a number of times if necessary until **Ringer off** appears in the display.

On the handset



Press and hold down the star-key until **Ringer Off** appears in the display.



For turning the ringer on again press and hold down the star-key until **Ringer Off** disappears.

You can turn off the ringer via the menu (handset: Handset -> Ringer Volume / desktop telephone: Ringer Tone -> Volume).



Muting the ringer for an incoming call (handset only)

In case of an incoming call you can mute the handset ringer. Nevertheless, you will be able to take the call as long as the caller did not hang up.



Press the softkey under **Silent**.

Setting the earpiece/loudspeaker volume

During a call you can adjust the volume in 5 levels using the volume keys on the side of the handset (if telephoning "normally" -> earpiece volume, with hands-free -> loudspeaker volume). These separate settings will remain at the last selected level when you end the call. On the handset press the keys + and -, on the desktop telephone press  and .

In addition you can increase the earpiece volume during a call by pressing the amplification key; **please refer to the note on page 31.**

Equalizer (changing of the frequency spectrum)

 You can change the sound of the earpiece in three stages (equalizer). The display shows the respective characteristics. The setting will be retained until it is changed again.

On the desktop telephone



Press the shown key in standby mode or during a call.



Select a setting.

EQU 3 = Reduced bass and enhanced treble.

EQU 2 = Flat – no increase or decrease in bass or treble frequencies.

EQU 1 = Increased bass and reduced treble.

After a few seconds, the display goes back to original state.

On the handset



Press the shown key during a call.

Select a setting.

Equalizer 1 = Reduced bass and enhanced treble.

Equalizer 2 = Flat – no increase or decrease in bass or treble frequencies.

Equalizer 3 = Increased bass and reduced treble.

After a few seconds, the display goes back to original state.

7 Call list / Redial

Editing the call list / handset



Open the call list.



Select an entry. Date and time of the respective call are shown. If the caller's number is stored in the phonebook, the name will be shown in addition.

Option



Press the softkey under **Option**. Select one of the following options and press the softkey under ✓.

Save Number

The telephone number will be stored in the phone book. Enter a name, confirm or edit the telephone number and select a melody for the entry.

Save to M1/M2

The telephone number will be stored to the direct call key M1 or M2. Enter a name, confirm or edit the telephone number and select a melody for the entry.

Delete

The entry will be deleted immediately.

Delete All

The complete list will be deleted after a confirmation query.

Editing the call list / desktop telephone



Open the call list.



Select an entry. Date and time of the respective call are shown. If the caller's number is stored in the phonebook, the name will be shown in addition.



Press the menu key.



Select one of the following options and press the menu key.



Save To PB

The telephone number will be stored in the phone book. Enter a name and confirm or edit the telephone number.

Save To M1/M2/M3

The telephone number will be stored to the direct call key M1, M2 or M3. Enter a name and

Delete

confirm or edit the telephone number.

Delete All

The entry will be deleted immediately.

The complete list will be deleted after a confirmation query.

Editing the redial list / handset



Open the redial list.



Select an entry. If the caller's number is stored in the phonebook, the name will be shown in addition. Press the softkey under **Option**

Option

For the description of the options please refer to "Editing the call list / handset".

Editing the redial list / desktop telephone



Open the redial list.



Select an entry. If the caller's number is stored in the phonebook, the name will be shown in addition. Press the menu key.



For the description of the options please refer to "Editing the call list / desktop telephone".

8 Phone book / Direct call keys

 Your handset and your desktop telephone can store up to 50 private phonebook entries with names and numbers each. You can assign each entry to a group. These groups can signal incoming calls with different melodies. Always enter the phone numbers with the area code; this enables a correct display of the respective caller for whom there is an existing entry and whose phone number transmission to your connection is available.

Creating a new entry / handset



Press the phone book key.



Empty telephone book: **Phonebook Empty** is shown. After pressing the softkey under **Option** the display shows **New Entry**.

If there are entries: the first entry is shown.

Press the softkey under **Option**.

Confirm **New Entry** with the softkey under .

Enter the name (max. 16 digits).

Letters are also imprinted on the digit keys. Letters, digits and special characters are entered by pressing the relevant key the respective number of times. You can delete the last character with the softkey under . Use  to switch to capitals and back again. After a short time the cursor skips one position forwards.

Save

After having entered the name press the softkey under **Save**.

Enter the telephone number (max. 24 digits). If your telephone is connected to a PBX start the telephone number with the access code. If a dialling pause is needed, press after the access code the **0** key for approx. 2 sec. A **P** appears in the display.

Save



Save



After having entered the telephone number press the softkey under **Save**.

Select a melody for this entry.

Having done this press the softkey under **Save**.

Back to standby mode.

Creating a new entry / desktop telephone



Press the phone book key.



Empty telephone book: **Empty** is shown. After pressing the menu key the display shows **Add New**.

If there are entries: the first entry is shown.

Press the menu key.

Confirm **Add New** with the menu key.

Enter the name (max. 16 digits).

Letters are also imprinted on the digit keys. Letters, digits and special characters are entered by pressing the relevant key the respective number of times. You can delete the last character with . Use  to switch to capitals and back again. After a short time the cursor skips one position forwards.

After having entered the name press the menu key. Enter the telephone number (max. 24 digits). If your telephone is connected to a PBX start the telephone number with the access code. If a dialling pause is needed, press after the access code the key  for approx. 2 sec. A **P** appears in the display.

After having entered the telephone number press the menu key.

Back to standby mode.



Editing telephone book entries / handset



Press the phone book key.



Select an entry.

Option

Press the softkey under **Option**.



Select one of the following options and press the softkey under .

New Entry

You can create a new entry.

Edit Entry

You can edit the entry. Use the softkey under to delete characters and numbers then add new characters and numbers as required. Please refer to "Creating a new entry".

Show Details

The entry is shown.

Delete Entry

The entry will be deleted.

Delete All

The complete list will be deleted after a confirmation query.

Copy Entry

The entry is being copied to another suitable device (desktop telephone = 0). All suitable devices will be shown. Select the device using the arrow keys and press the softkey under . Allow the operation on the other device.

Copy Append

All entries will be added to the other suitable device's phonebook.

Copy All

All entries will be copied to another suitable device. By this all entries on the other device will be deleted.

You can enter the first letter of the desired name using the alphanumeric keypad. The first matching entry is shown. Scroll to the desired entry using the arrow keys and .

Editing telephone book entries / desktop telephone



Press the phone book key.



Select an entry.



Press the menu key.



Select one of the following options and press the menu key.

Add New

You can create a new entry (see above).

Edit

see menu item "Edit Entry" on the handset.

Delete

see menu item "Delete Entry" on the handset.

Delete All

see menu item "Delete All" on the handset.

Copy Entry

see menu item "Copy Entry" on the handset.

Copy Append

see menu item "Copy Append" on the handset.

Copy All

see menu item "Copy All" on the handset.

Editing the direct call keys / handset

M1 / M2

Press one of the direct call keys.

Option

Press the softkey under **Option**.



Select one of the following options and press the softkey under .

Edit Entry

You can edit the entry. Use the softkey under to delete characters and numbers then add new characters and numbers as required. Please refer to "Creating a new entry" on page 41.

Delete Entry

The entry will be deleted.

If "Empty" is shown after pressing a direct call key select "Edit Entry" for creating a new entry.

Editing the direct call keys / desktop telephone

M1 / M2 / M3

Press one of the direct call keys.

If no number is stored yet **M1/2/3 Empty** will be shown.



Press the menu key and confirm **Add New** with the menu key.



Enter the name and press the menu key.



Enter the telephone number and press the menu key.

If there is an entry the telephone number is shown.

Press the menu key.



Select one of the following options and press the menu key.



Edit

You can edit the entry. Use , to delete characters and numbers then add new characters and numbers as required. Please refer to "Creating a new entry" on page 41.

Delete

The entry will be deleted.

9 Setting the telephone

Date/Time (handset/desktop telephone)

Press the **menu key** (handset/desktop telephone).

Select **Time**.

Press the softkey under **✓** (handset) or the **menu key** (desktop telephone).

Select **Date and Time** (handset) or **Date & Time** (desktop telephone).

On the handset: Enter step by step the year, the month, the day, the hour and the minute using the digit keys and confirm each with the softkey under **Save**.

On the desktop telephone: Enter month, day and year using the digit keys and press the menu key.
Enter the time and press the menu key.

 In case of mains failure on the desktop telephone this setting will be deleted.

Time format (handset/desktop telephone)

Press the **menu key** (handset/desktop telephone).

Select **Time**.

Press the softkey under **✓** (handset) or the **menu key** (desktop telephone).

Select **Set Time Format** (handset) or **Format** (desktop telephone) and press the softkey under **✓** (handset) or the **menu key** (desktop telephone).

Select **12Hour** or **24Hour** and press the softkey under **✓** (handset) or the **menu key** (desktop telephone).

Alarm (handset)

Press the **menu key**.

Select **Time** and press the softkey under **✓**.

Select **Set Alarm** and press the softkey under **✓**.

Select one of the following options and confirm with the softkey under **Save**:

- Once** Enter the alarm time using the digit keys and select a melody. The alarm is given once at the specified time.
- Every Day** The alarm is repeated daily at the specified time. For details for setting refer to "Once".
- Mon to Fri** The alarm is repeated from monday to friday at the specified time. For details for setting refer to "Once".
- Off** Alarm is set to off.

 To confirm the alarm signal, press the softkey under **Stop**. Pressing the softkey under **Zzz..** activates the snooze function. With this function the alarm is repeated up to five times after every 5 minutes before it is switched off completely.

Setting the ringer (handset)

Press the **menu key**.

Select **Handset** and press the softkey under **✓**.

Select **Ring Tone** and press the softkey under **✓**.

Select **External** or **Internal** and press the softkey under **✓**.

Select a melody and confirm with the softkey under **Save**.

Setting the ringer (desktop telephone)

Press the **menu key**.

Select **Base Settings** -> **Ring Tone** (handset) or **Ringer Tone** -> **EXT Melody** or **INT Melody** (desktop telephone) and press the softkey under ✓ (handset) or the **menu key** (desktop telephone).

Select the desired melody and press the softkey under ✓ (handset) or the **menu key** (desktop telephone).

 *Using the handset you can only set the ringer melody for external calls on the desktop telephone.*

Ringer volume (handset)

Press the **menu key**.

Select **Handset** and press the softkey under ✓.

Select **Ringer Volume** and press the softkey under ✓.

Select the desired volume and press the softkey under **Save**.

Ringer volume (desktop telephone)

Press the **menu key**.

Select **Base Settings** -> **Ringer Volume** (handset) or **Ringer Tone** -> **Volume** (desktop telephone) and press the softkey under ✓ (handset) or the **menu key** (desktop telephone).

Select the desired volume and press the softkey under ✓ (handset) or the **menu key** (desktop telephone).

Handset name (handset)

Press the **menu key**.

Select **Handset** and press the softkey under ✓.

Select **Handset Name** and press the softkey under ✓.

Use the softkey under ◀**C** to delete characters. Enter a name using the digit keys and confirm with the softkey under **Save**.

Keypad beep (handset/desktop telephone)

Press the **menu key**.

Select **Handset** -> **Keypad Beep** (handset) or **Key Tone** (desktop telephone) and press the softkey under ✓ (handset) or the **menu key** (desktop telephone).

Select **On** or **Off** and press the softkey under ✓ (handset) or the **menu key** (desktop telephone).

Display contrast (handset/desktop telephone)

Press the **menu key**.

Select **Handset** -> **Contrast** (handset) or **Display** -> **Contrast** (desktop telephone) and press the softkey under ✓ (handset) or the **menu key** (desktop telephone).

Select a setting and press the softkey under ✓ (handset) or the **menu key** (desktop telephone).

Auto Answer (handset)

Press the **menu key**.

Select **Handset** and press the softkey under ✓.

Select **Auto Talk** and press the softkey under ✓.

Select **On** or **Off** and press the softkey under ✓.

 *If **Auto Talk** is on an incoming call will immediately be taken when the handset is taken from the charging station.*

Backlight Time (handset)

Press the **menu key**.

Select **Handset** and press the softkey under ✓.

Select **Backlight Time** and press the softkey under ✓.

Select a setting and press the softkey under ✓.

Confirmation Beep (handset)

Press the **menu key**.

Select **Handset** and press the softkey under ✓.

Select **Confirm Beep** and press the softkey under ✓.

Select **On** or **Off** and press the softkey under ✓.

 For every kind of setting, a long beep is generated to alert user the setting saved.

Selecting the base station (handset)

 If your handset is subscribed to several base stations (for the Big-Tel 480 the desktop telephone is the base station) you can select a base station to operate with the handset ("Manual"). When "Auto" is activated, the handset will automatically choose the closest base unit in standby. During a call there will be no changing of the base station.

Press the **menu key**.

Select **Handset** and press the softkey under ✓.

Select **Select Base** and press the softkey under ✓.

Select **Auto** or **Manual** and confirm with the softkey under ✓.

If you choose **Manual** select one of the base stations from the list and press the softkey under ✓.

Display language (handset/desktop telephone)

Press the **menu key**.

Select **Handset -> Language** (handset) or **Display -> Language** (desktop telephone) and press the softkey under ✓ (handset) or the **menu key** (desktop telephone).

Select a language and press the softkey under ✓ (handset) or the **menu key** (desktop telephone).

Setting Boost on permanently (handset/desktop telephone)

Press the **menu key**.

Select **Handset -> Boost on** (handset) or **Settings -> Boost on** (desktop telephone) and press the softkey under ✓ (handset) or the **menu key** (desktop telephone).

Select **On** or **Off** and press the softkey under ✓ (handset) or the **menu key** (desktop telephone).

 If Boost On is set to ON "BOOST ON" will replace the handset name on stand-by screen. The display on the desktop telephone shows ?.

Dial mode (handset/desktop telephone)

Press the **menu key**.

Select **Base Settings -> Dial Mode** (handset) or **Settings -> Dial Mode** (desktop telephone) and press the softkey under ✓ (handset) or the **menu key** (desktop telephone).

Select **Tone** or **Pulse** (handset) or **Tone** or **Pulse** (desktop telephone) and press the softkey under ✓ (handset) or the **menu key** (desktop telephone).

 In most situations the "Tone" option should be selected.

Recall Time (handset/desktop telephone)

Press the **menu key**.

Select **Base Settings** -> **Recall Time** (handset) or **Settings** -> **Recall** (desktop telephone) and press the softkey under **✓** (handset) or the **menu key** (desktop telephone).

Select **Short** or **Long** and press the softkey under **Save** (handset) or the **menu key** (desktop telephone).

☎ The typical setting for access to analogue telephone networks in Germany is "Short".

Changing the PIN (handset/desktop telephone)

Press the **menu key**.

Select **Base Settings** -> **System PIN** (handset) or **Settings** -> **System PIN** (desktop telephone) and press the softkey under **✓** (handset) or the **menu key** (desktop telephone).

Enter the relevant PIN (default 0 0 0 0) and press the softkey under **✓** (handset) or the **menu key** (desktop telephone).

Enter the new PIN and press the softkey under **✓** (handset) or the **menu key** (desktop telephone).

Enter the new PIN again and press the softkey under **✓** (handset) or the **menu key** (desktop telephone).

*☎ The four digit PIN protects some settings against unauthorized changes.
If you have forgotten your PIN please call our service hotline.*

Appointment (handset)

☎ You can set up to five appointments or reminders which you can give a name and an alarm by date and time.

Press the **menu key**.

Select **Tools** and press the softkey under **✓**.

Select **Appointment** and press the softkey under **✓**.

Select an entry and press the softkey under **✓**.

Select **Edit** and press the softkey under **✓**.

Use the softkey under **◀C** to delete characters. Enter a name using the digit keys and confirm with the softkey under **Save**.

Enter the date using the digit keys and confirm with the softkey under **Save**.

Enter the time using the digit keys and confirm with the softkey under **Save**.

Select a melody and confirm with the softkey under **Save**.

☎ To delete an appointment select "Delete". The appointment will be deleted after a confirmation query.

Stopwatch (handset)

Press the **menu key**.

Select **Tools** and press the softkey under ✓.

Select **Stop Watch** and press the softkey under ✓.

Press the softkey under **Start** to start the stop watch, **Stop** to stop it or **Reset** to set it back to "00:00".

Setting the character font (desktop telephone)

Press the **menu key**.

Select **Settings** and press the **menu key**.

Select **Change Case** and press the **menu key**.

Select a character font (**ABC** = without special characters / **ÄÅÄÄÄÄÄ** = with special characters / **ΑΒΓ** = greek / **АБВГ** = cyrillic). The character font is used for entries in the phonebook.

Resetting the handset

Press and hold the **R key** for approx. 10 s.

Confirm **Handset Reset?** with the softkey under ✓.

The handset will be reset to default.

Resetting the desktop telephone

Press the **menu key**.

Select **Reset** and press the **menu key**.

Confirm **BaseReset?** with the **menu key**.

The desktop telephone will be reset to default.

10 Answering machine







The answering machine is operated on the desktop telephone. It supports you during operation and settings via voice prompts. You can select one of three different languages.

There are two modes possible:

- Outgoing message 1 = Answer and record (2 minutes per call)
- Outgoing message 2 = Answer only.

In delivery state two standard OGMs are recorded, which can be replaced with your own announcements (max. 2 minutes each).

The keys

Key	In standby mode		During playback
	press briefly	press and hold 2 s	
	Playback outgoing mess.	Record new outgoing mess.	Skip back
	Playback messages		Pause/Resume
MEMO 		Record memo	Skip next
 	Volume voice & ringer		Playback volume
	Aswer. mach. On/off	Select outgoing message	Stop playback
		Delete all messages	Delete message or outgoing message

Display

Answer Off
xx Message

Answering machine off
Outgoing message 1, answer & record (xx = number of messages / flashing: number of new messages).

Answer Only
DTAM In Use
Memory Full

Outgoing message 2, answer only.
A handset is operating the answering machine
Memory full, the answering machine will automatically switch to OGM 2 without recording incoming messages. Delete old messages to get free memory space again.

- A
- P

Incoming call or remote access.
Pause during playback.

Answering machine on/off / select OGM



Press the shown key to switch the answering machine on or off. When switching on you will hear an information about the selected OGM.

- **Outgoing message 1** = OGM and record (2 minutes per call)
- **Outgoing message 2** = OGM only



> 2 sec. To change the OGM (answering machine must be set to "On"), press and hold down the shown key for approx. 2 seconds. The OGM will be switched.

 You can set the mode in the desktop telephone's menu as well:
Ans Machine -> Answer Mode -> Answer&Record/Answer only/Answer off.

Playback messages on the handset

You can playback messages on the handset. If there are new messages, the display will show "New message(s)" and the number of new messages.

Playback new messages



Press the softkey under **▶**.
A voice prompt plays how many new messages are recorded. It then plays new messages from first recorded to last one by one.
For more information in operating refer to the next chapter "Playback all messages".

Playback all messages



Press the menu key.



Select **Ans Machine** and press





the softkey under **✓**.



Select **Play New Msgs** or **Play All Msgs**



and press the softkey under **✓**.

A voice prompt plays how many messages are recorded. It then plays new messages from first recorded to last one by one via the loudspeaker. If you want to hear the messages via the earpiece press . To switch the loudspeaker on again press .



To skip to the next message during playback, press the softkey under **▶▶**.



To delete the current message during playback, press the softkey under **Delete**.

In addition you can use the following digit keys:

- 2 Interrupt playback / restart playback
- 3 Skip forward to next message
- 1 Skip back to previous message
- 6 Stop playback

Call screening / Interception (handset)

Once the answering machine has taken a call you can listen to the caller.

Press . The answering machine continues recording.

If you want to intercept the call and speak to the caller, press .

The answering machine will stop recording.

Playback messages on the desktop telephone



Press the playback key. The messages are played one at a time. If there are new messages, only the new messages (those that have not been heard) are played.

During playback, you can:



- skip back to previous message.



- stop playback.



- interrupt playback, for restart playback press the key once again.



- skip forward to next message.



Deleting messages on the desktop telephone

During playback



Press and hold down the shown key for approx. 2 seconds. The current message will be deleted.

Deleting all old messages

Only old messages (already heard) are deleted.



In standby press and hold down the shown key for approx. 2 seconds. The messages will be deleted after a confirmation query.

☎ You can delete the messages in the desktop telephone's menu as well: : Ans Machine -> Del.All Msgs

Outgoing message (OGM)

Playback / delete current outgoing message



Press the shown key briefly. The answering machine will playback the current OGM.



Stop playback with the stop key.



Press and hold down the delete key for approx. 2 seconds to delete the OGM (you will hear a voice prompt). The standard OGM cannot be deleted.



Recording a personal OGM

Select an OGM you want to replace (refer to "Answering machine on/off / select OGM", page 49).



> 2 sec Press and hold down the shown key for approx. 2 seconds.



To stop the recording press the stop key.



The answering machine will playback the recorded OGM.

Recording a memo

You can record memos for other users. These memos are considered an incoming message that can be picked up later by the user. The max. recording time for a memo is 3 minutes.

MEMO >> > 2 sec Press and hold down the memo key for approx. 2 seconds. Speak your memo.
To stop the recording press the stop key.

Answer delay settings

Select the delay for answering the call: select 2...9 rings or "Toll saver". If "Toll saver" is set, a call will be taken after 5 rings, if no new messages are available. If new messages are available, the answering machine will answer after two rings. Therefore you can check remotely whether or not new messages are available without having to make a connection.

Press the **menu key**.

Select **Ans Machine** and press the **menu key**.

Select **Answer Delay** and press the **menu key**.

Select a setting and press the **menu key**.

Remote access code settings

The remote access code is a 3-digit code used to operate the machine remotely (refer to "Remote Operation"). The remote access code is set to '0 0 0' by default.

Press the **menu key**.

Select **Ans Machine** and press the **menu key**.

Select **Remote PIN** and press the **menu key**.

Enter the relevant remote PIN (default 0 0 0) and press the **menu key**.

Enter the new remote PIN and press the **menu key**.

Enter the new remote PIN again and press the **menu key**.

Setting the language for outgoing messages (OGM)

You can select one of three different languages, i.e. German, French and English.

Press the **menu key**.

Select **Ans Machine** and press the **menu key**.

Select **Language** and press the **menu key**.

Select a language and press the **menu key**.

Remote operation

The answering machine can be operated remotely using a tone-dialing (DTMF) telephone.

1. Dial your own telephone number.
2. If the answering machine is set to on it will answer after the preset delay. If the answering machine is set to off, it will answer after 20 rings with OGM 2.
3. Wait for the end of the announcement and then press the star key 2 times. You will hear a beep.
4. Slowly enter the remote access code (default "0 0 0").
5. You will hear two short beeps for confirmation.
6. Follow the spoken information for using the remote access.
 - 2 Playback messages
 - 2 Interrupt playback / restart playback
 - 3 Skip forward to next message
 - 1 Skip back to previous message
 - 6 Stop playback
 - 7 Delete current message
 - 0 Delete all old messages
 - 4 Playback current OGM
 - 9 Turn on answering machine / Toggle between "Answer and Record" mode and "Answer Only" mode
 - 5 Record new OGM
 - 6 Stop recording
 - 8 Turn off answering machine
 - 6 Stop remote operation.

11 Registering/de-registering handsets

Up to five handsets can be registered to a base station (desktop telephone). The handsets delivered with your telephone are already registered.

Each handset can be registered to four base stations.

To register a "foreign" handset please refer to it's user manual.

Registering a handset of the same type (handset)

Press the **menu key**.

Select **Handset** and press the softkey under ✓.

Select **Registration** and press the softkey under ✓.

Select **Register** and press the softkey under ✓.

Select a number for the base station (1 - 4) and press the softkey under ✓.

Enter the relevant PIN for the base, the new handset should be registered on and press the softkey under ✓.



Press and hold down the paging key on the desktop telephone until the display shows "Register . . ." (approx. 10 sec).

After a few seconds the handset will be registered.

Deleting a handset (handset)

Press the **menu key**.

Select **Handset -> Registration -> De-register** and press the softkey under ✓.

Enter the relevant PIN for the base and press the softkey under ✓.

Enter the internal number of the handset, that should be de-registered and press the softkey under ✓.

 *You can only cancel subscription of another handset, not the handset you are using to do the remove procedure.*

Deleting a handset (desktop telephone)

Press the **menu key**.

Select **Remove HS** and press the **menu key**.

Enter the internal number of the handset, that should be de-registered and press the **menu key**.

12 PBX / Supplementary Services

PBX

If the telephone is connected to a private branch exchange, functions such as transferring calls and automatic call back can be used via the R button.

Refer to the operating manual provided with your private branch exchange as to which Flash time must be set in order to use these functions. The sales outlet where you purchased the exchange can provide information as to whether the telephone will work properly with the exchange.

Please remember to enter the access code and a necessary dialling pause (longpress "0") when creating phone book entries.

Supplementary services

Your telephone supports supplementary services provided by your telephone network provider, such as brokering, call waiting and conference facilities. These supplementary services can be used via the R-button.

Please contact your telephone network provider regarding which Flash time must be set to use the supplementary services. Contact your telephone network provider with regard to enabling supplementary services.

13 Appendix

Menu Structure (handset)

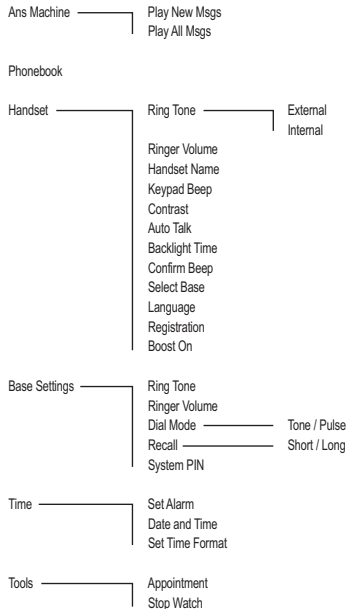

Menu Structure (desktop telephone)

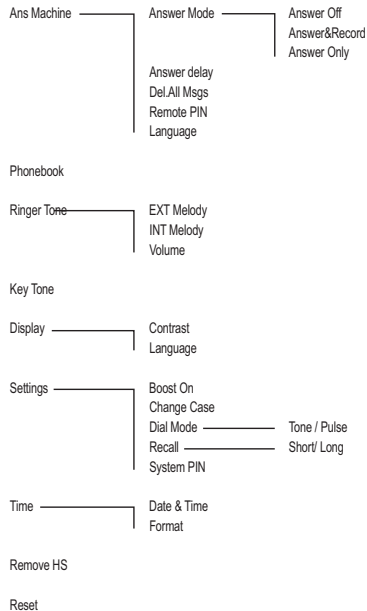

Help and support / Troubleshooting guide

Helpline

If you need some help and you're in the UK, please first check and see if your problem can be solved using the troubleshooting guide below. If it can't, please call us on 0844 800 6503 (using a UK land-line, at the time of going to print: calls cost 6p for connection charge and then 5p a minute. Mobile costs may vary). Lines are open Monday to Friday, 9am to 5pm, excluding public holidays. If you've a claim on your 2-year guarantee, please contact your supplier.

 *Some issues may simply be resolved by disconnecting the power to the unit. In such instances the power to the desktop telephone should be switched off and batteries in the handset should also be removed for about 20 minutes. After which reconnect everything to determine if this has resolved the issue.*

I can't make phone calls

- Make sure the phone cable is connected properly. If it is, there may be a fault. Please make sure you're using the phone cable that came with your phone.
- Check power's plugged in, switched on and working.
- Make sure you aren't too far from the base (in ideal conditions, it should work up to 300 metres outdoors and up to 50 metres indoors).
- Test the phone line and socket by using another phone.

I keep losing my connection

- Make sure you aren't too far from the base station (in ideal conditions, it should work up to 300 metres outdoors and up to 50 metres indoors).
- The base station may not be in an ideal location – consider moving it.

My handset keeps switching off

- It may need recharging. So it can charge fully, place your handset on its charger base for at least 16 hours (make sure the power socket is switched on!).
- Replace the rechargeable batteries. Any replacement batteries should be the same type as those provided.

Caller's identification (Call Line ID) isn't working

- Check you have this service on your phone line. Please call your network provider.
- The caller may have withheld their phone number.

My handset or desktop telephone doesn't ring

- Check that the ringer is on. See page 45.

I've got a buzzing noise on my radio, TV or computer

- We suggest you use your cordless handset at least one metre away from electrical equipment and mobile phones.

There is interference in the earpiece and/or internet connection is very slow when using the phone

- You must plug the phone into the wall socket via an ADSL filter if you have broadband internet on your phone line.

Technical data

Standard: DECT / GAP
 Number of channels: 120 duplex channels
 Frequencies: 1880 MHz to 1900 MHz
 Duplex mode: Time division multiplex, 10ms frame length
 Channel spacing: 1728 kHz
 Bit rate: 1152 kBit / s
 Modulation: GFSK
 Voice encoding: 32 kBit / s
 Transmitter power: 10 mW (average power per channel)
 Range: up to 300 m outside, up to 50 m inside buildings
 Electricity supply desktop telephone:
 100-240 V AC, 7 V / 420 mA DC
 Handset: Operating time: Stand-by time / Talk time
 600 mAh = up to 100 h / up to 10 h
 Charging time: approx. 16 hours
 Operating temperature for handset operation:
 5°C to 45°C ; 20 % to 75 % rel. humidity
 Operating temperature for desktop telephone operation:
 5°C to 45°C ; 20 % to 75 % rel. humidity
 Storage temperature: -10°C to +60°C
 Maximum earpiece volume: +30 dB (distortion < 2%)
 Dial mode: Tone / Pulse
 R-key: Flash (short/long)
 Desktop telephone dimensions (mm): L / B / H = 200 x 155 x 70
 Handset dimensions (mm): L / B / H = 55 x 28 x 170
 Telephone line cord:
 TSV on Pin 3 and 4 according to CTR 37 (Euro)
 Adapter plug: European-type mains connector

Default settings

	Desktop tel.	Handset
Language display	English	English
Character font (deskt. tel.)	ABC	--
Ringer melody	External 8	External 7
	Internal 9	Internal 9
Ringer volume	5	5
Dial mode	Tone	--
Earpiece volume	4	4
Loudspeaker volume	4	4
Key tone	On	On
Recall time	Short	--
Boost on (permanent)	Off	Off
Equalizer	2	2
Auto Talk	--	On
System PIN	0 0 0 0	0 0 0 0
Base selection	--	Auto
Confirmation tone	--	On
Time format	24 h	24 h
Display contrast	4	3
Answering machine	On	
Mode	Answer & record	
Language outgoing mess.	English	
Answer delay	3 rings	
Playback volume	3	

Declaration of Conformity



This device fulfils the requirements stipulated in the EU directives:

- 1999/5/EU directive on radio equipment and telecommunications terminal equipment and the mutual recognition of their conformity.
- 2005/32/EU directive "Energy-using products".

Conformity with the above mentioned directives is confirmed by the CE symbol on the device.

To view the complete Declaration of Conformity, please refer to the free download available on our web site www.amplicomms.com.

Maintenance

Clean the housing surfaces with a soft, fluff-free cloth.

Do not use any cleaning agents or solvents.

Guarantee

AMPLICOMMS equipment is produced and tested according to the latest production methods. The implementation of carefully chosen materials and highly developed technologies ensure trouble-free functioning and a long service life. The terms of guarantee do not apply where the cause of equipment malfunction is the fault of the telephone network operator or any interposed private branch extension system. The terms of guarantee do not apply to the batteries or power packs used in the products. The period of guarantee is 24 months from the date of purchase.

All deficiencies related to material or manufacturing errors within the period of guarantee will be redressed free of charge. Rights to claims under the terms of guarantee are annulled following tampering by the purchaser or third parties. Damage caused as the result of improper handling or operation, normal wear and tear, incorrect positioning or storage, improper connection or installation or Acts of God and other external influences are excluded from the terms of guarantee. In the case of complaints, we reserve the right to repair defect parts, replace them or replace the entire device. Replaced parts or

devices become our property. Rights to compensation in the case of damage are excluded where there is no evidence of intent or gross negligence by the manufacturer.

If your device shows signs of defect during the period of guarantee, please return it to the sales outlet in which you purchased the AMPLICOMMS device together with the purchase receipt. All claims under the terms of guarantee in accordance with this agreement can only be asserted at the sales outlet.

No claims under the terms of guarantee can be asserted after a period of two years from the date of purchase and hand-over of the product.

Index

A		P	
Alarm	.44	Package contents	.32
Answer delay	.51	Phone book	.37, 41
Answering machine	.49	PIN	.47
Answering machine on/off	.49	Playback all messages	.50
Appointment	.47	Playback messages on the handset	.49
Auto Answer	.45	Playback new messages	.50
B		Power adapter plug	.30
Boost	.46	R	
C		Recall Time	.47
Call list	.36, 40	Rechargeable batteries	.30
Call screening	.50	Redial	.36, 40
Call timer	.37	Registering a handset	.53
Character font	.48	Remote operation	.52
Charging the batteries	.33	Reset	.48
Confirmation Beep	.46	Ringer	.44
Connecting the charging station	.32	Ringer volume	.45
Connecting the desktop telephone	32	S	
D		Safety Information	.30
Date/Time	.44	Select OGM	.49
Declaration of Conformity	.58	Selecting the base station	.46
Default settings	.57	Setting the earpiece/loudspeaker volume	.39
Deleting a handset	.53	Standby mode	.35
Deleting messages	.51	Stopwatch	.48
Dial mode	.46	Switching the ringer on/off	.38
Direct call	.37, 42	T	
Display contrast	.45	Taking a call	.36
Display icons	.35	Time format	.44
Display language	.33, 46	Outgoing message	.51
E		Transferring an external call	.37
Disposal	.31		
Earpiece Volume	.31		
Ending a call	.36		
Equalizer	.39		
G			
Guarantee	.58		
I			
In Case of Problems	.56		
Inserting the batteries	.32		
Installation location	.30		
Intended use	.30		
Interception	.50		
Internal calls	.37		
K			
Key lock	.38		
Keypad beep	.45		
M			
Maintenance	.58		
Making a call	.36		
Medical equipment	.31		
Menu Structure	.55		
Muting the microphone	.37		
N			
Navigating in the menu	.35		
O			
Operating Elements	.34		



Vertrieb: Audioline GmbH, D-41460 Neuss

Oktober 2011 – Ausgabe 1.0

