

YAMAHA

SPEAKER SYSTEMS

S112IV/S115IV

SM10IV/SM12IV/SM15IV

S112IV-OAK

S115IVA-OAK

SM10IV-OAK/SM15IV-OAK

SUBWOOFER

SW118IV

CROSSOVER NETWORK

PN90

Owner's Manual

Mode d'emploi

Bedienungsanleitung

Manual de instrucciones

Thank you for purchasing a YAMAHA product. To obtain maximum performance from your YAMAHA speaker system and ensure many years of trouble-free operation, we recommend that you read this Owner's Manual thoroughly before use.

Contents

<i>Precautions</i>	2
<i>Connecting the Speakers</i>	4
<i>Specifications</i>	6
<i>Technical Data</i>	25

Precautions

AVOID EXCESSIVE HEAT, HUMIDITY, DUST AND VIBRATION

When choosing a location for your speakers, avoid the following:

- Direct sunlight, high temperatures (such as near heaters), or excessively low temperatures.
- High humidity.
- Areas subject to excessive dust accumulation and vibration.
- Non-level or unstable surfaces.

HOW TO POWER UP YOUR SOUND SYSTEM

To avoid damage to your speakers and other parts of your system, when you turn on your system, **ALWAYS** turn the power amp on last! This will avoid loud, damaging pops that will annoy your audience, and blow your speakers. When you power down, the amplifier should **ALWAYS** be turned off first to avoid the same problems.

To protect your speakers

When choosing a power amplifier to use with your speakers, make sure that its power output matches the speakers' power capacity (refer to the Specifications on page 6). Even if the amplifier's power output is lower than the speakers' PGM (program) power capacity, the speakers may be damaged when clipping of a high input signal occurs.

The following may cause damage to speakers:

- Feedback caused when using a microphone.
- Continuous high sound pressure level produced by electronic instruments.
- Continuous high-power output distorted signals.
- Popping noises caused by turning on equipment, or by connecting or disconnecting system components while the amplifier is turned on.

MAKE SURE THE POWER IS OFF BEFORE MAKING OR REMOVING CONNECTIONS

Always turn the power switches of system components **OFF** prior to connecting or disconnecting cables. Failure to do so may result in damage to speakers as well as to connected equipment.

DISCONNECT CABLES BEFORE MOVING THE SYSTEM

To prevent short circuits or breakage of cables, always disconnect cables prior to moving system equipment.

MATCH CONNECTOR POLARITY

When using two or more speaker systems, be sure match the polarity (+/-) of the speaker system connectors to those at the amplifier. If the polarities do not match, the sounds produced by the speakers will interfere with each other, making it impossible to achieve a well-balanced sound field.

KEEP THIS OWNER'S MANUAL IN A SAFE PLACE FOR FUTURE REFERENCE

Poly Switch

All full-range loudspeakers are fitted with a self-resetting poly switch that protects the high-frequency driver from damage caused by excessive power.

If a loudspeaker cabinet loses high-frequency output, immediately remove power from the unit and wait for two to three minutes. This should allow the poly switch to reset. Re-apply power and check the performance of the high-frequency driver before continuing with the power reduced to a level that does not cause the poly switch to interrupt the signal.

On the SW118IV sub woofer, the Poly Switch protects the woofer and a similar routine should be followed if its output is lost.



This product, when used in combination with amplification and/or additional loudspeakers, may be capable of producing sound levels that could cause permanent hearing loss.

DO NOT operate at high volume levels or at a level that is uncomfortable. If you experience any discomfort or ringing in the ears, or suspect an hearing loss, you should consult an audiologist.

CAUTION!

The following five models can be mounted on speaker stands: S112IV, S115IV, SM10IV, SM12IV SM15IV. The use of Ultimate Support Systems, Inc. Model TS-30 or TS-33 speaker stands is recommended.

- Use only ONE speaker per stand.
- The loudspeakers and stands must always rest upon a solid, level surface.
- Improper installation or usage could result in the loudspeaker falling and causing injury.
- The top tube of the TS-30 and TS-33 speaker stands has a diameter of 1-1/2", but is tapered to 1-3/8" at the top to fit in the mounting holes on the five models named. If you should remove the top tube from a stand, be sure to insert it with the narrow end up when reassembling.

The SW118IV subwoofer has a metal socket to allow mounting of a satellite speaker. Do not use a pole longer than 56".

SPEAKER HANDLES

The handles on your speakers are for transportation. They are not designed for suspension or hanging. Only the "A" versions of these speakers are designed for suspension. Please consult a qualified engineer for proper hanging techniques.

ATM Fly-Ware

Model S115IVA-OAK only

These speakers are supplied with ATM Fly-Ware rigging hardware installed. The following notes explain how to prepare these speakers for suspension.

IMPORTANT! *This material does not explain how to suspend speakers.*

To properly suspend any speaker, a knowledge of structural engineering and structural rigging is **REQUIRED**. Suspending loudspeakers requires special tools and techniques. Do not attempt to suspend any speaker system unless you have received specific training to do so.

The improper installation of flying speakers can result in bodily injury or death.

Always consult a licensed engineer to verify the design of any suspended system. In addition, please follow these safety steps:

- Use only hardware specifically designed for rigging applications.
- Always use an independent safety suspension system as a backup.
- Get professional help.

To prepare these speakers for suspension:

1. Remove the flathead screws from the top of the speaker.

Note: The 3/8" flathead screws use a 7/32" hex wrench. Take care not to remove both screws from each corner, as the internal bracket will fall inside the loudspeaker.

2. Apply a drop of thread locking adhesive to the end of the threads of the eyebolts.

Note: Please use the supplied eyebolts found in the carrying handle of the speaker. If you use any part other than that supplied, be sure it is Load Rated and know that it will be de-rated if not suspended so that the pull direction is in-line.

3. Install the eyebolts into the holes on top of the speaker and finger-tighten.
4. Securely tighten the eyebolts. Hand tighten +1/2 turn.
5. Inspect the other six (6) flathead screws, making sure they are tightened down.

Connecting the Speakers

CONNECTION EXAMPLE 1

The illustration below shows audio connections for a standard setup using two speaker systems.

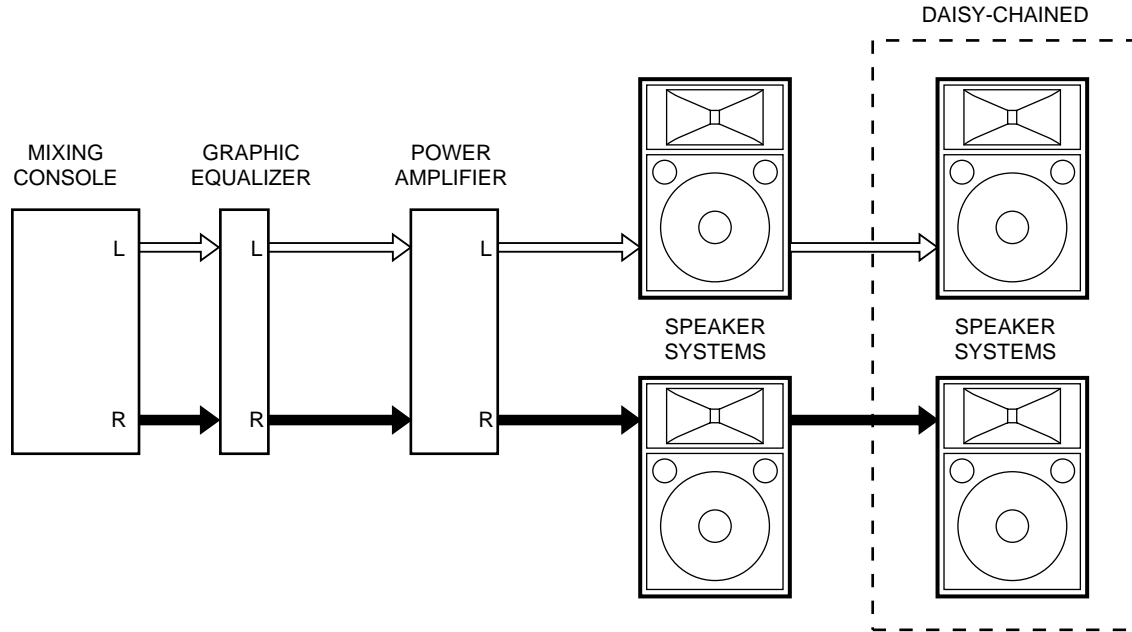

DAISY-CHAINING SPEAKERS

Since the speaker systems in this series are equipped with two input terminals that are internally connected in parallel, it is possible “daisy-chain” speakers by connecting the output from the power amplifier to one phone jack, and a second speaker system to the other.

All speaker models in this series have a nominal impedance of 8Ω . Since most power amplifiers are designed to provide stable performance at a load impedance of 4 or 8Ω , Yamaha recommends that no more than two 8Ω speaker systems be daisy-chained together. This will allow the amplifier to operate properly and avoid overheating.

PHONE PLUG WIRING

The standard input terminals for this unit are 1/4" phone jacks. Connect the speaker leads as shown in this diagram.

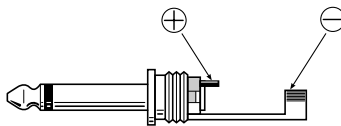

Caution: Use only unshielded speaker cable with stranded conductors to connect speakers to the speaker terminals on a power amplifier. The use of audio cable not rated as sufficient for the amplifier’s maximum output level can create a potential fire hazard.

CONNECTION EXAMPLE 2

This example shows audio connections for a system using SW118IV Subwoofers and a PN90 Crossover Network.

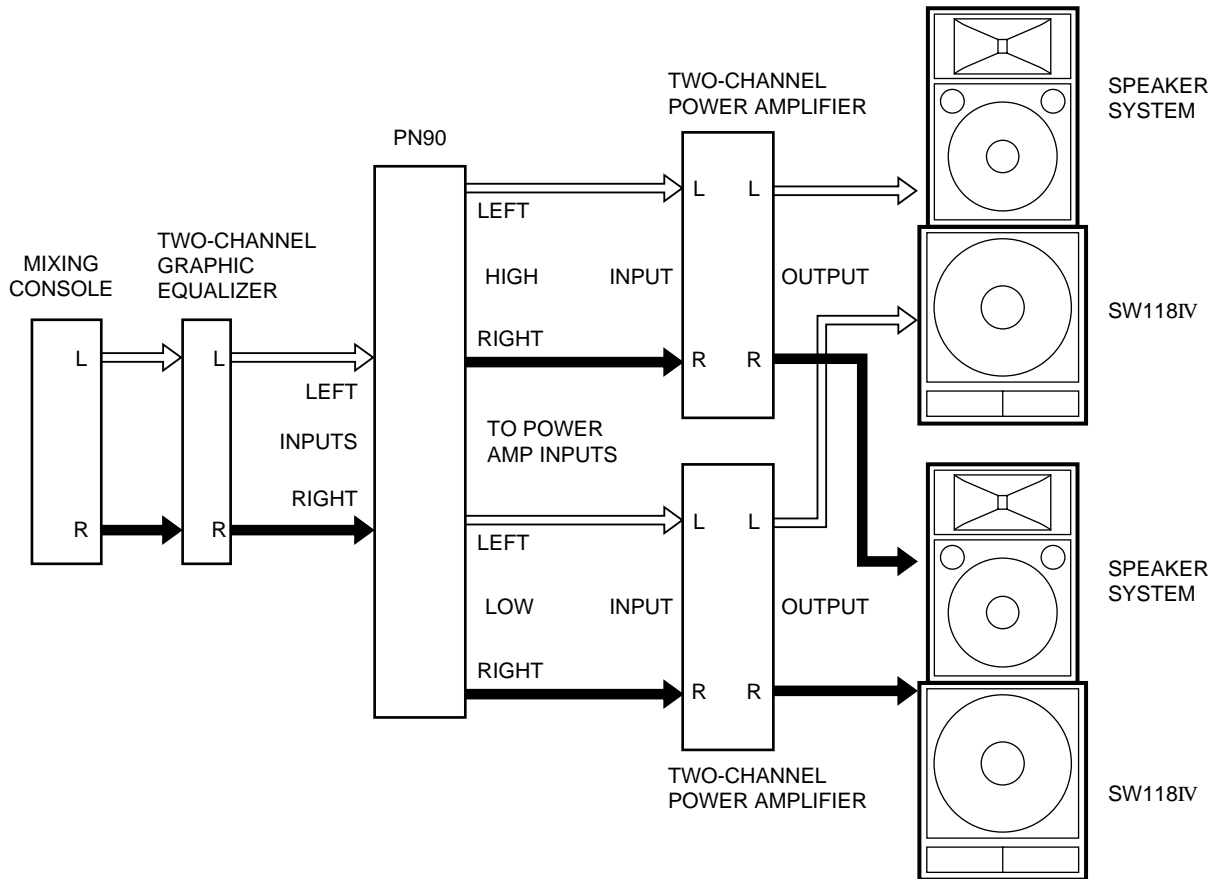

- Do not connect the PN90 between the power amplifiers and the SW118IV subwoofers, as doing so will damage the equipment.
- Although the PN90 has a standard load impedance of 15 k Ω , it can be used with loads between 7.5 and 30 k Ω , allowing use with most power amplifiers.
- Since the LOW signal polarity is inverted at the crossover point between the LOW and HIGH signals, be sure to reverse the polarity when connecting the SW118IV input jacks to the power amplifier output jacks.

This polarity correction must not be made by reversing the polarity of the connections between the PN90 and the power amplifiers, as doing so will damage the equipment. Please reverse the polarity between the power amplifiers and the SW118IVs only.

- The PN90 uses unbalanced connectors. Use shielded audio cable with high-quality phone plugs to connect the PN90.

The balance between the LOW and HIGH signal levels may be adjusted using the power amplifier volume controls. A good starting point is generally achieved for typical sound sources by raising the LOW signal level about 8 dB higher than that of the HIGH signal.

Specifications

Model		SM10IV /SM10IV-OAK	S112IV/SM12IV/S112IV-OAK	S115IV/SM15IV/S115IVA-OAK/SM15IV-OAK
Enclosure		Bass reflex type		
Speaker Unit	LF	10" cone	12" cone	15" cone
	HF	1" driver	2" driver	
Frequency Response		70 Hz to 20 kHz	60 Hz to 16 kHz	55 Hz to 16 kHz
Power Capacity	NOISE*	100 W	150 W	250 W
	PGM	200 W	300 W	500 W
	MAX	400 W	600 W	1000 W
Nominal Impedance		8Ω		
Sensitivity		95 dB SPL (1W, 1m)	97 dB SPL (1W, 1m)	99 dB SPL (1W, 1m)
Nominal Dispersion	Horizontal	60°	90°	
	Vertical	40°		
Crossover Frequency		1.8 kHz	2 kHz	1.7 kHz
Input Connectors		1/4" phone jack x 2 (parallel input)		
Dimensions (W x H x D)		SM10IV: 560 x 339 x 277 mm SM10IV-OAK: 526 x 316 x 261 mm	S112IV: 400 x 638 x 318 mm SM12IV: 643 x 402 x 344 mm S112IV-OAK: 400 x 620 x 318 mm	S115IV: 475 x 712 x 362 mm SM15IV: 720 x 485 x 345 mm S115IV-OAK: 479 x 695 x 360 mm SM15IV-OAK: 695 x 479 x 340 mm
Weight		SM10IV: 12.2 kg SM10IV-OAK: 10.5 kg	S112IV: 19.3 kg, SM12IV: 19.5 kg S112IV-OAK: 18 kg	S115IV: 27.5 kg, SM15IV: 26 kg S115IV-OAK: 27.5 kg, SM15IV-OAK: 26 kg

S112IV, S112IV-OAK,
S115IV, S115IVA-OAK

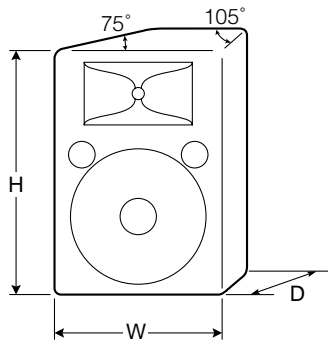

SM10IV, SM10IV-OAK,
SM12IV,
SM15IV, SM15IV-OAK

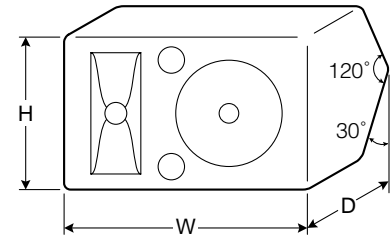

Model		SW118IV
Enclosure		Bass reflex type
Speaker Unit		18" cone
Frequency Response		30 Hz to 2 kHz
Power Capacity	NOISE*	250 W
	PGM	500 W
	MAX	1000 W
Nominal Impedance		8Ω
Sensitivity		96 dB SPL (1W, 1m)
Recommended Crossover Frequency		90 Hz, 12 dB/octave
Input Connectors		1/4" phone jack x 2 (parallel input)
Dimensions (W x H x D)		542 x 654 x 791 mm
Weight		32.4 kg

SW118IV

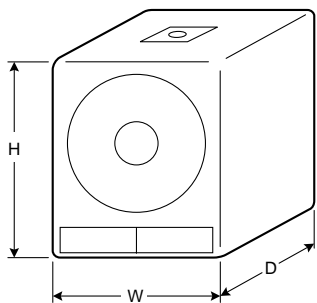

Model		PN90
Crossover Frequency		90 Hz, 12 dB/octave (at 15 kΩ load)
Recommended Load Impedance		15Ω
Insertion loss		3 dB
Input Connectors		1/4" phone jack x 2
Output Connectors		1/4" phone jack x 4
Dimensions (W x H x D)		227 x 38 x 76 mm
Weight		0.6 kg

PN90

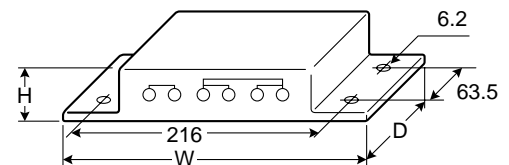

Unit: mm

*: EIA RS-426

Specifications subject to change without notice

Technical Data / Données techniques Technische Daten / Datos técnicos

Frequency Response / Impedance

Réponse en fréquence/impédance

Frequenzgang/Impedanz

Respuesta en frecuencia/Impedancia

• SM10IV/SM10IV-OAK

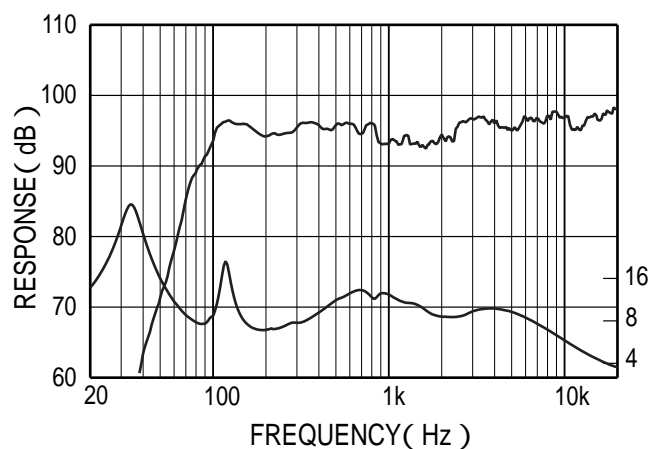

• S115IV/SM15IV/S115IVA-OAK/SM15IV-OAK

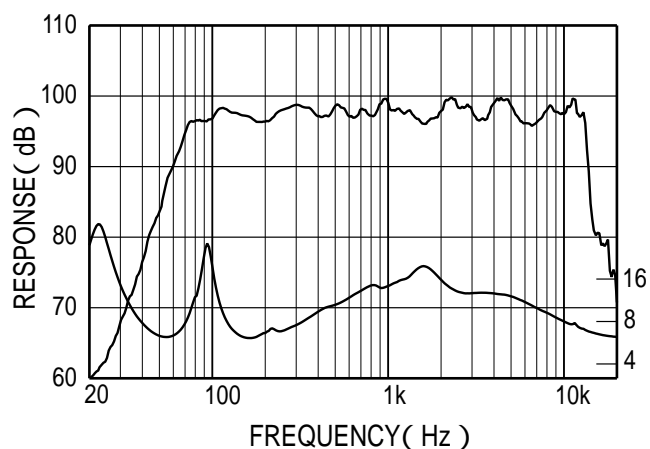

• S112IV/SM12IV/S112IV-OAK

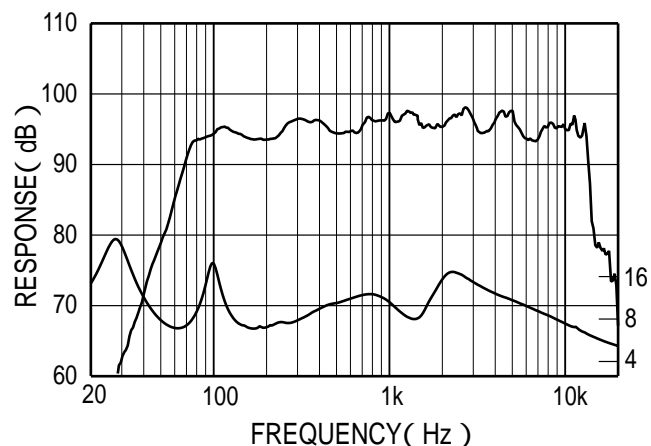

• SW118IV

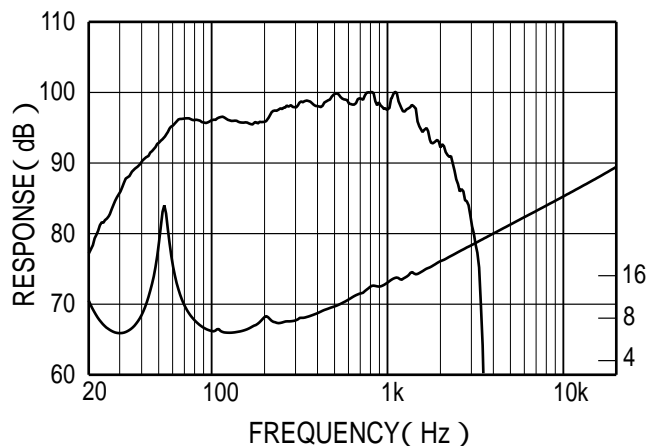

Additions

Horizontal Directivity / Directivité horizontale

Abstrahlung horizontal / Directividad horizontal

• SM10IV/SM10IV-OAK

- 500Hz ———
- 1kHz - - - - -
- 2kHz ———

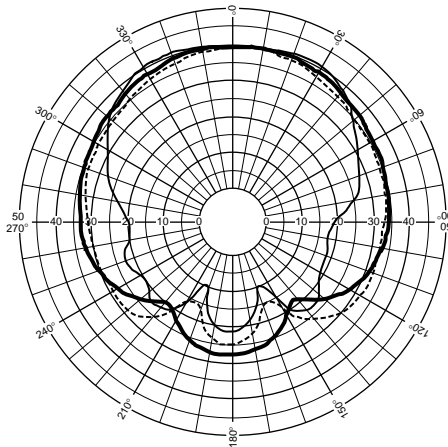

- 4kHz ———
- 8kHz - - - - -
- 16kHz ———

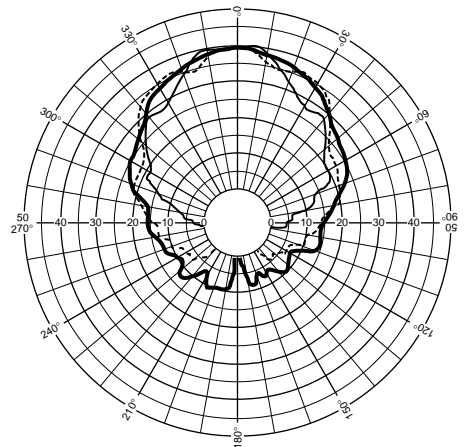

• S112IV/SM12IV/S112IV-OAK

- 500Hz ———
- 1kHz - - - - -
- 2kHz ———

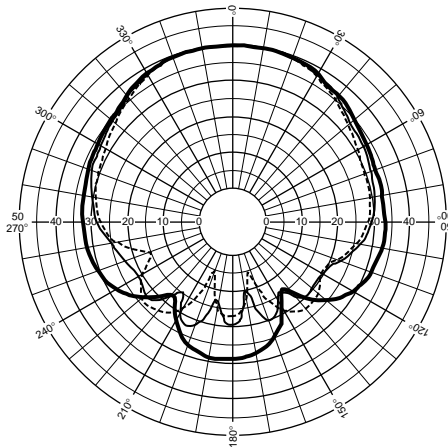

- 4kHz ———
- 8kHz - - - - -
- 16kHz ———

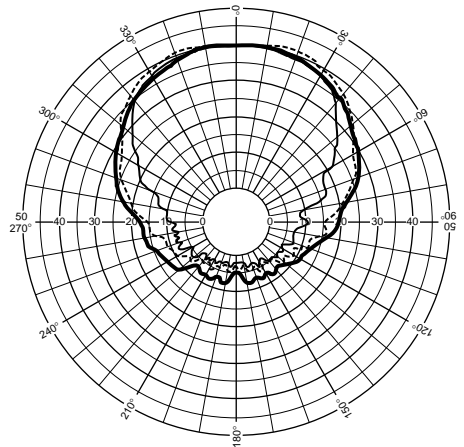

• S115IV/SM15IV/S115IVA-OAK/SM15IV-OAK

- 500Hz ———
- 1kHz - - - - -
- 2kHz ———

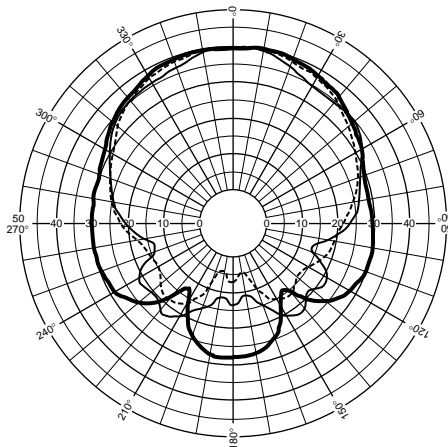

- 4kHz ———
- 8kHz - - - - -
- 16kHz ———

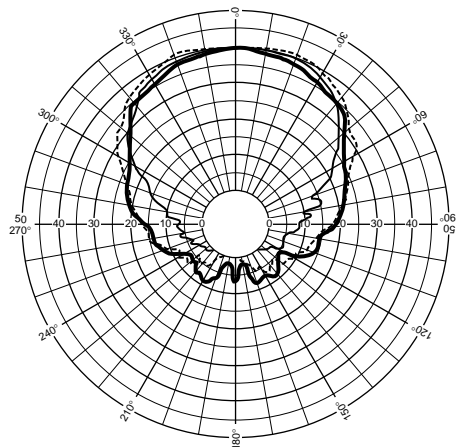

Vertical Directivity / Directivité verticale

Vertikale Richtcharakteristik / Directividad vertical

• SM10IV/SM10IV-OAK

- 500Hz ———
- 1kHz - - - - -
- 2kHz ———

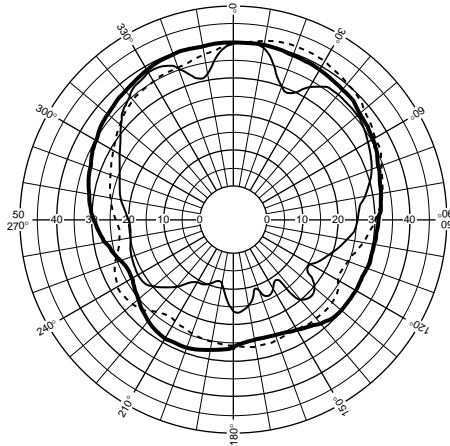

- 4kHz ———
- 8kHz - - - - -
- 16kHz ———

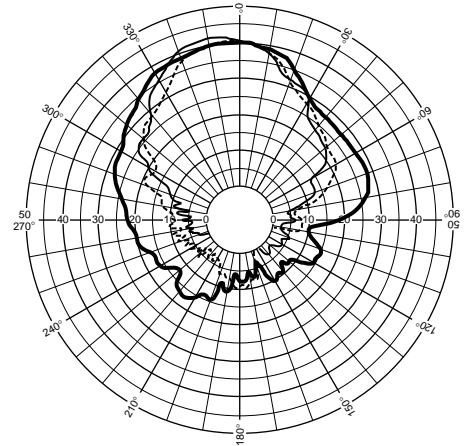

• S112IV/SM12IV/S112IV-OAK

- 500Hz ———
- 1kHz - - - - -
- 2kHz ———

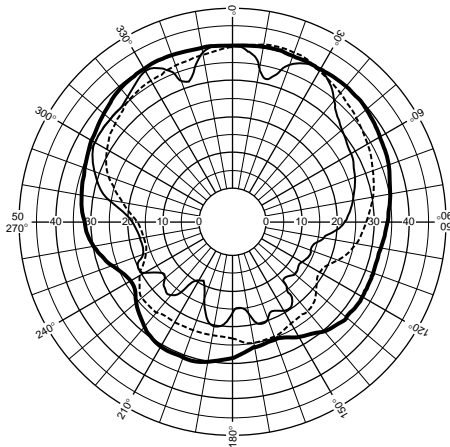

- 4kHz ———
- 8kHz - - - - -
- 16kHz ———

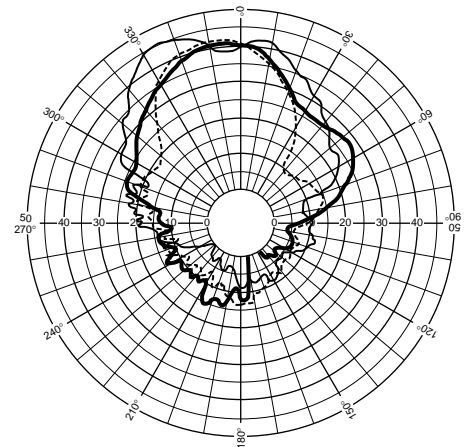

• S115IV/SM15IV/S115IVA-OAK/SM15IV-OAK

- 500Hz ———
- 1kHz - - - - -
- 2kHz ———

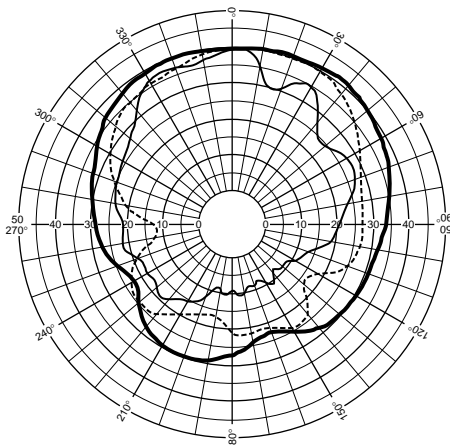

- 4kHz ———
- 8kHz - - - - -
- 16kHz ———

