



**WEIL-McLAIN**

# **CGa, CGi, CGs, EG, EGH, LGB, PEG, PFG Gas-Fired Boilers**

---

## **User's Information Manual**

### **INSTALLER:**

Please take time to review this User's Information Manual with the boiler owner. Explain all maintenance and service procedures and the correct Lighting or Operating Instructions.

### **⚠ WARNING**

If the information in this manual is not followed exactly, a fire or explosion may result, causing property damage, personal injury or loss of life.

Do not store or use **gasoline or other flammable vapors and liquids** in the vicinity of this or any other appliance.

### **WHAT TO DO IF YOU SMELL GAS**

- **Do not try to light any appliance.**
- **Do not touch any electrical switch; do not use any phone** in your building.
- **Immediately call your gas supplier from a neighbor's phone.** Follow the gas supplier's instructions.
- **If you cannot reach your gas supplier, call the fire department.**

Installation and service must be performed by a qualified installer, service technician or the gas supplier.



## Please read this page first

### How to use this manual . . .

To . . .	Read/use . . .	Pages . . .
<b>Learn precautions</b>	Warnings and definitions	<b>1, 2, and 3</b>
<b>Prevent air contamination</b>	Read list of air contaminants you must avoid. <b>If found, either remove products permanently or isolate boiler and provide outside combustion air.</b>	<b>3</b>
<b>Identify boiler components</b>	The illustration on page 4 or 5, will show you the location of the main components.	<b>4-5</b>
<b>Maintain boiler</b>	Set up a <b>plan for maintaining the boiler</b> using the schedule included in this manual. Schedule an <b>annual start-up</b> by a qualified service technician before every heating season.	<b>6-12</b>
<b>Start — or — Shutdown boiler</b>	Use the <b>Lighting/Operating instruction</b> sheet for the gas valve installed on your boiler. Ask your service technician if you are unsure which one.	<b>12-22</b>
<b>Troubleshoot common problems</b>	Use the common problems/solutions table to resolve typical heating system/boiler problems.	<b>23</b>

### Hazard definitions

The following defined terms are used throughout this manual to bring attention to the presence of hazards of various risk levels or to important information concerning the life of the product.



Indicates presence of hazards that **will cause severe** personal injury, death or substantial property damage.



Indicates presence of hazards that **can cause severe** personal injury, death or substantial property damage.



Indicates presence of hazards that **will or can cause minor** personal injury or property damage.



Indicates special instructions on installation, operation or maintenance that are important but not related to personal injury or property damage.

### Boiler service and maintenance



The Boiler manual is for use only by a qualified heating installer/service technician. Refer only to this User's Information Manual for your reference. Improper installation, adjustment, alteration, service or maintenance can cause property damage, personal injury (exposure to hazardous materials) or loss of life. Installation and service must be performed by a qualified installer, service agency or the gas supplier (who must read and follow the supplied instructions before installing, servicing, or removing this boiler. This boiler contains materials that have been identified as carcinogenic, or possibly carcinogenic, to humans).



# STOP!! – Read before proceeding



Failure to adhere to the guidelines on this page can result in severe personal injury, death or substantial property damage.



## Air contamination

- To prevent potential of severe personal injury or death, check for products or areas listed in table at right before installing boiler. If any of these contaminants are found:
- remove contaminants permanently. — OR —
- isolate boiler and provide outside combustion air. See national, provincial or local codes for further information. — OR —
- for CGs boilers only — combustion air may be ducted from outside to the boiler air intake.



## Service and maintenance

- To avoid electric shock, **disconnect electrical supply** before performing maintenance.
- To avoid severe burns, **allow boiler to cool** before performing maintenance.
- You must **maintain** the boiler as outlined in the manual and have the boiler **started up and serviced at least annually by a qualified service technician** to ensure boiler/system reliability.



## Boiler operation

- **Do not block flow of combustion or ventilation air** to boiler. This boiler is equipped with a control which will automatically shut down the boiler should air or vent be blocked. If vent or air blockage is easily accessible and removable, remove it. The boiler should attempt to restart within an hour. If blockage is not obvious or cannot be removed, have the boiler and system checked by a qualified service technician.
- Should **overheating occur or gas supply fail to shut off**, do not turn off or disconnect electrical supply to pump. Instead, **shut off the gas supply** at a location **external to the appliance**.
- **Do not use this boiler if any part has been under water.** Immediately call a qualified service technician to inspect the boiler and to replace any part of the control system and any gas control, which has been under water.
- **Have the building monitored when it is vacant** for an extended period. Safety controls can shut down the boiler at any time. The loss of heat can result in significant damage due to freezing.



## Boiler water

- **DO NOT** use **petroleum-based** cleaning or sealing compounds in boiler system. Water seal deterioration will occur, causing leakage between sections and damage to heating system components. This can result in substantial property damage.
- **DO NOT** use “**homemade cures**” or “**boiler patent medicines**”. Serious damage to boiler, personnel and/or property may result.
- Continual fresh **makeup water will reduce boiler life**. Mineral buildup in sections reduces heat transfer, overheats cast iron, and causes section failure. Addition of oxygen and other gases can cause internal corrosion. Leaks in boiler or piping must be repaired at once to prevent makeup water.
- **Do not add cold water to hot boiler.** Thermal shock can cause sections to crack.

Products to avoid
Spray cans containing chloro/fluorocarbons
Permanent wave solutions
Chlorinated waxes/cleaners
Chlorine-based swimming pool chemicals
Calcium chloride used for thawing
Sodium chloride used for water softening
Refrigerant leaks
Paint or varnish removers
Hydrochloric acid/muriatic acid
Cements and glues
Antistatic fabric softeners used in clothes dryers
Chlorine-type bleaches, detergents, and cleaning solvents found in household laundry rooms
Adhesives used to fasten building products and other similar products
Areas likely to have contaminants
Dry cleaning/laundry areas and establishments
Swimming pools
Metal fabrication plants
Beauty shops
Refrigeration repair shops
Photo processing plants
Auto body shops
Plastic manufacturing plants
Furniture refinishing areas and establishments
New building construction
Remodeling areas
Garages with workshops

## Boiler components

### CGa

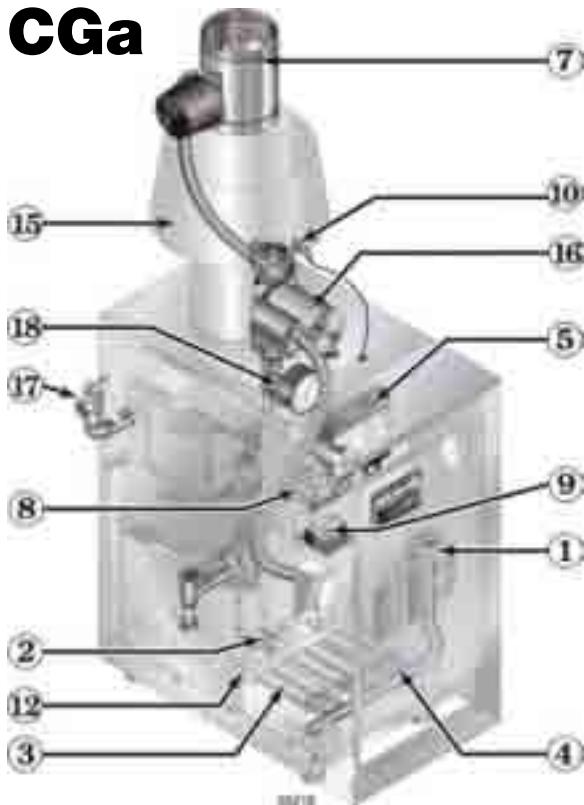

### CGi

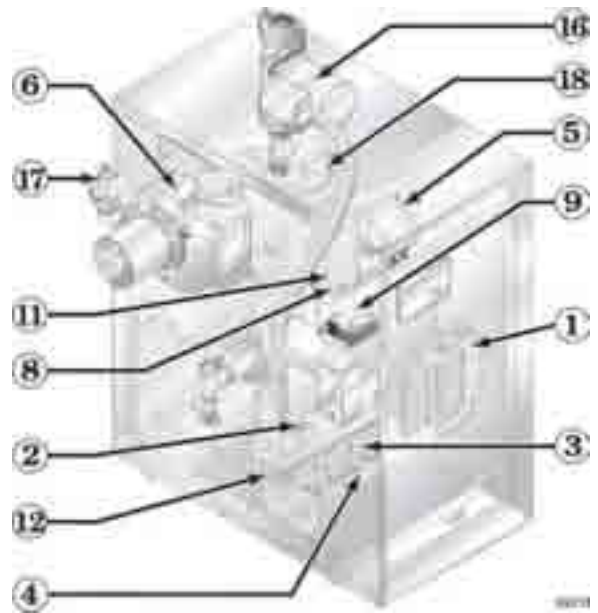

### CGs

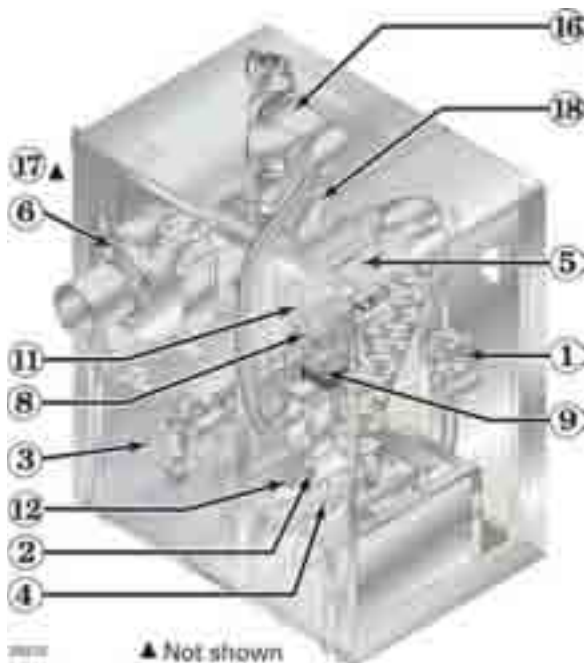

- 1 Gas valve
- 2 Pilot burner
- 3 Main burner
- 4 Gas manifold/orifices
- 5 Control module
- 6 Inducer (*CGi and CGs only*)
- 7 Vent damper (*CGa only*)
- 8 Water temperature limit switch
- 9 Transformer
- 10 Spill switch (*CGa only*)
- 11 Air pressure switch (*CGi and CGs only*)
- 12 Rollout thermal fuse element
- 15 Draft hood (*CGa only*)
- 16 Circulator
- 17 Relief valve
- 18 Gauge (*pressure or pressure/temperature*)



## EG/EGH

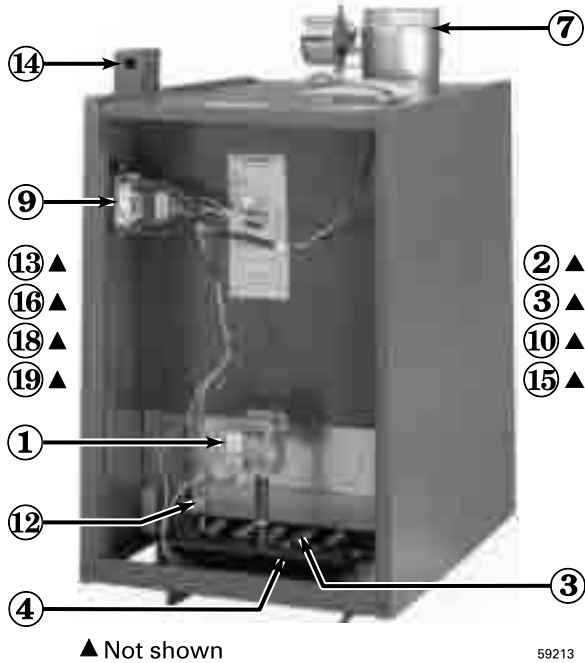

▲ Not shown

59213

## PFG

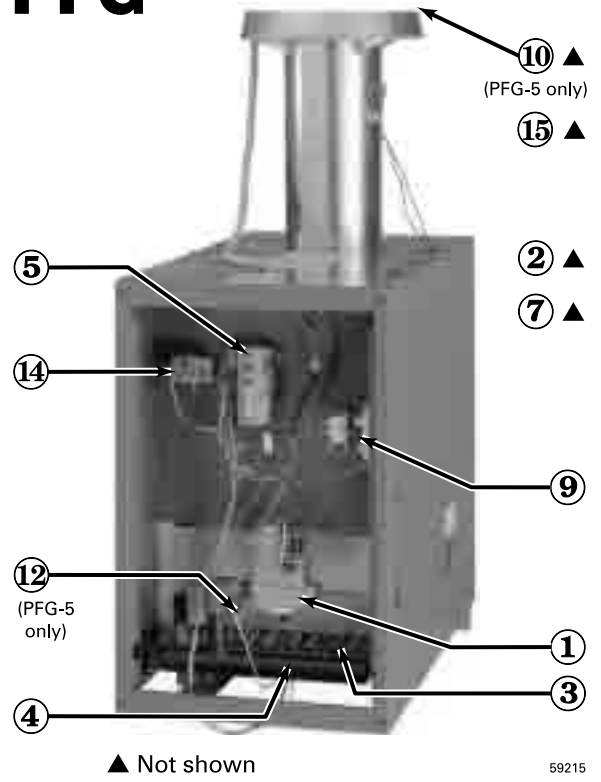

▲ Not shown

59215

- 1 Gas valve
- 2 Pilot burner
- 3 Main burner
- 4 Gas manifold/orifices
- 5 Control module
- 7 Vent damper
- 9 Transformer
- 10 Spill switch
- 12 Rollout thermal fuse element
- 13 Low water cutoff (*steam boilers*)
- 14 Limit control(s)
- 15 Draft hood
- 16 Circulator
- 18 Gauge (*pressure or pressure/temperature*)
- 19 Gauge glass (*steam only*)

## LGB

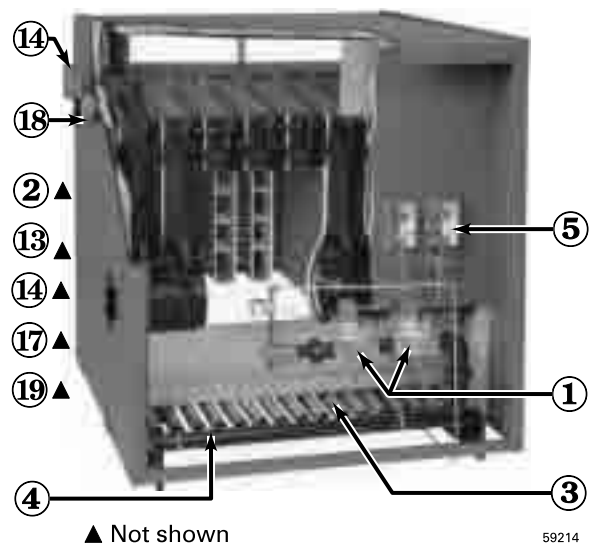

▲ Not shown

59214



## Maintain boiler using schedule below

<b>Service technician</b> (covered in Boiler Manual — for use only by a qualified service technician)		<b>Owner maintenance</b> (see following pages for instructions)	
<b>ANNUAL START-UP</b>	<b>Inspect:</b>	<b>Daily</b>	<ul style="list-style-type: none"> <li>• Check boiler area</li> <li>• Check air openings</li> <li>• Check boiler pressure/temperature gauge</li> </ul>
	<ul style="list-style-type: none"> <li>• Reported problems</li> <li>• Boiler area</li> <li>• Air openings</li> <li>• Flue gas vent system</li> <li>• Pilot and main burner flames</li> <li>• Water piping</li> <li>• Boiler heating surfaces</li> <li>• Burners, base and inlet air box</li> </ul>	<b>Monthly</b>	<ul style="list-style-type: none"> <li>• Check boiler interior piping</li> <li>• Check venting system</li> <li>• Check air vents</li> <li>• Check boiler relief valve</li> <li>• Check automatic air vents (if used)</li> </ul>
	<b>Service:</b>	<b>Periodically</b>	<ul style="list-style-type: none"> <li>• Test low water cutoff (if used)</li> </ul>
	<ul style="list-style-type: none"> <li>• Oiled-bearing circulators</li> </ul>	<b>Every 6 months</b>	<ul style="list-style-type: none"> <li>• Operate relief valve</li> </ul>
	<b>Start-up:</b>	<b>End of season</b>	<ul style="list-style-type: none"> <li>• Shut down procedure</li> </ul>
<ul style="list-style-type: none"> <li>• Perform start-up per manual</li> </ul>			
<b>Check/test:</b>			
<ul style="list-style-type: none"> <li>• Gas piping</li> <li>• Cold fill and operating pressures</li> <li>• Air vents and air elimination</li> <li>• Limit controls and cutoffs</li> <li>• Expansion tank</li> <li>• Boiler relief valve</li> </ul>			
<b>Review:</b>			
<ul style="list-style-type: none"> <li>• Review with owner</li> </ul>			

### Tankless water heater (EG and EGH only)

If boiler is used to supply domestic hot water, limit control should be set to supply adequate hot water. Weil-McLain tankless heaters are rated at 200 °F boiler water temperature. To get rated output, set low limit at 200 °F. Limit can be adjusted to meet system hot water

requirements. Differential can be set to 15 ° and adjusted to control level. Lowering the differential will cause a slight variation in water temperature but will decrease burner on-off cycling. High limit should be set at least 20 ° above low limit.

# User maintenance procedures

## Boiler must be serviced & maintained

**WARNING**

The boiler should be inspected and started annually, at the beginning of the heating season, only by a qualified service technician. In addition, the maintenance and care of the boiler designated on page 6 and explained on the following pages must be performed to assure maximum boiler efficiency and reliability. Failure to service and maintain the boiler and system could result in equipment failure, causing possible severe personal injury, death or substantial property damage.

**NOTICE**

The following information provides detailed instructions for completing the maintenance items listed in the maintenance schedule, page 6. In addition to this maintenance, the boiler must be serviced and started up at the beginning of each heating season by a qualified service technician.

## Component information

### Rollout thermal fuse element

**CGa, CGi, CGs, EG, EGH, PEG & PFG-5 only**

Cuts off gas flow should flame rollout occur. See **Figure 1**.

**WARNING**

Do not attempt to place boiler in operation if rollout thermal fuse element cuts off gas flow. Immediately call a service technician. Failure to do so can cause severe personal injury, death or substantial property damage.

**Figure 1**  
Rollout thermal fuse element

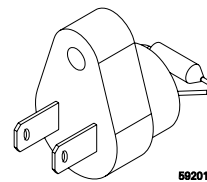

### Spill switch

**CGa, EG, EGH, PEG & PFG-5 only**

Cuts off gas flow should vent system become blocked. See **Figure 2**.

**WARNING**

Do not attempt to place boiler in operation if spill switch cuts off gas flow. Immediately call a service technician. Failure to do so can cause severe personal injury, death or substantial property damage.

**Figure 2**  
Spill switch

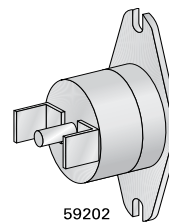

## Check daily . . . . . Boiler area

**WARNING**

To prevent potential of severe personal injury, death or substantial property damage, eliminate all materials discussed below from the boiler vicinity. If found:

- Remove products immediately from the area. If they have been there for an extended period, call a qualified service technician to inspect the boiler and vent system for possible damage from acid corrosion.
- If products cannot be removed, immediately call

a qualified service technician to install an outside combustion air source for the boiler (if not already installed).

1. Combustible/flammable materials — Do not store combustible materials, gasoline or any other flammable vapors or liquids near the boiler. Remove immediately if found.
2. Air contaminants — See listing of contaminants on page 3.





## ☐ Check daily . . . . .

### Pressure/temperature gauge or pressure gauge (steam)

1. Water boilers — Make sure the pressure reading on the boiler pressure/temperature gauge does not exceed 24 psig. Higher pressure may indicate a problem with the expansion tank or gauge.
2. Steam boilers — Make sure the pressure reading on the boiler pressure gauge does not exceed 15 psig. Higher pressure indicates a problem with the gauge or limit control.
3. Contact a qualified service technician if problem persists.

### Air openings

1. Verify that combustion and ventilation air openings to the boiler room and/or building are open and unobstructed.
2. **CGs boilers** — Verify that boiler vent discharge and air intake are clean and free of obstructions. Remove any debris on the air intake or flue exhaust openings.

## ☐ Check monthly . . . . .

### Boiler piping

1. Visually inspect for leaks around piping, circulators, relief valve and other fittings. Immediately call a qualified service technician to repair any leaks.



Have leaks fixed at once by a qualified service technician. Continual fresh makeup water will reduce boiler life. Minerals can build up in sections, reducing heat transfer, overheating cast iron, and causing section failure.



Do not use **petroleum-based cleaning or sealing compounds** in boiler system. Severe damage to boiler and system components can occur, resulting in possible severe personal injury, death or substantial property damage.

### Venting system



Failure to inspect the vent system as noted above and have them repaired by a qualified service technician can result in vent system failure, causing severe personal injury or death.

1. Visually inspect all parts of the flue gas venting system for any signs of blockage, leakage or joints or deterioration of the piping.
2. **CGa and EG boilers:**
  - a. With boiler firing, hold a candle or match below lower edge of draft hood “skirt.” If flame does not blow out, but burns undisturbed, the vent system is working properly.

If flame blows out or flickers severely, the vent system must be checked for obstructions or other causes of improper venting.

- b. Verify the vent damper (CGa and EG boilers) opens before burners ignite.
3. Notify your qualified service technician at once if you find any problem.

### Boiler relief valve . . . . .

1. Inspect the boiler relief valve (see **Figure 3**) and the relief valve discharge pipe for signs of weeping or leakage.
2. If the relief valve often weeps:
  - **water boilers** — the expansion tank may not be working properly.
  - **steam boilers** — limit control may be set too high or there may be system problems.
  - Immediately contact your qualified service technician to inspect the boiler and system.

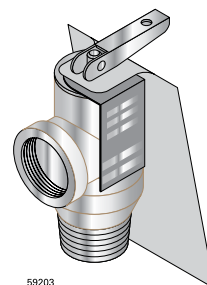

Figure 3 Relief valve



# Check monthly . . . . .

## Automatic air vents (if used)

1. See **Figure 4**.
2. Remove the cap from any automatic air vent in the system and check operation by depressing valve **B** slightly with the tip of a screwdriver.
3. If the air vent valve appears to be working freely and not leaking, replace cap **A**, twisting all the way on.
4. Loosen cap A one turn to allow vent to operate.
5. Have vent replaced if it does not operate correctly.

**Figure 4**  
Automatic air vent

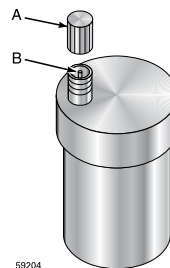

## Pilot burner flame

**Proper** pilot flame (see **Figure 5**):

1. Blue flame.
2. Inner cone engulfing thermocouple or thermopile (standing pilot) or pilot flame sensor (spark-ignited pilot).
3. Thermocouple or thermopile, or pilot flame sensor glowing cherry red.

**Improper** pilot flame:

1. Overfired — Large flame lifting or blowing past pilot flame sensor.
2. Underfired — Small flame. Inner cone not engulfing pilot flame sensor.
3. Lack of primary air — Yellow flame tip.
4. Incorrectly heated pilot flame sensor.

**Figure 5** Pilot burner and flame, typical

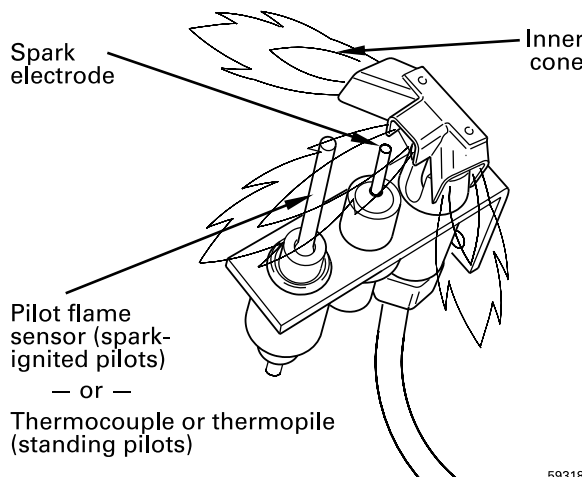

## Main burner flame

**Proper** main burner flame (see **Figure 6**):

1. Yellow-orange streaks may appear (caused by dust).

**Improper** main burner flame:

1. Overfired — Large flames.
2. Underfired — Small flames.
3. Lack of primary air — Yellow tipping on flames (sooting will occur).

**Figure 6** Main burner flame, typical

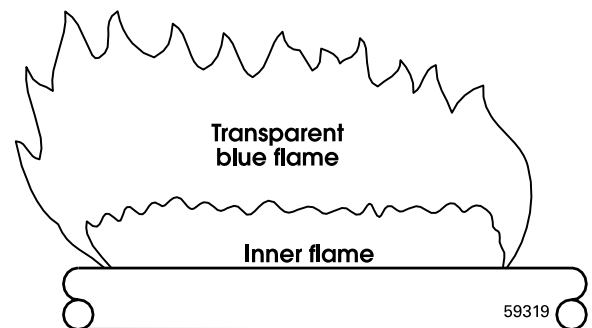

## Clean vent termination & air intake screens — CGs boilers only

1. Remove all lint and debris from both the boiler air intake screen and the flue discharge screen.

The boiler control module will sense blockage of the air intake or flue and lockout if the blockage is excessive. It will signal the failure by flashing the appropriate indicator lights on the control board.

2. If removing the debris does not allow the boiler to operate correctly afterwards, contact your qualified service technician to inspect the boiler and vent/air systems.

## Check condensate drain system

1. Inspect condensate drain fittings and tubing. Verify that condensate can flow freely to drain.

# ❑ **Service periodically . . . . .**

## **Test low water cutoff (all steam boilers) (water boilers, if installed)**

If the system is equipped with a low water cutoff, test the low water cutoff periodically during the heating season.

### **Float type — See Figure 7**

1. Clean float type low water cutoff to clear float chamber of sediment.
  - a. Open blowdown valve at bottom control.
  - b. Drain water into a bucket.

**⚠ DANGER**

Boiler pressure and temperature must be low to avoid the potential of severe burns from steam or hot water.

2. Check float type low water cutoff for proper operation.
  - a. Turn operating control to call for heat.
  - b. Before water gets hot, drain to bottom of gauge glass. Boiler should shut off after water level lowers a few inches.
  - c. Refill boiler to correct waterline. Boiler should come back on.

### **Probe type— See Figure 8**

1. Clean probe type low water cutoff for proper operation.
  - a. Turn off power to boiler and wait 5 minutes.
  - b. Drain water to bottom of gauge glass.
  - c. Turn on power.
  - d. Set thermostat to call for heat. Red neon lamp on lower water cutoff should light.
  - e. Wait 5 minutes. Boiler should not fire.
  - f. Refill boiler to correct water line. Red lamp should go off.
  - g. Wait 5 minutes. Boiler should fire.
  - h. Return thermostat to normal setting.

**Figure 7** Float type low water cutoff



**Figure 8** Probe type low water cutoff

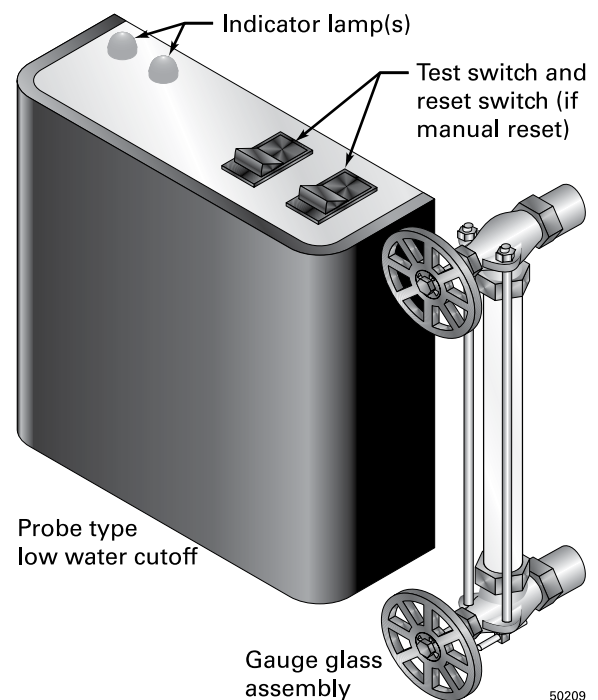

❑ **Service periodically** continued . . . . .

**Clean gauge glass**

Normal waterline on a steam boiler is halfway up gauge glass. See Figure 9. Clean when needed.

1. Close lower gauge cock.
2. Open pet cock.
3. Open lower gauge cock and allow a small amount of water to flush out through open pet cock.
4. Close pet cock.
5. Open lower gauge cock.



Boiler pressure must be low to eliminate potential of severe burns.

6. If gauge glass breaks, close both gauge cocks and call a qualified service technician to replace gauge glass. **Do not** replace with thin glass tubing.

**Figure 9** Gauge glass

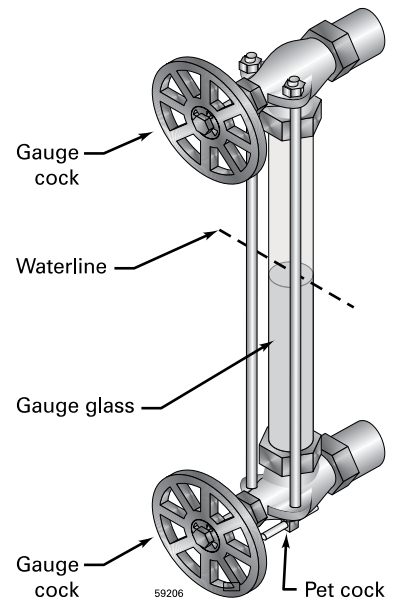

❑ **Service every 6 months** . . . . .

**Operate boiler relief valve**



To avoid water damage or scalding due to valve operation, a metal discharge line must be connected to relief valve outlet and run to a safe place of disposal. This discharge line must be installed by a qualified heating installer or service technician in accordance with the instructions in the **Boiler Manual**.

The discharge line must be terminated so as to eliminate possibility of severe burns should the valve discharge.

1. Before proceeding, verify that the relief valve outlet has been piped to a safe place of discharge, avoiding any possibility of scalding from hot water.
2. Read the boiler pressure/temperature gauge to make sure the system is pressurized.

3. Lift the relief valve top lever slightly, allowing water to relieve through the valve and discharge piping.
4. If water flows freely, release the lever and allow the valve to seat. Watch the end of the relief valve discharge pipe to ensure that the valve does not weep after the line has had time to drain. If the valve weeps, lift the seat again to attempt to clean the valve seat. If the valve continues to weep afterwards, contact your qualified service technician to inspect the valve and system.
5. If water does not flow from the valve when you lift the lever completely, the valve or discharge line may be blocked. Immediately shutdown the boiler, following the instructions on the inside jacket top Lighting Instructions. Call your qualified service technician to inspect the boiler and system.



# End-of-season shutdown . . . . .

## Follow boiler shutdown procedure

1. Follow “TOTURN OFF GASTO APPLIANCE” on the **Lighting/Operating instructions** on the inside of the jacket panel. You will also find these instructions on pages 13 through 22 of this manual.  
Use the **Lighting/Operating instruction** for the gas valve model installed on the boiler.
2. Do not drain system unless exposure to freezing temperatures will occur.
3. Do not drain the system if it is filled with an antifreeze solution.
4. Do not shut down boilers used for domestic water heating. They must operate year-round.

## Propane gas odorant



**Propane boilers only** — Your propane supplier mixes an odorant with the propane to make its presence detectable. In some instances, the odorant can fade and the gas may no longer have an odor.

- Propane gas can accumulate at floor level. Smell near the floor for the gas odorant or any unusual odor. If you suspect a leak, do not attempt to light the pilot.
- Use caution when attempting to light the propane pilot. This should be done by a qualified service technician, particularly if pilot outages are common.
- Periodically check the odorant level of your gas.
- Inspect boiler and system at least yearly to make sure all gas piping is leak-tight.
- Consult your propane supplier regarding installation of a gas leak detector. There are some products on the market intended for this purpose. Your supplier may be able to suggest an appropriate device.

# Lighting instructions

Use **Table 2** below to locate the correct Lighting/Operating instruction for the gas valve model installed on your boiler.

**Table 2**  
Lighting  
/Operating  
instruction  
guide

Standing pilot	Models	Page	Spark-ignited pilot	Models	Page
Honeywell VR8200/VR8300	CGa-25 – CGa-8 EG-30 – EG-65 PEG-30 – PEG-55	13	Honeywell VR8204/VR8304	CGa-25 – CGa-8 EG-30 – EG-75 PEG-30 – PEG-55 PFG-5	16
				CGi, CGs	21
			White-Rodgers 36E	CGa-25 – CGa-6 EG-30 – EG-50 PEG-30 – PEG-50	17
Robertshaw 7200	CGa-25 – CGa-6 EG-30 – EG-50 PEG-30 – PEG-50	14	White-Rodgers 36E	CGi CGs	21
Robertshaw 7000ERHC	EG-75 EGH-85, EGH-95 PFG-6, PFG-7	15	White-Rodgers 36C	CGa-7, CGa-8 EG-55 – EG-75 PEG-55, PFG-5	18
				CGi, CGs	21
			Robertshaw 7200	CGa-25 – CGa-6 EG-30 – EG-50 PEG-30 – PEG-50	19
			Robertshaw 7000 DERHC	EGH-85 – EGH-125 PFG-6 – PFG-8	20
--	--	--	LGB	22	



# Lighting instructions

## CGa, EG-30 to EG-65, PEG-30 to PEG-55

- **Standing pilot**
- Gas valve — **Honeywell VR8200/VR8300**

### FOR YOUR SAFETY READ BEFORE LIGHTING



If you do not follow these instructions exactly, a fire or explosion may result causing property damage, personal injury or loss of life.

- A. This appliance has a pilot, which must be lighted by hand. When lighting the pilot, follow these instructions exactly.
- B. **BEFORE LIGHTING**, smell all around the appliance area for gas. Be sure to smell next to the floor because some gas is heavier than air and will settle on the floor. See below.
- C. Use only your hand to push down the reset button or turn the gas control knob. Never use tools. If the knob or reset button will not operate by hand, don't try to repair it, call a qualified service technician. Force or attempted repair may result in a fire or explosion.
- D. Do not use this appliance if any part has been under water. Immediately call a qualified service technician to inspect the appliance and to replace any part of the control system and any gas control, which has been under water.

#### WHAT TO DO IF YOU SMELL GAS

- Do not try to light any appliance.
- Do not touch any electric switch; do not use any phone in your building.
- Immediately call your gas supplier from a neighbor's phone. Follow the gas supplier's instructions.
- If you cannot reach your gas supplier, call the fire department.

### LIGHTING INSTRUCTIONS

1. **STOP!** Read the safety information above on this label.
2. Set the thermostat to lowest setting.
3. Turn off all electrical power to the appliance.
4. Remove front panel.
5. Turn gas control knob clockwise ↻ to **"OFF"**.

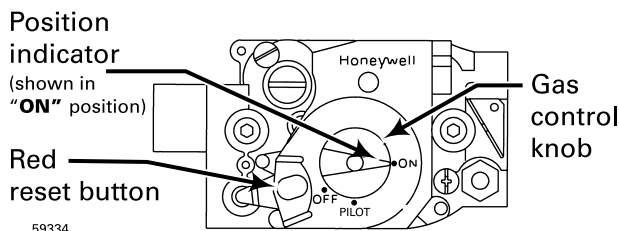

8. Find pilot - follow metal tube from gas control. The pilot is between two burners behind the access panel.
9. Turn gas control knob counterclockwise ↻ to **"PILOT"**.
10. Push in red reset button and hold. Immediately light the pilot with a match. Continue to hold reset button in for about one (1) minute after the pilot is lit.
11. Release reset button. Pilot should remain lit. If pilot goes out, repeat steps 6 through 13.
  - If reset button stays depressed after release, stop and immediately call your service technician or gas supplier.
  - If the pilot will not stay lit after several tries, turn the gas control knob clockwise ↻ to **"OFF"** and call your service technician or gas supplier.
12. Replace access panel.
13. Turn gas control knob counterclockwise ↻ to **"ON"**.
14. Turn on all electric power to the appliance.
15. Set thermostat to desired setting.
16. Replace front panel.

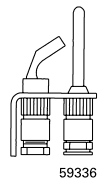

59336

59334

### TO TURN OFF GAS TO THE APPLIANCE

1. Set the thermostat to lowest setting.
2. Turn off all electric power to the appliance if service is to be performed.
3. Remove front panel.
4. Turn gas control knob clockwise ↻ to **"OFF"**.
5. Replace front panel.

550-223-038(0906)

# Lighting instructions

- **Standing pilot**
- Gas valve — **Robertshaw 7200**

# CGa-25 to CGa-6, EG-30 to EG-50, PEG-30 to PEG-50

## FOR YOUR SAFETY READ BEFORE LIGHTING



If you do not follow these instructions exactly, a fire or explosion may result causing property damage, personal injury or loss of life.

- |  |   |
|--|---|
| <p>A. This appliance has a pilot, which must be lighted by hand. When lighting the pilot, follow these instructions exactly.</p> <p>B. <b>BEFORE LIGHTING</b>, smell all around the appliance area for gas. Be sure to smell next to the floor because some gas is heavier than air and will settle on the floor. See below.</p> | <p>C. Use only your hand to depress the selector arm. Never use tools. If the selector arm will not move by hand, don't try to repair it, call a qualified service technician. Force or attempted repair may result in a fire or explosion.</p> <p>D. Do not use this appliance if any part has been under water. Immediately call a qualified service technician to inspect the appliance and to replace any part of the control system and any gas control, which has been under water.</p> |
|--|---|

### WHAT TO DO IF YOU SMELL GAS

- |  |   |
|--|---|
| <ul style="list-style-type: none"> <li>• Do not try to light any appliance.</li> <li>• Do not touch any electric switch; do not use any phone in your building.</li> </ul> | <ul style="list-style-type: none"> <li>• Immediately call your gas supplier from a neighbor's phone. Follow the gas supplier's instructions.</li> <li>• If you cannot reach your gas supplier, call the fire department.</li> </ul> |
|--|---|

## LIGHTING INSTRUCTIONS

- STOP!** Read the safety information above on this label.
- Set the thermostat to lowest setting.
- Turn off all electrical power to the appliance.
- Remove front panel.
- Depress and move selector arm left to **"OFF"**.  
Note: Selector arm cannot be moved to **"OFF"** unless selector arm is depressed slightly. Do not force.

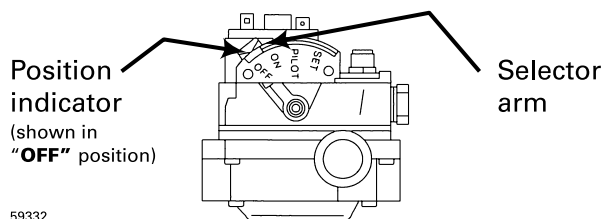

- Wait five (5) minutes to clear out any gas. Then smell for gas, including near the floor. If you smell gas, **STOP!** Follow **"B"** in the safety information above. If you don't smell gas, go to the next step.
- Remove access panel located above burners.

- Find pilot - follow metal tube from gas control. The pilot is between two burners behind the access panel.
- Move selector arm on gas control right to **"SET"** position.
- Hold selector arm in **"SET"** position and immediately light the pilot with a match. Continue to hold selector arm to **"SET"** for about one-half (1/2) minute after the pilot is lit.
- Release selector arm. If pilot does not remain lit, repeat steps 6 through 13.
  - If the pilot will not stay lit after several tries, move selector arm left to **"OFF"** and call your service technician or gas supplier.
- Replace access panel.
- Turn selector arm left to **"ON"**.
- Turn on all electric power to the appliance.
- Set thermostat to desired setting.
- Replace front panel.

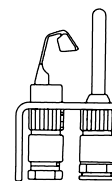

59337

## TO TURN OFF GAS TO THE APPLIANCE

- Set the thermostat to lowest setting.
- Turn off all electric power to the appliance if service is to be performed.
- Remove front panel.
- Depress and move selector arm left to **"OFF"**. Do not force.
- Replace front panel.

550-223-039(0906)





# Lighting instructions

## EG-75, EGH-85, EGH-95, PFG-6, PFG-7

- **Standing pilot**
- Gas valve — **Robertshaw 7000ERHC**

### FOR YOUR SAFETY READ BEFORE LIGHTING



If you do not follow these instructions exactly, a fire or explosion may result causing property damage, personal injury or loss of life.

- A. This appliance has a pilot, which must be lighted by hand. When lighting the pilot, follow these instructions exactly.
- B. **BEFORE LIGHTING**, smell all around the appliance area for gas. Be sure to smell next to the floor because some gas is heavier than air and will settle on the floor. See below.
- C. Use only your hand to depress or turn the gas control knob. Never use tools. If the selector arm will not depress or move by hand, don't try to repair it, call a qualified service technician. Force or attempted repair may result in a fire or explosion.
- D. Do not use this appliance if any part has been under water. Immediately call a qualified service technician to inspect the appliance and to replace any part of the control system and any gas control, which has been under water.

#### WHAT TO DO IF YOU SMELL GAS

- Do not try to light any appliance.
- Do not touch any electric switch; do not use any phone in your building.
- Immediately call your gas supplier from a neighbor's phone. Follow the gas supplier's instructions.
- If you cannot reach your gas supplier, call the fire department.

### LIGHTING INSTRUCTIONS

- STOP!** Read the safety information above on this label.
- Set the thermostat to lowest setting.
- Turn off all electrical power to the appliance.
- Remove front panel.
- Depress gas control knob slightly and turn clockwise ↻ to **"OFF"**. **Note:** Gas control knob cannot be turned to **"OFF"** unless knob is depressed slightly. Do not force.
- Wait five (5) minutes to clear out any gas. Then smell for gas, including near the floor. If you smell gas, **STOP!** Follow **"B"** in the safety information above. If you don't smell gas, go to the next step.
- Remove access panel located above burners.
- Find pilot — follow metal tube from gas control. The pilot is between two burners behind the access panel.
- Turn gas control knob counterclockwise ↶ to **"PILOT"**.
- Depress gas control knob and hold. Immediately light the pilot with a match. Continue to hold gas control knob in for about one (1) minute after the pilot is lit.
  - If pilot can be lit without depressing gas control knob, turn gas knob clockwise ↷ to **"OFF"** and call your service technician or gas supplier.
- Release gas control knob. Pilot should remain lit. If pilot goes out, repeat steps 5 through 11.
  - If gas control knob stays depressed after release, stop and immediately call your service technician or gas supplier.
  - If the pilot will not stay lit after several tries, turn the gas control knob clockwise ↷ to **"OFF"** and call your service technician or gas supplier.
- Replace access panel.
- Turn gas control knob counterclockwise ↶ to **"ON"**.
- Turn on all electric power to the appliance.
- Set thermostat to desired setting.
- Replace front panel.

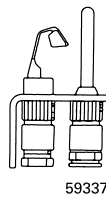
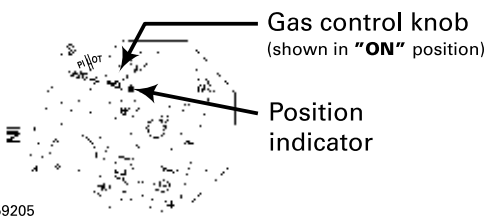

### TO TURN OFF GAS TO THE APPLIANCE

- Set the thermostat to lowest setting.
- Turn off all electric power to the appliance if service is to be performed.
- Remove front panel.
- Depress gas control knob slightly and turn clockwise ↷ to **"OFF"**.
- Replace front panel.

550-223-081(0706)



# Operating instructions

- **Spark-ignited pilot**
- Gas valve — **Honeywell VR8204/VR8304**

## CGa, EG-30 to EG-75, PEG-30 to PEG-55, PFG-5

### FOR YOUR SAFETY READ BEFORE OPERATING

**WARNING**

If you do not follow these instructions exactly, a fire or explosion may result causing property damage, personal injury or loss of life.

- |   |  |
|---|--|
| <p>A. This appliance is equipped with an ignition device which automatically lights the pilot. <b>Do not</b> try to light the pilot by hand.</p> <p>B. <b>BEFORE OPERATING</b>, smell all around the appliance area for gas. Be sure to smell next to the floor because some gas is heavier than air and will settle on the floor. See below.</p> | <p>C. Use only your hand to turn the gas control knob. Never use tools. If the knob will not turn by hand, don't try to repair it, call a qualified service technician. Force or attempted repair may result in a fire or explosion.</p> <p>D. Do not use this appliance if any part has been under water. Immediately call a qualified service technician to inspect the appliance and to replace any part of the control system and any gas control, which has been under water.</p> |
|---|--|

#### WHAT TO DO IF YOU SMELL GAS

- Do not try to light any appliance.
- Do not touch any electric switch; do not use any phone in your building.
- Immediately call your gas supplier from a neighbor's phone. Follow the gas supplier's instructions.
- If you cannot reach your gas supplier, call the fire department.

### OPERATING INSTRUCTIONS

1. **STOP!** Read the safety information above on this label.
2. Set the thermostat to lowest setting.
3. Turn off all electrical power to the appliance.
4. Remove from panel.
5. This appliance is equipped with an ignition device which automatically lights the pilot. **Do not** try to light the pilot by hand.
6. Turn gas control knob clockwise ↻ to **"OFF"**.
7. Wait five (5) minutes to clear out any gas. Then smell for gas, including near the floor. If you smell gas, **STOP!** Follow **"B"** in the safety information above. If you don't smell gas, go to the next step.
8. Turn gas control knob counterclockwise ↺ to **"ON"**.
9. Turn on all electric power to the appliance.
10. Set thermostat to desired setting.
11. If the appliance will not operate, follow the instructions **To Turn Off Gas To The Appliance** and call your service technician or gas supplier.
12. Replace front panel.

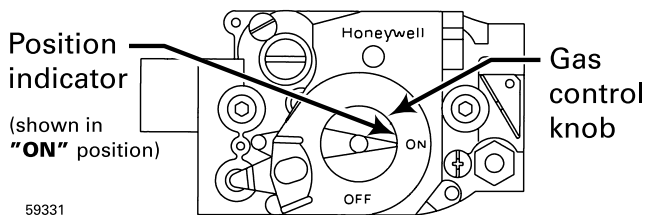

### TO TURN OFF GAS TO THE APPLIANCE

1. Set the thermostat to lowest setting.
2. Turn off all electric power to the appliance if service is to be performed.
3. Remove front panel.
4. Turn gas control knob clockwise ↻ to **"OFF"**. Do not force.
5. Replace front panel.

550-223-041(0906)



# Operating instructions

- **Spark-ignited pilot**
- Gas valve – **White-Rodgers 36E**

## CGa-25 to CGa-6, EG-30 to EG-50, PEG-30 to PEG-50

### FOR YOUR SAFETY READ BEFORE OPERATING



If you do not follow these instructions exactly, a fire or explosion may result causing property damage, personal injury or loss of life.

- |   |  |
|---|--|
| <p>A. This appliance is equipped with an ignition device which automatically lights the pilot. <b>Do not</b> try to light the pilot by hand.</p> <p>B. <b>BEFORE OPERATING</b>, smell all around the appliance area for gas. Be sure to smell next to the floor because some gas is heavier than air and will settle on the floor. See below.</p> | <p>C. Use only your hand to turn the gas control knob. Never use tools. If the knob will not turn by hand, don't try to repair it, call a qualified service technician. Force or attempted repair may result in a fire or explosion.</p> <p>D. Do not use this appliance if any part has been under water. Immediately call a qualified service technician to inspect the appliance and to replace any part of the control system and any gas control, which has been under water.</p> |
|---|--|

#### WHAT TO DO IF YOU SMELL GAS

- Do not try to light any appliance.
- Do not touch any electric switch; do not use any phone in your building.
- Immediately call your gas supplier from a neighbor's phone. Follow the gas supplier's instructions.
- If you cannot reach your gas supplier, call the fire department.

### OPERATING INSTRUCTIONS

- |  |   |
|--|---|
| <ol style="list-style-type: none"> <li>1. <b>STOP!</b> Read the safety information above on this label.</li> <li>2. Set the thermostat to lowest setting.</li> <li>3. Turn off all electrical power to the appliance.</li> <li>4. Remove front panel.</li> <li>5. This appliance is equipped with an ignition device which automatically lights the pilot. <b>Do not</b> try to light the pilot by hand.</li> <li>6. Turn gas control knob clockwise ↻ to <b>"OFF"</b>.</li> </ol> | <ol style="list-style-type: none"> <li>7. Wait five (5) minutes to clear out any gas. Then smell for gas, including near the floor. If you smell gas, <b>STOP!</b> Follow <b>"B"</b> in the safety information above. If you don't smell gas, go to the next step.</li> <li>8. Turn gas control knob counterclockwise ↺ to <b>"ON"</b>.</li> <li>9. Turn on all electric power to the appliance.</li> <li>10. Set thermostat to desired setting.</li> <li>11. If the appliance will not operate, follow the instructions <b>To Turn Off Gas To The Appliance</b> and call your service technician or gas supplier.</li> <li>12. Replace front panel.</li> </ol> |
|--|---|

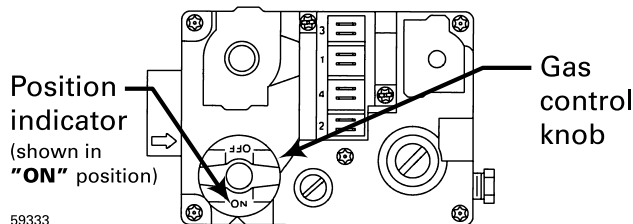

### TO TURN OFF GAS TO THE APPLIANCE

- |  |  |
|--|--|
| <ol style="list-style-type: none"> <li>1. Set the thermostat to lowest setting.</li> <li>2. Turn off all electric power to the appliance if service is to be performed.</li> </ol> | <ol style="list-style-type: none"> <li>3. Remove front panel.</li> <li>4. Turn gas control knob clockwise ↻ to <b>"OFF"</b>. Do not force.</li> <li>5. Replace front panel.</li> </ol> |
|--|--|

550-223-042(0906)



# Operating instructions

- **Spark-ignited pilot**
- Gas valve — **White-Rodgers 36C**

## CGa-7, CGa-8, EG-55 to EG-75, PEG-55, PFG-5

### FOR YOUR SAFETY READ BEFORE OPERATING



If you do not follow these instructions exactly, a fire or explosion may result causing property damage, personal injury or loss of life.

- A. This appliance is equipped with an ignition device which automatically lights the pilot. **Do not** try to light the pilot by hand.
- B. **BEFORE OPERATING**, smell all around the appliance area for gas. Be sure to smell next to the floor because some gas is heavier than air and will settle on the floor. See below.
- C. Use only your hand to depress or turn the gas control knob. Never use tools. If the knob will not depress or turn by hand, don't try to repair it, call a qualified service technician. Force or attempted repair may result in a fire or explosion.
- D. Do not use this appliance if any part has been under water. Immediately call a qualified service technician to inspect the appliance and to replace any part of the control system and any gas control, which has been under water.

#### WHAT TO DO IF YOU SMELL GAS

- Do not try to light any appliance.
- Do not touch any electric switch; do not use any phone in your building.
- Immediately call your gas supplier from a neighbor's phone. Follow the gas supplier's instructions.
- If you cannot reach your gas supplier, call the fire department.

### OPERATING INSTRUCTIONS

1. **STOP!** Read the safety information above on this label.
2. Set the thermostat to lowest setting.
3. Turn off all electrical power to the appliance.
4. Remove front panel.
5. This appliance is equipped with an ignition device which automatically lights the pilot. **Do not** try to light the pilot by hand.
6. Depress gas control knob slightly and turn clockwise ↻ to **"OFF"**. **Note:** Knob cannot be turned to **"OFF"** unless knob is depressed slightly. Do not force.
7. Wait five (5) minutes to clear out any gas. Then smell for gas, including near the floor. If you smell gas, **STOP!** Follow **"B"** in the safety information above. If you don't smell gas, go to the next step.
8. Turn gas control knob counterclockwise ↺ to **"ON"**.
9. Turn on all electric power to the appliance.
10. Set thermostat to desired setting.
11. If the appliance will not operate, follow the instructions **To Turn Off Gas To The Appliance** and call your service technician or gas supplier.
12. Replace front panel.

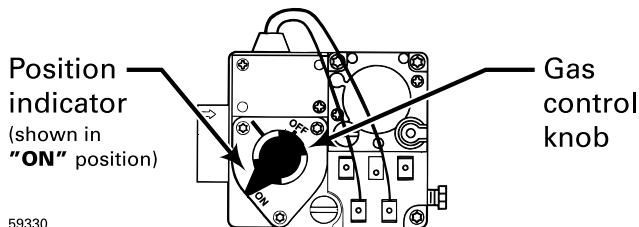

### TO TURN OFF GAS TO THE APPLIANCE

1. Set the thermostat to lowest setting.
2. Turn off all electric power to the appliance if service is to be performed.
3. Remove front panel.
4. Depress gas control knob slightly and turn clockwise ↻ to **"OFF"**. Do not force.
5. Replace front panel.

550-223-043(0906)



# Operating instructions

- **Spark-ignited pilot**
- Gas valve — **Robertshaw 7200**

## CGa-25 to CGa-6, EG-30 to EG-50, PEG-30 to PEG-50

### FOR YOUR SAFETY READ BEFORE OPERATING



If you do not follow these instructions exactly, a fire or explosion may result causing property damage, personal injury or loss of life.

- |   |  |
|---|--|
| <p>A. This appliance is equipped with an ignition device which automatically lights the pilot. <b>Do not</b> try to light the pilot by hand.</p> <p>B. <b>BEFORE OPERATING</b>, smell all around the appliance area for gas. Be sure to smell next to the floor because some gas is heavier than air and will settle on the floor. See below.</p> | <p>C. Use only your hand to depress or move the selector arm. Never use tools. If the selector arm will not depress or move by hand, don't try to repair it, call a qualified service technician. Force or attempted repair may result in a fire or explosion.</p> <p>D. Do not use this appliance if any part has been under water. Immediately call a qualified service technician to inspect the appliance and to replace any part of the control system and any gas control, which has been under water.</p> |
|---|--|

#### WHAT TO DO IF YOU SMELL GAS

- Do not try to light any appliance.
- Do not touch any electric switch; do not use any phone in your building.
- Immediately call your gas supplier from a neighbor's phone. Follow the gas supplier's instructions.
- If you cannot reach your gas supplier, call the fire department.

### OPERATING INSTRUCTIONS

- |  |   |
|--|---|
| <ol style="list-style-type: none"> <li><b>STOP!</b> Read the safety information above on this label.</li> <li>Set the thermostat to lowest setting.</li> <li>Turn off all electrical power to the appliance.</li> <li>Remove front panel.</li> <li>This appliance is equipped with an ignition device which automatically lights the pilot. <b>Do not</b> try to light the pilot by hand.</li> <li>Depress and move selector arm left ↶ to <b>"OFF"</b>. <b>Note:</b> Selector arm cannot be moved to <b>"OFF"</b> unless selector arm is depressed slightly. Do not force.</li> </ol> | <ol style="list-style-type: none"> <li>Wait five (5) minutes to clear out any gas. Then smell for gas, including near the floor. If you smell gas, <b>STOP!</b> Follow <b>"B"</b> in the safety information above. If you don't smell gas, go to the next step.</li> <li>Move selector arm right ↷ to <b>"ON"</b>.</li> <li>Turn on all electric power to the appliance.</li> <li>Set thermostat to desired setting.</li> <li>If the appliance will not operate, follow the instructions <b>"To Turn Off Gas To The Appliance"</b> and call your service technician or gas supplier.</li> <li>Replace front panel.</li> </ol> |
|--|---|

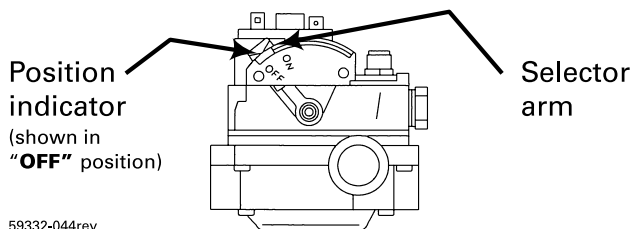

### TO TURN OFF GAS TO THE APPLIANCE

- |  |   |
|--|---|
| <ol style="list-style-type: none"> <li>Set the thermostat to lowest setting.</li> <li>Turn off all electric power to the appliance if service is to be performed.</li> </ol> | <ol style="list-style-type: none"> <li>Remove front panel.</li> <li>Depress and move selector arm to <b>"OFF"</b>. Do not force.</li> <li>Replace front panel.</li> </ol> |
|--|---|

550-223-044(0906)



# Operating instructions

## EGH-85 to EGH-125, PFG-6 to PFG-8

- **Spark-ignited pilot**
- Gas valve – **Robertshaw 7000DERHC**

### FOR YOUR SAFETY READ BEFORE OPERATING



If you do not follow these instructions exactly, a fire or explosion may result causing property damage, personal injury or loss of life.

- A. This appliance is equipped with an ignition device which automatically lights the pilot. **Do not** try to light the pilot by hand.
- B. **BEFORE OPERATING**, smell all around the appliance area for gas. Be sure to smell next to the floor because some gas is heavier than air and will settle on the floor. See below.
- C. Use only your hand to turn the gas control knob. Never use tools. If the selector arm will not depress or move by hand, don't try to repair it, call a qualified service technician. Force or attempted repair may result in a fire or explosion.
- D. Do not use this appliance if any part has been under water. Immediately call a qualified service technician to inspect the appliance and to replace any part of the control system and any gas control, which has been under water.

#### WHAT TO DO IF YOU SMELL GAS

- Do not try to light any appliance.
- Do not touch any electric switch; do not use any phone in your building.
- Immediately call your gas supplier from a neighbor's phone. Follow the gas supplier's instructions.
- If you cannot reach your gas supplier, call the fire department.

### OPERATING INSTRUCTIONS

1. **STOP!** Read the safety information above on this label.
2. Set the thermostat to lowest setting.
3. When equipped with **Effikal** vent damper **Model RVGP**, place service switch in **Hold Damper Open** position.
4. Turn off all electrical power to the appliance.
5. Remove front panel.
6. When equipped with **Johnson Controls** vent damper **Model M35**, manually rotate damper blade in direction of arrow to **"OPEN"** position indicated on damper assembly.
7. Turn gas control knob clockwise ↻ to **"OFF"**.
8. When equipped with vent damper, verify damper blade is in full open position.
9. Wait five (5) minutes to clear out any gas. Then smell for gas, including near the floor. If you smell gas, **STOP!** Follow **"B"** in the safety information above. If you don't smell gas, go to the next step.
10. Turn gas control knob counterclockwise ↺ to **"ON"**.
11. Turn on all electric power to the appliance.
12. When equipped with **Effikal** vent damper, place service switch in **Automatic Operation** position.
13. Set thermostat to desired setting.
14. If the appliance will not operate, follow the instructions **"TO TURN OFF GAS TO APPLIANCE"** below and call your service technician or gas supplier.
15. Replace front panel.

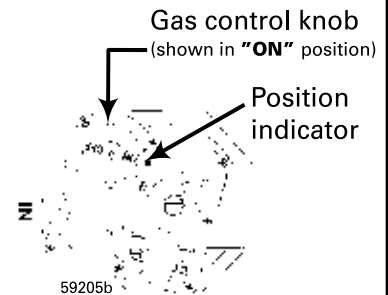

### TO TURN OFF GAS TO THE APPLIANCE

1. Set the thermostat to lowest setting.
2. Turn off all electric power to the appliance if service is to be performed.
3. Remove front panel.
4. Turn gas control knob clockwise ↻ to **"OFF"**.
5. Replace front panel.

550-223-045(1101)



# Operating instructions

# CGI, CGs

- **Spark-ignited pilot**
- Gas valve – **Honeywell VR8204/VR8304, White-Rodgers 36C and 36E**

## FOR YOUR SAFETY READ BEFORE OPERATING



If you do not follow these instructions exactly, a fire or explosion may result causing property damage, personal injury or loss of life.

- A. This appliance does not have a pilot. It is equipped with an ignition device which automatically lights the burner. **Do not** try to light the burner by hand.
- B. **BEFORE OPERATING**, smell all around the appliance area for gas. Be sure to smell next to the floor because some gas is heavier than air and will settle on the floor. See below.
- C. Use only your hand to turn the gas control knob. Never use tools. If the knob will not turn by hand, don't try to repair it, call a qualified service technician. Force or attempted repair may result in a fire or explosion.
- D. Do not use this appliance if any part has been under water. Immediately call a qualified service technician to inspect the appliance and to replace any part of the control system and any gas control, which has been under water.

### WHAT TO DO IF YOU SMELL GAS

- Do not try to light any appliance.
- Do not touch any electric switch; do not use any phone in your building.
- Immediately call your gas supplier from a neighbor's phone. Follow the gas supplier's instructions.
- If you cannot reach your gas supplier, call the fire department.

## OPERATING INSTRUCTIONS

1. **STOP !** Read the safety information above on this label.
2. Set the thermostat to lowest setting.
3. Turn off all electrical power to the appliance.
4. Remove jacket front panel.
5. This appliance is equipped with an ignition device which automatically lights the burner. Do not try to light the burner by hand.
6. Turn **Gas control knob** clockwise ↻ to **"OFF"**.
7. Wait five (5) minutes to clear out any gas. Then smell for gas, including near the floor. If you smell gas, **STOP !** Follow **"B"** in the safety information above. If you don't smell gas, go to the next step.
8. Turn **Gas control knob** counterclockwise ↺ to **"ON"**.
9. Turn on all electric power to the appliance.
10. Set thermostat to desired setting.
11. If the appliance will not operate, follow the instructions **"TO TURN OFF GAS TO APPLIANCE"** below and call your service technician or gas supplier.
12. Replace jacket front panel.

26070

White-Rodgers 36C Gas valve

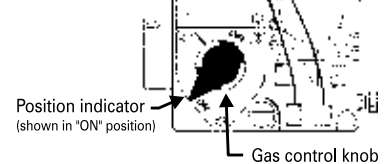

White-Rodgers 36E Gas valve

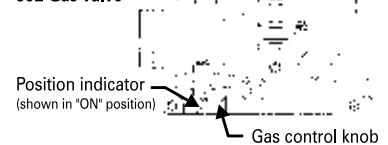

Honeywell VR8204 or VR8304 Gas valve

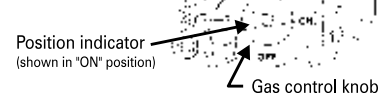

## TO TURN OFF GAS TO THE APPLIANCE

1. Set the thermostat to lowest setting.
2. Turn off all electric power to the appliance if service is to be performed.
3. Remove jacket front panel.
4. Turn **Gas control knob** clockwise ↻ to **"OFF"**. Do not force.
5. Replace jacket front panel.



# Operating instructions

# LGB

## • Spark-ignited pilot

### FOR YOUR SAFETY READ BEFORE OPERATING



If you do not follow these instructions exactly, a fire or explosion may result causing property damage, personal injury or loss of life.

- A. This appliance is equipped with an ignition device which automatically lights the pilot. Do not try to light the automatic pilot by hand.  
For PROPANE BOILERS ONLY: Propane boilers contain both an automatic pilot and a manual (standing) pilot. A pilot switch box controls gas flow to the manual pilot. Follow instructions below to manually light the manual pilot. Do not try to light the automatic pilot by hand.
- B. **BEFORE OPERATING**, smell all around the appliance area for gas. Be sure to smell next to the floor because some gas is heavier than air and will settle on the floor. See below.
- C. Use only your hand to depress or turn gas valve handles. Never use tools. If a handle will not turn by hand, don't try to repair it. Call a qualified service technician. Force or attempted repair may result in a fire or explosion.
- D. Do not use this appliance if any part has been under water. Immediately call a qualified service technician to inspect the appliance and to replace any part of the control system and any gas control, which has been under water.

### WHAT TO DO IF YOU SMELL GAS

- Do not try to light any appliance.
- Do not touch any electric switch; do not use any phone in your building.
- Immediately call your gas supplier from a neighbor's phone. Follow the gas supplier's instructions.
- If you cannot reach your gas supplier, call the fire department.

### OPERATING INSTRUCTIONS

1. **STOP!** Read the safety information above this label.
2. Set the thermostat/operating control to the lowest setting.
3. Turn off all electrical power to the appliance.
4. Remove jacket front panel. On PROPANE BOILERS ONLY: Remove base access shield.
5. Close gas hand valve, **b**. Close manual test firing valve, **c**. Close all pilot shutoff valve(s), **g**.
6. Wait five (5) minutes to clear out any gas. Then smell for gas, including near the floor. If you smell gas, STOP! Follow **B** in the safety information above. If you do not smell gas, go to step 7.
7. Open pilot shutoff valve(s), **g**.
8. On PROPANE BOILERS ONLY:
  - Press and hold reset lever of pilot switch box, **d**.
  - Manually light manual pilot, **e**, while holding the lever down.
  - Allow time for air to purge from the pilot line. Release lever after pilot flame has had time to heat thermocouple (about 1 minute). Pilot burner should remain lit.
9. Open manual test firing valve, **c**, and gas hand valve, **b**. Follow sequence below.
10. Turn on electric power to the appliance.
11. Set the thermostat/operating control to desired setting.
12. If boiler does not operate correctly, follow instructions under, "TO TURN OFF GAS TO APPLIANCE," below. Call your service technician or gas supplier.
13. On PROPANE BOILERS ONLY: Replace base access shield.
14. Replace jacket front panel.

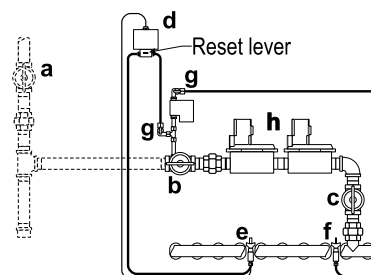

Typical gas piping only — See Control Supplement for details

- a service valve
- b gas hand valve
- c manual test firing valve
- d pilot switch box (propane only)
- e manual pilot (propane only)
- f automatic pilot
- g pilot shutoff valve(s)
- h automatic gas valves, typical

### TO TURN OFF GAS TO THE APPLIANCE

1. Set thermostat or operating control to lowest setting.
2. Turn off all electrical power to the appliance if service is to be performed.
3. Close manual test firing valve (**c**), all pilot shutoff valve(s) (**g**) and gas hand valve (**b**).
4. Replace base access shield (on PROPANE BOILERS ONLY) and jacket front panel.

550-223-000(1001)





## Common problems and solutions

Symptom	Common Causes	Possible Corrections
<b>Rapid cycling – boiler turns on and off frequently</b>	Thermostat installed where drafts or heat affect reading	Locate thermostat on inner wall away from heat sources or cool drafts.
	Heat anticipator in thermostat adjusted incorrectly	Adjust thermostat per manufacturer's instructions.
	Incorrect limit setting	Set limit according to system needs. Maximum setting is 220°F. Increase limit setting to decrease cycling.
	Insufficient water flow through boiler	Check all valves to and from boiler. Return to proper setting. Confirm circulator size.
<b>Frequent release of water through relief valve</b>	Expansion tank sized too small	Call qualified service technician to check expansion tank operation and size.
	Flooded expansion tank	Call qualified service technician to check expansion tank operation.
	Inoperative limit control	Call qualified service technician to replace limit control.
<b>Need to frequently add makeup water</b>	Leaks in boiler or piping	Have qualified service technician repair leaks at once to avoid constant use of makeup water. Makeup water can cause mineral deposits which, in turn, can cause boiler section failure. Do not use petroleum-base stop-leak compounds.
<b>Black water condition</b>	Oxygen corrosion due to leaks in boiler and piping	Have qualified service technician repair at once. Keep pH of water between 7.0 to 8.5.
<b>Popping or percolating noise heard in boiler</b>	Mineral deposits in sections due to constant use of makeup water	Call qualified service technician to de-lime boiler, if necessary. In some cases, deposits will be too heavy to remove with de-liming procedures. Have qualified service technician repair leaks to eliminate need for constant makeup water.
	Incorrect pH of boiler water	Call qualified service technician to check pH level and correct. pH should be maintained between 7.0 to 8.5.
	Insufficient water flow through boiler	Check all valves to and from boiler. Return to proper setting. Confirm circulator size.
<b>Metal flakes found in vent outlet or vent – flueway corrosion</b>	Contaminated combustion air supply — See page 3 in this manual.	Remove any contaminating products. See page 3 in this manual. Provide outside air for combustion. Kit available through Weil-McLain distributor. Have qualified service technician pipe-up kit.
	Condensation of combustion gases in boiler sections	Have qualified service technician inspect system piping and controls to verify proper regulation of return water temperature.
<b>Some radiators or baseboard units do not heat or are noisy</b>	Air in system	Bleed air from system through air vents in radiators or baseboard units.
	Low system pressure	Fill to correct pressure. Check for leaks in boiler or piping. Have qualified service technician repair at once.
	High limit set too low	Adjust high limit to higher setting.

# Weil-McLain Limited Warranties

## Residential & Commercial Cast Iron Boilers

### ◆ Residential Water Warranty — Limited Lifetime

### ◆ Residential Steam Warranty — Limited 10 Year

### ◆ Commercial Warranty — Limited 10 Year

**First Year — (All Residential & Commercial Cast Iron Boilers)** Weil-McLain warrants that its cast iron boilers are free from defects in material and workmanship for one year from date of installation. If any parts are found to be defective from such defects, Weil-McLain will provide replacement of such defective parts.

### **Second Through Tenth Year — (Residential & Commercial Water/Steam)**

Weil-McLain warrants that the cast iron sections of its water and steam boilers are free from defects in material and workmanship from the date of installation for the second through the tenth year. If, during such time, any section is found to be defective, Weil-McLain will provide replacement of such defective section(s).

**Eleventh Year and Beyond — (Residential Water Only)** Weil-McLain warrants that the cast iron sections of its residential water boilers are free from defects in material and workmanship for the eleventh year and beyond from the date of installation. If, during such time period, any section(s) is found to be defective, Weil-McLain will provide replacement of such defective section(s) upon the payment of a proportionate charge based on the time the boiler has been in service. The proportionate charge will be equal to the appropriate percentage of the list price of such section(s) at the time the warranty claim is made, and will be determined as follows: 11th year-5%; 12th year-10%; 13th year-15%; 14th year-20%; 15th year-25%; 16th year-30%; 17th year-35%; 18th year-40%; 19th year-45%; 20th year-50%; 21st year-55%; 22nd year-60%; 23rd year-65%; 24th year-70%; 25th year & beyond -75%.

**These warranties do not cover** boilers operated with combustion air contaminated externally by chemical vapors or with improper fuel additives, or with water conditions which may have caused unusual deposits in the cast iron sections.

See section "For all Weil-McLain Products" for additional warranty information.

## Weil-McLain Ultra Cast Aluminum Boilers

### ◆ Residential Warranty — Limited 15 Year (includes 5-Year Ultra Protection Plan)

### ◆ Commercial Warranty — Limited 15 Year (does NOT include Ultra HPP)

**First Through Fifth Year —** Weil-McLain warrants that its cast aluminum boilers are free from defects in material and workmanship for one year from the date of installation and the heat exchanger is free from defects in material and workmanship for five years from the date of installation. If any parts in the first year, or the heat exchanger in the first five years are found to be defective from such defects, Weil-McLain will provide replacement of such defective parts or heat exchanger. In addition to the product warranty, Weil-McLain will provide a 5-Year "Ultra" Homeowner Protection Plan ("UHPP") for residential applications only to cover parts and labor for five years from the date of installation provided only if the Ultra boiler is properly registered with the UHPP Administrator within one month of the date of installation. UHPP claims must be processed directly through the Plan Administrator and not through Weil-McLain.

**Sixth Through Tenth Year —** Weil-McLain warrants that the heat exchangers of its cast aluminum boilers are free from defects in material and workmanship for the sixth through the tenth year from the date of installation. If, during such time, the heat exchanger is found to be defective, Weil-McLain will provide replacement of such defective heat exchanger.

**Eleventh Through Fifteenth Year —** Weil-McLain warrants that the heat exchangers of its cast aluminum boilers are free from defects in material and workmanship for the eleventh through fifteenth year from the date of installation. If, during such time period, the heat exchanger is found to be defective, Weil-McLain will provide replacement for such defective heat exchanger upon the payment of a proportionate charge based on the time the boiler has been in service. The proportionate charge will be equal to the appropriate percentage of the list price of such heat exchanger at the time the warranty claim is made, and will be determined as follows: 11th year - 10%; 12th year - 20%; 13th year - 40%; 14th year - 60%; 15th year - 80%; 16th year & beyond - 100%.

**This warranty does not cover** boilers operated with combustion air contaminated externally by chemical vapors or with improper fuel additives, or with water/system conditions which may have caused heat exchanger failure.

See section "For all Weil-McLain Products" for additional warranty information.

**For All Weil-McLain Products:** These warranties are subject to the condition that the Weil-McLain Product(s) must have been installed in accordance with manufacturers' instructions by a heating contractor whose principal occupation is the sale and installation of plumbing, heating and/or air conditioning equipment. These warranties extend only to the first retail purchaser of the products and only to a product that has not been moved from its original installation site.

In addition to each product warranty listed, Weil-McLain warranties do not cover:

1. Components that are part of the heating system (products) but were not furnished by Weil-McLain as a part of the heating system (products).
2. The workmanship of any installer of Weil-McLain's product(s). In addition, this warranty does not assume any liability of any nature for unsatisfactory performance caused by improper installation.
3. Any costs for labor for removal and reinstallation of the alleged defective part, transportation to Weil-McLain, if necessary, and any other materials necessary to perform the exchange.
4. Any products that have a failure or malfunction resulting from improper or negligent operation, accident, abuse, freezing, misuse, unauthorized alteration or improper repair or maintenance.
5. Improper adjustments (including boiler/burner), control settings, care or maintenance. Information is in the installation, start-up, operations, owner/user's manuals, service/maintenance instructions, and other printed/technical information provided with the product or direct from Weil-McLain or [weil-mclain.com](http://weil-mclain.com).

## Indirect-Fired Water Heaters

### ◆ Residential Water Heater Warranty — Limited Lifetime

### ◆ Commercial Water Heater Warranty — Limited 15 Year

**First Year — (Residential and Commercial Water Heaters)** Weil-McLain warrants that its indirect-fired water heaters are free from defects in material and workmanship for one year from the date of installation. If any parts are found to be defective from such defects, Weil-McLain will provide replacement of such defective parts.

### **Second Year and Beyond — (Residential Only)**

### **Second Through Fifth Years — (Commercial Only)**

Weil-McLain warrants that the tank assembly components of its indirect-fired water heaters are free from defects in material and workmanship for the second through the fifth year from the date of installation (commercial only), or for the second year from the date of installation and beyond (for residential only). If, during such time periods, a leak in the tank assembly should occur, Weil-McLain will provide replacement for the original tank assembly.

**Sixth Year through Fifteenth Year — (Commercial Only)** Weil-McLain warrants that the tank assembly components of its commercial indirect-fired water heaters are free from defects in material and workmanship for the sixth year through the fifteenth year following the date of installation. If, during such time period, a leak in the tank assembly should occur, Weil-McLain will provide replacement for such defective tank assembly. Such replacement will be furnished with the nearest comparable model available from Weil-McLain at the time of such replacement and upon payment of a proportionate charge. Proportionate charges will be equal to the appropriate percentage of the current list price of such commercial indirect-fired water heater at the time warranty claim is made and will be determined as follows: 6th & 7th year-55%; 8th & 9th year-60%; 10th & 11th year-65%; 12th & 13th year-70%; 14th & 15th year-75%.

**These warranties do not cover:**

1. Any water heater not initially installed with a new temperature-pressure relief valve bearing the listing of the American Society of Mechanical Engineers (A.S.M.E.) at the time of the water heater installation.
2. Any water heater that has a failure or malfunction resulting from a.) failure to keep the tank full of potable water; b.) failure to assure that water in the tank is free to circulate at all times; or c.) failure to keep the tank free of water sediment or scale deposits.
3. Any water heater that has potable water in the unit with a chloride or chlorine content higher than 80 mg/liter.
4. Any water heater installed in a residence containing any type of water softener system that is not installed and maintained in accordance with manufacturer's specifications.
5. Any water heater installation where non-metallic piping products without an oxygen barrier are used.
6. Any water heater used for non-potable application such as pool or process heating.

See section "For all Weil-McLain Products" for additional warranty information.

## Radiant Heating Products

### ◆ Radiant Heating Products Warranty — Limited 30 Year

### ◆ IPP & IPC Products Warranty — Limited 3 Year

Weil-McLain warrants that its AlumiPex and Qual-Pex radiant heating products are free from defects in material and workmanship for thirty years (three years for IPP and IPC products) from the date of installation. If any parts are found to be defective from such defects during such time period, Weil-McLain will provide replacement of such defective parts. It is expressly understood that failure as a result of freezing of water within the pipes (tubing) does not constitute a defect in material or workmanship and shall not be covered by this warranty.

See section "For all Weil-McLain Products" for additional warranty information.

## Parts and Accessories

### ◆ Parts and Accessories Warranty — Limited 1 Year

Weil-McLain warrants that parts and accessories that were purchased through Weil-McLain are free from defects in material and workmanship for one year from the date of installation. If any parts and/or accessories are found to be defective from such defects during such time period, Weil-McLain will provide replacement of such defective parts. Parts and accessories covered under this warranty include only those items that are not covered under other Weil-McLain product warranties.

See section "For all Weil-McLain Products" for additional warranty information.

**NOTE:** Residential warranties do not cover any residential products installed in buildings other than one or two family dwelling units, unless they are buildings with individual residential products for each dwelling unit.

**THE WARRANTIES DESCRIBED HEREIN ARE IN LIEU OF ALL OTHER WARRANTIES, EXPRESS OR IMPLIED, INCLUDING BUT NOT LIMITED TO ANY IMPLIED WARRANTIES OF FITNESS FOR A PARTICULAR PURPOSE AND MERCHANTABILITY. WEIL-McLAIN EXPRESSLY DISCLAIMS AND EXCLUDES ANY LIABILITY FOR CONSEQUENTIAL, INCIDENTAL, INDIRECT OR PUNITIVE DAMAGES FOR BREACH OF ANY EXPRESS WARRANTY.** For prompt product warranty claims, notify the installer who, in turn, will notify the Weil-McLain distributor from whom he purchased the boiler. If this action does not result in warranty resolution, contact Weil-McLain Consumer Relations Department, 500 Blaine Street, Michigan City, Indiana 46360, with details in support of the warranty claim. Alleged defective part or parts must be returned through the same trade channel in accordance with the Weil-McLain procedure currently in force for handling returned goods for the purpose of inspection to determine cause of failure. Weil-McLain will furnish new part(s) to an authorized Weil-McLain distributor who, in turn will furnish the new part(s) to the heating contractor who installed the boiler. If you have any questions about the coverage of this warranty, contact Weil-McLain at the address above.



Weil-McLain  
500 Blaine Street  
Michigan City, IN 46360-2388  
<http://www.weil-mclain.com>