

TM-2430

Recorder for Ambulatory blood
pressure monitor

INSTRUCTION MANUAL

Ambulatory Blood Pressure Monitor



© 2014 A&D Company, Limited. All rights reserved.

No part of this publication may be reproduced, transmitted, transcribed or translated into any language in any form by any means without the express written consent of A&D Company, Limited.

The contents of this manual and the specifications of the instruments covered by this manual are subject to change without notice.



Contents

| | |
|---|----|
| Before use | |
| Compliance | 2 |
| Definitions | 2 |
| Precautions for Use | 3 |
| Notes on the Blood Pressure Recorder | 5 |
| Welcome | |
| Welcome and Intention | 6 |
| Product overview | |
| Packing List and Component Names | 7 |
| Display | 9 |
| Symbols | 9 |
| Specifications | |
| Features | 10 |
| Functions and Specifications | 10 |
| The complete procedure for use | |
| Step by Step Procedure | 14 |
| Initializing the recorder | |
| Replacing the Batteries | 16 |
| The State of Turning on the Recorder | 17 |
| Parameters for the Display and Clock | 17 |
| Selection for the Automatic Measurement | 19 |
| Deleting Old Data | 23 |
| Resetting the Recorder | 23 |
| Preparing the patient | |
| Patient Instructions | 24 |
| Notes on Cuff Use | 25 |
| Use of the Cuff Cover | 26 |
| Attaching the Cuff and Recorder | 26 |
| Preparation of the Carrying Case | 28 |
| Operation | |
| Automatic Measurement (by Programmed Time Intervals)..... | 29 |
| Manual Measurement | 29 |
| To Stop the Current Measurement | 29 |
| Data transfer | |
| Data Transmission to a Printer | 30 |
| Data Transmission to a Computer Using Analysis Software | 32 |
| Options and accessories | |
| Analysis Software and Communication Cables | 33 |
| Cuffs and Other Accessories | 34 |
| Maintenance | |
| Checking Accuracy | 35 |
| Cleaning the Cuff and Recorder | 36 |
| Periodical Inspection | 36 |
| Troubleshooting | 36 |
| Error Codes | 37 |
| Appendix | |
| EMC Information | 39 |
| Index | 42 |



Before use



Compliance

Compliance with European Directive 93/42 EEC for Medical Products

The device conforms to the following requirements: European Directive 93/42 EEC for Medical Products; Medical Products Act; European Standards for Electrical Medical Equipment EN60601-1 (General Safety Provisions), EN60601-2-30 (Particular Requirements for the Safety of Automatic Cycling Indirect Blood Pressure Monitoring Equipment), EN60601-1-2 and EN55011 (Electromagnetic Compatibility); European Standards pertaining to Non Invasive Blood Pressure Instruments EN1060-1 (General Requirements), EN1060-3 (Supplementary Requirements for Electromechanical Blood Pressure Measuring Systems). The above is evidenced by the CE mark of conformity accompanied by the reference number of a designated authority. This device is designed for adults only.

Compliance with FCC Rules

Please note that this equipment generates, uses and can radiate radio frequency energy. This equipment has been tested and has been found to comply with the limits of a Class A computing device pursuant to Subpart J of Part 15 of FCC rules. These rules are designed to provide reasonable protection against interference when this equipment is operated in a commercial environment. If this unit is operated in a residential area it might cause some interference and under these circumstances the user would be required to take, at his own expense, whatever measures are necessary to eliminate the interference. (FCC: Federal Communications Commission in the U.S.A.)

Compliance with the Australian EMC Framework

The device conforms to the following requirements: EMC Emission standard for industrial, Scientific & Medical equipment AS/ NZS 2064-1997, EMC Generic Immunity standard AS/ NZS 4252. 1-1994. The above is evidenced by the C-Tick label.



Definitions

| | |
|----------------------|--|
| SYS | Systolic Blood Pressure |
| DIA | Diastolic Blood Pressure |
| DSD | The difference between Systolic Blood Pressure and Diastolic Blood Pressure. |
| Exhaust | This means "releasing the cuff air as soon as possible". |
| Constant exhaust | This means "releasing the cuff air at a constant depressurization rate". |
| Exhaust velocity | This means the rate of depressurizing the cuff air. |
| During a measurement | This means "a period between the start of cuff inflation and the end of exhausting the air". |
| Interval | This is called a "block". A block consists of a start time and frequency. |
| bpm | beats per minute. |



Precautions for Use

Precautions

Batteries

- Use alkaline batteries (LR6 type, AA type, Mignon) or the specified Ni-MH batteries.
- Do not mix new and used batteries in the recorder.
- Remove the batteries from the recorder, if it will not be used for a long period of time and unless there is no risk of a SAFETY HAZARD arising.

A malfunctioning recorder

- If the recorder malfunctions, stop the operation, attach a note "Do not use this recorder" and store in a safe place to avoid misuse.

Training

- Instruct the patient on how to stop the operation if there is an abnormal measurement, and how to remove the cuff if there is excessive arm pain.
- Advise the patient on how to cope with mis-operation and contingencies

Repair

- Do not open the recorder case. Contact your nearest A&D dealer if you have questions.

Blood pressure measurement

- Use the recorder on adults.
- The recorder may not make a correct measurement when a patient has continuous arrhythmia or the recorder senses noise due to the patient's movement.
- Please check measurement values by other methods, if you suspect the values.
- Do not use this recorder on a person who is using a heartlung machine and a defibrillator.
- Do not use this recorder on a person who is critical or is in an intensive care unit.

Data in memory

- A built-in backup battery keeps the important data in memory while replacing the main batteries. However it works for a short period of time. Perform the battery replacement swiftly, or you may lose measurement data, the clock setting information and automatic measurement condition data. The period varies depending on the battery condition. The backup battery may take 24 hours or more to be fully charged (depending on the battery condition).
- The built-in backup battery (rechargeable) as well as the primary battery (not rechargeable) will deteriorate along use, which causes to decrease its capacity. The built-in backup battery will deteriorate due to repetitive backup operations.

To prevent the sudden drop of the built-in battery life, observe the following:

- Before using the monitor for the first time after purchase or after an extended period of no use, charge the battery fully. It takes 24 hours or more with the power switch turned on. Charging can be performed during measurement.
- After measurement, leave the battery inside and the power switch turned on. Under this condition, the built-in battery will not deteriorate. (This is true with the "B" sign displayed.)
- When the monitor is not to be used for a month or longer, turn the power switch off to prevent the main batteries from leaking. During an extended period of no use, the built-in battery will deteriorate. To prevent the situation, use the monitor regularly.
- When the power switch is turned on and off after a short period of use, the built-in battery will not be fully charged and the battery life will decrease. Avoid this situation.

Saving power

- Turn off the power switch when not in use.
- The backup battery life is a few days. Please transfer the data as soon as possible.

Cuff

- Close the cuff fastener properly when attaching the cuff to a patient or replacing the cuff cloth. If the fastener is closed incorrectly, the cuff may be damaged during use.



Notes on the Blood Pressure Recorder

Storage

- Do not store the recorder in the following places.
 - Where the recorder could be splashed with water or other liquids. If the recorder becomes soaked, it needs a repair. (Do not use the recorder.)
 - Where the temperature and humidity are high, or in direct sunlight.
 - Where the recorder may be influenced by vibration or shock.
 - Where there is dust, salt or sulfur vapor.
 - Where chemicals are stored, or chemicals are evaporating.

Before use

- Cover the RS-232C terminal using the cap, to avoid dust.
- Confirm that the recorder works correctly and measurement values are proper.
- Confirm that the cuff and air hose are connected properly.
- Confirm parts in direct contact with the patient. Keep these parts clean.
- Use a clean cuff cover. Because it comes into direct contact with the patient.
- Delete the old data before starting a new measurement.
- Avoid strong magnetic field and static electricity.
- Do not use this recorder while using high frequency surgical equipment.

During use

- The recorder should be operated by medical personnel who knows it well.
- Use the recorder only during the time of diagnosis or medical treatment.
- Stop using the recorder, if the patient feels pain in the arm or the recorder does not measure properly.
- The measurement cycle may be reduced due to the environment.
- When an inside part of the recorder becomes soaked (wet), turn off the power switch and request service from your supplier or the A&D service group.

After use

- Clean the recorder, cuff and accessories for the next use. Do not pull or kink hoses. Do not use organic solvent, antiseptic solution, etc.
- Turn off the power switch after measurement.
- Please use the original box for transportation.

Periodic maintenance

- The recorder is a precision instrument. Please check all functions periodically (every year). Contact your nearest A&D dealer for the inspection.

Environmental protection

- If you discard the recorder, remove the Ni-MH batteries and built-in Li battery from the recorder.
 - Dispose of the Ni-MH batteries in the designated container for recycling.
 - Dispose of the Li battery properly as a hazardous waste.





Welcome



Welcome and Intention

Thank you for your Purchase!

The A&D TM-2430 ambulatory blood pressure recorder enables you to accurately take a patient's blood pressure, automatically, at different preset times throughout a 24-hour period.

Recently, in the treatment of patients with hypertension, there has been an increasing need to prescribe medication according to the particular blood pressure fluctuation pattern of the patient. These patterns can be made more evident by using the TM-2430 recorder, and analysis by a physician.

This manual will explain in simple language how this recorder works.

Patient

This blood pressure recorder is designed for an adult patient.

Environment

This blood pressure recorder is used in a hospital and / or patient's home.



Product overview



Packing List and Component Names

When you open this box, make sure you have everything as shown below:

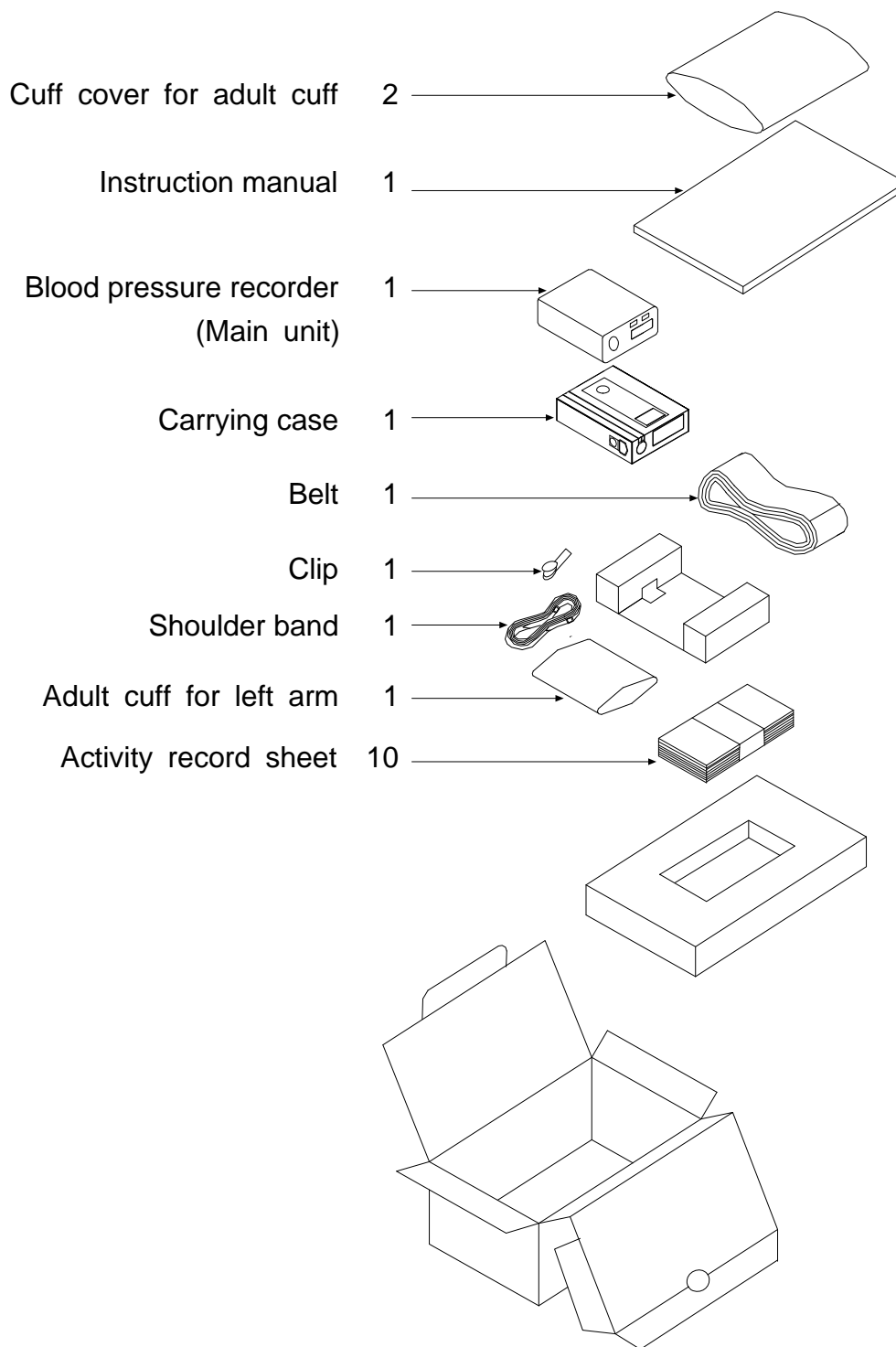

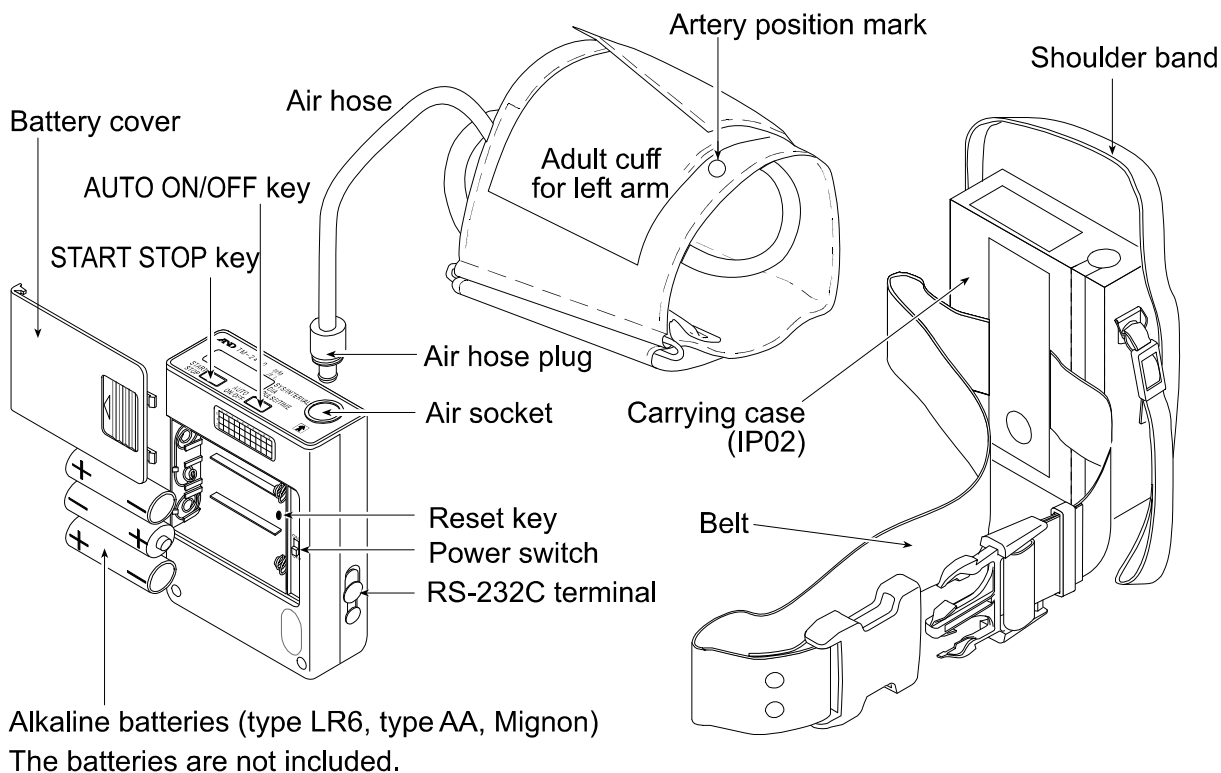

| Name | Functions |
|------------------|---|
| Power switch | This is the main power switch. At the OFF state, all data and parameters are stored by a backup battery. This backup battery life is approximately 10 days with the power off. |
| AUTO ON/OFF key | <ul style="list-style-type: none"> • When you press and hold the AUTO ON/OFF key, the automatic measurement is started or stopped alternately. • When you press the AUTO ON/OFF key at mode II of the automatic measurement, "S" is displayed or turned off alternately. This sign changes the interval for sleep. |
| START STOP key | <ul style="list-style-type: none"> • When you press the START STOP key, a blood pressure measurement is started. • When you press and hold the START STOP key for approx. 3 seconds, the recorder proceeds to "Selection for the automatic measurement". • When you press and hold the START STOP key for approx. 6 seconds, the recorder proceeds to "Parameters for the display and clock". • When you press and hold the START STOP key for approx. 9 seconds, the recorder proceeds to "Deleting old data". |
| RS-232C terminal | This terminal is used for data output to a printer or computer. The optional RS-232C cable is necessary to output the data. |
| Reset key | All data and parameters are deleted. |



Display

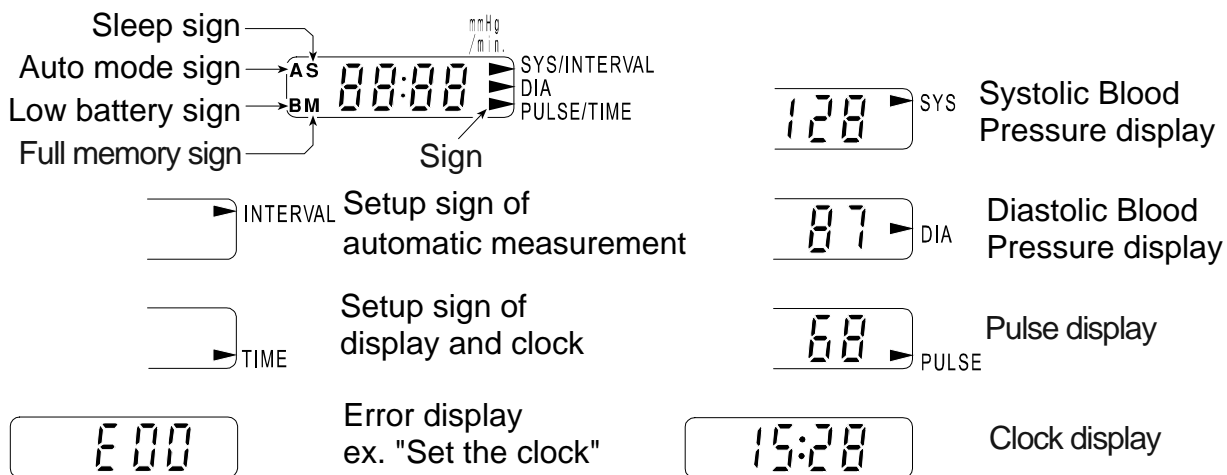

| Sign | Name | Functions |
|------|-----------------------|---|
| ▶ | Arrow | The arrow points to the kind of current display in the measurement result and function mode. |
| A | Automatic measurement | "A" is displayed when the automatic measurement is selected. When you press and hold the AUTO ON/OFF key, this sign is turned on or off alternately. |
| S | Sleep | When you press the AUTO ON/OFF key while in mode II of the automatic measurement, "S" is displayed or turned off alternately. With "S" turned off, the time interval is 15 minutes. With "S" turned on, the time interval is 30 minutes. |
| B | Low battery | When the recorder cannot operate all functions due to low battery, this sign is displayed. The clock is still displayed. Please replace the batteries immediately. |
| M | Full memory | When data memory is at full capacity, this sign is displayed. In this case, you cannot perform another measurement. Transfer the data, save in other media and delete. Then "M" turns off. |



Symbols

- I Turning on the recorder.
- Turning off the recorder.
- Direction guide to install batteries.
- Direct current.
- SN Serial number.
- 2014 Date of manufacture.
- Attention symbol. "See instruction for use."
- Recorder, Cuff and tubing are designed to have special protection against electric shocks.
- Operating instructions
- Refer to instruction manual/booklet
Note: On ME equipment "Follow instruction for use"
- WEEE symbol



Specifications



Features

Portability

- The recorder weighs approx. 215 g (including batteries) and is palm top size, because a micro-pump is used.
- The recorder is powered by LR6 type (Mignon) alkaline batteries. It is possible to replace the LR6 type batteries with Ni-MH rechargeable batteries.

Operation & management

- Clock and automatic measurement parameters may be set as needed.
- If you connect to a computer and use the optional software, clock and automatic measurement parameters can be set easily.
- There are three modes for automatic measurement.
- The recorder can transmit data to a printer directly. (An adaptable printer is necessary to print the data. Refer to "Data Transmission to a Printer" for specifications of the printer.)
- The recorder has the built-in rechargeable coin Li battery to keep the clock and automatic measurement parameters.
- Charge the rechargeable battery using a charger with CE Marking. The battery cannot be charged using the recorder.

Analysis

- The time interval may be changed as needed.
- The patient's blood pressure can be measured immediately at any time.
- If you use the optional software, you can analyze the data widely.

Smart measurement

- The measurement time is shortened by proper exhaust velocity control.
- The exhaust velocity adjustment is unnecessary, because the constant exhaust is properly controlled.
- In the automatic measurement, the inflation value and stop value at exhaust is managed to reduce the measurement time.



Functions and Specifications

Blood pressure measurement

- There are two ways of blood pressure measurement.
Automatic measurement----- This automatic measurement works in accordance with internal clock, preset time intervals and preset mode. The measurement data is saved in memory.
Manual measurement -----Any time you press the **START STOP** key, a blood pressure measurement is performed immediately. The measurement data is saved in memory.

Automatic measurement

- The measurement starts or stops using the **AUTO ON/OFF** key. When the measurement is started, the recorder begins to work in accordance with preset time intervals from the preset time of the internal clock. Refer to "Selection for the Automatic Measurement".
- In the automatic measurement, "A" appears in the upper left of the display.
- The recorder automatically measures the patient's blood pressure at the time that is pointed out by "the frequency" and "the start time" (by the programmed time intervals).
- When a measurement error occurs and there is 8 minutes until the next measurement, the measurement is retried after approx. 30 seconds.
- If a measurement is retried, only the data from the retry is saved.
- The recorder automatically adjusts the proper pressure, exhaust velocity and end of measurement.
- Refer to "Selection for the Automatic Measurement" and "Automatic Measurement (by Programmed Time Intervals)" about operation and entering parameters.

Stopping a measurement

- If you press the **START STOP** key during a measurement, the recorder exhausts the air and stops the measurement.

Concealing the measurement value

- This function works only while using automatic measurement.
- This function does not display the SYS, DIA or pulse rate for the automatic measurement, but the data is saved in memory.
- This function can select "reveal" or "conceal" at "Parameters for the Display and Clock". Refer to this section.
- If you select "conceal", the recorder displays the clock during a measurement.
- If you reset the recorder, this parameter is set to "reveal".

Pressurization

- The pressure is automatically selected by the recorder while in the automatic measurement mode.
- The first pressure is set to approx. 185 mmHg. This value automatically varies to the proper value after first measurement. If the first inflation is not successful, the recorder retries twice.
- If you reset the recorder, the first inflation value is set to 185 mmHg.

Memory

- The recorder can store 350 sets of data (the memory capacity is 350). A data set consists of the SYS, DIA and pulse rate.
- When memory becomes full, the recorder displays an "M". Until you delete the data, you cannot measure blood pressure.



When the recorder saves data for more than one patient, data management becomes complicated. We encourage that each patient's data is recorded, transferred and is deleted from memory.





When "B" is displayed, the backup battery that stores a patient's data is weak. Please transfer the data and save it in other media as soon as possible.

ID number

- If you reset the recorder, the ID number is set to "1".
- The ID number can be set using the optional software.

Performance specifications

| | | |
|---|--|---|
| Measurement method | Oscillometric | |
| Pressurization | Micro-pump | |
| | Display range | 0 ~ 320 mmHg |
| | Automatic measurement | 85 ~ 300 mmHg (Fitted) |
| | Manual measurement | 185 mmHg (Fixed) |
| Measurement range | Systolic Blood Pressure | 60 ~ 280 mmHg |
| | Diastolic Blood Pressure | 40 ~ 160 mmHg |
| | Pulse rate | 30 ~ 200 bpm |
| Accuracy | Pressure | ±3 mmHg |
| | Blood pressure | Conforming to 1992 AAMI standard |
| | Pulse rate | ±5 % |
| Minimum display division | Pressure | 1 mmHg |
| | Pulse rate | 1 bpm |
| Depressurization | Constant exhaust | Controlled ceramic valve |
| | Exhaust | Ceramic valve |
| Measurement | Automatic measurement | |
| | Manual measurement | |
| Number of measurement | Approx. 200 times (Varies depending on the environment and the condition of the Ni-MH batteries) | |
| Memory | Up to 350 sets of data | |
| Display | Normal | Clock |
| | During a measurement | Pressure value |
| | After a measurement | SYS, DIA and pulse rate |
| | Error code, function of concealing the measurement data | |
| Clock | 24-hour (1997-2096, automatic leap year setting) | |
| Batteries | 3 x Alkaline battery (type LR6, type AA, Mignon) or 3 x Ni-MH battery (type AA, Mignon) | |
| Type of protecting against electric shock | Internally powered equipment type BF  | |
| CE Marking | The label of the medical device by the EC directive. |  |
| C-Tick Marking | The certification trade mark registered to the ACA by the Trademark office. |  |
| Protection against water and dust | Recorder: IP20 Carrying case (IP02): IP02 | IP22 (when both are used) |

AAMI: Association for the Advancement of Medical Instrumentation

ACA: the Australian Communications Authority

CE marking and C-Tick marking are labeled only for the countries where they are required.

| | | | | | | | | | | | | |
|-------------|---|-----------|----------|-----------|--------|-----------|--------|-------------|---|--------|------|------|
| Interface | Connected to a computer, you can output the data and enter parameters. Connected to a printer, you can print the data. EIA RS-232C, Asynchronous, bi-directional, half duplex | | | | | | | | | | | |
| | <table> <tr><td>Baud rate</td><td>9600 bps</td></tr> <tr><td>Data bits</td><td>8 bits</td></tr> <tr><td>Stop bits</td><td>2 bits</td></tr> <tr><td>X parameter</td><td>Used (for computer) Not used (for printer)</td></tr> <tr><td>Parity</td><td>None</td></tr> <tr><td>Code</td><td>ASCII</td></tr> </table> | Baud rate | 9600 bps | Data bits | 8 bits | Stop bits | 2 bits | X parameter | Used (for computer) Not used (for printer) | Parity | None | Code |
| Baud rate | 9600 bps | | | | | | | | | | | |
| Data bits | 8 bits | | | | | | | | | | | |
| Stop bits | 2 bits | | | | | | | | | | | |
| X parameter | Used (for computer) Not used (for printer) | | | | | | | | | | | |
| Parity | None | | | | | | | | | | | |
| Code | ASCII | | | | | | | | | | | |
| | | | | | | | | | | | | |

Environment specifications

| | |
|-----------------------|---|
| Operating environment | + 10° C ~ +40° C (+50° F ~ +104° F), 10 ~ 85%RH * |
| Transport and Storage | - 20° C ~ +55° C (-4° F ~ +131° F), 10 ~ 95%RH * |

* Non Condensing

Physical specifications

| | |
|------------|---|
| Dimensions | 72(W) x 100(D) x 27(H) mm 2.8(W) x 3.9(D) x 1.0(H) in. |
| Weight | Approx. 215 g (0.47lb) excluding cuff |

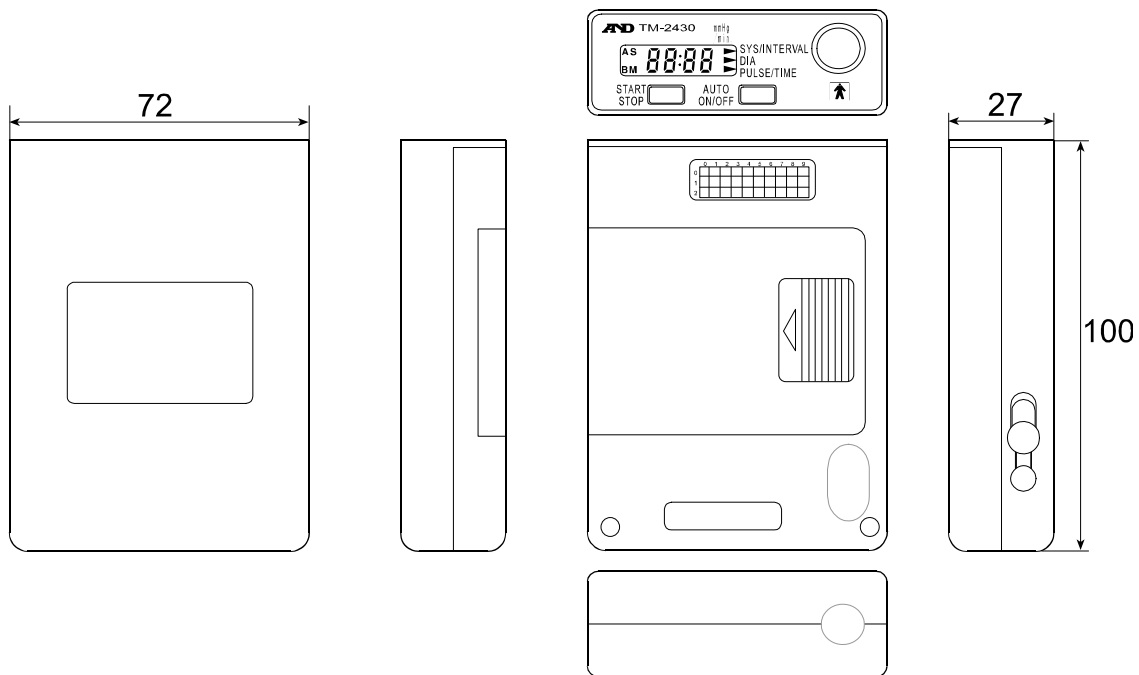

Unit: mm



The complete procedure for use



Step by Step Procedure

Step 1 Battery replacement.
Replace with new alkaline batteries (note direction).
Refer to "Replacing the Batteries" on page 16.

Step 2 Turn on the recorder using the power switch.

Step 3 Follow the procedure, depending on the recorder state.

Case 1 Normal state

The buzzer sounds once and the clock is displayed. The recorder is ready for use. The recorder stores parameters for "display and clock" and "automatic measurement". Please proceed to **Step 5**.

Case 2 Error state

When the recorder displays the $E \square \square$ error code, it is necessary to set parameters for "display and clock" and "automatic measurement". Please proceed to the next step.

Step 4 Set parameters for "display and clock". When you use automatic measurement, set parameters for automatic measurement. Refer to "Parameters for the Display and Clock" and "Selection for the Automatic Measurement". Please proceed to **Step 6**.

Step 5 Set new parameters for "display and clock" and "automatic measurement", if necessary.

Step 6 Delete the old data stored in the recorder. Refer to "Deleting Old Data".

Step 7 Explain "Patient Instructions" and "Notes on the Blood Pressure Recorder" to the patient.

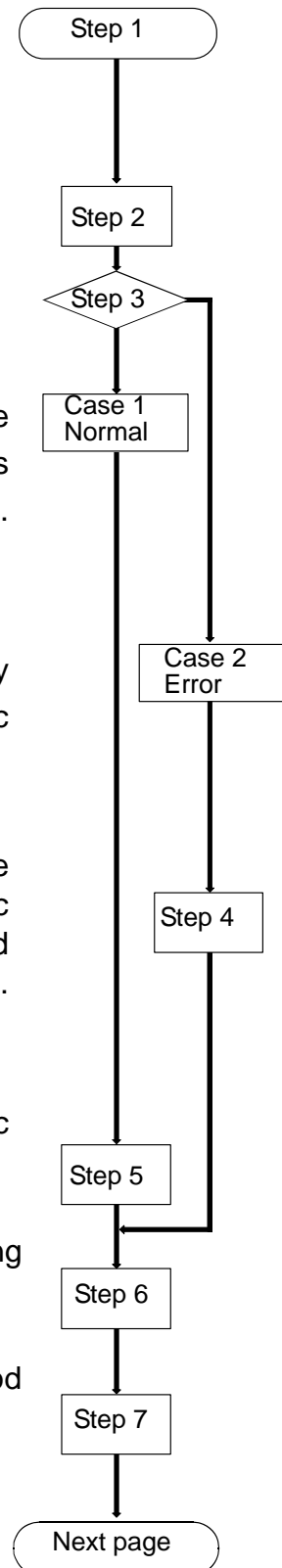

Step 8 Attach the cuff to the patient. Refer to "Attaching the Cuff and Recorder".

Step 9 Attach the carrying case to the patient and insert the recorder. Refer to "Attaching the Cuff and Recorder".

Step 10 Check the recorder using the manual measurement with relaxed, but correct posture. Refer to "Manual Measurement".

Step 11 Start the automatic measurement. The recorder displays "A" and starts the automatic measurement sequence. Refer to "Automatic Measurement".

Step 12 When using automatic measurement, consider the following.

- Consider the sections "Patient instructions" and "Notes on the Blood Pressure Recorder".
- When the patient uses mode II of automatic measurement, press the **AUTO ON/OFF** key with each rising and going to bed.

Step 13 When the automatic measurement sequence is finished, the "A" sign turns off. Refer to "Automatic Measurement".

Step 14 Remove the cuff and recorder from the patient.

Step 15 Transfer the patient's data and save it in other media. Refer to "Data transfer".

Step 16 Clean the cuff and recorder and place them in storage. Refer to "Before use" and "Maintenance".

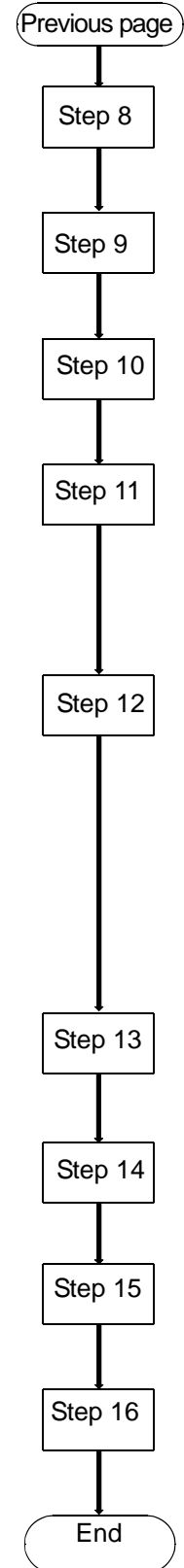



Initializing the recorder



Replacing the Batteries

Caution

- When "B" is displayed before a measurement, the recorder cannot make a measurement. Please replace with new batteries before using.
- If "B" is displayed during the measurement, stop the measurement and replace with new batteries immediately.
- Use alkaline batteries or the specified rechargeable batteries for the recorder.
- Do not use new and used batteries at the same time.

Steps for replacing the batteries

- Step 1** Open the battery cover.
- Step 2** Turn off the power switch.
- Step 3** Replace with new batteries. (Note the direction, "+" and "-".)
- Step 4** Turn on the power switch.
- Step 5** Close the battery cover.

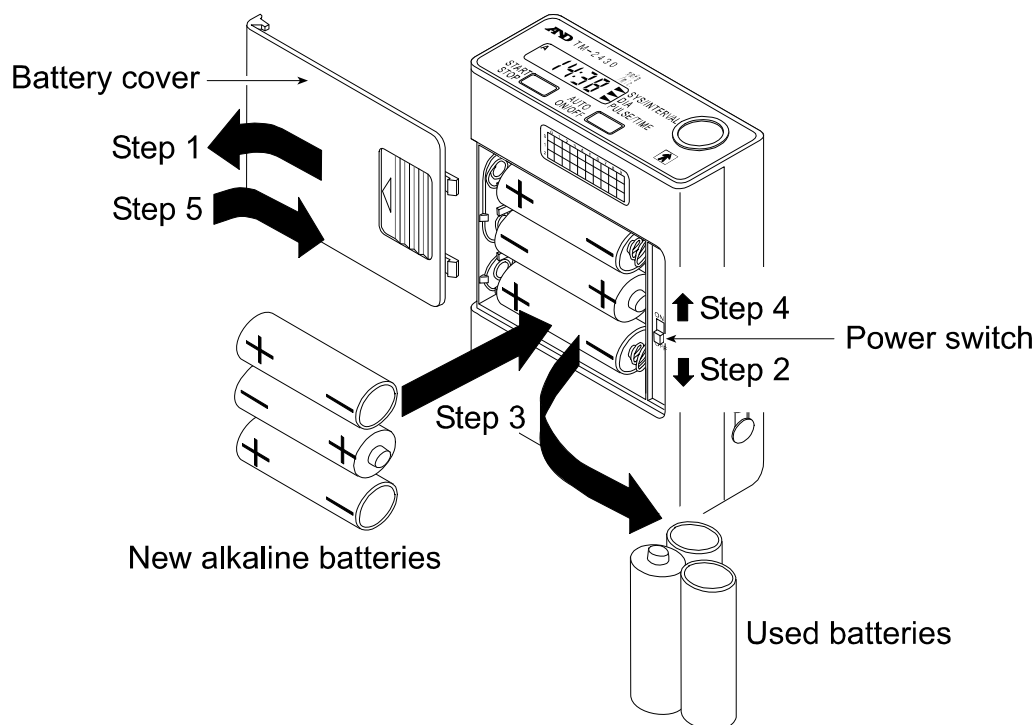



The State of Turning on the Recorder

There are three types of state when the recorder is turned on. Select an operation. Refer to "The complete procedure for use" about use.

| Action when the recorder is turned on. | State of recorder | Treatment (Operation) |
|---|---|---|
| The buzzer sounds once and the clock is displayed. (Normal state) | The recorder stores parameters for "display and clock" and "automatic measurement". | The recorder is ready for use. |
| The buzzer sounds once and $E 00$ is displayed blinking. | All parameters are lost. | Set parameters for "display and clock" and "Automatic measurement". |
| The buzzer sounds four times and $E 00$ is displayed blinking. | The state after reset. All parameters are lost. | |



Parameters for the Display and Clock

This setting selects the display during automatic measurement sequence and adjusts the clock parameters. The sequence number tells you which parameter you are adjusting.

Display & key

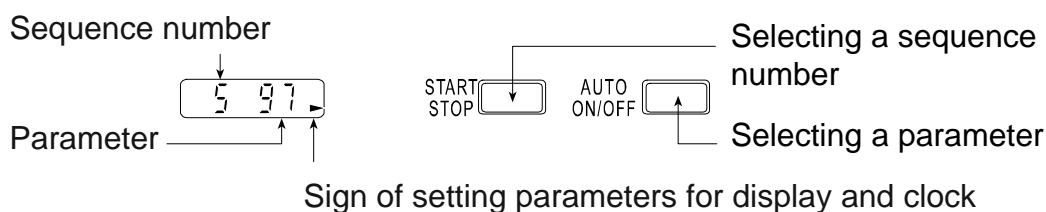

Items

| Sequence number | Value & range | Meaning of parameters | |
|-----------------|---------------|---|--------|
| 1 | 0 | Displaying clock only in automatic measurement | |
| | 1 | Displaying pressure and result in automatic measurement | $1 1$ |
| 5 | 00 ~ 99 | Year (1997 ~ 2096) | $5 97$ |
| 6 | 01 ~ 12 | Month | $6 1$ |
| 7 | 01 ~ 31 | Day | $7 1$ |
| 8 | 00 ~ 23 | Hour | $8 0$ |
| 9 | 00 ~ 59 | Minute | $9 00$ |

Steps for setting the display and clock

This explanation uses the following examples.

ex. After reset, the measurement value is not displayed.

The clock is adjusted to 1997/ 05/ 27 14:28.

- Step 1** Press and hold the **START STOP** key for approx. 6 seconds. The recorder displays  for adjusting the display and clock.
- Step 2** Press the **AUTO ON/OFF** key to display .
(A selection to display the clock only in automatic measurement)
- Step 3** Press the **START STOP** key. The current year is displayed.
- Step 4** Press the **START STOP** key. The current month is displayed.
- Step 5** Press the **AUTO ON/OFF** key to display 5 (for May).
- Step 6** Press the **START STOP** key. The current day is displayed.
- Step 7** Press the **AUTO ON/OFF** key to display 27 (27th day).
- Step 8** Press the **START STOP** key. The current hour is displayed.
- Step 9** Press the **AUTO ON/OFF** key to display 14 (14th hour).
- Step 10** Press the **START STOP** key. The current minute is displayed.
- Step 11** Press the **AUTO ON/OFF** key to display 28 (28th minute).
- Step 12** Press the **START STOP** key to save these parameters. Then the recorder displays the clock.

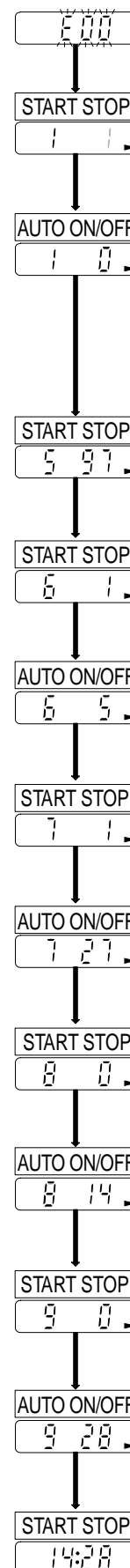



Selection for the Automatic Measurement

This setting initializes measurement intervals that are based on the internal 24-hour clock.

Mode

mode I 07:00 ~ 21:59 The measurement is performed every quarter hour.
 22:00 ~ 06:59 The measurement is performed every half hour.

mode II The **AUTO ON/OFF** key is pressed at rising and going to bed so that the measurement intervals are changed and the time during sleep can be distinguished on the data.

When "S" is off, the measurement is performed every quarter hour.

When "S" is displayed, the measurement is performed every half hour.

mode III The measurement interval can be changed six times within a maximum of 24 hours. (The recorder can store six measurement intervals (blocks) in 24 hours. A block consists of a start time and frequency.)

Display & key

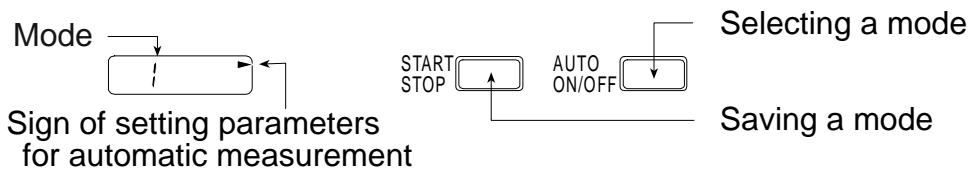

Steps for selecting a mode

ex. Mode II is selected.

Step 1 Press and hold the **START STOP** key for about 3 seconds. The current mode is displayed.

Step 2 Press the **AUTO ON/OFF** key to display **2** for mode II.

Step 3 Press the **START STOP** key. The recorder stores the mode and displays the clock.

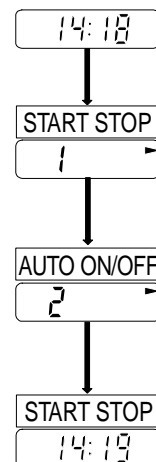

Mode III Settings

Setup procedure

Before you enter into mode III, read the procedure below. Also, refer to the example on the next page for the setting procedure.

- Each block's finish time is the next block's start time.
- The end of block 6 automatically becomes the start time of block 1.
- If you enter the block 1 start time in any other block, these parameters are saved and this sequence is finished.
- When selecting 120 minutes for the current frequency, you must adjust the start time of the next block so that the current block fits a multiple of 120 minutes. If not, an error code is displayed.
- The recorder displays 1h as 60 minutes and 2h as 120 minutes.
- When you enter the sequence of mode III settings, the recorder initializes each start time to the start time of block 1 and each frequency to "-" (not used).

To read the current settings, press the **START STOP** key in this sequence.

Display & key

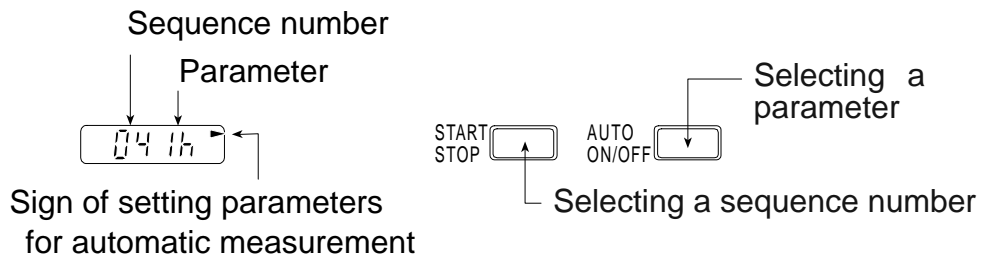

Items

| Sequence number | Parameters (monitor) | Meaning | Initial value |
|-----------------|---------------------------------------|----------------------------|---------------|
| 01 | 0 ~ 23 o'clock | Start time of first block | 01 7 |
| 02 | -, 5, 10, 15, 20, 30, 60, 120 minutes | Frequency of first block | 02 15 |
| 03 | 0 ~ 23 o'clock | Start time of second block | 03 22 |
| 04 | -, 5, 10, 15, 20, 30, 60, 120 minutes | Frequency of second block | 04 30 |
| 05 | 0 ~ 23 o'clock | Start time of third block | 05 7 |
| 06 | -, 5, 10, 15, 20, 30, 60, 120 minutes | Frequency of third block | 06 - |
| 07 | 0 ~ 23 o'clock | Start time of fourth block | 07 - |
| 08 | -, 5, 10, 15, 20, 30, 60, 120 minutes | Frequency of fourth block | 08 - |
| 09 | 0 ~ 23 o'clock | Start time of fifth block | 09 - |
| 10 | -, 5, 10, 15, 20, 30, 60, 120 minutes | Frequency of fifth block | 10 - |
| 11 | 0 ~ 23 o'clock | Start time of sixth block | 11 - |
| 12 | -, 5, 10, 15, 20, 30, 60, 120 minutes | Frequency of sixth block | 12 - |
| 13 | 0 ~ 23 o'clock | End of sixth block | 13 - |

"-" means "not used".

Steps for automatic measurement

ex. First block 08:00 ~ 21:59 frequency 30 minutes
 Second block 22:00 ~ 05:59 frequency 60 minutes
 Third block 06:00 ~ 07:59 frequency 10 minutes

- Step 1** Press and hold the **START STOP** key for approx. 3 seconds. The current mode is displayed.
- Step 2** Press the **AUTO ON/OFF** key to display **3** for mode III.
- Step 3** Press the **START STOP** key. The mode is stored and the current start time of the first block is displayed.
- Step 4** Press the **AUTO ON/OFF** key to display "8" for 8:00 hours as the start time of the first block.
- Step 5** Press the **START STOP** key. The current frequency for the first block is displayed.
- Step 6** Press the **AUTO ON/OFF** key to display "30" for 30 minutes as the frequency for the first block.
- Step 7** Press the **START STOP** key. The current start time of the second block is displayed.
- Step 8** Press the **AUTO ON/OFF** key to display "22" for 22:00 hours as the start time for the second block.
- Step 9** Press the **START STOP** key. The current frequency for the second block is displayed.
- Step 10** Press the **AUTO ON/OFF** key to display "1h" for 60 minutes as the frequency of the second block.
- Step 11** Press the **START STOP** key. The current start time of the third block is displayed.
- Step 12** Press the **AUTO ON/OFF** key to display "6" for 6:00 hours as the start time of the third block.

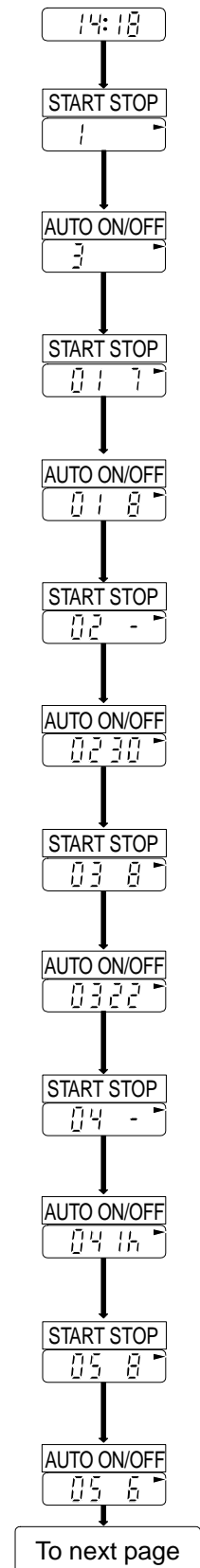

- Step13** Press the **START STOP** key. The current frequency of the third block is displayed.
- Step14** Press the **AUTO ON/OFF** key to display "10" for 10 minutes as the frequency of the third block.
- Step15** Press the **START STOP** key. The current start time of the fourth block is displayed.
- Step16** Press the **AUTO ON/OFF** key. The recorder stores these parameters and displays the clock, (because the current start time of the fourth block is the same as the start time of the first block).

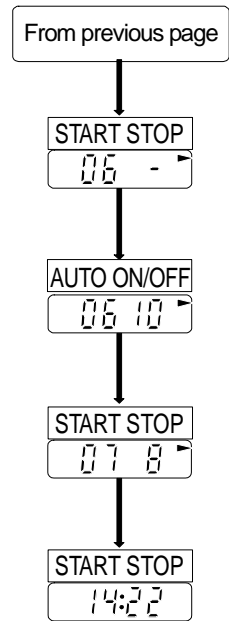



Deleting Old Data

- Caution** Confirm that the data has already been transferred and saved, when the data is to be deleted. It is not possible to recover data that was deleted.
- It is not possible to delete data completely, if the **START STOP** key is released while the buzzer sounds at Step 2.

Steps for deleting old data

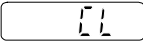
- Step 1** Press and hold the **START STOP** key for approx. 9 seconds.  is displayed. If you want to cancel this process, press the **AUTO ON/OFF** key.
- Step 2** Press and hold the **START STOP** key once more until the buzzer stops.



Resetting the Recorder

If the recorder does not work correctly, press the reset key. The recorder deletes all data and parameters. The internal system is initialized.

- Caution** By resetting, all data and parameters are deleted and the internal system is initialized.
- Do not press the reset key too intensely. Press the key gently so as not to damage the components inside.
- Keep the reset key hole free of foreign materials.

Steps for resetting the recorder

- Step 1** Open the battery cover.
- Step 2** Turn off the power switch.
- Step 3** Remove the batteries from the recorder.
- Step 4** Press the reset key gently.
- Step 5** Place new batteries in the recorder.
- Step 6** Turn on the power switch. The recorder sounds the buzzer four times and *E 00* is displayed blinking.
- Step 7** Set the parameters for the display and clock. Also, adjust the parameters for automatic measurement.

Reset key

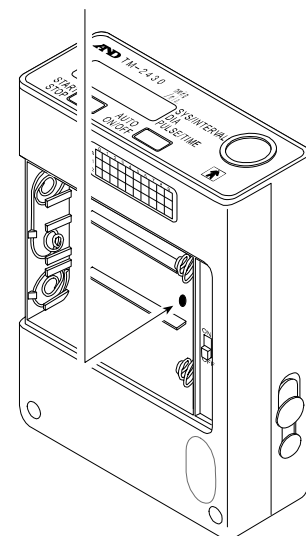



Preparing the patient



Patient Instructions

Advise the patient on how to cope with mis-operation and contingencies.

Precautions during automatic measurement

- Relax and be quiet, when the recorder starts inflating the cuff.
- Maintain the same posture during measurement.
- Avoid noises and vibrations during measurement.
- After inflation, the recorder deflates the cuff and measures the patient's blood pressure. The maximum measurement time is 90 seconds. Relax and be quiet during measurement.
- If you move your body during measurement, the recorder may start inflation during the deflation process for reevaluating the blood pressure.
- If the recorder did not acquire usable data due to the patient's body movement and the frequency of the interval is 8 minutes or more, the recorder may start measurement again approx. 30 seconds after measurement.. Do not move and try to relax during measurement.
- Stop using the recorder, if the patient feels pain in the arm.

Stopping or canceling an automatic measurement

- To stop the measurement, press the **START STOP** key. The recorder beeps, releases the cuff air and an error is displayed. The recorder will inflate the cuff for the next time period automatically.
- To cancel automatic measurement, press and hold the **AUTO ON/OFF** for approx. 3 seconds. Automatic measurement is canceled and "A" turns off.
To restart automatic measurement after cancellation, press and hold the **AUTO ON/OFF** for approx. 3 seconds. "A" appears and the recorder resumes measurement and records data except the cancelled block.

Manual measurement

- To start a measurement, press the **START STOP** key.
- To stop the measurement, press the **START STOP** key.

Precautions for attaching the cuff and recorder

- Do not drop or apply shock to the recorder.
- The recorder and cuff are not water resistant. Prevent rain, sweat and water from wetting the recorder and cuff.
- Do not place anything on the recorder.
- Re-attach the cuff if the cuff is slipped from the proper position due to the patient's movement.
- Use caution not to break the air hose or not to entangle around the patient's neck or body during sleep. Attach the air hose to the patient's body only as shown on page 27.

Replacing the batteries

- Replace with new batteries immediately, when "B" is displayed.



Notes on Cuff Use

**Note: A cuff is a consumable item and may need replacing if worn or damaged.
Please check the cuff conditions before use.**

In the following cases, replace the used cuff with a new one immediately.

- When there is a crack or stickiness in the joint of the cuff's bladder or the tube.
- When the tube is not flexible or has stiffened.
- When the surface of the tube is coated with an oil-like substance.
- When there is a defined crease in the bladder.

Confirm the following before use.

- Confirm that the zip fastener, for the cuff cover, is closed completely, to the red stopper cloth, as shown in the illustration below.
If the zip fastener is not closed completely, the internal bladder may escape from the cuff cover and explode or otherwise be damaged.

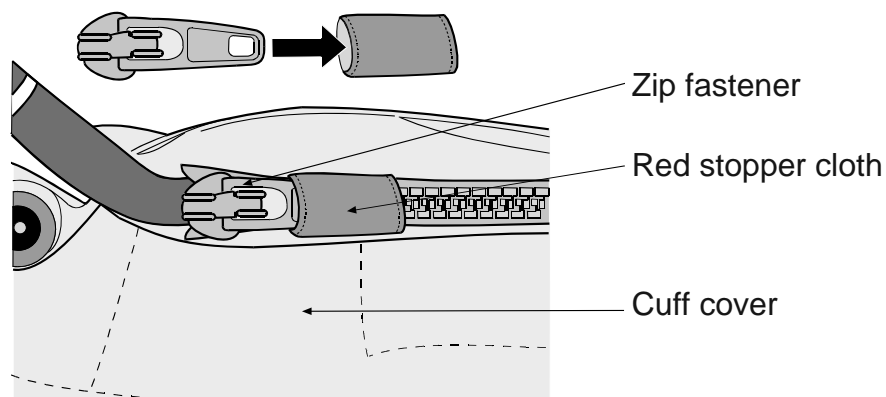



Use of the Cuff Cover

Step 1 Place the cuff on the cuff cover as shown.
When the cuff cover with slits is used, pass the air hose through a slit.

Step 2 Secure the cuff cover to the cuff using the fabric fasteners.

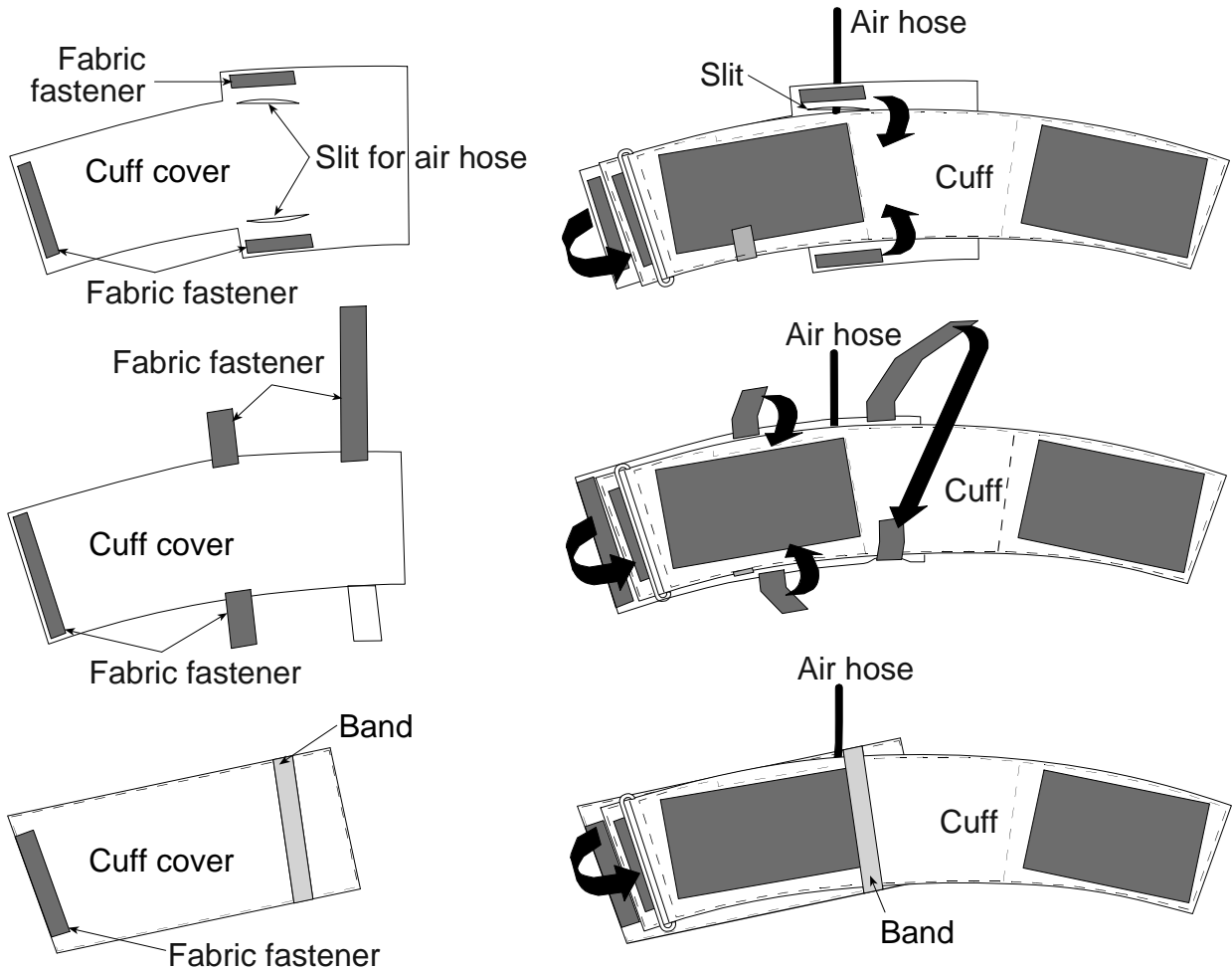

Attaching the Cuff and Recorder

Caution

- If the cuff is not attached at the proper position, the recorder may not measure the blood pressure correctly and an error may occur.
- The cuff accessory is for use on the left arm, of about 20cm ~ 31cm. If you need a different cuff, purchase a cuff of the proper size and arm position. Refer to "Option and accessories".
- Do not attach the cuff to an arm with an unhealed wound, dermatitis, etc.



Keep the cuff clean. Change the cuff cover for each patient. The cuff cover may be used for either right or left arm cuff.

Steps for attaching the cuff and recorder

- Step 1** Make a circle where the end of the cuff is passed through the ring.
- Step 2** Search for the brachial artery using palpation.
- Step 3** Attach the cuff directly against the skin so that the artery position mark is directly over the brachial artery and the lower edge of the cuff is placed one inch above the inside of the elbow.
- Step 4** Wrap the cuff so that the ring is within the slide range, evenly and tight enough not to slip down but loose enough to insert two fingers. (If the ring is not within the slide range, you need a proper cuff.)
- Step 5** Position the air hose over the shoulder and affix it on the patient using the clip.
- Step 6** Assemble the belt and carrying case.
- Step 7** Position the belt so that the carrying case is on the right (left) side of the patient, when a patient attaches the left (right) arm cuff.
- Step 8** Connect the air hose plug to the air socket.
- Step 9** Place the recorder into the carrying case.

Caution

- Do not disturb the cuff or air hose during the measurement because the recorder measures small pressure variations.

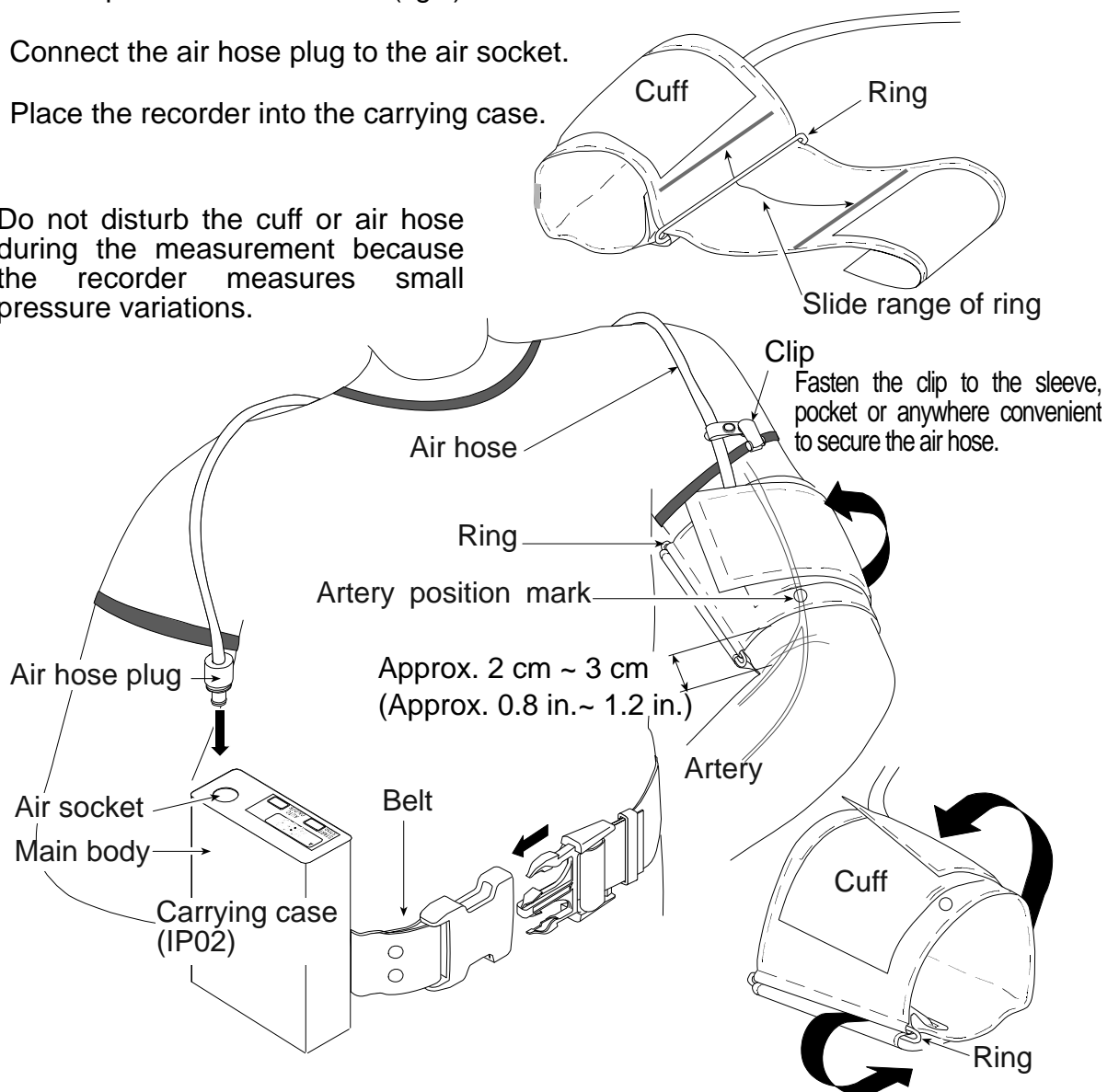



Preparation of the Carrying Case

- Use the belt or shoulder band to attach the carrying case.
- We recommend the belt so that the carrying case is not worn out of shape on the patient.

Using the belt

- Step 1** Insert the belt through the strap located on the rear of the carrying case.
- Step 2** Pull the belt through the strap.
- Step 3** Pass the belt through the ring.
- Step 4** Pass the belt through the front-hole and the rear-hole of the hook.
- Step 5** Insert the belt into the ring again.

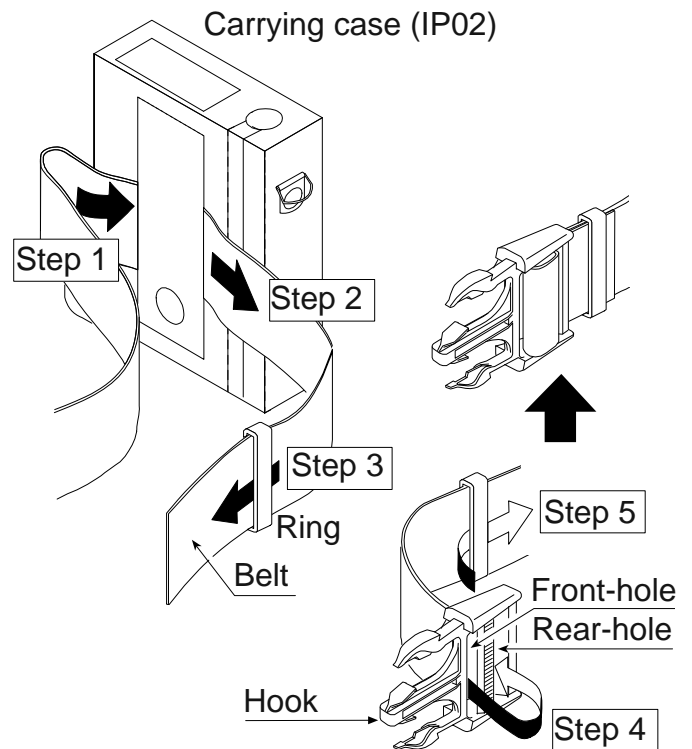

Using the shoulder band

- Step 1** Insert the band into the buckle.
- Step 2** Pass the band through the ring.
- Step 3** Pass the band through the buckle as shown in the right illustration.

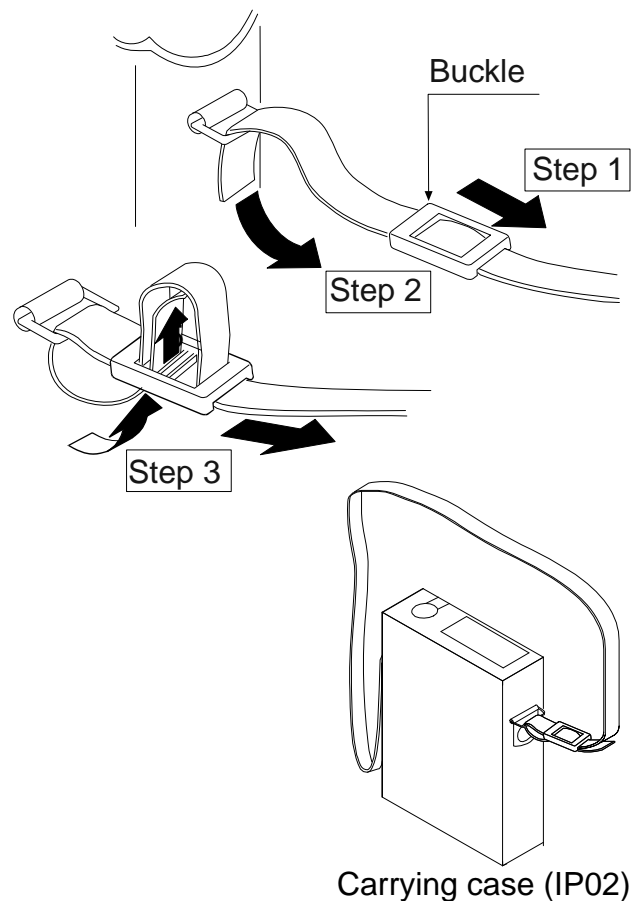



Operation



Automatic Measurement

Caution

- Automatic measurement uses the internal clock and parameters for automatic measurement. Refer to "Parameters for the Display and Clock" and "Selection for the Automatic Measurement" for setting these parameters.
- When the patient stops the automatic measurement or removes the cuff, press and hold the **AUTO ON/OFF** key for approx. 3 seconds to turn off the "A" sign. If the "A" sign is left turned on, the recorder may start the next automatic measurement and cause damage to the cuff.

Starting or re-starting automatic measurement

- Step 1** Confirm the parameters for automatic measurement. Refer to "Selection for the Automatic Measurement".
- Step 2** Press and hold the **AUTO ON/OFF** key for about 3 seconds. Then "A" is displayed and the recorder starts an automatic measurement based on the internal clock and the parameters for automatic measurement.

Operation using mode II

- Step 1** Press the **AUTO ON/OFF** key to turn off "S" when the patient wakes up.
- Step 2** Press the **AUTO ON/OFF** key to turn on "S" when the patient goes to bed.

Stopping or canceling automatic measurement

- Step 1** Press and hold the **AUTO ON/OFF** key for about 3 seconds. "A" turns off and the recorder stops automatic measurement.



Manual Measurement

- Step 1** Press the **START STOP** key. The recorder starts a measurement. The results are displayed and stored in memory.



To Stop the Current Measurement

- Step 1** Press the **START STOP** key during measurement. The recorder will stop the measurement and releases the air from the cuff.



Data transfer

- The recorder transfers data to a printer or computer using the RS-232C terminal.
- We recommend analysis of the data using the optional analysis software.

Caution

- Cover the RS-232C terminal using the cap, to prevent dust and foreign materials from entering when this terminal is not in use.
- Remove the recorder and cuff from the patient, when the recorder is connected to a printer or computer.
- The personal computer must comply with EN60601-1.



Data Transmission to a Printer

Caution

- The recorder intensely consumes the battery power while connected to the RS-232C cable. Disconnect the cable when not actually transferring data.
- Maintain the power-on state while transmitting the data so that the data is not damaged.
- The optional RS-232C cable is required when connecting to a printer.
- The printer (to print the data) must have a serial interface and adapt to the RS-232C protocol of the recorder.
- The printer must comply with EN60601-1.

Specifications for an adaptable printer

| | | |
|--------------------|---|------------------|
| Transmission | EIA RS-232C | |
| | Asynchronous, bi-directional, half duplex | |
| | Baud rate | 9600 bps |
| | Start bits | 1 bit |
| | Data bits | 8 bits |
| | Parity bit | None |
| | Stop bits | 2 bits |
| | X parameter | Not used |
| | ETX/ACK | Not used |
| | DSR | Not used |
| | Code | ASCII |
| Command | Carriage return | 0Dh |
| | Next line | 0Dh 0Ah |
| | Next page | 0Ch 0Dh |
| Printer parameters | Next page | Automatic |
| | Characters per line | 72 min. |
| | Buffer size | approx. 32Kbytes |

Steps for data transmission

- Step 1** Enter the parameters into the printer so that the data can be transmitted.
- Step 2** Connect the cable to both the recorder and printer. Then the recorder displays . Refer to "Analysis Software and Communication Cables" about the cable.
- Step 3** Set the printer to "ON LINE".
- Step 4** Press the **START STOP** key. Then . is displayed and the data is transmitted.
- Step 5** When the transmission is finished, . is displayed.
- Step 6** Remove the cable. The clock is displayed.

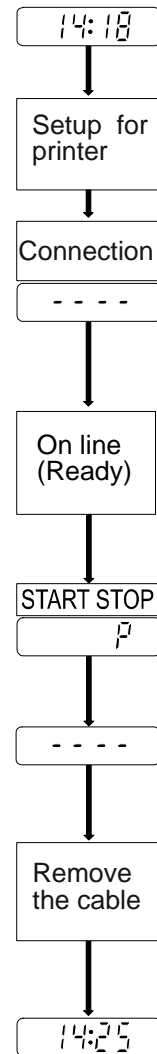

Print sample

| ===== ABPM DATA TABLE ===== | | | | | | | |
|-----------------------------|-----------|-------|-----------|-----------|----------|-----|----|
| No. | Date | Time | SYS(mmHg) | DIA(mmHg) | PUL(bpm) | ERR | |
| 1 | `97/ 5/17 | 7:43 | 103 | 65 | 55 | - | |
| 2 | `97/ 5/17 | 8:00 | 119 | 79 | 65 | - | |
| 3 | `97/ 5/17 | 8:30 | 125 | 88 | 132 | - | |
| 4 | `97/ 5/17 | 9:00 | 122 | 84 | 116 | - | |
| 5 | `97/ 5/17 | 9:30 | 115 | 87 | 63 | - | |
| 6 | `97/ 5/17 | 10:00 | 118 | 76 | 61 | - | |
| 7 | `97/ 5/17 | 10:30 | - | - | - | - | 08 |
| 8 | `97/ 5/17 | 10:35 | 116 | 82 | 68 | - | |
| 9 | `97/ 5/17 | 11:00 | 114 | 75 | 62 | - | |
| 10 | `97/ 5/17 | 11:30 | 122 | 81 | 94 | - | |
| 11 | `97/ 5/17 | 12:00 | 123 | | | - | |
| 12 | `97/ 5/17 | 12:30 | 11 | | | - | |



Data Transmission to a Computer Using Analysis Software

Caution

- The recorder intensely consumes the battery power while connected to the RS-232C cable. Disconnect the cable when not actually transferring data.
- Maintain the power-on state while transmitting the data so that the data is not damaged.

Steps for data transmission

- Step 1** Connect the cable to both the recorder and printer. The recorder displays . Refer to "Analysis Software and Communication Cables" about the cable.
- Step 2** Read the data using the optional analysis software. Refer to the software instruction manual.
- Step 3** Remove the cable. The clock is displayed.

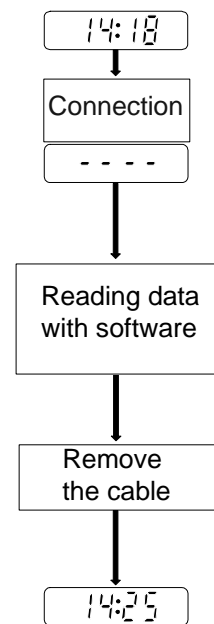



Options and accessories



Analysis Software and Communication Cables

The analysis software has functions as follows:

- Maximum value, minimum value and average are calculated in an arbitrary period of time. (Partial analysis)
- Correlation graph, trend graphs and histogram are displayed.
- The patient's data and information are managed.
- Data can be saved.
- Data can be deleted or copied.
- A saved data file can be exported into CSV format so that EXCEL can read it.
- Data can be output as a report.
- Data is input from the recorder and parameters are written to the recorder.

| Name | Order code |
|--|------------|
| Windows-based analysis software | TM2430-13 |
| Communication cable, D-SUB 9pin socket type | AX-KO1502 |
| Communication cable, D-SUB 25pin socket type | AX-KO1503 |
| Communication cable, D-SUB 25pin plug type | AX-KO1504 |



Cuffs and Other Accessories

Cuff

| Name | Order code |
|---|------------|
| Large cuff for left arm, 28 ~ 36 cm (11 ~ 14 inches) | TM2430-02B |
| Adult cuff for left arm, 20 ~ 31 cm (8 ~ 12 inches) | TM2430-06B |
| Small cuff for left arm, 15 ~ 22 cm (6 ~ 8 inches) | TM2430-07B |
| Adult cuff for right arm, 20 ~ 31 cm (8 ~ 12 inches) | TM2430-09B |

Cuff cover

| Name | Order code |
|----------------------------|-----------------|
| Large cuff cover 10 sheets | AX-133002066-S |
| Adult cuff cover 10 sheets | AX-1133011576-S |
| Small cuff cover 10 sheets | AX-13A37410-S |

Others

| Name | Order code |
|---------------------------------|--------------|
| TM-2430 Accuracy Diagnostic Kit | TM2430-90 |
| Activity record sheet 10 sheets | AX-PP174-S |
| Carrying case (IP02) | AX-133012212 |



Maintenance



Checking Accuracy

Required equipment

- Accurate office mercury sphygmomanometer or aneroid gauge with inflation system.
- TM-2430 Accuracy Diagnostic Kit (TM2430-90).
- A rigid cylinder sized to fit the cuff pressured.

Steps for checking accuracy

Step 1 Turn off the TM-2430 and remove the air hose from the unit.

Step 2 Construct the check system as shown below

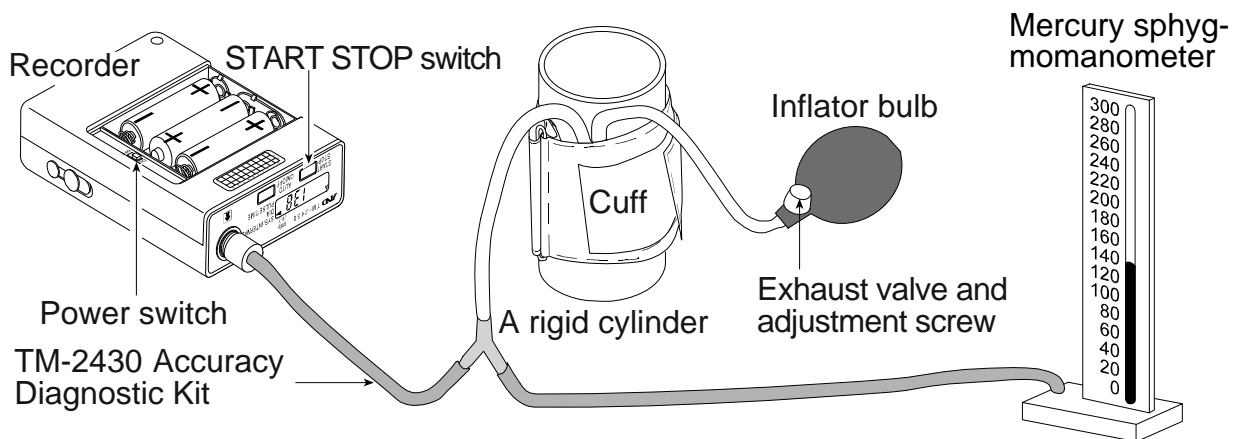

Step 3 Keep the pressure at the air socket to atmospheric pressure.

Step 4 While holding the **START STOP** key, turn on the power switch. "0" blinks. Release the **START STOP** key. "0" stops blinking.

Step 5 Squeeze the inflator bulb until the cuff pressure reaches 50 mmHg. Check the difference between the blinking display of TM-2430 and mercury sphygmomanometer is within ± 3 mmHg.

Step 6 Squeeze the inflator bulb until cuff pressure reaches 150 mmHg. Check the difference is within ± 3 mmHg.

Step 7 Squeeze the inflator bulb until cuff pressure reaches 250 mmHg. Check the difference is within ± 3 mmHg.

Step 8 Release the cuff air, turn off the TM-2430 and disassemble the check system. The blood pressure recorder is a precision instrument. Contact your nearest A&D dealer, if you need repair.



Cleaning the Cuff and Recorder

- Before cleaning the recorder, remove the battery cover, turn the power switch off and remove the batteries.
- The recorder is not water resistant. Do not allow liquids to splash on or get into the case while cleaning.
- After each use, wipe the case of the recorder with a clean lint free cloth, moistened with water and a mild detergent.
- Do not use antiseptic solutions, Alcohol, etc., to clean the recorder, hose or cuff.
- Clean the cuff cloth and cuff cover by washing in water with a mild detergent. Do not scrub or wring them by hand. If the cuff cloth and cuff cover become contaminated, replace them with new ones.



Periodical Inspection

- This blood pressure recorder is a precision instrument. Please inspect the functions (once a year) periodically. Contact your nearest A&D dealer for the inspection.
- Confirm the accuracy of the blood pressure monitor once a year.



Troubleshooting

Caution

- Do not open the case of the recorder because it uses delicate electrical components and intricate air unit that could be damaged.
- If you cannot locate and fix the problem, request service from your nearest A&D dealer, or from the A&D service group.
- A&D service group will support authorized suppliers about technical information, spare parts and units.

| Problem | Cause | Treatment |
|--------------------------------------|---|--|
| No display at turning on. | Batteries are drained. | Replace with new batteries. |
| Data lost while replacing batteries. | The built-in backup battery is drained | Turn on the recorder and display the clock for 24 hours or more, to fully charge the backup battery. |
| No pressure. | Air leakage at the connector, hose or cuff. | Confirm the cuff and air hose are not damaged and are connected correctly. |



Error Codes

Caution The error code may be updated without prior notice.

| Error code | Meaning | Status | Operation and Treatment |
|------------|---|--|--|
| E00 | No clock parameter | All parameters are lost. Reset status. | Enter clock parameters. Refer to "Parameters for the Display and Clock" |
| E03 | Pressure zero error | An error code is displayed without cuff inflation. | Release the air from the cuff completely. |
| E04 | Low battery | Measurement is stopped. An error code is displayed. Auto mode is quit. | Replace with new batteries. Restart the auto mode if you use it. |
| E05 | Inflation error | Inflation pressure does not reach the target pressure. | Connect the cuff to the main unit securely. If you cannot clear the error, there may be an air leak and repair is necessary |
| E06 | Above 320 mmHg | An error code is displayed. | Do not move and try to relax during the measurement. If you cannot clear the error, repair is necessary |
| E07 | Controlled stop using STOP key | Air is exhausted. An error code is displayed. | Press the STOP key only when necessary. |
| E08 | Pulsation cannot be measured | Measurable pulsation is searched to 20mmHg in constant exhaust. An error code is displayed. | Do not move and try to relax during the measurement. The error occurs when pulsations are not detected due to thick cloth or quick motion. |
| E10 | Pulsations cannot be detected because the patient may have moved. | In the measurement, quick exhaust is executed. An error code is displayed. | Do not move and try to relax during the measurement. |
| E20 | Pulse rate < 30 200 < Pulse rate | An error code is displayed. DIA : Diastolic Blood Pressure SYS : Systolic Blood Pressure DSD : The Difference between Systolic Blood Pressure and Diastolic Blood Pressure. | Measure the blood pressure by other methods. |
| E21 | DIA < 40 160 < DIA | | |
| E22 | SYS < 60 280 < SYS | | |
| E23 | DSD < 10 150 < DSD | | |

| Error code | Meaning | Status | Operation and Treatment |
|--------------------------|---|---|---|
| E30 | Measurement time exceeds 120 seconds. | Air is exhausted from the cuff, and an error code is displayed. | Repair is necessary because of slow inflation or slow constant exhaust. |
| E31 | The constant exhaust exceeds 60 seconds. | Air is exhausted from the cuff, and an error code is displayed. | Repair is necessary because of slow constant exhaust. |
| E32 | Clock error. | An error code is displayed. | If you cannot clear this error, repair is necessary. |
| E50 | Pressure offset error to measure pulsation. | An error code is displayed at restarting the recorder. | Release the air from the cuff completely, reset the recorder. If you cannot clear this error, repair is necessary. |
| E52 | Memory error. | An error code is displayed at restarting the recorder. | The recorder needs repair. |
| E53 | Battery contact is defective. | The measurement is stopped, air is released from the cuff and an error code is displayed. | Replace batteries correctly. If you cannot clear this error, repair is necessary. |
| E55 E56 E57 | Exhaust error. | An error code is displayed at measurement. | Do not move and try to relax during the measurement. If this error occurs frequently, repair is necessary. |
| E60 | Interval setting error. | Start time is not proper, interval of last block is not set in the unit of 120 min. | Enter parameters for the interval correctly. |
| E70 E71 E72 E73 | RS-232C error. | The error code is displayed during communications. | Re-connect the communication cable. If you cannot clear this error, repair is necessary. |
| E74 | Low battery for communication. | | Replace batteries with new ones and restart communication. |
| E75 | Protocol error due to external equipment. | | Re-connect the communication cable. If you cannot clear this error, repair is necessary. |
| E90 | Pressure zero error for safety circuit. | This error code is displayed before the measurement. | Release the air from the cuff completely. |
| E91 | Safety circuit detects overload pressure. | Patient moved during the measurement. | Relax and try to be quiet during the measurement. If it occurs while the patient relaxes and is quiet, the recorder needs repair. |
| Other | | Monitor code is displayed. | Reset. Turn on the power switch again. |



Appendix



EMC Information

- EMC guidelines and manufacturer's declaration
Medical Electrical Equipment needs special precautions regarding EMC and needs to be installed and put into service according to the EMC information provided in the following. Portable and mobile RF communication equipment (e.g. cell phones) can affect Medical Electrical Equipment.
The use of accessories and cables other than those specified (other than A&D original parts) may result in increased emissions or decreased immunity of the unit.

Guidance and manufacturer's declaration – electromagnetic emissions

The A&D unit is intended for use in the electromagnetic environment specified below. The customer or the user of the A&D unit should assure that it is used in such an environment.

| Emissions test | Compliance | Electromagnetic environment – guidance |
|---|------------|---|
| RF emissions CISPR 11 | Group 1 | The A&D unit uses RF energy only for its internal function. Therefore, its RF emissions are very low and are not likely to cause any interference in nearby electronic equipment. |
| RF emissions CISPR 11 | Class B | The A&D unit is suitable for use in all establishments, including domestic establishments and those directly connected to the public low-voltage power supply network that supplies buildings used for domestic purposes. |
| Harmonic emissions IEC 61000-3-2 | n.a. | |
| Voltage fluctuations/flicker emissions IEC 61000-3-3 | n.a. | |

Recommended separation distances between portable and mobile RF communications equipment and the A&D unit

The A&D unit is intended for use in an electromagnetic environment in which radiated RF disturbances are controlled. The customer or the user of the A&D unit can help prevent electromagnetic interference by maintaining a minimum distance between portable and mobile RF communications equipment (transmitters) and the A&D unit as recommended below, according to the maximum output power of the communications equipment.

| Rated maximum output power of transmitter W | Separation distance according to frequency of transmitter m | | |
|--|--|--|---|
| | 150 kHz to 80 MHz $d = 1.2\sqrt{P}$ | 80 MHz to 800 MHz $d = 1.2\sqrt{P}$ | 800 MHz to 2.5 GHz $d = 2.3\sqrt{P}$ |
| 0.01 | 0.12 | 0.12 | 0.23 |
| 0.1 | 0.38 | 0.38 | 0.73 |
| 1 | 1.2 | 1.2 | 2.3 |
| 10 | 3.8 | 3.8 | 7.3 |
| 100 | 12 | 12 | 23 |

For transmitters rated at a maximum output power not listed above, the recommended separation distance d in metres (m) can be estimated using the equation applicable to the frequency of the transmitter, where p is the maximum output power rating of the transmitter in watts (W) according to the transmitter manufacturer.

NOTE 1 At 80 MHz and 800 MHz, the separation distance for the higher frequency range applies.

NOTE 2 These guidelines may not apply in all situations. Electromagnetic propagation is affected by absorption and reflection from structures, objects and people.

Guidance and manufacturer's declaration – electromagnetic immunity

The A&D unit is intended for use in the electromagnetic environment specified below. The customer or the user of the A&D unit should assure that it is used in such an environment.

| Immunity test | IEC 60601 test level | Compliance level | Electromagnetic environment – guidance |
|---|---|---------------------------------|--|
| Conducted RF IEC 61000-4-6 Radiated RF IEC 61000-4-3 | 3 V _{rms} 150 kHz to 80 MHz 3 V/m 80 MHz to 2,5 GHz | 3 V _{rms} 3 V/m | Portable and mobile RF communications equipment should be used no closer to any part of the A&D unit, including cables, than the recommended separation distance calculated from the equation applicable to the frequency of the transmitter. Recommended separation distance: $d = 1.2 \sqrt{P}$ $d = 1.2 \sqrt{P}$ 80 MHz to 800 MHz $d = 2.3 \sqrt{P}$ 800 MHz to 2,5 GHz where <i>P</i> is the maximum output power rating of the transmitter in watts (W) according to the transmitter manufacturer and <i>d</i> is the recommended separation distance in metres (m). Field strengths from fixed RF transmitters, as determined by an electromagnetic site survey, ^a should be less than the compliance level in each frequency range. ^b Interference may occur in the vicinity of equipment marked with the following symbol:  |

NOTE 1 At 80 MHz and 800 MHz, the higher frequency range applies.

NOTE 2 These guidelines may not apply in all situations. Electromagnetic propagation is affected by absorption and reflection from structures, objects and people.

^a Field strengths from fixed transmitters, such as base stations for radio (cellular/cordless) telephones and land mobile radios, amateur radio, AM and FM radio broadcast and TV broadcast cannot be predicted theoretically with accuracy. To assess the electromagnetic environment due to fixed RF transmitters, an electromagnetic site survey should be considered. If the measured field strength in the location in which the A&D unit is used exceeds the applicable RF compliance level above, the A&D unit should be observed to verify normal operation. If abnormal performance is observed, additional measures may be necessary, such as re-orienting or relocating the A&D unit.

^b Over the frequency range 150 kHz to 80 MHz, field strengths should be less than 3 V/m.

Guidance and manufacturer's declaration – electromagnetic immunity

The A&D unit is intended for use in the electromagnetic environment specified below. The customer or the user of the A&D unit should assure that it is used in such an environment.









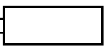

| Immunity test | IEC 60601 test level | Compliance level | Electromagnetic environment – guidance |
|--|---|------------------------------|--|
| Electrostatic discharge (ESD) IEC 61000-4-2 | ± 6 kV contact ± 8 kV air | ± 6 kV contact ± 8 kV air | Floors should be wood, concrete or ceramic tile. If floors are covered with synthetic material, the relative humidity should be at least 30%. |
| Electrical fast transient/burst IEC 61000-4-4 | ± 2 kV for power supply lines ± 1 kV for input/output lines | n.a. | Mains power quality should be that of a typical commercial or hospital environment. |
| Surge IEC 61000-4-5 | ± 1 kV line to line ±2 kV line to earth | n.a. | Mains power quality should be that of a typical commercial or hospital environment. |
| Voltage dips, short interruptions and voltage variations on power supply input lines IEC 61000-4-11 | < 5% U_T (> 95% dip in U_T) for 0.5 cycle 40% U_T (60% dip in U_T) for 5 cycles 70% U_T (30% dip in U_T) for 25 cycles < 5% U_T (> 95% dip in U_T) for 5 s | n.a. | Mains power quality should be that of a typical commercial or hospital environment. If the user of the A&D unit requires continued operation during power mains interruptions, it is recommended that the A&D unit be powered from an uninterruptible power supply or a battery. |
| Power frequency (50/60 Hz) magnetic field IEC 61000-4-8 | 3 A/m | 3 A/m | Power frequency magnetic fields should be at levels characteristic of a typical location in a typical commercial or hospital environment. |

NOTE : U_T is the AC mains voltage prior to application of the test level.

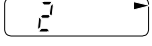

Index

Symbols

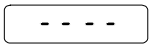
| | | |
|--|----------------|--------|
| | ----- | 9 |
| ○ | ----- | 9 |
| ⊕  ⊖ | ----- | 9 |
| — | ----- | 9 |
| - - - | ----- | 9 |
| 1997  | ----- | 9 |
|  | ----- | 9 |
|  | ----- | 9 |
|  | ----- | 9 |
|  | ----- | 9 |
|  | ----- | 9 |
|  | -----9, 17, 19 | |
|  | ----- | 19 |
|  | ----- | 19 |
|  | ----- | 21 |
| - | ----- | 20 |
|  | ----- | 31, 32 |
| SN | ----- | 9 |

A

| | | |
|-----------------------|--------------------|-----------|
| A | ----- | 9, 11, 29 |
| AAMI | ----- | 12 |
| accuracy | ----- | 12 |
| adult cuff | ----- | 34 |
| air hose | ----- 8, 26, 27 | |
| air hose plug | ----- 8, 27 | |
| alkaline battery | ----- 3, 12, 16 | |
| analysis | ----- | 10, 33 |
| arrow | ----- | 9 |
| artery | ----- | 27 |
| artery position mark | -----8, 27 | |
| AUTO ON/OFF key | ----- | 8 |
| automatic measurement | ----- 8, 9, 11, 29 | |

B

| | | |
|---------------|-------|-----------|
| B | ----- | 9, 11, 16 |
| battery | ----- | 3, 16 |
| battery cover | ----- | 8 |
| baud rate | ----- | 13 |

| | | |
|-------|-------|---------------|
| belt | ----- | 7, 8, 27 |
| block | ----- | 2, 19, 20, 21 |
| bpm | ----- | 2 |

C

| | | |
|---|-------|------------------|
| cable | ----- | 32, 33 |
|  | ----- | 23 |
| clock | ----- | 9, 12, 17 |
| code | ----- | 13 |
| concealing the measurement value | ----- | 11 |
| constant exhaust | ----- | 2 |
| CSV | ----- | 33 |
| cuff | ----- | 4, 8, 26, 27, 34 |
| cuff cover | ----- | 26, 34 |

D

| | | |
|--------------------------|----------------|----|
| D-SUB | ----- | 33 |
| data bits | ----- | 13 |
| depressurization | ----- | 12 |
| DIA | ----- | 2 |
| diastolic blood pressure | -----2, 12, 37 | |
| dimensions | ----- | 13 |
| display | ----- | 12 |
| DSD | ----- | 2 |

E

| | | |
|---|-------|------------|
|  | ----- | 17, 23, 37 |
| EEC | ----- | 2 |
| EMC information | ----- | 39 |
| error state | ----- | 14 |
| EXECL | ----- | 33 |
| exhaust | ----- | 2 |
| exhaust velocity | ----- | 2 |

F

| | | |
|-----------------|-------|---------------|
| fabric fastener | ----- | 26 |
| FCC | ----- | 2 |
| frequency | ----- | 2, 19, 20, 21 |
| full memory | ----- | 9 |

I

| | | |
|-----------|-------|-------|
| ID number | ----- | 12 |
| interface | ----- | 13 |
| interval | ----- | 2, 19 |

L

| | | |
|------------|-------|----|
| large cuff | ----- | 34 |
|------------|-------|----|

left arm ----- 34
low battery ----- 9

M

M -----9, 11
management ----- 10
manual measurement ----- 10
measurement ----- 12
memory ----- 11, 12
mode I ----- 19
mode II ----- 19, 29
mode III ----- 19, 20

N

Ni-MH ----- 5, 12

O

operating environment ----- 13

P

\bar{p} ----- 31
parity ----- 13
patient ----- 24
portability ----- 10
power switch ----- 8
printer ----- 30
pulse ----- 9

R

recorder ----- 5, 24
recording sheet ----- 34
repair ----- 3
reset key ----- 8, 23
right arm ----- 34
ring ----- 27
RS-232C ----- 8, 13, 30

S

S ----- 9, 19
selecting mode ----- 19
shoulder band ----- 7, 8
sleep ----- 9
slit ----- 26
small cuff ----- 34
SN ----- 9
START STOP key ----- 8
start time ----- 2, 19, 20, 21
stop bits ----- 13
stopping a measurement ----- 11
storage ----- 5

SYS -----2
systolic blood pressure -- 2, 12, 37

T

transmission ----- 30
transport and storage environment ---- 13

W

weight ----- 13

X

X parameter ----- 13



 **A&D Company, Limited**

1-243 Asahi , Kitamoto-shi, Saitama 364-8585, JAPAN
Telephone: [81] (48) 593-1111 Fax: [81] (48) 593-1119

 **A&D INSTRUMENTS LIMITED**

Unit 24/26 Blacklands Way, Abingdon Business Park, Abingdon, Oxfordshire OX14 1DY United Kingdom
Telephone: [44] (1235) 550420 Fax: [44] (1235) 550485

A&D ENGINEERING, INC.

1756 Automation Parkway, San Jose, California 95131, U.S.A.
Telephone: [1] (408) 263-5333 Fax: [1] (408)263-0119

A&D AUSTRALASIA PTY LTD

32 Dew Street, Thebarton, South Australia 5031, AUSTRALIA
Telephone: [61] (8) 8301-8100 Fax: [61] (8) 8352-7409

ООО A&D RUS

ООО "ЭЙ энд ДИ РУС"

121357, Российская Федерация, г.Москва, ул. Верейская, дом 17
(Business-Center "Vereyskaya Plaza-2" 121357, Russian Federation, Moscow, Vereyskaya Street 17)
тел.: [7] (495) 937-33-44 факс: [7] (495) 937-55-66

A&D Technology Trading(Shanghai) Co. Ltd

爱安德技研贸易(上海)有限公司

中国 上海市浦东新区浦东大道138号永华大厦21楼A室 邮编200120
(21F Room A, Majesty Building, No.138 Pudong Avenue, Pudong New Area, Shanghai, 200120, China)
电话: [86] (21) 3393-2340 传真: [86] (21) 3393-2347