

INSTALLATION AND SERVICE MANUAL gas-fired weatherproof duct furnaces models HFG & HFP

Model HFG



FOR YOUR SAFETY

IF YOU SMELL GAS:

1. Don't touch electrical switches.
2. Extinguish any open flame.
3. Immediately call your gas supplier.

Model HFP



FOR YOUR SAFETY

The use and storage of gasoline or other flammable vapors and liquids in open containers in the vicinity of this appliance is hazardous.

IMPORTANT

The use of this manual is specifically intended for a qualified installation and service agency. A qualified installation and service agency must perform all installation and service of these appliances.

⚠ WARNING

Improper installation, adjustment, alteration, service or maintenance can cause property damage, injury or death, and could cause exposure to substances which have been determined by various state agencies to cause cancer, birth defects or other reproductive harm. Read the installation, operating and maintenance instructions thoroughly before installing or servicing this equipment.

Inspection on Arrival

1. Inspect unit upon arrival. In case of damage, report it immediately to transportation company and your local factory sales representative.
2. Check rating plate on unit to verify that power supply meets available electric power at the point of installation.
3. Inspect unit upon arrival for conformance with description of product ordered (including specifications where applicable).

SPECIAL PRECAUTIONS / TABLE OF CONTENTS

SPECIAL PRECAUTIONS

THE INSTALLATION AND MAINTENANCE INSTRUCTIONS IN THIS MANUAL MUST BE FOLLOWED TO PROVIDE SAFE, EFFICIENT AND TROUBLE-FREE OPERATION. IN ADDITION, PARTICULAR CARE MUST BE EXERCISED REGARDING THE SPECIAL PRECAUTIONS LISTED BELOW. FAILURE TO PROPERLY ADDRESS THESE CRITICAL AREAS COULD RESULT IN PROPERTY DAMAGE OR LOSS, PERSONAL INJURY, OR DEATH. THESE INSTRUCTIONS ARE SUBJECT TO ANY MORE RESTRICTIVE LOCAL OR NATIONAL CODES.

HAZARD INTENSITY LEVELS

1. **DANGER:** Indicates an imminently hazardous situation which, if not avoided, WILL result in death or serious injury.
2. **WARNING:** Indicates a potentially hazardous situation which, if not avoided, COULD result in death or serious injury.
3. **CAUTION:** Indicates a potentially hazardous situation which, if not avoided, MAY result in minor or moderate injury.
4. **IMPORTANT:** Indicates a situation which, if not avoided, MAY result in a potential safety concern.



DANGER

Appliances must not be installed where they may be exposed to a potentially explosive or flammable atmosphere.



WARNING

1. All field gas piping must be pressure/leak tested prior to operation. Never use an open flame. Use a soap solution or equivalent for testing.
2. Gas pressure to appliance controls must never exceed 14" W.C. (1/2 psi).
3. To reduce the opportunity for condensation, the minimum sea level input to the appliance, as indicated on the serial plate, must not be less than 5% below the rated input, or 5% below the minimum rated input of dual rated units.
4. Disconnect power supply before making wiring connections to prevent electrical shock and equipment damage.
5. All appliances must be wired strictly in accordance with wiring diagram furnished with the appliance. Any wiring different from the wiring diagram could result in a hazard to persons and property.
6. Any original factory wiring that requires replacement must be replaced with wiring material having a temperature rating of at least 105°C.
7. Ensure that the supply voltage to the appliance, as indicated on the serial plate, is not 5% greater than rated voltage.
8. When servicing or repairing this equipment, use only factory-approved service replacement parts. A complete replacement parts list may be obtained by contacting Modine Manufacturing Company. Refer to the rating plate on the appliance for complete appliance model number, serial number, and company address. Any substitution of parts or controls not approved by the factory will be at the owner's risk.



CAUTION

1. Appliances are designed for outdoor installation only. DO NOT LOCATE APPLIANCES INDOORS.
2. Purging of air from gas supply line should be performed as described in ANSI Z223.1 - latest edition "National Fuel Gas Code", or in Canada in CAN/CGA-B149 codes.
3. Do not reuse any mechanical or electrical component which has been wet. Such component must be replaced.

IMPORTANT

1. To prevent premature heat exchanger failure, do not locate ANY gas-fired appliances in areas where corrosive vapors (i.e. chlorinated, halogenated or acid) are present in the atmosphere.
2. To prevent premature heat exchanger failure, observe heat exchanger tubes by looking at the heat exchanger through field installed access openings in connecting ductwork. If the bottom of the tubes become red while blower and duct furnace are in operation, additional baffles must be inserted between blower and duct furnace to assure uniform air flow across the heat exchanger.
3. To prevent premature heat exchanger failure, the input to the appliance, as indicated on the serial plate, must not exceed the rated input by more than 5%.
4. To prevent premature heat exchanger failure, with all control systems, a blower starting mechanism must be provided so that the blower is running or energized within 45 seconds of the gas control operation.
5. Start-up and adjustment procedures should be performed by a qualified service agency.
6. To check most of the Possible Remedies in the troubleshooting guide listed in Table 20.1, refer to the applicable sections of the manual.

Table of Contents

Inspection on Arrival	1
General Information/Installation Codes	1
Special Precautions.....	2
SI (Metric) Conversion Factors.....	3
Unit Location.....	3
Location Recommendations.....	3
Combustible Material and Service Clearances	3
Unit Lifting.....	4
Installation	4
Direction of Airflow.....	4
Duct Installation.....	4
Airflow Distribution.....	4
Venting	5
Gas Connections.....	5
Electrical Connections.....	7
Start-Up Procedure.....	7
Pilot Burner Adjustment.....	8
Main Burner Adjustment	8
Air Shutter Adjustment.....	9
Control Operating Sequence.....	10
Variable Air Movement Applications	11
Gas Control Options.....	12
Dimensional Data	13-14
Performance	15
Air Temperature and External Static Pressure Limits.....	15
Pressure Drop Curves	16-17
Maintenance	18
Manifold Assembly Removal	18
Burner and Pilot Assembly Removal	18
Service & Troubleshooting.....	20-21
Automatic Reset High Limit.....	20
Replacement Parts Ordering	22
Serial Plate Location	22
Model Identification.....	23
Warranty	24

SI (METRIC) CONVERSION FACTORS / UNIT LOCATION

SI (METRIC) CONVERSION FACTORS

Table 3.1

To Convert	Multiply By	To Obtain
"W.C. (inches water column)	0.24	kPa
psig	6.893	kpa
°F	subtract 32 and then multiply by 0.555	°C
inches	25.4	mm
feet	0.305	meters
CFM	0.028	m ³ /min
CFH	1.699	m ³ /min
btu/ft ³	0.0374	mJ/m ³
pound	0.453	kg
btu/hr	0.000293	kW/hr
gallons	3.785	liters

UNIT LOCATION



DANGER

Appliances must not be installed where they may be exposed to a potentially explosive or flammable atmosphere.



CAUTION

Appliances are designed for outdoor installation only. DO NOT LOCATE APPLIANCES INDOORS.

IMPORTANT

To prevent premature heat exchanger failure, do not locate ANY gas-fired appliances in areas where corrosive vapors (i.e. chlorinated, halogenated or acid) are present in the atmosphere.

Location Recommendations

- When locating the furnace, consider general space and heating requirements and availability of gas and electrical supply.
- Unit must be installed on the positive pressure side of the circulating blower.
- Be sure the structural support at the unit location site is adequate to support the weight of the unit. For proper operation the unit must be installed in a level horizontal position.
- Do not install units in locations where the flue products can be drawn into the adjacent building openings such as windows, fresh air intakes, etc.
- Be sure that the minimum clearances to combustible materials and recommended service clearances are maintained. For HFG units, be sure clearances are maintained to the combustion air/vent cap. For HFP units, be sure clearances are maintained to the combustion air inlet louvers and power exhaustor discharge cover. Units are designed for installation on non-combustible surfaces or combustible surfaces with the minimum clearances shown in Figure 3.1, Table 3.2, and Table 3.3.

Figure 3.1
Combustible Material and Service Clearances

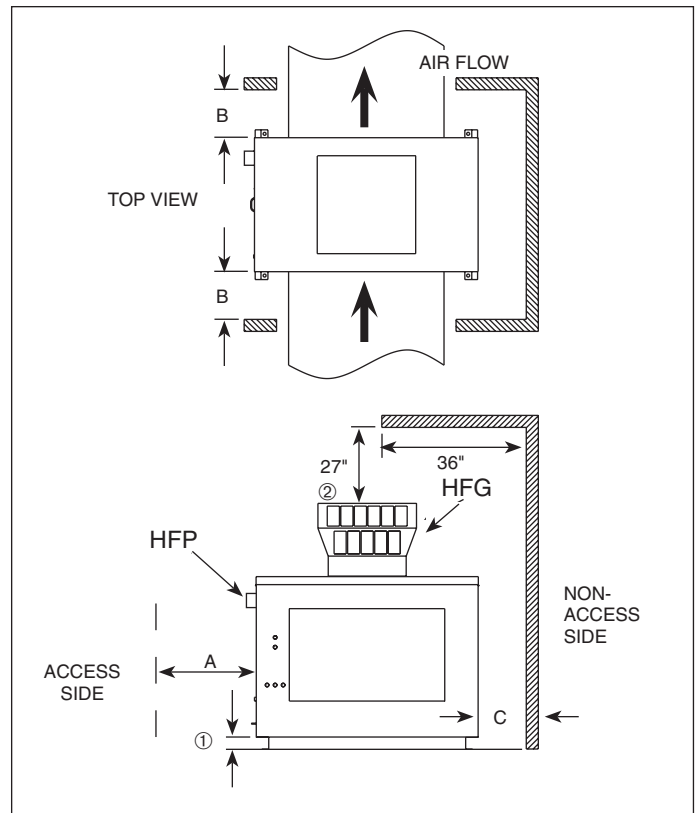

① Minimum clearance to combustibles is 0.0" from bottom of unit mounting rail or 3" from bottom of sheet metal of unit casing.

② Minimum clearance to combustible for HFP is 1.0" from rooftop.

Table 3.2
Combustible Material Clearances

Model Size	Clearance to Combustible Materials				
	Front & Rear (B) HFG	Front & Rear (B) HFP	Non-Access Side (C) HFG/HFP	Access Side (A)	
				HFG	HFP
75	0"	3"	0"	0"	3"
100/125	0"	3"	0"	0"	3"
150/175	3"	3"	0"	0"	3"
200/225	4"	4"	0"	0"	3"
250/300	5"	5"	0"	0"	3"
350/400	11"	11"	0"	0"	3"

Table 3.3
Service Clearances

Model Size	Recommended Service Clearance	
	Access Side (A)	Non-Access Side (C)
75	18"	6"
100/125	20"	6"
150/175	25"	6"
200/225	27"	6"
250/300	30"	6"
350/400	41"	6"

UNIT LIFTING / INSTALLATION

UNIT LIFTING

Lifting holes are provided in the mounting rails of the duct furnace. When lifting the unit, use spreader bars between the lifting cables as shown in Figure 4.1 to insure that no damage will occur to the sheet metal parts of the duct furnace.

Figure 4.1 - Unit Lifting



INSTALLATION

Direction of Airflow

Select proper direction of airflow. If the unit is not provided with an air distribution baffle (Not provided on models in which the 10th digit of the model number is an "L" for Low Temperature Rise), the airflow direction is fully reversible without modification to the duct furnace. See Airflow Reversal Note.

If the unit is provided with an air distribution baffle (Provided on models in which the 10th digit of the model number is an "H" for High Temperature Rise), the air baffle must face the air inlet direction as shown in Figure 4.2. If it is necessary to reverse the airflow direction, remove the four screws securing the air distribution baffle, reverse the air distribution baffle to the air inlet side and replace the screws. See Airflow Reversal Note.

Figure 4.2 - Air Distribution Baffle Location

Baffle location shown on entering air side of duct furnace.

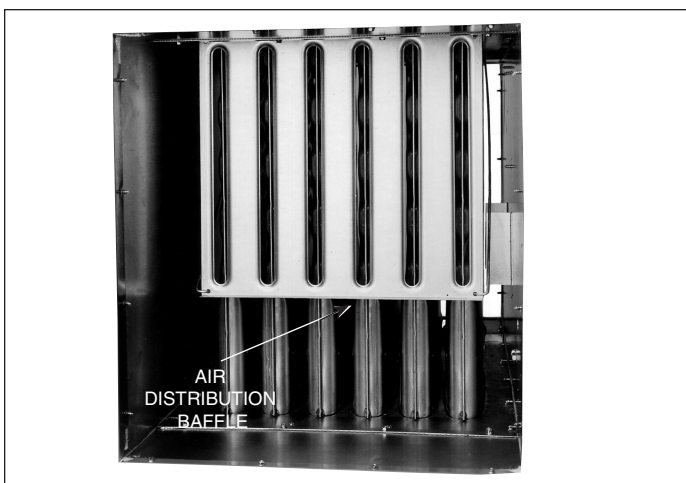

Airflow Reversal Note: If factory installed discharge air options (thermostat, freeze protection, etc.) were provided, these options would have to be relocated to the discharge air side of the duct furnace.

Duct Installation

1. The furnace is designed to accept 90° flanged ductwork. See Figure 4.3. Provide an airtight seal between the ductwork and the furnace. Seams with cracks in ductwork should be caulked and/or taped and be of permanent type. All duct connections **MUST** be weathertight to prevent rain and snow from entering the ductwork.
2. Provide removable access panels on both the upstream and downstream sides of the ductwork; see Figure 4.3. These openings should be large enough to view smoke or reflect light inside the casing to indicate leaks in the heat exchanger and to check for hot spots on heat exchangers due to poor air distribution or lack of sufficient air (CFM).

Figure 4.3 - Duct Connections

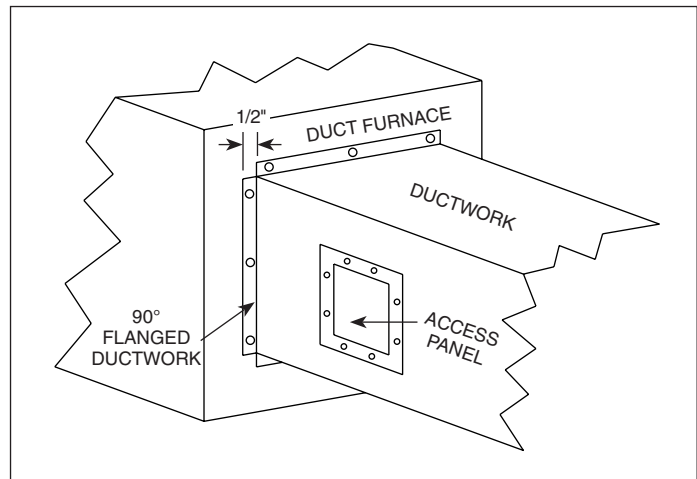

Airflow Distribution

IMPORTANT

To prevent premature heat exchanger failure, observe heat exchanger tubes by looking at the heat exchanger through field installed access openings in connecting ductwork. If the bottom of the tubes become red while blower and duct furnace are in operation, additional baffles must be inserted between blower and duct furnace to assure uniform air flow across the heat exchanger.

1. Provide uniform air distribution over the heat exchanger. Use turning vanes where required (see Figure 5.1) to obtain uniform air distribution. Avoid installing as in "G", "H" & "J" of Figure 5.1.
2. A bottom, horizontal discharge type blower should be installed at least 12" from the furnace (See "A", Figure 5.1).
3. A top, horizontal discharge type blower should be installed at least 24" from the furnace (See "B", Figure 5.1). Provide air baffle at top of duct to deflect air down to the bottom of heat exchanger.

INSTALLATION

Figure 5.1 - Typical Duct & Airflow Installation

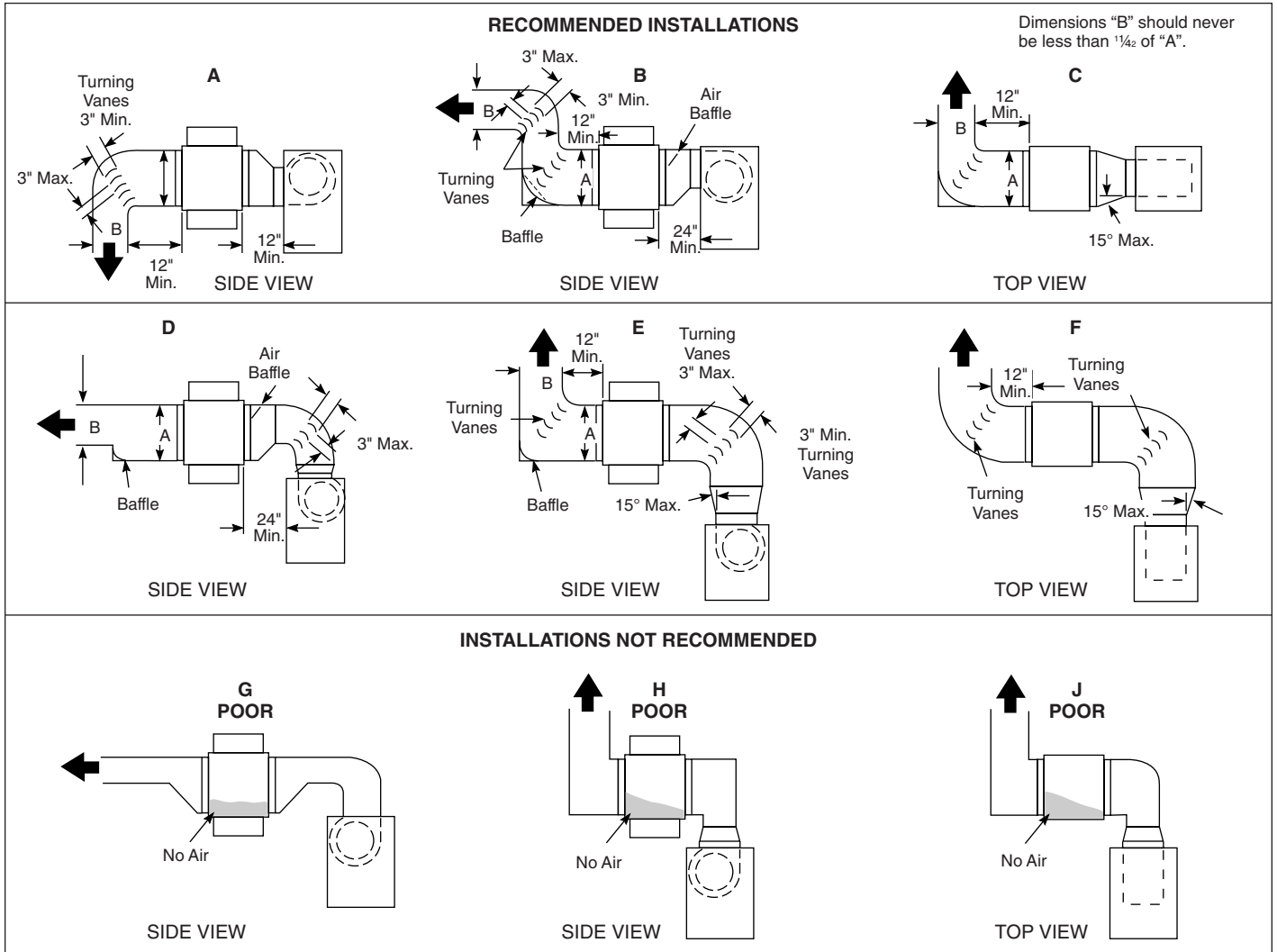

Venting

1. Installation of venting must conform with local building codes, or in the absence of local codes, with the National Fuel Gas Code, ANSI Z223.1 (NFPA 54) - Latest Edition. In Canada, installation must be in accordance with CAN/CGA-B149.1 for natural gas units and CAN/CGA-B149.2 for propane units.
2. For HFG units, do not operate duct furnaces without the factory supplied vent cap (shipped loose) fastened securely in place. HFP units are shipped with the power exhauster discharge cover factory installed.
3. For HFG units, do not modify or obstruct the vent cap in any manner. For HFP units, do not modify or obstruct the combustion air inlet louvers or the power exhauster discharge cover.
4. Do not add any vents other than those supplied by the manufacturer.

Gas Connections



WARNING

1. All field gas piping must be pressure/leak tested prior to operation. Never use an open flame. Use a soap solution or equivalent for testing.
2. Gas pressure to appliance controls must never exceed 14" W.C. (1/2 psi).
3. To reduce the opportunity for condensation, the minimum sea level input to the appliance, as indicated on the serial plate, must not be less than 5% below the rated input, or 5% below the minimum rated input of dual rated units.



CAUTION

Purging of air from gas supply line should be performed as described in ANSI Z223.1 - latest edition "National Fuel Gas Code", or in Canada in CAN/CGA-B149 codes.

IMPORTANT

To prevent premature heat exchanger failure, the input to the appliance, as indicated on the serial plate, must not exceed the rated input by more than 5%.

INSTALLATION

Gas Connections (continued)

1. Installation of piping must conform with local building codes, or in the absence of local codes, with the National Fuel Gas Code, ANSI Z223.1 (NFPA 54) - Latest Edition. In Canada, installation must be in accordance with CAN/CGA-B149.1 for natural gas units and CAN/CGA-B149.2 for propane units.
2. Piping to units should conform with local and national requirements for type and volume of gas handled, and pressure drop allowed in the line. Refer to Table 9.1 to determine the cubic feet per hour (cfh) for the type of gas and size of unit to be installed. Using this cfh value and the length of pipe necessary, determine the pipe diameter from Table 6.1. Where several units are served by the same main, the total capacity, cfh and length of main must be considered. Avoid pipe sizes smaller than 1/2". Table 6.1 allows for a 0.3" W.C. pressure drop in the supply pressure from the building main to the unit. The inlet pressure to the unit must be 6-7" W.C. for natural gas and 11-14" W.C. for propane gas. When sizing the inlet gas pipe diameter, make sure that the unit supply pressure can be met after the 0.3" W.C. has been subtracted. If the 0.3" W.C. pressure drop is too high, refer to the Gas Engineer's Handbook for other gas pipe capacities.
3. The gas piping to the unit can enter the unit from the side of the unit or from below (curb mounted units). Drill locator dimples are located in the side and bottom of the unit for field drilling the hole for the gas pipe entry.

For side piped units

Install a ground joint union with brass seat and a manual shut-off valve external of the unit casing, and adjacent to the unit for emergency shut-off and easy servicing of controls, including a 1/8" NPT plugged tapping accessible for test gauge connection (See Figure 6.1).

For bottom piped units

Install a ground joint union with brass seat and a manual shut-off valve internal to the unit casing for easy servicing of controls, including a 1/8" NPT plugged tapping accessible for test gauge connection (See Figure 6.2). **NOTE:** Some local codes may require a manual shut-off valve external to the unit casing. In this case, the gas piping must exit the unit through a side piping hole, followed by the manual shut-off valve, piped back into the unit corner post, through the unit bottom, and lead to an additional union and manual shut-off valve.

4. Provide a sediment trap before each unit in the line where low spots cannot be avoided. (See Figures 6.1 & 6.2).

5. When Pressure/Leak testing, pressures above 14" W.C. (1/2 psi), close the field installed shut-off valve, disconnect the appliance and its combination gas control from the gas supply line, and plug the supply line before testing. When testing pressures 14" W.C. (1/2 psi) or below, close the manual shut-off valve on the appliance before testing.

Figure 6.1
Recommended Sediment Trap/Manual Shut-off Valve Installation - Side Gas Connection

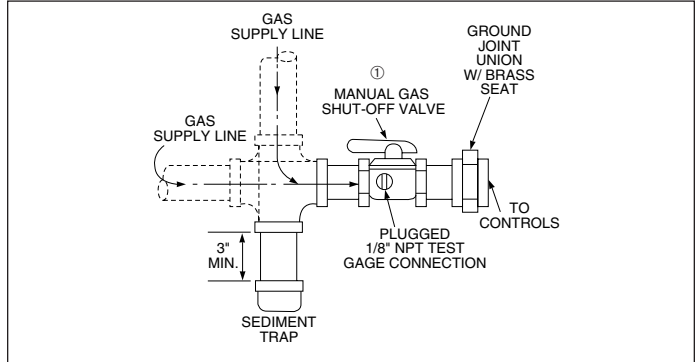
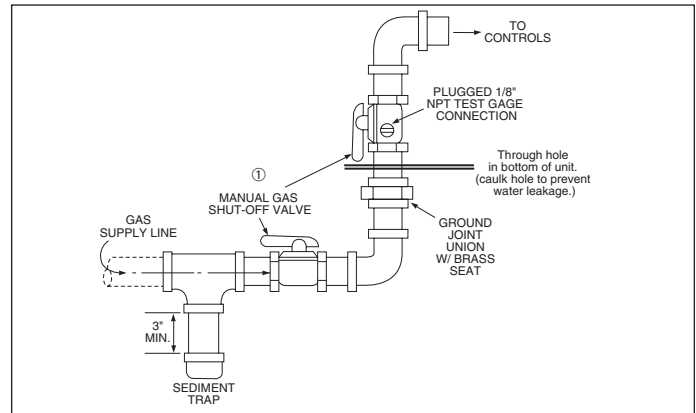

Figure 6.2
Recommended Sediment Trap/Manual Shut-off Valve Installation - Bottom Gas Connection



① Manual shut-off valve is in the "OFF" position when handle is perpendicular to pipe.

Table 6.1 - Gas Pipe Capacities

Gas Pipe Capacities (Up to 14" W.C. Gas Pressure through Schedule 40 Pipe) Cubic Feet per Hour with Pressure Drop of 0.3" W.C. Natural Gas - Specific Gravity - 0.60 Propane Gas - Specific Gravity - 1.50												
Length Of Pipe (feet)	Pipe Diameter											
	1/2"		3/4"		1"		1-1/4"		1-1/2"		2"	
	Natural	Propane	Natural	Propane	Natural	Propane	Natural	Propane	Natural	Propane	Natural	Propane
10	132	83	278	175	520	328	1050	662	1600	1008	3050	1922
20	92	58	190	120	350	221	730	460	1100	693	2100	1323
30	73	46	152	96	285	180	590	372	890	561	1650	1040
40	63	40	130	82	245	154	500	315	760	479	1450	914
50	56	35	115	72	215	135	440	277	670	422	1270	800
60	50	32	105	66	195	123	400	252	610	384	1150	725
70	46	29	96	60	180	113	370	233	560	353	1050	662
80	43	27	90	57	170	107	350	221	530	334	990	624
90	40	25	84	53	160	101	320	202	490	309	930	586
100	38	24	79	50	150	95	305	192	460	290	870	548
125	34	21	72	45	130	82	275	173	410	258	780	491
150	31	20	64	40	120	76	250	158	380	239	710	447

INSTALLATION / START-UP PROCEDURE

Electrical Connections

WARNING

1. Disconnect power supply before making wiring connections to prevent electrical shock and equipment damage.
2. All appliances must be wired strictly in accordance with wiring diagram furnished with the appliance. Any wiring different from the wiring diagram could result in a hazard to persons and property.
3. Any original factory wiring that requires replacement must be replaced with wiring material having a temperature rating of at least 105°C.
4. Ensure that the supply voltage to the appliance, as indicated on the serial plate, is not 5% greater than rated voltage.

1. Installation of wiring must conform with local building codes, or in the absence of local codes, with the National Electric Code ANSI/NFPA 70 - Latest Edition. Unit must be electrically grounded in conformance to this code. In Canada, wiring must comply with CSA C22.1, Part 1, Electrical Code.
2. All duct furnaces are provided with a wiring diagram located on the inside door of the electrical junction box. Refer to this wiring diagram for all wiring connections. For factory installed options and field installed accessory wiring, refer to Set A and Set B on the provided wiring diagram.
3. The power supply to the duct furnace should be protected with a fused disconnect switch.
4. Refer to Table 7.1 to determine the amp draw of the duct furnace. Size the disconnect switch to cover the amp draw of the unit.
5. Refer to the unit dimensional drawings on pages 13 and 14 for the location of the drill locator dimples in the side and bottom of the unit for field drilling the hole for the electrical conduit entry.

Table 7.1 - Unit Amps

Base Model (Digits 1-6)	Supply Voltage (Digit 14)	Transformer (Digit 15)				
		1	2	3	4	0
HFG (All)	A	0.35	0.65	1.30	2.17	0.00
	B or D	0.19	0.36	0.72	1.20	0.00
	C or E	0.17	0.33	0.65	1.09	0.00
	F	0.09	0.16	0.33	0.54	0.00
	G	0.07	0.13	0.26	0.43	0.00
HFP 75-175	A	1.75	2.05	2.70	3.57	1.40
	B or D	0.89	1.06	1.42	1.90	0.70
	C or E	0.83	0.99	1.31	1.75	0.66
	F	0.63 ^①	1.25 ^②	2.50 ^③	2.72 ^③	0.00 ^④
	G	0.50 ^①	1.00 ^②	2.00 ^③	2.17 ^③	0.00 ^④
HFP 200-400	A	2.35	2.65	3.30	4.17	2.00
	B or D	1.14	1.31	1.67	2.15	0.95
	C or E	1.27	1.43	1.75	2.19	1.10
	F	0.63 ^①	1.25 ^②	2.50 ^③	2.72 ^③	0.00 ^④
	G	0.50 ^①	1.00 ^②	2.00 ^③	2.17 ^③	0.00 ^④

① Includes a field supplied 250 VA step down transformer from supply voltage to 115V.
 ② Includes a field supplied 500 VA step down transformer from supply voltage to 115V.
 ③ Includes a field supplied 1000 VA step down transformer from supply voltage to 115V.
 ④ Unit amp draw is included in master unit amp draw.

IMPORTANT

Start-up and adjustment procedures should be performed by a qualified service agency.

1. Turn off power to the unit at the disconnect switch. Check that fuses or circuit breakers are in place and sized correctly. Turn all hand gas valves to the "OFF" position.
2. Check that the supply voltage matches the unit supply voltage listed on the serial plate. Verify that all wiring is secure and properly protected. Trace circuits to insure that the unit has been wired according to the wiring diagram.
3. Check that all electrical and gas connections are weatherized.
4. For HFG units, check to insure that the vent cap is installed and free from obstructions. For HFP units, check to insure that the combustion air inlet louvers and the power exhauster discharge cover is free from obstructions/damage.
5. Check to see that there are no obstructions to the intake and discharge of the duct furnace.
6. Perform a visual inspection of the unit to make sure no damage has occurred during installation.
7. Turn on power to the unit at the disconnect switch. Check to insure that the voltage between terminals 1 and 2 is 24V.
8. Check the thermostat, ignition control, gas valve, and supply fan blower motor for electrical operation. If these do not function, recheck the wiring diagram. Check to insure that none of the Gas Control Options & Accessories (see page 12) have tripped.
9. Recheck the gas supply pressure at the field installed manual-shut-off valve. The inlet pressure should be 6" - 7" W.C. on natural gas or 11" - 14" W.C. on propane. If inlet pressure is too high, install an additional pressure regulator upstream of the combination gas control.
10. Open the field installed manual gas shut-off valve.
11. Open the manual main gas valve on the combination gas control. Call for heat with the thermostat and allow the pilot to light. (For HFP units, on a call for heat the power exhauster relay will energize the power exhauster motor. Once the power exhauster motor reaches full speed, a centrifugal switch in the motor will close before the pilot can light.) If the pilot does not light, purge the pilot line. If air purging is required, disconnect the pilot line at outlet of pilot valve. In no case should line be purged into heat exchanger. Check the pilot flame length (See Pilot Burner Adjustment).
12. Once the pilot has been established, check to make sure that the main gas valve opens. Check the manifold gas pressure (See Main Burner Adjustment) and flame length (See Air Shutter Adjustment) while the circulating air blower is operating.
13. Check to insure that gas controls sequence properly (See Control Operating Sequence). Verify if the unit has any additional control devices and set according to the instructions in the Gas Controls Options.
14. Once proper operation of the duct furnace has been verified, remove any jumper wires that were required for testing.
15. Close the electrical compartment door.
16. Replace all exterior panels.

START-UP PROCEDURE

Pilot Burner Adjustment

The pilot burner is orificed to burn properly with an inlet pressure of 6-7" W.C. on natural gas and 11-14" W.C. on propane gas, but final adjustment must be made after installation. If the pilot flame is too long or large, it is possible that it may cause soot and/or impinge on the heat exchanger causing failure. If the pilot flame is shorter than shown, it may cause poor ignition and result in the controls not opening the combination gas control. A short flame can be caused by a dirty pilot orifice. Pilot flame condition should be observed periodically to assure trouble-free operation.

To Adjust the Pilot Flame

1. Create a call for heat from the thermostat.
2. Remove the cap from the pilot adjustment screw. For location, see the combination gas control literature supplied with unit.
3. Adjust the pilot length by turning the screw in or out to achieve a soft steady flame 3/4" to 1" long and encompassing 3/8"-1/2" of the tip of the thermocouple or flame sensing rod (See Figure 8.1).
4. Replace the cap from the pilot adjustment screw.

Figure 8.1 - Correct Pilot Flame

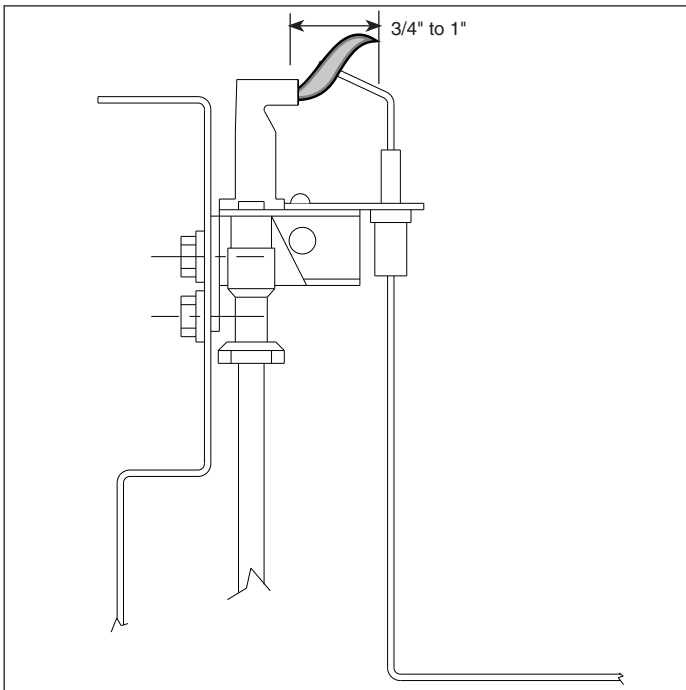

Main Burner Adjustment

The gas pressure regulator (integral to the combination gas control) is adjusted at the factory for average gas conditions. It is important that gas be supplied to the duct furnace in accordance with the input rating on the serial plate. Actual input should be checked and necessary adjustments made after the duct furnace is installed. Over-firing, a result of too high an input, reduces the life of the appliance and increases maintenance. Under no circumstances should the input exceed that shown on the serial plate.

Measuring the manifold pressure is done at the tee in the manifold (See Figure 9.1).

To Adjust the Manifold Pressure

1. Move the field installed manual shut-off valve to the "OFF" position.
2. Remove the 1/8" pipe plug in the pipe tee and attach a water manometer of "U" tube type which is at least 12" high.
3. Move the field installed manual gas shut-off valve to the "ON" position.
4. Create a high fire call for heat from the thermostat.
5. Determine the correct high fire manifold pressure. For natural gas 3.5" W.C., for propane gas 10" W.C. Adjust the main gas pressure regulator spring to achieve the proper manifold pressure (for location, see the combination gas control literature supplied with unit).
6. If the unit has Electronic Modulation gas controls (determine from the Model Identification Digit 12), the low fire gas pressure needs to be adjusted. Using Figure 9.2 for item number locations, this is accomplished as follows:
 - a. Disconnect power.
 - b. Remove all wires from duct furnace terminal "43" and remove cover plate (2).
 - c. Turn on power at the disconnect switch.
 - d. Remove the maximum adjustment screw (4), spring (5), and plunger (8). A small magnet is useful for this purpose. CAUTION - The plunger is a precision part. Handle carefully to avoid marring or picking up grease and dirt. Do not lubricate.
 - e. Using minimum adjusting screw (9), adjust low fire manifold pressure to 0.56" W.C. for natural gas and 1.6" W.C. for propane gas.
 - f. Replace plunger and spring retainer, spring, and maximum adjusting screw in proper order.
 - g. Using maximum adjustment screw (4), adjust high fire manifold pressure to 3.5" W.C. for natural gas and 10" W.C. for propane gas.
 - h. Disconnect power.
 - i. Replace cover plate (2) and re-install all wires from duct furnace terminal "43".
7. After adjustment, move the field installed manual shut-off valve to the "OFF" position and replace the 1/8" pipe plug.
8. After the plug is in place, move the field installed manual shut-off valve to the "ON" position and recheck pipe plugs for gas leaks with soap solution.

START-UP PROCEDURE

Figure 9.1
Checking Manifold Pressure with “U” Tube Manometer



Figure 9.2
Maxitrol Modulating Valve Adjustments

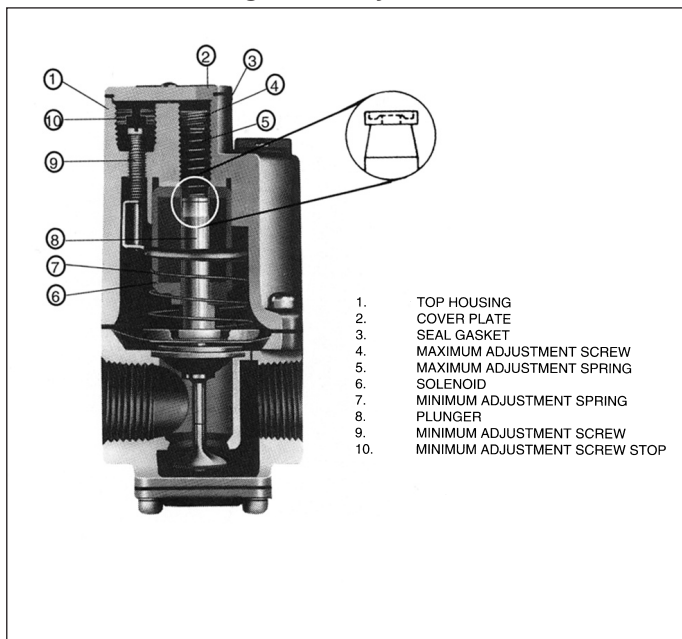

Air Shutter Adjustment

Proper operation provides a soft blue flame with a well-defined inner core. A lack of primary air will reveal soft yellow-tipped flames. Excess primary air produces short, well-defined flames with a tendency to lift off the burner ports. For both natural and propane gas, the air shutters can be adjusted to control the burner flame height. The air shutters can be accessed by reaching behind the manifold tee shown in Figure 9.1. The larger models may require the removal of the manifold (see Manifold Assembly Removal).

Natural Gas Flame Control

Control of burner flames on duct furnaces utilizing natural gas is achieved by resetting the primary air shutters (See Figure 19.1) to either increase or decrease primary combustion air. Prior to flame adjustment, operate duct furnace for about fifteen minutes. The main burner flame can be viewed after loosening and pushing aside the gas designation disc on the side of the burner box.

To increase primary air, loosen the air shutter set screws and move the air shutters closer to the manifold until the yellow-tipped flames disappear. (See Figure 19.1 for air shutter and heat exchanger support locations.) To decrease primary air, move the air shutters away from the manifolds until flames no longer lift from burner ports, but being careful not to cause yellow tipping. Retighten set screws after adjustment.

Propane Gas Flame Control

An optimum flame will show a slight yellow tip. Prior to flame adjustment, operate furnace for at least fifteen minutes. Loosen air shutter set screws and move the air shutters away from the manifold to reduce the primary air until the yellow flame tips appear. Then increase the primary air until yellow tips diminish and a clean blue flame with a well defined inner cone appears.

Table 9.1
Manifold Pressure and Gas Consumption

Model Size	Type of Gas	Natural	Propane	No. of Orifices
	Btu/Cu. Ft.	1040	2500	
	Specific Gravity	0.60	1.53	
High Fire Manifold Pressure		3.5	10	
Inches of Water Column				
75	Cfh	72.1	30.0	1
	Orifice Drill Size	20	37	
100	Cfh	96.1	40.0	2
	Orifice Drill Size	30	45	
125	Cfh	120.2	50.0	2
	Orifice Drill Size	25	42	
150	Cfh	144.2	60.0	3
	Orifice Drill Size	30	45	
175	Cfh	168.3	70.0	3
	Orifice Drill Size	27	43	
200	Cfh	192.3	80.0	3
	Orifice Drill Size	23	40	
225	Cfh	216.3	90.0	3
	Orifice Drill Size	20	37	
250	Cfh	240.4	100.0	4
	Orifice Drill Size	25	42	
300	Cfh	288.7	120.0	4
	Orifice Drill Size	20	37	
350	Cfh	336.5	140.0	6
	Orifice Drill Size	27	43	
400	Cfh	384.6	160.0	6
	Orifice Drill Size	23	40	

START-UP PROCEDURE

IMPORTANT

To prevent premature heat exchanger failure, with all control systems, a blower starting mechanism must be provided so that the blower is running or energized within 45 seconds of the gas control operation.

Control Operating Sequence

All Modine weatherproof duct furnaces are supplied with intermittent pilot ignition systems. These systems are offered with 100% shut-off with continuous retry for operation on natural gas and 100% shut-off with lockout for units operating on propane gas. On all systems, both the main burner and pilot burner are turned off 100% when the thermostat is satisfied.

For natural gas units, the ignition controller is 100% shut-off with continuous retry. On a call for heat, the system will attempt to light the pilot for 70 seconds. If the pilot is not sensed for any reason, the ignition control will wait for approximately six minutes with the combination gas control closed and no spark. After six minutes, the cycle will begin again. After three cycles, some ignition controllers lockout for approximately one hour before the cycle begins again. This will continue indefinitely until the pilot flame is sensed or power is interrupted to the system.

For propane gas units, the ignition controller is 100% shut-off with lockout. On a call for heat, the system will attempt to light the pilot for 70 seconds. If the pilot is not sensed for any reason, the ignition control will lockout, the pilot gas valve shut off and the sparking discontinued. The system will not attempt to relight until power has been interrupted to the controls and the controls are reset via the thermostat.

NOTE: Gas Control Options (see page 12) could change the listed sequence of operation based on their function. The descriptions given are for the basic duct furnace.

Single-Stage Gas Controls

Utilizes a single-stage combination gas control, an ignition control, and a single-stage low voltage thermostat.

1. The thermostat calls for heat. For HFP units, see ①.
2. The pilot valve opens and the spark ignitor sparks in an attempt to light the pilot. (If the unit was not provided with a time delay relay, the blower starts at this time.)
3. Once the pilot is lit, the flame sensor proves the pilot and stops the spark ignitor from sparking.
4. The main gas valve is opened and the main burner is lit to 100% full fire.
5. If the unit was provided with a time delay relay, the blower starts after 30 to 45 seconds.
6. The unit continues to operate until the thermostat is satisfied, at which time both the main and pilot valves close 100%. (If the unit was not provided with a time delay relay, the blower stops at this time.)
7. If the unit was provided with a time delay relay, the blower stops after 30 to 45 seconds.

Two-Stage Gas Controls

Utilizes a two-stage combination gas control, an ignition control, and a two-stage low voltage thermostat. The unit fires at 50% fire on low stage and 100% fire on high stage.

1. The thermostat calls for low stage heat. For HFP units, see ①.
2. The pilot valve opens and the spark ignitor sparks in an attempt to light the pilot. (If the unit was not provided with a time delay relay, the blower starts at this time.)
3. Once the pilot is lit, the flame sensor proves the pilot and stops the spark ignitor from sparking.
4. The main gas valve is opened and the main burner is lit to 50% fire.

5. If the unit was provided with a time delay relay, the blower starts after 30 to 45 seconds.
6. If the temperature at the thermostat continues to fall, the thermostat will call for high stage heat.
7. The main gas valve is opened completely and the main burner is lit to 100% full fire.
8. The unit continues to operate until the high stage of the thermostat is satisfied, at which time the main valve closes to 50% fire.
9. The unit continues to operate until the low stage thermostat is satisfied, at which time both the main and pilot valves close 100%. (If the unit was not provided with a time delay relay, the blower stops at this time.)
10. If the unit was provided with a time delay relay, the blower stops after 30 to 45 seconds.

Electronic Modulating Gas Controls

Single Furnace

Utilizes an electronic modulating/regulating gas control, combination gas valve, an ignition control, modulating amplifier, and either a modulating room thermostat or modulating duct thermostat with remote temperature set point adjuster. The thermostat controls can modulate the gas flow between 40% through 100% full fire. When the thermostat is satisfied, the amplifier cuts power to the combination gas valve which prevents gas flow to both the main and pilot burners. When duct sensing is utilized, a room override thermostat can be added. When calling for heat, the room override thermostat provides full fire operation until the space temperature is satisfied. Control is then returned to the duct sensing control. In this situation, either the duct sensor or the room override thermostat can call for heat.

1. The thermostat calls for heat. For HFP units, see ①.
2. The pilot valve opens and the spark ignitor sparks in an attempt to light the pilot. (If the unit was not provided with a time delay relay, the blower starts at this time.)
3. Once the pilot is lit, the flame sensor proves the pilot and stops the spark ignitor from sparking.
4. The main gas valve is opened and the main burner is lit to 100% full fire.
5. If the unit was provided with a time delay relay, the blower starts after 30 to 45 seconds.
6. The modulating gas valve can be controlled by either an electronic modulating room or duct thermostat. The thermostat can modulate the firing rate between 40% through 100% full fire. The call for heat is created by a resistance signal (8000 to 12000 ohms) in the thermostat. The amplifier converts this resistance into a DC voltage (0 to 12 volts DC with 0 volts high fire and 12 volts low fire). The output voltage is applied to the modulating gas valve to control the gas flow to the main burner. As the temperature drops, the voltage drops causing the modulating valve to open further. If the discharge air temperature increases, the voltage increases causing the modulating valve to close allowing less gas flow to the main burner. For further information regarding the operation of the electronic modulating system, consult the literature provided with the unit.
7. The unit continues to operate in this manner until the thermostat is satisfied, at which time both the main and pilot valves close 100%. (If the unit was not provided with a time delay relay, the blower stops at this time.)
8. If the unit was provided with a time delay relay, the blower stops after 30 to 45 seconds.

① After the thermostat calls for heat, the power exhauster relay is energized starting the power exhauster motor. Once the motor has reached full speed, the power exhauster centrifugal switch closes energizing the gas control circuit.

START-UP PROCEDURE

Electronic Modulating Gas Controls - Master/Slave

One Master furnace is provided with up to three Slave furnaces that utilize electronic modulating/regulating gas controls, combination gas valves, ignition controls, one multiple furnace modulating amplifier, and either a modulating room thermostat or modulating duct thermostat with remote temperature adjuster. The thermostat controls can modulate the gas flow of all the furnaces between 40% through 100% full fire. The amplifier sends a signal to all of the gas valves so that they modulate at the same percentage. When the thermostat is satisfied, the amplifier cuts power to the combination gas valves which prevents gas flow to both the main and pilot burners.

When duct sensing is utilized, a room override thermostat can be added. When calling for heat, the room override thermostat provides full fire operation until the space temperature is satisfied. Control is then returned to the duct sensing control. In this situation, either the duct sensor or the room override thermostat can call for heat.

The sequence of operation for Electronic Modulating Gas Controls - Master/Slave is the same as Electronic Modulating Gas Controls - Single Furnace.

Electronic Modulating Gas Controls - Building Management Control (0-10Vdc or 4-20 mA Signal)

Utilizes an electronic modulating/regulating gas control, combination gas valve, an ignition control, modulating signal conditioner, and an inverted (0 Vdc or 4mA being high fire and 10 Vdc or 20 mA being low fire) 0-10Vdc or 4-20 mA input signal provided by a Building Management System (BMS). The signal conditioner can modulate the gas flow between 40% through 100% full fire. When the BMS thermostat (field supplied) is satisfied, the BMS heat contact (field supplied) opens to cut power to the combination gas valve which prevents gas flow to both the main and pilot burners.

1. The BMS thermostat (field supplied) calls for heat and closes the BMS heat contact (field supplied). For HFP units, see ①.
2. The pilot valve opens and the spark ignitor sparks in an attempt to light the pilot. (If the unit was not provided with a time delay relay, the blower starts at this time.)
3. Once the pilot is lit, the flame sensor proves the pilot and stops the spark ignitor from sparking.
4. The main gas valve is opened and the main burner is lit to 100% full fire.
5. If the unit was provided with a time delay relay, the blower starts after 30 to 45 seconds.
6. The modulating gas valve is controlled the BMS thermostat. The thermostat can modulate the firing rate between 40% through 100% full fire by modulating the input signal between either 0-10Vdc or 4-20 mA (The signal conditioner can accept a 0-10 Vdc signal when all the dip switches are in the "OFF" position and 4-20 mA signal when all the dip switches are in the "ON" position). The signal conditioner converts the input signal into a DC voltage (0 to 12 volts DC with 0 volts high fire and 12 volts low fire). The output voltage is applied to the modulating gas valve to control the gas flow to the main burner. As the temperature drops, the voltage drops causing the modulating valve to open further. If the discharge air temperature increases, the voltage increases causing the modulating valve to close allowing less gas flow to the main burner. For further information regarding the operation of the electronic modulating system, consult the literature provided with the unit.

7. The unit continues to operate in this manner until the thermostat is satisfied, at which time the BMS heat contact opens resulting in both the main and pilot valves closing 100%. (If the unit was not provided with a time delay relay, the blower stops at this time.)
8. If the unit was provided with a time delay relay, the blower stops after 30 to 45 seconds.

Variable Air Movement Applications

When the air mover supplied by others can provide variable air movement (i.e. 2-speed or variable frequency drive units), the allowable minimum CFM of the HFG/HFP duct furnace can be 66% of the minimum listed CFM in Table 15.2 if the unit is applied as follows:

1. The unit is provided with 2-stage, mechanical modulation, or electronic modulating gas controls. (see Model Identification).
2. The unit is provided with a factory installed discharge air controller.
3. The system does not include a room thermostat.

The factory installed discharge air thermostat will prevent the unit from firing above the allowable 100°F rise when the unit is at or above the minimum CFM by monitoring the discharge air and going to low fire. A room thermostat, because it is located remote from the unit, could cause the unit to over-fire.

① After the thermostat calls for heat, the power exhauster relay is energized starting the power exhauster motor. Once the motor has reached full speed, the power exhauster centrifugal switch closes energizing the gas control circuit.

START-UP PROCEDURE

Gas Control Options

The unit must be reviewed to determine if any of the listed gas control options were supplied.

① Time Delay Relay

The Time Delay Relay is factory installed in the duct furnace electrical junction box. The standard duct furnace is provided for instantaneous fan operation. On a call for heat, the blower is energized at the same time as the gas controls. The optional time delay relay allows the gas controls to operate for approximately 30 seconds before the blower starts. This allows the heat exchanger a warm up period so that the initial delivered air coming out of the ductwork is not cool. The time delay relay also keeps the motor running for approximately 30 seconds after the call for heat has been satisfied to remove the residual heat from the heat exchanger.

② Low Gas Pressure Switch

The low gas pressure switch is factory installed in the duct furnace above the gas train. The switch monitors the gas pressure upstream of all the gas controls and shuts off the electric supply to the ignition controller and combination gas valve if low gas pressure is experienced. This will shut off all gas flow to the burner. The switch has an automatic reset so that if the gas pressure is interrupted and then is returned, the switch will automatically allow the unit to operate when gas conditions are returned to the allowable range of the pressure switch. The pressure switch range is 2" to 14" W.C. and should be set to insure that the minimum inlet gas pressure is available (6" W.C. for natural gas, 11" W.C. for propane gas).

③ High Gas Pressure Switch

The high gas pressure switch is factory installed in the duct furnace above the gas train. The switch monitors the gas pressure downstream of all the gas controls and shuts off the electric supply to the ignition controller and combination gas valve if high gas pressure is experienced right before the manifold. This will shut off all gas flow to the burner. The switch has a manual reset so that if the gas pressure is too high, a service person must check the unit to make sure that none of the gas controls have been damaged by the high gas pressure and then reset the switch to allow the unit to operate when gas conditions are returned to the allowable range of the pressure switch. The pressure switch range is 2" to 16" W.C. and should be set to insure that the maximum manifold gas pressure is not exceeded (3.5" W.C. for natural gas, 10" W.C. for propane gas).

④ Supply Air Fire Stat

The fire stat is factory installed in the duct furnace electrical junction box with the sensor in the discharge air stream. In case of elevated temperatures in the supply air, the manual reset switch shuts down the entire unit. If the limit temperature is exceeded, a service person must inspect the unit for the cause of the high discharge temperature, take corrective action, and then reset the switch.

⑤ Timed Freeze Protection

The timed freeze protection system is factory installed in the duct furnace electrical junction box with the sensor (30°-75°F adjustable) factory installed in discharge air stream. On initial start-up, the timed delay in the system allows the unit to go through the normal ignition sequence. The timed delay is an automatic reset switch and adjustable for 1-10 minutes. In the event that the unit fails to fire after this period, the discharge air sensor will sense the cold air and will shut down the entire unit.

Figure 12.1 - Location of Gas Control Options

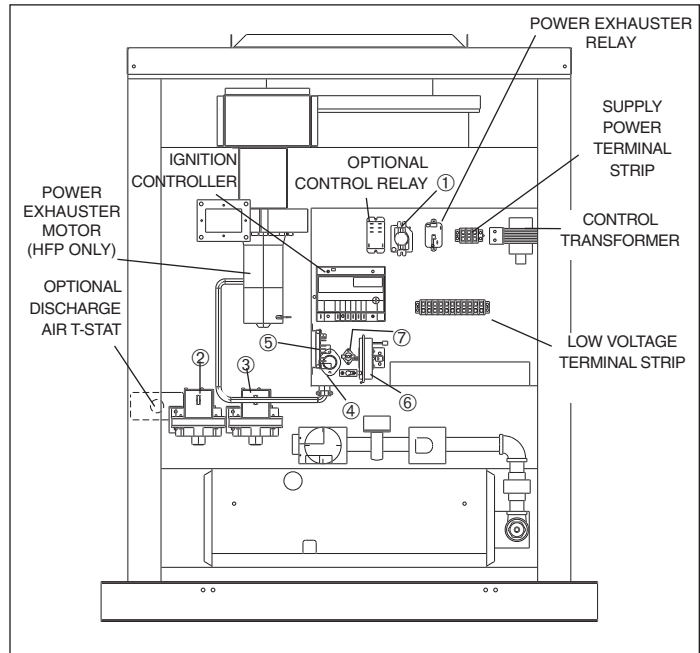

⑥ Air Flow Proving Switch

The air flow proving switch is factory installed in the duct furnace electrical junction box. The air flow proving switch monitors the pressure differential between the duct furnace and the atmosphere. The purpose of the air flow proving switch is to cut power to the gas controls if a positive pressure is not measured by the switch. This could be caused by a lack of air movement through the heat exchanger.

NOTE: The air flow proving switch will prevent any heat exchanger warm-up (the unit should not be equipped with a time delay relay) because the gas controls can not be energized until air flow is proven.

Setting the Air Flow Proving Switch

The range of the air flow proving switch is adjustable between 0.17" to 5.0" W.C.

1. Set the thermostat so that there is a call for heat. This should start the blower and then the burner ignition sequence.
2. Turn the set screw of the pressure switch clockwise until it stops. This will set the pressure at 5.0" W.C.
3. Turn the screw counter-clockwise until the gas controls light and then one additional full turn (This is approximately 0.25" W.C.). This will allow for dirty filters or any other slight static pressure increases in the system.

⑦ Manual Reset High Limit

The manual reset high limit switch is factory installed in place of the standard automatic reset high limit switch located in the duct furnace electrical junction box. In case of a failure of the blower motor, blockage of the inlet air, etc., the manual reset switch prevents the unit from cycling on the high limit. If the limit temperature is exceeded, a service person must inspect the unit for the cause of the high discharge temperature, take corrective action, and then reset the switch.

DIMENSIONAL DATA

Figure 13.1 - HFG Unit Drawing

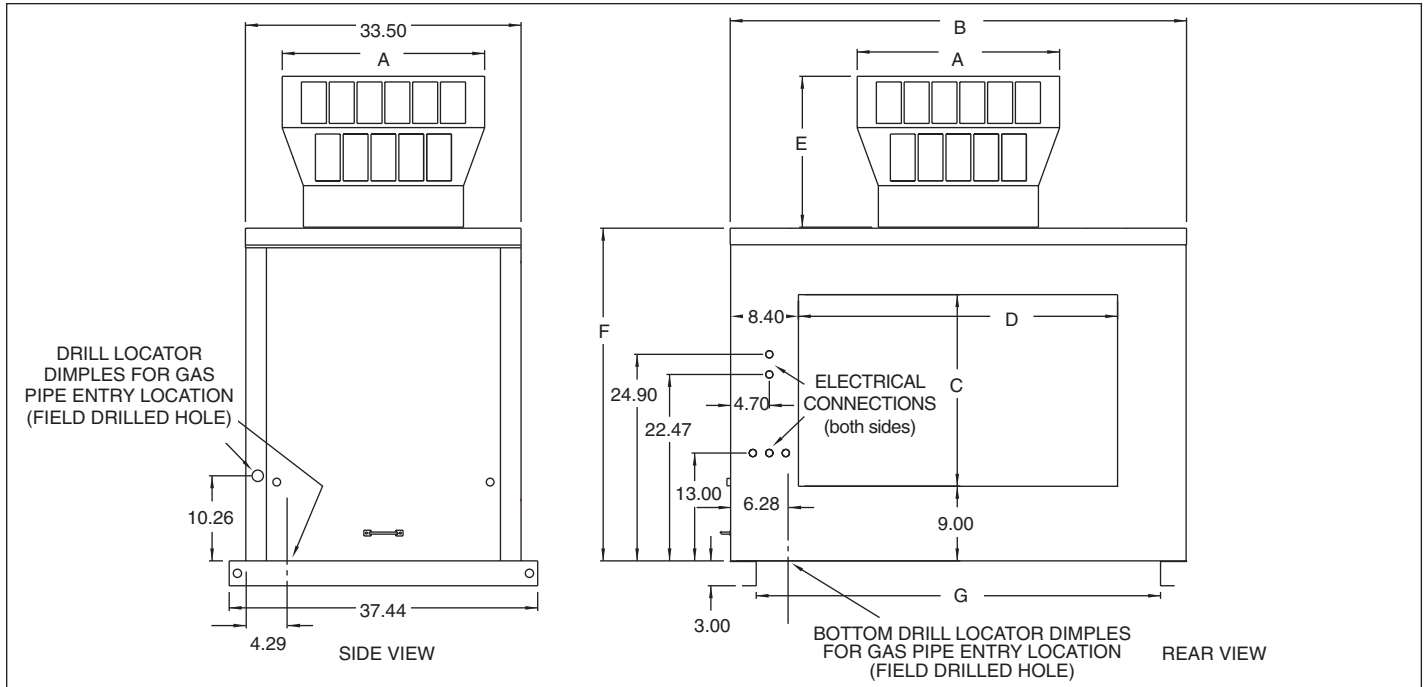

Figure 13.2 - Rail or Slab Type Mounting Base

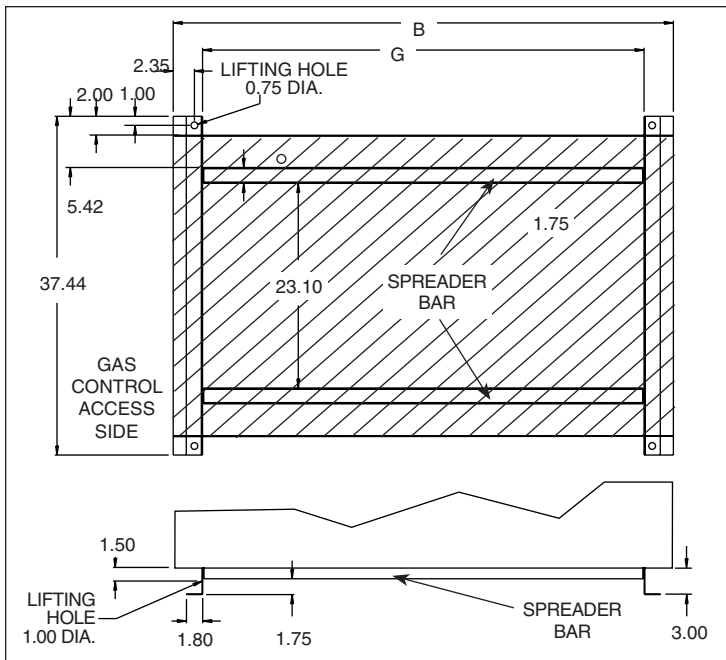

Table 13.1 - Model HFG Dimensions (All dimensions in inches)

Model Size	75	100/125	150/175	200/225	250/300	350/400
A	19.22	19.22	19.22	19.22	21.31	24.64
B	31.96	34.46	38.72	40.84	43.86	55.38
C	18.98	18.98	18.98	22.98	22.98	22.98
E	14.20	14.20	14.20	14.20	15.18	18.38
F	36.11	36.11	36.11	40.11	40.11	40.11
G	25.50	28.00	32.25	34.38	37.40	48.92
Gas Connection Pipe Size	1/2"	1/2"	1/2"	1/2"	3/4"	3/4"
Approx. Weight	Unit Shipping	282#	305#	333#	383#	525#
	Unit Net	207#	225#	248#	288#	400#
	Cap Net	16#	16#	16#	16#	35#

DIMENSIONAL DATA

Figure 14.1 - HFP Unit Drawing

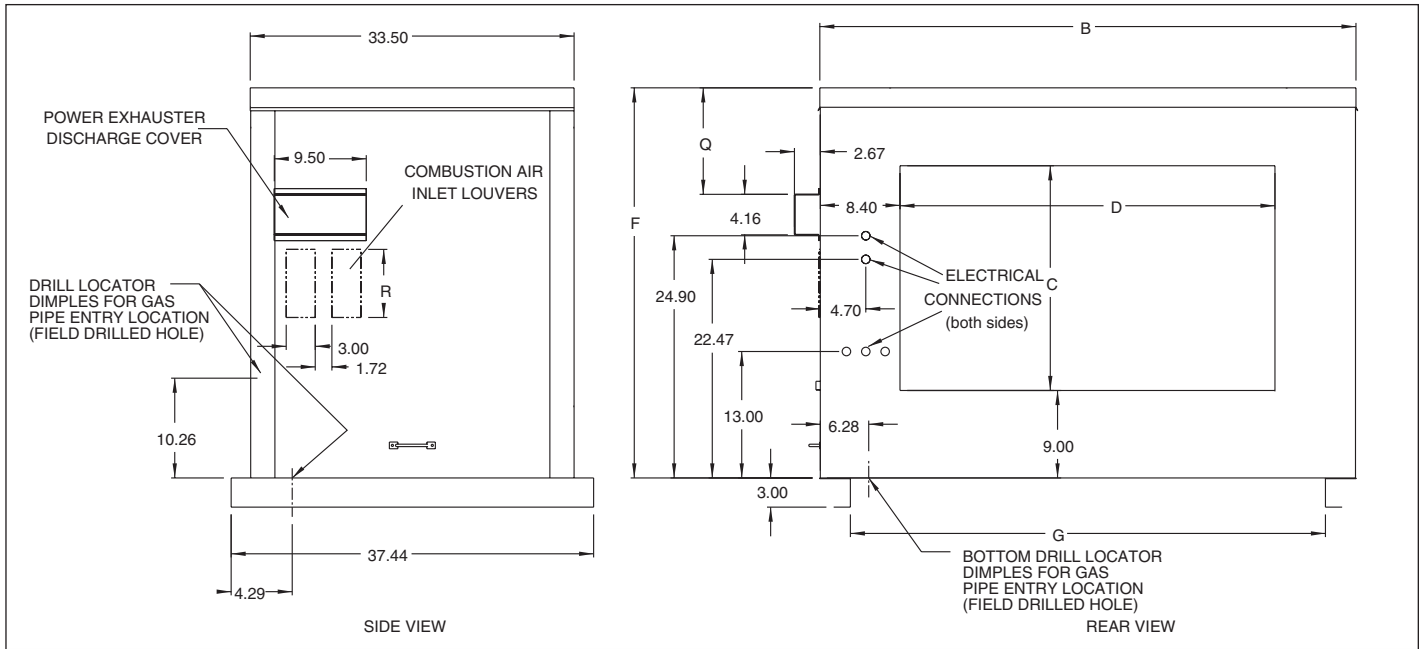

Figure 14.2 - Rail or Slab Type Mounting Base

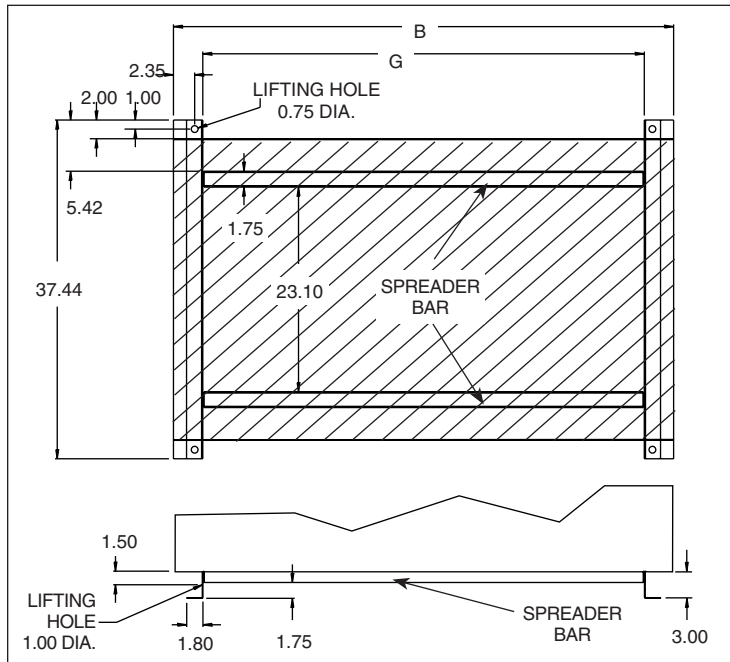

Table 14.1 - Model HFP Dimensions (All dimensions in inches)

Model Size	75	100/125	150/175	200/225	250/300	350/400
B	31.96	34.46	38.72	40.84	43.86	55.38
C	18.98	18.98	18.98	22.98	22.98	22.98
D	15.18	17.69	21.94	24.06	27.09	38.60
F	36.11	36.11	36.11	40.11	40.11	40.11
G	25.50	28.00	32.25	34.38	37.40	48.92
Q	10.95	10.95	10.95	11.58	11.58	11.58
R	7	7	7	9.9	9.9	9.9
Gas Connection Pipe Size	1/2"	1/2"	1/2"	1/2"	3/4"	3/4"
Approx. Weight	Unit Shipping	292#	315#	343#	398#	540#
	Unit Net	217#	235#	258#	303#	415#

PERFORMANCE

Table 15.1 — Air Temperature Rise - Low Temperature Rise Duct Furnaces ① ② ③

Model Size	Btu/Hr		Air Temperature Rise Through Unit (°F)								
			20	25	30	35	40	45	50	55	60
	Input	Output	Max	CFM							
75	75,000	60,000	2778	2222	1852	1587	1389	1235	1111	1010	926
100	100,000	80,000	3704	2963	2469	2116	1852	1646	1481	1347	1235
125	125,000	100,000	4630	3704	3086	2646	2315	2058	1852	1684	1543
150	150,000	120,000	5556	4444	3704	3175	2778	2469	2222	2020	1852
175	175,000	140,000	6481	5185	4321	3704	3241	2881	2593	2357	2160
200	200,000	160,000	7407	5926	4938	4233	3704	3292	2963	2694	2469
225	225,000	180,000	8333	6667	5556	4762	4167	3704	3333	3030	2778
250	250,000	200,000	9259	7407	6173	5291	4630	4115	3704	3367	3086
300	300,000	240,000	11111	8889	7407	6349	5556	4938	4444	4040	3704
350	350,000	280,000	12963	10370	8642	7407	6481	5761	5185	4714	4321
400	400,000	320,000	14815	11852	9877	8466	7407	6584	5926	5387	4938

Table 15.2 — Air Temperature Rise - High Temperature Rise Duct Furnaces ① ② ③

Model Size	Btu/Hr		Air Temperature Rise Through Unit (°F)											
			20 ④	40 ④	50 ④	60	65	70	75	80	85	90	95	100 ⑤
	Input	Output	Max	CFM										
75	75,000	60,000	2778	1389	1111	926	855	794	741	694	654	617	585	556
100	100,000	80,000	3704	1852	1481	1235	1140	1058	988	926	871	823	780	741
125	125,000	100,000	4630	2315	1852	1543	1425	1323	1235	1157	1089	1029	975	926
150	150,000	120,000	5556	2778	2222	1852	1709	1587	1481	1389	1307	1235	1170	1111
175	175,000	140,000	6481	3241	2593	2160	1994	1852	1728	1620	1525	1440	1365	1296
200	200,000	160,000	7407	3704	2963	2469	2279	2116	1975	1852	1743	1646	1559	1481
225	225,000	180,000	8333	4167	3333	2778	2564	2381	2222	2083	1961	1852	1754	1667
250	250,000	200,000	9259	4630	3704	3086	2849	2646	2469	2315	2179	2058	1949	1852
300	300,000	240,000	11111	5556	4444	3704	3419	3175	2963	2778	2614	2469	2339	2222
350	350,000	280,000	11111⑥	6481	5185	4321	3989	3704	3457	3241	3050	2881	2729	2593
400	400,000	320,000	11111⑥	7407	5926	4938	4558	4233	3951	3704	3486	3292	3119	2963

- ① Ratings are shown for elevations up to 2000 feet. For higher elevations, the input rating should be reduced at the rate of 4% per 1000 feet elevation above sea level. For Canada, in elevations between 2000 and 4500 feet, the unit must be derated to 90% of the rating listed above.
- ② Units approved for use in California by CEC.
- ③ High air temperature rise units include an air distribution baffle and restrictor change when compared to the low air temperature rise units. Field conversion of a high air temperature rise to a low air temperature rise unit (or the opposite) requires a factory supplied conversion kit.
- ④ The certified range of the High Temperature Rise Duct Furnaces is 20°-100°F but it is recommended that they be used from 60°-100°F to reduce the system pressure drop.
- ⑤ For Variable Air Movement Applications, see page 11.
- ⑥ The maximum CFM for the 350 and 400 results in a 23°F and a 27°F air temperature rise (respectively) based on the maximum unit pressure drop.

Air Temperature and External Static Pressure Limits

The maximum allowable discharge air temperature is 150°F. The maximum allowable air temperature rise for Low Air Temperature Rise Units is 60°F. The maximum allowable air temperature rise for High Air Temperature Rise Units is 100°F. All duct furnaces are designed for a maximum allowable static pressure of 3.0" W.C. on the heat exchanger.

**Figure 15.1
Recommended Unit Configurations**

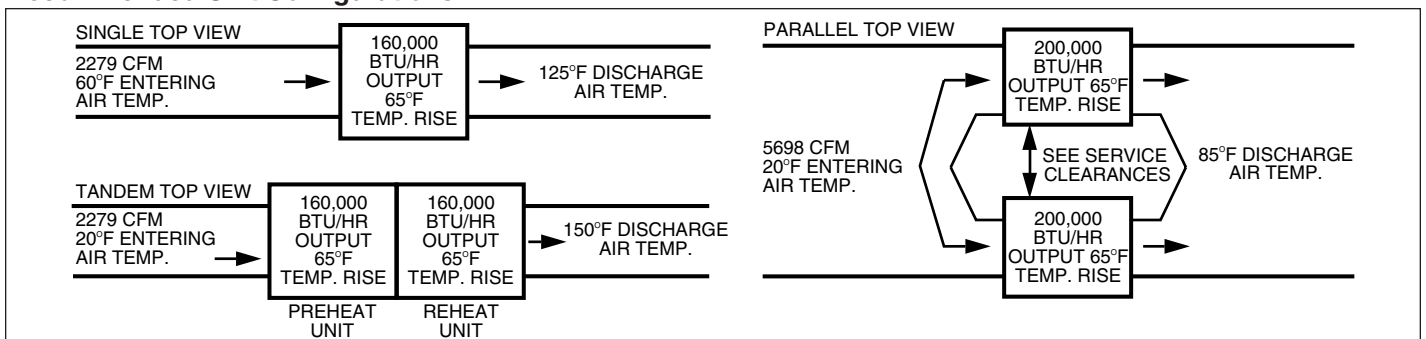

PRESSURE DROP CURVES

Figure 16.1
Low Air Temperature Rise Duct Furnace Pressure Drop vs. CFM Curves

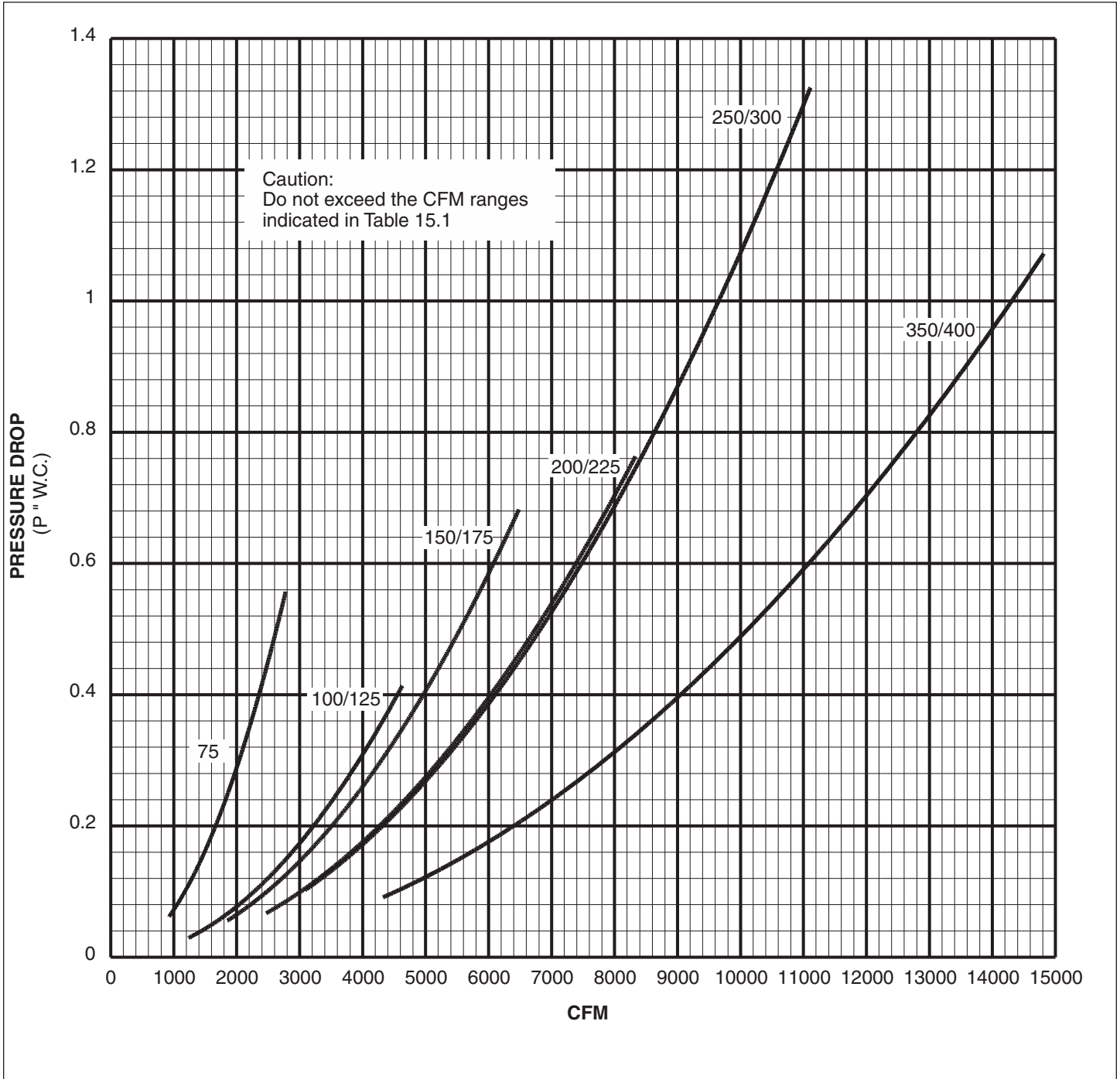

PRESSURE DROP CURVES

Figure 17.1
High Air Temperature Rise Duct Furnace Pressure Drop vs. CFM Curves

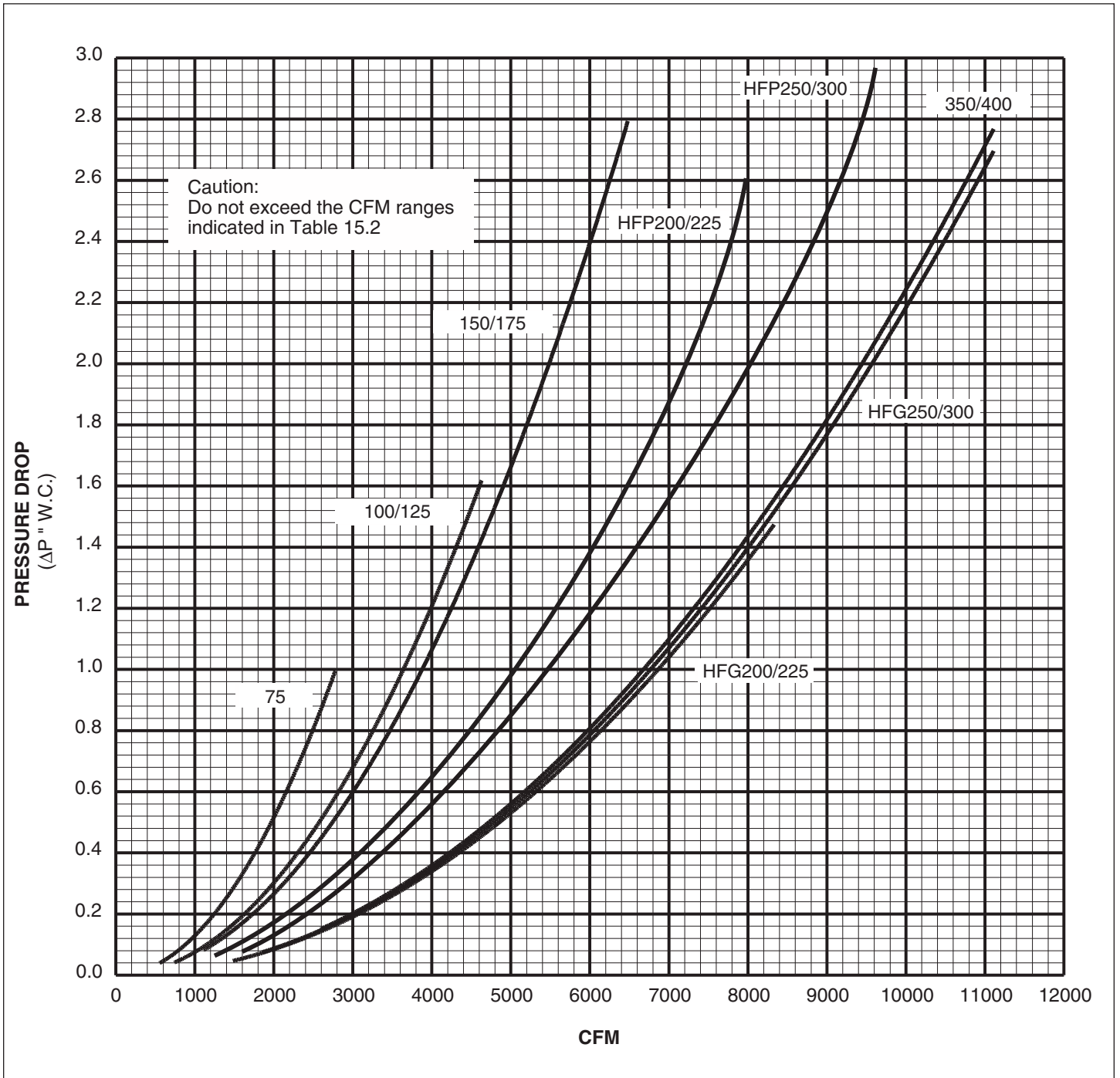

MAINTENANCE

All heating equipment should be serviced before each heating season to assure proper operations. The following items may be required to have more frequent service schedule based on the environment in which the unit is installed, and the frequency of the equipment operation.

Blower Assembly

The blower assembly includes the bearings, drive sheaves and belts.

Blower bearings should be checked and lubricated based on the blower manufacturer's recommendations. Bearings should also be checked for any unusual wear and replaced if needed.

Drive sheaves should be checked at the same time the bearings are inspected. Check to make sure the sheaves are in alignment and are securely fastened to the blower and motor shafts.

Belt tension should be rechecked shortly after the unit has been installed to check for belt stretching. After the initial start-up, monthly checks are recommended.

Filters

If the unit is supplied with a dirty filter switch and light, clean or replace the filters any time the dirty filter light comes on.

Units which do not have a dirty filter warning light should have the filters checked monthly. Clean or replace if necessary. In dirty atmospheres, filter maintenance may be required more often.

Duct Furnace

When providing annual maintenance for the duct furnace, keep the unit free from dust, dirt, grease and foreign matter. Pay particular attention to:

1. The combustion air intake and exhaust vent cap louvered openings.
2. The burner ports and pilot burner orifices (avoid the use of hard, sharp instruments capable of damaging surfaces for cleaning these ports). To check the burner port and pilot burner orifice, see Burner and Pilot Assembly Removal.
3. The air shutters and main burner orifices (avoid the use of hard, sharp instruments capable of damaging surfaces for cleaning these orifices). To check the air shutters and main burner orifices, see for Manifold Assembly Removal.

The heat exchanger should be checked annually for cracks and discoloration of the tubes. If a crack is detected, the heat exchanger should be replaced before the unit is put back into service. If the tubes are dark gray, airflow across the heat exchanger should be checked to insure that a blockage has not occurred or the blower is operating properly.

Electrical Wiring

The electrical wiring should be checked annually for loose connections or deteriorated insulation.

Gas Piping & Controls

The gas valves and piping should be checked annually for general cleanliness and tightness.

The gas controls should be checked to insure that the unit is operating properly.

Manifold Assembly Removal

To remove the manifold

1. Shut off gas and electric supply.
2. Remove the burner side access panel.
3. Disconnect gas manifold at ground union joint.
4. Remove the two screws holding the manifold to the heat exchanger support.
5. Slide the manifold through the manifold bracket.
6. Clean the orifices and adjust the air shutters as necessary.
7. Follow steps 3-6 in reverse order to install the manifold assembly.
8. Turn on the electric and gas supply.
9. Check the ground union joint for leaks with a soap solution. Tighten if necessary.
10. Install the burner side access panel.

Figure 18.1
Manifold Assembly Removal

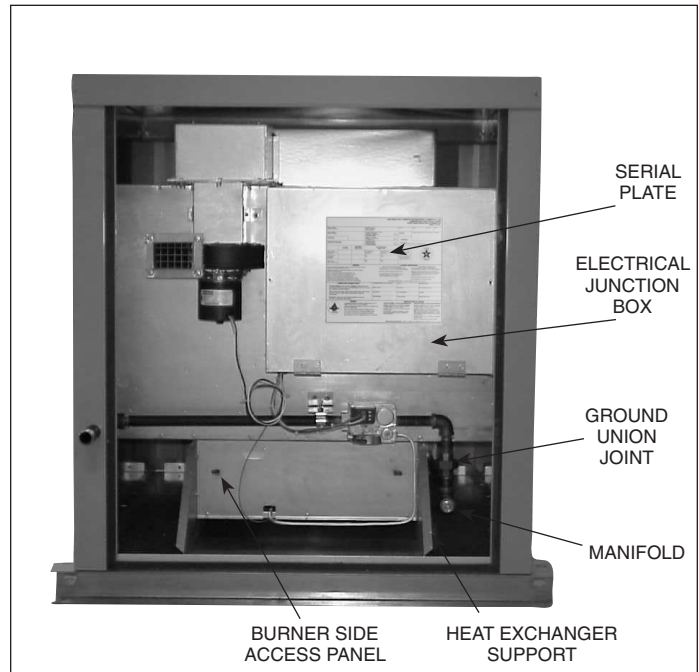

Burner and Pilot Assembly Removal

To remove the burner

1. Shut off gas and electric supply.
2. Remove the burner side access panel.
3. Disconnect the pilot supply line from the gas valve.
4. Disconnect the ignition cable from the ignition controller (located in the electrical junction box). Feed the cable through the bushing in the bottom of the electrical junction box.
5. Remove the screws holding the burner side access panel. Attached to the panel are the burner retaining pins that align the burner.

MAINTENANCE

Burner and Pilot Assembly Removal (continued)

6. Slide the burner assembly out. The pilot is attached to the burner assembly.
7. Examine the burner and pilot assembly for cleanliness and/or obstructions as necessary (see Duct Furnace for cleaning instructions).
8. Replace the burner assembly in reverse order. In replacing the burner, be certain that the rear burner slots are located properly on the burner retaining pins. Do not force the burner side access panel, it will not fit if the burner is not properly aligned.
9. Reconnect the ignition cable and pilot gas supply line.
10. Install the burner side access panel.
11. Turn on the electric and gas supply.

Figure 19.1
Burner and Pilot Assembly Removal

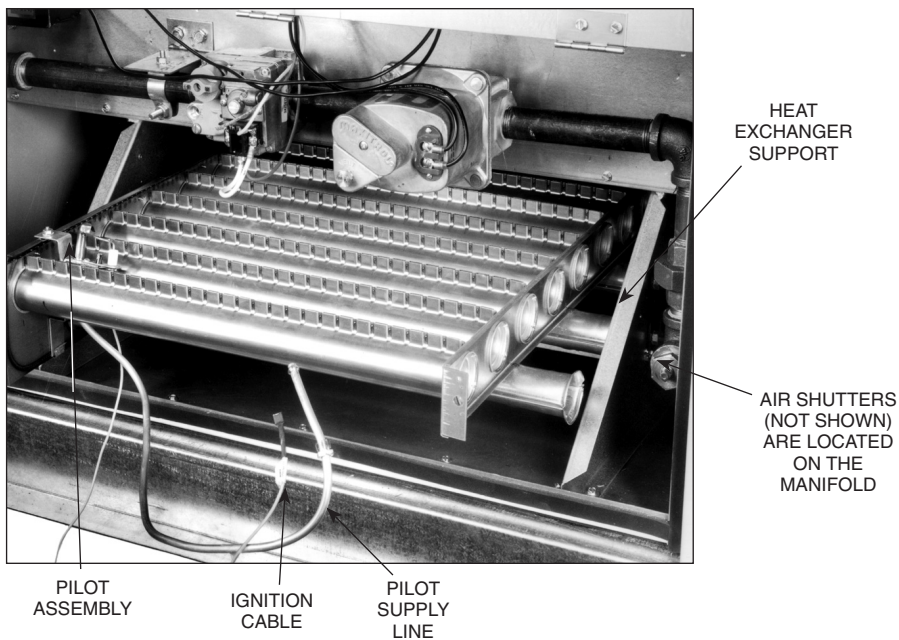

SERVICE & TROUBLESHOOTING

WARNING

When servicing or repairing this equipment, use only factory-approved service replacement parts. A complete replacement parts list may be obtained by contacting Modine Manufacturing Company. Refer to the rating plate on the appliance for complete appliance model number, serial number, and company address. Any substitution of parts or controls not approved by the factory will be at the owner's risk.

CAUTION

Do not reuse any mechanical or electrical component which has been wet. Such component must be replaced.

IMPORTANT

To check most of the Possible Remedies in the troubleshooting guide listed in Table 20.1, refer to the applicable sections of the manual.

Table 20.1
Troubleshooting

Trouble	Possible Cause	Possible Remedy
Pilot does not light	<ol style="list-style-type: none"> 1. Main gas is off. 2. Power supply is off. 3. Air in gas line. 4. Dirt in pilot orifice. 5. Gas pressure out of proper range. 6. Pilot valve does not open. <ol style="list-style-type: none"> a. Defective ignition controller. b. Defective gas valve. 7. No Spark at ignitor. <ol style="list-style-type: none"> a. Loose wire connections. b. Pilot sensor is grounded. c. Defective ignition controller. 8. Safety device has cut power. 	<ol style="list-style-type: none"> 1. Open manual gas valve. 2. Turn on main power. 3. Purge gas line. 4. Check for plugged pilot orifice and clean with compressed air if necessary. 5. Adjust to a maximum of 14" W.C. Minimum for Natural Gas - 6" W.C. Minimum for Propane Gas - 11" W.C. 6. Check wiring for 24 volts to valve. <ol style="list-style-type: none"> a. Replace ignition controller. b. Replace gas valve. 7. <ol style="list-style-type: none"> a. Check all ignition controller wiring. b. Replace sensor if cracked or worn c. Replace ignition controller. 8. Check all safety devices (High limit, air flow proving switch, power exhauster centrifugal switch - HFP Models Only, gas pressure switches, etc.) Determine and correct problem. Reset if necessary.
Main burners do not light (Pilot is lit)	<ol style="list-style-type: none"> 1. Defective valve. 2. Loose wiring. 3. Defective pilot sensor 4. Defective ignition controller. 5. Improper thermostat wiring. 	<ol style="list-style-type: none"> 1. Replace valve. 2. Check wiring to gas valve. 3. Replace pilot sensor. 4. Replace ignition controller. 5. Verify wiring compared to wiring diagram.
Lifting Flames (See Figure 21.1)	<ol style="list-style-type: none"> 1. Too much primary air. 2. Main pressure set too high. 3. Orifice too large. 	<ol style="list-style-type: none"> 1. Reduce primary air. 2. Adjust to a maximum of 14" W.C. 3. Check orifice size with those listed on the serial plate.
Yellow Tipping (With propane gas, some yellow tipping is always present.)	<ol style="list-style-type: none"> 1. Insufficient primary air. 2. Dirty orifice. 3. Misaligned orifice. 	<ol style="list-style-type: none"> 1. Increase primary air. 2. Check orifices and clean with compressed air if necessary. 3. Check manifold, replace if necessary.
Flashback	<ol style="list-style-type: none"> 1. Too much primary air. 2. Main pressure set too high. 3. Orifice too large. 	<ol style="list-style-type: none"> 1. Reduce primary air. 2. Adjust to a maximum of 14" W.C. 3. Check orifice size with those listed on the serial plate.
Floating Flames (See Figure 21.2)	<ol style="list-style-type: none"> 1. Insufficient primary air. 2. Main pressure set too high. 3. Orifice too large. 4. Blocked vent cap. 	<ol style="list-style-type: none"> 1. Increase primary air. 2. Adjust to a maximum of 14" W.C. 3. Check orifice size with those listed on the serial plate. 4. Clean louvers in vent cap.

SERVICE & TROUBLESHOOTING

Trouble	Possible Cause	Possible Remedy
Flame Rollout (See Figure 21.3)	<ol style="list-style-type: none"> Main pressure set too high. Orifice too large. Blocked vent cap. 	<ol style="list-style-type: none"> Adjust to a maximum of 14" W.C. Check orifice size with those listed on the serial plate. Clean louvers in vent cap.
Not Enough Heat	<ol style="list-style-type: none"> Unit cycling on high limit. ① <ol style="list-style-type: none"> Obstructions/leaks in duct system. Main pressure set too high. Blower motor not energized. Loose belt Blower speed too low. Blocked/damaged venting system. Air distribution baffle removed (high temperature rise units only). Defective high limit switch. Main pressure set too low. Too much outside air. Thermostat malfunction. Gas controls wired incorrectly. Unit undersized. 	<ol style="list-style-type: none"> <ol style="list-style-type: none"> Clean/correct duct system. Adjust to a maximum of 14" W.C. Check/correct to insure blower motor operates within 45 seconds of when - gas controls are energized. Adjust belt tension. Check/correct blower drive settings for proper rpm. Check/correct venting system. Replace air distribution baffle. Replace high limit switch. Adjust main gas pressure. Minimum for Natural Gas — 6" W.C. Minimum for Propane Gas — 11" W.C. Adjust outside air damper to decrease outside air percentage (if possible). Check/replace thermostat. Check unit wiring against the wiring diagram. Check design conditions. If unit is undersized, an additional unit(s) or other heat source must be added.
Too Much Heat	<ol style="list-style-type: none"> Thermostat malfunction. Gas controls do not shut-off. <ol style="list-style-type: none"> Gas controls wired incorrectly. Short circuit. Main gas pressure set too high. Defective gas valve. 	<ol style="list-style-type: none"> Check/replace thermostat. <ol style="list-style-type: none"> Check unit wiring against the wiring diagram. Check for loose or worn wires. Adjust to a maximum of 14" W.C. Replace gas valve.
Power Exhauster Motor will not start (HFP Models Only)	<ol style="list-style-type: none"> Power supply is off. No 24V power to thermostat. Thermostat malfunction. Defective power exhauster relay. Defective power exhauster motor. 	<ol style="list-style-type: none"> Turn on main power. Check control transformer. Check/replace thermostat. Replace power exhauster relay. Replace power exhauster motor.

① Automatic Reset High Limit

The duct furnace comes standard with an automatic reset high limit switch that will shut-off the gas should the discharge air temperature become excessive. See Figure 12.1, indicator ⑦ for the location of either the standard automatic or optional manual reset high limit switch. The switch should operate only when something is seriously wrong with the unit operation. Anytime the switch operates, correct the difficulty immediately or serious damage may result. If the switch cuts off the gas supply during normal operation, refer to the "Not Enough Heat" section of Service & Troubleshooting.

Figure 21.1
Lifting Flame Condition

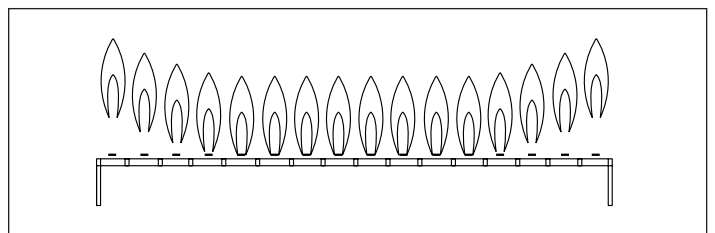

Figure 21.2
Floating Flame Condition

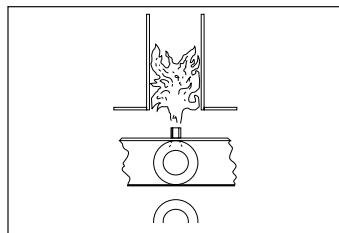
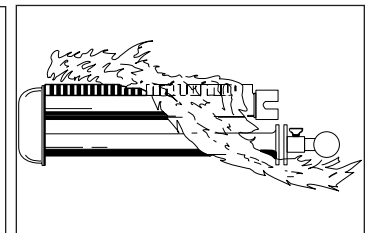

Figure 21.3
Flame Rollout Appearance



REPLACEMENT PARTS ORDERING

Ordering

When servicing, repairing or replacing parts on these units, locate the serial plate of the unit and always give the complete Model Number and Serial Number from the serial plate. The serial plate is located on the door of the electrical control box. The part numbers for some common replacement parts are listed on the sample serial plate (See Figure 22.1). For a complete description of the model number, see Model Identification.

Figure 22.1

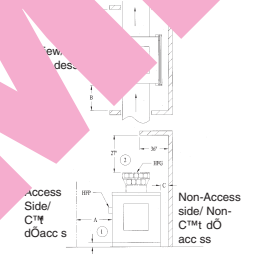
Modine Manufacturing Company 1500 DeKoven Ave., Racine, WI 53403 Phone: 800.828.4328				OUTDOOR GAS-FIRED DUCT FURNACE/ FOR INDUSTRIAL/COMMERCIAL USE CHAUDIERE À GAZ À CONDUIT POUR EXTERIEUR/ POUR USAGE INDUSTRIEL/COMMERCIAL				MADE IN U.S.A.																							
MODEL NUMBER NUMERO DE MODELE		HFG200AFRHN10A1		MIN. INPUT BTU/HR DEBIT CALORIFIQUE MIN. BTU/HEURE		160000		APPROVALS																							
SERIAL NUMBER NUMERO DE SERIE		09170936100123		MIN. INLET PRESS. FOR PURPOSE OF INPUT ADJUSTMENT PRESSION D'ALIMENTATION EN GAZ MIN. ADMISE		6		IN. W.C. P.O.C.D'E																							
TYPE OF GAS TYPE DE GAZ		Natural		MANIFOLD PRESSURE PRESSION A LA TUBULURE D'ALIMENTATION		3.5		IN. W.C. P.O.C.D'E																							
TEMPERATURE RISE RANGE ELEVATION DE TEMPERATURE		20-100		MAXIMUM EXTERNAL STATIC PRESSURE PRESSION STATIQUE EXTERIEUR MAXIMUM		3		IN. W.C. P.O.C.D'E																							
0 TO 2000 FT. 0 ET 610 M.		(IN CANADA) 2000 TO 4500 FT. 610 ET 1370 M.		AIR THROUGHPUT DEBIT D'AIR		VOLTS		115																							
INPUT BTU/HR DEBIT CALORIFIQUE BTU/HEURE		200000		180000		MIN. CFM		1481																							
OUTPUT BTU/HR RENDEMENT BTU/HEURE		160000		144000		MAX. CFM		7407																							
ORIFICE SIZE DIM. DE L'INJECTEUR		23		26		MIN. VARIABLE SPEED CFM *		1111																							
60		PHASE		1		AMPS		60																							
COMMON REPLACEMENT PARTS For parts ordering, contact the parts wholesaler or the manufacturer's representative serving your area. When inquiring about parts, always provide model number, serial number, description and part number. When ordering parts, provide part number listed. For service, contact your local qualified installation and service contractor or appropriate utility company.				COMBUSTIBLE MATERIALS CLEARANCE REQUIREMENTS 				GENERAL 1. FOR OUTDOOR INSTALLATIONS ONLY. 2. MINIMUM AMBIENT TEMPERATURE -40 F. 3. FOR INSTALLATION DOWN STREAM OF REFRIGERATION SYSTEMS. 4. INSTALL ON THE POSITIVE PRESSURE SIDE OF AIR CIRCULATING BLOWER. 5. FOR UNITS WITH MANUAL RESET HIGH LIMIT SWITCH, RESET BUTTON IS LOCATED IN ELECTRICAL JUNCTION BOX. 6. (IN USA) FOR INSTALLATIONS ABOVE 2000 FEET, DERATE 4 PERCENT FOR EACH 1000 FEET OR ELEVATION ABOVE SEA LEVEL.																							
5H73205-1 Comb. Gas Control 5H73696- Ignition Control 3H34347-3 Pilot Assy. Kit 5H74976-1 limit Control 5H74977-1 Transfomer 5H74818-1 Wiring Diagram 3H35628-6 Burner Kit 3H35616-6 Heat Exch. Kit				① Minimum clearance to combustibles is 0.0" from bottom of unit mounting rail or 3" from bottom of sheet metal casing. / Le dégagement minimum du combustible est 0.0" du bas de la barre qui support l'élément ou 3" du bas de l'enveloppe de tôle. ② OFF - Minimum clearance to combustibles is 1.0" from rooftop. / OFF Les dimensions minima de positionnement par rapport aux matériaux combustibles est de 1.0 po depuis le dessus de l'appareil.				LIGHTING INSTRUCTIONS 1. OPEN ALL GAS VALVES. TURN ON POWER. 2. SET THERMOSTAT TO DESIRED SETTING. SHUT DOWN INSTRUCTIONS 1. TURN OFF POWER & CLOSE ALL GAS VALVES. REFER TO INSTALLATION AND SERVICE MANUAL FOR MORE INSTRUCTIONS * FOR UNITS WITH TWO STAGE, MECHANICAL MODULATION, OR ELECTRONIC MODULATING GAS CONTROLS, A FACTORY DISCHARGE AIR CONTROLLER AND NO ROOM THERMOSTAT INCLUDED.																							
RECOMMENDED SERVICE CLEARANCE				DEGAGEMENT DU MATERIEL COMBUSTIBLE				DEGAGEMENT DE SERVICE RECOMMENDE																							
MODEL SIZE		FRONT & REAR (B) HFG		FRONT & REAR (B) HFP		SIDE C HFG/HFP		SIDE A HFG/HFP		ACCESS SIDE (A)		NON-ACCESS SIDE (C)		DIMENSION DU MODELE		AVANT & ARRIERE (B) HFG		AVANT & ARRIERE (B) HFP		COTE C HFG/HFP		COTE A HFG/HFP		COTE SPACES (A)		COTE NON-ACCES (C)					
75		0"		3"		0"		0"		3"		18"		6"		75		0"		3"		0"		0"		3"		18"		6"	
100/125		0"		3"		0"		0"		3"		20"		6"		100/125		0"		3"		0"		0"		3"		20"		6"	
150/175		3"		3"		0"		0"		3"		25"		6"		150/175		3"		3"		0"		0"		3"		25"		6"	
200/225		4"		4"		0"		0"		3"		27"		6"		200/225		4"		4"		0"		0"		3"		27"		6"	
250/300		5"		5"		0"		0"		3"		30"		6"		250/300		5"		5"		0"		0"		3"		30"		6"	
350/400		11"		11"		0"		0"		3"		41"		6"		350/400		11"		11"		0"		0"		3"		41"		6"	

MODEL IDENTIFICATION

Weatherproof Model Nomenclature

1	2	3	4 5 6	7	8	9	10	11	12	13	14	15
PT	UC	V	MBH	HE	DS	AS	ATR	GT	GV	SS	SV	TR

1 - Product Type (PT)

H - Outdoor HVAC Unit

2 - Unit Configuration (UC)

F - Furnace

3 - Venting (V)

G - Gravity

P - Power

4,5,6 - Furnace Input Rating (MBH)

75 - 75,000 Btu/Hr Input	225 - 225,000 Btu/Hr Input
100 - 100,000 Btu/Hr Input	250 - 250,000 Btu/Hr Input
125 - 125,000 Btu/Hr Input	300 - 300,000 Btu/Hr Input
150 - 150,000 Btu/Hr Input	350 - 350,000 Btu/Hr Input
175 - 175,000 Btu/Hr Input	400 - 400,000 Btu/Hr Input
200 - 200,000 Btu/Hr Input	

7 - Heat Exchanger/Burner/Drip Pan Material (HE)

A - Aluminized Steel
 S - 409 Stainless Steel Heat Exchanger/Burner
 T - 409 Stainless Steel Heat Exchanger/Burner/Drip Pan

8 - Development Sequence (DS)

F - Single Stage M - 2-stage or Modulating

9 - Access Side (AS)

R - Right Hand L - Left hand

10 - Air Temperature Rise (ATR)

H - High 20°-100°F L - Low 20°-60°

11 - Gas Type (GT)

N - Natural with continuous retry ignition controller
 P - Propane with lockout ignition controller

12 - Gas Valve (GV)

1 - Single Stage	6 - Electronic Modulation Slave
2 - Two Stage	7 - Electronic Modulation 0-10 Vdc External Input
4 - Electronic Modulation	8 - Electronic Modulation 4-20 mA External Input
5 - Electronic Modulation Master	

13 - Additional Safety Switches (SS)

0 - No Additional Switches 2 - High Gas Pressure Switch
 1 - Low Gas Pressure Switch 3 - High & Low Gas Pressure Switch

14 - Supply Voltage (SV)

A - 115/60/1	E - 230/60/3
B - 208/60/1	F - 460/60/3
C - 230/60/1	G - 575/60/3
D - 208/60/3	

15 - Transformer (TR)

1 - 40 VA 3 - 150 VA 0 - None
 2 - 75 VA 4 - 250 VA

Figure 23.1 - Serial Number Designations

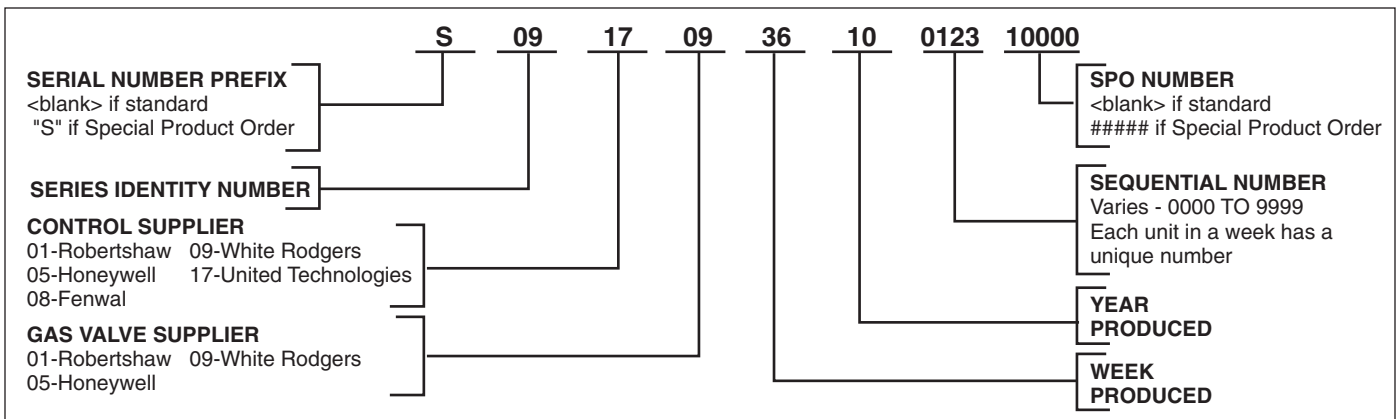

COMMERCIAL WARRANTY

Seller warrants its products to be free from defects in material and workmanship, EXCLUSIVE, HOWEVER, of failures attributable to the use of materials substituted under emergency conditions for materials normally employed. This warranty covers replacement of any parts furnished from the factory of Seller, but does not cover labor of any kind and materials not furnished by Seller, or any charges for any such labor or materials, whether such labor, materials or charges thereon are due to replacement of parts, adjustments, repairs, or any other work done. This warranty does not apply to any equipment which shall have been repaired or altered outside the factory of Seller in any way so as, in the judgment of Seller, to affect its stability, nor which has been subjected to misuse, negligence, or operating conditions in excess of those for which such equipment was designed. This warranty does not cover the effects of physical or chemical properties of water or steam or other liquids or gases used in the equipment.

BUYER AGREES THAT SELLER'S WARRANTY OF ITS PRODUCTS TO BE FREE FROM DEFECT IN MATERIAL AND WORKMANSHIP, AS LIMITED HEREIN, SHALL BE IN LIEU OF AND EXCLUSIVE OF ALL OTHER WARRANTIES, EITHER EXPRESS OR IMPLIED, WHETHER ARISING FROM LAW, COURSE OF DEALING, USAGE OF TRADE, OR OTHERWISE, THERE ARE NO OTHER WARRANTIES, INCLUDING WARRANTY OF MERCHANTABILITY OR FITNESS FOR PURPOSE, WHICH EXTEND BEYOND THE PRODUCT DESCRIPTION CONFIRMED BY BUYER AND SELLER AS OF THE DATE OF FINAL AGREEMENT.

This warranty is void if the input to the product exceeds the rated input as indicated on the product serial plate by more than 5% on gas-fired and oil-fired units, or if the product in the judgment of SELLER has been installed in a corrosive atmosphere, or subjected to corrosive fluids or gases, been subjected to misuse, negligence, accident, excessive thermal shock, excessive humidity, physical damage, impact, abrasion, unauthorized alterations, or operation contrary to SELLER'S printed instructions, or if the serial number has been altered, defaced or removed.

BUYER'S REMEDY FOR BREACH OF WARRANTY, EXCLUSIVE OF ALL OTHER REMEDIES PROVIDED BY LAW, IS LIMITED TO REPAIR OR REPLACEMENT AT THE FACTORY OF SELLER, ANY COMPONENT WHICH

SHALL, WITHIN THE APPLICABLE WARRANTY PERIOD DEFINED HEREIN AND UPON PRIOR WRITTEN APPROVAL, BE RETURNED TO SELLER WITH TRANSPORTATION CHARGES PREPAID AND WHICH THE EXAMINATION OF SELLER SHALL DISCLOSE TO HAVE BEEN DEFECTIVE; EXCEPT THAT WHEN THE PRODUCT IS TO BE USED BY BUYER AS A COMPONENT PART OF EQUIPMENT MANUFACTURED BY BUYER, BUYER'S REMEDY FOR BREACH, AS LIMITED HEREIN, SHALL BE LIMITED TO ONE YEAR FROM DATE OF SHIPMENT FROM SELLER. FOR GAS-FIRED PRODUCTS INSTALLED IN HIGH HUMIDITY APPLICATIONS AND UTILIZING STAINLESS STEEL HEAT EXCHANGERS, BUYER'S REMEDY FOR BREACH, AS LIMITED HEREIN, SHALL BE LIMITED TO TEN YEARS FROM DATE OF SHIPMENT FROM SELLER.

These warranties are issued only to the original owner-user and cannot be transferred or assigned. No provision is made in these warranties for any labor allowance or field labor participation. Seller will not honor any expenses incurred in its behalf with regard to repairs to any of Seller's products. No credit shall be issued for any defective part returned without proper written authorization (including, but not limited to, model number, serial number, date of failure, etc.) and freight prepaid.

OPTIONAL SUPPLEMENTAL WARRANTY

Provided a supplemental warranty has been purchased, Seller extends the warranty herein for an additional four (4) years on certain compressors. Provided a supplemental warranty has been purchased, Seller extends the warranty herein for an additional four (4) years or nine (9) years on certain heat exchangers.

EXCLUSION OF CONSUMABLES & CONDITIONS BEYOND SELLER'S CONTROL

The above referenced warranty shall not be applicable to any of the following items: refrigerant gas, belts, filters, fuses and other items consumed or worn out by normal wear and tear or conditions beyond Seller's control, including (without limitation as to generality) polluted or contaminated or foreign matter contained in the air or water utilized for heat exchanger (condenser) cooling or if the failure of the part is caused by improper air or water supply, or improper or incorrect sizing of power supply.

Component Applicable Models	"APPLICABLE WARRANTY PERIOD"
<u>Heat Exchangers</u> Gas-Fired Units except PSH/BSH	TEN YEARS FROM DATE OF FIRST BENEFICIAL USE BY BUYER OR ANY OTHER USER, WITHIN TEN YEARS FROM DATE OF RESALE BY BUYER OR ANY OTHER USER, WITHIN TEN YEARS FROM DATE OF RESALE BY BUYER IN ANY UNCHANGED CONDITION, OR WITHIN ONE HUNDRED TWENTY-SIX MONTHS FROM DATE OF SHIPMENT FROM SELLER, WHICHEVER OCCURS FIRST
<u>Heat Exchangers</u> Low Intensity Infrared Units <u>Compressors</u> Condensing Units for Cassettes	FIVE YEARS FROM DATE OF FIRST BENEFICIAL USE BY BUYER OR ANY OTHER USER, WITHIN FIVE YEARS FROM DATE OF RESALE BY BUYER OR ANY OTHER USER, WITHIN FIVE YEARS FROM DATE OF RESALE BY BUYER IN ANY UNCHANGED CONDITION, OR WITHIN SIXTY-SIX MONTHS FROM DATE OF SHIPMENT FROM SELLER, WHICHEVER OCCURS FIRST
<u>Burners</u> Low Intensity Infrared Units <u>Other</u> Components excluding Heat Exchangers, Coils, Condensers, Burners, Sheet Metal	TWO YEARS FROM DATE OF FIRST BENEFICIAL USE BY BUYER OR ANY OTHER USER, WITHIN TWO YEARS FROM DATE OF RESALE BY BUYER IN ANY UNCHANGED CONDITION, OR WITHIN THIRTY MONTHS FROM DATE OF SHIPMENT FROM SELLER, WHICHEVER OCCURS FIRST
<u>Heat Exchangers/Coils</u> Indoor and Outdoor Duct Furnaces and System Units, PSH/BSH, Steam/Hot Water Units, Oil-Fired Units, Electric Units, Cassettes, Vertical Unit Ventilators <u>Compressors</u> Vertical Unit Ventilators <u>Burners</u> High Intensity Infrared Units <u>Sheet Metal Parts</u> All Products	ONE YEAR FROM DATE OF FIRST BENEFICIAL USE BY BUYER OR ANY OTHER USER, WITHIN ONE YEAR FROM DATE OF RESALE BY BUYER IN ANY UNCHANGED CONDITION, OR WITHIN EIGHTEEN MONTHS FROM DATE OF SHIPMENT FROM SELLER, WHICHEVER OCCURS FIRST

As Modine Manufacturing Company has a continuous product improvement program, it reserves the right to change design and specifications without notice.



Commercial Products Group

Modine Manufacturing Company
 1500 DeKoven Avenue
 Racine, WI 53403
 Phone: 1.800.828.4328 (HEAT)
 www.modine.com
 Litho in USA