

In case the need for Servicing arises

Don't hesitate to call any nearby AS center
with your name, address and telephone number
when anything wrong with your product occurs.

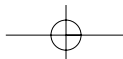

AH68-10332H



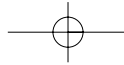

OWNER'S INSTRUCTIONS

Z-99Q

VIDEO-CD CD PLAYER

Before operating the unit, please read this manual thoroughly, and retain for future reference.

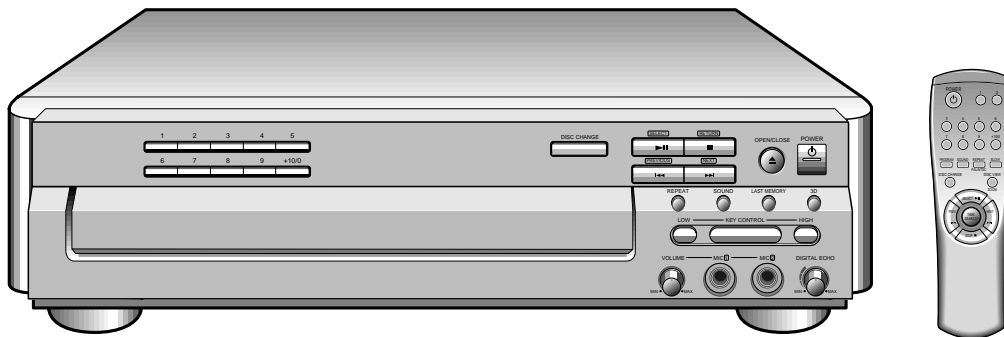

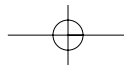

This player does not apply to business use
and CD-ROM/CD graphic discs
cannot be played with this player.

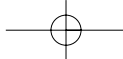



SAFETY PRECAUTIONS

	CAUTION RISK OF ELECTRIC SHOCK DO NOT OPEN	
CAUTION TO REDUCE THE RISK OF ELECTRIC SHOCK, DO NOT REMOVE TOP COVER, NO USER SERVICEABLE PARTS INSIDE, REFER SERVICING TO QUALIFIED SERVICE PERSONNEL.		

CLASS 1 LASER PRODUCT

CLASS 1 LASER PRODUCT
 This Compact Disc player is classified as a CLASS 1 LASER product

Use of controls adjustments or performance of procedures other than those specified herein may result in hazardous radiation.

CAUTION-INVISIBLE LASER RADIATION WHEN OPEN AND INTER LOCK DEFEATED, AVOID EXPOSURE TO BEAM.



This symbol is intended to alert you to the presence of dangerous voltage within the product.



This symbol is intended to alert you to the presence of important instruction accompanying the product.

SPECIAL NOTICE

- Warning:**
- This unit contains no user serviceable parts. Never remove covers unless qualified to do so. This unit contains dangerous voltages, always remove main plug from the socket before any service operation and when not in use for a long period.

WARNING

To reduce the risk of fire or electric shock, do not expose this appliance to rain or moisture.

Important:

- This unit is designed for your enjoyment in your home. We cannot be liable for the quality of the unit if you use it for commercial use. So please do not use this unit for commercial use.

Enter information here for future reference.

Date of Purchased: _____
 Model No: _____
 Serial No: _____
 Selling Dealer: _____
 Dealer Address: _____
 Dealer Phone No: _____

IMPORTANT NOTICE

NOTE TO CATV SYSTEM INSTALLER;

- This reminder is provided to call the CATV system installer's attention to article 820-40 of the NEC provides guidelines for proper the cable ground shall be connected to the grounding system of the building, as close to the point of cable entry as practical.

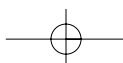

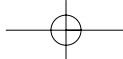

SAFETY INSTRUCTIONS

CONTENTS

SAFETY INSTRUCTIONS

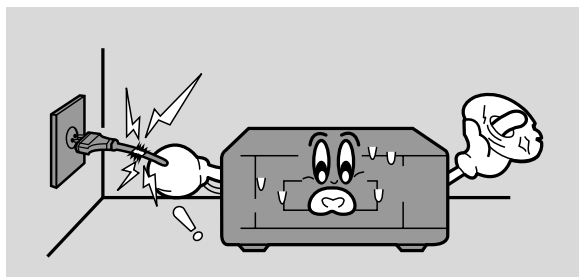

- Do not damage the power cord. Damage to the power cord may cause a fire or shock hazard.
- When unplugging the power cord, please hold by the plug and remove it carefully in standby mode.
- When you finish operating the unit, always turn off the power. Leaving a disc loaded for a long time with power turned on may damage the disc.
- When you insert the disc, please do not insert over another disc.
- This product should not be used in business applications.

SAFETY INSTRUCTIONS	3
CONTROLS AND COMPONENTS.....	6
REMOTE CONTROL	8
TO INSERT BATTERIES	8
SYSTEM CONNECTIONS	9
VIDEO-CD PLAYBACK	10
DISC VIEW FUNCTION.....	12
REPEAT FUNCTION	13
PROGRAM FUNCTION	14
ZOOM FUNCTION	15
SEARCHING FUNCTIONS	16
KARAOKE FUNCTION	18
TROUBLE SHOOTING	20
WHEN VIDEO IS DISPLAYED THROUGH SET	21
GENERAL INFORMATION ABOUT THE DISC	21
CARE OF PLAYER AND DISCS	21
SPECIFICATIONS	22

WHEN MOISTURE CONDENSATION GETS IN THE UNIT

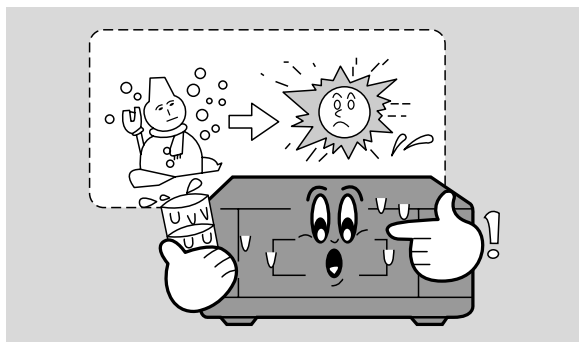

- When the unit is moved from a cold area to a warm area suddenly, moisture may condense on the mechanical parts which restricts the laser signal from normal operation.
- If this occurs, leave the unit with the power turned on for 1-2 hours. (without a disc)

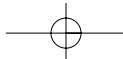

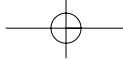

SAFETY INSTRUCTIONS

READ INSTRUCTIONS

- All the safety and operating instructions should be read before the appliance is operated.

RETAIN INSTRUCTIONS

- The safety and operating instructions should be retained for future reference.

HEED WARNINGS

- All warnings on the appliance and in the operating instructions should be adhered to.

FOLLOW INSTRUCTIONS

- All operating and use instructions should be followed.

WATER AND MOISTURE

- Do not use this video product near water—for example, near a bathtub, wash bowl, kitchen sink, or laundry tub, in a wet basement, or near a swimming pool, and the like.

OVERLOADING

- Do not overload wall outlets and extension cords as this can result in the risk of fire or electric shock.

VENTILATION

- Slots and openings in the cabinet are provided for ventilation and to ensure reliable operation of the video product and to protect it from overheating these openings must not be blocked or covered. The openings should never be blocked by placing the video product on a bed, sofa, rug, or other similar surface. This video product should never be placed near or over a radiator or heat register. This video product should not be placed in a built-in installation such as a bookcase or rack unless proper ventilation is provided or the manufacturer's instructions have been followed.

POWER CORD PROTECTION

- Power-supply cords should be routed so that they are not likely to be walked on or pinched by items placed upon or against them paying particular attention to cords at plugs, convenience receptacles, and the point where they exit from the appliance.

CLEANING

- Unplug this video product from the wall outlet before cleaning. Do not use liquid cleaners or aerosol cleaners. Use a damp cloth for cleaning.

LIGHTNING

- For added protection of this video product receiver during a lightning storm, or when it is left unattended and unused for long periods of time, unplug it from the wall outlet and disconnect the antenna or cable system. This will prevent damage to the video product due to lightning and power-line surges.

OBJECT AND LIQUID ENTRY

- Never push objects of any kind into this product through openings as they may touch dangerous

voltage points or short-out parts that could result in a fire or electric shock. Never spill liquid of any kind on the video product.

ACCESSORIES

- Do not place this video product on an unstable cart, stand, tripod, bracket, or table. The video product may fall, causing serious injury to a child or adult, and serious damage to the appliance. Use only with a cart, stand, tripod, bracket, or table recommended by the manufacturer, or sold with the video product. Any mounting of the appliance should follow the manufacturer's instructions and should use a mounting accessory recommended by the manufacturer.

CART

- An appliance and cart combination should be moved with care. Quick stops, excessive force, and uneven surfaces may cause the appliance and cart combination to overturn.

POWER SOURCES

- This video product should be operated only from the type of power source indicated on the marking label. If you are not sure of the type of supply to your home, consult your appliance dealer or local power company. For video products intended to be operated from battery power, or other sources, refer to the operating instructions.

POWER LINES

- An outside antenna system should not be located in the vicinity of overhead power lines or other electric light or power circuits, or where it can fall into such power lines or circuits. When installing an outside antenna system, extreme care should be taken to keep from touching such power lines or circuits as contact with them might be fatal.

POLARIZATION

- This video product is equipped with a polarized alternating current line plug (a plug having one blade wider than the other.) This plug will fit into the power outlet only one way. This is a safety feature. If you are unable to insert the plug fully into the outlet, try reversing the plug. If the plug should still fail to fit, contact your electrician to replace your obsolete outlet. Do not defeat the safety purpose of the polarized plug.

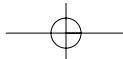

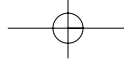

OUTDOOR ANTENNA GROUNDING

- If an outside antenna is connected to the antenna terminal, be sure the antenna system is grounded so as to provide some protection against voltage surges and built-up static charges.
- In the U.S.A section 810 of the National Electrical Code, ANSI/NFPA No. 70-1984, provides information with respect to proper grounding of the mast and supporting structure, grounding of the lead-in wire to an antenna discharge unit, size of grounding conductors location of antenna discharge unit, connection to grounding electrodes, and requirements for the grounding electrode. See the figure below.

ATTACHMENTS

- Do not use attachments not recommended by the video product manufacturer as they may cause hazards.

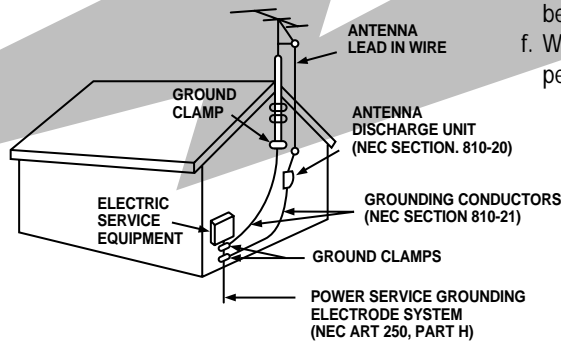

SERVICING

- Do not attempt to service this product yourself as opening or removing covers may expose you to dangerous voltage or other hazards.
- Refer all servicing to qualified service personnel.

REPLACEMENT PARTS

- When replacement parts are required, be sure the service technician has used replacement parts specified by the manufacturer or having the same characteristics as the original part. Unauthorized substitutions may result in fire, electric shock or other hazards.

SAFETY CHECK

- Upon completion of any service or repairs to this video product, ask the service technician to perform safety checks to determine that the video product is in proper operating condition.

DAMAGE REQUIRING SERVICE

- Unplug this video product from the wall outlet and refer servicing to qualified service personnel under the following conditions.
 - a. When the power-supply cord or plug is damaged.
 - b. If liquid has been spilled, or objects have fallen into the video product.
 - c. If the video product has been exposed to rain or water
 - d. If the video product does not operate normally by following the operating instructions. Adjust only those controls that are covered by the operating instructions as an improper adjustment of other controls may result in damage and will often require extensive work by a qualified technician to restore the video product to its normal operation.
 - e. If the video product has been dropped or the cabinet has been damaged.
 - f. When the video product exhibits a distinct change in performance - this indicates a need for service.

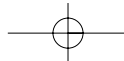

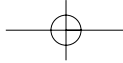

CONTROLS AND COMPONENTS

FRONT PANEL

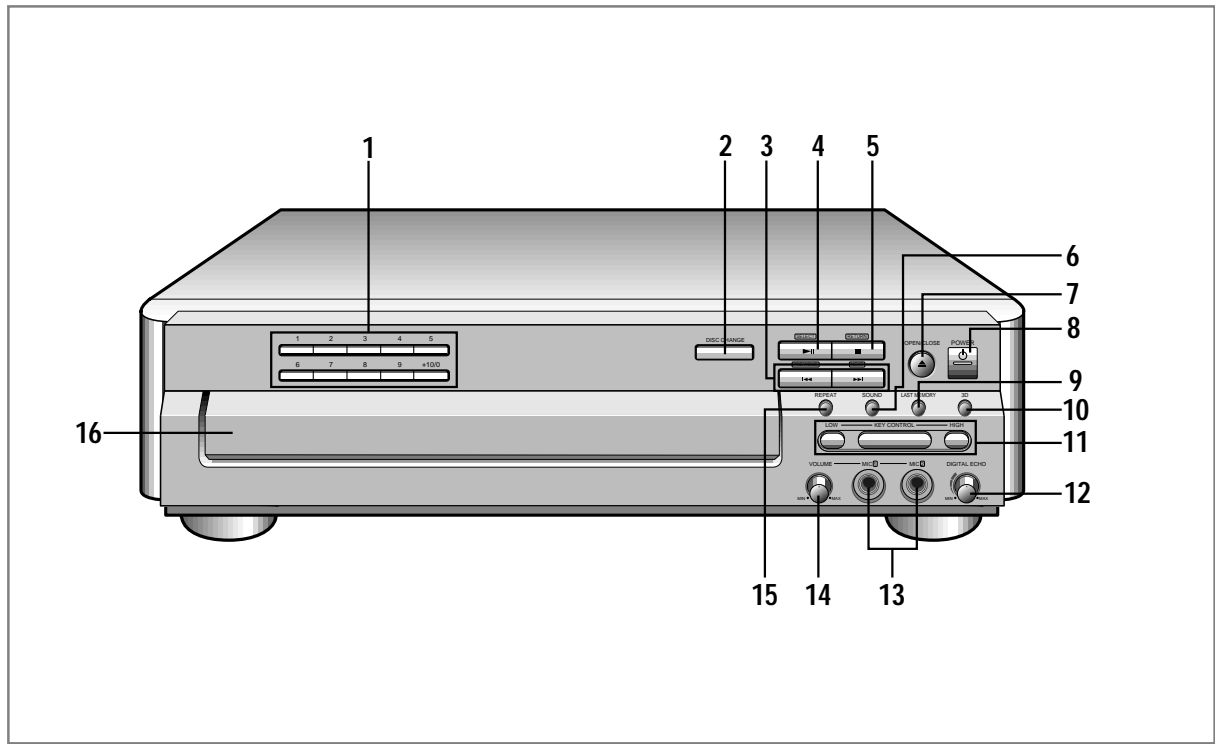

- | | |
|------------------------------|------------------------------|
| 1. DIGIT buttons | 9. LAST MEMORY button |
| 2. DISC CHANGE button | 10. 3D button |
| 3. PREVIOUS/NEXT buttons | 11. KEY CONTROL buttons |
| 4. SELECT(PLAY/PAUSE) button | 12. DIGITAL ECHO VOLUME knob |
| 5. RETURN(STOP) button | 13. MIC jacks |
| 6. SOUND button | 14. MIC VOLUME knob |
| 7. OPEN/CLOSE button | 15. REPEAT button |
| 8. POWER button | 16. DISC TRAY |

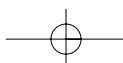

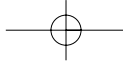

CONTROLS AND COMPONENTS

REAR PANEL

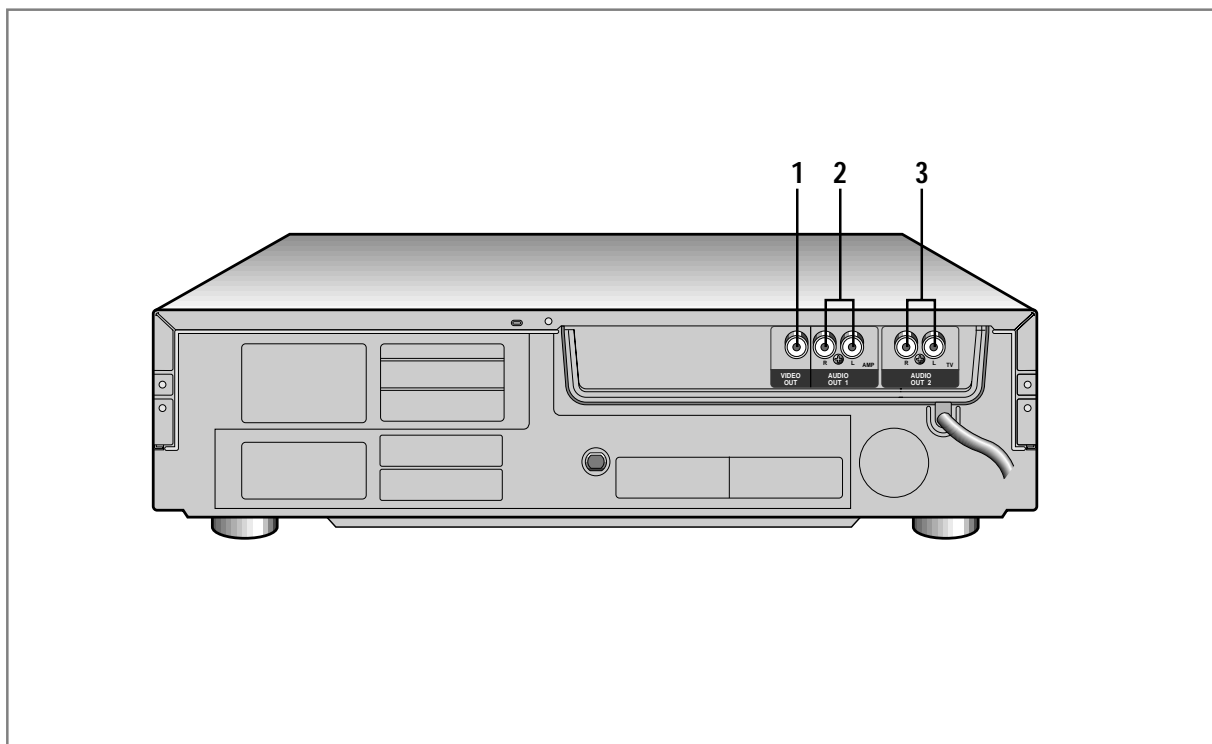





1. VIDEO OUTPUT
- Connect to the VIDEO IN of your TV set.

2. AUDIO OUTPUT (AMP)
- Connect to the AUDIO IN of your STEREO AMPLIFIER.

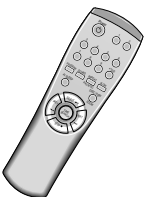
3. AUDIO OUTPUT (TV)
- Connect to the AUDIO IN of your TV set.

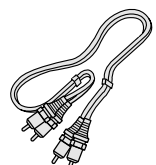
ACCESSORIES

<p>REMOTE CONTROL</p> 	<p>VIDEO CABLE</p> 	<p>AUDIO CABLE</p> 	<p>OWNER'S INSTRUCTIONS</p> 
---	--	---	---

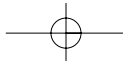

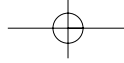

REMOTE CONTROL

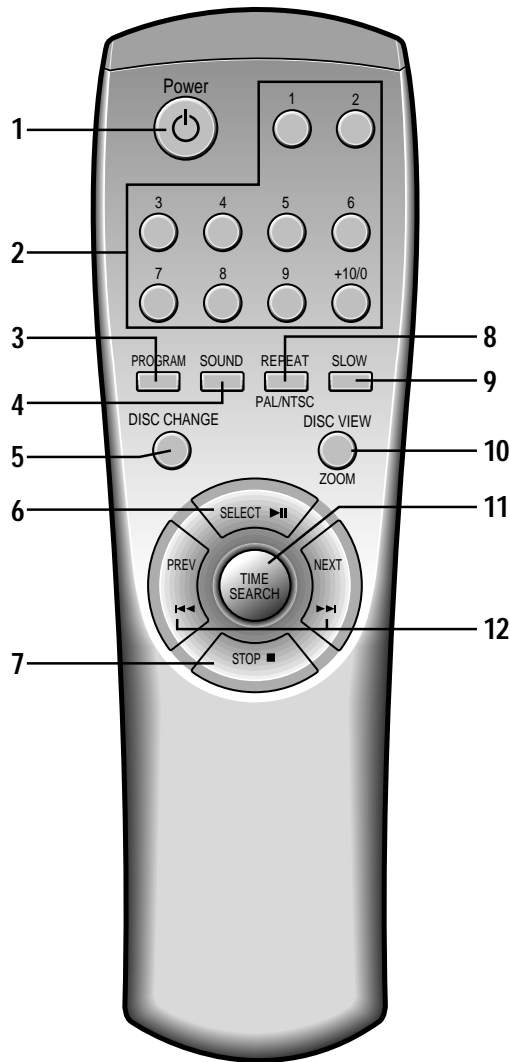

1. POWER button
2. DIGIT buttons
3. PROGRAM button
4. SOUND SELECTOR button
5. DISC CHANGE button
6. SELECT(PLAY / PAUSE) button
7. STOP button
8. REPEAT/PAL/NTSC button
9. SLOW button
10. DISC VIEW/ZOOM button
11. TIME SEARCH(LAST MEMORY) button
12. PREVIOUS / NEXT(SKIP) button

TO INSERT BATTERIES

1 Open the battery compartment cover.

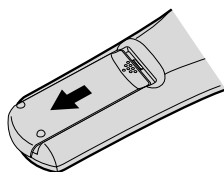

2 Install two "AAA" batteries observing the correct polarity as shown in compartment.

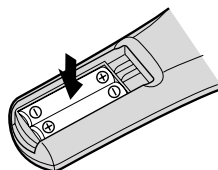

3 Replace the cover.

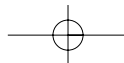
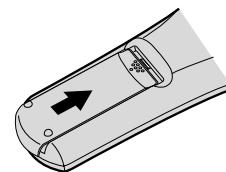

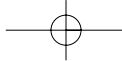

SYSTEM CONNECTIONS

VCD AND CDP + TV

1. Connect AUDIO OUT2 jack of the VCD and CDP to AUDIO IN jack of the TV.
2. Connect VIDEO OUT jack of the VCD and CDP to VIDEO IN jack of the TV.

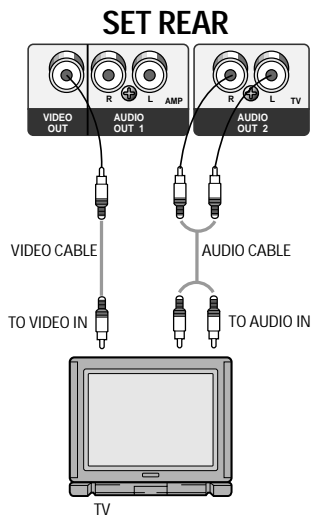

VCD AND CDP + TV + AMPLIFIER

1. Connect VIDEO OUT jack of the VCD and CDP to VIDEO IN jack of the TV.
2. Connect AUDIO OUT1 jack of the VCD and CDP to the AUX or CD INPUT jacks of the AMPLIFIER.

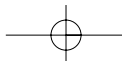
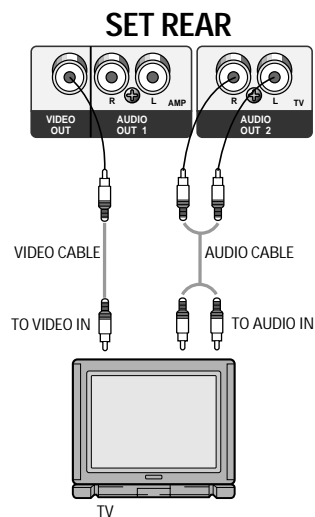

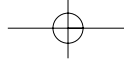

VIDEO-CD PLAYBACK

HOW TO PLAYBACK VIDEO-CD version 2.0

- Turn on the POWER button.

- 1** Press the OPEN/CLOSE button.
- The tray is ejected.

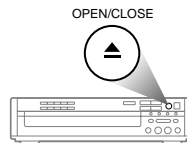

- 2** Insert a VIDEO-CD disc and press the OPEN/CLOSE button.
- Press the DISC CHANGE button for tray No selection.

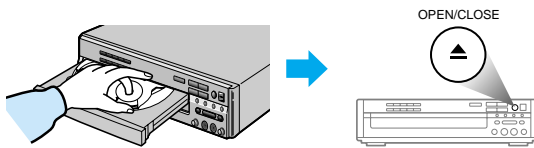

- 3** Press the SELECT (PLAY/PAUSE) button.
- In version 1.1 disc menu is not displayed and play function is operated.
 - Only in version 2.0 disc menu is displayed.
 - If you press directly the digit key at STOP MODE, start to play the track of selected digit No without menu picture (PBC OFF, MENU OFF MODE).
- Ex) When playing a VIDEO-CD version 2.0 disc

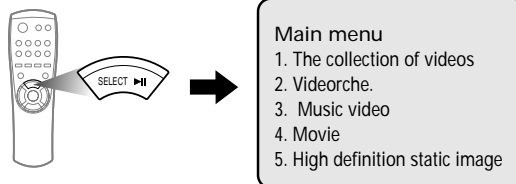

- 4** Select a number from the menu and press it.
- Ex) In the case of selecting No. 1 the collection of videos.

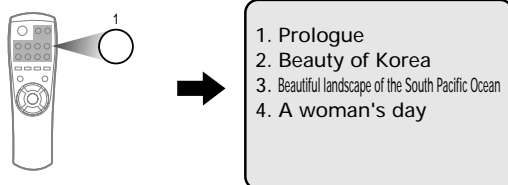

- 5** Select a number from the menu and press it.

Ex) When selecting No. 4 A woman's day.

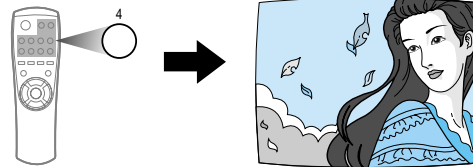

TO RETURN TO THE PREVIOUS MENU

Press the RETURN button.

- When a wrong menu is selected or other menu is about to be selected, hold down the RETURN button more than one second.

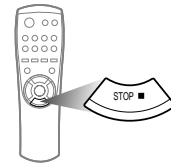

When the RETURN button is pressed shortly in VIDEO-CD version 2.0, the disc may be stopped.

- When you want to stop playing at the VIDEO-CD version 2.0 menu on mode, press the RETURN button short.

Press the NEXT button, the next menu will be displayed.
Press the PREVIOUS button, the previous menu will be displayed.

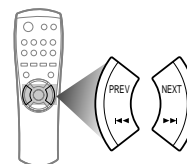

NOTE

In the case of menu mode

- PROGRAM, TIME SEARCH, REPEAT, DISC VIEW functions do not work.

How to select a song or a video without using menu function.

- Select a track number from the disc jacket and press it at the stop mode.
- When playing version 2.0 disc which has no MENU screen, If no play or no picture, Press SELECT button or NEXT button to see MENU screen or the next screen.

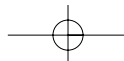

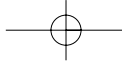

SLOW MOTION

Press the SLOW button on the remote control when the play function is on.

- Voices do not come out when the SLOW MOTION button is pressed
- Slow playing is 1/2 of the normal playing speed at 1st press.
- Slow playing is 1/4 of the normal playing speed at 2nd press.
- Slow playing is 1/8 of the normal playing speed at 3rd press.
- Slow playing is canceled at 4th press.
- The sound is muted during the slow playing.

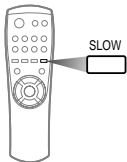

To return to normal operation

- Press the SELECT(PLAY/PAUSE) button.

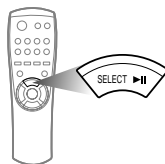

NTSC/PAL SELECTION METHOD

- Press the PAL/NTSC(REPEAT) button for 1 sec or longer. You can matching the picture display on your TV.

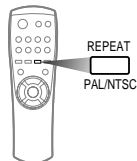

DISC CHANGE FUNCTION

To replace disc during the play

- Press the RETURN(STOP) button.
- Eject the tray by pressing the OPEN/CLOSE button.
- Press the DISC CHANGE button to rotate the tray.

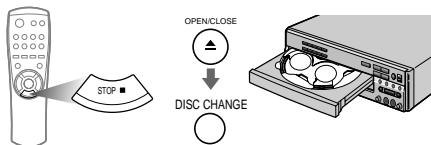

To load additional disc

- Eject the tray by pressing the OPEN/CLOSE button. It plays continuously even though the tray is ejected.
- When the tray is ejected while playing a disc, the tray does not rotate. Therefore, only up to two discs can be loaded.

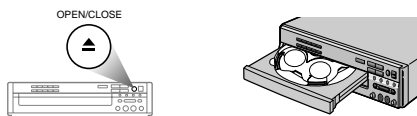

SELECT SOUND TO YOUR PREFERENCE

PREPARATION

1. Press the POWER button.
(The audio is set to the stereo mode automatically)
2. Insert a disc and press the PLAY button.

- 1 Press the SOUND SELECTOR button
 - Every time you press this button, sound changes as show below

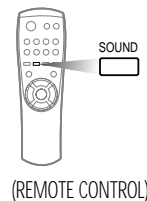

	Screen on your TV monitor	Audio Output	
		L-ch	R-ch
1st press.	L-CH	L-signal	L-signal
2nd press.	R-CH	R-signal	R-signal
3rd press.	STEREO	L-signal	R-signal

- 2 Press the SOUND SELECTOR button.
 - Each time the sound button is pressed for 1 sec or longer, the mode changes as follows.

	TV monitor
1st press. (for 1 sec or longer)	3D
2nd press. (for 1 sec or longer)	LIVE
3rd press. (for 1 sec or longer)	THEATER

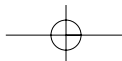

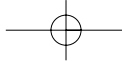

DISC VIEW FUNCTION

- Desired music or video display can be used directly without by menu functions (VER 2.0 Mode). This function is possible in Ver 1.1 and Ver 2.0 menu off mode.

TRACK VIEW

- This function is used for show the first views by nine in track.
ex) VCD 1.1 Version

1 Press the DISC VIEW button.
• DISC VIEW MENU is displayed.

2 Press the DIGIT button 1 to select Track View.
• Nine tracks are presented with sound.

3 Press the DIGIT button to select the desired track.
• The selected track is displayed on the small screen with sound played.
EX) When selecting No 4.

4 Press the SELECT(PLAY/PAUSE) button.
• Displayed in full screen.

In case of cancelling the TRACK VIEW function.

- Repress the DISC VIEW button.
- If playbacks as original case.

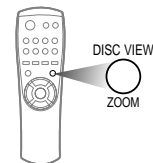

In case the number of tracks is more than ten.

- Press the NEXT button watching the track bellow.
- Press the PREVIOUS button. watching the former track.
- EX) If the disc has 14 tracks.

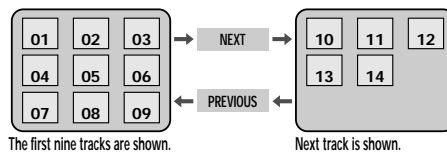

In case of directly selecting the TRACK VIEW function.

- Press the DISC VIEW button in stop state.
- TRACK VIEW function is selected and nine tracks are displayed in screen with sound in sequence.

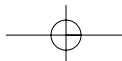
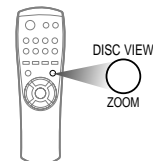

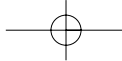

REPEAT FUNCTION

- Turn on the TV.
- Load and play a disc.

INDEX VIEW

- This function acts as displaying the track in playing sequentially by time and so it's convenient for searching desired video.
ex) VCD 1.1 Version

1 Press the PLAY button to playback.

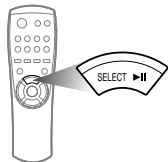

2 Press the DISC VIEW button.
• DISC VIEW MENU is displayed.

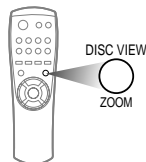

3 After step 1,2 Press the DIGIT button 2 to select Index View.

- The display as dividing into nine equal parts in displayed together with relevant sound.

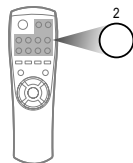

4 Press the DIGIT button to play back the desired part number.

- It's displayed from the selected part in full screen.

1.TO REPEAT ONE TRACK

Press the REPEAT button.

- "REPEAT" indicating the one track repeat lights and the one track is played repeatedly.



2.TO REPEAT ONE DISC

Press the REPEAT button again.

- "REPEAT" indicating the one disc repeat lights and the one disc is played repeatedly.



3.TO REPEAT ALL DISCS

Press the Repeat button three times.

- "REPEAT" indicating the all discs repeat lights and all of the discs are played repeatedly.



4.TO END REPEAT PLAY

Press the Repeat button at the all discs repeat mode

- "REPEAT" indicator will be turned off and it becomes all discs continuous play mode.

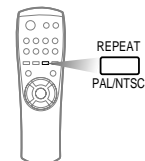

5.TO SELECT VIDEO OUTPUT

At STOP mode ,press the Repeat(PAL/NTSC) button more than one second,then it is converted to " PAL NTSC "

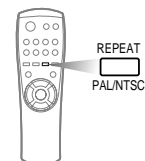

and select the type you want.

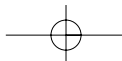

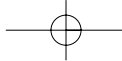

PROGRAM FUNCTION

- This function can program up to 30 tracks during STOP mode.

ex) To program No.4 track of No.2 disc

1 Press the PROGRAM button.

2 Select the disc by pressing the DISC CHANGE button.

- Press the DISC CHANGE button.

3 Press the track number to be programmed.

- Press the digit buttons.
- Ex) Select track 4

4 In a second

- After step 3, you must press the PROGRAM button again then the selected number (2-04) is programmed.
- Up to 30 tracks can be programmed by repeating step 2 to 4.

5 Press the PLAY/PAUSE button.

- Programming is completed, and the first track of the program is played.
- When the Previous/NEXT button is pressed, the next or previous programmed track is played.

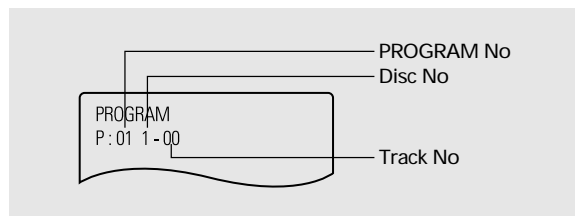

NOTE

- If the PROGRAM button is pressed during programming, it can not be programmed anymore, press again to continue.
- To escape program function, Press the OPEN/CLOSE button, or press the STOP button two times.

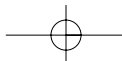

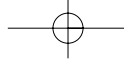

ZOOM FUNCTION

- This function works only in the VCD play mode.

- 1** Press the DISC VIEW/ZOOM key for 1 sec or longer to change the screen to 2 x ZOOM.

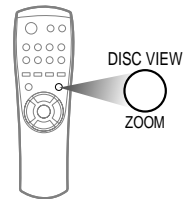

- 2** While in the 2 x ZOOM screen, press the DISC VIEW/ZOOM key for 1 sec or longer again to change the screen to 4 x ZOOM.

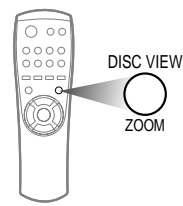

- 3** While in the stage of No.1 or No.2 above, press the ◀◀, ▶▶, ■, ▶▶ key to scroll the screen to the left, right, up, or down.

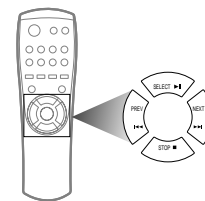

- 4** While in the 4 x ZOOM, Press the DISC VIEW/ZOOM button for 1 sec or longer, and display normal picture.

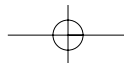
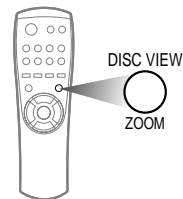

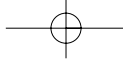

SEARCHING FUNCTIONS

- Turn on the TV.
- Load and play the disc.

HIGH SPEED SEARCH

- This function is used to searching disc for desired location. Press and hold down the Search button during the play.
- Hold down the PREV./NEXT button on the front panel more than one second.

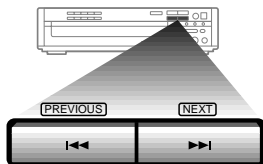

NOTE

In case of high speed search

- When searching a CD disc, the volume is lowered and it advances in high speed.
- If the search does not operate properly due to the noise, release the button momentarily and press it again.
- When the search for a VIDEO-CD is released, mosaic screen might appear or the screen might advance slower than the audio for a short period of time.

To play normally

- When the pressed button is released, it returns to the normal play.

SKIP

Press the PREVIOUS/NEXT(◀◀, ▶▶) buttons.

- Press the PREV./NEXT(◀◀, ▶▶) button on the front panel repeatedly within one second.
- When the PREVIOUS/NEXT button is pressed, it quickly advances to the PREVIOUS/NEXT Track.
- When the "◀◀" button is pressed, it returns to the beginning of the currently playing track. If pressed again, it returns to the previous track.
- Picture moves to the beginning of the next track whenever "▶▶" button is pressed.
- When the PREVIOUS or NEXT button is pressed while playing a disc such as a movie disc, it quickly advances 5 minutes in the forward/reverse direction.

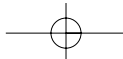
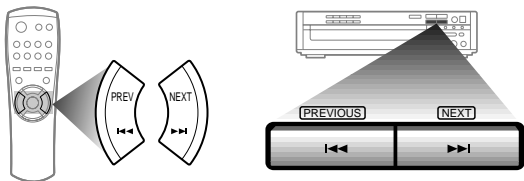

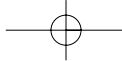

TIME SEARCH

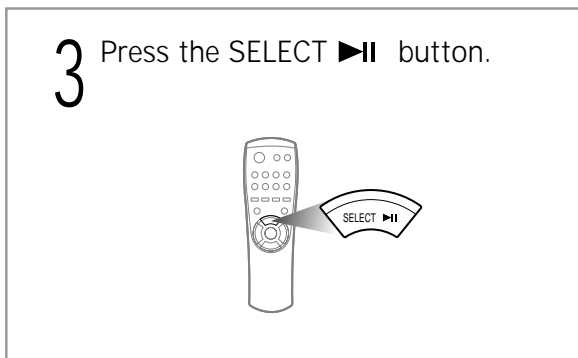
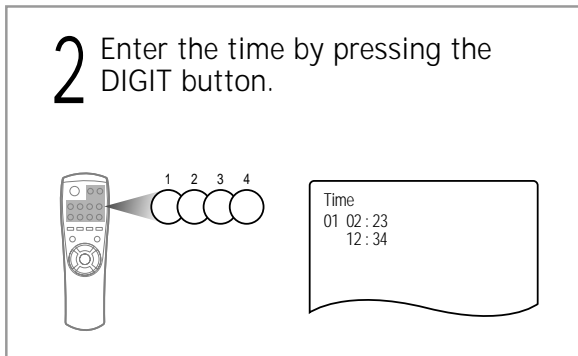
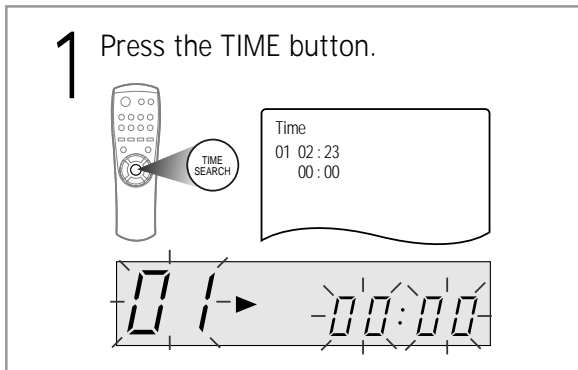

NOTE

1. If entering the time is greater than total time of the disc, it will not be entered.
2. If entering the time is greater than track time it will play next track.
3. This function works only for playing mode.
4. This function can operate only for Menu off mode of VIDEO-CD.

LAST MEMORY FUNCTION

- If you press the STOP or POWER button during VIDEO-CD playback, a playback position slightly ahead of the current time is stored in the unit's memory.
- You can easily find the memorized position just press the TIME SEARCH button.

METHOD

- When you press the STOP or POWER button to finish the operation,
- Press TIME SEARCH button and this unit will search for original position.

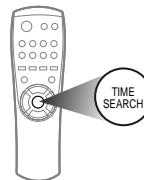

NOTE

1. Last memory play is always operated as menu off mode even if last status is menu on.
2. If you press stop and open, this function will be cancelled.

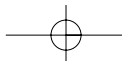

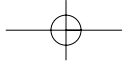

KARAOKE FUNCTION

- Turn on the TV.
- Load and play a disc.

1 Connect the MIC.
 • The key control will be displayed on the screen.

2 Load a disc and select a desired track.
 • Eject the tray by pressing the OPEN/CLOSE button, load a disc and close the tray.

3 Use the microphone.
 • Two microphones can be used at the same time.

KEY CONTROL FUNCTION

- Make sure to be at the karaoke mode.

Press the Key Control button

- Press the KEY CONTROL button to adjust the key to suit to your voice. (the 25 step key control)

ex) In case of pressing # :

On screen Display will disappear in 3 seconds.

ex) In case of pressing # once more:

NOTE

- Depending on a type of VIDEO-CD 2.0 disc, it may be not operated KEY CONTROL FUNCTION in still picture.

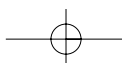

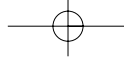

Adjust the DIGITAL ECHO.

- This will add an echo to your voice, giving you the feeling of singing on stage, Adjust it as desired.

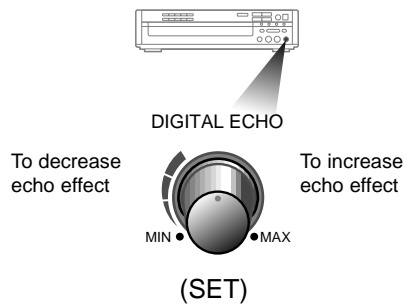

To decrease or increase the volume of the Microphone:

- Turning to the left decreases Volume.
- Turning to the right increases Volume.



If howling occurs:

- Reduce the microphone volume.
- Change the direction that the microphone faces.
- Move the microphone away from the speaker.

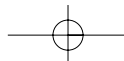

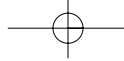

TROUBLE SHOOTING

SYMPTOM	CHECK AND ACTION
Tray is not ejected.	-Check if the power is turned on.
The unit does not play	-Check if a disc is loaded.
Tray is ejected.	-Check if a disc is contaminated or damaged. Remove disc, clean it and insert again. -Check if a disc is seated properly.
Video or audio is muted, or tray is ejected after 2-5 seconds.	-Check for condensation in unit. -Removed disc, leave the unit with the power turned on for 1-2 hours. The unit will operate only after the condensation is cleared.
Picture appears late when SELECT(PLAY/PAUSE) button is pressed.	-Repeated pressing of PLAY/STOP/OPEN caused disc drive motor to over heat, and protection circuit activated until motor cools down.
Does not have video although disc is turned.	-Check if TV power is turned on. -Check if connection is secure. -Check if the unit is bypassed.
Picture shakes vertically.	-Picture may shakes momentarily during transition from dark to bright.
Picture quality of a particular disc is poor and picture shakes	-Check if disc is damaged or deformed. -Check if disc is contaminated.
SKIP or SEARCH takes too much time.	-Some discs may require longer time to read encoded information. -Check disc.
TIME SEARCH searches different time.	-Check if disc is contaminated or deformed. -When picture shakes disc may be contaminated or deformed causing malfunction. Clean disc
After pressing the SELECT(PLAY/PAUSE) button, there is a long delay before picture appears on screen.	-If the PLAY/STOP/OPEN/DISC CHANGE operations are repeated within short period of time, the Disc Drive Motor overheats. The disc will not rotate until the motor cools down. This is a normal condition. Wait a few minutes for the motor to cool down.
The disc rotates well, but you do not have picture on the screen, You can see the picture on screen, but the quality is poor and the picture shakes.	-Check if the TV power is turn ON. -Check if the connection is good. -Check if the disc is in good condition.
No sound	-Check if disc is loaded upside down. -Insert disc with label side up. -Check if disc is severely deformed. Clean the disc

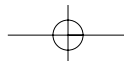

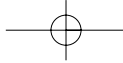

WHEN VIDEO IS DISPLAYED THROUGH SET



- Source : VIDEO-CD DISC
- Display :TV monitor

SET MODE	TV SYSTEM	DISC	DISPLAY	REMARK
PAL	PAL	PAL	OK	PAL 50Hz
		NTSC	OK	PAL 50Hz
	NTSC	PAL	NG	No sync
		NTSC	NG	No sync
NTSC	PAL	PAL	NG	No color
		NTSC	NG	No color
	NTSC	PAL	OK	
		NTSC	OK	NTSC 60Hz

* Color or sync is in trouble according to TV set.

GENERAL INFORMATION ABOUT THE DISC

GENERAL INFORMATION ABOUT THE DISC

Compact Disc 8cm (3 inch) 	Digital Audio (Max. 20 min.) Single
Compact Disc (CD) 12cm (5 inch) 	Digital Audio (Max: 74min) Single
Video Compact Disc 74min.) (VCD) 12cm (5 inch) 	Digital Video and Audio (Max. Single

CARE OF PLAYER AND DISCS

CARE OF DISCS

Use a soft, dry cloth for cleaning.



Clean the disc with water diluted with neutral detergent solution and wipe from inside to outside using dry cloth.

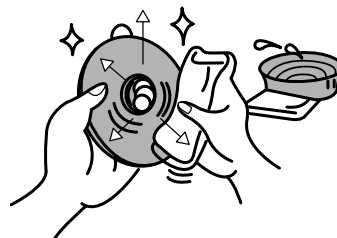

Store a disc away from direct sunlight or heat source.

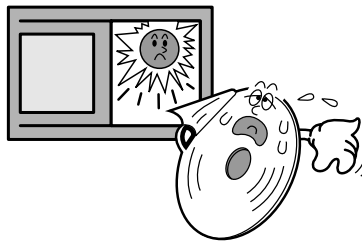

Keep the disc free from dust.

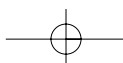
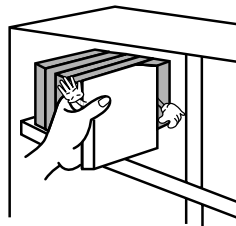

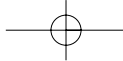

CARE OF PLAYER AND DISCS

Cleaning the Player

- Use soft cloth or the dusting attachment of your vacuum cleaner to dust the exposed surface of the player. Use the vacuum cleaner attachment to remove dust from the ventilation holes on the top, back, sides, and bottom of the cabinet.

- Some of plastic surfaces are easily scratched, and they can be marred by alcohol and various solvents. Avoid excessive use of oil-based furniture polishes since the materials used in the cabinet are non-porous and the residue will accumulate more dust.

CARE OF DISC

Handling Discs

- When loading or removing discs, do not touch the playing surface.

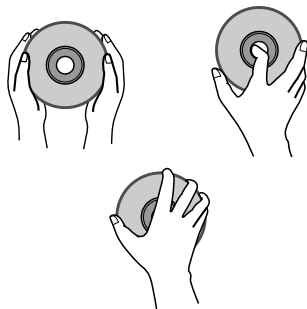

DO NOT PLAY CRACKED OR WARPED DISCS.

- Never play cracked, scratched, or warped disc. This may damage the player cause it to malfunction.

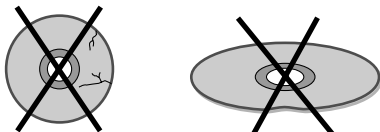

SPECIFICATIONS

GENERAL SPECIFICATIONS		-Power consumption: 8W -Weight: 3.7 kg -Dimensions 420 (W) x334 (D) x 111 (H) mm -Operating temperature: +5°C--+35°C (41°F-95°F)	
DISC USABLE		NTSC/PAL	
CD	12cm	single	74 min
	8 cm	single	20 min
VCD	12cm single	Audio + Video	74 min
VIDEO OUTPUT		-Output level: 1Vp-p (for 75 ohm load) 1channel	
AUDIO OUTPUT		-2 Channels (L/R) -Output1 level: 2 Vrms (1KHz, 0 dB) -Output2 level: 0.5 Vrms (1KHz, 0 dB) -Audio characteristics: frequency response: 20Hz-20KHz Signal to Noise: 85dB total harmonic distortion: 0.1%(at 1KHz, 0dB)	



