

The background features several large, light gray, abstract geometric shapes. On the left, there is a large, stylized arrow pointing to the left. To the right, there are several curved, wavy lines and shapes that resemble stylized letters or symbols, such as a 'Z' and a 'P'.

Macintosh Performa User's Guide

.....

Includes setup, troubleshooting, and important health-related information for Macintosh Performa 600 series computers

 Apple Computer, Inc.

© 1995 Apple Computer, Inc. All rights reserved.

Under the copyright laws, this manual may not be copied, in whole or in part, without the written consent of Apple. Your rights to the software are governed by the accompanying software license agreement.

The Apple logo is a trademark of Apple Computer, Inc., registered in the U.S. and other countries. Use of the “keyboard” Apple logo (Option-Shift-K) for commercial purposes without the prior written consent of Apple may constitute trademark infringement and unfair competition in violation of federal and state laws.

Every effort has been made to ensure that the information in this manual is accurate. Apple is not responsible for printing or clerical errors.

Apple Computer, Inc.
1 Infinite Loop
Cupertino, CA 95014-2084
(408) 996-1010

Apple, the Apple logo, LaserWriter, LocalTalk, Macintosh, Performa, and PlainTalk are trademarks of Apple Computer, Inc., registered in the U.S. and other countries.

Apple Backup, Apple Desktop Bus, Apple Restore, AppleScript, Balloon Help, Disk First Aid, Extensions Manager, Finder, Macintosh PC Exchange, PowerTalk, and QuickDraw are trademarks of Apple Computer, Inc.

Adobe, Adobe Illustrator, Adobe Photoshop, and PostScript are trademarks of Adobe Systems Incorporated, which may be registered in certain jurisdictions.

ExposurePro is a registered trademark of Baseline Publishing, Inc.

Helvetica and Times are registered trademarks of Linotype Company.

IBM is a registered trademark of International Business Machines Corporation.

QMS is a registered trademark of QMS, Inc.

QuarkXPress is a registered trademark of Quark, Inc.

SuperPaint is a registered trademark of Aldus Corporation.

Tektronix is a registered trademark of Tektronix, Inc.

Simultaneously published in the United States and Canada.

Mention of third-party products is for informational purposes only and constitutes neither an endorsement nor a recommendation. Apple assumes no responsibility with regard to the performance or use of these products.



Contents

Communications regulation information vi

1 Getting Started 1

- Plugging in the computer 1
- Installing an expansion card 3
- Connecting a monitor 3
- Connecting the mouse and keyboard 6
- Connecting other equipment 8
- Turning the computer on 9
- Problems turning your computer on? 11
- What's next? 12
- Learning the basics 13
- Reviewing the basics 14
- Turning the computer off 15
- Where to find answers 17

2 Getting Help 19

- Getting answers to your questions 20
- Identifying objects on the screen 28
- Learning useful shortcuts 29

3	Connecting Additional Equipment	31
	Where to connect additional equipment	32
	Connecting an Apple PlainTalk Microphone	33
	Connecting external stereo speakers	34
	Expanding memory	36
	Installing internal drives	36
4	Using Programs and Backing Up Disks	37
	Installing application programs	38
	Working with several programs at a time	39
	Protecting the information on a disk	40
	Restoring the information on your hard disk	46
5	Troubleshooting	49
	When you have questions	49
	When you run into trouble	49
	Solutions to common problems	53
	Repairing a damaged disk	64
	Initializing a hard disk	71
	Installing or reinstalling system software	73

Appendix A	Health, Safety, and Maintenance Tips	75
	Health-related information about computer use	75
	Safety instructions	80
	Handling your computer equipment	81
	Cleaning your equipment	85
	Locking and unlocking the mouse	87
Appendix B	Installing an Expansion Card	89
	Opening the computer	91
	Installing a processor-direct slot (PDS) card	94
	Installing a communication card	95
	Closing the computer	97
Appendix C	Special Keys on Your Keyboard	101
	Typing special characters and symbols	103
	Special key combinations	104
	Index	105

Communications regulation information

FCC statement

This equipment has been tested and found to comply with the limits for a Class B digital device in accordance with the specifications in Part 15 of FCC rules. See instructions if interference to radio or television reception is suspected.

Radio and television interference

The equipment described in this manual generates, uses, and can radiate radio-frequency energy. If it is not installed and used properly—that is, in strict accordance with Apple’s instructions—it may cause interference with radio and television reception.

This equipment has been tested and found to comply with the limits for a Class B digital device in accordance with the specifications in Part 15 of FCC rules. These specifications are designed to provide reasonable protection against such interference in a residential installation. However, there is no guarantee that interference will not occur in a particular installation.

You can determine whether your computer system is causing interference by turning it off. If the interference stops, it was probably caused by the computer or one of the peripheral devices.

If your computer system does cause interference to radio or television reception, try to correct the interference by using one or more of the following measures:

- Turn the television or radio antenna until the interference stops.
- Move the computer to one side or the other of the television or radio.
- Move the computer farther away from the television or radio.
- Plug the computer into an outlet that is on a different circuit from the television or radio. (That is, make certain the computer and the television or radio are on circuits controlled by different circuit breakers or fuses.)

If necessary, consult an Apple-authorized service provider or Apple. See the service and support information that came with your Apple product. Or, consult an experienced radio/television technician for additional suggestions. You may find the following booklet helpful: *Interference Handbook* (stock number 004-000-00493-1). This booklet, prepared by the Federal Communications Commission, is available from the U.S. Government Printing Office, Washington, DC 20402.

IMPORTANT Changes or modifications to this product not authorized by Apple Computer, Inc., could void the FCC Certification and negate your authority to operate the product.

This product was tested for FCC compliance under conditions that included the use of Apple peripheral devices and Apple shielded cables and connectors between system components. It is important that you use Apple peripheral devices and shielded cables and connectors between system components to reduce the possibility of causing interference to radios, television sets, and other electronic devices. You can obtain Apple peripheral devices and the proper shielded cables and connectors through an Apple-authorized dealer. For non-Apple peripheral devices, contact the manufacturer or dealer for assistance.

DOC statement

DOC Class B Compliance This digital apparatus does not exceed the Class B limits for radio noise emissions from digital apparatus as set out in the interference-causing equipment standard entitled “Digital Apparatus,” ICES-003 of the Department of Communications.

Observation des normes—Classe B Cet appareil numérique respecte les limites de bruits radioélectriques applicables aux appareils numériques de Classe B prescrites dans la norme sur le matériel brouilleur : “Appareils Numériques”, NMB-003 édictée par le ministre des Communications.

VCCI statement

情報処理装置等電波障害自主規制について

この装置は、第二種情報装置（住宅地域又はその隣接した地域において使用されるべき情報装置）で住宅地域での電波障害防止を目的とした情報処理装置等電波障害自主規制協議会（VCCI）基準に適合しております。

しかし、本装置をラジオ、テレビジョン受信機に近接してご使用になると、受信障害の原因となることがあります。

取扱説明書に従って正しい取り扱いをしてください。

CD-ROM drive

WARNING Making adjustments or performing procedures other than those specified in your equipment’s manual may result in hazardous exposure.

WARNING Do not attempt to disassemble the cabinet containing the laser. The laser beam used in this product is harmful to the eyes. The use of optical instruments, such as magnifying lenses, with this product increases the potential hazard to your eyes. For your safety, have this equipment serviced only by an Apple-authorized service provider.

If you have an internal Apple CD-ROM drive in your computer, your computer is a Class 1 laser product. The Class 1 label, located on the computer, indicates that the drive meets minimum safety requirements. A service warning label is on the CD-ROM drive inside the computer.



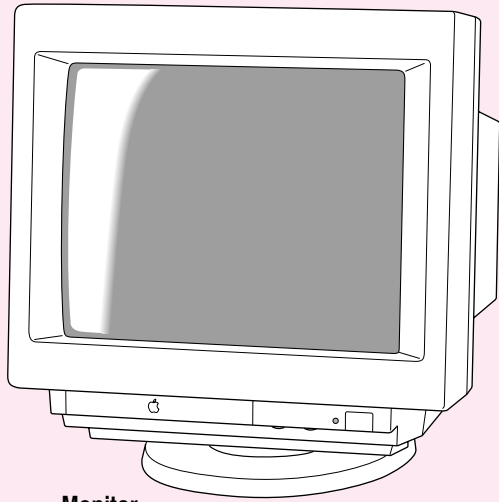

Monitor

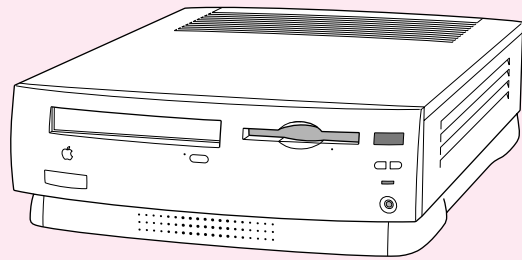

Macintosh Performa computer

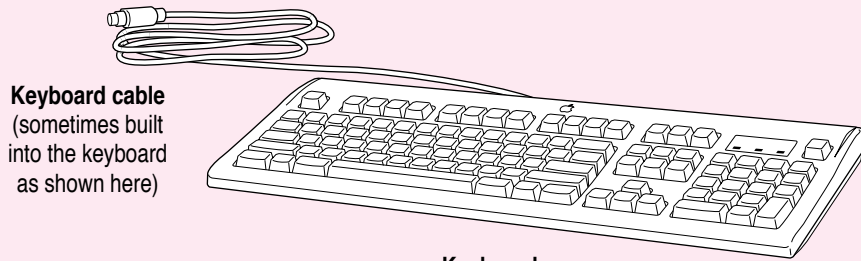

Keyboard cable
(sometimes built into the keyboard as shown here)

Keyboard

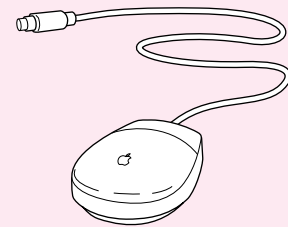

Mouse

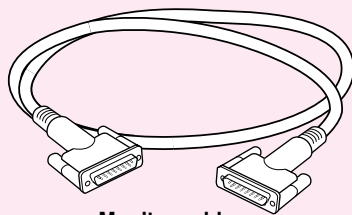

Monitor cable
(sometimes built into the monitor)

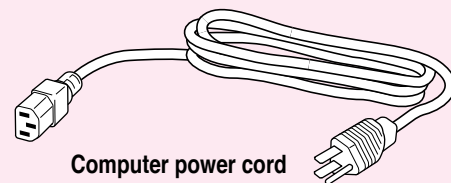

Computer power cord

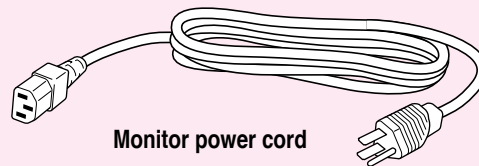

Monitor power cord

Follow the instructions in this chapter to set up your computer and learn the basics.



Getting Started



The illustration on the facing page shows all the equipment you will need to set up your computer and begin using it. Place your equipment on a sturdy, flat surface near a grounded wall outlet. Before following the setup instructions in this chapter, you may want to read “Arranging Your Office” in Appendix A (in the section on health-related information) for tips on adjusting your work furniture so that you’re comfortable when using the computer.

Plugging in the computer

Before you plug your Macintosh into a wall socket (and before you connect anything else to your Macintosh), carefully read all the setup instructions in this chapter. Then, begin by plugging in the computer according to the instructions that follow. The plug grounds the computer and protects it from electrical damage while you are setting up.

When you are ready to begin, follow these steps:

- 1 Plug the socket end of the computer's power cord into the recessed power cord socket (marked with the symbol ~) on the back of the computer.**
- 2 Plug the other end of the power cord into a three-hole grounded outlet or power strip.**

Choose a power outlet to which you have easy access.

WARNING This equipment is intended to be electrically grounded. Your Macintosh is equipped with a three-wire grounding plug—a plug that has a third (grounding) pin. This plug will fit only a grounded AC outlet. This is a safety feature. If you are unable to insert the plug into the outlet, contact a licensed electrician to replace the outlet with a properly grounded outlet. Do not defeat the purpose of the grounding plug!

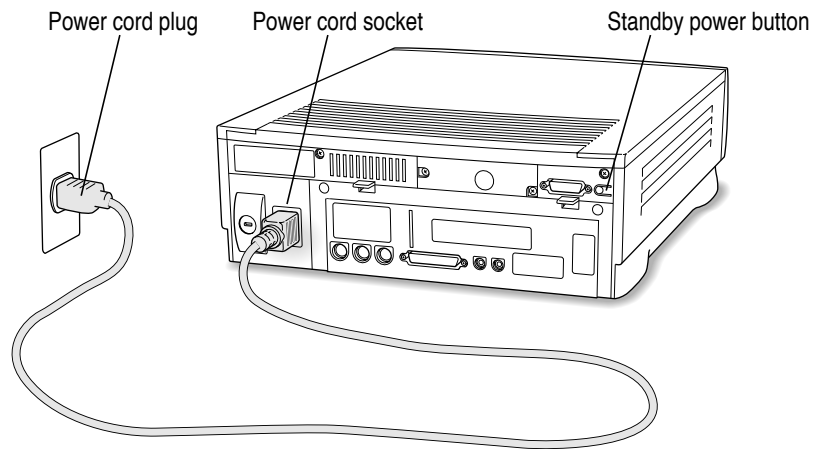

IMPORTANT Be sure that at least one end of the power cord is within easy reach so that you can unplug the computer when you need to.

If the computer starts up: If you hear a tone, the computer has started up and you need to turn it off before proceeding. Press the power button (also called the standby power button) located on the back of the computer to turn the computer off.

Installing an expansion card

If you purchased any expansion cards separately from your Macintosh, install them now. (For instructions, see Appendix B, “Installing an Expansion Card,” as well as the documentation that came with the cards.) If you don’t have an expansion card, go on to the next section, “Connecting a Monitor.”

Connecting a monitor

You can connect many types of monitors to your Macintosh. To connect a monitor from a manufacturer other than Apple, refer to the instructions that came with the monitor.

Connecting the monitor power cord

Monitors have two cords to connect—a power cord and a monitor cable.

To connect the monitor power cord, follow these steps:

1 Place the monitor where you will be using it.

You may place it on top of your computer. Keep these considerations in mind:

- Allow a few inches for air circulation around the sides of the computer and monitor.
- Make sure that the top of the screen is slightly below eye level when you’re sitting at the keyboard.
- Position the monitor to minimize glare and reflections on the screen from overhead lights and windows.
- Consult “Arranging Your Office” in Appendix A for suggestions on locating your computer equipment.

2 Connect the monitor power cord to the monitor.

On some monitors, the cord is already attached.

3 Plug in the monitor power cord.

Be sure to plug the power cord into a three-hole grounded outlet or power strip.

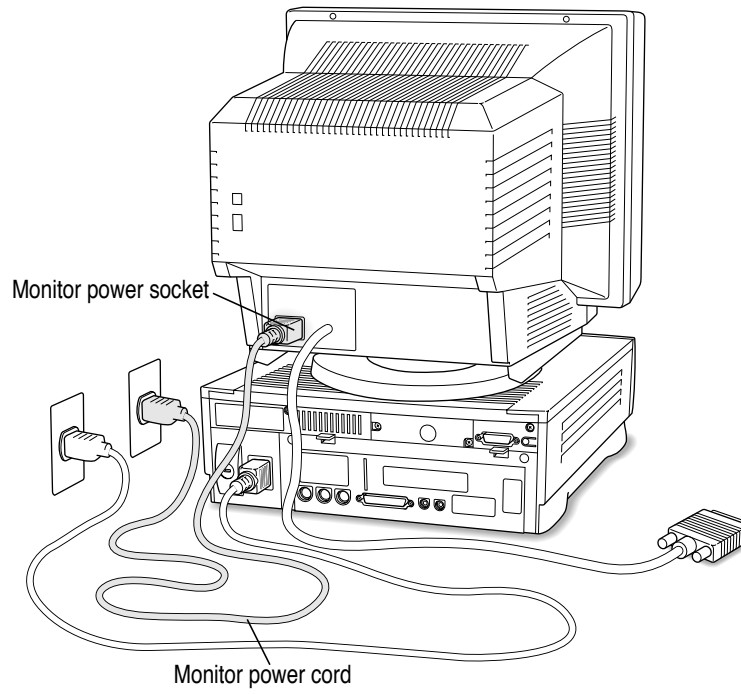

Connecting the monitor cable

After you plug in the monitor power cord, you connect the monitor cable to the computer's monitor port.

To connect the monitor cable, follow these steps:

- 1 Attach the monitor cable to the monitor.**

On some monitors, the cable is already attached (as shown below).

- 2 Attach the monitor cable to the monitor port on the back panel of the computer.**

The monitor port is marked with the  icon (symbol).

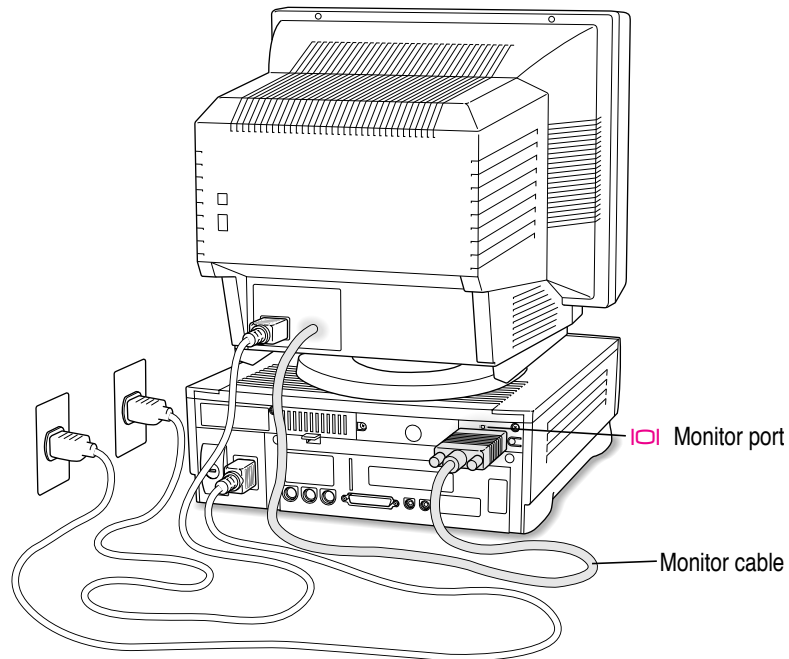



Connecting the mouse and keyboard

You have a choice of several keyboards for your Macintosh. The way you connect the mouse and keyboard depends on whether the keyboard has a separate cable or a built-in cable.

Connecting a keyboard with a built-in cable

- 1 Plug the mouse cable into the recessed port on the back of the keyboard.**

The plug and the port are marked with the  icon (symbol). The positions of the port and icon on your keyboard may be different from those pictured.

By the way: A port marked with the  icon is called an Apple Desktop Bus (ADB) port.

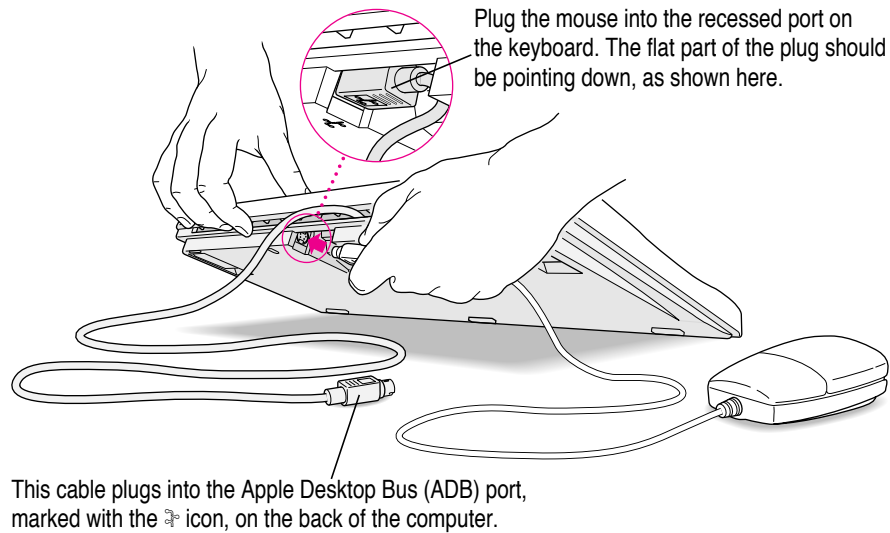

- 2 Plug the keyboard cable into the port marked with the  icon on the back of the computer.**

Some monitors have a port to which you can connect the keyboard or mouse. See the information that came with your monitor.

Connecting a keyboard with a separate cable

- 1 **Plug the mouse cable into the port on either side of the keyboard.**

Most right-handed people prefer to use the mouse with their right hand; most left-handed people prefer to use their left hand. Plug the mouse into the port on the side you prefer.

The plug and the port are marked with the  icon (symbol). Align the symbols before you insert the plug. (The positions of the port and icon on your keyboard may be different from those pictured here.)

By the way: A port marked with the  icon is called an Apple Desktop Bus (ADB) port.

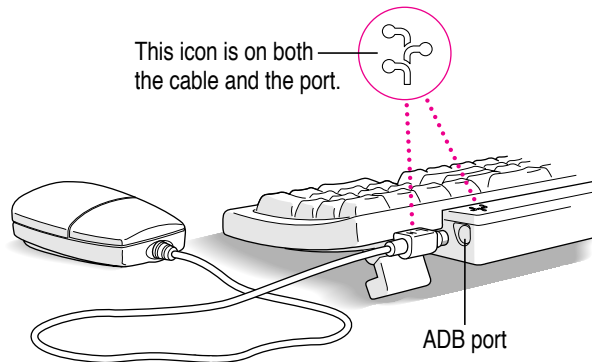

- 2 **Plug the keyboard cable (both ends are the same) into the other port on the keyboard.**

If you plugged the mouse cable in on the right, for example, plug the keyboard cable in on the left.

- 3 **Plug the keyboard cable into the port marked with the  icon on the back of the computer.**

Some monitors have a port to which you can connect the keyboard or mouse. See the information that came with your monitor.

Connecting other equipment

If you are new to the Macintosh, it's a good idea to get some experience using your computer before you connect other equipment, such as a printer or scanner. To learn basic Macintosh skills, continue with the instructions in this chapter.

When you're ready to connect other equipment to your Macintosh, see the instructions in Chapter 3.



Turning the computer on

Follow these steps to turn the computer on:

1 Turn on the monitor.

See the information that came with your monitor for the location of the power button.

2 Turn on your computer by pressing the Power key.

The Power key is at the top of the keyboard. You can recognize this key by the triangle outline on it (◁).

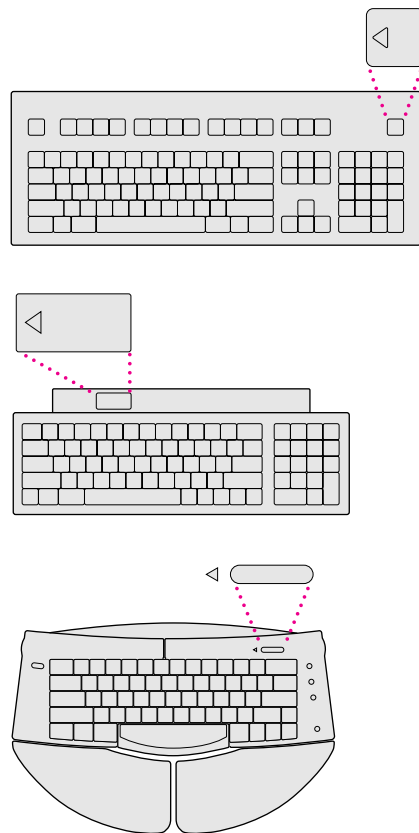

You hear a tone from the computer as it starts up.

3 Check to see what's on your screen.

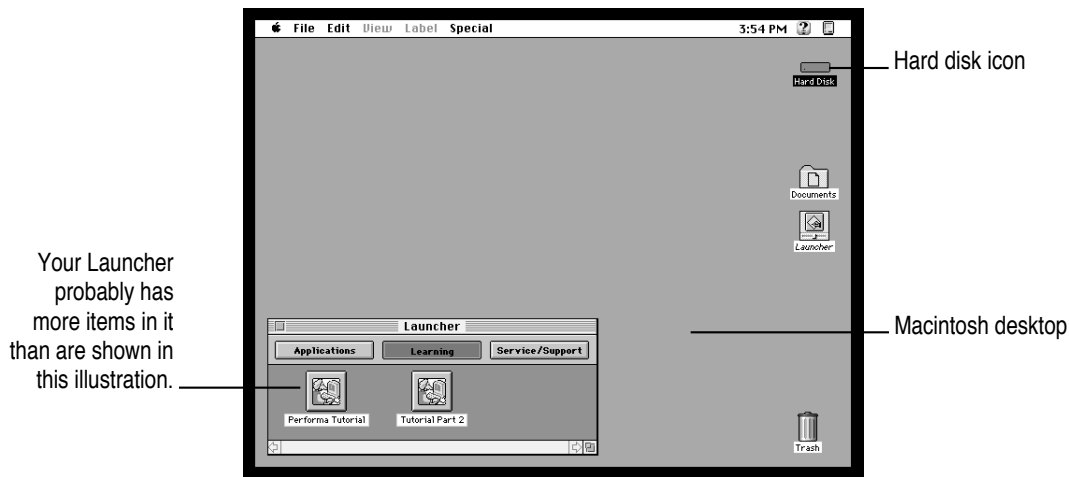

- If you see the Macintosh desktop, as in the illustration below, your system software has already been installed, and your computer is ready to use. Skip now to the section “What's Next?” later in this chapter.



- If you see a blinking question mark, you probably need to install system software on your computer's hard disk. (System software is the set of programs your computer uses to start itself up.) See “Solutions to Common Problems” in Chapter 5.
- If you see anything else on your screen, or nothing at all, see the next section, “Problems Turning Your Computer On?”

Problems turning your computer on?

If you don't see anything on the screen, check these items to see if you can identify the problem:

- Is the computer plugged into a power source? If it is plugged into a power strip, is the power strip turned on?
- Is the computer turned on? The power-on light on the front panel should be on. If it isn't on, press the standby power button on the computer's back panel (marked with the symbol .
- Are the keyboard and mouse cables connected correctly? (Don't disconnect the keyboard or mouse cable while the computer is on. You could damage your equipment.)
- Is the monitor power cord plugged in?
- Is the monitor turned on? (Check the power-on light on the front of the monitor.)
- Is the monitor cable attached firmly to both the monitor and computer?
- Is the brightness control on the monitor adjusted correctly? (On Apple monitors, the brightness control is marked with the symbol .)

What's next?

Congratulations! You've finished setting up your computer. Now continue with one of the following steps:

- If you are new to the Macintosh, turn to the next section, “Learning the Basics.”
- If you are an experienced Macintosh user, turn to Chapter 2, “Getting Help,” to learn about Macintosh Guide, your main source of information when you're working with the Macintosh.
- If you want to connect other equipment, such as a printer, to your computer, see Chapter 3, “Connecting Additional Equipment.”

Before you begin working with your computer, be sure to read the important health and safety information in Appendix A.

IMPORTANT If you need to turn off your computer at any point, please see “Turning the Computer Off” later in this chapter. It is very important to use the correct procedure for shutting down your Macintosh before turning it off.

Learning the basics

If you are new to the Macintosh, you should begin by looking at the easy-to-use program called the Performa Tutorial. The two-part tutorial teaches you the basic skills you'll need to use your computer. To start the tutorial, follow these steps:

1 Slide your mouse along your mouse pad or desk.

Hold the mouse as shown, with the cable pointing away from you. Don't press the mouse button (under your index finger). Notice that the arrow (␞) on the screen moves in the same direction that you move the mouse.

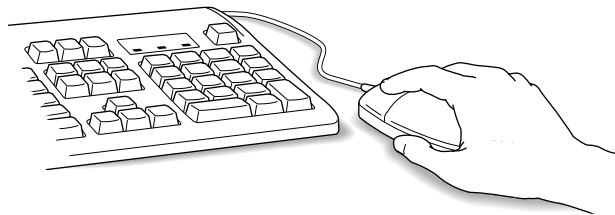

If the arrow doesn't move, make sure that the cables connecting the mouse and keyboard are secure and that your mouse is positioned as shown in the illustration.

2 Move the mouse so that the arrow is over the picture labeled "Performa Tutorial."

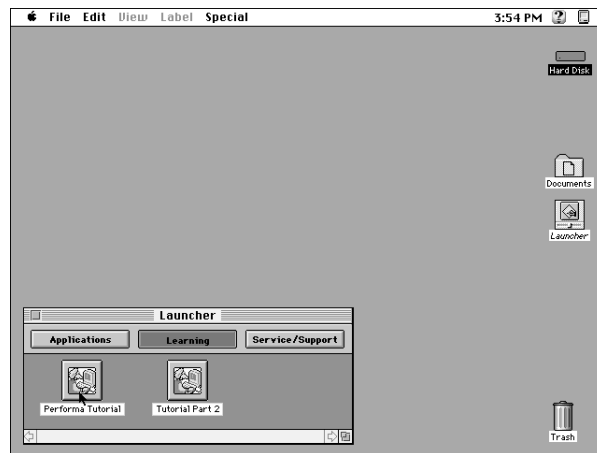

If you don't see the picture for the Performa Tutorial on your screen, put the arrow on the word "Learning" and click (press and release) the mouse button.

If you run out of room on your mouse pad or desk while moving the mouse, pick up the mouse and place it where there's more room. (The arrow on the screen moves only when the mouse is in contact with the mouse pad or desk.)

3 Without moving the mouse, click the mouse button.

A window appears welcoming you to the tutorial. You can set this book aside for now and follow the instructions on the screen. When you have completed both parts of the tutorial, return to this book.

Reviewing the basics

The following illustration summarizes many of the basic skills and terms you learned from the tutorial.

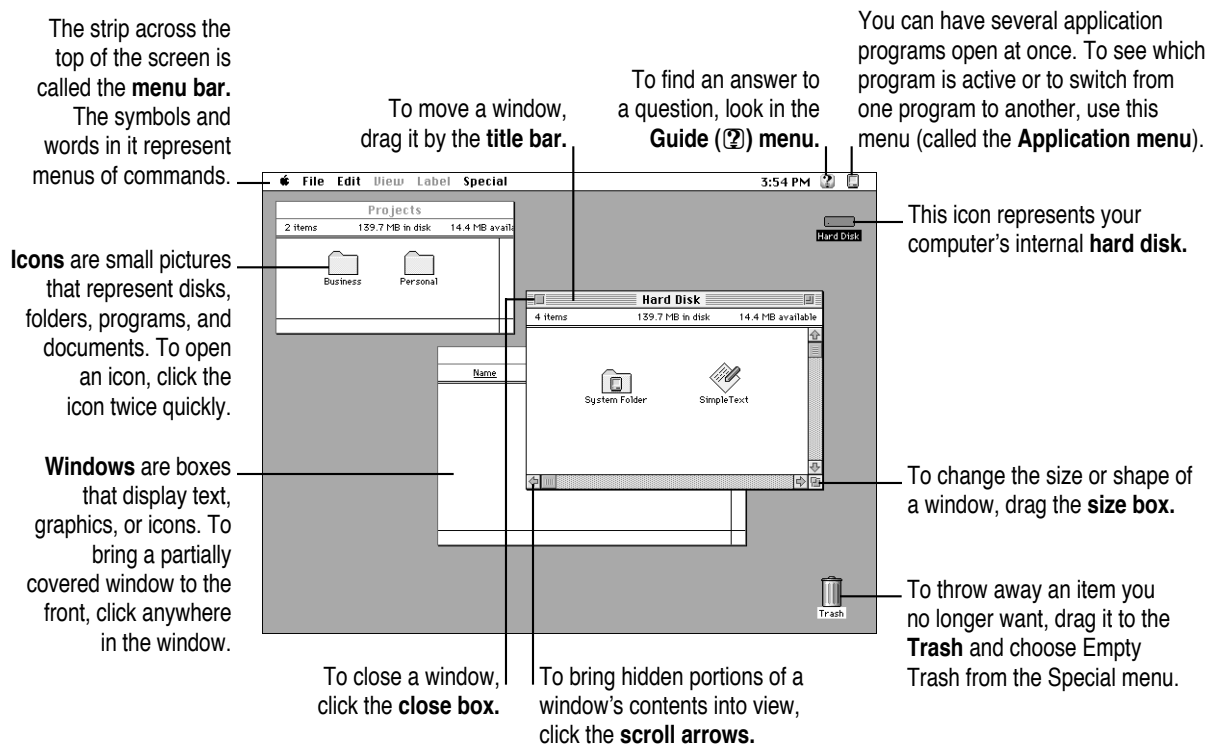

Turning the computer off

To turn the computer off, you choose Shut Down from the Apple () menu. Detailed instructions follow. (*Note:* The Shut Down command is also available in the Special menu.)

- 1 Move the tip of the arrow to the Apple () menu at the top left of the screen.

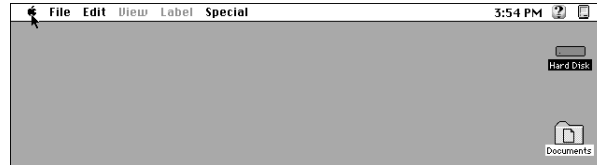

- 2 With the tip of the arrow on the apple, press and hold down the mouse button.
- 3 While holding down the mouse button, move the arrow down the list of choices until the words "Shut Down" are highlighted, then release the mouse button.

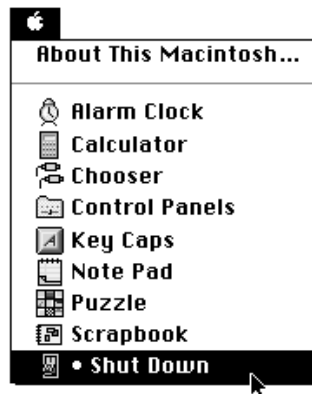

You can also shut down your computer from the keyboard.

- 1 Press the Power key (marked with a triangle) on the keyboard.

You will see a message asking whether you want to shut down or continue working.

2 Click Shut Down.

To turn the computer on, simply press the Power key again.

WARNING Do not turn the computer off by pressing the standby power button on the back panel. If you do so, you may lose any work you haven't previously saved to a disk. You also risk losing any open documents.

Where to find answers

When you have questions about using your Macintosh, there are several places you can look for answers.

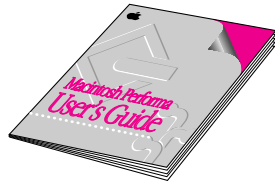

In this book

Use this book to help you set up your computer and learn about it, or to find solutions to problems.



In the Guide menu

The Guide menu (marked with the  icon) is your main source of information about the Macintosh. To learn how to get different kinds of help from the Guide menu, see Chapter 2 in this book.

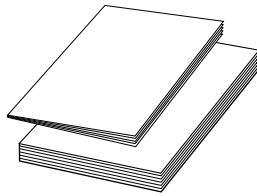

In other manuals

For answers to questions about other equipment or about application programs you have purchased, see the manuals that came with the equipment or programs.



From Apple's customer support hotline

If you can't find an answer in any of the materials provided, call the customer support hotline. (The phone number for the hotline is in the service and support information that came with your computer.)

Use the instructions in this chapter to learn about the help available to you in the Guide menu.

2 Getting Help

The Guide menu is your main source of information when you're working with your computer. The menu is identified by a question mark (🔍) in the upper-right corner of the screen.

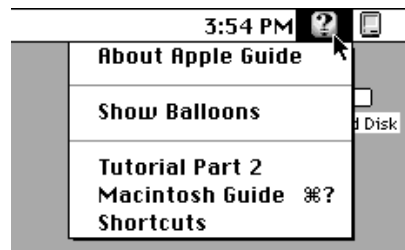

Getting answers to your questions

When you have a question while working with your computer, you can get the answer by choosing Macintosh Guide from the Guide menu.

- 1 Pull down the Application menu (in the upper-right corner of the screen) and choose Finder to make it the active application program.



A checkmark in the menu indicates that the Finder is the active program.

- 2 Pull down the Guide menu (marked with the ? icon) and choose Macintosh Guide.

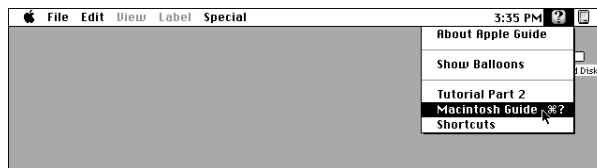

The Macintosh Guide window appears.

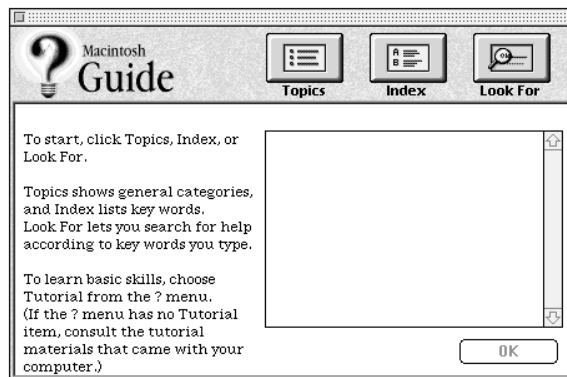

Whenever you use Macintosh Guide, its window remains in front of other windows. If the window gets in your way, you can move it by dragging its title bar (the gray bar across the top of the window).

- 3 Notice the three buttons at the top of the window: Topics, Index, and Look For.



Macintosh Guide gives you three ways of finding information:

- **Topics** lets you choose from a list of general subjects; it is like the table of contents in a book.
- **Index** lets you choose from an alphabetical list of more specific subjects; it is like the index in a book.
- **Look For** lets you search for information related to a specific word or phrase that you type.

In the following sections you will practice using each method.

If you have problems while using Macintosh Guide, see “Tips for Using Macintosh Guide” later in this chapter.

Getting answers with the Topics button

- 1 In the Macintosh Guide window, click the Topics button.

A list of general topics appears on the left side of the Macintosh Guide window. (Depending on the hardware and software you have, the list of topics may look different.)

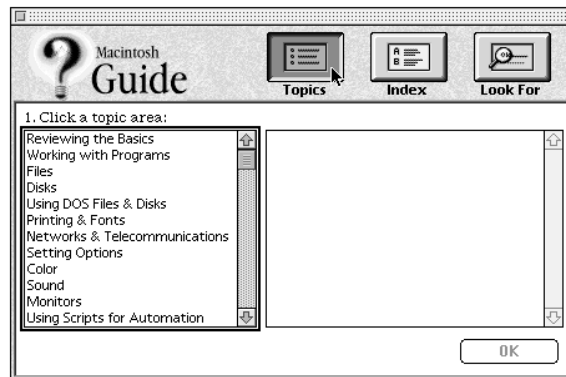

2 Click “Setting Options” in the list of topics.

When you click any topic area, a list of related questions appears on the right side of the Macintosh Guide window.

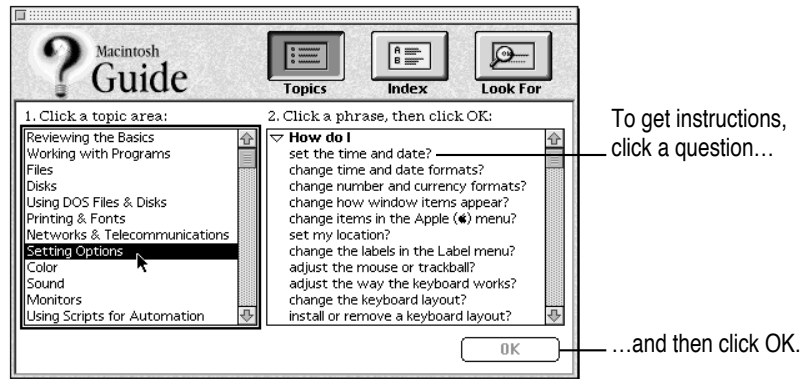

3 Click the question “How do I set the time and date?” and then click OK. Or double-click the question.

A small window appears with instructions for you to follow.

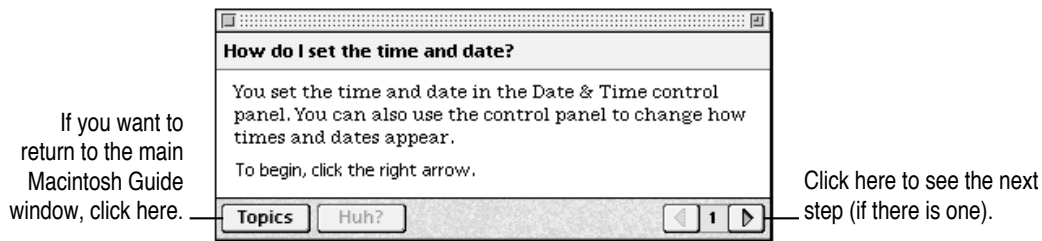

4 Read and follow the instructions in this window.

Macintosh Guide provides step-by-step instructions to answer the question you selected. When you have completed each step, click the right arrow in the lower-right corner to see the next step.

5 When you have completed all the steps, click the Topics button in the lower-left corner to return to the main Macintosh Guide window.

Now continue with the next section.

Getting answers with the Index button

- 1 In the Macintosh Guide window, click the Index button.

An alphabetical list of subjects appears on the left side of the window.

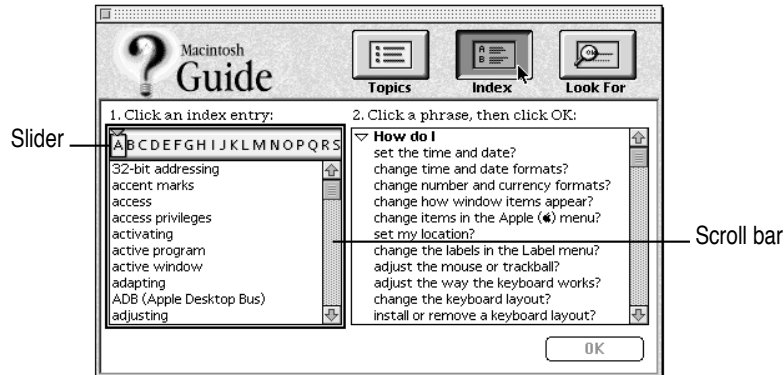

- 2 Scroll through the alphabetical list until the phrase “background pattern” is visible.

You can scroll through the list either by dragging the slider to the letter *B* or by using the scroll bar at the right of the list.

- 3 Click the phrase “background pattern” in the alphabetical list.

When you click any index entry, a list of related questions appears on the right side of the Macintosh Guide window.

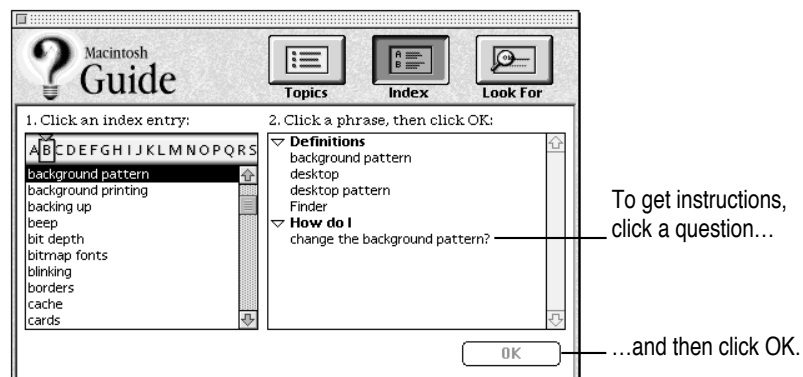

- 4 Click the question “How do I change the background pattern?” and then click OK. Or double-click the question.

A small window appears with instructions for you to follow.

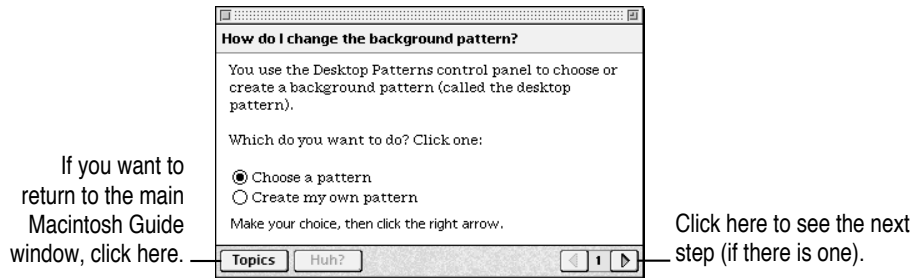

- 5 Read and follow the instructions in the window.

Macintosh Guide provides step-by-step instructions to answer the question you selected. When you have completed each step, click the right arrow in the lower-right corner to see the next step.

- 6 When you have completed all the steps, click the Topics button in the lower-left corner to return to the main Macintosh Guide window.

Now continue with the next section.

Getting answers with the Look For button

- 1 In the Macintosh Guide window, click the Look For button.

A small box appears on the left side of the window, where you can type text.

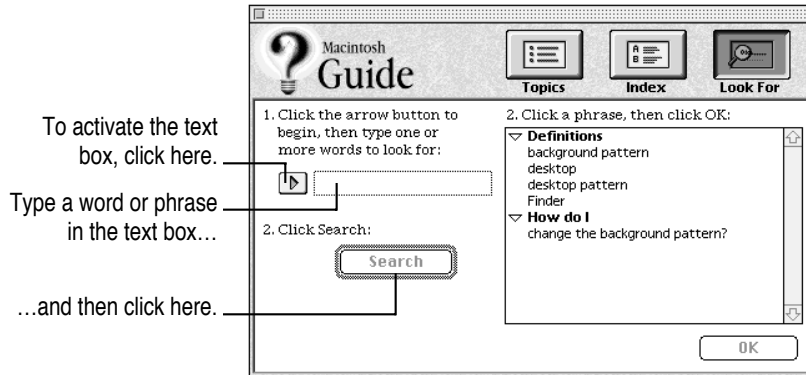

- 2 Click the arrow button to activate the text box.
- 3 Type "sound" in the text box and then click Search.

When you click Search, a list of questions related to the word or phrase you typed appears on the right side of the Macintosh Guide window.

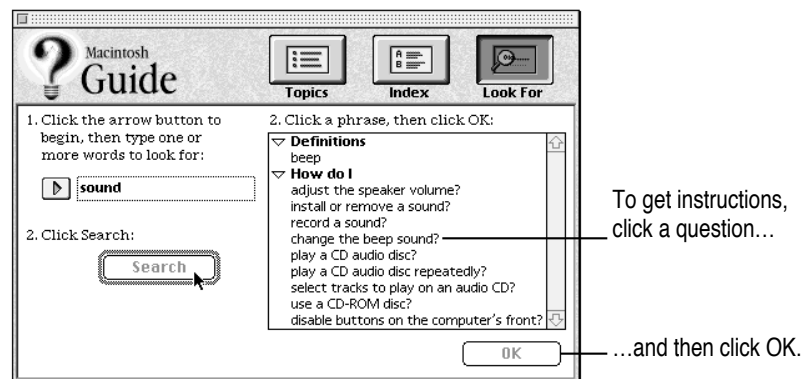

- 4 Click the question “How do I change the beep sound?” and then click OK. Or double-click the question.

A small window appears with instructions for you to follow.

If you want to close
Macintosh Guide,
click here.

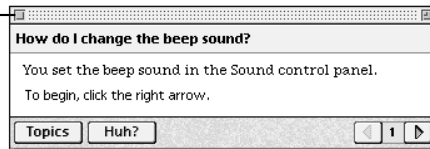

Click here to see the next
step (if there is one).

- 5 Read and follow the instructions in the window.

Macintosh Guide provides step-by-step instructions to answer the question you selected. When you have completed each step, click the right arrow in the lower-right corner to display the next step.

- 6 When you have completed all the steps, click the close box in the upper-left corner to close Macintosh Guide.

Tips for using Macintosh Guide

Here are a few tips for using Macintosh Guide effectively:

- Macintosh Guide is available only when you are in the Finder—the desktop area where you can see the icons of disks, folders, and files. (Other programs may also have help available in the Guide menu, however.) If you don't see Macintosh Guide in the Guide menu, pull down the Application menu (to the right of the Guide menu) and choose Finder.
- Follow the steps when you're instructed to; don't skip ahead or read ahead. That way the computer can check to make sure you've done a step correctly.
- Unlike most windows, the Macintosh Guide window stays in front of other windows on the screen so that your instructions are never covered. If you need to move the Guide window out of the way, drag it by the title bar at the top of the window.

You can also move the window out of the way by clicking the zoom box. Click the box once to shrink the window; click it a second time to expand the window to its original size.

- If you need more information about an instruction or a term, click the button labeled “Huh?” to get further explanation. (The “Huh?” button is dimmed when no additional information is available.)
- If you want to return to the main Macintosh Guide window, click the Topics button in the lower-left corner of the Guide window.
- When you're finished using Macintosh Guide, click the close box in the upper-left corner of the window.

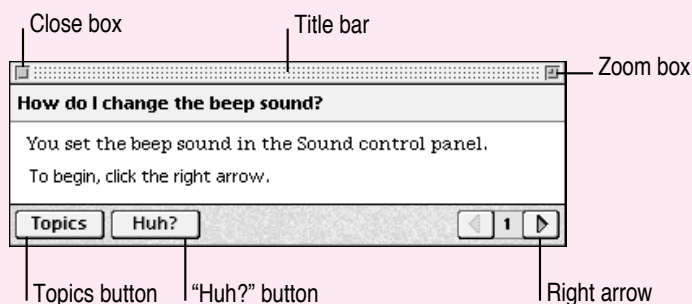

Identifying objects on the screen

Sometimes you'll see an unfamiliar item on the screen and ask yourself, "What's that?" You can get an answer by using a Macintosh feature known as Balloon Help.

Balloon Help explains the function of icons, menus, commands, and other items on the Macintosh screen in balloons like those you see in comic strips.

Follow these steps to use Balloon Help:

- 1 Pull down the Guide menu (marked with the  icon) and choose Show Balloons.**

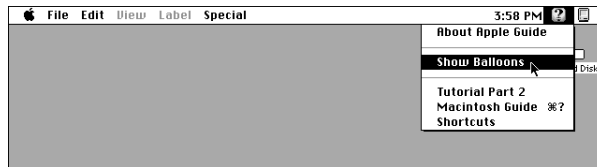

- 2 Point to any object on the screen that you want to identify.**

A balloon appears next to the object. In the following illustration, for example, pointing to the Trash displays a balloon that explains how to use the Trash to throw items away.



Although balloons appear next to items when you point to them, the way you work does not change; you can still select icons, choose commands, and so on.

- 3 When you're finished using Balloon Help, choose Hide Balloons from the Guide menu.**

Learning useful shortcuts

You can perform many tasks in the Finder more quickly if you use keyboard or mouse shortcuts. For example, instead of clicking an icon and choosing Open from the File menu, you can simply double-click the icon to open it.

Follow these steps to learn keyboard and mouse shortcuts:

- 1 **Pull down the Guide menu (marked with the  icon) and choose Shortcuts.**

The main Macintosh Shortcuts window appears.

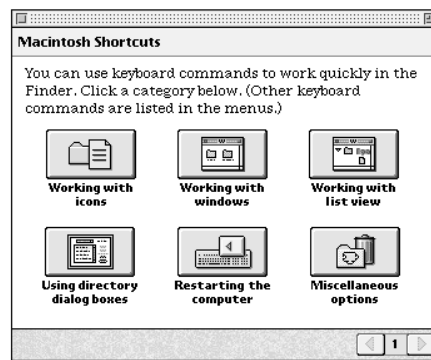

- 2 **Click one of the category buttons.**

Another window appears, describing shortcuts for that category.



3 Read about the shortcuts available for the category you selected.

Click the right arrow in the lower-right corner of the window to display the next window (if there is one).

4 When you finish reading about the shortcuts for your category, click the Topics button in the lower-left corner to return to the main Macintosh Shortcuts window. Or click the close box in the upper-left corner to close the window.



Read this chapter for information on expanding your computer system with additional hardware.

3

Connecting Additional Equipment

The illustration below shows a basic Macintosh system. You can expand your computer system by connecting additional hardware (such as a printer, modem, or external stereo speakers).

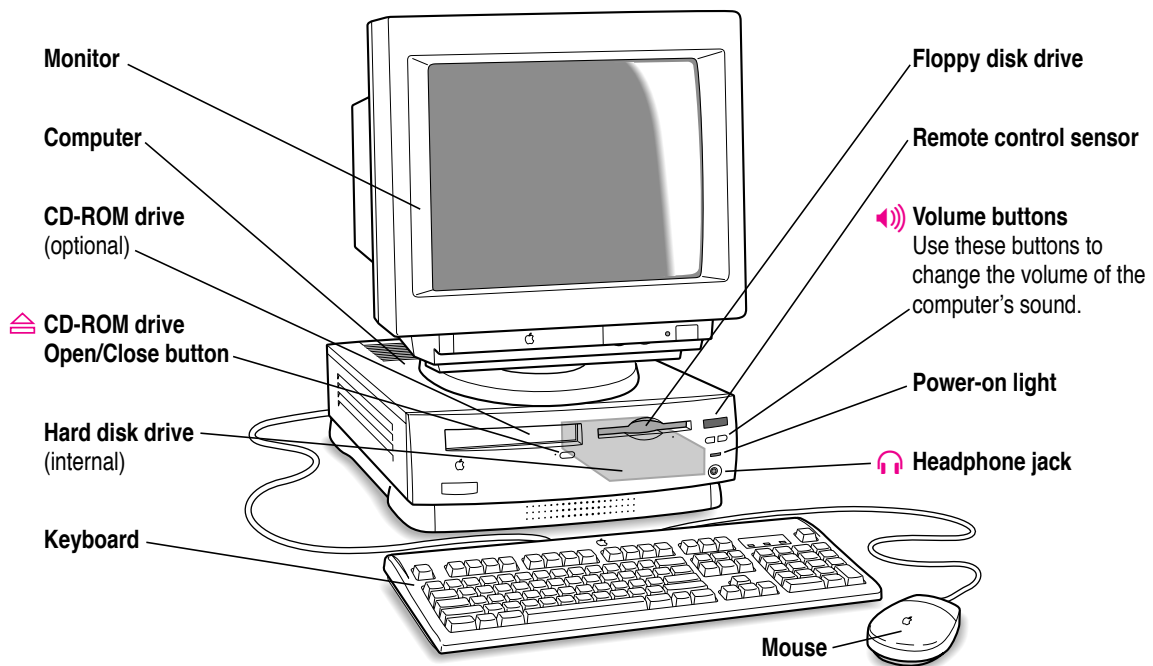

Where to connect additional equipment

The illustration on this page shows where equipment should be connected to your computer.

For instructions on connecting additional equipment such as a printer or scanner, see the manual that came with the equipment.

WARNING Before you connect any equipment—such as a mouse, keyboard, or external SCSI device—to your computer, make sure that your computer is plugged in (in order to ground the computer) and turned *off*. If you connect equipment with the computer turned on, you can damage your computer and your equipment.

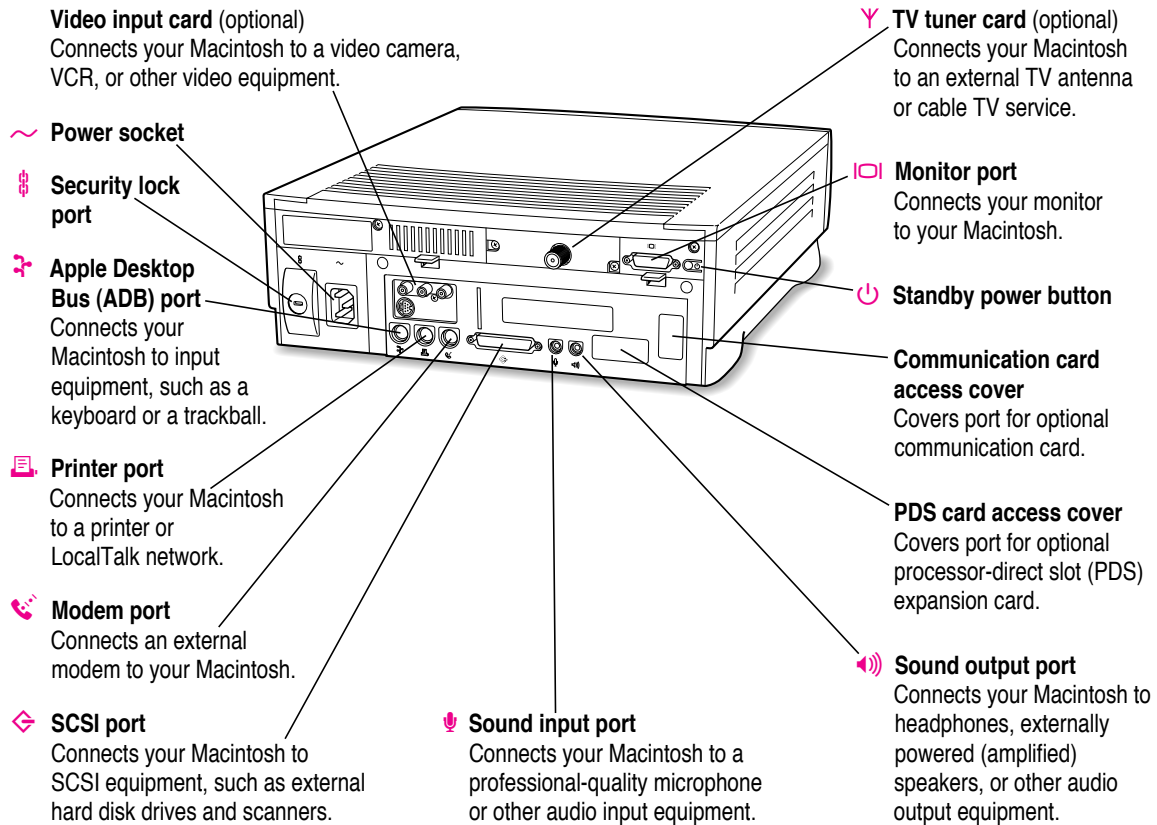

Connecting an Apple PlainTalk Microphone

Your computer has a sound input port, which you can use to connect an Apple PlainTalk Microphone.

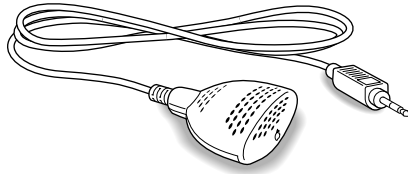

Use PlainTalk only: You should connect only the Apple PlainTalk Microphone. Other models of microphone will not work with your Macintosh.

To connect the microphone, do this:

- Plug the microphone's connector into the sound input port (marked with the icon ) on the back of the computer.

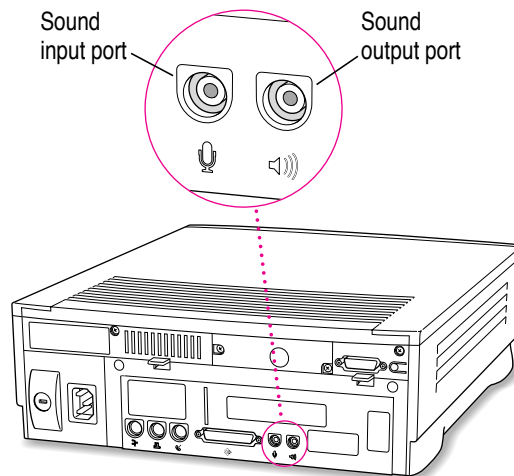

Connecting external stereo speakers

You can take advantage of your computer's stereo sound output by attaching external powered (amplified) speakers.

1 Assemble the speakers and the cable you need.

You need a cable with stereo miniplugs at each end to connect one or both speakers to the computer. (Some speakers require a dual-plug adapter. Others, like those shown here, accept a single stereo miniplug and are joined by standard speaker wires.)

The following illustration shows the equipment configuration and the connections for a computer sound system.

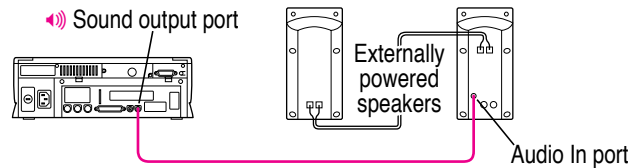

2 Turn off the Macintosh.

3 Plug a stereo miniplug into the sound output port on the Macintosh.

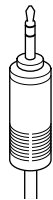

Stereo miniplug

4 Plug a stereo miniplug into the Audio In port on one of the speakers.

If the speakers take a dual-plug cable, connect both plugs to the speakers' Audio In ports.

- 5** Connect the speakers together with speaker wires, if necessary.
- 6** Turn on the computer.

You hear the computer's sound through the external speakers.

Note: To control the volume of your external speakers, use the volume buttons on the front of the computer. If you are playing an audio compact disc (CD), you may also need to adjust the volume control in the program you're using to play CDs. For more information on sound and playing audio CDs, see the "Sound" topic of Macintosh Guide, available in the Guide (📖) menu.

Expanding memory

The random-access memory (RAM) in your computer can be expanded. Installing additional RAM adds more memory chips to your computer and expands its capabilities. The *Technical Information* booklet that came with your computer describes how much additional memory can be installed in your Macintosh.

WARNING To avoid damage to your computer, Apple recommends that only an Apple-certified technician install additional RAM. Consult the service and support information that came with your computer for instructions on how to contact an Apple-authorized service provider or Apple for service. If you attempt to install additional RAM yourself, any damage you may cause to your equipment will not be covered by the limited warranty on your computer. See an Apple-authorized dealer or service provider for information about this or any other warranty question.

Installing internal drives

Your Macintosh can hold up to three internal storage devices, including a floppy disk drive, a CD-ROM (compact disc read-only memory) drive, and a hard disk drive (several capacities are available). These drives may already be installed. If you want to add or replace an internal drive, see your Apple-authorized dealer.

Read this chapter to learn how to work with application programs and protect the information on your disks.

4

Using Programs and Backing Up Disks



Your computer came installed with several ready-to-use application programs. You can open these programs by clicking their buttons in the Launcher.

The Apple Extras folder on your hard disk (or the *Macintosh Performa CD*) contains other programs (some of which must be installed before they will work), including the following:

- *AppleScript*. You need AppleScript on your hard disk in order to use Macintosh Guide. With AppleScript you can also automate tasks in the Finder and other scriptable programs (programs that support AppleScript). Instructions for using AppleScript are included in the AppleScript folder.
- *QuickDraw GX* gives your computer more powerful printing and font capabilities. You'll want to install QuickDraw GX if you purchased another program that requires it. If your computer has at least 8 megabytes of random-access memory (RAM), you can install QuickDraw GX by opening the QuickDraw GX folder and double-clicking the Installer icon.
- *PowerTalk* provides an open collaboration environment with a universal mailbox and other electronic mail services. You'll want to install PowerTalk if you purchased another program that requires it. If your computer has at least 8 megabytes of RAM, you can install PowerTalk by opening the PowerTalk folder and double-clicking the Installer icon.
- *Apple Video Player* lets you watch video or TV on your computer. With Apple Video Player and a video input card, you can watch video on your computer. With Apple Video Player, a video input card, and a TV tuner card, you can watch video and TV. For instruction on using Apple Video Player, open Apple Video Player and then choose Apple Video Player Guide from the Guide (⌘) menu.

Installing application programs

You'll probably want to buy and install additional application programs. See the manuals you receive with your programs for instructions on installing and using them.

In most cases, you'll install an application program on your internal hard disk from floppy disks that contain the program. The following illustration shows how to insert a floppy disk in your computer's floppy disk drive.

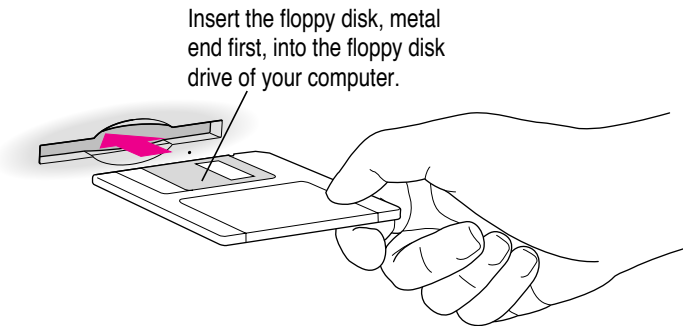

For instructions on how to eject floppy disks, see the “Disks” topic of Macintosh Guide, available in the Guide (🔍) menu.

To use your programs most effectively, follow these guidelines:

- Put only one copy of each program on your hard disk. Having more than one copy can cause errors.
- Whenever you copy a program disk to your hard disk, be careful not to copy a System Folder. Always check to see what you've copied, and drag any extra System Folders to the Trash.
- If you have problems using a program, read the manuals you received with the program.
- If a program malfunctions consistently, try installing a fresh copy. If that doesn't help, find out from the software manufacturer whether your version of the program is compatible with the system software you're using.

For instructions on how to put a program into the Launcher, see the “Launcher” index topic of Macintosh Guide, available in the Guide (🔍) menu.

Working with several programs at a time

You can open as many application programs and desk accessories as your computer's memory allows.

All open programs are listed in the Application menu at the right end of the menu bar. The name of the active program (the one you're using right now) has a checkmark next to it, and its icon appears in the menu bar.

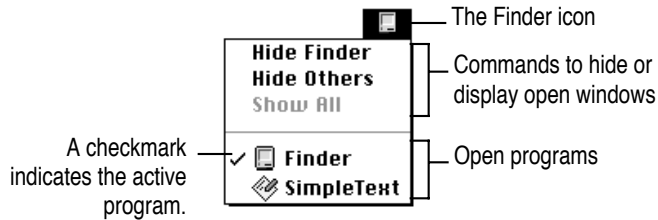

Finding out which programs are open

If you have several programs and windows open, you can find out which program is active and which other programs are open by pulling down the Application menu.

Switching programs

You can switch to another open program or desk accessory by choosing its name from the Application menu.

If a program's icon is dimmed in the menu, that means its windows are hidden. Choosing the program from the Application menu displays its windows.

You can also switch to another program by clicking in a window that belongs to an open program, or by double-clicking a program icon (or the icon of a document that was created with the program).

Hiding and showing windows on the desktop

You can hide all windows except those of the active program by choosing Hide Others from the Application menu.

The other programs remain open even though their windows are hidden. When you switch to another program, its windows become visible again.

If you want to see all the open windows, choose Show All from the Application menu.

Protecting the information on a disk

Your computer's hard disk comes with a lot of valuable information already stored on it, including system software and some application programs. If you had a valuable document like a birth certificate, you'd probably make an extra copy of it for safekeeping. Similarly, you should make a copy of the information on your hard disk for safekeeping. (The extra copy is called a *backup*, and the process of making the copy is called *backing up*.)

Once you have a backup, you're protected from accidentally losing the information on your hard disk. In the unlikely event that something happens to your hard disk, you can easily get the information back.

Backing up your files

You can back up the work you store on a hard disk by copying individual files to another disk in the usual way (dragging the files' icons to the icon of the other disk). You can back up the contents of an entire floppy disk by dragging its icon to another floppy disk or hard disk icon.

If your computer has a CD-ROM drive

If your computer has a CD-ROM drive, you also received the *Macintosh Performa CD*, which contains a backup copy of all the software that came with your computer. You should make backup copies of the documents you create. If you alter the contents of your System Folder, you may also want to use Apple Backup and Apple Restore—application programs that came with your computer—to preserve the contents of your hard disk. (See the following sections for instructions on using Apple Backup and Apple Restore.)

If your computer does not have a CD-ROM drive

If your computer does not have a CD-ROM drive, use Apple Backup to copy the entire contents of your Macintosh hard disk to floppy disks. Keeping this backup copy up-to-date will protect you in case information on your hard disk is accidentally lost or damaged. You should update your backup copy at least once a month, and in between full backups you should store copies of important documents on floppy disks.

If something happens to the information on your hard disk, you can use the backup copy you made to put the information back on your hard disk. To do this, you use Apple Restore. (See the following sections for instructions on using Apple Backup and Apple Restore.)

It's a good idea to keep two sets of backup copies, and to alternate between them (using one set one month, and the other the next) when updating your backup copy. This protects you from losing files in the unlikely event that a problem damages the files on both your internal hard disk and your backup set of floppy disks.

You can also purchase a backup program with additional features that make copying faster. (For example, some programs have a feature that lets you copy only the new and changed information on your hard disk.)

Using Apple Backup for the first time

If you have a *Macintosh Performa CD*, you don't need to use Apple Backup, because the CD contains all the software that came with your computer. However, if you don't have the CD as backup, use Apple Backup to copy the software to floppy disks, as backup.

WARNING Do not attempt to back up your Macintosh with disks that have been preformatted for an IBM-compatible personal computer.

To use Apple Backup for the first time, follow these steps:

- 1 Click the Applications grouping button in the Launcher.**

The buttons for application programs available in the Launcher are grouped under the Applications button.

- 2 Click the Apple Backup button in the Launcher window.



Apple Backup

The Apple Backup program opens.



- 3 Click the Continue button.

A message appears, showing you how to identify the high-density floppy disks you need.

- 4 Make sure your floppy disks are high-density. Then click the Continue button.

A message appears, telling you how many disks you need to make the copy and approximately how long it will take. Make sure you have enough time and disks to complete the copying. If you stop the copying before it's finished, you'll have to start over again from the beginning.

- 5 Click the appropriate button, as follows:

- If you have enough disks to copy everything, then click the Copy All Files button.
- If you have only enough disks to copy the System information, then click the Copy System Folder button. As soon as you buy more disks, follow the instructions in this chapter to back up everything.
- If you don't have enough disks for either choice, click the Quit button.

6 Insert a high-density floppy disk into the disk drive.

A message tells you when it's time to insert another floppy disk.

7 Lock each disk as you remove it from the computer. Label the disks to indicate the order in which you create them (for example: *Backup 1*, *Backup 2*, and so on).

To lock a disk, turn it label-side down and use a pen or your fingernail to slide the tab in the lower-right corner of the disk so that the square hole is open. (The disk has two square holes, but only one of them has a moveable tab.)

8 When a message appears telling you that you've finished, store the labeled and locked floppy disks in a safe, cool place.

Using Apple Backup to update your backup copy

If you made a backup copy of your hard disk information on floppy disks using Apple Backup, you can keep your backup copy up-to-date by following the instructions here.

By the way: Another way to make sure you have up-to-date information is to use a new set of floppy disks to create your backup copy, preserving your original backup. If you are using a fresh set of floppy disks, follow the instructions in the previous section, "Using Apple Backup for the First Time."

1 Get the floppy disks that you used to make a previous backup copy.

Have some extra high-density disks on hand in case there is more information on your hard disk than there was the last time you made a copy.

2 Turn on your Macintosh, if it's not already on.

3 Click the Applications grouping button in the Launcher.

The buttons for application programs available in the Launcher are grouped under the Applications button.

- 4 Click the Apple Backup button in the Launcher window.



Apple Backup

The Apple Backup program opens.



- 5 Click the Continue button.

A message appears, showing you how to identify the high-density floppy disks you need.

- 6 Make sure your floppy disks are high-density. Then click the Continue button.

A message appears, telling you how many disks you will need to copy all files on your hard disk, or to copy just the System Folder. It also tells you approximately how long it will take to make the copy.

Copy all files or just the System Folder? Because all the information on your hard disk is important, it's recommended that you make a copy of all the files on the hard disk. But if you don't have enough disks or time right now to make a copy of everything, you can choose to make a copy of just the System Folder.

If you want to be doubly protected, you can make a copy of all files and then start Apple Backup again and make an extra copy of the System Folder. That way, if something goes wrong with your System Folder, you can replace it quickly without having to copy everything back onto your hard disk.

7 Click the button that corresponds to your choice.

Make sure you have enough time and disks to complete the copying. If you stop the copying before it's done, you'll have to start over from the beginning.

8 Unlock your first backup floppy disk.

To unlock the disk, turn the disk label-side down and use a pen or your fingernail to slide the tab in the lower-right corner of the disk so that it covers the square hole. (The disk has two square holes, but only one of them has a moveable tab.)

9 Insert the disk into the floppy disk drive.

If you did not unlock the disk correctly, it is ejected and a message appears. Unlock the disk, making sure that the tab snaps into place, and try again.

A message appears, telling you that the disk contains information.

10 Click the Continue button.

If there is a problem with the disk, a message appears. Otherwise, copying takes place automatically. A sound alerts you when it's time to insert another disk.

11 When the disk is ejected, lock and label it.

To lock a disk, turn it label-side down and use a pen or your fingernail to slide the tab in the lower-right corner of the disk so that the square hole is open.

12 Repeat steps 7 through 11 for each disk in your stack of backup disks.

Apple Backup lets you know when you've finished.

13 Store the disks in a safe, cool place.

Restoring the information on your hard disk

If information on your hard disk becomes damaged or lost, you can restore it if you have a backup copy of the information. If your computer has a CD-ROM drive, the *Macintosh Performa CD* contains copies of all the system software and application programs that came with your computer. See the *Macintosh Performa CD* booklet for instructions on using the *Macintosh Performa CD*.

If you have used Apple Backup to copy the information on your hard disk to floppy disks, you can use the Apple Restore program to put that information back on your hard disk. You can also use Apple Backup and Apple Restore to replace only the System Folder (the folder that contains the software the Macintosh uses to operate). See the following section, “Using Apple Restore,” for instructions.

If your computer doesn't have a CD-ROM drive and you have not used Apple Backup to back up the contents of your hard disk, call the customer support hotline. (The phone number for the hotline is in the service and support information that came with your computer.)

Using Apple Restore

If you made backup floppy disks with Apple Backup, follow these steps to restore your information:

- 1** Get the *Utilities* floppy disk or the *Macintosh Performa CD*—whichever came with your computer—and the floppy disks that you made when you used Apple Backup.
- 2** Make sure your Macintosh is turned off.
- 3** Insert the floppy disk or CD into its drive.

If you're starting up from the *Utilities* floppy disk, go to step 4. If you're starting up from the *Macintosh Performa CD*, go to step 5.

- 4** If you're starting up from the *Utilities* floppy disk, turn on your Macintosh. Then skip to step 6.

It takes several moments for your computer to start up.

- 5 **If you're starting up from the *Macintosh Performa CD*, turn on your Macintosh and then immediately press and hold down the ⌘ (Command), Shift, Option, and Delete keys (all at the same time). As soon as the smiling Macintosh appears on your screen, release the keys.**

The key combination tells your computer not to start up from the internal hard disk.

It takes several moments for you computer to start up.

- 6 **Locate the Apple Restore icon (on *Utilities* disk) or button (on *Macintosh Performa CD*).**



- 7 **Open the Apple Restore program.**

In a moment you'll see this screen:



- 8 **Read the information on the screen and click the Continue button.**
- 9 **Insert your first backup floppy disk.**

Restoring proceeds automatically. If there is a problem with the disk, you see a message describing the problem.

IMPORTANT If at any time during the restore process you see a message reporting that the hard disk is damaged or unreadable, see "Repairing a Damaged Disk" in Chapter 5, "Troubleshooting."

10 Respond to any messages you see on the screen.

If Apple Restore finds an item on your hard disk that is newer than an item with the same name on the floppy disk, it asks whether you want the older version of the item to replace the newer version. Use the following guidelines to decide whether or not to replace the item:

- If the item is system software, click **Replace Newer Version**.
- If the item is one of your own files, click **Keep Newer Version**.
- If, after the restore procedure, you still have problems with the disk, repeat the restore procedure and, this time, replace all newer items with the older items.

A sound alerts you when it's time to insert another disk.

11 Repeat steps 8 and 9 for each disk in your stack of backup disks.

Apple Restore lets you know when you have finished.

12 Restart your Macintosh and make sure that everything is back on your hard disk.

If the Macintosh does not start up or is not working properly, see “Repairing a Damaged Disk” in Chapter 5, “Troubleshooting.” If you are able to repair the disk, then try again to restore the information on your hard disk.

If repairing the disk doesn't help, you may need to reinstall system software. See “Installing or Reinstalling System Software” in Chapter 5, “Troubleshooting.”

13 Store your backup disks in a safe, cool place.



Consult this chapter if you experience problems using your computer.

5

Troubleshooting



When you have questions

If you want to know how to do a particular task with your computer, refer to Macintosh Guide in the Guide (🔗) menu. For instructions on using Macintosh Guide, see Chapter 2 of this manual.

When you run into trouble

While you're using your computer, you may occasionally see a bomb icon or an error message, or you may have a problem such as the pointer (⏏) “freezing” on the screen. If you have trouble with your computer, take a few minutes to read the information in this chapter. If your problem is related to a particular procedure, you should also look for information on that procedure in Macintosh Guide, available in the Guide (🔗) menu. For additional troubleshooting information and a list of common questions relating to your system software, see the “Troubleshooting” topic of Macintosh Guide.

If you are unable to access Macintosh Guide (for example, if your screen is “frozen”), refer to this chapter to see if you can resolve the problem.

Take your time

When you see an error message, you don't have to take action immediately. The message stays on the screen until you click the OK button or turn off the Macintosh.

To help diagnose and correct the problem, gather as much information on the situation as you can before starting over.

- Make a note of exactly what you were doing when the problem occurred. Write down the message on the screen and its ID number (if any). Also list the programs you were using and the names of any items you know have been added to the System Folder since the system software was installed. This information will help a service person diagnose the problem. (It is helpful to keep a printed copy of the items in your System Folder. For instructions on printing the contents of a folder, see the "Printing & Fonts" topic of Macintosh Guide, available in the Guide [?] menu.)
- Check the screen for any clues. Is a menu selected? What programs and document icons are open? Note anything else that seems relevant.
- If you were typing text and were not able to save it before the problem occurred, you can write down the parts of the text still visible on the screen so that some of your work will be easy to replace.
- Ask other Macintosh users about the problem you're having; they may have a solution for it.

If you need repair service, consult the service and support information that came with your computer for instructions on how to contact an Apple-authorized service provider or Apple for assistance.

Start over

Often you can eliminate a problem simply by clearing the computer's memory and starting over.

If you can, save any open documents before restarting the Macintosh. If your system is frozen and does not respond to anything you do, or if you have a “bomb” message on the screen, saving may not be possible. You can try pressing ⌘-Option-Esc to quit the program in use when the problem occurred; if this works, you can then save the documents open in other programs before restarting.

To restart your Macintosh, try the following steps:

- 1 If you can, choose Restart from the Special menu or from the dialog box that's on the screen.**

Dialog boxes contain messages from the computer. If something goes wrong, a message may appear on the screen, asking you to restart the computer.

- 2 If you can't choose Restart, hold down the ⌘ and Control keys while you press the Power key (marked with a triangle).**

This key combination restarts the computer. (Use this key combination only when you can't choose Restart from the Special menu.)

- 3 If nothing happens, turn off your computer with the standby power button, wait at least 10 seconds, and then turn it on again.**

- 4 If the standby power button doesn't turn off the computer, unplug your Macintosh.**

If you suspect that the problem is with other equipment, such as a printer or an external hard disk that's attached to your computer, turn that equipment off for 10 seconds or longer, then turn it on again and restart the Macintosh.

Rebuild your desktop regularly

A process known as “rebuilding the desktop” helps your Macintosh keep track of data on your startup disks. Although you usually use the hard disk in your computer as a startup disk, you can also start up from any other disk that has system software installed. It’s a good idea to rebuild the desktop of your startup disks once a month or so.

To rebuild the desktop of a startup disk, follow these steps:

- 1 Hold down the Option and ⌘ keys while you start up your computer.**

Do not release the keys until you see a message asking whether you want to rebuild the desktop.

- 2 Click OK.**

Solutions to common problems

The computer is turned on but the screen is dark.

One of the following is probably the cause:

- You have a screen saver program that darkens the screen when the computer has not been used for a certain period.

Press a key or move the mouse to turn off the screen saver.

- The monitor's brightness control (☼) is not adjusted properly.

Check the monitor's brightness control and turn it up if necessary.

- The Macintosh or the monitor is not getting power.

If you have a separate monitor, check that the monitor is plugged in and turned on, and that the monitor cable is firmly connected to both the computer and the monitor.

Check that the computer's power cord is firmly connected to the computer and plugged into a grounded electrical outlet, and that the outlet has power.

If you have more than one monitor and only one is dark, check that it is set up correctly in the Monitors control panel. For information on using more than one monitor, see the "Monitors" topic of Macintosh Guide, available in the Guide (📖) menu.

If you are displaying video from your computer on a television screen, it is normal for your computer monitor to be dark.

The computer's clock keeps time inaccurately.

Your computer has a clock that runs continuously. When the computer is turned off, a battery keeps the clock running. If your clock begins to keep time inaccurately, have your Apple-authorized service provider replace the battery.

When you start up, a disk icon with a blinking question mark appears in the middle of the screen.



This icon indicates that your Macintosh cannot find the system software it needs to start up. One of the following is probably the cause:

- Your computer may be having a problem recognizing external equipment that uses the Small Computer System Interface (SCSI).

Turn off all external SCSI equipment and disconnect the first SCSI device in the chain from your computer's SCSI port. Then restart the computer. If the computer starts up after you disconnect your SCSI equipment, refer to the manuals that came with the equipment for information on the proper way to connect SCSI equipment and assign SCSI ID numbers.

If you have a printer connected to your computer's SCSI port, make sure your printer is not supposed to be connected to the printer port instead. Check the manuals that came with your printer for information on how to connect it properly.

- System software is not installed on the startup hard disk, the system software is damaged, or the hard disk is not working properly.

Start up your computer using the *Utilities* floppy disk or, if you have a built-in CD-ROM drive, using the *Macintosh Performa CD*. (For instructions on how to start up your computer from the CD-ROM disc, see "Starting Up From a CD-ROM Disc" in the section "Repairing a Damaged Disk" later in this chapter.) Then follow the rest of the instructions on repairing a disk to test your startup hard disk and repair any damage.

If repairing the disk doesn't help, follow the instructions in "Installing or Reinstalling System Software" later in this chapter to reinstall system software on your startup hard disk.

When you try to start up from a floppy disk, a disk icon with an X appears in the middle of the screen and the floppy disk is ejected.



This icon indicates that the floppy disk you tried to start up from is not a startup disk.

Wait a few seconds. The computer should start up from its internal hard disk. Make sure you insert floppy disks only after the computer has begun starting up.

A “sad Macintosh” icon appears and the computer won’t start up.



This icon indicates that your Macintosh cannot start up because of a problem with the system software or the computer hardware.

Eject any floppy disks by turning off the computer and then holding down the mouse button while you turn the computer on again. Try starting up with the *Utilities* floppy disk or, if you have a built-in CD-ROM drive, with the *Macintosh Performa CD*. (For instructions on how to start up your computer from the CD-ROM disc, see “Starting Up From a CD-ROM Disc” in the section “Repairing a Damaged Disk” later in this chapter.) If the “sad Macintosh” icon appears again, consult the service and support information that came with your computer for information on contacting an Apple-authorized service provider or Apple for assistance.

The hard disk icon does not appear on the desktop.

If you don't see a hard disk icon on the desktop, try the following:

- If the hard disk is internal, shut down your computer, wait at least 10 seconds, and then turn it on again.
- If the hard disk is external, make sure that it is turned on and that its cable is connected firmly; then restart the Macintosh.
- Check the ID numbers of all SCSI equipment connected to your computer. See the manuals that came with your SCSI equipment for information on setting SCSI ID numbers.
- If the hard disk is your startup disk, start your computer using the *Utilities* floppy disk or, if you have a built-in CD-ROM drive, with the *Macintosh Performa CD*. (For instructions on how to start up your computer from the CD-ROM disc, see “Starting Up From a CD-ROM Disc” in the section “Repairing a Damaged Disk” later in this chapter.) Then follow the rest of the instructions on repairing a disk to test your startup hard disk and repair any damage.

If repairing the disk doesn't help, follow the instructions in “Installing or Reinstalling System Software” later in this chapter to reinstall system software on your startup hard disk.

Icons do not appear correctly on your screen.

You need to rebuild the desktop—a process that helps your Macintosh keep track of files and folders on your hard disks. For instructions, see “Rebuild Your Desktop Regularly” in the section “When You Run Into Trouble” earlier in this chapter.

If icons do not appear correctly after you rebuild the desktop, restart your computer while pressing the Shift key to temporarily turn off system extensions. When you see the “Welcome to Macintosh—extensions off” message, release the Shift key and press the Option and ⌘ keys until you see a message asking if you want to rebuild the desktop.

Your Macintosh can't read a floppy disk.

If you see a message that a floppy disk is unreadable, try one of the following:

- If the disk has never been used, you may simply need to initialize it. For instructions, see the “Disks” topic of Macintosh Guide, available in the Guide (🔍) menu.
- The disk may be damaged. See “Repairing a Damaged Disk” later in this chapter for information on testing and repairing disks.
- If the disk is a high-density disk previously used on another computer, the disk may have been formatted incorrectly as an 800K disk rather than as a 1440K (high-density) disk. If so, use the other computer to copy the disk's contents onto a properly formatted disk.

If you are trying unsuccessfully to use a DOS floppy disk, consider the following:

- When formatting floppy disks on a DOS computer for use in a Macintosh, users need to format standard double-sided disks as 720K disks and high-density disks as 1440K disks. Because DOS computers allow standard double-sided disks to be formatted in 1440K format and high-density disks to be formatted in 720K format, it's possible that your disk has been given a format that won't work in a Macintosh. If you think your DOS floppy disk might have a format that doesn't work in a Macintosh, use a DOS computer to copy the contents of your DOS floppy disk onto another DOS floppy disk that has been properly formatted for use in a Macintosh.

A dialog box with a bomb appears.

Your system has a software problem.

- Write down what you were doing when the message appeared, the text of the message, and the message number, if there is one.
- Restart your Macintosh. (See “Start Over” in the section “When You Run Into Trouble” earlier in this chapter for instructions.) Most software problems are temporary, and restarting usually corrects the problem.
- Check the startup disk and application program you were using when the dialog box appeared. Make sure that all programs, desk accessories, and system extensions you’re using are compatible with the system software. Reinstalling the system software may correct the problem.
- Sometimes incompatible system extensions or control panels can cause system software problems. Restart while holding down the Shift key; this temporarily turns off all system extensions. If your computer works normally after you do this, use the Extensions Manager control panel to turn on extensions and control panels one at a time. Restart after you turn on each extension. This procedure should identify any incompatible extensions.

For information on using the Extensions Manager control panel to manage system extensions, see the “Setting Options” topic of Macintosh Guide, available in the Guide (⌘) menu.

- If the problem recurs, you may need to reinstall system software. See “Installing or Reinstalling System Software” later in this chapter for instructions.

The pointer (⏏) doesn’t move when you move the mouse.

One of the following situations is probably the cause.

- Your system has a software problem. Try one or more of the following:
Press ⌘-Option-Esc to quit the application program in use when the problem occurred. If this works, you can save the documents open in other programs before restarting.
Restart your Macintosh. See “Start Over” in the section “When You Run Into Trouble” earlier in this chapter for instructions.

Check the startup disk and program you were using when the problem occurred. Make sure that all programs, desk accessories, and system extensions you're using are compatible with the system software. Try starting up the computer with the *Utilities* floppy disk or, if you have a built-in CD-ROM drive, with the *Macintosh Performa CD*. (For instructions on how to start up your computer from the CD-ROM disc, see “Starting Up From a CD-ROM Disc” in the section “Repairing a Damaged Disk” later in this chapter.) If your computer starts up normally, there may be an extension conflict.

- Sometimes incompatible system extensions or control panels can cause system software problems. Restart while holding down the Shift key; this temporarily turns off all system extensions. If your computer works normally after you do this, use the Extensions Manager control panel to turn on extensions and control panels one at a time. Restart after you turn on each extension. This procedure should identify any incompatible extensions. For information on using the Extensions Manager control panel to manage system extensions, see the “Setting Options” topic of Macintosh Guide, available in the Guide (⌘) menu.

If the problem recurs, you may need to reinstall system software. See “Installing or Reinstalling System Software” later in this chapter for instructions.

- The mouse is not connected properly.
Turn the computer off using the standby power button, check that the mouse and keyboard cables are connected properly, and then restart the computer.
- Signals from the mouse are not reaching the computer, either because the mouse needs cleaning or because there is something wrong with the mouse.
Clean the mouse according to the instructions in Appendix A of this book.
If you have another mouse or pointing device, try connecting and using it. (Turn off the computer before connecting it.) If the new device works, there is probably something wrong with the mouse you replaced.

If none of these procedures solves the problem, consult the service and support information that came with your computer for instructions on how to contact an Apple-authorized service provider or Apple for assistance.

Typing on the keyboard produces nothing on the screen.

One of the following is probably the cause:

- Your system has a software problem.

Restart your Macintosh. For instructions, see “Start Over” in the section “When You Run Into Trouble” earlier in this chapter.

Check the startup disk and application program you were using when the problem occurred. Make sure that all programs, desk accessories, and system extensions you’re using are compatible with the system software.

If the problem recurs, you may need to reinstall system software. See “Installing or Reinstalling System Software” later in this chapter for instructions.

- You haven’t selected any text or set the insertion point (I).

Make sure the program you want to type in is the active program. Then place the pointer (⌘) in the active window and click to set an insertion point (I) or drag to select text (if you want to replace the text with your typing).

- The keyboard is not connected properly.

Turn off the computer using the standby power button, then check that the keyboard cable is connected properly at both ends.

If you have a keyboard with an ADB port (marked with the ⌘ icon) on each end, turn off the Macintosh using the standby power button and plug the keyboard cable into the other ADB port on the keyboard. (You may have to unplug the mouse to do this.) Then restart the computer.

- The keyboard is damaged.

If you have access to another keyboard, try using it instead. (Turn the computer off before connecting it.) If the new keyboard works, there is probably something wrong with the one you replaced.

If none of these procedures solves the problem, consult the service and support information that came with your computer for instructions on how to contact an Apple-authorized service provider or Apple for assistance.

You can't start an application program or it quits unexpectedly. Or, when you try to open a program, you see a message that not enough memory is available.

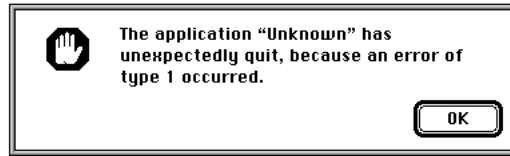

One of the following is probably the cause:

- The Macintosh ran out of memory.

Quit the programs that you have open and then open the program you want to use, or restart your Macintosh.

Use the Memory control panel to turn on virtual memory. For more information on virtual memory, see the "Memory" topic of Macintosh Guide, available in the Guide (🔗) menu.

- The program needs more memory.

Use the program's Info window to give it more memory. For more information on increasing a program's memory, see the "Memory" topic of Macintosh Guide, available in the Guide (🔗) menu.

- The program requires special hardware, and your computer doesn't have the hardware installed.

Check the documentation that came with the program to find out if the program requires a Macintosh with special hardware. Then check the *Technical Information* booklet that came with your Macintosh to find out if your computer is equipped with such special hardware, or if the hardware can be installed. Consult your Apple-authorized service provider for information on installing special hardware in your computer.

You can't open a document, or you see a message that an application program can't be found.

- Some documents can be opened by more than one application program. Try starting a program that you think might be able to open the document, then choose Open from the program's File menu to try to open the document.
- Purchase and install the correct software to use the document, or find out if the creator of the document can convert it to a form that one of your programs can use.
- Don't try to open the files in your System Folder. Most of the files in your System Folder are used by your computer for internal purposes and are not intended to be opened.
- Rebuild your desktop by holding down the Option and ⌘ keys while starting up your computer. Keep holding down the keys until you see a message asking whether you want to rebuild the desktop. Click OK.
- If the document is from a DOS computer, use the PC Exchange control panel to specify which Macintosh program will open the document. For information about working with DOS documents on your Macintosh, see the "Using DOS Files & Disks" topic of Macintosh Guide, available in the Guide (🔍) menu.

You experience problems using a document from a DOS computer.

If you can't open a DOS document using a Macintosh program, try the following:

- Open the document from within the program by choosing Open in the program's File menu.
- Use the PC Exchange control panel to change the document's type to one that can be opened by the program.

If a DOS document is displayed incorrectly, or you see strange codes or characters in the document, try one of the following:

- Your application program may have special procedures for opening and saving documents with different file formats. See the information that came with your program or call the program's publisher.
- Try opening the document in another program.

Note: Some characters that can be displayed on the Macintosh are not accurately displayed on DOS computers, and vice versa.

For more information about working with DOS documents on your Macintosh, see the “Using DOS Files & Disks” topic of Macintosh Guide, available in the Guide (⌘) menu.

Repairing a damaged disk

If you see a message reporting that a disk is damaged or unreadable, you may need to repair the disk.

Try these suggestions first

If you can't start up from a hard disk or you don't see the hard disk icon on the desktop, try the following:

- If the hard disk is internal, shut down your Macintosh, wait at least 10 seconds, and then turn it on again.
- If the hard disk is external, make sure that it is turned on and that its cable is connected firmly; then restart the Macintosh.
- If the hard disk is your startup disk, start up with a different startup disk. (See the following sections, “Starting Up From a CD-ROM Disc” and “Starting Up From a Floppy Disk.”)

If, after you start up from a different disk, your hard disk's icon appears on your desktop, reinstall system software on the hard disk (see “Installing or Reinstalling System Software” later in this chapter).

If your hard disk's icon does not appear on your desktop, you may need to initialize the disk (see “Initializing a Hard Disk” later in this chapter).

- Check the ID numbers of all SCSI equipment connected to your computer. Each device must have a unique ID number less than 7; the computer itself has the ID number 7, and the internal CD-ROM drive (if there is one) has the ID number 3. The ID numbers 0, 1, 2, 4, 5, and 6 are available for additional SCSI devices.

Also check that the chain of devices is terminated properly. For information on setting SCSI ID numbers and terminating a SCSI chain, see the manuals that came with your SCSI equipment.

- If none of these suggestions solves the problem, test the disk by following the instructions given later in this section.

Starting up from a CD-ROM disc

To test, repair, or initialize a hard disk, or to install system software on a hard disk, you need to start up your computer from another disk. If your computer has a CD-ROM drive, you can start up your computer using the *Macintosh Performa CD* that came with your computer.

The procedure for starting up from the CD varies depending on the condition of the system software on your hard disk. To find out which procedure to use, you must turn on your Macintosh.

The steps that follow tell how to start up from a CD-ROM disc, depending on what you see on your screen.

If you see a blinking question mark on your screen

The blinking question mark means that your Macintosh is unable to find usable system software on your hard disk.



- 1 Press the Open/Close button of your CD-ROM drive to open the CD-ROM tray.**
- 2 Place the *Macintosh Performa CD* disc in the tray with the disc label facing up.**

Make sure the disc is lying flat in the tray.

- 3 Push the tray in, or press the Open/Close button, to close the tray.**

Your Macintosh recognizes the CD as a startup disk, and in a few seconds the Macintosh desktop with a Launcher appears.

If you see the Macintosh desktop

- 1 Press the Open/Close button of your CD-ROM drive to open the CD-ROM tray.**
- 2 Place the *Macintosh Performa CD* disc in the tray with the disc label facing up.**
Make sure the disc is lying flat in the tray.
- 3 Push the tray in, or press the Open/Close button, to close the tray.**

If the Macintosh Performa CD icon does not appear on your screen, follow the steps in the section “Problems Starting Up From the CD?”

If the Macintosh Performa CD icon appears on the right side of your screen, continue with these steps.

- 4 Choose Control Panels from the Apple () menu.**
- 5 Double-click the Startup Disk icon.**

The Startup Disk control panel window appears.

- 6 Click the CD icon to select it as your startup disk.**
- 7 Choose Restart from the Special menu.**

Your computer recognizes the CD as its startup disk, and in a few seconds the Macintosh desktop with a Launcher appears.

Problems starting up from the CD?

If you’ve followed the steps in the previous sections and the Macintosh Performa CD icon does not appear on your screen, follow these steps:

- 1 Insert the CD into the tray.**
- 2 Choose Restart from the Special menu.**
- 3 Press and hold down the Command (⌘), Shift, Option, and Delete keys.**

The Macintosh Performa CD icon appears on the desktop.

- 4 Choose Control Panels from the Apple () menu.**
- 5 Double-click the Startup Disk icon.**

The Startup Disk control panel window appears.

- 6 Click the CD icon to select it as your startup disk.
- 7 Close the Startup Disk control panel.
- 8 Press and hold down the Control, Command (⌘), and Power keys.

Starting up from a floppy disk

To test, repair, or initialize a hard disk, or to install system software on a hard disk, you need to start up your computer from another disk. If you don't have a built-in CD-ROM drive, you can start up the computer using the *Utilities* floppy disk that came with your computer.

To start up your computer using the *Utilities* floppy disk, follow these steps:

- 1 Shut down your computer.
- 2 Insert the *Utilities* disk into the disk drive.
- 3 Turn the computer on.

It takes several moments for your computer to start up from the *Utilities* disk.

Checking for damage on your internal hard disk

You can check for damage on your internal hard disk with the Internal HD Format program, which is on the *Utilities* floppy disk that came with your computer. If your computer has a built-in CD-ROM drive and you didn't receive floppy disks, you can find the Internal HD Format program on the *Macintosh Performa CD*. You can use Internal HD Format at any time to check for damaged blocks (segments of the hard disk that cannot reliably be used to store information).

- 1 Start up your computer from the *Utilities* floppy disk or the *Macintosh Performa CD*.

See “Starting Up From a CD-ROM Disc” or “Starting Up From a Floppy Disk” earlier in this section.

- 2 Open the Internal HD Format program.

You may need to look in a folder called Utilities to find Internal HD Format.

3 Choose Scan For Defects in the Functions menu.

If the program finds damaged blocks, it marks them so the computer will not store information in them. This process does not harm any information on the hard disk.

Testing an external SCSI hard disk

You can test an external Apple SCSI hard disk with the Apple HD SC Setup program, which is on the *Macintosh Performa CD* or the *Utilities* disk— whichever came with your computer.

1 Start up your computer from the *Macintosh Performa CD* or the *Utilities* disk.

See “Starting Up From a CD-ROM Disc” or “Starting Up From a Floppy Disk,” earlier in this section.

2 Open the Apple HD SC Setup program.



Apple HD SC Setup

3 Click Drive until the disk you want appears.

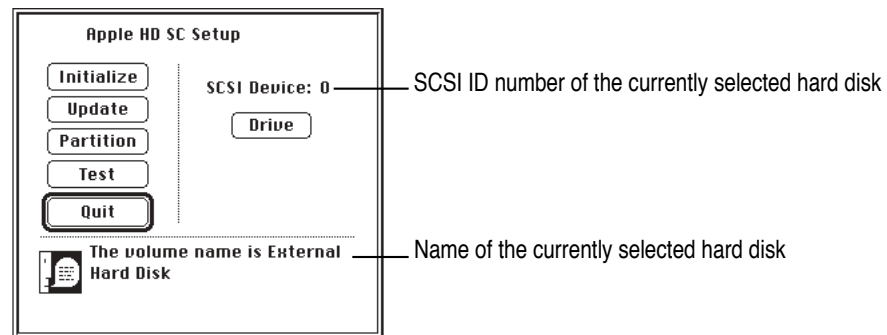

- 4 Click Test.
- 5 When a message tells you that testing is complete, click Quit.

If the test reveals a problem, you may be able to correct it by using Disk First Aid or another disk repair program (see the instructions in the next section), or you may need to reinitialize the disk (see “Initializing a Hard Disk” later in this chapter). Consult an Apple-authorized service provider for assistance if necessary.

How to repair a hard disk or floppy disk

You can repair some types of disk damage by using the Disk First Aid program, which is included either on the *Utilities* floppy disk or on the *Macintosh Performa CD*.

- 1 Start up your computer from the *Utilities* disk or the *Macintosh Performa CD*.

See “Starting Up From a CD-ROM Disc” or “Starting Up From a Floppy Disk” earlier in this section.

- 2 Open the Disk First Aid program.



Disk First Aid

- 3 Click the icon of the disk you want to test.

Disk icons appear in a box at the top of the Disk First Aid window.

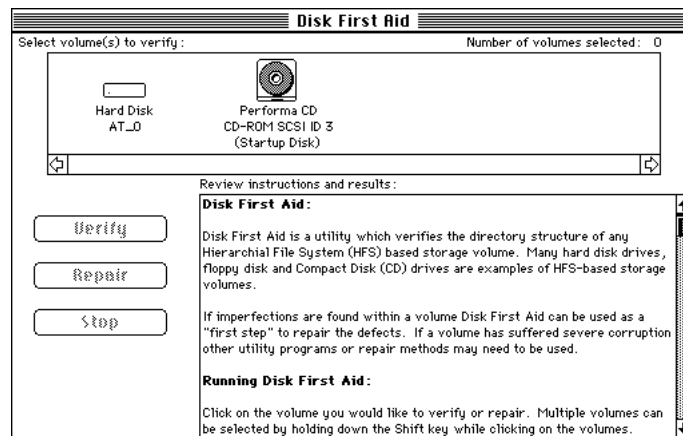

4 Click Repair to begin testing and repairing the disk.

You can't repair the startup disk or the disk that contains the Disk First Aid program, but you can test these disks by clicking Verify. If the program reveals a problem with either of these disks, start up the computer from another disk so that you can repair the damaged disk.

If you want to test and repair another disk, click its icon and then click Repair.

5 When testing and repair are done, choose Quit from the File menu.

If Disk First Aid cannot correct the problem

- Try repairing the disk again. Sometimes repeating the process corrects the problem.
- Use another disk repair or recovery program. Some disk repair programs let you recover information from a damaged disk.
- Consult a computer repair specialist for help.
- Once you have recovered all the information you can and backed it up, erase (reinitialize) the disk. For instructions on reinitializing a floppy disk, see the "Disks" topic of Macintosh Guide, available in the Guide (🔍) menu. For instructions on reinitializing a hard disk, see the next section, "Initializing a Hard Disk."

If initialization doesn't work, discard the damaged disk (if it's a floppy disk), or take it to your Apple-authorized service provider for repair (if it's a hard disk). If you received a copy of the *Macintosh Performa CD* (whether or not your computer has a CD-ROM drive), bring this disc with you to the service provider.

Initializing a hard disk

The hard disk inside your computer was initialized (formatted for use) at the factory, so you shouldn't need to initialize it. You need to initialize a hard disk only if

- you purchase a hard disk that has not been initialized at the factory
- your hard disk is damaged

If a hard disk needs to be initialized, the disk's icon may not appear on the desktop when you start up the computer using another disk.

WARNING Initializing a disk erases any information that may be on it. Before you initialize a damaged disk, try to repair it as described in “Repairing a Damaged Disk” earlier in this chapter.

How to initialize an external SCSI hard disk

You initialize an Apple SCSI hard disk by using a program called Apple HD SC Setup, which is on the *Macintosh Performa CD* or the *Utilities* disk, whichever came with your computer.

- 1 Start up your computer from the *Macintosh Performa CD*.**

See “Starting Up From a CD-ROM Disc” or “Starting Up From a Floppy Disk” in the section “Repairing a Damaged Disk,” earlier in this chapter.

- 2 Open the Apple HD SC Setup program.**



Apple HD SC Setup

- 3 **Click Drive until the disk you want to initialize appears.**

You cannot initialize the disk that you used to start up your computer or the disk that contains the Apple HD SC Setup program.

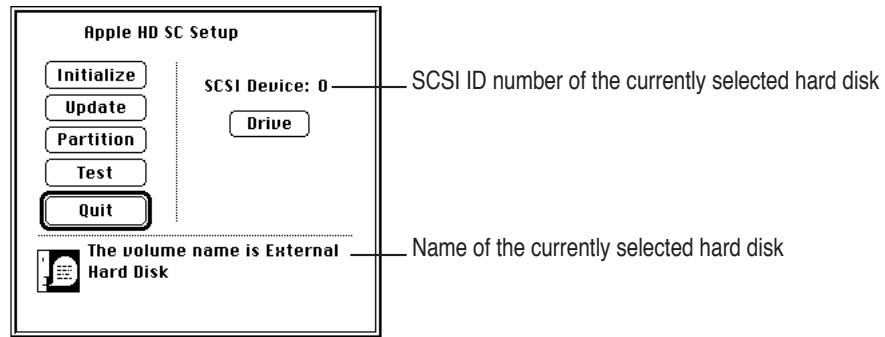

- 4 **Click Initialize.**
- 5 **Click Init to initialize the hard disk.**

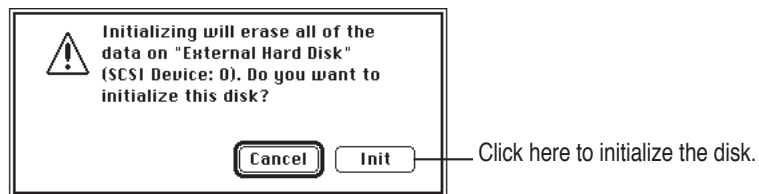

- 6 **If a message appears asking you to name the disk, type a name and then click OK.**
- 7 **Click Quit when you see a message reporting that initialization was successful.**

If a message reports that initialization failed, try again. If initialization fails a second time, take the disk to your Apple-authorized service provider for repair.

Reinitializing your computer's internal hard disk

You initialize your internal hard disk using a program called Internal HD Format, which is on the *Utilities* floppy disk that came with your computer. If your computer came with a CD-ROM drive and you didn't receive floppy disks, you can find Internal HD Format on the *Macintosh Performa CD*.

- 1 Start up your computer from the *Utilities* floppy disk or the *Macintosh Performa CD*.**

See “Starting Up From a CD-ROM Disc” or “Starting Up From a Floppy Disk” in the section “Repairing a Damaged Disk,” earlier in this chapter.

- 2 Click the Internal HD Format Launcher button once (if you are using the *Macintosh Performa CD*) or double-click the Internal HD Format icon (if you are using the *Utilities* floppy disk) to open it.**

- 3 Type a name for your hard disk in the name box.**

- 4 If you want to make sure that none of the hard disk's original information is recognizable after reinitialization, choose Zero Out Data from the Options menu.**

If you choose Zero Out Data, initialization may take a few minutes. (If you don't choose Zero Out Data, initialization will take less than 30 seconds.)

- 5 Click Initialize.**

A message informs you that initializing the disk erases all information on it.

- 6 Click OK.**

During initialization, a status bar shows you the progress of the initialization.

- 7 When the initialization is complete, click Done.**

If a message reports that initialization failed, try again. If initialization fails a second time, take the disk to your Apple-authorized service provider for repair.

Installing or reinstalling system software

System software is the set of programs and other files that your computer uses to start itself up, keep track of your files, and run the application programs you use. System software is kept in the System Folder. When you turn on your computer, it looks for a startup disk, which is a disk that contains the system software. The startup disk is usually the hard disk that's inside your computer, though another hard disk or a floppy disk can also be a startup disk.

When should you install or reinstall system software?

Your Macintosh came with all the necessary system software installed on its internal hard disk, so you don't need to install system software on that disk unless you encounter software problems.

If you have a new hard disk or a newly initialized hard disk that doesn't contain system software, or if you want to upgrade to a more recent version of system software on a hard disk, you'll need to install system software. See the next section, "How to Install or Reinstall System Software."

If your hard disk already has system software installed on it but there is a problem with the disk or the software, you may see this icon in the middle of the screen:



If this icon appears, first try testing your startup hard disk and repairing any damage. To do this, follow the instructions in "Repairing a Damaged Disk" earlier in this chapter. If repairing the disk doesn't help, you may need to reinstall system software.

How to install or reinstall system software

If your computer has a CD-ROM drive, you can install or reinstall system software by following the instructions in the *Macintosh Performa CD* booklet that came with your computer.

If your computer doesn't have a CD-ROM drive and you've used Apple Backup to back up the contents of your hard disk, you can use Apple Restore to reinstall system software. For instructions, see "Restoring the Information on Your Hard Disk" in Chapter 4.

If your computer doesn't have a CD-ROM drive and you have not used Apple Backup to back up the contents of your disk, try one of the following:

- If you received the *Macintosh Performa CD* with your computer, contact an Apple-authorized service provider, a Macintosh user group, or another Macintosh user for access to a CD-ROM drive. Reinstall system software on your hard disk by following the instructions in the *Macintosh Performa CD* booklet that came with your computer.
- If you did not receive the *Macintosh Performa CD* with your computer, or if you cannot get access to a CD-ROM drive, call the customer support hotline. (The phone number for the hotline is in the service and support information that came with your computer.)

Read this appendix for important health and safety instructions, as well as tips on keeping your computer in good working order.



Appendix A Health, Safety, and Maintenance Tips



For your own safety and that of your equipment, follow all the instructions in this chapter. Keep these instructions available for reference by you and others.

Health-related information about computer use

Muscle soreness, eye fatigue, and other discomforts and injuries sometimes associated with using computers can occur from performing any number of activities. In fact, misuse of the same muscles during multiple activities can create a problem that might not otherwise exist. For example, if you engage in nonwork activities that involve repetitive stress on the wrist—such as bicycling—and also use your computer’s keyboard improperly, you may increase your likelihood of developing wrist problems. Some individuals are at greater risk of developing these problems because of their health, physiology, lifestyle, and general exposure to stress. Work organization and conditions, such as workstation setup and lighting, also play a part in your overall health and comfort. Preventing health problems is a multifaceted task that requires careful attention to the way you use your body every hour of every day.

The most common health effects associated with using a computer are musculoskeletal discomfort and eye fatigue. We’ll discuss each area of concern below.

Musculoskeletal discomfort

As with any activity that involves sitting for long periods of time, using a computer can make your muscles sore and stiff. To minimize these effects, set up your work environment carefully, using the guidelines that follow, and take frequent breaks to rest tired muscles. To make working with your computer more comfortable, allow enough space in your work area so that you can change position frequently and maintain a relaxed posture.

Another type of musculoskeletal concern is repetitive stress injuries (RSIs), also known as cumulative trauma disorders (CTDs). These problems can occur when a certain muscle or tendon is repeatedly overused and forced into an unnatural position. The exact causes of RSIs are not totally understood, but in addition to awkward posture, such factors as the amount of repetition, the force used in the activity, the individual's physiology, workplace stress level, and lifestyle may affect the likelihood of experiencing an RSI.

RSIs did not suddenly arise when computers were invented; tennis elbow and writer's cramp, for example, are two RSIs that have been with us for a long time. Although less common than other RSIs, one serious RSI discussed more often today is a wrist problem called carpal tunnel syndrome, which may be aggravated by improper use of computer keyboards. This nerve disorder results from excessive pressure on the median nerve as it passes through the wrist to the hand.

This section offers advice on setting up your work area to enhance your comfort while you use your computer. Since the effects of repetitive movements associated with using a computer can be compounded by those of other work and leisure activities to produce or aggravate physical problems, proper use of your computer system must be considered as just one element of a healthy lifestyle.

No one, of course, can guarantee that you won't have problems even when you follow the most expert advice on using computer equipment. You should always check with a qualified health specialist if muscle, joint, or eye problems occur.

Eye fatigue

Eye fatigue can occur whenever the eyes are focused on a nearby object for a long time. This problem occurs because the eye muscles must work harder to view an object that's closer than about 20 feet (6 meters). Improper lighting can hasten the development of eye fatigue. Although eye fatigue is annoying, there's no evidence that it leads to permanent damage.

Whenever you're engaged in an activity that involves close-up work—such as reading a magazine, doing craft work, or using a computer—be sure to have sufficient glare-free lighting and give your eyes frequent rest breaks by looking up and focusing on distant objects. Remember to have your eyes examined regularly.

To prevent discomfort and eye fatigue:

- Arrange your work space so that the furniture is properly adjusted for you and doesn't contribute to an awkward working posture.
- Take frequent short breaks to give your muscles and eyes a chance to rest.

Arranging your office

Here are some guidelines for adjusting the furniture in your office to accommodate your physical size and shape.

- An adjustable chair that provides firm, comfortable support is best. Adjust the height of the chair so your thighs are horizontal and your feet flat on the floor.

The back of the chair should support your lower back (lumbar region). Follow the manufacturer's instructions for adjusting the backrest to fit your body properly.

- When you use the computer keyboard, your shoulders should be relaxed. Your upper arm and forearm should form an approximate right angle, with your wrist and hand in roughly a straight line.

You may have to raise your chair so your forearms and hands are at the proper angle to the keyboard. If this makes it impossible to rest your feet flat on the floor, you can use a footrest with adjustable height and tilt to make up for any gap between the floor and your feet. Or you may lower the desktop to eliminate the need for a footrest. Another option is to use a desk with a keyboard tray that's lower than the regular work surface.

- Position the mouse at the same height as your keyboard. Allow adequate space to use the mouse comfortably.
- Arrange the monitor so the top of the screen is slightly below your eye level when you're sitting at the keyboard. The best distance from your eyes to the screen is up to you, although most people seem to prefer 18 to 28 inches (45 to 70 cm).
- Position the monitor to minimize glare and reflections on the screen from overhead lights and windows. You may want to use a tiltable monitor stand. The stand lets you set the monitor at the best angle for viewing, helping to reduce or eliminate glare from lighting sources you can't move.

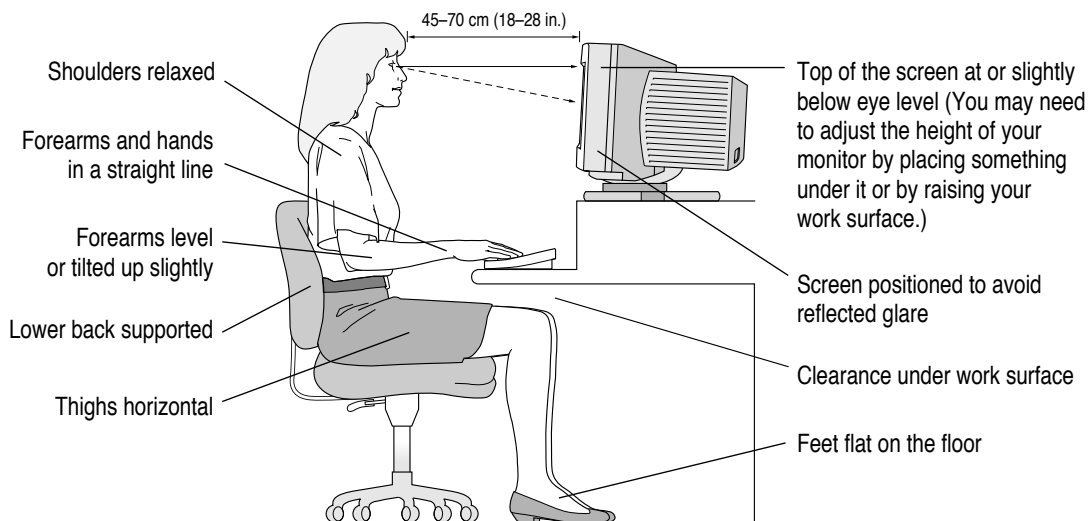

Avoiding fatigue

- Change your seated position, stand up, or stretch whenever you start to feel tired. Frequent short breaks are helpful in reducing fatigue.
- Use a light touch when typing or using a mouse and keep your hands and fingers relaxed.
- Some computer users may develop discomfort in their hands, wrists, or arms after intensive work without breaks. If you begin to develop chronic pain or discomfort in your hands, wrists, or arms, consult a qualified health specialist.
- Allow adequate work space so that you can use your keyboard and mouse comfortably. Place papers or other items so you can view them easily while using your computer. A document stand may make reading papers more comfortable.
- Eye muscles must work harder to focus on nearby objects. Occasionally focus your eyes on a distant object, and blink often while you work.
- Clean your screen regularly. Keeping the screen clean helps reduce unwanted reflections.

What about electromagnetic emissions?

There has been recent public discussion of the possible health effects of prolonged exposure to extremely low frequency (ELF) and very low frequency (VLF) electromagnetic fields. Such fields are associated with electromagnetic sources such as television sets, electrical wiring, and some household appliances—as well as computer monitors.

Apple has reviewed scientific reports and sought the counsel of government regulatory agencies and respected health organizations. Based on the prevailing evidence and opinions, Apple believes that the electric and magnetic fields produced by computer monitors do not pose a health risk.

In response to those customers who wish to reduce their exposure to electromagnetic fields, Apple has lowered the emission levels of our products. We are also actively encouraging further scientific research so we can continue to promote the health and safety of our customers and employees.

Safety instructions

For your own safety and that of your equipment, always take the following precautions.

Turn off the computer completely and disconnect the power plug (by pulling the plug, not the cord) if any of the following conditions exists:

- the power cord or plug becomes frayed or otherwise damaged
- you spill something into the case
- your Macintosh is exposed to rain or any other excess moisture
- your Macintosh has been dropped or the case has been otherwise damaged
- you suspect that your Macintosh needs service or repair
- you want to clean the case (use only the recommended procedure described later in this chapter)

Be sure that you always do the following:

- Keep your Macintosh away from sources of liquids, such as wash basins, bathtubs, shower stalls, and so on.
- Protect your Macintosh from dampness or wet weather, such as rain, snow, and so on.
- Read all the installation instructions carefully before you plug your Macintosh into a wall socket.
- Keep these instructions handy for reference by you and others.
- Follow all instructions and warnings dealing with your system.

WARNING Electrical equipment may be hazardous if misused. Operation of this product, or similar products, must always be supervised by an adult. Do not allow children access to the interior of any electrical product and do not permit them to handle any cables.



Handling your computer equipment

Follow these guidelines for handling your computer and its components:

- When setting up your computer, place components on a sturdy, flat surface, and carefully follow all setup instructions.
- When connecting or disconnecting a cable, always hold the cable by its connector (the plug, not the cord).
- Turn off your computer and all its components before connecting or disconnecting any cables to add or remove any component. Failure to do so could seriously damage your equipment.
- Never force a connector into a port. If the connector and port do not join with reasonable ease, they probably don't match. Make sure that the connector matches the port and that you have positioned the connector correctly in relation to the port.
- Take care not to spill any food or liquid on the computer, keyboard, mouse, or other components. If you do, turn your computer off immediately and unplug it before cleaning up the spill. Depending on what you spilled and how much of it got into your equipment, you may have to bring your equipment to an Apple-authorized service provider.
- Protect the computer and its components from direct sunlight and rain or other moisture.
- Keep all ventilation openings clear and unobstructed. Without proper air circulation, components can overheat, causing damage or unreliable operation.

WARNING This equipment is intended to be electrically grounded. Your Macintosh is equipped with a three-wire grounding plug—a plug that has a third (grounding) pin. This plug will fit only a grounded AC outlet. This is a safety feature. If you are unable to insert the plug into the outlet, contact a licensed electrician to replace the outlet with a properly grounded outlet. Do not defeat the purpose of the grounding plug!

Handling the monitor

Follow these procedures for handling a monitor:

- Turn down the screen brightness control if you leave the computer turned on for extended periods. If the brightness is not turned down, the image on the screen could “burn in” and damage the screen.

You can also use a “screen saver” program, which dims or varies the image on the screen when the computer has been idle for a specified period of time. These programs are available from independent suppliers and user groups.

- Make sure that the ventilation openings on the computer and the monitor are clear and unobstructed.
- Some large monitors cannot safely be placed on top of the computer. Check the instructions that came with the monitor for setup information.
- If there is interference on the monitor’s screen or on a television or radio near your computer, move the affected equipment farther away.

Handling the keyboard

Take care not to spill any liquid on the keyboard. If you do, turn off your computer immediately.

- If you spill liquid that is thin and clear, unplug the keyboard, turn it upside down to let the liquid drain out, and let it dry for 24 hours at room temperature. If, after you take these steps, the keyboard doesn’t work, take it to an Apple-authorized service provider for repair.
- If you spill liquid that is greasy, sweet, or sticky, unplug the keyboard and take it to an Apple-authorized service provider for repair.

Handling floppy disks

Store disks at temperatures between 50° F and 125° F.

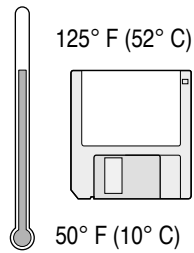

Do not use a pencil or an eraser on a disk or disk label.

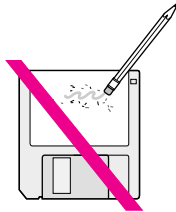

Keep disks dry.

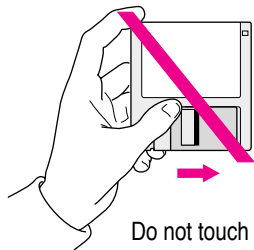
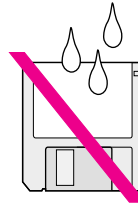

Do not touch the exposed part of the disk behind the metal shutter.

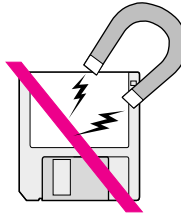

Keep disks away from magnets.

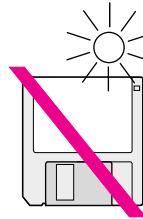

Avoid exposing disks to extremely hot temperatures.

Ejecting a disk

For instructions on ejecting a floppy disk, a CD-ROM disc, or a removable media disk, see the “Disks” topic of Macintosh Guide, available in the Guide (🔍) menu.

If you can't eject a floppy disk

If you can't eject a floppy disk in the usual way, try the following in order:

- Hold down the ⌘ and Shift keys and press the number 1 key on your keyboard to eject a disk in the internal disk drive.
- Turn off the computer. If the disk isn't ejected, then hold down the button on your mouse or other pointing device while you turn the computer on again.
- Locate the small hole near the disk drive's opening, and carefully insert the end of a large straightened paper clip into it. Push gently until the disk is ejected. Do not use excessive force.

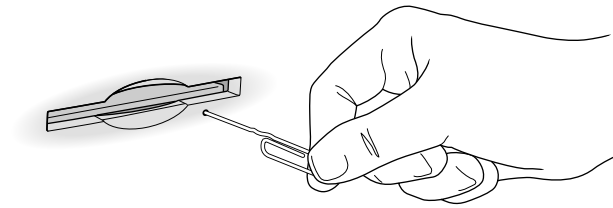

If nothing works, take the computer or disk drive to your Apple-authorized service provider to have the disk removed.

Power supply

The power supply in your computer is a high-voltage component and should not be opened for any reason, even when the computer is off. If the power supply needs service, contact your Apple-authorized dealer or service provider.

Cleaning your equipment

Follow these general rules when cleaning the outside of your computer and its components:

- Use a damp, soft, lint-free cloth to clean the computer's exterior. Avoid getting moisture in any openings.
- Don't use aerosol sprays, solvents, or abrasives.

Cleaning the computer case

To clean the case, do the following:

- 1 Turn off the computer completely and then disconnect the power plug. (Pull the plug, not the cord.)**
- 2 Wipe the surfaces lightly with a clean, soft cloth dampened with water.**

Cleaning the monitor

To clean the screen, put household glass cleaner on a soft cloth and wipe the screen. Don't spray the cleaner directly on the screen, because the liquid might drip into the monitor or computer.

Cleaning the mouse

The mouse contains a small ball that must roll smoothly for the mouse to work properly. You can keep this ball free of dirt and grease by using the mouse on a clean, lint-free surface and cleaning it occasionally.

You need a few cotton swabs and a clean, soft, lint-free cloth.

- 1 Turn off your computer.**

- 2 Turn the mouse upside-down and turn the plastic ring on the bottom counterclockwise to disengage it.**

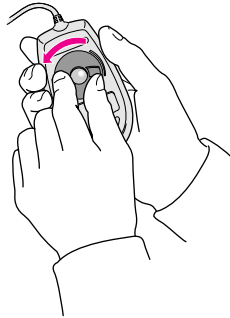

On some mouse devices, you may need to press the plastic ring (rather than turn it) to disengage it. If you cannot disengage the ring, your mouse may be locked. See “Locking and Unlocking the Mouse,” next in the appendix.

- 3 Turn the mouse right-side up with one hand and catch the ring and the ball with your other hand.**

- 4 Clean the three small rollers inside the mouse with a cotton swab moistened with water.**

Rotate the rollers to clean all around them.

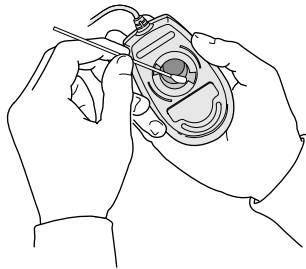

- 5 Wipe the mouse ball with a clean, soft, dry, and lint-free cloth.**
- 6 If necessary, wash the mouse ball with warm soapy water (use a mild soap such as a dishwashing liquid) and then dry the mouse ball thoroughly.**
- 7 Gently blow into the mouse case to remove any dust that has collected there.**
- 8 Put the ball and the ring back in place.**

Your mouse should roll smoothly across your mouse pad or desk. If it doesn't, repeat these instructions carefully.

Locking and unlocking the mouse

Some mouse devices can be locked so that the ball can't be removed. A locking mouse has a small hole on the plastic ring.

To lock the mouse, follow these steps:

- 1 Insert a straightened paper clip into the hole on the plastic ring.**

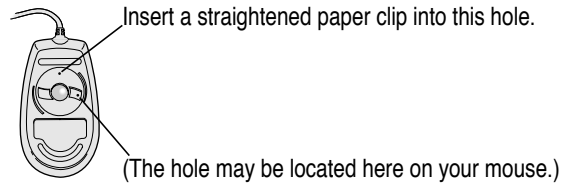

- 2 Press down on the paper clip while you turn the ring clockwise.**

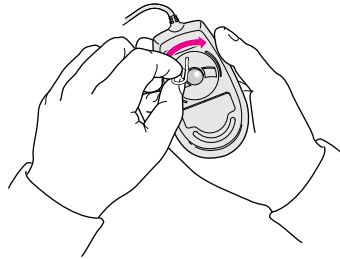

Turn the ring a very short distance, until it stops. When the recessed area on the ring is *not* lined up with the recessed area surrounding the ring, the mouse is locked.

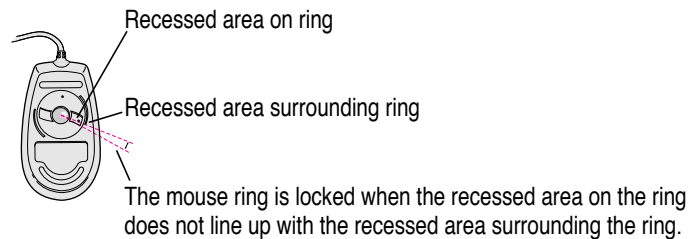

To unlock the mouse, follow these steps:

- 1 Insert a straightened paper clip into the hole on the plastic ring.**

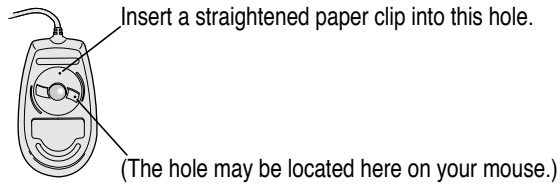

- 2 Press down on the paper clip while you turn the ring counterclockwise.**

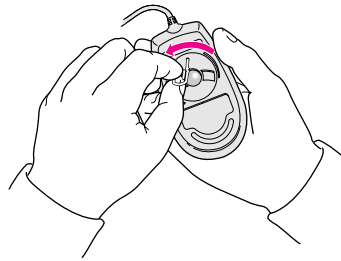

Turn the ring a very short distance. When the recessed area on the ring is lined up with the recessed area surrounding the ring, the mouse is unlocked.

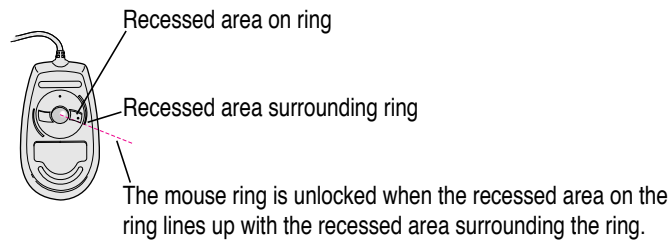

Read this appendix for instructions
on installing an expansion card
in your computer.



Appendix B Installing an Expansion Card



Expansion cards are printed circuit boards that can be installed in your computer to give it special capabilities, such as enhanced video capabilities, networking and communications, and additional processing power.

If you purchased an expansion card separately from your computer, you can install it by following the instructions that came with the card, or by following the instructions in this appendix. However, be sure to read this appendix for instructions that may be specific to your computer.

Cards fit into slots on the computer's logic board, the board that holds the components that make your computer work. There are three types of slots on your computer's logic board, each labeled on the board:

- an LC-compatible 68030 processor-direct slot (PDS) for most expansion cards
- a communication slot for an internal modem or an Ethernet card
- a video-in slot for a card that brings signals into the computer from a videocassette recorder (VCR), laserdisc player, video camera, or similar device

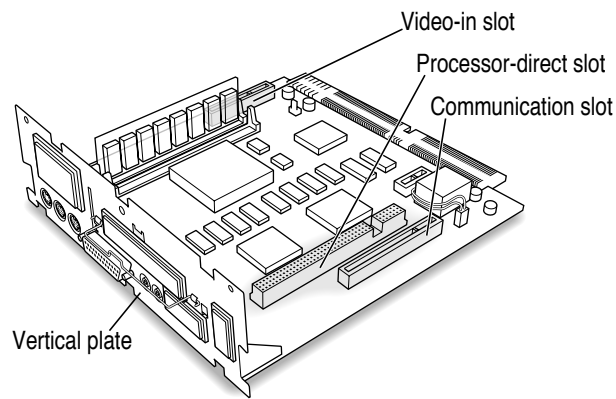

This appendix contains instructions for installing a PDS card or a communication card. To install a video input card or a TV tuner card, follow the instructions that came with the card.

WARNING To avoid damaging your computer and expansion card, do not attempt to install any expansion card without first checking the documentation for that card. If the documentation specifies that an Apple-certified technician must install the card (usually because the installation requires special training or tools), consult the service and support information that came with your computer for instructions on how to contact an Apple-authorized service provider or Apple for assistance. If you attempt to install the card yourself, any damage you may cause to the computer or card will not be covered by the limited warranty on your computer. If the card is not an Apple-labeled product, check with an Apple-authorized dealer or service provider to see if you can install it yourself.

Installing an expansion card involves three steps:

- opening the computer
- inserting the card into a specific slot
- closing the computer

Opening the computer

- 1** Shut down your computer by choosing Shut Down from the Apple () menu or the Special menu.

You can also press the Power key on the keyboard.

- 2** Unplug all the cables except the power cord from your computer.

Leaving the power cord plugged in helps protect the computer from electrostatic discharge.

IMPORTANT To avoid generating static electricity that may damage components, do not walk around the room until you have completed the installation of the expansion card and closed the computer. Additionally, move the logic board as little as possible while it is outside the computer case.

- 3** Place your thumbs on the two tabs at the top of the computer's back panel, and press down.

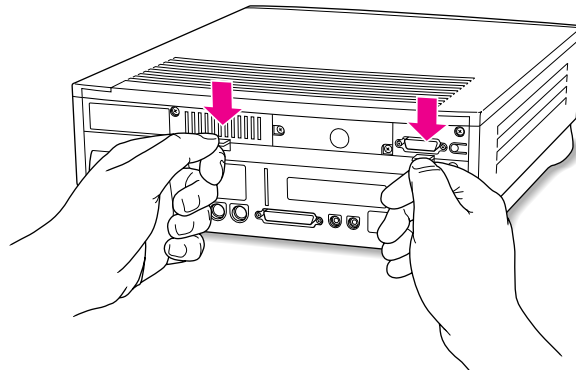

- 4** Pulling gently, swing the panel down, and slip it out.

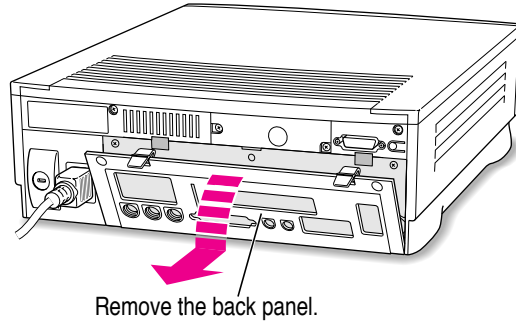

- 5** If there are security screws on the vertical plate on the back of the computer, remove them with a Phillips screwdriver.

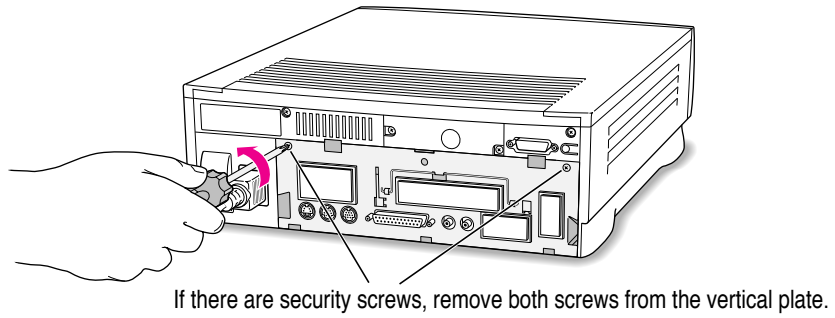

- 6** Unplug the power cord from your computer.
- 7** Swing the handle out from its storage position. Then grasp the handle and gently but firmly pull it toward you.

The vertical plate and the logic board to which it's attached slide all the way out of the computer. Carefully support the logic board as it comes out, and put it on a stable, clean, flat surface.

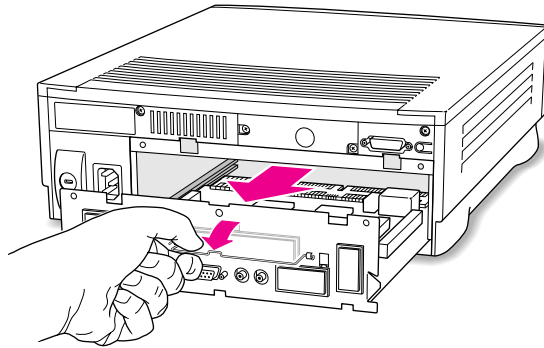

What you do next depends on the type of expansion card you want to install.

Installing a processor-direct slot (PDS) card

- 1 If your PDS (processor-direct slot) card has ports for connecting equipment, remove the plastic access cover from the vertical plate.

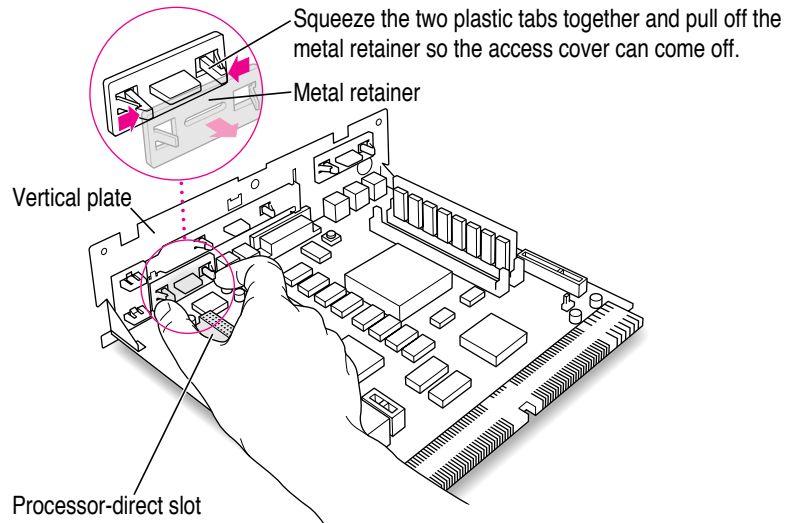

- 2 Remove the PDS card from its static-proof bag.
Hold the card by its edges to avoid touching any connectors on the card.
- 3 Locate the slot labeled LC PDS SLOT on the logic board.
- 4 Align the card over the processor-direct slot.

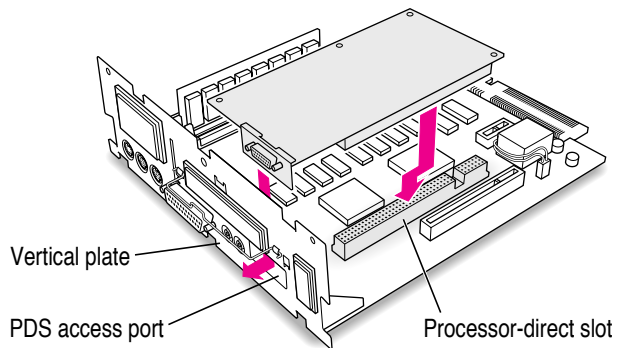

- 5 Press down on the card until the connector is solidly in place.**

Don't force the card. If you meet resistance, pull the card out and try again. To see if the card is properly connected, lift it gently. If it resists and stays in place, it's connected.

Installing a communication card

- 1 If your communication card has ports for connecting equipment, remove the plastic access cover from the vertical plate.**

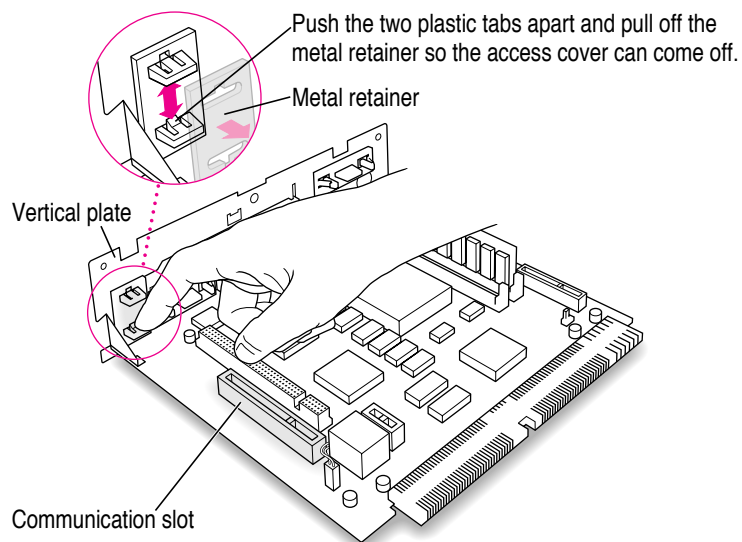

- 2 Remove the communication card from its static-proof bag.**
Hold the card by its edges to avoid touching any connectors on the card.
- 3 Locate the slot labeled COMMUNICATION SLOT on the logic board.**

4 Align the card over the communication slot.

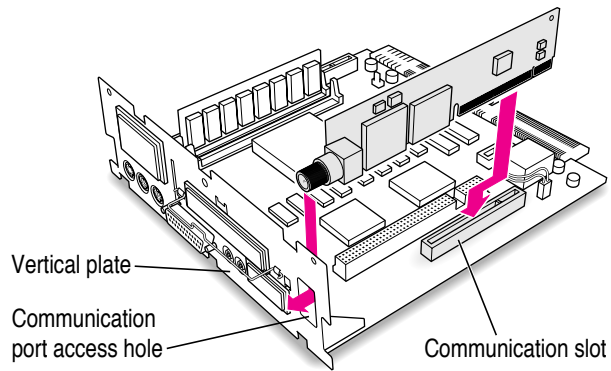

5 Press down on the card until the connector is solidly in place.

Don't force the card. If you meet resistance, pull the card out and try again.

To see if the card is properly connected, lift it gently. If it resists and stays in place, it's connected.

Closing the computer

- 1 Slip the base of the logic board into the guide rails inside the computer case and swing the handle back into its storage position.

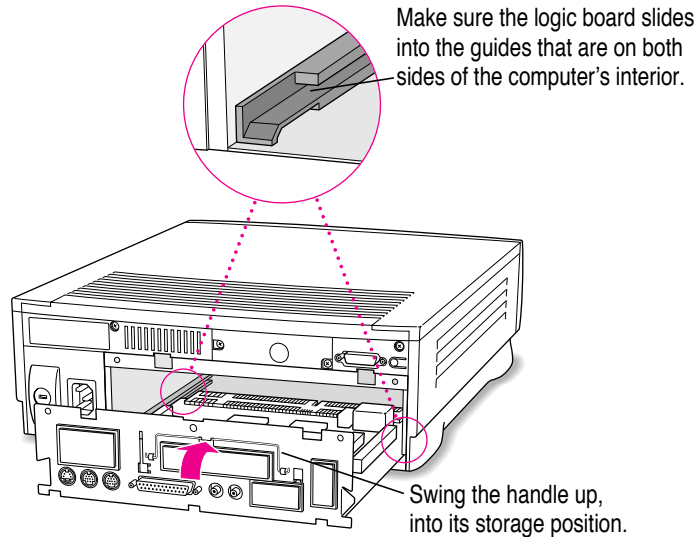

- 2 Press the reset button on the logic board, and then slide the board back into the computer.

When you press the reset button, some of your computer's software settings will change. You may want to open the control panels for the date and time, keyboard, and mouse to make sure that they are set the way you want them. For more information about working with control panels, see the "Setting Options" topic of Macintosh Guide, available in the Guide (🔍) menu.

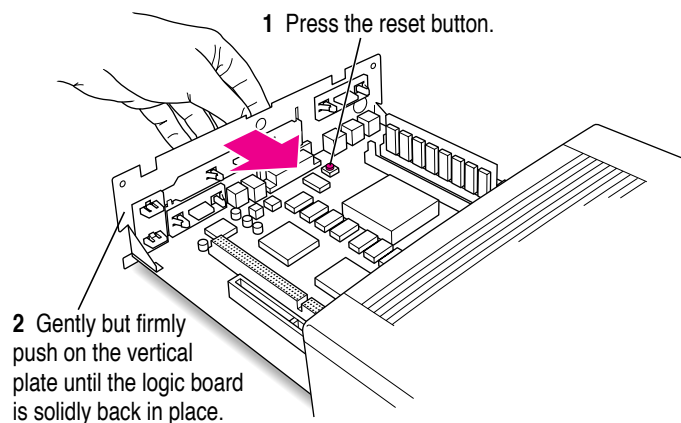

- 3** If you removed security screws earlier, reinsert them now.

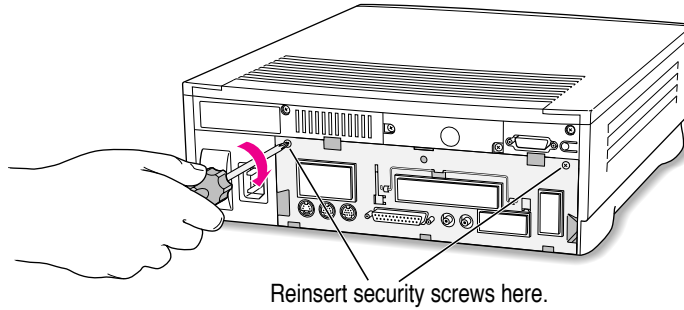

- 4** Slip the three hooks at the base of the back panel into the grooves on the computer case.

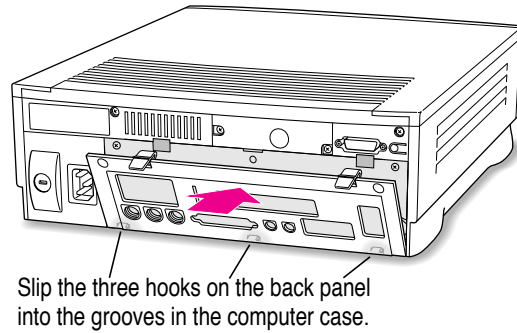

- 5** Swing the back panel up and snap it into place.

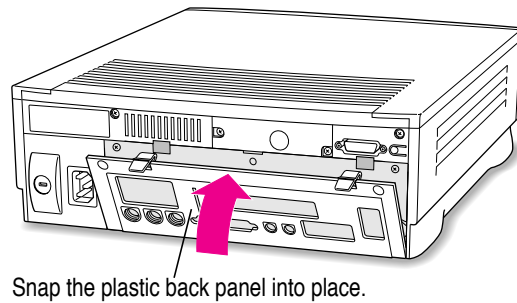

6 Plug the cables back into the computer.

7 Reconnect the power cord.

Your computer is now ready to turn on and use.

WARNING Never turn on your computer unless all of its internal and external parts are in place. Operating the computer when it is open or missing parts can be dangerous, and can damage your computer.





Read this appendix to learn
how to use the special
keys on your keyboard.

Appendix C Special Keys on Your Keyboard

Your computer keyboard contains certain special keys that typewriter keyboards don't have. Many of these keys allow you to give commands to the computer without using the mouse. For example, in many application programs, pressing the ⌘ (Command) key at the same time as the Q key is often an alternative method of quitting a program.

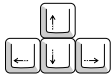
The following table describes what you can do with the special keys on your keyboard. The number of special keys on your keyboard may vary from this list; it depends on the model of keyboard you have.

Special keys on Apple keyboards

Arrow keys		Use to move the insertion point, as an alternative to using the pointer. In some programs, the arrow keys have other functions.
Caps Lock key		Use to capitalize a series of letters (numbers and symbols aren't affected).
Clear key		Use to delete the current selection (or use the Delete key). In some programs, Clear has other functions.
⌘ (Command) key		Use in combination with other keys as an alternative to choosing a menu command.

continued ►

Special keys on Apple keyboards *(continued)*

Control key



In combination with other keys, this key provides shortcuts or modifies other actions.

Delete key



Use to delete selected material, or the character to the left of the insertion point.

Enter key



In a dialog box, pressing Enter is the same as clicking the outlined button. In some programs, pressing this key confirms information you have provided.

Escape key



The function of this key depends on the program you're using.

Function keys



Some programs allow you to use the 12 function keys to give commands. You can assign commands or action sequences to function keys with special utility programs.

Option key



Use in combination with other keys to produce special characters or modify actions.

Numeric keys



Use to produce numbers and mathematical symbols; some programs use these keys as function keys to initiate actions.

Power key



On some models, press to turn on the computer. Also press to shut down the computer on certain models.

Return key



Use to move the insertion point to the beginning of the next line. In a dialog box, pressing Return is the same as clicking the outlined button.

Shift key



Use to produce capital letters (or the upper character on the key).

Tab key



Use to move the insertion point to the next stopping place (such as a tab stop or field in a dialog box or program).

Other special keys



The function of these keys depends on the operating system and program you're using.

If you see rectangles: If you see rectangles instead of diacritical marks on some of the pictures of keys in Key Caps, try pressing Option-⌘ to see the diacritical marks. However, you only need to use the Option key (not Option-⌘) in combination with the other keys to type letters with diacritical marks.

If you press the Option key at the same time as a key for a specific diacritical mark and then release both keys, Key Caps outlines in bold the keys for letters that can be typed with that mark. (You'll see that most key combinations for diacritical marks can be used with the Space bar as well as letter keys—producing the mark without a letter.)

The most common diacritical marks and how to create them are summarized next.

Diacritical mark	Key combination
Grave accent (`)	Option-` , then type the character
Acute accent (´)	Option-e, then type the character
Circumflex (^)	Option-i, then type the character
Tilde (~)	Option-n, then type the character
Umlaut (¨)	Option-u, then type the character
The letter “c” with a cedilla (ç)	Option-c

- **To type a letter or a space with a specific diacritical mark, press the Option key and the key for the mark simultaneously. Then type the letter that needs the mark.**

If you are having trouble getting a mark and letter to appear together, try again. Be sure to press the Option key before (or at the same time as) the key for the mark; then, after you release both keys, type the letter to be marked.

Special key combinations

If difficulties with your mouse or computer don't allow you to use standard methods of quitting a program or restarting your computer, you can try using these special key combinations.

To do this press this key combination
Force a program to quit	⌘-Option-Esc
Force the computer to restart	⌘-Control-Power



If you can't find what you're looking for in this index, look in Macintosh Guide—available in the Guide (🔍) menu on your computer.



Index

- 🍏 (Apple) menu 15
- ^ (circumflex) 104
- ⌘-Control-Power key, for restarting computer 51
- ⌘-Option, for rebuilding desktop 52
- ⌘-Option-Esc, for quitting program in trouble 51, 58
- ⌘-Shift-1, for ejecting floppy disk 84
- ⌘-Shift-Option-Delete, to not start up from internal hard disk 47
- | (insertion point) 60, 102
- 🔍 icon, as Guide menu indicator 14, 17
- ~ (tilde) 104
- ¨ (umlaut) 104

A

- accented characters, typing 104
- activating application programs 14
- active program indicator 39
- active window, checking for 14
- acute accent, typing 104
- ADB port. *See* Apple Desktop Bus (ADB) port
- air circulation around case 81

- Apple Backup program 40–45
 - button for 42, 44
 - updating backup copy with 43–45
 - using for first time 41–43
- Apple Desktop Bus (ADB) port 32
 - icon for 6, 7
 - troubleshooting 60
- Apple Extras folder 37
- Apple HD SC Setup program 67–68, 70–71
- Apple menu 15
- Apple PlainTalk Microphone
 - connecting 33
 - jack for (sound input port) 32
- Apple Restore program 46–48
 - button for 47
- AppleScript program 37
- Apple Video Player 37
- Application menu
 - Hide Others command 40
 - icon for 14
 - open programs listed in 39
 - Show All command 40
- application programs 38–40
 - activating 14
 - active, identifying 14, 39
 - additional, on hard disk 38
 - backing up 40–45
 - can't be found 62

- compatibility with system software 58, 60
- disk repair 68–69
- disk test, for external hard disks 67–68
- disk test, for internal hard disk 66–67
- installing 37, 38
- memory problems with 61
- opening 14, 39
- open, listed 39
- quitting unexpectedly 58, 61
- quitting when system freezes 51
- screen saver program 53, 82
- switching between 14, 39
- troubleshooting 38, 58–62
 - for typing special characters 103–104
- Applications button (Launcher) 41, 43
- arrow keys 101
- arrow pointer on screen
 - “frozen” 58–59
 - moving 13–14
- audio input/output jacks (sound input/output ports) 32
- audio level (volume) buttons 31, 35
- audio-visual (AV) capabilities, Apple Video Player program for 37
- automating tasks 37

B

- backing up files or disks 40–45
- Balloon Help 28
- basic Macintosh skills 13–14
- battery for clock 53
- blinking question mark disk icon 54, 73
- “bomb” message 51, 58
- buttons. *See also* icons
 - Apple Backup (Launcher) 41, 43
 - Apple Restore (Launcher) 47
 - “Huh?” (Macintosh Guide window) 27
 - Index (Macintosh Guide window) 23–24

- Internal HD Format (Launcher) 72
- Look For (Macintosh Guide window) 21, 25–26
- Open/Close, for CD-ROM drive 31
- Performa Tutorial (Launcher) 13
- reset (logic board) 97
- standby power (on/off switch) 2, 16
- Topics (Macintosh Guide window) 21–22
- volume (computer) 31, 35

C

- cables
 - checking keyboard 60
 - checking monitor 53
 - checking mouse 59
 - connecting monitor 5
 - connecting mouse and keyboard 6–7
 - and safety concerns 81
- cable television, TV tuner card for 32, 90
- capital letters 101, 102
- Caps Lock key 101
- cards. *See* communication card; Ethernet expansion card; expansion card; processor-direct slot (PDS) expansion card; video input card
- caret. *See* circumflex, insertion point
- carpal tunnel syndrome 76
- case
 - cleaning 85
 - closing 97–99
 - installing communication card in 95–96
 - installing Ethernet expansion card in 95–96
 - installing internal modem in 95–96
 - installing processor-direct slot (PDS) expansion card in 94–95
 - opening 91–93

CD-ROM drive. *See also Macintosh Performa CD*

- adding or replacing 36
- ejecting disk from 83
- location of, in computer 31
- Open/Close button for 31
- starting up from 47, 64–66

cedilla, typing 104

characters, special 103–104

checkmark in menu 39

circumflex, typing 104

cleaning

- computer case 85
- monitor 85
- mouse 85–86
- spills 80, 81, 82

Clear key 101

clock, troubleshooting 53

close box 14

closing computer 97–99

closing Macintosh Guide window 27

Command-Control–Power key, for restarting computer 51

Command key 101

Command-Option, for rebuilding desktop 52

Command-Option-Esc, for quitting program in trouble 51, 58

commands

- assigning to function keys 102
- shortcuts for 29–30, 101, 102

Command-Shift-1, for ejecting floppy disk 84

Command-Shift-Option-Delete, to not start up from internal hard disk 47

common problems 53–63. *See also specific problems;* troubleshooting

communication card 91–93, 95–99

- access cover for 32
- expansion slot for 90
- installing 95–96
- opening computer for 91–93
- and warranty caution 90

computer case. *See case*

computer startup tone 2

connecting. *See installing*

connectors, handling 81

Control key 102

control panels

- compatibility problems with 58, 59
- Extensions Manager 58
- Memory 61
- PC Exchange 62
- Startup Disk 65
- turning off 58

copying files or disks 40

cumulative stress disorders (CTDs) 76

cursor. *See pointer*

customer support hotline 17

D

Delete key 102

desk accessories

- compatibility problems with 56, 58, 59
- turning off (in Extensions Manager control panel) 58

desktop

- hard disk icon does not appear on 56
- hiding or showing windows on 40
- illustrated 14
- rebuilding 52, 62
- at startup 10

diacritical marks, typing 104

dialog boxes 51

dimmed icons 39

disc. *See Macintosh Performa CD*

Disk First Aid program 68–69

disk icons

- with blinking question mark 10, 54, 73
- with X in center 55

disk repair program 68–69

disks. *See floppy disks; hard disk*

- disk test programs
 - for external hard disk 67–68
 - for internal hard disk 66–67
- displaying windows on desktop 40
- documents, DOS 62–63
- DOS disks 57
- drive. *See* CD-ROM drive, floppy disk drive, hard disk

E

- ejecting disks 83
 - problems with 84
- electrical safety 2, 79, 80, 81, 84
- electromagnetic emissions 79
- electronic mail 37
- ELF (extremely low frequency)
 - emissions 79
- Empty Trash command (Special menu) 14
- entering text. *See* typing
- Enter key 102
- erasing external hard disk, by initializing 70–71
- erasing internal hard disk, by initializing 70, 72
- erasing selected material 102
- ergonomics 75–79
- error messages 50. *See also* troubleshooting
- Escape key 102
- Ethernet expansion card 91–93, 95–99
 - access cover for 32
 - installing 95–96
 - opening computer for 91–93
 - slot for 90
 - and warranty caution 90
- expanding computer 31–36
- expansion card 89–99
 - access cover for 32
 - installing 90, 94–96
 - opening computer for 91–93
 - slots for 90
 - and warranty caution 90

- extensions
 - compatibility problems with 56, 58, 59
 - turning off (in Extensions Manager control panel) 58
- extremely low frequency (ELF)
 - emissions 79
- eye fatigue problems 77

F

- fatigue
 - avoiding 79
 - eye problems 77
- files, backing up 40–45
- Finder
 - activating 20
 - active program indicated in 39
 - application management in 39
 - automating tasks in 37
 - icon for 39
 - Macintosh Guide and 20, 27
 - shortcuts in 29–30
- floppy disk drive
 - ejecting disk from 83
 - inserting disk in 38
 - location of, in computer 31
 - replacing 36
- floppy disks
 - backing up on 43
 - DOS 57
 - ejecting, from drive 83
 - handling guidelines for 83
 - initializing 57
 - inserting in drive 38
 - locking 43
 - problems ejecting 84
 - problems reading 57
 - rebuilding desktop on 52
 - repairing 68–69
 - starting up from 66
 - troubleshooting 57, 68–69
 - unlocking 45
 - Utilities* 46

- formatting external hard disk 70–71
- formatting floppy disks 57
- formatting internal hard disk 70, 72
- frozen system, troubleshooting 51, 58–59
- function keys 102

G

- grave accent, typing 104
- grounding plug 2, 81
- Guide menu 14, 17, 19. *See also* Balloon Help; Macintosh Guide window
 - Hide Balloons command 28
 - Macintosh Guide command 20
 - Shortcuts command 29–30
 - Show Balloons command 28

H

- handling computer equipment 81–84
 - floppy disks 83
 - keyboard 82
 - monitor 82
 - power supply 84
 - safety concerns 79, 80
- hard disk
 - backing up 40–45
 - damaged 63, 66–69
 - erasing external 70–71
 - erasing internal 70, 72
 - initializing external 70–71
 - initializing internal 70, 72
 - installing application programs on 38
 - installing system software on 73–74
 - location of internal, in computer 31
 - rebuilding desktop on 52
 - repairing 63–69
 - replacing internal 36
 - restoring information on 46–48
 - SCSI ID number for 63
 - testing external 67–68
 - testing internal 66–67
 - troubleshooting 56, 63–69

- hard disk icon 10, 14
 - failure to appear 56
- hardware components viii, 31, 32
 - cleaning 85–86
 - handling guidelines 81–84
- HD SC Setup program 67–68, 70–71
- headphones
 - jack for 31
 - sound output port for 32
- health concerns 75–79. *See also* safety instructions
 - avoiding fatigue 79
 - cumulative stress disorders (CTDs) 76
 - electromagnetic emissions 79
 - eye fatigue 77
 - musculoskeletal discomfort 76
 - office arrangement and 77–78
 - repetitive stress injuries (RSIs) 75, 76
- help. *See* Balloon Help; Guide menu; Macintosh Guide window; service and support; troubleshooting
- Hide Balloons command (Guide menu) 28
- Hide Others command (Application menu) 40
- “Huh?” button (Macintosh Guide window) 27

I, J

- icons. *See also* buttons
 - appearing incorrectly on screen 56
 - Apple HD SC Setup 67
 - Apple Restore 47
 - bomb 51, 58
 - clicking 14
 - defined 14
 - dimmed 39
 - disk with blinking question mark 10, 54, 73
 - Disk First Aid 68
 - disk with X in center 55

- Finder 39
- hard disk 10, 14, 56
- Internal HD Format 72
- opening, shortcut for 14
- question mark, as Guide menu indicator 14, 17
- “sad Macintosh” 55
- Trash 14
- identifying objects on screen 28
- Index button 23–24
- information sources 17
- initializing DOS disks 57
- initializing external hard disk 70–71
- initializing floppy disks 57
- initializing internal hard disk 70, 72
- insertion point (I)
 - moving with Return key 102
 - moving with Tab key 102
 - setting with pointer 60
- installing additional memory 36
- installing Apple PlainTalk Microphone 33
- installing application programs 37, 38
- installing expansion cards
 - communication 95–96
 - Ethernet 95–96
 - other 90
 - processor-direct slot (PDS) 94–95
 - and warranty caution 90
- installing internal modem. *See* modem, internal
- installing monitor 3–5
- installing mouse and keyboard
 - with built-in cable 6
 - with separate cable 7
- installing stereo speakers 34–35
- installing system software 73–74
- Internal HD Format program 66–67, 72

K

- keyboard
 - handling guidelines 82
 - installing, with built-in cable 6
 - installing, with separate cable 7
 - Power key on 9
 - shortcuts with 29–30
 - troubleshooting 60
 - turning off computer from 15
- keyboard cable 6
 - checking 60
- Key Caps program 103–104
- keys, special 101–102

L

- laserdisc player, expansion card for. *See* video input card
- Launcher 10
 - Apple Backup button 42, 44
 - Apple Restore button 47
 - Applications button 41, 43
 - Internal HD Format button 66, 72
 - Performa Tutorial button 13
- light, power-on 11, 31
- locking disks 43
- locking mouse 87
- logic board, reset button on 97
- Look For button (Macintosh Guide window) 21, 25–26

M

- Macintosh basics 13–14
- Macintosh desktop 10
- Macintosh Guide window 20–27
 - appearance of 20
 - closing 27
 - “Huh?” button in 27
 - Index button in 23–24
 - Look For button in 21, 25–26
 - moving 27
 - moving to next step in 22
 - opening 20
 - returning to 22
 - searching for general subjects in 21–22
 - searching for specific subjects in 21, 23–24
 - searching for words or phrases in 21, 25–26
 - shrinking and expanding 27
 - tips for using 27
 - Topics button in 21–22
- Macintosh Performa CD 40. See also*
 - CD-ROM drive
 - Apple HD SC Setup program 67–68, 70–71
 - Apple Restore program 46
 - Disk First Aid program 68–69
 - Internal HD Format program 66–67, 72
 - starting up from 64–66
- Macintosh Shortcuts window 29
- mail, electronic 37
- maintenance
 - cleaning equipment 85–86
 - equipment-handling guidelines 81–84
 - keyboard 82
 - power supply 84
- mathematical symbols 102
- memory
 - adding 36
 - insufficient 61
 - virtual 61
- Memory control panel 61
- menu bar 14
- menu commands. *See* commands
- microphone
 - connecting 33
 - sound input port for 32
- modem, external, port for 32
- modem, internal 91–93, 95–99
 - expansion slot for 90
 - installing 95–96
 - opening computer for 91–93
 - and warranty caution 90
- monitor 31. *See also* screen display
 - cleaning 85
 - handling guidelines 82
 - installing 3–5
 - positioning 78
 - troubleshooting 11, 53
 - turning on 9
 - using more than one 53
- monitor cable 5
 - checking 53
- monitor port 5, 32
- mouse
 - cleaning 85–86
 - holding 13
 - installing 6, 7
 - locking 87
 - moving 13–14
 - moving arrow with 13–14
 - position of 13
 - shortcuts with 29–30
 - troubleshooting 13–14, 58–59
 - unlocking 88
- mouse button 13
- mouse cable 6, 7
 - checking 59

mouse pad 13
moving arrow on screen 13–14
moving insertion point with keys 102
moving Macintosh Guide window 27
moving mouse 13–14
musculoskeletal discomfort 76

N

networking card.
 See communication card
numeric keys 102

O

office arrangement guidelines 77–78
on/off switch (standby power button)
 2, 16
open application, identifying 39
Open/Close button (CD-ROM drive) 31
opening an application 14, 39
 problems with 61, 62
opening computer 91–93
opening DOS documents, problems with
 62–63
opening icons 14
 shortcut for 29
open windows, showing 39
Option key 102

P

PC Exchange control panel 62
PDS expansion card. *See* processor-direct
 slot (PDS) expansion card
Performa Tutorial, starting 13–14
PlainTalk Microphone. *See* Apple
 PlainTalk Microphone
plugging in computer 1–2, 53
 and safety concerns 80, 81

pointer
 “frozen” 58–59
 moving 13–14
 setting insertion point with 60
ports 32
 Apple Desktop Bus (ADB) 6, 7, 60
 monitor 5
power button, standby (on/off switch)
 2, 16
power cord
 for computer 2
 for monitor 3–4
 and safety concerns 80, 81
Power key 9, 102
 in restart procedure 51
power-on light 11, 31
power problems, troubleshooting 11, 53
power supply caution 84
PowerTalk program 37
printer port 32
problem solving. *See* Balloon Help;
 Guide menu; Macintosh Guide
 window; service and support;
 troubleshooting
processor-direct slot (PDS) expansion
 card 91–95, 97–99
 access cover for 32
 installing 94–95
 opening computer for 91–95
 slot for 90
 and warranty caution 90
programs. *See* application programs

Q

question mark disk icon 10, 54, 73
question mark icon, as Guide menu
 indicator 14, 17
questions. *See* Balloon Help; Guide
 menu; Macintosh Guide
 window; service and support;
 troubleshooting
QuickDraw GX program 37
quitting applications when system freezes
 51, 58, 104

R

- radio and television interference vi
- random-access memory (RAM)
 - adding 36
 - required for QuickDraw GX and PowerTalk programs 37
- rebuilding desktop 52
 - when application can't be found 62
 - when icons don't appear correctly 56
- reinstalling system software 73–74
- remote control sensor 31
- repair. *See* service and support
- repairing disks 63–69
- repetitive stress injuries (RSIs) 75, 76
- reset button (logic board) 97
- Restart command (Special menu) 51
- restarting Macintosh
 - to solve problems 51, 104
 - to turn off system extensions 58
- restoring information on hard disk 46–48
- Return key 102
- RSIs (repetitive stress injuries) 75, 76

S

- “sad Macintosh” icon 55
- safety instructions 80. *See also*
 - health concerns
 - grounding plug 2, 81
 - power supply 84
- screen display 56. *See also* monitor
 - dark 11, 53
 - frozen 51, 58–59
 - icons appearing incorrectly on 56
 - identifying objects on 28
 - at startup 10
 - typing produces nothing on 60
- screen saver programs 53, 82
- scroll arrows 14
- SCSI devices
 - ID numbers on 63–64, 67
 - terminating chain of 64
 - troubleshooting 54, 56, 63–64

- SCSI port 32
- security lock port 32
- service and support
 - adding memory 36
 - for hard disk initialization failure 71, 72
 - installing expansion card 90
 - sources of 17
 - startup problems 55
- setting up computer 1–8
- Shift key 102
 - using to turn off extensions 58
- Shortcuts command (Guide menu) 29–30
- shortcuts, keyboard and mouse 29–30
- Show All command (Application menu) 40
- Show Balloons command (Guide menu) 28
- Shut Down command (Special menu) 15
- size box 14
- slider, in Macintosh Guide window 23
- slots, expansion, in computer 90
- Small Computer System Interface. *See* SCSI devices; SCSI port
- socket, power cord
 - for computer 2
 - for monitor 4
- software. *See* application programs; system software
- sound input/output ports 32
- sound (volume) buttons 31, 35
- speakers, stereo
 - installing 34–35
 - port for (sound output port) 32
- special characters 103–104
- special keys 101–102
- Special menu
 - Empty Trash command 14
 - Restart command 51
 - Shut Down command 15
- spills, cleaning 80, 81, 82
- standby power button (on/off switch) 2, 16

- starting up 9–10. *See also* restarting
 - Macintosh
 - from CD-ROM drive 47, 64–66
 - from device other than internal hard disk 47
 - from floppy disk 66
 - troubleshooting 11, 53–56
- startup disk
 - purpose of 73
 - restarting computer with 51
 - troubleshooting 54, 55, 58, 60
- Startup Disk control panel 65
- startup tone 2
- stereo headphone jack 31
- stereo miniplug 34
- stereo speakers
 - installing 34–35
 - port for (sound output port) 32
- support. *See* service and support
- switching between programs 14, 39
- system extensions. *See* extensions
- System Folder
 - backing up 44
 - disk copy warning 38
 - do not open files in 62
 - printing contents of 50
 - restoring to hard disk 46–48
- system software
 - backing up 40–45
 - compatibility problems with 58, 60
 - installing 73–74
 - purpose of 73
 - reinstalling 73–74
- system startup. *See* starting up; startup disk

T

- Tab key 102
- television antenna, TV tuner expansion card for 32, 90
- television interference vi
- television, using as monitor 53
- terminating SCSI chain 64
- testing external hard disk 67–68
- testing internal hard disk 66–67
- text, failure to appear on screen 60
- tilde, typing 104
- title bar 14
- tone, computer startup 2
- Topics button (Macintosh Guide window) 21–22
- Trash icon 14
- troubleshooting 49–74. *See also* Guide menu; health concerns; safety instructions
 - ADB port problems 60
 - applications 38, 58–59, 60, 61, 62
 - “bomb” message 51, 58
 - cable connections 6–7
 - clock 53
 - common problems 53–63. *See also specific problems*
 - disk icon with blinking question mark 10, 54, 73
 - DOS documents 62–63
 - error messages 50
 - floppy disks 57, 68–69
 - floppy disks, ejecting 84
 - frozen system 51, 58–59
 - hard disk 56, 63–69
 - icons appearing incorrectly on screen 56
 - information sources 17
 - keyboard 60
 - memory 61
 - monitor 11, 53
 - mouse 13–14, 58–59
 - opening applications 61, 62



- pointer does not move 58–59
- power 11, 53
- rebuilding desktop 52, 56, 62
- repairing disks 63–69
- restarting Macintosh 51
- “sad Macintosh” icon 55
- screen display 11, 53
- SCSI devices 54, 56, 63–64
- starting applications 61, 62
- starting up 11, 53–56
- starting up from CD-ROM drive 65–66
- system extensions 56, 58, 59
- system software 58, 60, 73–74
- text entry problems 60
- turning off computer 15–16
 - for solving problems 51
- turning off extensions and control panels 58
- turning on computer 9–10
- turning on monitor 9
- tutorial, starting 13–14
- TV, application program for 37
- TV tuner expansion card 32, 90
- typing. *See also* keyboard
 - accented characters 104
 - capital letters 101, 102
 - diacritical marks 104
 - mathematical symbols 102
 - special characters 103–104
 - with special keys 101–102
- text, troubleshooting 60

U

- umlaut, typing 104
- unlocking floppy disks 45
- unlocking mouse 88
- unplugging computer, for solving problems 51
- updating backup copy 43–45

Utilities disk

- Apple HD SC Setup program 67–68, 70–71
- Apple Restore program 46
- Disk First Aid program 68–69
- Internal HD Format program 66–67, 72
- starting up from 66

V

- ventilation 81
- vertical plate on back of computer 90
- very low frequency (VLF) emissions 79
- video, application program for 37
- video camera, expansion card for. *See* video input card
- videocassette recorder (VCR), expansion card for. *See* video input card
- video equipment, expansion card for. *See* video input card
- video input card 32
 - installing 90
 - video-in expansion slot for 90
- virtual memory 61
- volume buttons 31, 35

W

- warranty concerns, and expansion card 90
- windows 14
 - bringing to front 14
 - hiding or showing on desktop 40
 - moving Macintosh Guide window 27

X, Y, Z

- X in disk icon 55

The Apple Publishing System

This Apple manual was written, edited, and produced on a desktop publishing system using Apple Macintosh computers and QuarkXPress. Technical illustrations were drawn in Adobe™ Illustrator; screen shots were created and modified with system software, ExposurePro, Aldus SuperPaint, and Adobe Photoshop. Proof pages were created on Apple LaserWriter printers and on QMS and Tektronix color printers. Final pages were output directly to separated film on a PostScript™-driven imagesetter.

Text type is Times®, display type is Helvetica® Narrow, and cover type is Apple Garamond, Apple's corporate font. Ornaments are custom symbols designed for Apple Computer.

PostScript, the LaserWriter page-description language, was developed by Adobe Systems Incorporated.