



ATTO Technology, Inc.

---

# **ATTO FastFrame Network Interface Adapter Installation and Operation Manual**

**FastFrame NS14**

**10GbE Quad Port PCIe 2.0 Network Interface Adapter**

**FastFrame NS12**

**10GbE Dual Port PCIe 2.0 Network Interface Adapter**

**FastFrame NS11**

**10GbE Single Port PCIe 2.0 Network Interface Adapter**

**FastFrame NT12**

**10GBASE-T Dual Port PCIe 2.0 Network Interface Adapter**

**FastFrame NT11**

**10GBASE-T Single Port PCIe 2.0 Network Interface Adapter**

## **ATTO Technology, Inc.**

155 CrossPoint Parkway  
Amherst, New York 14068 USA  
[www.attotech.com](http://www.attotech.com)

Tel (716) 691-1999  
Fax (716) 691-9353

Sales support: [sls@attotech.com](mailto:sls@attotech.com)  
Technical support: Monday -- Friday, 8am-6pm EST  
[techsupp@attotech.com](mailto:techsupp@attotech.com)  
(716) 691-1999 ext. 242

© 2013 ATTO Technology, Inc. All rights reserved. All brand or product names are trademarks of their respective holders. No part of this manual may be reproduced in any form or by any means without the express written permission of ATTO Technology, Inc.

# Contents

---

|   |             |
|---|-------------|
| <b>1 ATTO FastFrame NIC Features &amp; Overview .....</b> | <b>1</b>    |
| Getting started   |             |
| FastFrame NS14 Adapter                                    |             |
| FastFrame NS12 Adapter                                    |             |
| FastFrame NS11 Adapter                                    |             |
| FastFrame NT12 Adapter                                    |             |
| FastFrame NT11 Adapter                                    |             |
| <b>2 Driver Installation .....</b>                        | <b>8</b>    |
| <b>3 Hardware Installation .....</b>                      | <b>10</b>   |
| <b>4 FastFrame Link Aggregation .....</b>                 | <b>16</b>   |
| <b>5 Troubleshooting .....</b>                            | <b>20</b>   |
| General suggestions                                       |             |
| Windows   |             |
| Linux   |             |
| Mac OS X  |             |
| <b>Appendix A Glossary .....</b>                          | <b>i</b>    |
| <b>Appendix B Accessories .....</b>                       | <b>iii</b>  |
| <b>Appendix C ATTO Adapter Selection Guides .....</b>     | <b>iv</b>   |
| <b>Appendix D Standards, Compliances .....</b>            | <b>viii</b> |
| FCC standards: radio and television interference          |             |
| Compliances   |             |
| <b>Appendix E Safety, Warranty .....</b>                  | <b>xi</b>   |
| Safety  |             |
| ATTO Technology, Inc. limited warranty                    |             |

# 1 ATTO FastFrame NIC Features & Overview

*FastFrame 10Gb Ethernet NICs provide flexible and scalable LAN connectivity.*

Built on industry-leading Intel® silicon for universal usability, ATTO FastFrame NICs lead in high performance I/O connectivity for Mac OS X environments while offering broad support for Windows and Linux server and workstation operating systems. They provide reliable, inexpensive, fast network access to block storage via iSCSI, with lossless Ethernet (CEE) and Data Center Bridging (DCB) for improved iSCSI quality of service. ATTO FastFrame NICs comprise a full range of products for flexible design—single, dual, and quad-port configurations, as well as support for Direct Attach Copper.

New to the FastFrame family, ATTO FastFrame 10GBASE-T NICs operate with existing structured shielded or unshielded twisted pair copper cabling familiar to network professionals.

Strong reseller & OEM programs plus exceptional support provided by ATTO make the FastFrame line of NICs the choice for system builders seeking a lasting footprint in storage-intensive and data center markets.

- Extensively tested and optimized by ATTO for high-performance in Media & Entertainment applications, as well as applications with similar profiles such as medical imaging, and oil & gas
- 10GbE cards, ports & cabling are backwards compatible to Gig-E for staged upgrades or future-proofing— and you can run 10GBASE-T NICs with Cat6a cabling that's already in place
- 30% lower power rating means lower energy costs, lower data center maintenance fees, and less heat to dissipate

## Getting started

In general, to install the ATTO Network Interface Adapter, you must:

- 1 Ensure you have the equipment and software you need for the installation:
  - FastFrame NIC
  - ATTO FastFrame NIC CD including drivers, user manuals and utilities (Installation CD)
  - A computer with an available expansion slot



### Note

*Install your FastFrame NIC into a PCIe 2.0 x8 expansion slot for best performance*

- Cables  
<http://www.attotech.com/products/cable-finder/>

- 2 Install drivers for your operating system. Refer to [Driver Installation](#) on page 8.
- 3 Install the configuration software, the ATTO ConfigTool, found on the Installation CD. For more information on how to use the ATTO ConfigTool, refer to the ATTO Utilities Installation and Operation Manual.
- 4 Install the FastFrame Adapter. Refer to [Hardware Installation](#) on page 10.
- 5 Attach your NIC to a switch or server using an ATTO recommended cable:
  - Optical (NS14, NS12, NS11)*
    - CBL-LCLC-R03 (3 Meter)
    - CBL-LCLC-R10 (10 Meter)
  - 10GBASE-T (NT12, NT11)*
    - CAT6a

# FastFrame NS14 Adapter

FastFrame's comprehensive, easy-to-understand portfolio includes single-, dual-, and quad-port adapters with included high-quality SFP+ connectors - a hidden cost with some competitor cards - and support for direct attach copper cables. Quad-port adapters conserve PCI slots for more flexible system design. FastFrame™ draws up to 60% less power than competing solutions. A lower power rating means lower energy costs, lower data center maintenance fees, and fewer worries about heat dissipation. In addition to wide support for Windows and Linux server and desktop operating systems, ATTO leads in high performance I/O connectivity for Mac OS X environments.



## Technical specifications

- Simultaneously supports multiple networking and storage protocols: TCP/IP, iSCSI
- Supports Data Center Bridging; Priority-based Flow Control (PFC), Enhanced Transmission Selection (ETS) and DCB Exchange (DCBX) protocol
- Up to 10Gb/s throughput per port
- High-performance x8 PCIe 2.0 bus

## Ethernet features

- Data rate per port: 10Gb/s
- Jumbo frame support up to 9,000 bytes
- Tx/Rx IP, TCP & UDP checksum offloading (IPv4, IPv6) capabilities, Transmission control protocol (TCP), User datagram protocol (UDP), Internet protocol (IP)
- Large send offloads (LSO)

## Host bus specifications

- x8 mechanical and x8 electrical PCI Express interconnect
- Conforms to PCI Express Base Spec 2.0
- Conforms to PCI Express CEM Spec 2.0
- PCI Hot Plug spec 1.0

## Environmental & physical specifications

- Length: 6.52 inches
- Height: 4.375 inches
- Operating temperature: 0 to 55 °C (32 to 131 °F)
- Storage temperature: -40 to 70 °C (-40 to 158 °F)
- Relative humidity: 10 to 90% non-condensing
- 15.7 W (typical)
- 100 lf/m (minimum) airflow recommended
- RoHS compliant

## External connectivity

- Easy to install full height connection bracket
- External LEDs for on-line and speed status for each port
- Four pluggable optical LC SFP+ modules included

## Software specifications

- Microsoft Windows Vista®, 7®, 8®
- Microsoft Windows Server® 2008, 2008 R2, 2012
- Mac OS® X 10.6, 10.7, 10.8
- Red Hat Enterprise Linux® 5.x, 6.x
- SUSE Linux Enterprise® Server 10, 11, 11 SP1
- openSUSE™ 11.3, 11.4
- CentOS 6

# FastFrame NS12 Adapter

FastFrame's comprehensive, easy-to-understand portfolio includes single-, dual-, and quad-port adapters with included high-quality SFP+ connectors - a hidden cost with some competitor cards - and support for direct attach copper cables. FastFrame™ draws up to 60% less power than competing solutions. A lower power rating means lower energy costs, lower data center maintenance fees, and fewer worries about heat dissipation. In addition to wide support for Windows and Linux server and desktop operating systems, ATTO leads in high performance I/O connectivity for Mac OS X environments.

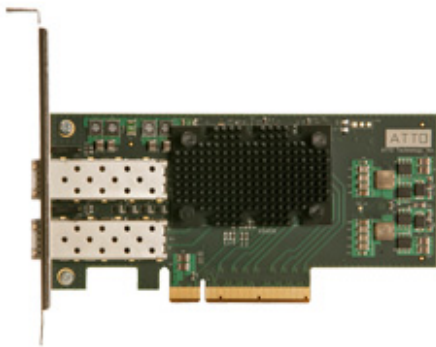

## Technical specifications

- Simultaneously supports multiple networking and storage protocols: TCP/IP, iSCSI
- Supports Data Center Bridging; Priority-based Flow Control (PFC), Enhanced Transmission Selection (ETS) and DCB Exchange (DCBX) protocol
- Up to 10Gb/s throughput per port
- High-performance x8 PCIe 2.0 bus

## Ethernet features

- Data rate per port: 10Gb/s
- Jumbo frame support up to 9,000 bytes
- Tx/Rx IP, TCP & UDP checksum offloading (IPv4, IPv6) capabilities, Transmission control protocol (TCP), User datagram protocol (UDP), Internet protocol (IP)
- Large send offloads (LSO)

## Host bus specifications

- x8 mechanical and x8 electrical PCI Express interconnect
- Conforms to PCI Express Base Spec 2.0
- Conforms to PCI Express CEM Spec 2.0
- PCI Hot Plug spec 1.0

## Environmental & physical specifications

- Length: 5.6 inches
- Height: 2.71 inches
- Operating temperature: 0 to 55 °C (32 to 131 °F)
- Storage temperature: -40 to 70 °C (-40 to 158 °F)
- Relative humidity: 10 to 90% non-condensing
- 5.9 W (typical)
- 100 lf/m (minimum) airflow recommended
- RoHS compliant

## External connectivity

- Easy to install full height connection bracket; low-profile bracket included in finished goods packaging
- External LEDs for on-line and speed status for each port
- Two pluggable optical LC SFP+ modules included

## Software specifications

- Microsoft Windows Vista®, 7®, 8®
- Microsoft Windows Server® 2008, 2008 R2, 2012
- Mac OS® X 10.6, 10.7, 10.8
- Red Hat Enterprise Linux® 5.x, 6.x
- SUSE Linux Enterprise® Server 10, 11, 11 SP1
- openSUSE™ 11.3, 11.4
- CentOS 6

# FastFrame NS11 Adapter

FastFrame's comprehensive, easy-to-understand portfolio includes single-, dual-, and quad-port adapters with included high-quality SFP+ connectors - a hidden cost with some competitor cards - and support for direct attach copper cables. FastFrame™ draws up to 60% less power than competing solutions. A lower power rating means lower energy costs, lower data center maintenance fees, and fewer worries about heat dissipation. In addition to wide support for Windows and Linux server and desktop operating systems, ATTO leads in high performance I/O connectivity for Mac OS X environments.

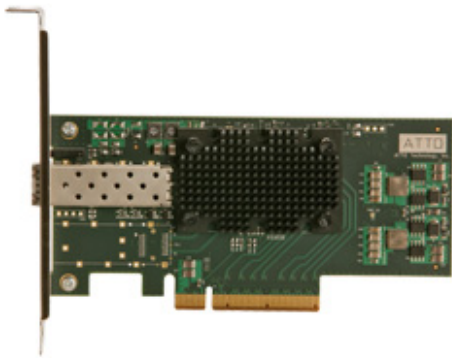

## Technical specifications

- Simultaneously supports multiple networking and storage protocols: TCP/IP, iSCSI
- Supports Data Center Bridging; Priority-based Flow Control (PFC), Enhanced Transmission Selection (ETS) and DCB Exchange (DCBX) protocol
- Up to 10Gb/s throughput per port
- High-performance x8 PCIe 2.0 bus

## Ethernet features

- Data rate per port: 10Gb/s
- Jumbo frame support up to 9,000 bytes
- Tx/Rx IP, TCP & UDP checksum offloading (IPv4, IPv6) capabilities, Transmission control protocol (TCP), User datagram protocol (UDP), Internet protocol (IP)
- Large send offloads (LSO)

## Host bus specifications

- x8 mechanical and x8 electrical PCI Express interconnect
- Conforms to PCI Express Base Spec 2.0
- Conforms to PCI Express CEM Spec 2.0
- PCI Hot Plug spec 1.0

## Environmental & physical specifications

- Length: 5.6 inches
- Height: 2.71 inches
- Operating temperature: 0 to 55 °C (32 to 131 °F)
- Storage temperature: -40 to 70 °C (-40 to 158 °F)
- Relative humidity: 10 to 90% non-condensing
- 4.7 W (typical)
- 100 lf/m (minimum) airflow recommended
- RoHS compliant

## External connectivity

- Easy to install full height connection bracket; low-profile bracket included in finished goods packaging
- External LEDs for on-line and speed status for each port
- Pluggable optical LC SFP+ module included

## Software specifications

- Microsoft Windows Vista®, 7®, 8®
- Microsoft Windows Server® 2008, 2008 R2, 2012
- Mac OS® X 10.6, 10.7, 10.8
- Red Hat Enterprise Linux® 5.x, 6.x
- SUSE Linux Enterprise® Server 10, 11, 11 SP1
- openSUSE™ 11.3, 11.4
- CentOS 6

# FastFrame NT12 Adapter

Built on industry-leading Intel® silicon for universal usability, ATTO FastFrame NICs lead in high performance I/O connectivity for Mac OS X environments while offering broad support for Windows and Linux server and workstation operating systems. They provide reliable, inexpensive, fast network access to block storage via iSCSI, with lossless Ethernet (CEE) and Data Center Bridging (DCB) for improved iSCSI quality of service. New to the FastFrame family, ATTO FastFrame 10GBASE-T NICs operate with existing structured shielded or unshielded twisted pair copper cabling familiar to network professionals. 10GbE cards, ports & cabling are backwards compatible to Gig-E for staged upgrades or future-proofing— and you can run 10GBASE-T NICs with Cat6a cabling that's already in place.

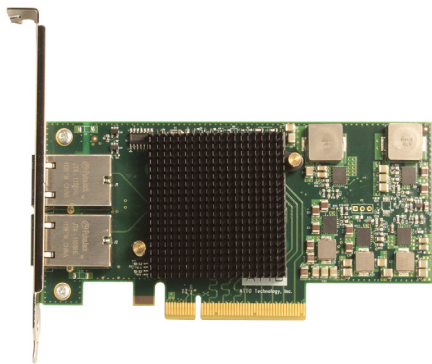

## Technical specifications

- Intel X540 10GBASE-T Ethernet Controller
- Simultaneously supports multiple networking and storage protocols: TCP/IP, iSCSI
- Supports Data Center Bridging; Priority-based Flow Control (PFC), Enhanced Transmission Selection (ETS) and DCB Exchange (DCBX) protocol
- Up to 10Gb/s throughput per port
- High-performance x8 PCIe 2.0 bus

## Ethernet features

- Data rate per port: 10Gb/s, 1Gb/s, 100Mb/s
- Jumbo frame support up to 9,000 bytes
- Tx/Rx IP, TCP & UDP checksum offloading (IPv4, IPv6) capabilities, Transmission control protocol (TCP), User datagram protocol (UDP), Internet protocol (IP)
- Large send offloads (LSO)

## Host bus specifications

- x8 mechanical and x8 electrical PCI Express 2.0 interconnect
- Backward compatible with PCI Express 1.1
- Supports PCI Express Base Spec 2.0
- Supports PCI Express CEM Spec 2.0

## Environmental & physical specifications

- Length: 5.6 inches
- Height: 2.71 inches
- Operating temperature: 0 to 55 °C (32 to 131 °F)
- Storage temperature: -40 to 70 °C (-40 to 158 °F)
- Relative humidity: 10 to 90% non-condensing
- 13.6W (typical), 16.0W (max)
- 200 lf/m (minimum) airflow recommended
- RoHS compliant

## External connectivity

- Easy to install full height connection bracket; low-profile bracket included in finished goods packaging
- External LEDs for link speed and activity for each port
- Compatible with CAT-7, CAT-6a, and CAT-6 Ethernet cables for 10GBASE-T connections and CAT-5e for 1000BASE-T and 100BASE-TX connections

## Software specifications

- Microsoft Windows Vista®, 7®, 8®
- Microsoft Windows Server® 2008, 2008 R2, 2012
- Mac OS® X 10.6, 10.7, 10.8
- Red Hat Enterprise Linux® 5.x, 6.x
- SUSE Linux Enterprise® Server 10, 11, 11 SP1
- openSUSE™ 11.3, 11.4
- CentOS 6



# FastFrame NT11 Adapter

Built on industry-leading Intel® silicon for universal usability, ATTO FastFrame NICs lead in high performance I/O connectivity for Mac OS X environments while offering broad support for Windows and Linux server and workstation operating systems. They provide reliable, inexpensive, fast network access to block storage via iSCSI, with lossless Ethernet (CEE) and Data Center Bridging (DCB) for improved iSCSI quality of service. New to the FastFrame family, ATTO FastFrame 10GBASE-T NICs operate with existing structured shielded or unshielded twisted pair copper cabling familiar to network professionals. 10GbE cards, ports & cabling are backwards compatible to Gig-E for staged upgrades or future-proofing— and you can run 10GBASE-T NICs with Cat6a cabling that's already in place.

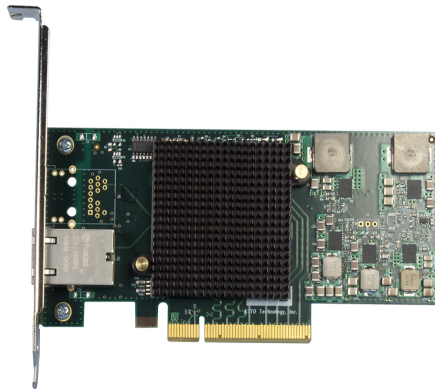

## Technical specifications

- Intel X540 10GBASE-T Ethernet Controller
- Simultaneously supports multiple networking and storage protocols: TCP/IP, iSCSI
- Supports Data Center Bridging; Priority-based Flow Control (PFC), Enhanced Transmission Selection (ETS) and DCB Exchange (DCBX) protocol
- Up to 10Gb/s throughput per port
- High-performance x8 PCIe 2.0 bus

## Ethernet features

- Data rate per port: 10Gb/s, 1Gb/s, 100Mb/s
- Jumbo frame support up to 9,000 bytes
- Tx/Rx IP, TCP & UDP checksum offloading (IPv4, IPv6) capabilities, Transmission control protocol (TCP), User datagram protocol (UDP), Internet protocol (IP)
- Large send offloads (LSO)

## Host bus specifications

- x8 mechanical and x8 electrical PCI Express 2.0 interconnect
- Backward compatible with PCI Express 1.1
- Supports PCI Express Base Spec 2.0
- Supports PCI Express CEM Spec 2.0

## Environmental & physical specifications

- Length: 5.6 inches
- Height: 2.71 inches
- Operating temperature: 0 to 55 °C (32 to 131 °F)
- Storage temperature: -40 to 70 °C (-40 to 158 °F)
- Relative humidity: 10 to 90% non-condensing
- 13.6W (typical), 16.0W (max)
- 200 lf/m (minimum) airflow recommended
- RoHS compliant

## External connectivity

- Easy to install full height connection bracket; low-profile bracket included in finished goods packaging
- External LEDs for link speed and activity for each port
- Compatible with CAT-7, CAT-6a, and CAT-6 Ethernet cables for 10GBASE-T connections and CAT-5e for 1000BASE-T and 100BASE-TX connections

## Software specifications

- Microsoft Windows Vista®, 7®, 8®
- Microsoft Windows Server® 2008, 2008 R2, 2012
- Mac OS® X 10.6, 10.7, 10.8
- Red Hat Enterprise Linux® 5.x, 6.x
- SUSE Linux Enterprise® Server 10, 11, 11 SP1
- openSUSE™ 11.3, 11.4
- CentOS 6

## Selection guide: FastFrame adapters

| Product Features                          | FFRM-NS14       | FFRM-NS12       | FFRM-NS11       | FFRM-NT12       | FFRM-NT11       |
|---|-----------------|-----------------|-----------------|-----------------|-----------------|
| Ports                                     | 4               | 2               | 1               | 2               | 1               |
| Maximum Transfer Rate (Full Duplex)       | 8GB/s           | 5GB/s           | 2.5GB/s         | 5GB/s           | 2.5GB/s         |
| Bus type                                  | PCIe 2.0        | PCIe 2.0        | PCIe 2.0        | PCIe 2.0        | PCIe 2.0        |
| Bus characteristics                       | 8 lane          | 8 lane          | 8 lane          | 8 lane          | 8 lane          |
| Optical/Copper interface                  | SFP+LC          | SFP+LC          | SFP+ LC         | RJ45            | RJ45            |
| Maximum cable length                      | See Chart Below | See Chart Below | See Chart Below | See Chart Below | See Chart Below |
| Low profile form factor                   |                 | ✓               | ✓               | ✓               | ✓               |
| Advanced Data Streaming (ADS™) Technology | ✓               | ✓               | ✓               | ✓               | ✓               |
| Windows driver support                    | ✓               | ✓               | ✓               | ✓               | ✓               |
| Mac OS X driver support                   | ✓               | ✓               | ✓               | ✓               | ✓               |
| Linux driver support                      | ✓               | ✓               | ✓               | ✓               | ✓               |

Cable length varies by interface and cable type.

| Interface  | Cable type                          | Max Distance |
|------------|-------------------------------------|--------------|
| 10GBASE-SR | 62.5/125 μm multi-mode fiber (OM1)  | 26m          |
| 10GBASE-SR | 50/125 μm MMF (OM2)                 | 82m          |
| 10GBASE-SR | Laser optimized 50/125 μm MMF (OM3) | 300m         |
| 10GBASE-T  | CAT-7                               | 100m         |
| 10GBASE-T  | CAT-6a                              | 100m         |
| 10GBASE-T  | CAT-6                               | 55m          |
| 1000BASE-T | CAT-5e                              | 100m         |
| 100BASE-TX | CAT-5e                              | 100m         |

## 2 Driver Installation

Before installing your FastFrame adapter, you must configure your system to recognize it by installing drivers for your operating system.



### Note

*If you already have one or more FastFrame adapters installed and you are installing additional adapter(s), you do not need to perform any of these procedures unless you are updating a previously installed driver.*

The Installation CD automatically starts when inserted in the system CD-ROM drive. Navigate the easy-to-use HTML-based menu to find the driver for your adapter and operating system.

The FastFrame NIC Installation CD, referred to in these instructions, is the Installation CD that shipped with your adapter or a folder containing the latest downloaded and expanded driver. We strongly recommend downloading the latest drivers, available at <http://www.attotech.com/downloads.html>

### Windows



### Note

*Windows 8, 7, Vista, Server 2012 and 2008 may utilize a new User Account Control Feature. Because of this there may be additional confirmations that will need to be performed to properly install the driver. These confirmations normally consist of a dialog where the user has to give Windows permission to perform an action. If you do not have the correct privileges during this, you will be prompted for an actual user name and password. You may need to contact your system administrator if you do not have this information.*

- 1 Power on your system and log in as the administrator or a user with proper administrative privileges
- 2 Go to [www.attotech.com](http://www.attotech.com)
- 3 Click on **downloads**.
- 4 Register or log in if previously registered.
- 5 Click on **Ethernet Adapters** in the left dialog.
- 6 Navigate to your HBA model/family in the right dialog and click on it.

- 7 Scroll down to and click the desired driver depending on the operating system.
- 8 A download window appears. Choose **Save File**.
- 9 After the download has completed, process the downloaded file guide should appear.
- 10 Click on **Windows XX Driver** link based on the operating system in use. If you are unsure which version you are using, please contact your system administrator.
- 11 Click **Install Windows Driver XX** next to the appropriate item to initiate the driver setup program.
- 12 Follow the on-screen instructions to complete the driver installation.

### Linux



### Note

*These steps assume a basic knowledge of Linux terminal commands. You must also have the correct kernel header files for the appropriate kernel already installed.*

- 1 Power on your system and log in as the administrator or a user with proper administrative privileges
- 2 Go to [www.attotech.com](http://www.attotech.com)
- 3 Click on **downloads**.
- 4 Register or log in if previously registered.
- 5 Click on **Ethernet Adapters** in the left dialog.
- 6 Navigate to your HBA model/family in the right dialog and click on it.
- 7 Scroll down to and click the desired driver depending on the operating system.
- 8 A download window appears. Choose **Save File**.
- 9 After the download has completed, open the FastFrame volume on the desktop.
- 10 Open the **Linux** folder.
- 11 Open the **Drivers** folder.
- 12 Copy the .tgz file to a temporary folder.
- 13 Open a terminal window and change to the location of copied tgz from step 6.
- 14 Extract the file using the command **tar -xzf <filename.tgz>**.
- 15 Change to the directory created above then run the installer script **./install.sh**.

## Mac OS X

- 1 Power on your system and log in as the administrator or a user with proper administrative privileges
- 2 Go to [www.attotech.com](http://www.attotech.com)
- 3 Click on **downloads**.
- 4 Register or log in if previously registered.
- 5 Click on **Ethernet Adapters** in the left dialog.
- 6 Navigate to your HBA model/family in the right dialog and click on it.
- 7 Scroll down to and click the desired driver depending on the operating system.
- 8 A download window appears. Choose **Save File**.
- 9 After the download has completed, process the downloaded file guide should appear.
- 10 Open the folder corresponding to the OS X version in use.
- 11 Launch the installer package.
- 12 Follow the on-screen instructions.

# 3 Hardware Installation

Install the ATTO FastFrame Adapter and attach your devices to it using the instructions below.



### CAUTION

**Back up your system data before changing or installing any hardware.**

### System requirements

The FastFrame NIC package contains the following:

- FastFrame Network Interface Adapter
- ATTO Utilities CD
- SFP+ Modules (NS adapters only)

*If any of these items are missing, contact your ATTO authorized sales representative.*

To install and use the FastFrame NIC you will need:

- 1 A computer with an available PCI Express expansion slot



#### Note

*Install your FastFrame NIC into a PCIe 2.0 x8 expansion slot for best performance*

- 2 The complete FastFrame NIC package

### MAC address

FastFrame NICs are configured with a unique MAC address designated by the Institute of Electrical and Electronic Engineers. This address, stored in flash memory, allows the system to recognize the FastFrame NIC as a unique part of your configuration. The address is clearly marked on the back of the adapter.

The MAC address assigned to an adapter is assigned to the 1st port of the adapter. If the adapter has more than one port then the MAC address is incremented by 1 and assigned to the 2nd port, incremented by 2 and assigned to the 3rd port and incremented by 3 and assigned to the 4th port.

For example, for the NS1X series, the assignment will be as follows:

|                 |                               |
|-----------------|-------------------------------|
| MAC address     | 1st port of NS11, NS12 & NS14 |
| MAC address + 1 | 2nd port of NS12 & NS14       |
| MAC address + 2 | 3rd port of NS14              |
| MAC address + 3 | 4th port of NS14              |

### Installation



### CAUTION

**FastFrame NICs contain components that are sensitive to electrostatic discharge (ESD). ESD can cause damage to the FastFrame host adapter. Please follow standard methods to avoid ESD.**

For bracket installation, please see the bracket installation guide included in your NIC product package.

- 1 Install the latest drivers. Refer to [Driver Installation](#) on page 8.
- 2 Power down the computer and unplug the computer from all power sources.
- 3 Open the case.
- 4 Remove the cover bracket from the PCI Express slot (v1.0a or later).
- 5 Install the FastFrame NIC host adapter in any open PCI Express expansion slot. If you have questions about how to install an expansion card in your system, consult your computer's documentation.



#### Note

*The FastFrame adapters fit into x8 or x16 mechanical PCI Express slots.*

- 6 Repeat step 4 through 5 for each adapter you want to install.
- 7 Close the case on the computer and power it up.

## Bracket details

Exhibit 3-1 FFRM-NS14 Bracket

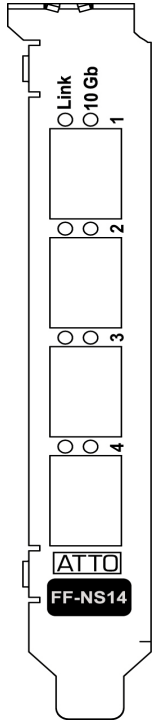

Exhibit 3-3 FFRM-NS11 Full & Low Profile Bracket

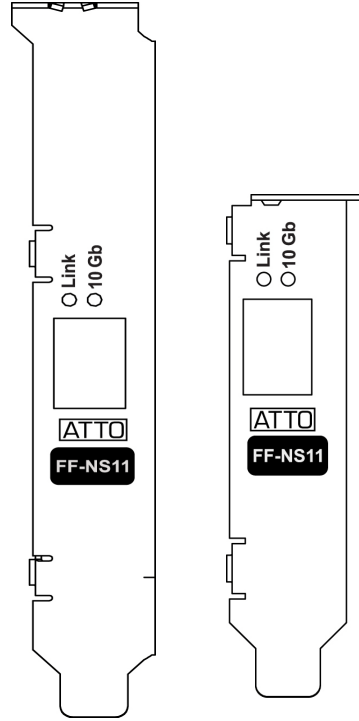

Exhibit 3-2 FFRM-NS12 Full & Low Profile Bracket

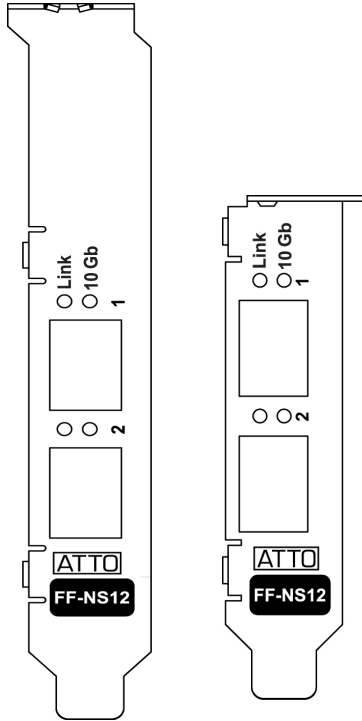

Exhibit 3-4 FFRM-NT12 Full & Low Profile Bracket

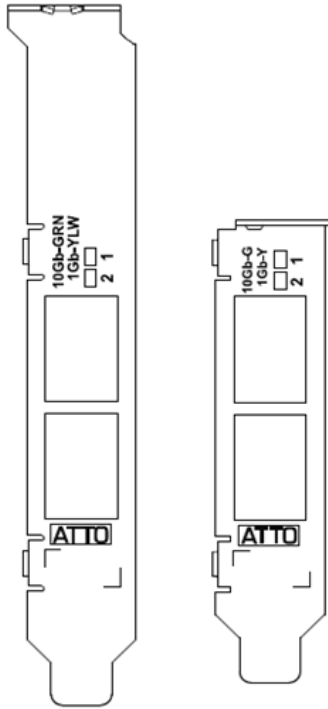
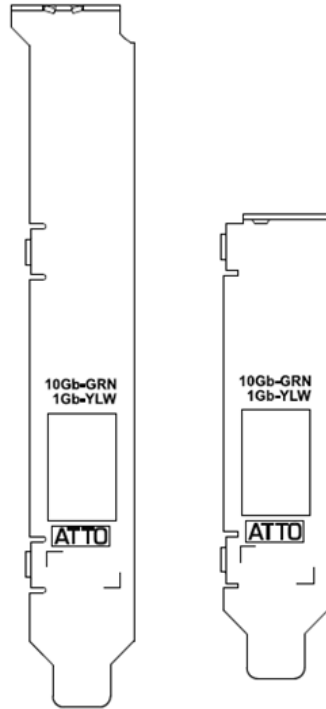

Exhibit 3-5 FFRM-NT11 Full & Low Profile Bracket



# Adapter board details

Exhibit 3-6 FFRM-NS14 board

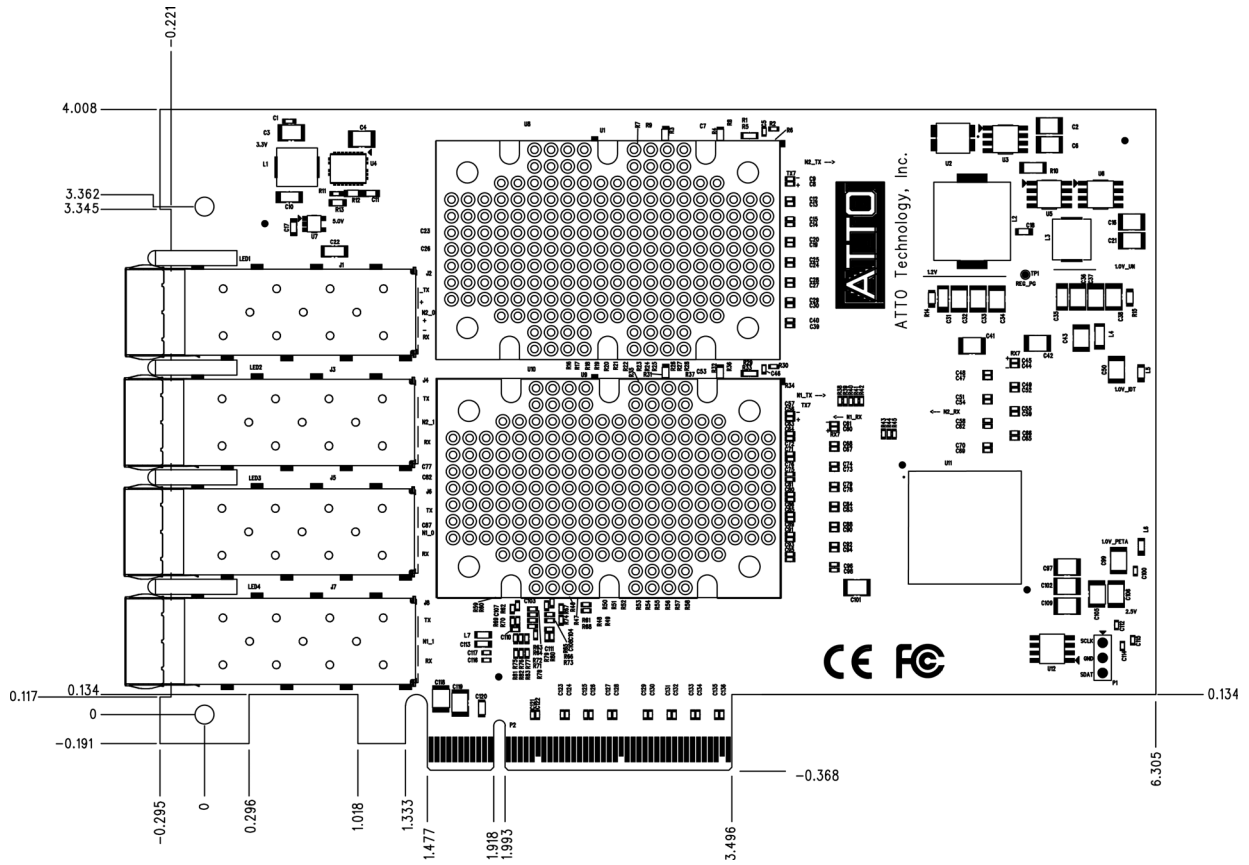

Exhibit 3-7 FFRM-NS12 board

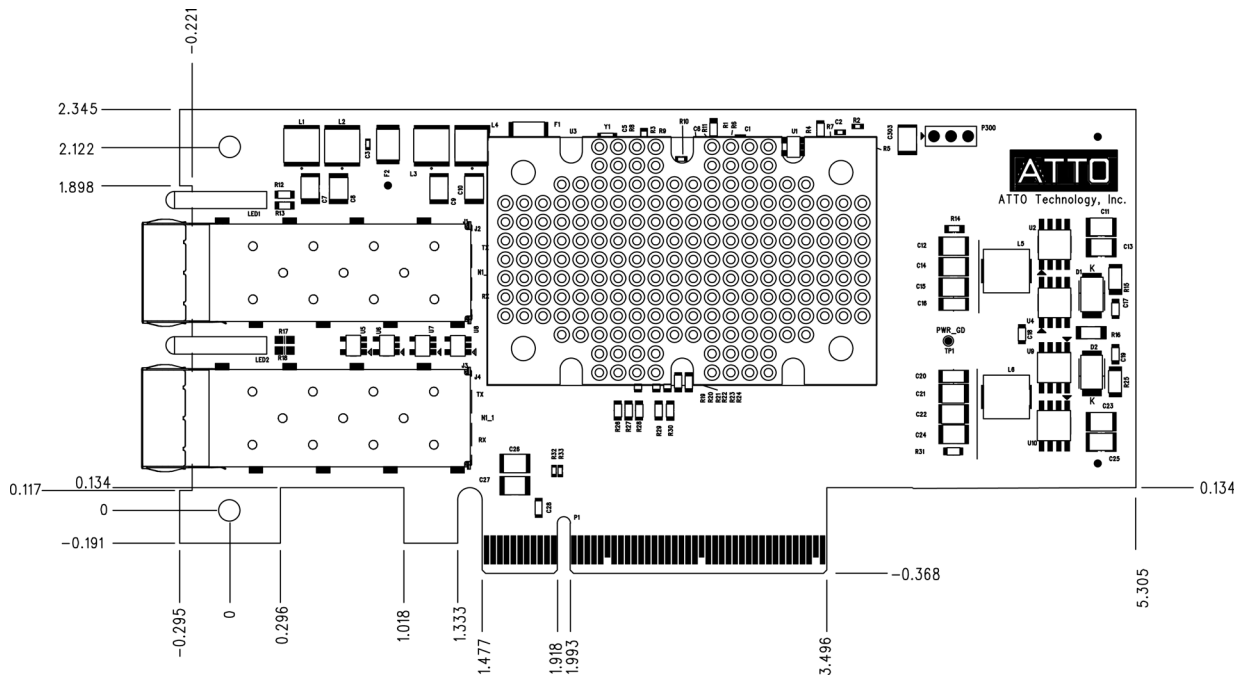



Exhibit 3-8 FFRM-NS11 board

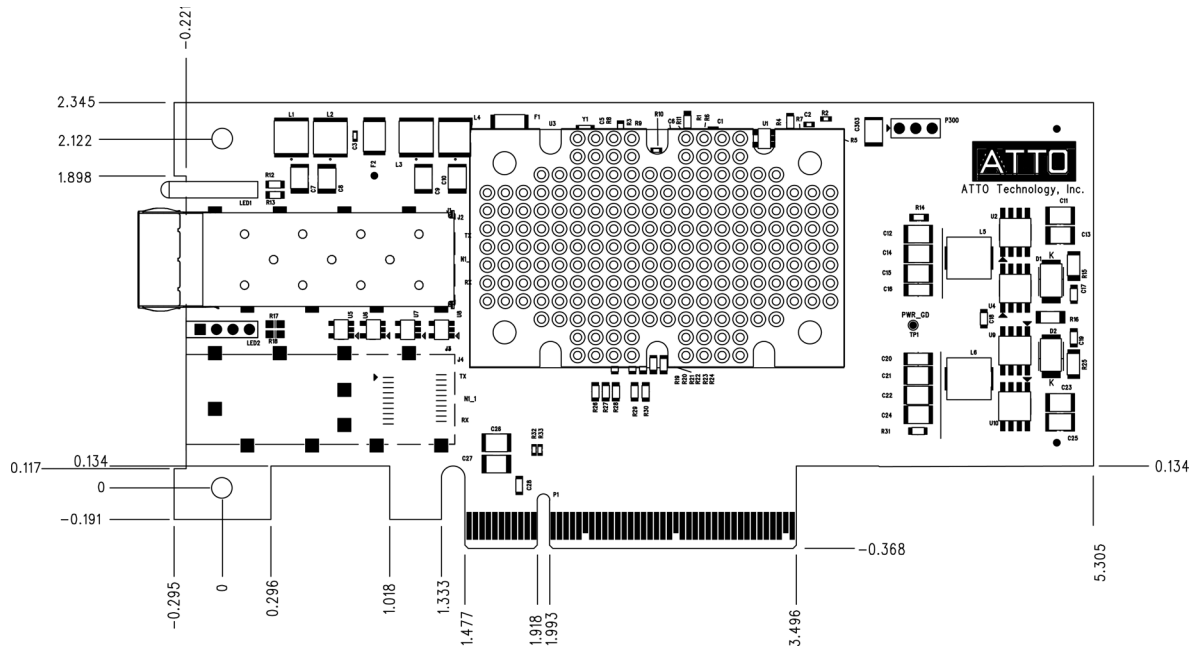

Exhibit 3-9 FFRM-NT12 board

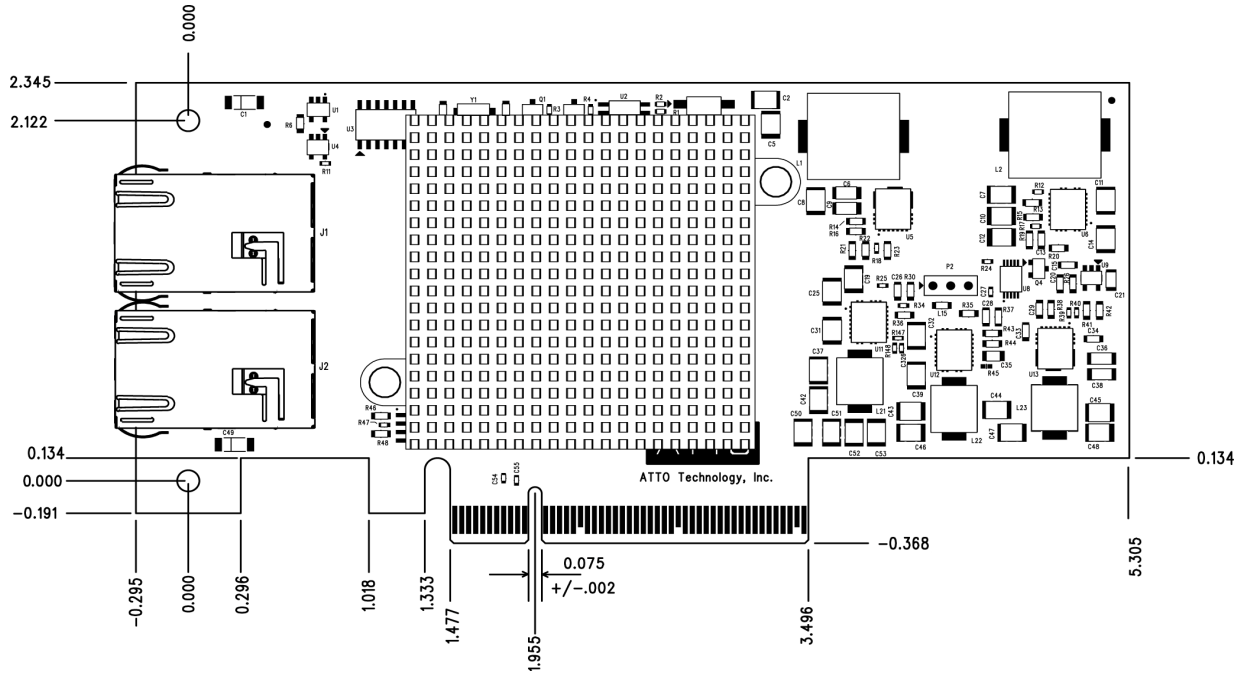
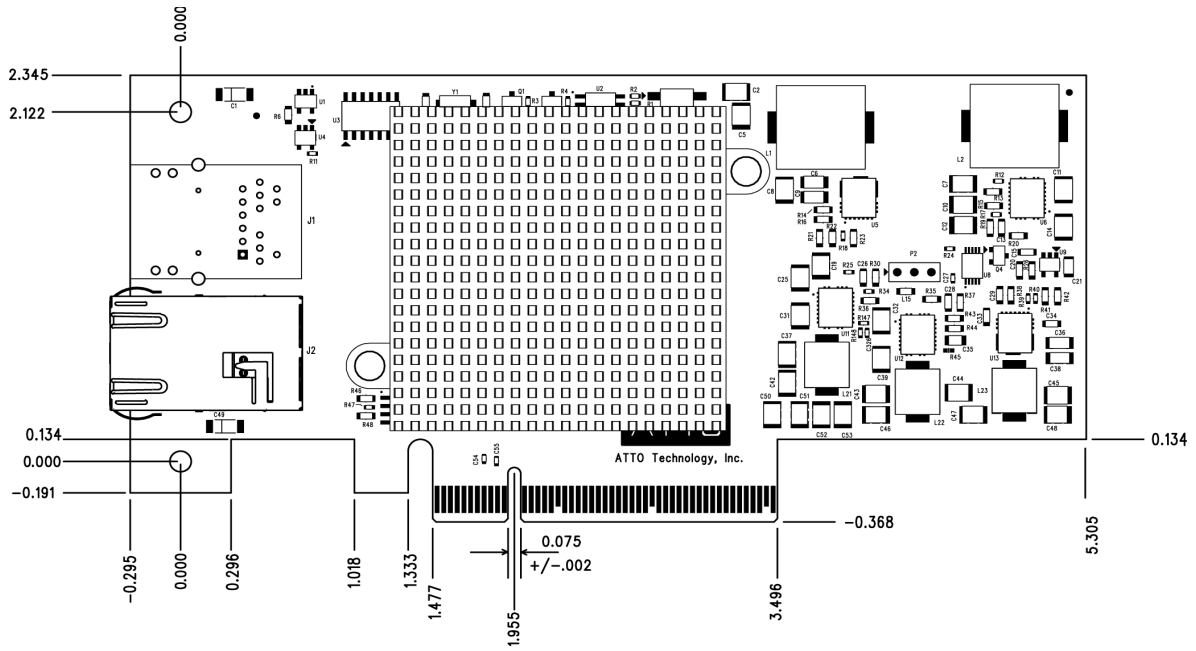

Exhibit 3-10 FFRM-NT11 board



## 4 FastFrame Link Aggregation

*FastFrame Link Aggregation allows multiple FastFrame 10GbE links to be combined into one logical link, for the purpose of increasing performance. This feature applies to Windows 8, 7, Vista, Server 2012, 2008 and 2008 R2 for all ATTO FastFrame models. Note: although FastFrame link aggregation does support Server 2012 it is recommended you use Teaming; Windows built-in link aggregation.*

### Installing FastFrame Link Aggregation

The FastFrame Link Aggregation driver consists of a Protocol driver and associated configuration components. It is installed on the system along with the FastFrame drivers. To use link aggregation, the protocol driver must be installed on the FastFrame Network Adapters.

- 1 Open the system's Network Connections control panel, as shown in 4-1:

*Exhibit 4-1 Windows Network Connection Control Panel*

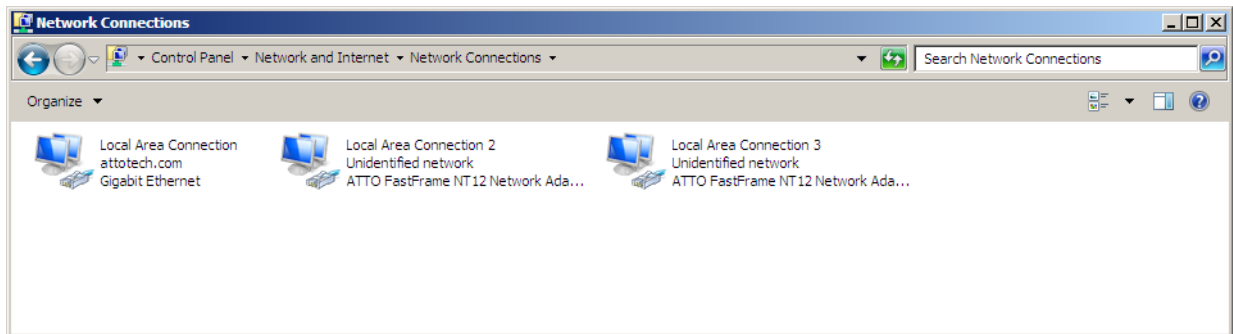

- 2 Right-click on an ATTO FastFrame Network Adapter connection and select **Properties** to open the Network Connection Properties page, shown below.
- 3 Click **Install**

*Exhibit 4-2 FastFrame Network Connection Properties*

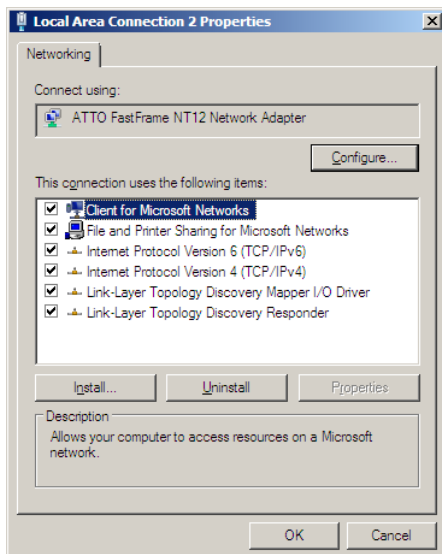

- 4 Select **Protocol** and click **Add**

*Exhibit 4-3 Network Feature Type Selection*

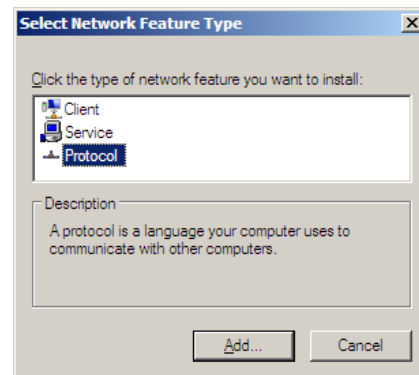

- 5 Select **FastFrame Link Aggregation** and click **OK** as shown in 4-4.

Exhibit 4-4 Select Protocol to install

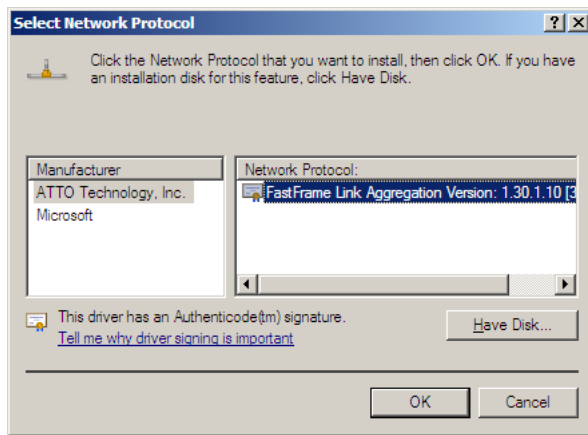

- 6 FastFrame Link Aggregation is now installed and ready to configure.

Exhibit 4-5 FastFrame Network Connection Properties (with Link Aggregation installed)

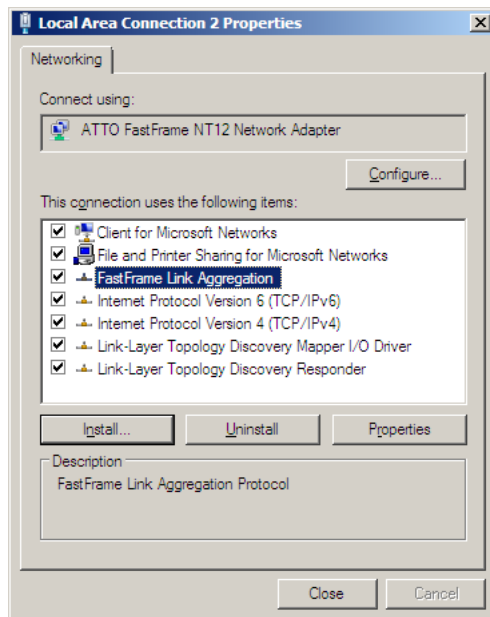

## Configuring Link Aggregation

The ATTO FastFrame Link Aggregation user interface uses the following terminology:

- **Port** - A port is a single ethernet connection on a network adapter. Only ports on FastFrame Ethernet adapters can participate in FastFrame link aggregation.
- **Aggregate Group** - A set of Ports which are configured to aggregate with each other. "Group" also refers to the Windows Network Connection object that represents the aggregated links.

## Opening the FastFrame Link Aggregation Properties Page

- 1 Open the Network Connection Properties page for one of the FastFrame adapters as shown in 4-5.
- 2 Select **FastFrame Link Aggregation** and click **Properties**. As shown in 4-6, the FastFrame Link Aggregation Properties page displays:
  - The name of the port
  - The name of the group that this port is a member of. If aggregation is not enabled for this port, the group will be **<none>**.
  - Controls to configure link aggregation for this port. The controls allow this port to be added to and removed from an aggregate group.

Exhibit 4-6 FastFrame Link Aggregation Properties Page

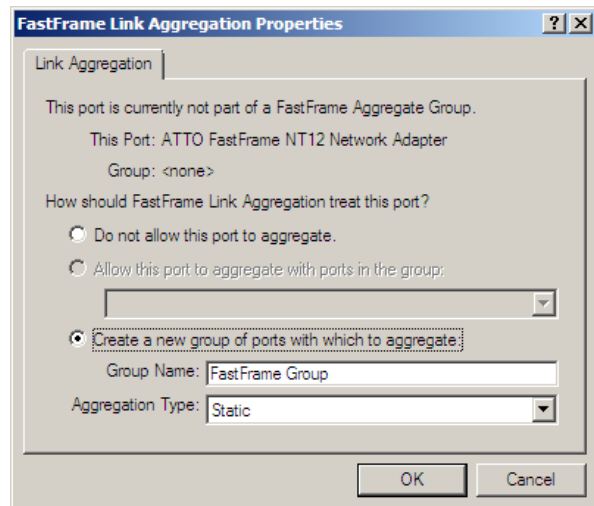

## Configuring a Group's Operational Settings

A FastFrame aggregate group derives most of its operational settings, such as Offloads and jumbo packets, automatically, based on the settings of the network adapters in the group. Therefore, in order for a feature to be in effect for a group, that feature must be set identically on each member adapter. For example, to enable jumbo packets for a group, enable Jumbo Packets (by selecting the same jumbo packet size, such as 9014) on each adapter. Likewise, in order to disable checksum offloads, checksum offloads must be disabled for each adapter.



### Note

*For best results, configure the settings on each individual member adapter before creating the group containing those adapters.*



### CAUTION

**Having adapters with mismatched configuration settings can lead to loss of connectivity and/or network I/O errors. To ensure proper operation, each of the underlying adapters in a group must be configured the same.**



### Note

*Reconfiguring an aggregate group - adding or removing a port, or making certain changes to a member adapter's operational settings - will result in momentary loss of the group's network connection.*

*After reconfiguration of FastFrame aggregate groups, it may be necessary to reboot the system in order for changes to be applied completely*

## Creating an Aggregate Group

- 1 Open the FastFrame Link Aggregation Properties page for one of the FastFrame adapters that is to be included in the new group as shown in 4-6.
- 2 Select the option to Create a new group of ports
- 3 Enter a name for the group and click **OK**.
- 4 Select the type of link aggregation to use. Currently only Static aggregation is supported.
- 5 Click **OK**.



### Note

*The Group will be given the MAC address of the first adapter added to the group.*



### Note

*As shown in 4-7, the group will appear in the Network Connections list and operate similarly to any other network connection.*

Exhibit 4-7 Network Connections (with a FastFrame Group)

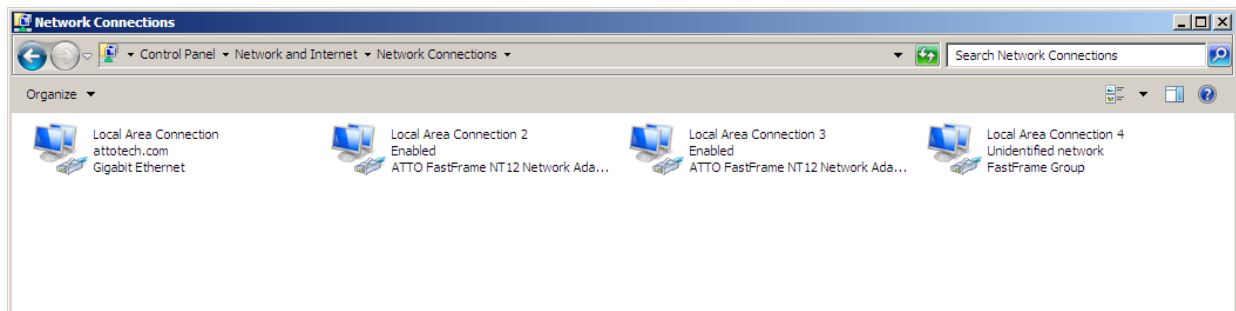

## Adding a Port to a Group

Exhibit 4-8 Adding a Port to a Group

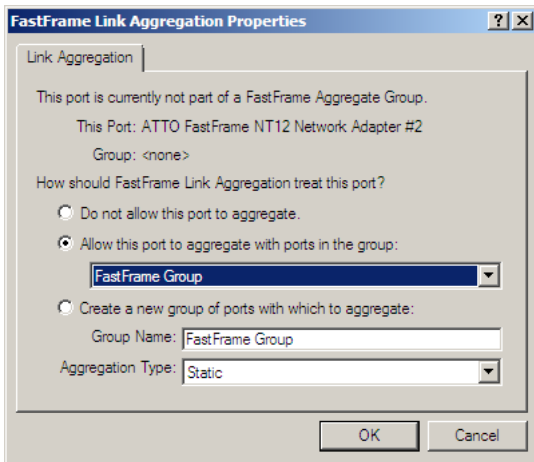

- 1 Open the FastFrame Link Aggregation Properties page for the FastFrame adapter that is to be added to the group.
- 2 Select **Allow this port to aggregate with ports in the group**
- 3 Select the group in the list.



### Note

*If only one group has been created, it will be the only entry in the list and will be selected automatically.*

- 4 Select the type of link aggregation to use.



### Note

*Currently only Static aggregation is supported, which will be selected automatically.*

- 5 Click **OK**.
- 6 Repeat this process for each port that is to be added to the group.

## Removing a Port from a Group

Exhibit 4-9 Removing a Port from a group

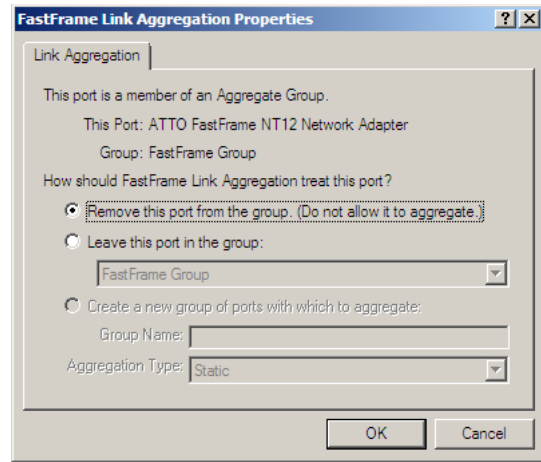

- 1 Open the FastFrame Link Aggregation Properties page for the FastFrame adapter that is to be removed from the group.
- 2 Select **Remove this port from the group.**
- 3 Click **OK**.



### Note

*The port is removed from the group, and will no longer aggregate with any of the ports in the group. This effectively disables FastFrame link aggregation for this adapter. If there are no other ports remaining in the group, the group itself will be removed and deleted from the system.*

## Removing a Group

To remove a group:

- 1 Remove each of the adapters from the group. Upon removal of the last adapter in the group, the group will be removed from the system

## Uninstalling Link Aggregation

To remove FastFrame Link Aggregation:

- 1 Open the Properties for any FastFrame Network Connection.
- 2 Select **FastFrame Link Aggregation**.
- 3 Click **Uninstall**.

# 5 Troubleshooting

---

This chapter contains solutions for the most common problems you might encounter. If you need additional assistance, please refer to the ATTO Technology website, [www.attotech.com](http://www.attotech.com), or contact an authorized ATTO Technology representative.

## General suggestions

---

- Check each cable connection on every device.
- Verify all cables are in proper working condition. Loose or broken cables are often the cause of errors or problems.
- Check that connected devices are plugged into an AC outlet and are turned on before you add power to your computer.

## Windows

---

- If working properly the NIC should appear in the Device Manager.
- If the FastFrame NIC does not appear under the Network Adapters:
  - a. Remove power from the PC.
  - b. Open the case.
  - c. Check that the FastFrame NIC adapter is properly seated in the PCI slot.
  - d. Replace the case and apply power.
- If the adapter has been identified but there is an exclamation point (!) on the listing:
  - a. Right click on the listing and select Uninstall.
  - b. Reload the driver (see [Installing FastFrame Link Aggregation](#) on page 16).
  - c. Reboot the system and repeat the installation process.

If problems persist, contact your authorized ATTO Technology representative.

## Linux

---

- 1 Verify the FastFrame driver is loaded with the `lsmod` command. If `lsmod` does not show the driver, refer to the installation instructions to install and load the driver in [Installing FastFrame Link Aggregation](#) on page 16.
- 2 Check the system log with the command `dmesg`. The FastFrame driver creates status messages during initialization. Make sure that all installed cards are properly detected and initialized.
- 3 Examine the contents of the file(s): `/proc/scsi/fastframe/x`, where `x` is the adapter's host number. This file contains details such as link status, connection speed and discovered devices.



### Note

*Advanced users only. Modify the **driver makefile** to enable debugging information. Upon loading, the **FastFrame driver** displays detailed debugging information which may help troubleshoot the problem.*

## Mac OS X

---



### Note

*The ATTO FastFrame supports Mac OS X versions 10.6.x and later.*

- 1 Open the ATTO ConfigTool from the ATTO Utilities CD or download it from the ATTO website. Refer to the ATTO Utilities Installation and Operations Manual for additional information.
- 2 If the adapter does not appear in the System Profiler, make sure the card is seated properly in the PCIe slot.
  - a. Shut down and remove power from the Mac.
  - b. Remove the side of the case.
  - c. Check the PCIe slot
  - d. Replace the side of the case.
  - e. Apply power



### Note

*If the Fastframe adapter is properly seated and devices are still not accessible check the cable to verify the link light is illuminated. If not contact an authorized ATTO representative.*

- 3 Verify the driver is loaded.
  - a. Click on the adapter name in the Device Listing to view the Basic Info screen.
  - b. If the Driver Information section indicates Unknown: driver not loaded, reinstall the driver. Refer to Updating Hardware Flash Drivers on page 25.
  - c. If reinstalling the driver does not fix the problem, contact an authorized ATTO representative.
- 4 Reset the NVRAM for all channels to defaults and reboot. If the problem persists, contact an authorized ATTO representative.



### Note

*When calling ATTO Technical Support please have a printout of the IOreg listing, Apple System Profiler, Serial number of the adapter, and what driver and firmware that is currently loaded in your Apple computer.*



# Appendix A Glossary

Some terms used in the Network Interface industry are defined below. More information is available through the ATTO Technology website ([www.attotech.com](http://www.attotech.com)) and the Storage Area Networking Industry Association ([www.snia.org](http://www.snia.org)).

| <b>Term</b>      | <b>Definition</b>   |
|------------------|---|
| ANSI             | American National Standards Institute   |
| BER              | Bit Error Rate: a measure of transmission accuracy; the ratio of bits received in error to bits sent  |
| bit              | smallest unit of data a computer can process: a single binary digit with a value of either 0 or 1   |
| bus              | a collection of unbroken signal lines used to transmit information from one part of a computer system to another; taps on the lines connect devices to the bus  |
| byte             | an ordered set of 8 bits  |
| channel          | a point-to-point link which transports data from one point to another   |
| CPU              | Central Processing Unit: the portion of the computer that actually performs computations  |
| CRC              | Cyclic Redundancy Check: an error-correcting code which calculates a numeric value for received and transmitted data; if no error has occurred during transmission, the CRC for both received and transmitted data should be the same       |
| device driver    | a program that allows a microprocessor to direct the operation of a peripheral device   |
| DMA              | Direct Memory Access: a way to move data from a storage device directly to RAM without using the CPU's resources  |
| DMA bus master   | allows a peripheral to control the flow of data to and from system memory by block as opposed to allowing the processor to control the data by bytes (PIO or programmed I/O)  |
| full-duplex      | a communication protocol which allows transmission in both directions at the same time  |
| half duplex      | a communication protocol which allows transmission in both directions, but only one direction at a time   |
| host             | a processor, usually a CPU and memory, which communicates with devices over an interface  |
| initiator device | a component which originates a command  |
| LED              | Light-emitting diode: a type of diode that emits light when current passes through it; visible LEDs are used as indicator lights on all sorts of electronic devices   |
| LUN              | Logical Unit Number: an identifier for a logical unit (0-7)   |
| MAC              | Media Access Controller   |
| MAC Address      | A unique address assigned to an ethernet device   |
| multi-mode fiber | an optical fiber which can carry several beams of light at once   |
| N_port           | a port attached to a node used with point to point or fabric configurations   |
| originator       | an initiating device; a component which originates a command  |
| parity checking  | a method which verifies the accuracy of data transmitted over the SCSI bus by adding one bit in the transfer to make the sum of all the bits either odd or even (for odd or even parity); an error message occurs if the sum is not correct |
| PCI              | Peripheral Component Interconnect. Allows peripherals to be connected directly to computer memory, bypassing the slower ISA and EISA busses   |
| point-to-point   | a topology where two ports communicate  |
| port             | an access point in a device: see N_port, NL_port, etc.  |
| port address     | also port number; the address, assigned by the PCI bus, through which commands are sent to a host adapter board   |
| port number      | see port address  |
| receiver         | the ultimate destination of data transmission; a terminal device  |

| <b>Term</b>       | <b>Definition</b>   |
|-------------------|---|
| scatter/gather    | a device driver feature which allows the host adapter to modify a transfer data pointer so that a single host adapter can access many segments of memory, minimizing interrupts and transfer overhead |
| single-mode fiber | an optical fiber with a small core which supports one wavelength (ray of light); the core radius is nearly equal to the wavelength of the source  |
| SNMP              | Simple Network Management Protocol: a standard for monitoring network-attached devices  |
| topology          | logical layout of the parts of a computer system or network and their interconnections  |
| transceiver       | a transmitter/receiver module   |
| transfer rate     | the rate at which bytes or bits are transferred, as in megabytes or gigabits per second   |

## **Appendix B Accessories**

---

*The following accessories are available through ATTO Technology and authorized resellers. Contact an ATTO Technology authorized sales representative to order.*

### **Optical Cables**

CBL-FCFI-05x5 m. cable – Duplex 50 Micron Multi-mode FC/Optical  
CBL-LCSC-0033 m. 50/125 optical cable (LC to SC)  
CBL-LCSC-01010 m. 50/125 optical cable (LC to SC)

*A variety of Fibre Channel, SAS and SCSI products are also available from ATTO Technology. Please contact your ATTO sales representative for product descriptions and part number information.*

### **Fibre Channel solutions**

ATTO Celerity™ Family of Fibre Channel Host Adapters

### **SCSI solutions**

ATTO ExpressPCI Family of SCSI Host Adapters (see Appendix C)

### **SAS/SATA Solutions**

ATTO ExpressSAS family of SAS Host and RAID Adapters (see Appendix C)

### **Software**

ATTO ConfigTool – Configuration and management software  
ATTO Express Power Center – Windows & Mac OS X RAID 0 and benchmark software

## Appendix C ATTO Adapter Selection Guides

Contact your ATTO representative or visit the ATTO website for details on all ATTO products.

### ExpressPCI SCSI host adapters

| Product Features                                | Ultra 320 SCSI |         |         |
|---|----------------|---------|---------|
|   | UL5D           | UL5D LP | UL4D    |
| Max. transfer rate (MB/sec.)                    | 640MB/s        | 640MB/s | 640MB/s |
| Low Voltage Differential                        | •              | •       | •       |
| Single-ended SCSI                               | •              | •       | •       |
| Number of SCSI Channels (internal/external)     | 2/2            | 0/2     | 2/2     |
| Number of SCSI IDs supported                    | 30             | 30      | 30      |
| Low profile                                     |                | •       |         |
| Large file transfers                            | •              | •       | •       |
| Cable distances (m)                             | 12.5           | 12.5    | 12.5    |
| 32-bit PCI compatible                           |                |         | •       |
| 64-bit PCI compatible                           |                |         | •       |
| 33 MHZ PCI                                      |                |         | •       |
| 133 MHZ PCI-X                                   |                |         | •       |
| 66 MHZ PCI                                      |                |         | •       |
| x4 PCI Express                                  | •              | •       |         |
| Windows 2000/XP, Server 2003/2008/Vista support | •              | •       | •       |
| Linux support                                   | •              | •       | •       |
| Mac OS X support                                | •              | •       | •       |
| Novell Netware support                          | •              | •       | •       |
| RoHS compliant                                  | •              | •       | •       |

## ExpressSAS 6 Gb Host Adapters

| Product Features                     | H6F0 GT                           | H6F0                              | H60F                              | H680                              | H608                              | H644   |
|--------------------------------------|-----------------------------------|-----------------------------------|-----------------------------------|-----------------------------------|-----------------------------------|--|
| Max Data Rate                        | 6Gb/s                             | 6Gb/s                             | 6Gb/s                             | 6Gb/s                             | 6Gb/s                             | 6Gb/s  |
| x8 PCI Express                       | •                                 | •                                 | •                                 | •                                 | •                                 | •  |
| Number of ports                      | 16                                | 16                                | 16                                | 8                                 | 8                                 | 8  |
| Port configuration external/internal | 16/0                              | 16/0                              | 0/16                              | 8/0                               | 0/8                               | 4/4  |
| Connector type                       | 4 mini SAS (x4) SFF-8644 external | 4 mini SAS (x4) SFF-8088 external | 4 mini SAS (x4) SFF-8087 internal | 2 mini SAS (x4) SFF-8088 external | 2 mini SAS (x4) SFF-8087 internal | 1 mini SAS (x4) SFF-8088 external<br><br>1 mini SAS (x4) SFF-8087 internal |
| Number of devices supported          | 2048 end-point devices            | 512 end-point devices             | 512 end-point devices             | 256 end-point devices             | 256 end-point devices             | 256 end-point devices  |
| 1.5 Gb SATA support                  | •                                 | •                                 | •                                 | •                                 | •                                 | •  |
| 3 Gb SATA II support                 | •                                 | •                                 | •                                 | •                                 | •                                 | •  |
| 3 Gb SAS support                     | •                                 | •                                 | •                                 | •                                 | •                                 | •  |
| 6 Gb SATA II support                 | •                                 | •                                 | •                                 | •                                 | •                                 | •  |
| 6 Gb SAS support                     | •                                 | •                                 | •                                 | •                                 | •                                 | •  |
| Software RAID                        | 0                                 | 0                                 | 0                                 | 0                                 | 0                                 | 0  |
| Cable distances                      | up to 8m SAS, 1m SATA             | up to 8m SAS, 1m SATA             | up to 8m SAS, 1m SATA             | up to 8m SAS, 1m SATA             | up to 8m SAS, 1m SATA             | up to 8m SAS, 1m SATA  |
| Advanced Data Streaming™             | •                                 | •                                 | •                                 | •                                 | •                                 | •  |
| 32-bit support                       | •                                 | •                                 | •                                 | •                                 | •                                 | •  |
| 64-bit support                       | •                                 | •                                 | •                                 | •                                 | •                                 | •  |
| Windows                              | •                                 | •                                 | •                                 | •                                 | •                                 | •  |
| Linux                                | •                                 | •                                 | •                                 | •                                 | •                                 | •  |
| Mac OS X                             | •                                 | •                                 | •                                 | •                                 | •                                 | •  |
| VMware                               | •                                 | •                                 | •                                 | •                                 | •                                 | •  |
| Low profile                          | •                                 | •                                 | •                                 | 1/2 height                        | 1/2 height                        | 1/2 height   |

## ExpressSAS 6 Gb RAID Adapters

| <b>Product Features</b>              | <b>R60F</b>                             | <b>R680</b>                             | <b>R608</b>                             | <b>R644</b>  |
|--------------------------------------|---|---|---|--|
| Max Data Rate                        | 6Gb/s                                   | 6Gb/s                                   | 6Gb/s                                   | 6Gb/s  |
| x8 PCI Express                       | •                                       | •                                       | •                                       | •  |
| Number of ports                      | 16                                      | 8                                       | 8                                       | 8  |
| Port configuration external/internal | 0/16                                    | 8/0                                     | 0/8                                     | 4/4  |
| Connector type                       | 4 mini SAS (x4)<br>SFF-8087<br>internal | 2 mini SAS (x4)<br>SFF-8088<br>external | 2 mini SAS (x4)<br>SFF-8087<br>internal | 1 mini SAS (x4)<br>SFF-8088<br>external<br>1 mini SAS (x4)<br>SFF-8087<br>internal |
| Number of devices supported          | 128 SAS/SATA<br>targets                 | 128 SAS/SATA<br>targets                 | 128 SAS/SATA<br>targets                 | 128 SAS/SATA<br>targets  |
| 1.5 Gb SATA support                  | •                                       | •                                       | •                                       | •  |
| 3 Gb SATA II support                 | •                                       | •                                       | •                                       | •  |
| 3 Gb SAS support                     | •                                       | •                                       | •                                       | •  |
| 6 Gb SATA II support                 | •                                       | •                                       | •                                       | •  |
| 6 Gb SAS support                     | •                                       | •                                       | •                                       | •  |
| Software RAID                        | 0, 40, 50, 60                           | 0, 40, 50, 60                           | 0, 40, 50, 60                           | 0, 40, 50, 60  |
| Integrated RAID                      | 0, 1, 4, 5, 6<br>JBOD, DVRAID           | 0, 1, 4, 5, 6<br>JBOD, DVRAID           | 0, 1, 4, 5, 6<br>JBOD, DVRAID           | 0, 1, 4, 5, 6<br>JBOD, DVRAID  |
| RAID Management Utility              | •                                       | •                                       | •                                       | •  |
| Global Hot Spares                    | •                                       | •                                       | •                                       | •  |
| Event notification                   | E-mail, pop-up,<br>log file             | E-mail, pop-up,<br>log file             | E-mail, pop-up,<br>log file             | E-mail, pop-up,<br>log file  |
| SNMP                                 | •                                       | •                                       | •                                       | •  |
| Memory (ECC)                         | 512 MB                                  | 512 MB                                  | 512 MB                                  | 512 MB   |
| Cable distances                      | up to 10m SAS,<br>1m SATA               | up to 10 SAS,<br>1m SATA                | up to 10m SAS,<br>1m SATA               | up to 10m SAS,<br>1m SATA  |
| Advanced Data Streaming™             | •                                       | •                                       | •                                       | •  |
| 32-bit support                       | •                                       | •                                       | •                                       | •  |
| 64-bit support                       | •                                       | •                                       | •                                       | •  |
| Windows                              | •                                       | •                                       | •                                       | •  |
| Linux                                | •                                       | •                                       | •                                       | •  |
| Mac OS X                             | •                                       | •                                       | •                                       | •  |
| Low profile                          | •                                       | •                                       | •                                       | •  |

## Celerity 8-Gb Adapters

| Product Features                          | FC-84EN                            | FC-82EN                            | FC-81EN                            |
|---|------------------------------------|------------------------------------|------------------------------------|
| Fibre Channel Ports                       | 4                                  | 2                                  | 1                                  |
| FC protocol                               | 8-Gb                               | 8-Gb                               | 8-Gb                               |
| Maximum Transfer Rate (Full Duplex)       | 6.4GB/s                            | 3.2GB/s                            | 1.6GB/s                            |
| Maximum Transfer Rate (Half Duplex)       | 3.2GB/s                            | 1.6GB/s                            | 800MB/s                            |
| Bus type                                  | PCIe 2.0                           | PCIe 2.0                           | PCIe 2.0                           |
| Bus characteristics                       | 8 lane                             | 8 lane                             | 4 lane                             |
| Optical interface                         | SFP+LC                             | SFP+LC                             | SFP+ LC                            |
| Maximum cable length                      | 300m@2-Gb<br>150m@4-Gb<br>50m@8-Gb | 300m@2-Gb<br>150m@4-Gb<br>50m@8-Gb | 300m@2-Gb<br>150m@4-Gb<br>50m@8-Gb |
| Low profile form factor                   |                                    | ✓                                  | ✓                                  |
| Advanced Data Streaming (ADS™) Technology | ✓                                  | ✓                                  | ✓                                  |
| Software RAID support <sup>1</sup>        | ✓                                  | ✓                                  | ✓                                  |
| Developer's kit (Target Mode & API)       | ✓                                  | ✓                                  | ✓                                  |
| Windows support                           | ✓                                  | ✓                                  | ✓                                  |
| Linux driver support                      | ✓                                  | ✓                                  | ✓                                  |
| Macintosh OS X driver support             | ✓                                  | ✓                                  | ✓                                  |
| VMware driver support                     | ✓                                  | ✓                                  | ✓                                  |
| 1 ATTO Express Power Center recommended   |                                    |                                    |                                    |

# Appendix D Standards, Compliances

The Technical Specification sheet for each FastFrame NIC lists certifications for that model. Models covered by this page include the FastFrame FFRM-NS14, FFRM-NS12, FFRM-NS11, FFRM-NT12, FFRM-NT11

## FCC standards: radio and television interference



This equipment has been tested and found to comply with the limits for a Class B digital device, pursuant to Part 15 of the FCC Rules. These limits are designed to provide reasonable protection against harmful interference in a residential installation. This equipment generates, uses, and can radiate radio frequency energy and, if not installed and used in accordance with the instruction manual, may cause interference to radio communications. However, there is no guarantee that interference will not occur in a particular installation. If this equipment does cause interference to radio or television reception, which can be determined by turning the equipment off and on, the user is encouraged to try to correct the interference by one or more of the following measures:

- Reorient or relocate the receiving antenna
- Increase the separation between the equipment and receiver
- Connect the equipment into an outlet on a circuit different from that to which the receiver is connected
- Consult the dealer or an experienced radio/TV technician for help

## Canadian standards



This Class B digital apparatus complies with Canadian ICES-003.

Cet appareil numérique de la classe B est conforme à la norme NMB-003 du Canada.

## European standards

### Declaration of Conformity



This following statement applies to all FastFrame adapter.

This device has been tested in the basic operating configuration and found to be compliant with the following European Union standards: Application of Council Directive: 2004/108/EC Standard(s) to which conformity is declared: EN55024:2010; EN55022:2010 CLASS B.

This Declaration will only be valid when this product is used in conjunction with other CE approved devices and when the entire system is tested to the applicable CE standards and found to be compliant

## Japanese standards

この装置は、クラスB情報技術装置です。この装置は、家庭環境で使用することを目的としていますが、この装置がラジオやテレビジョン受信機に近接して使用されると、受信障害を引き起こすことがあります。

取扱説明書に従って正しい取り扱いをして下さい。

VCCI-B

Voluntary Control Council for Interference by Information Technology Equipment (VCCI, Japan)

This is a Class B product based on the standard of the Voluntary Control Council for Interference from Information Technology Equipment (VCCI). If this is used near a radio or television receiver in a domestic environment, it may cause radio interference. Install and use the equipment according to the instruction manual.



# Compliances



ATTO FastFrame cards comply with Directive 2011/65/EU on the Restriction of the Use of Hazardous Substances in Electrical and Electronic Equipment (RoHS). Contact your ATTO representative regarding RoHS compliant products.

The FastFrame family of adapters take the following RoHS exemptions:

7(a) - Lead in high melting temperature type solders (i.e. lead based alloys containing 85% by weight or more lead).

7(c)-I - Electrical and electronic components containing lead in a glass or ceramic other than dielectric ceramic in capacitors, (e.g. piezoelectronic devices, or in a glass or ceramic matrix compound).

7(c)-III - Lead in dielectric ceramic in capacitors for a rated voltage of less than 125 V AC or 250 V DC.

13(a) - Lead in white glasses used for optical applications.

15 - Lead in solders to complete a viable electrical connection between semiconductor die and carrier within integrated circuit flip chip packages.

|  |   | China RoHS Status Certificate<br>中国 RoHS 认证概况  |                   |                                  |  |  |
|--|---|--|-------------------|----------------------------------|--|--|
|  |   | Table of Toxic and Hazardous Substances/Elements and their Content<br>有毒有害物质 / 成分及其含量表 |                   |                                  |  |  |
| Part Name<br>(部件名称)  | Toxic and Hazardous Substances and Elements |  |                   |                                  |  |  |
|  | Lead (Pb)<br>铅                              | Mercury (Hg)<br>汞  | Cadmium (Cd)<br>镉 | Hexavalent Chromium (Cr6)<br>六价铬 | Polybrominated biphenols (PBB)<br>多溴联苯 | Polybrominated diphenyl ethers (PBDE)<br>多溴二苯醚 |
| FFRM-NS14<br>Host Bus Adapter<br>主机总线 适配器  | X   | O  | O                 | O                                | O                                      | O  |
| FFRM-NS12<br>Host Bus Adapter<br>主机总线 适配器  | X   | O  | O                 | O                                | O                                      | O  |
| FFRM-NS11<br>Host Bus Adapter<br>主机总线 适配器  | X   | O  | O                 | O                                | O                                      | O  |
| FFRM-NT12<br>Host Bus Adapter<br>主机总线 适配器  | X   | O  | O                 | O                                | O                                      | O  |
| FFRM-NT11<br>Host Bus Adapter<br>主机总线 适配器  | X   | O  | O                 | O                                | O                                      | O  |

Notes 注意:

O: Indicates that this toxic or hazardous substance contained in all of the homogeneous materials for this part is below the limit requirement in SJ/T11363-2006.  
O: 表明该部件的所有同种材料中本有毒或有害物质的含量符合 SJ/T11363-2006 标准所要求的限量。

X: Indicates that this toxic or hazardous substance contained in at least one of the homogeneous materials used for this part is above the limit requirement in SJ/T11363-2006.  
X: 表明该部件使用的同种材料中,至少有一种材料的有毒或有害物质的含量超过 SJ/T11363-2006 标准所要求的限量。

The Environment-Friendly Use Period (EFUP) for all enclosed products and their parts are per the symbol shown here, unless otherwise marked. Certain fieldreplaceable parts may have a different EFUP (for example, battery modules) number. The Environment-Friendly Use Period is valid only when the product is operated under the conditions defined in the product manual.

除非另有特别的标注,此标志为针对所涉及产品的环保使用期限标志。某些可更换的零部件可能会有一个不同的环保使用期限(例如,电池单元模块)。此环保使用期限只适用于产品在产品手册中所规定的条件下工作。



# Appendix E Safety, Warranty

---

*All ATTO host adapter products have been tested to meet applicable safety standards when operated in proper electrical and thermal environments.*

## Safety

---

Please review the specifications for your specific host adapter before installing and operating it in any computer system to ensure compatibility.

## Installation

Before installing an ATTO host adapter product into your computer system, unplug the computer from its electrical power source and allow adequate time for electrical discharge and the internal components to cool down before removing the computer system cover. This will decrease the risk of personal injury from electrical shock or touching the hot surface of an electrical component.

Once an ATTO host adapter is installed in a computer system, the computer cover must be reinstalled properly before turning the computer system back on.

## Operation

ATTO host adapters require adequate cooling to function properly. If you have any questions as to the airflow provided by your computer system, please refer to your computer system manual or contact your computer system manufacturer.

To facilitate proper air circulation, ATTO host adapters should never be operated in a computer system without the cover installed or with an inoperable fan as this may cause safety or thermal problems which could damage the ATTO host adapter and void the warranty.

## ATTO Technology, Inc. limited warranty

---

ATTO Technology, Inc. ("ATTO") warrants to the original purchaser of this product ("Product") that the Product is free from defects in material and workmanship for the term described for this specific Product on ATTO's website ([www.attotech.com](http://www.attotech.com)). ATTO's liability shall be limited to replacing or repairing any defective product at ATTO's option. There is no charge for parts or labor if ATTO determines that this product is defective.

PRODUCTS WHICH HAVE BEEN SUBJECT TO ABUSE, MISUSE, ALTERATION, NEGLIGENCE, OR THOSE PRODUCTS THAT HAVE BEEN SERVICED, REPAIRED OR INSTALLED BY UNAUTHORIZED PERSONNEL WILL NOT BE COVERED UNDER THIS WARRANTY. DAMAGE RESULTING FROM INCORRECT CONNECTION OR AN INAPPROPRIATE APPLICATION OF THIS PRODUCT SHALL NOT BE THE RESPONSIBILITY OF ATTO. LIABILITY UNDER THIS LIMITED WARRANTY IS LIMITED TO ATTO PRODUCT(S). DAMAGE TO OTHER EQUIPMENT CONNECTED TO ATTO PRODUCT(S) IS THE CUSTOMER'S RESPONSIBILITY. THIS LIMITED WARRANTY IS MADE IN LIEU OF ANY OTHER WARRANTIES, EXPRESS OR IMPLIED. ATTO DISCLAIMS ANY IMPLIED WARRANTIES OF MERCHANTABILITY OR FITNESS FOR A PARTICULAR PURPOSE. TO THE EXTENT IMPLIED WARRANTIES CANNOT BE EXCLUDED, SUCH IMPLIED WARRANTIES ARE LIMITED IN DURATION TO THE EXPRESS WARRANTY PERIOD APPLICABLE TO THE PRODUCT. BECAUSE SOME STATES OR JURISDICTIONS DO NOT ALLOW LIMITATIONS ON THE DURATION OF IMPLIED WARRANTIES, THE ABOVE MAY NOT BE APPLICABLE. ATTO'S RESPONSIBILITY TO REPAIR OR REPLACE A DEFECTIVE PRODUCT IS THE SOLE AND EXCLUSIVE REMEDY PROVIDED TO THE CUSTOMER FOR BREACH OF THIS WARRANTY.

ATTO IS NOT RESPONSIBLE FOR DAMAGE TO OR LOSS OF ANY DATA, PROGRAMS OR ANY MEDIA. THE PRODUCTS ARE NOT INTENDED FOR USE IN: (I) MEDICAL DEVICES OR THE MEDICAL FIELD; OR (II) USE IN RUGGED APPLICATIONS.

ATTO IS NOT LIABLE FOR ANY INDIRECT, SPECIAL, INCIDENTAL, OR CONSEQUENTIAL DAMAGES, IRRESPECTIVE OF WHETHER ATTO HAS BEEN ADVISED OF THE POSSIBILITY OF SUCH DAMAGES. NO ATTO DEALER, AGENT OR EMPLOYEE IS AUTHORIZED TO MAKE ANY MODIFICATION, EXTENSION OR ADDITION TO THIS WARRANTY.

This warranty gives you specific legal rights, and you may also have other rights which vary from state to state.