

---

***Amana*® 24" Deep  
Side-By-Side Built-In Refrigerator  
Use & Care Manual**

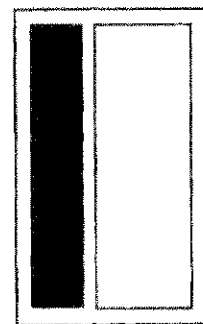

***Amana* 20**

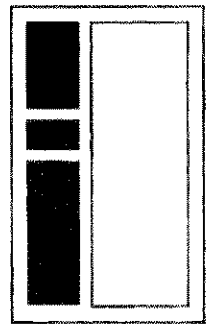

***Amana* 20**

---

# Welcome to the Amana Family

Your purchase of an Amana refrigerator/freezer—a household appliance known for its quality and reliability—is sincerely appreciated by Amana Refrigeration, Inc. Your total satisfaction with this new product is extremely important to us, and this Use and Care Manual will aid you in understanding the operation of your new appliance.

Each product is thoroughly tested and checked at the factory. Once in your home, you may want to make a few simple adjustments of control settings, etc. to tailor your new unit to your own individual requirements. These adjustments are easily made following the instructions in this manual.

Should your new unit ever require service, certain product information will aid in obtaining service faster! For your convenience and protection, please record this information in the box at right and retain this booklet for future reference.

The Registration Card in the packet with the manual should be filled out and returned to Amana Refrigeration, Inc.

Record in the space below the information found on the nameplate of your refrigerator. The nameplate is located on the ceiling of the refrigerator section. Also, please retain a copy of your sales receipt for future reference should warranty service be needed.

Serial No. \_\_\_\_\_

Model No. \_\_\_\_\_

Manufacturing No. \_\_\_\_\_

Date of Purchase \_\_\_\_\_

Selling Dealer \_\_\_\_\_

## WARNING

**Electrical Grounding Instructions**—This appliance is equipped with a three-prong (grounding) plug for your protection against possible shock hazards. Where a two-prong wall receptacle is encountered, it is the personal responsibility and obligation of the customer to contact a qualified electrician and have it replaced with a properly grounded three-prong wall receptacle in accordance with the National Electrical Code (see figure.)

Unit is designed to operate on a separate 103 to 126 V.A.C., 15 amp., 60 cycle line.

**DO NOT UNDER ANY CIRCUMSTANCES CUT OR REMOVE THE ROUND GROUNDING PRONG FROM THE PLUG. THE UNIT MUST BE GROUNDED AT ALL TIMES. DO NOT REMOVE WARNING TAG FROM THE SERVICE CORD.**

ELECTRICAL PLUG WITH GROUNDING PRONG

ELECTRICAL RECEPTACLE WITH GROUNDING RECEPTACLE

## WARNING

**DO NOT USE A TWO-PRONG ADAPTER.  
DO NOT USE AN EXTENSION CORD.**



ROUND GROUNDING PRONG

Contents	Page
Electrical Warning .....	2
Unpacking .....	3
Door Handle Removal .....	3
Door Removal .....	3
Placement, Door Alignment and Leveling .....	5
Door Panel and Dispenser Trim Installation Instructions .....	6
The Ice 'N Water Dispenser .....	8
General Features .....	11
Setting the Controls .....	12
Refrigerator Features .....	13

Contents	Page
Freezer Features .....	15
Other Features .....	16
Save Energy .....	17
Care and Cleaning .....	18
Non-Use Periods .....	20
Sounds .....	21
Before Calling For Service .....	22
Amana Asure .....	23
Amana Toll-Free .....	23

# Unpacking, Door Handle and Door Removal

## CAUTION:

To Avoid The Risk Of Personal Injury use caution in unpacking, handling, removing, installing and cleaning all parts of product which may have sharp edges.

## CAUTION:

To Avoid The Risk Of Personal Injury wear protective hand covering.

Remove all tape and packing material. To remove tape residue, touch a portion of the tape to the residue and lift it off. If adhesive residue still remains, try cleaning the sticky area with a clean cloth soaked in mild dish washing soap. Wipe area clean. If the wood base is still attached, have someone help you tilt the unit onto its back, placing a sturdy support underneath. Remove the mounting bolts from the base and discard bolts and wood base.

**IMPORTANT!** Do not leave the cabinet on it's back longer than it takes to remove the wooden base and do not connect the power cord until after all the inside packing has been removed and the cabinet has been leveled for proper operation.

With the unit upright, pull the toe grille from the bottom front (see Figure 1) and make sure the defrost drain pan is located underneath the defrost water drain tube. Two drain pan side supports (attached to the cabinet bottom) keep the pan in the proper location, to make the automatic defrost drain water drop on

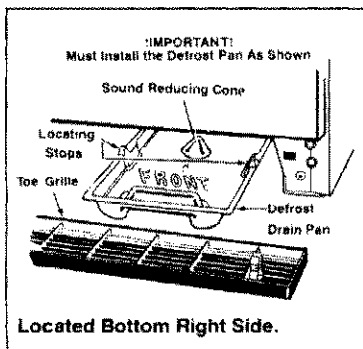

FIGURE 1

the sound reducing cone. The drain pan locating stops prevent the pan from being installed backwards.

Remove all tape and packing material from inside the unit.

**SPECIAL NOTE:** If cabinet is unable to fit through doorway safely, you may have to remove the door handles, or door assemblies. Refer to the following chart and diagrams.

### To Remove Door Handles

1. Remove screws with a phillips screwdriver from top of handle (end cap). (See Figure 2.)
2. Remove end cap.
3. Remove screw from bottom end cap. (Goes into door.) Note: Screws are in at an angle — do not scratch handle edge.
4. Pull out vinyl decorator strip by pulling straight up.
5. Remove screws retaining handle.
6. Handles will easily fall away.

### To Remove The Door Assemblies

**NOTE:** If unit is already installed slide unit out from cabinetry first.

1.

## CAUTION

To Avoid The Risk Of Personal Injury first tape the top of doors for safety after removing top door trim. (See Figure 2A)

2. Remove the 3 screws from the top of the aluminum extruded trim (See Figure 2).
3. Slide out trim from under end cap.

### TO REMOVE THE DOORS

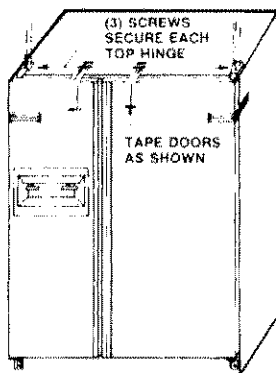

FIGURE 2A

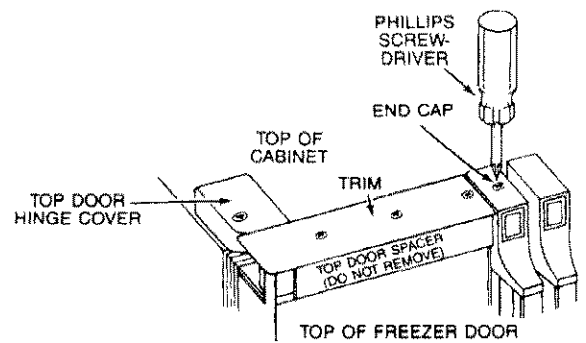

FIGURE 2

## CAUTION:

To Avoid Personal Injury, securely hold onto the door handles while removing screws.

# Door Removal

## CAUTION:

To Avoid The Risk Of Personal Injury Or Property Damage have two people remove the door. One to hold the door and one to remove the safety tape, and help with the tools.

4. Remove the top hinge covers (see Figure 3).

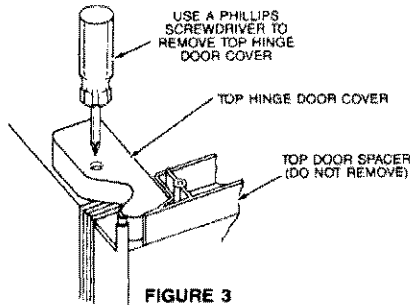

FIGURE 3

## CAUTION

To Avoid Electrical Shock or Death Disconnect the Power Cord.

5. Mark around the upper hinge brackets with a pencil to locate them for reassembly (see Figure 3A).

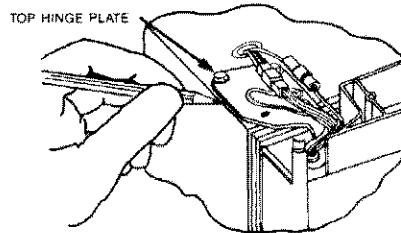

FIGURE 3A

## WARNING:

To Avoid The Risk Of Electrical Shock, Personal Injury or Death: DISCONNECT the power cord BEFORE removing the top hinge.

6. Disconnect top hinge freezer door wires (see Figure 4).

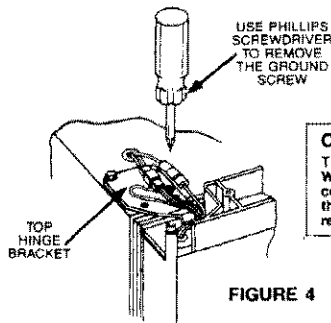
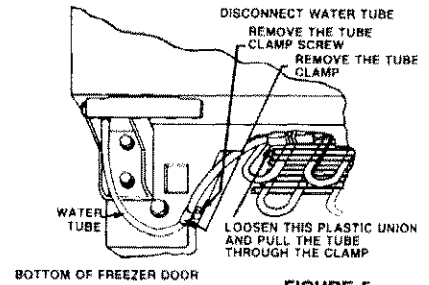

FIGURE 4

**CRITICAL:**  
The Ground Wire must be connected when the doors are reassembled.

7. Disconnect freezer door bottom hinge water line by loosening the 1/4" O.D. plastic tube union nut (see Figure 5).



BOTTOM OF FREEZER DOOR

FIGURE 5

8. Remove the upper door hinges, (3) screws per upper hinge (see Figure 6).

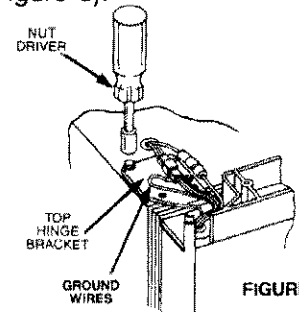

FIGURE 6

**CRITICAL:**  
The Ground Wire must be connected when the doors are reassembled.

9. The freezer door water line will thread through the bottom hinge, lift the door off carefully (see Figure 7).

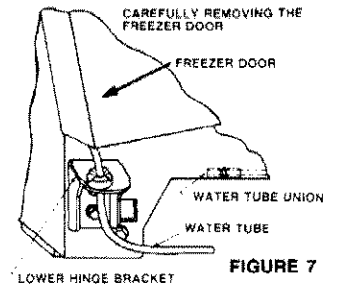

FIGURE 7

10. Remove the refrigerator door assemblies by lifting off the bottom hinge pins. Note: At this point the refrigerator may fit through the doorway. If not, proceed to steps 11 and 12.

11. Mark around the lower hinge brackets (see Figure 8).

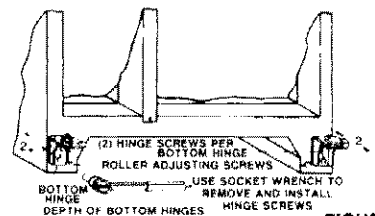

FIGURE 8

12. Remove the lower hinge bracket screws. (2) screws per lower hinge.

To install the door assemblies, assemble in reverse order.

# Placement, Door Alignment and Leveling

## Placement

On some counter tops there is a 1" overhang. If this is the case, the front corners of the counter top must be trimmed off at a 45° angle for the refrigerator and freezer door clearance (see Figure 9). To build-in your refrigerator a Perimeter Trim Kit is available from your dealer at an additional cost.

A recessed electrical outlet installed on the back wall allows for a built-in installation of your refrigerator.

Suggested height requirement for recessed electrical outlet is 3 to 4 ft. from floor.



## CAUTION:

To Avoid Property Damage to soft vinyl flooring follow the floor product manufacturer's recommendations when installing or moving the refrigerator.

To build in your refrigerator with other options, such as wood or laminate consult with a local kitchen designer.

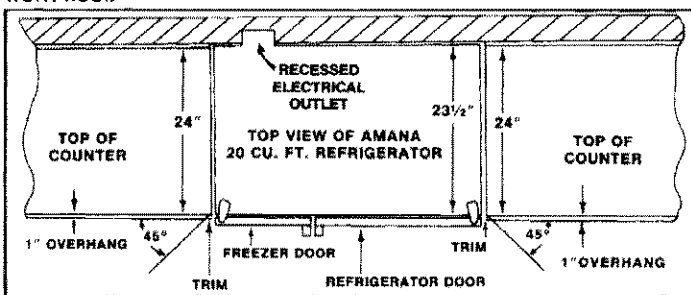

FIGURE 9

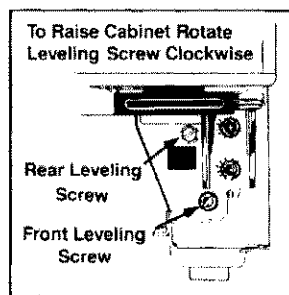

FIGURE 10

## Leveling

Install the refrigerator on a solid floor that is strong enough to support the combined weight of the unit, approximately 320 lbs.; and the food, maximum of 625 lbs. with an approximate combined weight of 945 lbs.

The refrigerator must be level from side to side, front to back to insure complete door closing and proper

ice making. This allows doors to close firmly. Your refrigerator is equipped with front and rear leveling feet. Adjust the wheels or leveling feet to level the refrigerator. To raise, turn screw or leveling feet clockwise. To lower, turn counter-clockwise. See Figure 10. Improper leveling will cause water spills and uneven ice cube size.

## Door Alignment

The doors on this refrigerator were aligned at the factory. Once the refrigerator is properly leveled, the doors will be aligned. If further adjustment is required, please follow the steps below.

1. Before checking alignment, open and close both doors to insure they are resting on the bottom bearings.
2. Check alignment of doors at TOP CENTER. See Figure 11. If doors are aligned, go to step 4.
3. If doors are not aligned:
  - A. Lower the front roller (turn the screw clockwise one turn at a time) on the side of the refrigerator which has the lower door. See Figure 10.
  - B. Open and close both doors.
  - C. Recheck alignment.
  - D. If doors are not aligned repeat steps A through C.
4. If one of the front rollers is not touching the floor (refrigerator will rock), lower that roller only enough to contact the floor.

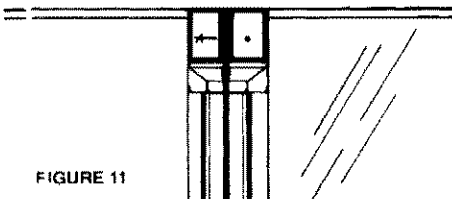

FIGURE 11

# Door Panel and Dispenser Trim Installation Instructions

**Tools Needed** — Standard Straight Screwdriver, Phillips Screwdriver, 1/4" Hex Nut Driver and Tightly Fitted Gloves

1. Remove screw from both top and bottom handle end cap. See Figure 12 and 13.

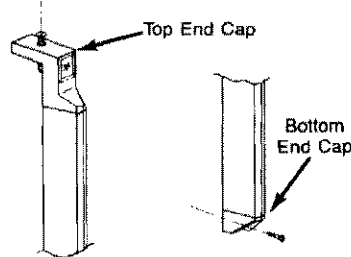

FIGURE 12

FIGURE 13

2. Remove end caps and place aside until needed. See Figure 14.

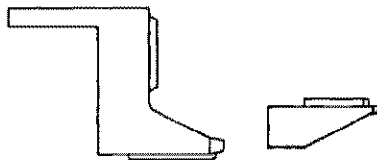

FIGURE 14

3. Slide out gray vinyl decorator strip located in the inset of the handle. See Figure 15.



FIGURE 15

## **CAUTION:**

To Avoid Personal Injury securely hold onto the door handles while removing screws.

4. **NOTE:** Screws are in at an angle — DO NOT scratch handle edge.

5. Remove screws retaining handle. See Figure 16. Handles will easily fall away. If you have a conventional model skip to step number 10. If you have a dispensing model proceed with step number 6.



FIGURE 16

6. Dispenser Trim parts are shipped separately and are located in the top crisper drawer in the refrigerator compartment. (Dispensing Models Only.)

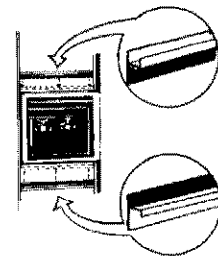

FIGURE 17

7. These trim pieces are designed to fit above AND below the dispenser and provide a groove for panel installation. See Figure 17. (Dispensing Models Only.)

8. To install the decorator trim gently slide the trim into the groove above the dispenser as shown in Figure 17. (Dispensing Models Only.)

9. To install the 2nd piece of trim below the dispenser follow the directions in step 8. See Figure 17 for placement. (Dispensing Models Only.)

## **CAUTION:**

To Avoid Property Damage take care not to tilt or start panel at an angle, to do so will cause panel to jam and may damage the trim.

# Door Panel and Dispenser Trim Installation Instruction (cont.)

- Gently insert the decorator panel into grooves and slide **EVENLY** until the panel is securely in place.
- To replace handles reverse the procedures above. Numbers 1 through 5.

## Decorator Doors

**Tools Needed** — Standard Straight Screwdriver and Tightly Fitted Gloves

The door fronts are to be decorated with panels to accent your kitchen decor. Models are equipped with metal door edge trim kits required to do this.

The basic  $\frac{1}{4}$ " trim kit is attached to the door edges and hold  $\frac{1}{4}$ "-thick panels. A  $\frac{3}{16}$ " filler such as cardboard is required for  $\frac{1}{16}$ " panel. Ask your Amana dealer about panel availability, or you may supply your own panels.

For your convenience the panel dimensions are listed below:

- SBI20  
 Freezer Door 14" x  $63\frac{1}{16}$ "  
 Refrigerator Door  $19\frac{5}{8}$ " x  $63\frac{1}{16}$ "  
 SBD20  
 Upper Freezer Door 14" x  $18\frac{3}{8}$ "  
 Lower Freezer Door 14" x  $31\frac{1}{16}$ "  
 Refrigerator Door  $19\frac{5}{8}$ " x  $63\frac{1}{16}$ "

## Dimensions

ICE 'N WATER SXS MODEL  
 (ALL DIMENSIONS IN INCHES)  
 †INCLUDES DOOR TRIM

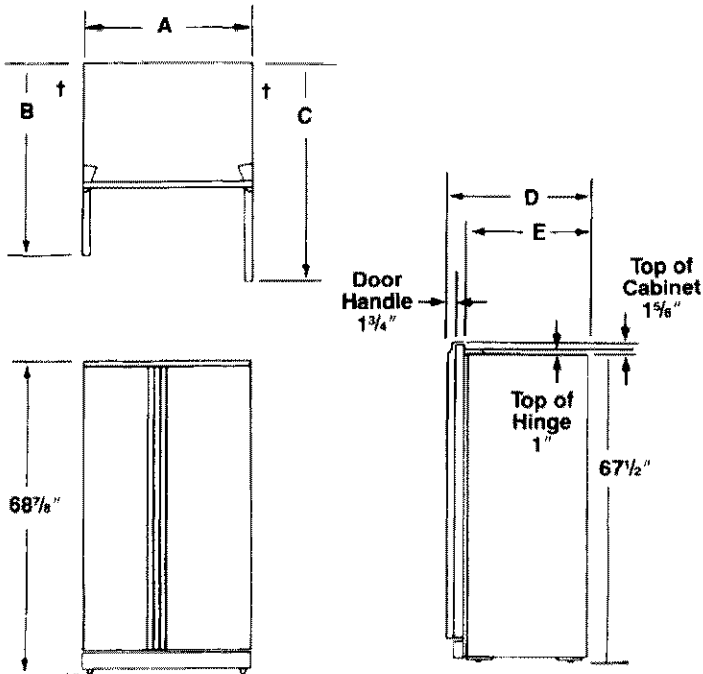

CONVENTIONAL SXS MODEL  
 †INCLUDES DOOR TRIM

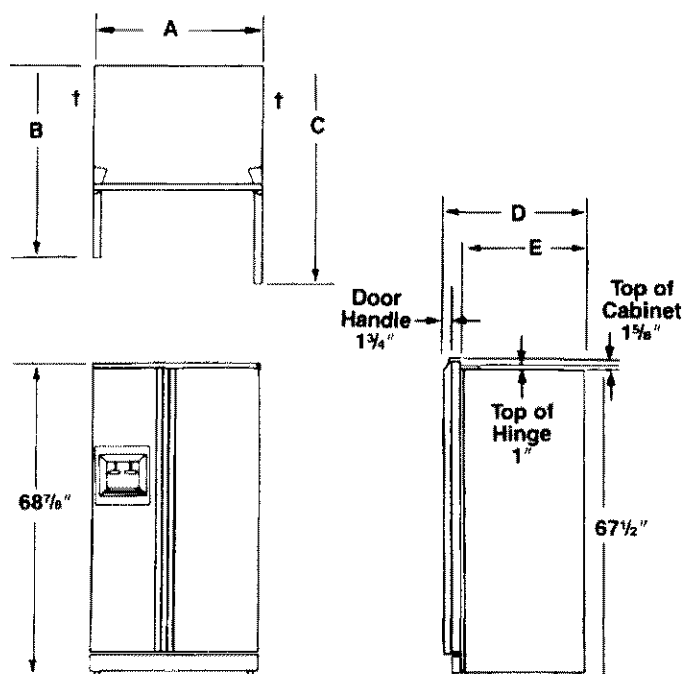

MODEL	"A" CABINET WIDTH	"B" FRZ DOOR OPEN 90°	"C" REF DOOR OPEN 90°	"D" OC* BACK TO HANDLE	"E" OC* BACK TO CAB FRONT
20	35"	39"	45"	27"	23"

\*Outer Case

†Must be installed  $1\frac{1}{4}$ " from side walls for 90° door opening.

# The Ice 'N Water Dispenser

## Connect the Ice 'N Water System To Cold Water Supply.

Refer to the instructions on the back of the cabinet.

### **CAUTION**

To avoid cross threading and water leaks, turn the water tube fittings by hand several times before tightening with wrenches. **DO NOT OVERTIGHTEN.** Also be sure to double check for water leaks after turning on the water pressure to the refrigerator.

## The automatic Ice 'N Water™ Dispensing Compartment

The Amana Ice 'N Water Dispensing Compartment will give you carefree use with minimal attention.

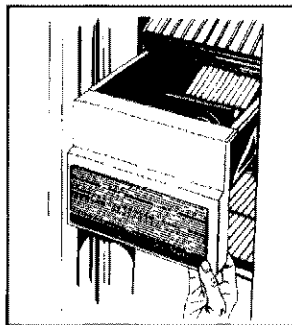

### **CAUTION:**

To Avoid the Possibility of Personal Injury, Never Attempt to Operate the Ice Dispenser with the Door Open.

Separate dispenser bars control the release of ice cubes and water. They are located in a recessed alcove for safety and convenience. The dispenser bars are sculptured to fit the contours of an ordinary drinking glass. Depress the appropriate dispenser bar to activate the dispensing mechanism.

Small spills will be caught in the sump area below the dispenser. The sump cover grille is easily removed for cleaning.

**NOTE: There is no drain in the sump so water should not purposely be poured into it.**

### **Automatic Nite Lite**

This is an optional feature that comes on automatically when it's dark. If you would prefer not to use the nite lite feature, there is an on/off switch just above the ice and water dispensing bars. Push this switch in once to turn off the nite lite.

### **Nite Lite Bulb Replacement**

Should the nite lite bulb ever need to be replaced, it is located just above the water dispenser bar. Replace with a 120 volt, 6 watt Sylvania 6S6 bulb or order from your Amana Service Dept., part number M0360001.

### **Do not add ice to ice bin.**

Do not try to speed ice dispensing by adding cubes of ice that you may have purchased or made in some other way. The unit has been "matched" to the automatic ice maker and will not operate properly with different shaped or sized cubes.

### **Water Dispenser**

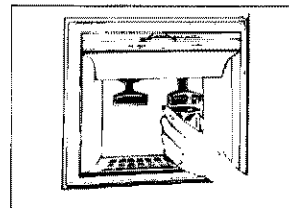

**To operate, press glass against the water dispenser bar. Releasing pressure shuts the water off.**

### **IMPORTANT**

After the unit is connected to an active household cold water line, it is advisable to fill and throw out the first 10-14 glasses of water. This will cleanse the lines of impurities.

### **Water taste and odor.**

There are many variables which can affect the taste and odor properties of the water that is being dispensed from your Amana Ice 'N Water model such as:

1. Iron and other mineral deposits normally found in water.
2. Type of tubing (copper, galvanized, plastic, etc.) used in the household water supply system as well as the type of tubing used to connect your unit to your household water supply.



# The Ice 'N Water Dispenser (cont.)

3. Is the water "fresh" or has it been left standing unused in the storage reservoir and/or water supply line for any length of time?

To minimize taste and odor problems, it is recommended that the following steps be taken:

1. Thoroughly rinse out the system after it has been connected to the household water supply. This can be accomplished by throwing away the first 10-14 eight-ounce glasses of water that are obtained from the unit.
2. If the water dispensing system is not used frequently, the entire water reservoir and system should be flushed. This will ensure a fresh supply of water at all times.

If the above suggestions do not entirely eliminate an undesirable taste or odor condition in your water, your problem is most likely a water problem. It is recommended that you contact your local water treatment company for its specialized kind of help in solving your problem.

## How The Water Dispenser Works

The water reservoir is located in the refrigerator behind the hi-humidity compartment or crisper pan, depending on the model you have. The water line to the dispenser bar is routed in a special way to prevent freeze-ups. The water dispensing lever energizes the water line solenoid to add water to the water reservoir.

The water is forced by household water pressure through the tubing and out the water dispenser.

This water is cooled in the water reservoir. Some water remains in the water line to the dispenser, causing the first glass of water to be somewhat warmer than the following glasses.

## Ice Dispenser

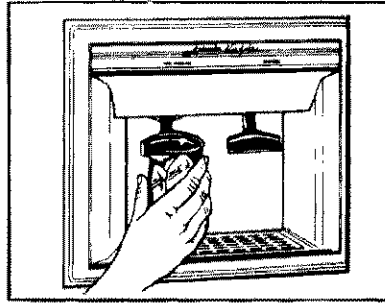

To operate apply pressure against the dispenser bar with a glass or activate other container. This activates the ice auger and ice wheel which automatically delivers ice to the glass.

**Release pressure on the dispenser bar before glass is full. Do not remove the glass until the last of the cubes fall.**

**Normal Operation.** Allow 4 to 12 hours after installation for the first ice harvest. The time required will depend on the freezer temperature and the amount of food in the unit.

The ice storage bin takes about three or four days to fill, depending on how often you use it. At first, your family will be using it quite frequently.

To help meet this demand, you can speed ice production by turning the freezer control to a colder setting.

**For best overall operation of the unit, be sure to return the freezer control to its previous position as soon as possible.**

**Overload.** If you hold the dispenser bar in the ON position for approximately 4-5 minutes, the dispenser motor may trip out on overload. This could occur if you were trying to fill a large container with ice. The overload will reset automatically in approximately 3 minutes, after which ice can again be dispensed.

**IMPORTANT! UNDER NO CIRCUMSTANCE SHOULD YOU USE AN ICE PICK OR SIMILAR SHARP INSTRUMENT TO BREAK THE ICE.** To do this could cause damage to the ice bin and/or ice auger.

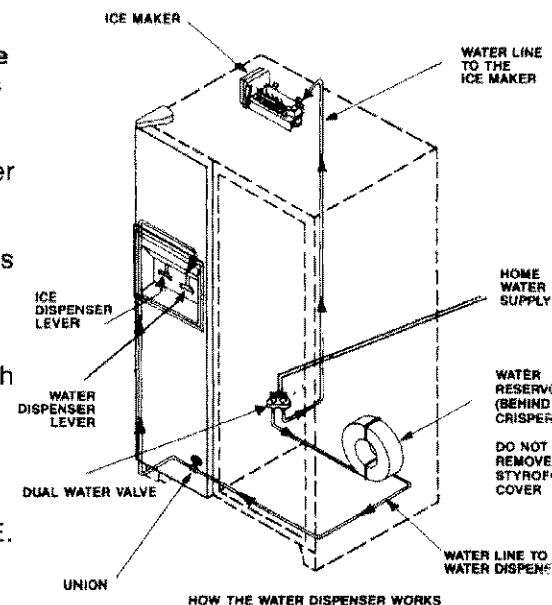

FIGURE :

# The Ice 'N Water Dispenser (cont.)

## How the Ice Dispenser Works

**Safety.** All the ice making and dispensing mechanisms are enclosed within their own compartment for safety and for maximum storage space in the freezer sections.

Whenever the freezer door is opened, the ice dispenser mechanism is interrupted. This prevents the dispensing of ice and also insures that you can service the ice bucket with complete safety.

Water is automatically measured into the ice maker. When the water freezes, a sensor initiates the ejector blades that dump the cubes into the U-shaped Harvester Bin, where they are held in storage for delivery. When you push the Dispenser Bar, a large auger gently, but firmly, moves cubes from the bin. See Figure 21.

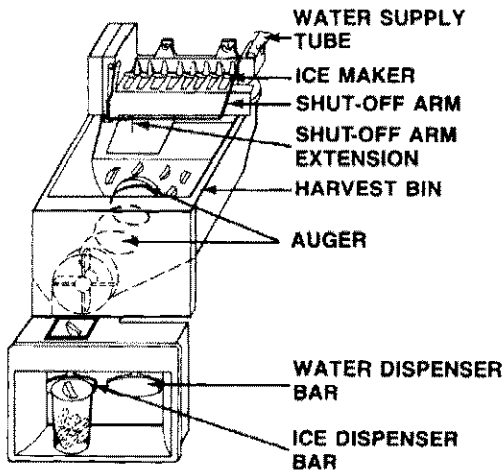

FIGURE 21

**You should remove the bin and empty the contents:**

### IMPORTANT

- After the first few harvests of ice have been made by a newly installed unit. **THIS IS ESSENTIAL.** It allows all impurities in the line to be flushed out before use.

- If you are going to be gone for longer than a week, empty the storage bin of all ice cubes and **raise** the ice maker control arm. This will prevent the cubes from freezing into a mass around the ice auger.
- If the ice cubes become frozen to each other and around the ice auger.
- If the ice cubes become frozen together on the back ledge of the ice bin, periodic cleaning of the ice bin may alleviate this occurrence. Clean with warm water and dry before replacing bin. Do not use an ice pick to break apart ice.

**Ice maker control arm.** The wire control arm on the automatic ice maker has 2 functions:

1. **Normal Operation:** the wire arm is in the down position; ice will be made. As the bin fills the arm will raise. Ice production will automatically stop when the bin is full. See Figure 22.

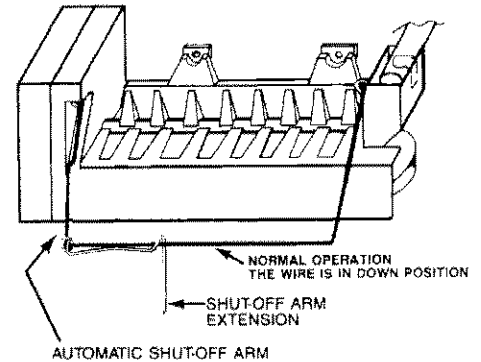

FIGURE 22

2. **To stop ice production or to remove the ice bin:** Take hold of wire arm near black housing, and lift up. There will be an audible "click" when ice maker shuts off. The wire arm stays in the upper position. See Figure 23. As long as the arm is in this position, ice will not be made. The unit will continue to dispense cubes from the ice bin until all have been used.

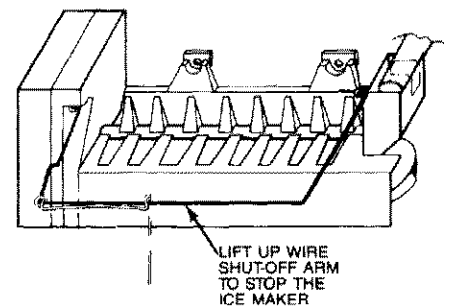
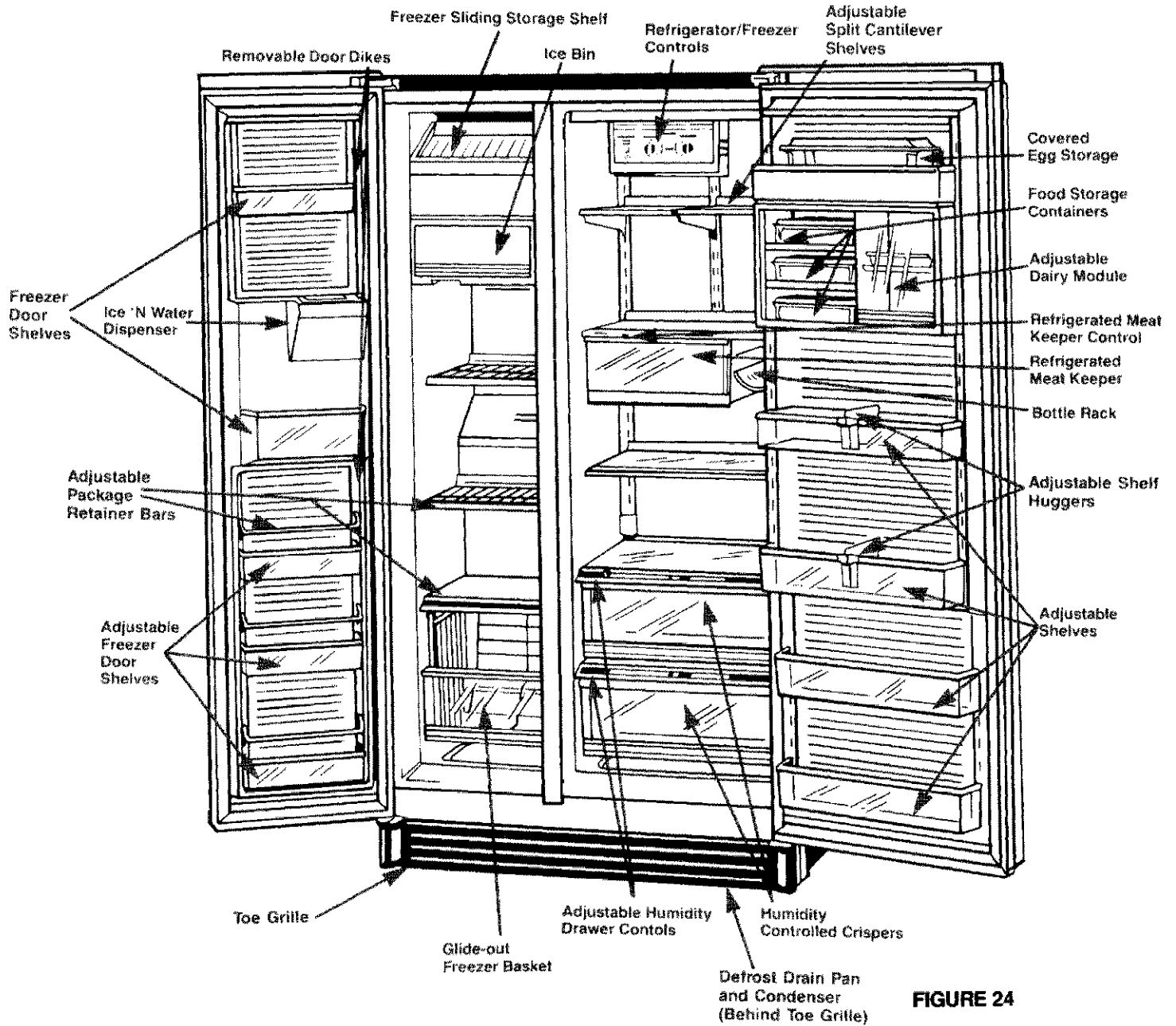

FIGURE 23

**To remove ice bin assembly:** Lift up the ice bin assembly 1/4", then pull out.

# General Features



**FIGURE 24**

**IMPORTANT NOTE:** Features may vary from model to model. Your refrigerator may not have all of the features shown.

# Setting the Controls

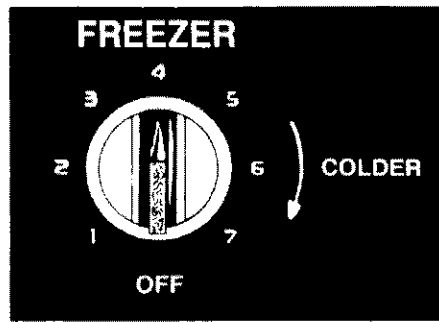

FIGURE 25

## Freezer Control

This is the main control. If it is turned OFF, neither the Freezer nor the Refrigerator will cool. All of the

electrical circuits remain energized except for the compressor and fan motors. The control has seven settings, from "1" (the warmest) to "7" (the coldest). Start by setting the dial on "4". Load food in freezer. Allow 24 hours for the freezer to cool after the unit is installed, before checking food temperatures.

Check Food temperature as instructed on page 12. **Adjust the control as needed one number at a time.** The best temperature for frozen food storage is in the 0° to +2°F range.

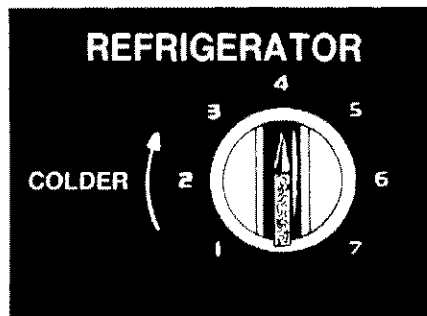

FIGURE 26

## Temp-Asure™ Thermostatic Refrigerator Control

This control, located on the upper back wall of the fresh food section operates independently of the freezer control. A hidden thermostatic sensor

measures refrigerator air temperature constantly, and automatically lets in more cold air if temperature rises as little as 1½°F from your setting.

The control has seven settings, from "1" (the warmest) to "7" (the coldest). The best food storage temperature is in the 38° to 40°F range. Start by setting the dial on 4. Load food in the refrigerator. Place a glass of water in the middle of the refrigerator section, making sure that air can flow around it. (This will be used later to check food temperature.)

After the unit is installed, allow 24 hours for the refrigerator to cool. Check food temperature as instructed on the next page. Adjust the control as needed, one number at a time.

## Checking Food Temperature

Twenty-four hours after the unit is installed, check the food temperature in the refrigerator and freezer sections. Use a quality thermometer that can register below zero temperatures.

**FREEZER:** Place the thermometer in the center of the freezer, surrounded by frozen packages. See Figure 27. Wait 5 to 8 hours, then check the reading. If temperature is not within 0° to

+2°F, adjust control as needed, one number at a time and check temperature again after 4 to 6 hours.

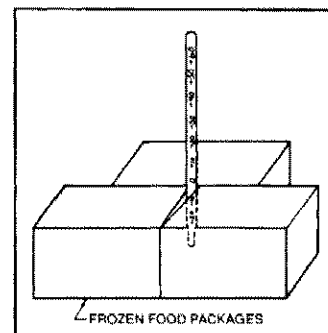

FIGURE 27

## Setting the Controls (cont.)

**REFRIGERATOR:** Place the thermometer in a glass of water and place the glass in the middle of the refrigerator section. See Figure 28. Be sure air can flow around it. Wait 3 to 4 hours, check the temperature and adjust the control as needed one number at a time to achieve the 38° to 40°F range. Wait 3 to 4 hours and check the temperature again.

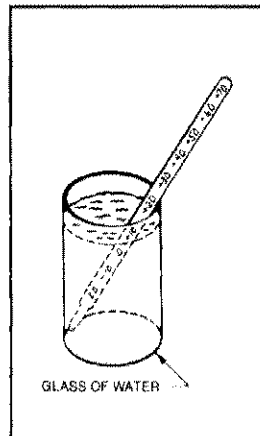

FIGURE 28

### Energy Saver Control

The 2-Position Energy Saver Control lets you save energy by adjusting refrigerator operation to the humidity level in your house. During hot, humid weather, any refrigerator/freezer will have moisture form around the doors, similar to the way condensate forms on a glass of ice water. The cabinet has special heaters to minimize this condensation. The Energy Saver Control lets you turn these heaters on or off.

The upper position is for periods of high humidity.

The lower position turns the heater off for maximum energy savings,

used for periods of low humidity. A minimum amount of condensation is normal. During extreme high humidity, condensate may also form on the cabinet sides and doors. This is normal and will disappear when climatic conditions return to normal.



FIGURE 29

## Refrigerator Features

### Refrigerated Meat Keeper Control

The Refrigerated Meat Keeper features a drawer inside a wrapper or sleeve. A control, located in the front trim, allows you to adjust the amount of freezer air that circulates between the drawer and sleeve to keep meat extra fresh without drying it out. Slide the control to the left for the coldest temperatures and to the right for warmer temperatures. The additional cold air can affect the refrigerator compartment tempera-

ture, so the Temp-Asure™ thermostatic control may require adjustment after the Meat Keeper temperature has been set.

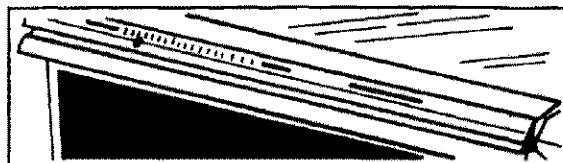

FIGURE 30

## Refrigerator Features (cont.)

**Adjustable Cantilever Glass Shelves.** These shelves attach to metal tracks in the back of the interior. See Figure 31. To remove, tap upwards at rear of shelf hooks. Lift shelf and pull out. To install, tilt shelf and engage upper hooks in desired track slots. Lower shelf front and tap downwards near the tracks until shelf hooks are securely seated and shelf is level.

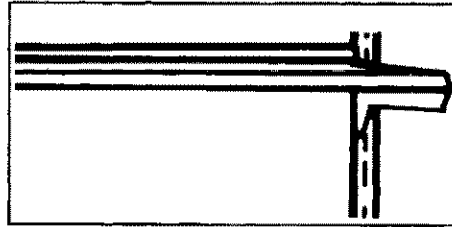

FIGURE 31

### CAUTION

To Avoid Personal Injury Or Property Damage test for proper installation by exerting light pressure downward on the front edge. Shelf should not move.

### To Adjust the Refrigerated Meat Storage Drawer

The Refrigerated Meat Keeper must be installed with its cold air supply tube covering the air inlet port completely. To ensure proper alignment, only insert the upper hooks of the shelf into the 9th, 10th, 11th or 12th track slots from the top. See Figure 32. Otherwise, food will freeze below the uncovered air supply hole, located in the back left side wall.

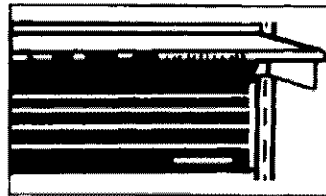

FIGURE 32

### Humidity Controlled Crisper Drawers

These drawers are for storage of fresh fruits and vegetables. It is normal for moisture to accumulate inside. See Figure 33.

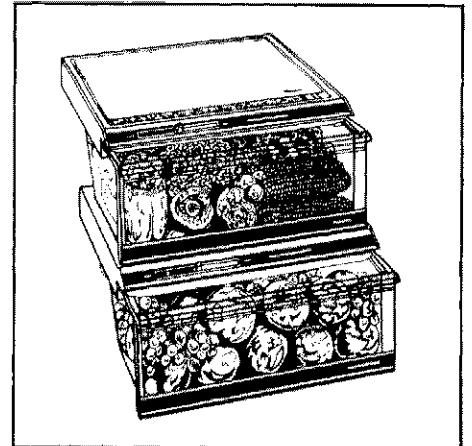

FIGURE 33

Crisper Drawers can be pulled out fully, even when door is opened at a minimum of 90° angle.

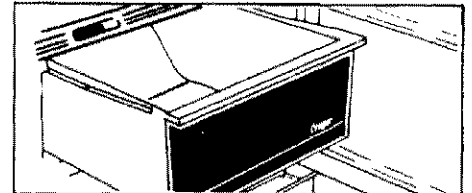

FIGURE 34

**Hi-Humidity Drawers** have a control to regulate humidity inside. Set high humidity for leafy vegetables such as cabbage and lettuce, and set low humidity for produce with skins such as apples and tomatoes. Slide to the left for high humidity and to the right for low humidity. See Figure 35.

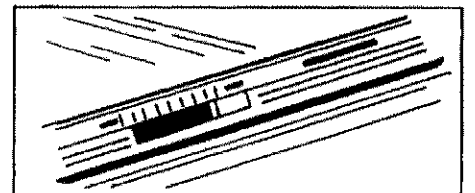

FIGURE 35

# Refrigerator Features (cont.)

## Stor-Mor® Door

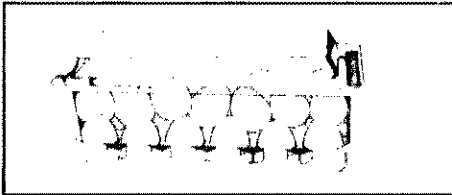

FIGURE 36

**Egg Storage.** A removable take-to-counter egg bucket, stores eggs in a see-thru covered container. See Figure 36. To clean, hand wash in warm, soapy water.

**Dairy Storage.** Store butter and cheese in an adjustable dairy module complete with top door full length shelf, two dairy compartments with sliding door and three food storage containers. See Figure 37.

(Note: When washing butter dish, place dish on top rack of dishwasher.)

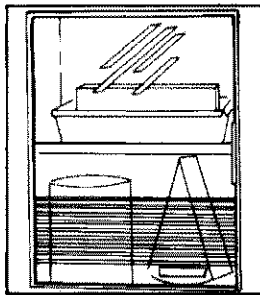

FIGURE 37



FIGURE 38

**Food Storage Containers.** Some models feature three durable leftover containers. See Figure 38.

They store conveniently in this compartment and slide out for easy access. Containers are microwave\* and dishwasher safe. (Always place in the top rack of dishwasher.) **Note:** If

containers should stain, follow manufacturer's instructions for cleaning.

\*Note: Be sure to follow manufacturer's instructions located in the containers when using containers to reheat foods in a microwave oven.

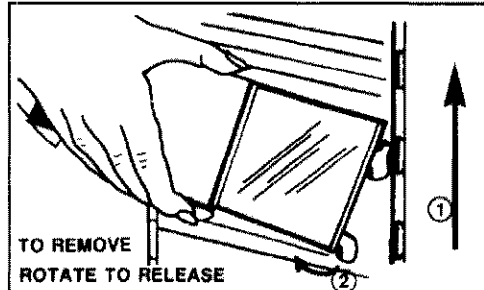

FIGURE 39

**Door Shelves.** Door shelves can be moved up or down to fit storage needs. See Figure 39. To remove, loosen shelf by tapping upwards gently underneath both ends. ① Lift shelf slightly. Rotate bottom out and up to release mounting hooks from door slots. To install, tilt shelf and insert upper hooks into any two door slots as shown. ② Rotate shelf bottom towards door and insert bottom hooks into door slots. Hold shelf against door and tap down gently on both ends until shelf is seated securely.

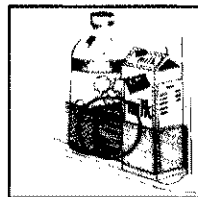

FIGURE 40

**Huggers.** Feature two handy shelf huggers that slide back and forth along door shelves. See Figure 40.

## Freezer Features

### Removable Door Dike

Designed for kitchens when space limitations restrict opening of door to 90°. The removable door dike (closest to hinge) will snap out to allow removal of freezer basket and ice bucket. Simply grasp door dike with both hands and firmly snap door dike out. To replace door dike align the four push clips to the holes on the freezer door. Snap in until the door dike is locked into place. See Figure 41.



FIGURE 41

## Freezer Features (cont.)

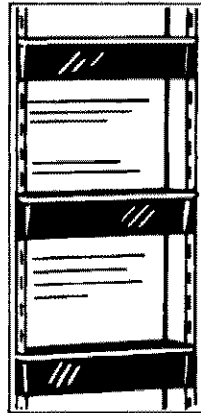

FIGURE 42

### Freezer Door

The freezer door has six adjustable shelves (some models). To remove, gently tap both ends up, then pull out. See Figure 42.

### Automatic Ice 'N Water Dispenser

See instructions beginning on page 8.

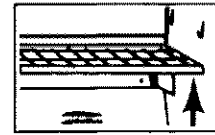

FIGURE 43

### Adjustable Freezer Shelves

1. To remove, tap shelf gently from the right side and slide out.
2. Reverse procedure to install.

### Large Glide-out Freezer Basket

Stores odd-shaped, bulky food items.

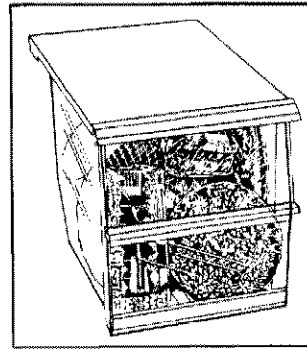

FIGURE 44

## Other Features

### Automatic Free-O'-Frost™

#### Operation

The freezer and refrigerator sections are completely frost-free. The Amana Frost-Magnet® evaporator coil in the back wall stops frost before it starts. Under normal operating conditions, you'll never have to defrost the unit, because it's automatic.

### Air Circulation

Air to cool the condenser is drawn in the grille, at the bottom front, passes over the condenser, and is then exhausted through the same grille. Therefore, the unit is designed to be enclosed completely at the top, back and sides for the total built-in look. Do not block airflow through the toe grille at bottom front of unit.

### Bottle Rack

This rack hangs from a shelf and holds a large bottle within easy reach. It is shipped inside a crisper drawer. See Figure 45. To install, hook tabs on flat portion of rack over the side metal frame of any shelf. The shelf may have to be tilted up or removed temporarily. Be sure bottle cap is on tightly before placing a bottle in the rack.

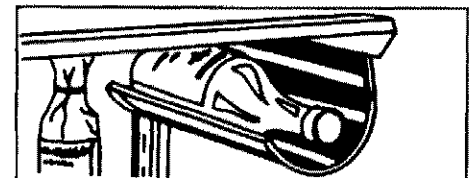

FIGURE 45



## Other Features (cont.)

### Automatic Ice Maker

An automatic ice maker is factory installed. See Figure 46.

Allow 4 to 12 hours before the first ice harvest occurs. The time required will depend on the freezer temperature setting and on the amount of food in the unit. The ice maker automatically

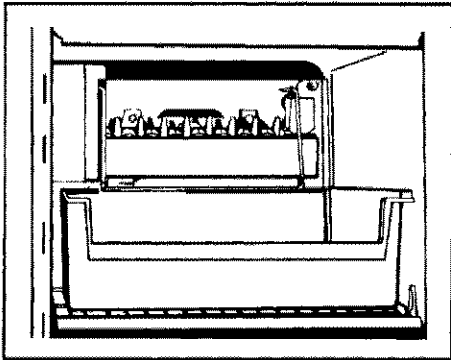

FIGURE 46

fills itself with water and empties ice into the bin. A wire arm senses the amount of ice and turns the icemaker off when the bin is full.

**To start ice production:** Install the ice bin and lower the wire arm. The ice bin must be all the way back to operate.

**To stop ice production:** Raise the wire arm until it locks. (NOTE:

As long as the arm is raised, the ice maker will not operate.)

#### IMPORTANT

Discard the first several ice harvests so any impurities flushed through the water line or ice maker will not be consumed.

Ice cubes are porous and will absorb food odors, so be sure to keep foods covered in the freezer and refrigerator sections. (See "Before Calling For Service" on page 22.)

Cold, dry air circulates through the entire refrigerator/freezer to maintain safe storage temperatures. After several weeks, this air movement can cause cubes stored open in the bin to evaporate and stick together.



#### CAUTION

**To guard against possible water damage.** If the refrigerator will be unattended, raise the ice maker wire shut off arm and turn the water shut off valve for the refrigerator to OFF.

\* If you should choose to install the optional ice maker, please follow the provided instructions and use only Amana parts.

## You Can Help Save Energy!

Your New Amana Stor-Mor® Refrigerator/Freezer is designed to operate efficiently. You can help reduce energy consumption by following these suggestions:

**Energy Saver Control.** This control regulates special heaters that help reduce condensation during periods of high humidity. Reduce energy consumption by setting the control according to current climatic conditions.

**Refrigerated Meat Keeper.** Adjust the control to obtain the best storage conditions for highly perishable food items.

**Keep Freezer Section Full.** The unit operates more economically

when the freezer is filled to capacity, but not overfilled. A full freezer helps maintain frozen temperatures when the door is opened.

**Controls.** Set the freezer and refrigerator controls so the compartments are not colder than recommended. See page 12 for details.

**Doors.** Make sure the door gaskets do not become blocked, dirty or worn. Air leaks will cause the unit to operate more often.

**Location.** Install the unit away from heating equipment or direct sunlight.

**Keep the Condenser Coil Clean.** A dirty condenser coil will cause the unit to operate more than necessary. (See page 19.)

## Care & Cleaning

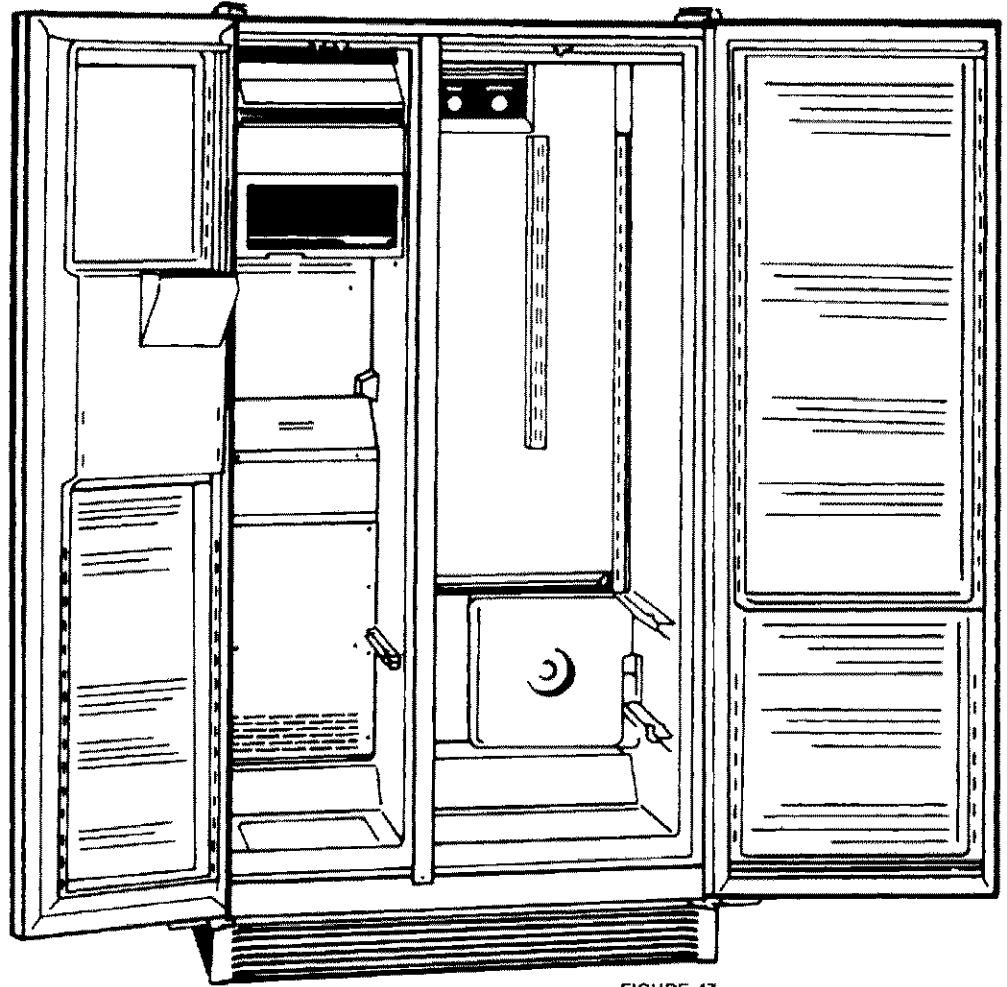

FIGURE 47

### **CAUTION:**

To Avoid The Risk Of Personal Injury use caution in unpacking, handling, removing, installing and cleaning all parts of product which may have sharp edges.

### **CAUTION:**

To Avoid The Risk Of Personal Injury wear protective hand covering.

### **WARNING:**

To Avoid The Risk Of Electrical Shock Or Death unplug the power cord before replacing a burned out light bulb or before cleaning.

Remove all food and special compartments from the freezer and refrigerator sections. See Figure 47.

**Exterior.** Wash with warm, soapy water, rinse and dry. Use appliance polish or wax periodically to keep the exterior looking like new.

**Door Gaskets.** Clean at least twice a year with mild soap and water. Rinse and dry. Apply a light film of petroleum jelly to the gaskets on the hinge side to keep them soft and pliable.

**Interior.** Wash the liner with warm, soapy water. Rinse and dry. Interior components such as shelves and drawers may be washed with 4 tablespoons baking soda dissolved in 1 quart of warm water to "sweeten" these parts. Rinse and dry thoroughly.

**Interior and Exterior.** DO NOT USE abrasive, heavy-duty powders such as AJAX cleanser, COMET cleanser, etc. when cleaning the interior or exterior of the refrigerator.

These can scratch and dull the surface, depending on their abrasiveness and the cleaning pressure applied. Avoid metal pads and abrasive impregnated plastic, nylon and cloth pads such as CHORE-BOY® and KURLY KATE® pot cleaners, BRILLO® metal cleaning pads, SCOTCH-BRITE® AND PADDY® soap pads, etc. These can scratch the baked enamel exterior and interior surfaces.

## Care and Cleaning (cont.)

---

**Do not use** concentrated liquid dishwashing detergent (dissolve in warm water before using), abrasive cleaners, solvents or polishing agents on plastic parts. These cleansers may cause cracking or discoloration.

**Do not wash** plastic parts in an automatic dishwasher. They may warp. (The butter dish and food storage containers can be washed in a dishwasher. See page 15 for details.)

**Ice Maker.** If your water has a high mineral content, the ice maker may require periodic cleaning. Cleaning with vinegar should remove most of the build-up. Contact your dealer for assistance with ice maker removal, cleaning and reinstallation. An in-line water filter may also be necessary.

**Clean Defrost Drain Pan.** The pan is located underneath the unit behind the toe grille. Every three months, remove the drain pan, wash it with warm soapy water, rinse and dry. When replacing the pan, make sure it is directly underneath the defrost water tube that extends from the back of the unit. Pull the toe grille forward to remove.

**Clean Condenser Coil.** The condenser coil is located behind the toe grille. Use a long-handled bottle brush and a vacuum cleaner to remove dust and lint from the coil. A suitable brush can be purchased from your Amana dealer. Dust and lint act as an insulator and prevent the coil from expelling heat taken from inside the unit. Failure to keep the coil clean will reduce cooling performance and efficiency.

**Reconnect Power Cord.** After cleaning, reconnect the power cord.

**Odors.** If an offensive odor appears to be lingering in the refrigerator or freezer, the following procedures may eliminate the problem. Always begin with Method I. Use Method II and III only if the odor persists.

### Method I

1. Unplug the Unit
2. Remove all food
3. Thoroughly wash the inside of the unit, including all shelves, drawers, accessories and gaskets with a mixture of 4 tablespoons of baking soda dissolved in 1 quart of warm water. Pay special attention to any corners, crevices or grooves into which odor-causing liquid may have seeped. Dry thoroughly.
4. Return food to unit washing off all bottles, jars and containers before placing them into the refrigerator and freezer.
5. Plug in the unit. Wait 24 hours before checking to see if the odor has been eliminated. If the odor is still present, proceed with Method II.

### Method II

1. Unplug the unit.
2. Remove all food, making arrangements for other food storage. (The inside of the unit should already have been washed as instructed in Method I.)
3. Place crisper drawers on the top shelf of the refrigerator section.
4. Lightly crumple single sheets of newspaper. Loosely pack and fill entire refrigerator and freezer interior with newspapers including door shelves, drawers and compartments.
5. Randomly place charcoal briquettes throughout both compartments on the crumpled newspaper.
6. Close the doors and let stand for 24 to 48 hours.
7. Remove the charcoal briquettes and newspapers. Wash and dry the inside of the unit as described in Method I.
8. Plug in the unit. Wait for 24 hours before checking to see if the odor has been eliminated then replace the food. If the odor persists, proceed with Method III.

### Method III

Order Delta Foremost's Original Country Club Cherry (a commercial neutralizing aerosol) from your nearest Amana authorized service center (Part number R1831-6). Use according to instructions packaged with the aerosol. Remember to unplug the unit before beginning.

## Non-Use Periods

**Vacation Time.** If you will be away for vacation, remove perishable foods from the unit. Shut off the ice maker by turning off the water supply to the refrigerator and moving the icemaker wire arm to its uppermost position.

**Extended periods of non-use.** If you are going to be away for longer periods, empty and unplug the unit. This will reduce needless operation and assure that food will not be spoiled if electrical service is interrupted. Just clean the unit as instructed in this manual and prop open the doors so air can circulate inside. Leave the unit unplugged. If the refrigerator has an automatic icemaker, turn off the water supply to the refrigerator.

**When You Move.** Unplug the unit and clean it. Use strapping tape or masking tape to secure all trays, shelves and other parts to prevent damage during shipment. Do not leave the unit closed for an extended period of time.



### CAUTION:

To Avoid Property Damage do NOT use tape that has "permanent" type adhesive.

### If The Refrigerator Will Be Stored.

If the refrigerator will be stored or remain unused in a sub-freezing environment, remove the water and protect the water valve from damage as follows:

1. Disconnect the refrigerator from the electrical power source.
2. Shut off the refrigerator water supply. This can be done at the saddle valve with the 1/4" copper

supply tubing joins the household water line. For factory installed ice makers, refer to illustration on back of cabinet. For all other ice makers, refer to installation instructions.

3. Remove the compressor compartment cover from the bottom rear of the refrigerator to reveal the water valve coupling. Place a small container under the valve to catch water spills. Remove the brass hose fitting from the valve. Label the two plastic tubes attached to the valve. Unscrew the compression nut(s) from the tube(s) and push the end(s) of the tube(s) away from their valve fitting(s). See Figure 48.

### TYPICAL WATER VALVE COUPLING

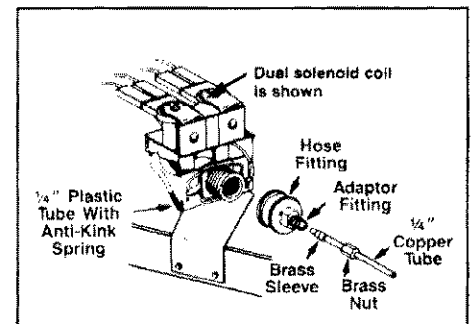
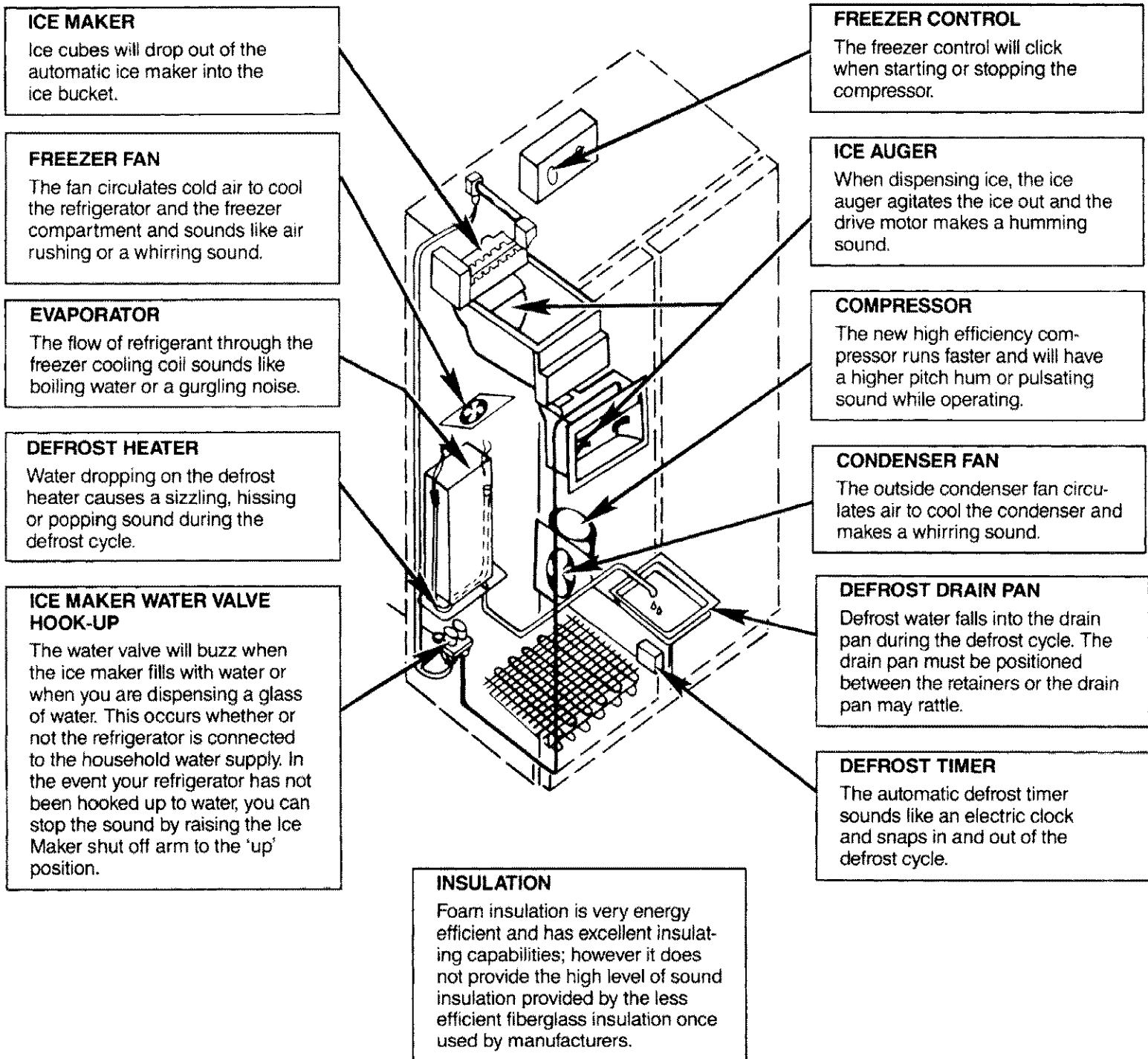

FIGURE 48

4. Blow the water out of the water dispenser plastic tubing with compressed air.

# Normal Operating Sounds of Today's Modern Refrigerators

Your new refrigerator may be replacing a smaller refrigerator of different design and/or a product which operated less efficiently. Steps have been taken in product design and operation of today's modern refrigerators which continue to provide the highest quality product, one which is energy efficient and operates as economically as possible. With this new design, you may hear sounds which are unfamiliar to you, yet quite normal and do **NOT** require a service call.



None of these sounds are unusual and will soon become familiar. They indicate the unit is operating and performing as designed.

## Before Calling For Service

Unnecessary service calls may be avoided by checking for the following common sources of difficulty. You will be charged for a serviceman's travel expenses and labor, even though the product may be in warranty, if the difficulty is not caused by *workmanship* or *material*, or if the component is *customer replaceable*. The following items are considered customer replaceable: defrost drain pan, door and cabinet shelves and drawers, butter dish, ice trays, light bulbs, egg bucket, huggers and accessories.

**Your refrigerator/freezer is designed for operation in a conditioned environment. For best performance your refrigerator should not be installed where surrounding temperatures will be lower than 55 degrees F. The compressor will not run frequently enough to maintain proper temperature. Operation in surrounding temperatures below 32 degree F. will result in defrosting problems and is not recommended for self defrosting products.**

**If product does not appear to be operating:**

- Does the light work? A dim light indicates low voltage or a weak bulb.
- Is the cord plugged in?
- Is a fuse or circuit breaker open? Check by plugging in another appliance or lamp at the same wall outlet.
- Has either of the doors been left open? Make certain food items stored within the refrigerator are not obstructing proper door closure. Check leveling of unit. (See page 5.)
- If the lights work and the freezer control is on, but the fan and compressor are not operating, the unit is likely in the defrost cycle. Wait 30 minutes to see if the unit will restart. If it does not, remove the toe grille. The defrost timer is located behind the grille. Turn the timer knob clockwise until you hear a click. The refrigerator should begin running.

**If the unit still won't operate:**

- Be sure you have completed the steps listed above.
- Take the steps necessary to preserve the food stored in the unit. Dry ice may be placed in the freezer section of the unit to preserve food until the unit can be serviced. Doors should be left closed until the unit has been repaired. Your product warranty does not cover food loss.
- Call your nearest Amana dealer or authorized service center listed in the Yellow pages.

**If food temperature appears to be warm:**

- See prior sections.
- Have you recently added a large load of food? Allow adequate time for the food to reach freezing temperature.
- Are any shelves covered with foil or plastic, preventing proper air flow?
- Is the condenser area clean? (See page 19.)
- Adjust freezer control. (See page 12.)

**If refrigerator section is too warm:**

- See prior sections.
- Adjust Temp-Assure refrigerator control. (See page 12.)

**If the Refrigerated Meat**

**Keeper is too warm:**

- Is Meat Keeper inlet tube in place with the control outlet tube on the side wall?
- Slide Meat Keeper control to colder setting.
- Adjust freezer control to colder setting.

**If refrigerator food temperature is too cold:**

- Check Refrigerator Meat Keeper drawer assembly to see that outlet tube is in proper place over the inlet hole on side wall. If it is not properly connected, freezer air will spill into the refrigerator section. (See page 14.)
- Is condenser area clean? (See page 19.)
- Are any shelves covered with foil or plastic, preventing proper air flow?

## **Before Calling For Service (cont.)**

---

- Adjust Temp-Assure refrigerator control. (See page 12.)
- Adjust freezer control to warmer setting. Allow several hours for temperature to change.

### **If the unit runs too much or too frequently:**

- It may be normal to maintain an even temperature.
- Is condenser area clean? (See page 19.)
- Have doors been opened frequently or for an extended period of time?
- Is freezer running too cold? Adjust freezer control. (See page 12.)
- Check door alignment and gasket seal for proper closure.

### **If the unit makes unfamiliar sounds such as popping or cracking; tapping, gurgling, boiling or bubbling; rumbling or rattling on shutdown:**

- These may be normal operating sounds. Refer to page 17 for information on sounds the unit may make.

### **If you hear running water in the unit:**

- This is normal when the icemaker fills.
- This is normal when the unit defrosts and water enters the condensate pan.

### **If you hear periodic buzzing:**

- This is normal in cabinets with an automatic icemaker. The water valve will buzz when energized to refill the icemaker.

### **If condensate forms on the inside of the unit:**

- This is highly normal during periods of high humidity.

### **If condensate forms on the outside of the unit:**

- Is Energy Saver Control on highest setting? This will help reduce condensate.
- Check door alignment and gasket seal for proper closure.

### **If Crisper or Meat Keeper drawers do not close freely:**

- Check for package obstructing proper closure.
- Check to confirm drawer is in proper position in assembly.

- Apply thin layer of petroleum jelly to slide channels.
- Make sure refrigerator is level.

### **If there is an odor in the unit or ice cubes:**

- Clean product. (See page 19.)
- Cover all foods tightly.
- Use freezer containers or freezer wrap.

### **If ice forms in the inlet tube to the ice maker:**

- Indicates sediment in solenoid valve which has not allowed the valve to close. An in-line water filter should be added. If problem persists the solenoid valve will need to be cleaned or changed.

### **If the Automatic Ice Maker does not produce ice:**

- Check for ice cubes obstructing the shut-off arm.
- Check to make sure shut-off arm is in the 'down' position.

### **IF LIGHT BULB NEEDS REPLACING:**

- Unplug unit from wall outlet to avoid electrical shock. A pair of gloves should be worn as a precaution against broken glass.

#### **Refrigerator Compartment**

1. Unscrew the light bulb(s) located on the front upper wall of the refrigerator compartment by turning counterclockwise.
2. Replace with a G.E. or Westinghouse #40A15/1, Sylvania #40A15 or order from your Amana Service Dept., part number A0282803.

#### **Freezer Compartment (Ice 'N Water Model)**

To remove the light bulb located on the right wall of the cavity, directly below the ice bucket of the upper freezer compartment, follow the directions below:

1. Remove the ice maker drawer.
2. Remove the protective shield by unscrewing the nut with a ¼" drive or socket wrench.
3. Unscrew the light bulb counterclockwise.
4. Replace with a G.E. or Westinghouse #40A15/1, Sylvania #40A15 or order from your Amana Service Dept., part number A0282803.

## Before Calling For Service (cont.)

### Freezer Compartment (Conventional Model)

To remove the light bulb located on the front upper wall of the refrigerator compartment by turning counterclockwise.

1. Unscrew the light.
2. Replace with a G.E. or Westinghouse #40A15/1, Sylvania, #40A15 or order from your Amana Service Dept., part number A0282803.

### Dispenser Light Bulb (Ice 'N Water Model)

Should the light bulb ever need to be replaced, it is located just above the water dispenser bar.

1. Unscrew the bulb counterclockwise.
2. Replace with a 120 volt, 6 watt Sylvania 6S6 bulb or order from your Amana Service Dept., part number M0360001.

**Amana**  
**Asure**  
EXTENDED SERVICE PLAN

### Rest assured against unexpected repair bills!

Amana is pleased to offer an important opportunity for long-term service protection on your new Amana appliance. The Amana Asure Extended Service Plan is specially designed to supplement the strong warranty that already accompanies your appliance, and it combines with this standard warranty to provide budget-protecting coverage on your appliance for up to five full

years, covering parts, labor and travel charges.

Your participating Amana dealer has details. Or contact us:

**Amana Refrigeration, Inc.**  
**Customer Service Department**  
**Amana, IA 52204**  
**(319) 622-5511**  
**Monday through Friday**  
**(8 a.m. - 4:30 p.m., C.S.T.)**

1-800-843-0304

---



TOLL-FREE

Amana.

---

Information on product usage, installation, warranty and dealer/service can be obtained through the toll free number.