

**SAMSUNG**

MICRO COMPONENT  
SYSTEM  
CD-R/RW PLAYBACK  
MM-J4

**Instruction Manual**



# Safety Warnings

GB

**CLASS 1 LASER PRODUCT**  
**KLASSE 1 LASER PRODUKT**  
**LUOKAN 1 LASER LAITE**  
**KLASS 1 LASER APPARAT**  
**PRODUCTO LASER CLASE 1**

## **CLASS 1 LASER PRODUCT**

This Compact Disc player is classified as a CLASS 1 LASER product.

Use of controls adjustments or performance of procedures other than those specified herein may result in hazardous radiation exposure.

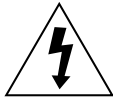

### **CAUTION**

**RISK OF ELECTRIC SHOCK.**  
**DO NOT OPEN**



## **CAUTION-INVISIBLE LASER RADIATION WHEN OPEN AND INTER LOCKS DEFEATED, AVOID EXPOSURE TO BEAM.**

### **CAUTION:**

TO REDUCE THE RISK OF ELECTRIC SHOCK,  
DO NOT REMOVE REAR COVER.  
NO USER SERVICEABLE PARTS INSIDE.  
REFER SERVICING TO QUALIFIED SERVICE  
PERSONNEL.

**WARNING:** TO REDUCE THE RISK OF FIRE OR  
ELECTRIC SHOCK, DO NOT EXPOSE  
THIS APPLIANCE TO RAIN OR MOIS-  
TURE.

**CAUTION:** TO PREVENT ELECTRIC SHOCK,  
MATCH WIDE BLADE OF PLUG TO  
WIDE SLOT, FULLY INSERT.

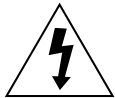

This symbol indicates that dangerous voltage which can cause electric shock is present inside this unit.



This symbol alerts you to important operating and maintenance instructions accompanying the unit.

# Contents

Thank you for buying this  
SAMSUNG micro-component system.

Please take time to read these instructions.  
They will allow you to operate your  
system with ease and take full advantage  
of its features.

GB

◆ SAFETY WARNINGS .....	2
◆ INSTALLING YOUR MICRO-COMPONENT SYSTEM	
■ Front Panel View .....	4
■ Remote Control .....	5
■ Rear Panel View .....	6
■ Where to install your Micro-Component System.....	7
■ Connecting your System to the Power Supply .....	7
■ Inserting Remote Control Batteries .....	7
■ Connecting to an External Source .....	8
■ Speaker Connection .....	8
■ Connecting the AM (MW)/LW Aerial .....	9
■ Connecting the FM Aerial .....	9
■ Connecting the SW Aerial(option) .....	9
■ Setting the Clock .....	10
◆ CD-PLAYER	
■ Listening to a Compact Disc .....	10
■ Selecting a Track.....	10
■ Searching for a Specific Music Passage on a CD .....	10
■ CD Repeat Function .....	11
■ Shuffle Play Function .....	11
■ Programming the Order of Playback .....	11
■ Regarding the playback of CD-R/RW .....	11
■ Checking or Changing Programmed Tracks .....	12
■ Function to skip through 10 tracks at a time .....	12
◆ TUNER	
■ Searching for and Storing the Radio Stations.....	12
■ Selecting a Stored Station.....	13
■ Improving Radio Reception .....	13
◆ TAPE DECK	
■ Listening to a Cassette .....	14
■ Recording a Compact Disc .....	14
■ Recording a Radio Program .....	14
■ Selecting the Cassette Playback Mode .....	15
■ Tape Counter.....	15
■ Repeat A ↔ B Function .....	15
◆ OTHER FUNCTIONS	
■ Timer Function .....	16
■ Cancelling the Timer .....	16
■ Power Sound Function .....	17
■ EQ/S.BASS (Super Bass) Function .....	17
■ Sleep Timer.....	18
■ MUTE Function.....	18
■ Connecting Headphones .....	18
■ Microphone Function(option) .....	18
◆ RECOMMENDATIONS FOR USE	
■ Safety Precautions.....	19
■ Cleaning your Micro-Component System.....	19
■ Precautions When Using Compact Discs .....	20
■ Precautions When Using Audio Cassettes .....	20
■ Before Contacting the After-Sales Service .....	20
■ Technical Specifications .....	21

## Symbols



Press



Push



Important



Note

# Front Panel View

GB

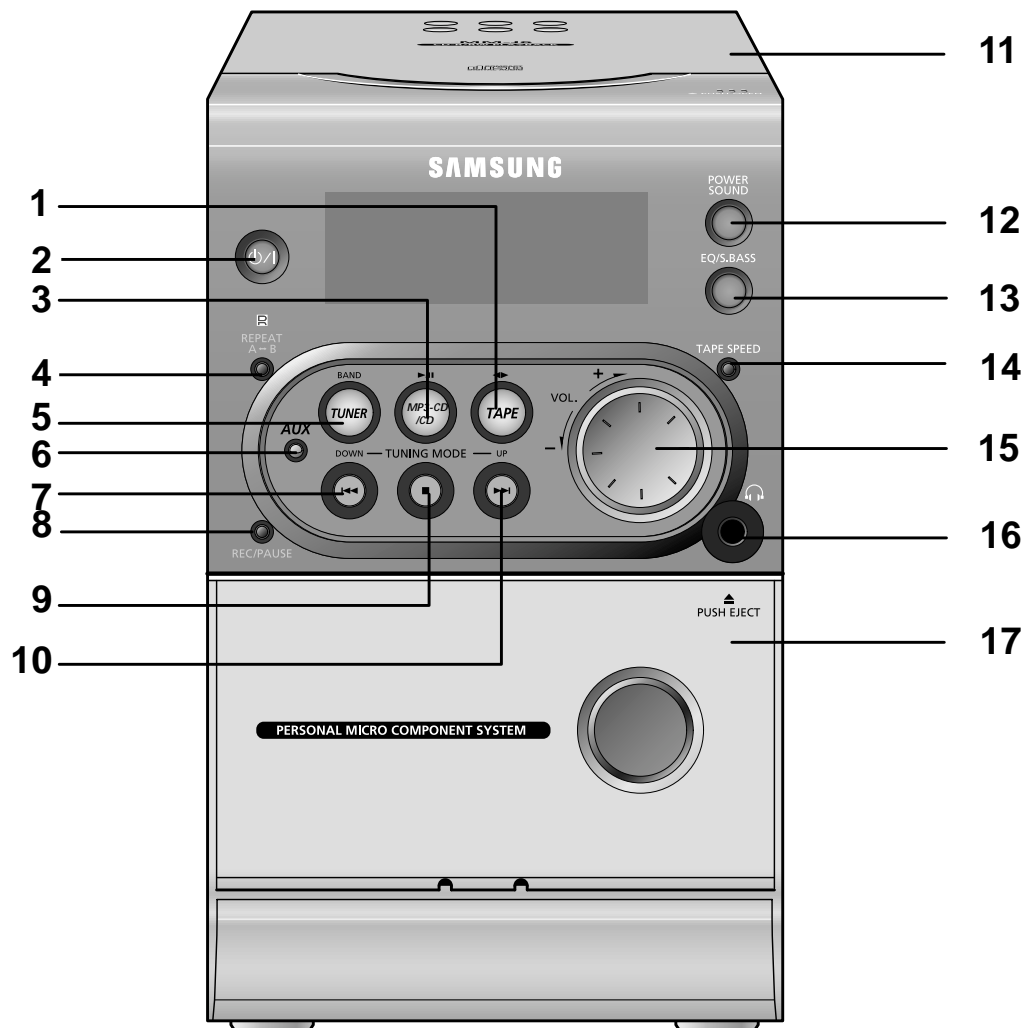

- |    |                         |     |                                 |
|----|-------------------------|-----|---------------------------------|
| 1. | TAPE PLAY               | 10. | FORWARD                         |
| 2. | STANDBY /ON             | 11. | PUSH OPEN (CD DOOR OPEN /CLOSE) |
| 3. | CD PLAY/PAUSE           | 12. | POWER SOUND                     |
| 4. | CD or TAPE REPEAT A ↔ B | 13. | EQ / SUPER BASS                 |
| 5. | TUNER / BAND            | 14. | TAPE SPEED                      |
| 6. | AUX                     | 15. | VOLUME Control                  |
| 7. | REWIND                  | 16. | HEADPHONE JACK                  |
| 8. | RECORD/PAUSE            | 17. | PUSH EJECT                      |
| 9. | STOP/TUNING MODE        |     | (CASSETTE DOOR OPEN/CLOSE)      |

# Remote Control

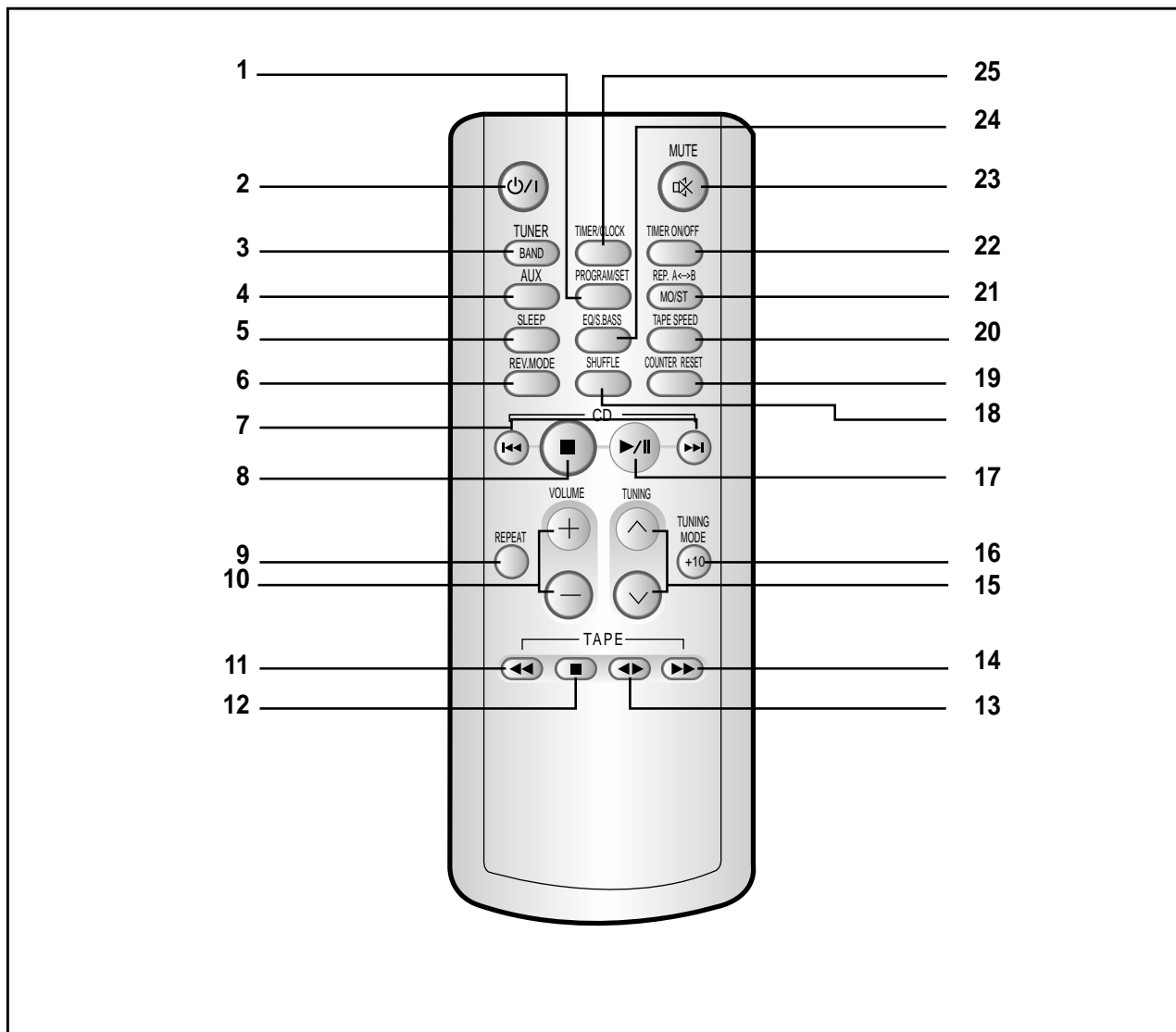

- |                      |                                 |
|----------------------|---------------------------------|
| 1. PROGRAM / SET     | 14. TAPE FAST-FORWARD           |
| 2. STANDBY/ON        | 15. TUNING UP OR DOWN SEARCH    |
| 3. TUNER/BAND        | 16. TUNING MODE / CD+10         |
| 4. AUX               | 17. CD PLAY/PAUSE               |
| 5. SLEEP             | 18. SHUFFLE PLAY                |
| 6. REVERSE MODE      | 19. COUNTER RESET               |
| 7. CD SKIP OR SEARCH | 20. TAPE SPEED                  |
| 8. CD STOP           | 21. REPEAT A-B / FM MONO/STEREO |
| 9. CD REPEAT         | 22. TIMER ON/OFF                |
| 10. VOLUME CONTROL   | 23. MUTE                        |
| 11. TAPE REWIND      | 24. EQ/SUPER BASS               |
| 12. TAPE STOP        | 25. TIMER/CLOCK                 |
| 13. TAPE PLAY        |                                 |

## Rear Panel View

GB

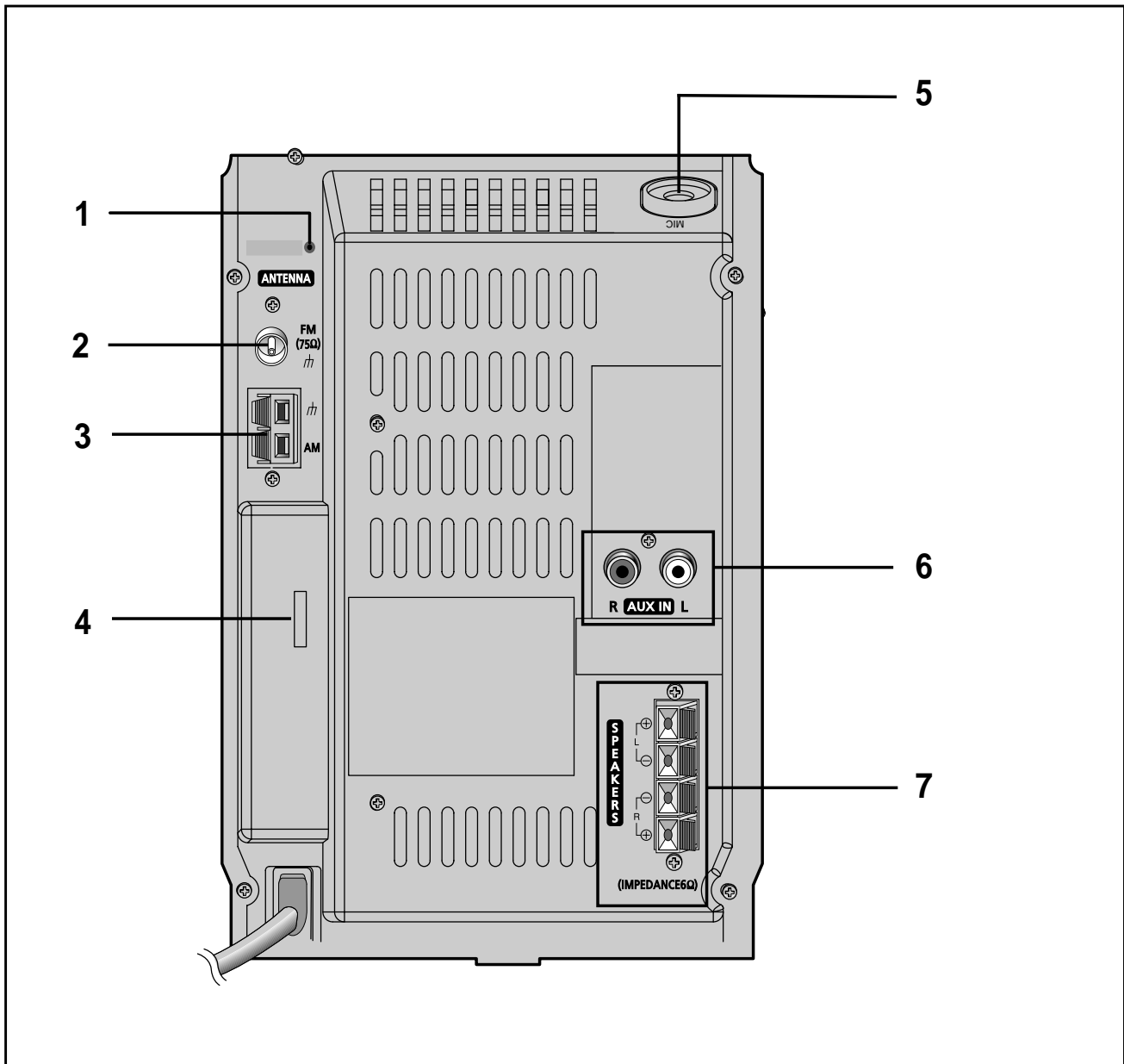

1. SW Aerial Connector Terminals (option)
2. FM Aerial Connector Terminal
3. AM Aerial Connector Terminals
4. Voltage selector (option)
5. Microphone Jack (option)
6. AUX-Input
7. Loudspeakers Connector Terminals

## Where to Install Your Micro-Component System

To take full advantage of your new micro-component system, follow these installation instructions before connecting the unit.

- ◆ Install the system on a flat, stable surface.
- ◆ Never place this unit on carpeting.
- ◆ Never place this unit in an outdoor area.
- ◆ Maintain an open space of approximately 6 inches (15 cm) on the sides and rear of the system, for ventilation purposes.
- ◆ Make sure that you have enough room to open the compact disc compartment easily.
- ◆ Place the loudspeakers at a reasonable distance on either side of the system to ensure good stereo sound.
- ◆ Direct the loudspeakers towards the listening area.
- ◆ For optimum performance, make sure that both speakers are placed at an equal distance above the floor.



## Connecting your System to the Power Supply

The main lead must be plugged into an appropriate socket.

- ☛ Before plugging your system into a main socket, you must check the voltage.

- 1 Check the position of voltage selector on the rear of the system (OPTIONAL).
- 2 Plug the main lead into an appropriate socket.
- 3 Press the **Standby/On** button to switch your micro-component system on.

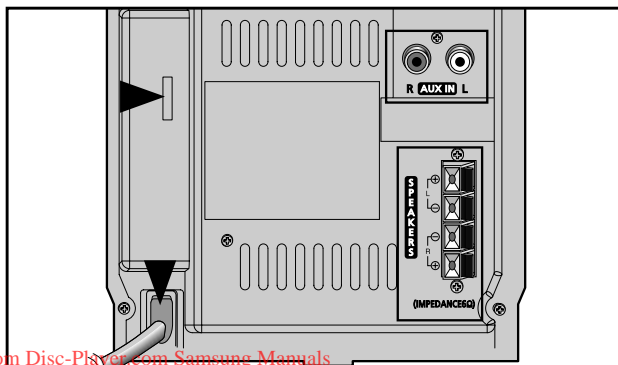

## Inserting Remote Control Batteries

GB

Insert or replace remote control batteries when you:

- ◆ Purchase the micro-component system
- ◆ Find that the remote control is no longer operating correctly

- ☛ When replacing the batteries, use a new set of batteries and never mix alkaline and manganese batteries.

- 1 Place your thumb on the position marked  on the battery compartment cover (rear of the remote control) and push the cover in the direction of the arrow.
- 2 Insert two AAA, LR03 or equivalent batteries, taking care to respect the polarities:
  - ◆ + on the battery against + in the battery compartment
  - ◆ - on the battery against - in the battery compartment
- 3 Replace the cover by sliding it back until it clicks into position.

- If you will not be using the remote control for a long time, remove the batteries to prevent corrosion.

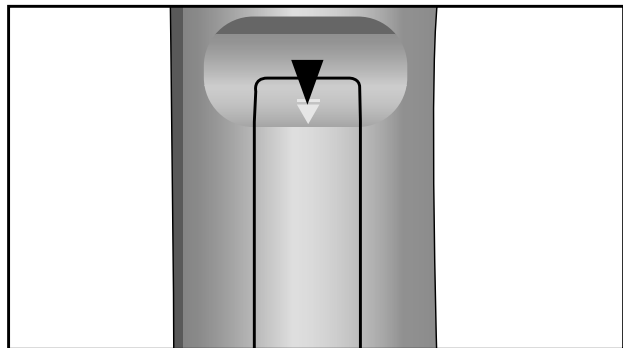

## Connecting to an External Source

GB

The auxiliary input can be used to take advantage of the sound quality of your micro-component system when listening to other sources.

- Examples:
- ◆ A television
  - ◆ A video disc player
  - ◆ A Hi-Fi stereo video cassette recorder

➤ To connect to the external source, the source must have an audio output. In addition, you need an RCA connection cable.

- 1 Set the system to standby mode and disconnect it and the external source from the main socket.
- 2 Connect the audio cable to the rear of the micro-component system.
 

Connect the...	To the connector marked...
Red jack .....	R (right)
White jack .....	L (left)

➤ For optimum sound quality, do not invert the right and left channels.
- 3 Plug the system back into the main socket and press **Standby/On** (⏻/⏻) to switch it on.
- 4 Select the AUX source by pressing **AUX**.  
Result: **AUX** is displayed.
- 5 Switch the external source on.
- 6 Adjust the volume and balance as required:
  - ◆ Volume
  - ◆ Equaliser

Example: You can watch a film and take advantage of stereo sound provided that the original sound track is in stereo (as if you were in a cinema).

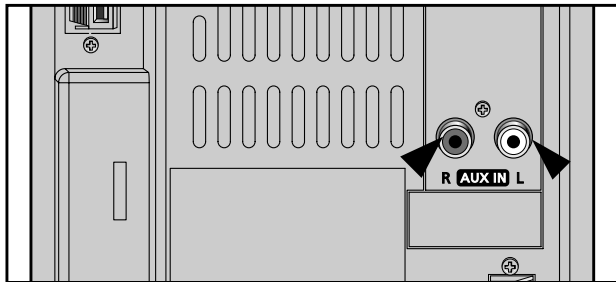

## Speaker Connection

The loudspeaker connector terminals are located on the rear of the system (red and black tabs).

There are four terminals on the system:

- ◆ Two for the left speaker (marked L)
- ◆ Two for the right speaker (marked R)

To achieve the correct sound quality, connect the:

- ◆ Red wire to the + terminals
- ◆ Black wire to the - terminals

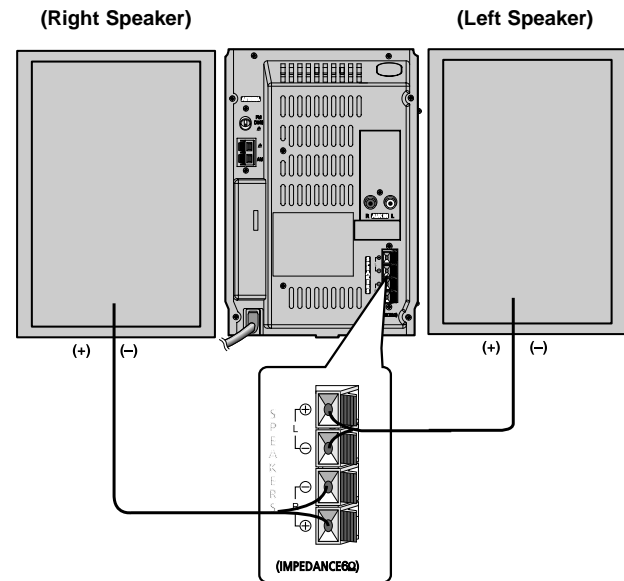

## Directions in Installing Speaker

- ◆ Installation in a place near heating apparatus, under direct lay of light or with high humidity may cause performance degradation of the speaker.
- ◆ Do not install on the wall or on a high place of pole or other unstable place to prevent any safety accident caused by falling of the speaker.
- ◆ Do not take the speaker apart from TV or computer monitor. The speaker near the TV or computer monitor may influence the quality of the screen display.



## Connecting the AM (MW)/LW Aerial

GB

The AM aerial (for long and medium waves) can be:

- ◆ Placed on a stable surface
- ◆ Fixed to the wall (you must first remove the base)

The **AM** aerial connector terminals are located on the rear of the system and are marked **AM**.

- ☛ To avoid noise interference, check that the loudspeaker wires do not run close to the aerial wires. Always keep them at least 2 inches (5 cm) away.

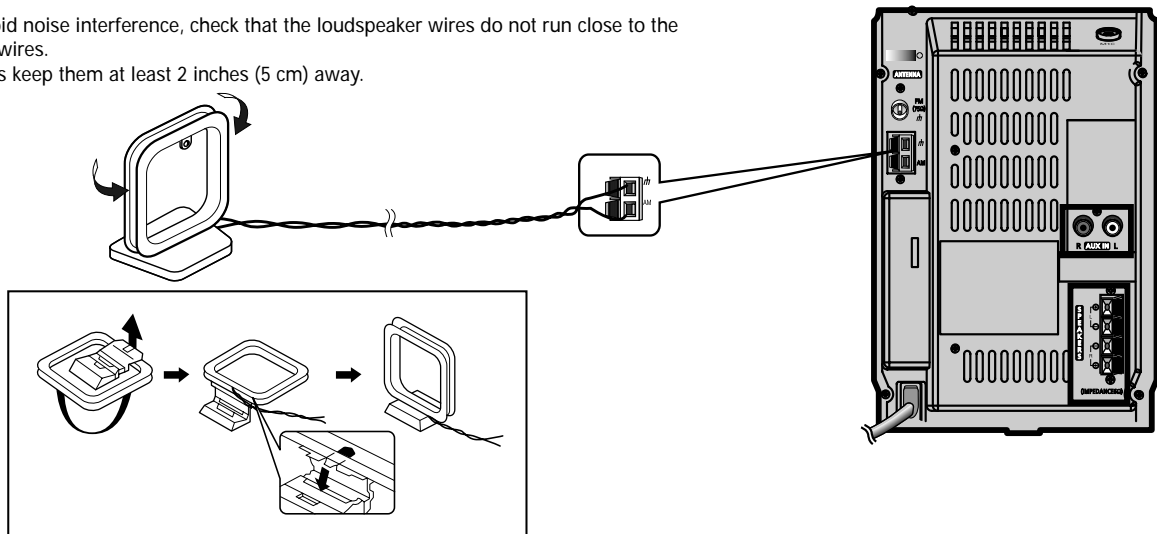

## Connecting the FM Aerial

How to connect a COAXIAL TYPE aerial.

- ◆ Connect a 75Ω antenna to the **FM** antenna terminal.
- ◆ Plug the connector on the **FM** aerial supplied into the coaxial socket (75Ω) marked **FM** on the rear of the system.
- ◆ Follow the instructions given on Page 12 to tune into a radio station, and determine the best position for the aerial.
- ◆ If reception is poor, you may need to install an outdoor aerial. To do so, connect an outdoor **FM** aerial to the **FM** socket on the rear of the system using a 75Ω coaxial cable (not supplied).

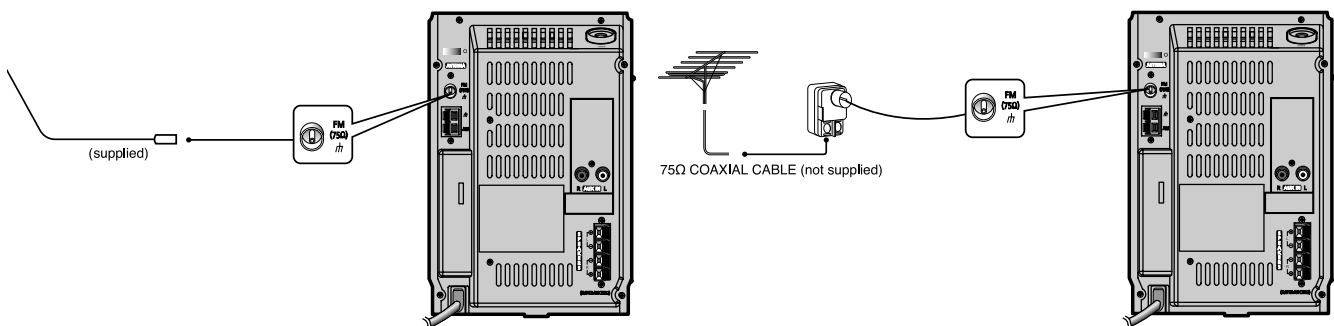

## Connecting the SW Aerial (option)

How to connect a SW TYPE aerial .

- ◆ Spread the SW aerial out and attach the ends to a wall, in the position providing the best reception.
- ◆ If reception is poor (e.g. distance from transmitter too great, walls blocking the radio waves, etc), install an outdoor aerial.

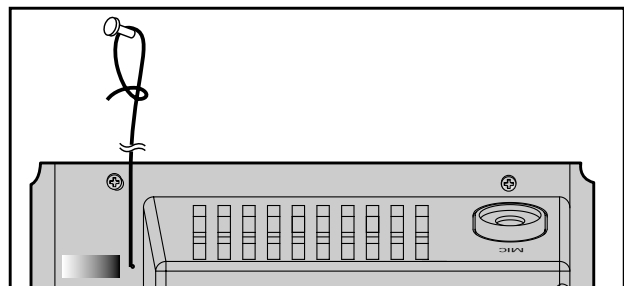

## Setting the Clock

GB

our system is equipped with a clock which allows you to turn your system on and off automatically.

You should set the clock:

- ◆ When you first purchase the micro-component system
- ◆ After a power failure
- ◆ After unplugging the unit

◆ For each step, you have a few seconds to set the required options. If you exceed this time, you must start again.

- 1 Switch the system on by pressing **Standby/On** ( / I )
- 2 Press **TIMER /CLOCK** twice.  
Result: **CLOCK** is displayed.
- 3 Press **PROGRAM /SET**.  
Result: The hour flashes.
- 4 

To...	Press...
Decrease the hours .....	▼
Increase the hours .....	▲
- 5 When the correct hour is displayed, press **PROGRAM /SET**.  
Result: The minutes flash.
- 6 

To...	Press...
Decrease the minutes .....	▼
Increase the minutes .....	▲
- 7 When the correct time is displayed, press **PROGRAM /SET**.  
Result: The clock starts and is displayed, even when the system is in standby mode.

➤ ◆ You can display the time, even when you are using another function, by pressing **TIMER /CLOCK** once.

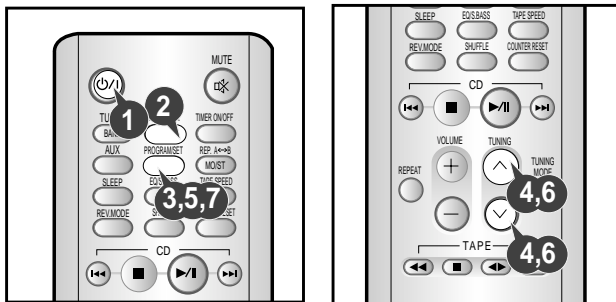

## Listening to a Compact Disc

◆ Do not use CDs of irregular shapes like heart or octagon shapes. The performance of the player may be degraded.

- 1 Press the **CD** ( ) button on the main unit and select CD.
- 2 Open the CD door by pushing on the top of the main unit marked **PUSH OPEN** ( ).  
Result: The CD door is opened.
- 3 Place the CD on the compartment so that the CD label faces upward.
- 4 Close the CD door.  
Result: Number of tracks and the total playback time are shown on the display.
- 5 Press the **CD** ( ) button to playback.

- 6 Adjust the volume according to needs with the following procedures.
  - ◆ Press the **VOLUME+,-** button or turn the **VOL. +** or **-** knob .
- 7 If it is desired to pause while the playback is processing, press the **CD** ( ) button.
  - Press the **CD** ( ) button once again to play back again.
- 8 To stop playback, press the **Stop** ( ) button.

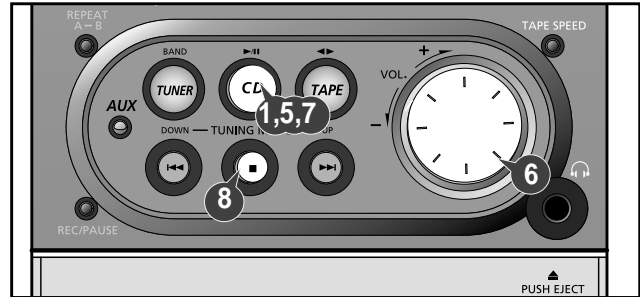

## Selecting a Track

You can select the track you wish to listen to, either when the compact disc player is stopped or when a disc is playing.

To start playback at the beginning of the...	Press...
Next track .....	▶▶ once
Current track .....	◀◀ once
Previous track .....	◀◀ twice
Track of your choice .....	◀◀ or ▶▶ the appropriate number of times.

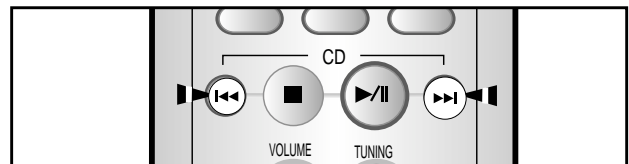

## Searching for a Specific Music Passage on a CD

When listening to a compact disc, you can quickly search for a specific music passage on a track.

To search through the tracks...	Press and hold down...
Forwards .....	▶▶ for at least one second
Backwards .....	◀◀ for at least one second

➤ It is recommended that you turn the volume down before using this function.

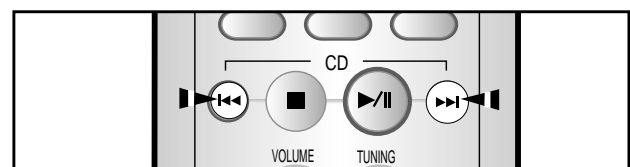

## CD Repeat Function

You can repeat:

- ◆ A specific track on a compact disc
- ◆ All tracks on the compact disc

1 Press the **REPEAT** button.

To repeat the...

Press REPEAT...

Current track indefinitely..... Once (**REPEAT 1** is displayed)

Disc ..... Twice (**REPEAT ALL** is displayed)

2 When you wish to stop the Repeat function, press **REPEAT** a third time.

Result: **REPEAT** is no longer displayed and the function is cancelled.

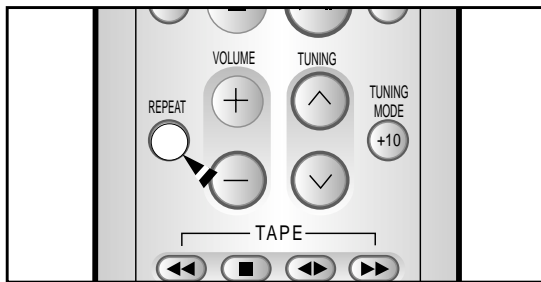

## Shuffle Play Function

You can listen to the tracks on a compact disc in a different order each time, as the various tracks will be selected automatically in a random sequence.

1 Press the **SHUFFLE** button.

Result: The Shuffle indication appears and all the tracks are played in a random order. Both the track number and the playing time are displayed.

2 When playing tracks in a random order, you can:

- ◆ Move on to the next track (selected at random) by pressing **⏮/⏭**
- ◆ Search quickly for a specific point in the current track by pressing and holding down **⏮/⏭** more than one second.

3 When you have finished the random playback, press **■** or press the **SHUFFLE** button again.

➤ Repeat and CD Synchro function are not available in Shuffle playing mode.



## Programming the Order of Playback

You can decide for yourself:

- ◆ The order in which you listen to the tracks
- ◆ The tracks to which you do not wish to listen

➤ This feature can be combined with the CD Repeat function.

1 If necessary, stop the player by pressing **Stop (■)**.

2 Press **PROGRAM / SET**.

Result: **PRO1** is displayed.

3 Select the required track by pressing the SKIP buttons:

- ◆ **⏭** to move forwards through the tracks
- ◆ **⏮** to move backwards through the tracks

4 Press **PROGRAM / SET**.

Result: **PRO2** is displayed.

5 To select other tracks, repeat Steps 3 and 4.

➤ You can programme up to 24 tracks.

6 When you have finished selecting the tracks, press **CD (▶/||)** to start listening to the selection, in the order in which the tracks were programmed.

7 Press **Stop (■)** twice to cancel the selection when the disc is playing.

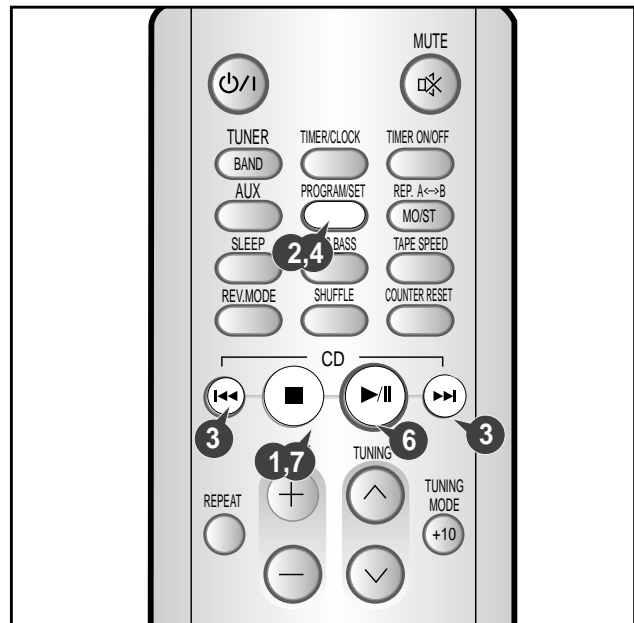

## Regarding the playback of CD-R/RW

- ◆ In the case of an original CD-R(Recordable) recorded in audio CD format, CD-RW(Rewritable) and editing by the user, playback is processed on the respective completed status. (The player may not be played back according to the characteristics of the CD or recorded status.)
- ◆ The CD-RW is comparably less reflexive than CD which causes more time delay to read.

## Checking and Changing Programmed Tracks

GB

You can check and change your selection of tracks at any time.

You must have selected at least one track.

- 1 Press **Stop** (■) once if you have started listening to the selection.
- 2 Press **PROGRAM / SET**.  
➤ Each time you press Program/Set, the next selection is displayed.
- 3 Press **PROGRAM / SET** one or more times until the track to be changed is displayed.

TRACK PRGM  
CH01 01

- 4 Press **◀** or **▶** to select the new track.
- 5 Press **PROGRAM / SET**.
- 6 Press **CD** (▶/||) to start listening to the selection.  
Result: The first track selected is played.

➤ You can change one or more tracks in your initial selection.



## Function to skip through 10 tracks at a time

Press the +10 button briefly while playing back a CD. The track 10 tracks after the current one will then be played back.

Example: If you want to select track 13 during playback of track 5, press the +10 button once, and then press the **▶▶** button three times.

5 → 10 → 11 → 12 → 13

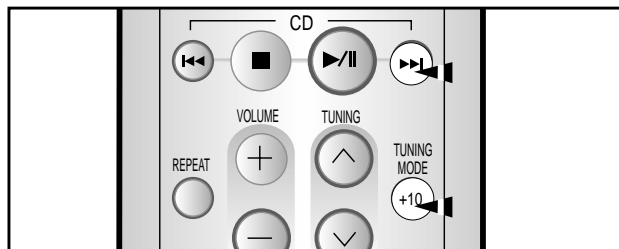

## Searching for and Storing the Radio Stations

You can store up to:

- ◆ 15 FM stations
  - ◆ 15 AM stations
  - ◆ 15 FM stations
  - ◆ 8 MW stations
  - ◆ 7 LW stations
  - ◆ 15 FM stations
  - ◆ 5 MW stations
  - ◆ 5 SW1 stations
  - ◆ 5 SW2 stations
- (option)

- 1 Switch the system on by pressing **Standby/On** (⏻/|)
- 2 Select the **TUNER** function by pressing **TUNER/BAND** on the front panel.
- 3 Select the required frequency band by pressing **TUNER/BAND** again.  
Result:The appropriate indication is displayed:
  - ◆ **FM** Frequency Modulation
  - ◆ **AM(MW)** Medium Wave
  - ◆ **LW(OPTION)** Long Wave
  - ◆ **SW1, SW2(OPTION)** Short Wave

- 4 **To search for a station ...** Press **Tuning Mode ...**

Manually.....One or more times until **MANUAL** is displayed.

Automatically.....One or more times until **AUTO** is displayed.

- 5 Select the station to be stored by pressing **◀**, **▶** button on the front panel to decrease or increase the frequency respectively.
  - ◆ To scroll through the frequencies faster when searching manually, hold down the **◀**, **▶** button on the front panel.
  - ◆ The automatic search procedure may stop on a frequency that does not correspond to a radio station.  
If this happens, use the manual search mode.
- 6 Adjust the volume by:
  - ◆ Turning the VOL.+, - knob on the front panel or
  - ◆ Pressing the VOLUME+, - button on the remote control.
- 7 Select the FM stereo or mono mode by pressing **MO/ST** on the remote control.

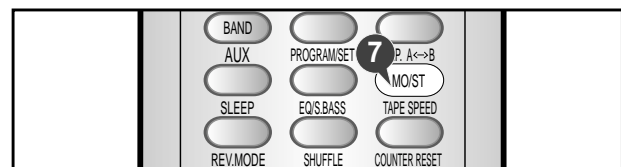
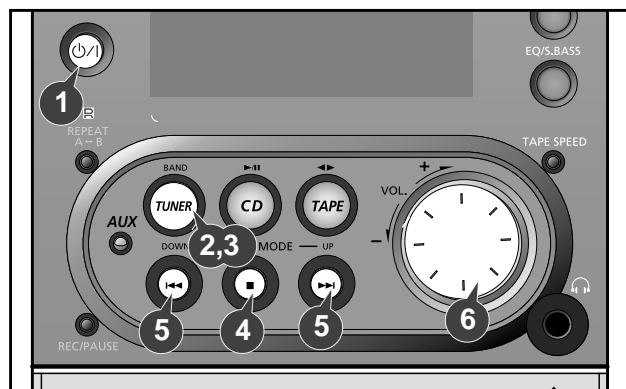

## Searching for and Storing the Radio Stations(continued)

- 8 If you do not want to store the radio station found, revert to Step 4 and search for another station.  
Otherwise:
- a Press **PROGRAM/SET**  
Result: The program number is displayed for a few seconds.
  - b Press **TUNING**  $\nabla$  and  $\blacktriangle$  to assign a program number between 1 and 15.
  - c Press **PROGRAM/SET** to store the radio station.  
Result: The program number is no longer displayed and the station is stored.
- 9 To store any other radio frequencies required, repeat Steps 3 to 6.

➤ The PROGRAM function can be used to assign a new station to an existing program number.

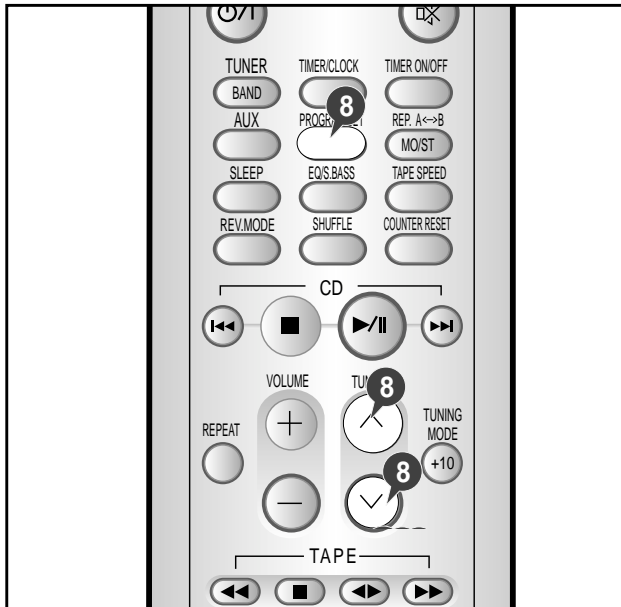

## Selecting a Stored Station

GB



You can listen to a stored radio station as follows:

- 1 Switch the system on by pressing **Standby/On** (  $\text{⏻}$  /  $\text{⏻}$  ).
- 2 Select the TUNER function by pressing **TUNER/BAND** on the front panel.
- 3 Select the required frequency band by pressing **TUNER/BAND**.
- 4 Select the radio station as follows.

To listen to ...	Press ...
A stored station.....	a Press the <b>TUNING MODE</b> button until "PRESET" is displayed.
	b <b>TUNING</b> $\nabla$ and $\blacktriangle$ to select the required station.

➤ Press TUNING MODE again to exit the stored station selection function.

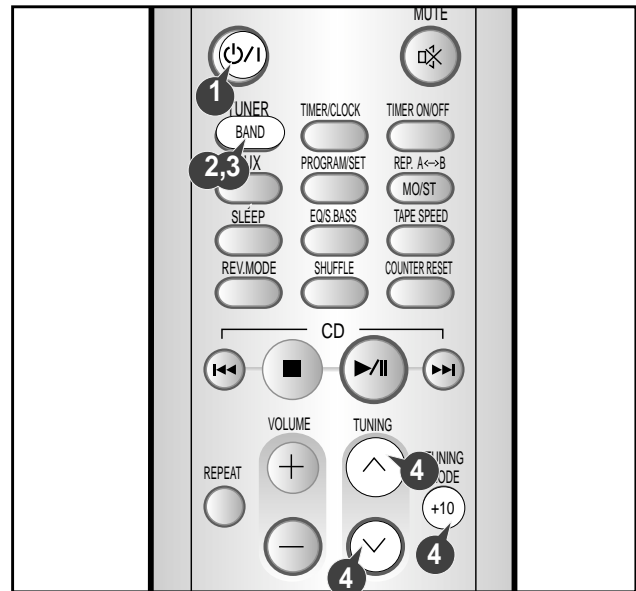

## Improving Radio Reception

You can improve the quality of radio reception by:

- ◆ Rotating the FM or AM(MW) aerial
  - ◆ Testing the positions of the FM and AM(MW) aerials before fixing them permanently
- If reception from a specific FM radio station is poor, press **MO/ST** to switch from stereo mode to mono. The quality of the sound will be improved.

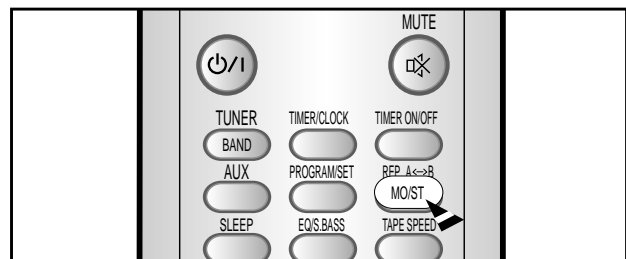

# Listening to a Cassette

GB

- 1 Switch the system on by pressing **Standby/On** (⏻/⏻).
- 2 Select the **TAPE** function by pressing **TAPE** on the front panel.
- 3  Open the cassette deck by pushing on the corner of the cover marked **PUSH EJECT** until you hear a click and then release it.
- 4 Insert the pre-recorded cassette with the open edge of the tape facing downwards.
- 5 Close the deck by pushing on it until it clicks into place.
- 6 Press the **TAPE** (◀▶) button.  
Side A .....TAPE (▶) once  
Side B .....TAPE (▶) twice  
**Result:** The cassette starts playing.
- 7 Press **TAPE SPEED** to adjust the speed of the tape playing. And each time the button is pressed, the mode changes as follows.

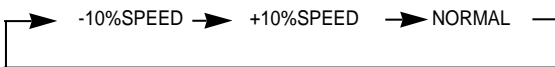

- 8 When the cassette is stopped, select one of the following functions as required.

To...	Press...
Rewind the cassette.....	⏮ / ⏪
Fast-forward the cassette.....	⏭ / ⏩

➤ The cassette player stops automatically when the beginning or end of the cassette is reached.

- 9 To stop the playback or search, press **Stop** (■) button.

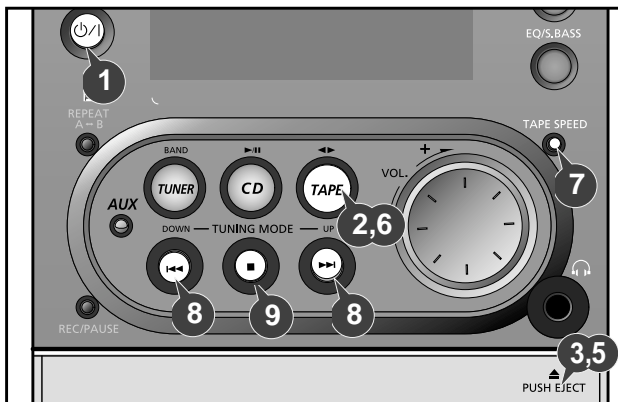

# Recording a Compact Disc

## Direct recording

The direct recording mode enables you to start recording with any track on the compact disc.

◆ You do not need to adjust the volume, as it has no effect on the recording.

- 1 Switch your system on by pressing **Standby/On** (⏻/⏻).
- 2 Insert a blank cassette in Deck.
- 3 Load a compact disc.
- 4 Press the **CD** (▶/||) button.  
◆ Use the CD selection (◀, ▶) buttons to select the desired song.
- 5 Press the **REC/PAUSE** button.  
**Result:** Recording will begin.
- 6 To stop recording, press **STOP** (■) button.

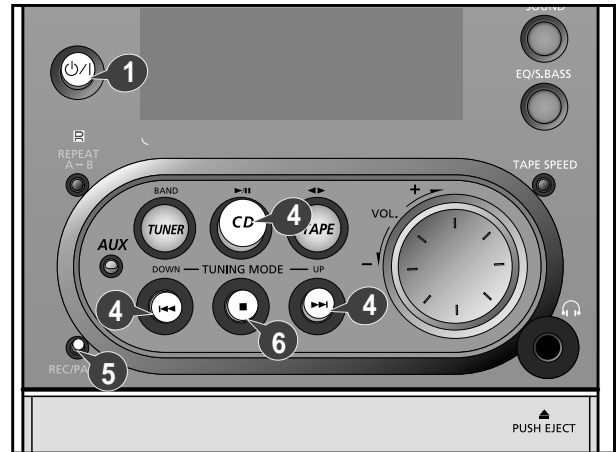

# Recording a Radio Program

You can record a radio program of your choice.

◆ You do not need to adjust the volume, as it has no effect on the recording.

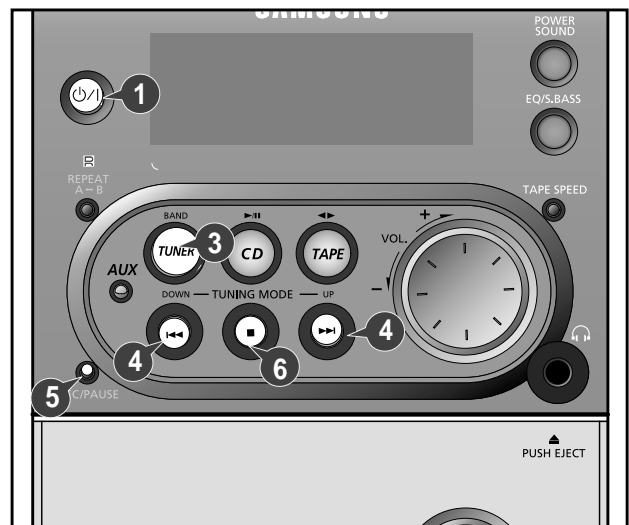

- 1 Switch the system on by pressing **Standby/On** (⏻/⏻).
- 2 Insert a blank cassette in Deck.
- 3 Select the **TUNER** function by pressing **TUNER/BAND**.
- 4 Select the radio station that you wish to record by pressing **◀** or **▶** button on the front panel or **∨** / **∧** on the remote control.
- 5 Press **REC/PAUSE**.  
**Result:** **REC** is displayed and recording starts.
- 6 To stop recording, press **STOP** (■) button.



## Selecting the Cassette Playback Mode

Your micro component system has three cassette playback modes which enable you to listen to both sides of a cassette automatically. Press REV.Mode until the appropriate symbol is displayed.

**When the display indicates... The micro component system plays back...**

	..... One side of the selected cassette and then stops.
	..... One side of the cassette. The other side of the cassette and then stops.
	..... Both sides of the cassette indefinitely until you press stop.

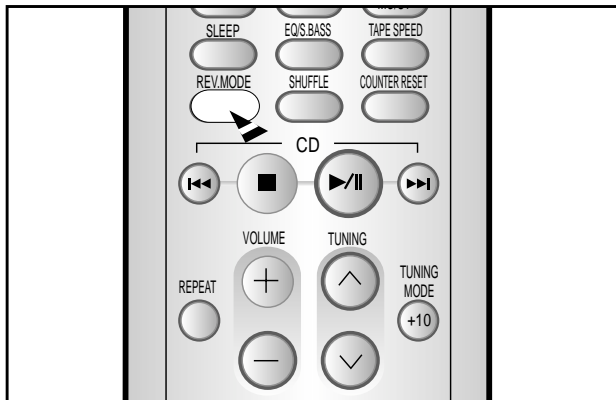

## Tape Counter

GB

*When playing a cassette, a counter is displayed to enable you to take note of the counter value at the start of each track and thus start playback at the beginning of the track to which you wish to listen.*

➤ The counter is only displayed when a cassette is being played. Before starting to record a cassette for which you wish to take note of the counter values at the beginning of each track, reset the counter by pressing **COUNTER RESET**.

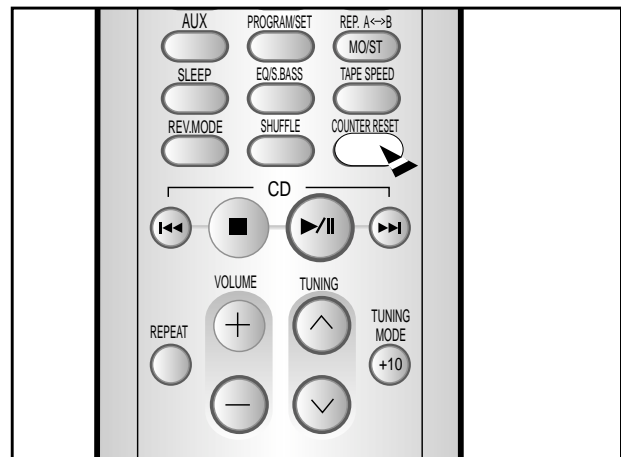

## REPEAT A-B Function

When you select CD(TAPE) **REPEAT A ↔ B** playback, the music passages to which you were listening are repeated 3 times.

- 1 Press **CD** (▶/||) or **TAPE** button.  
Result:The CD(TAPE) player starts playing.
- 2 Press **REPEAT A ↔ B** button.  
Result:The indications appear: **START**  
The flashes appear: **A ↔**  
◆ A Time is memorised.
- 3 Press **REPEAT A ↔ B** button.  
Result:The indications appear: **END**  
◆ B Time is memorised.  
◆ Your selected passages are repeated 3 times.
- 4 When you have finished the Repeat playback, Press **REPEAT A ↔ B**.

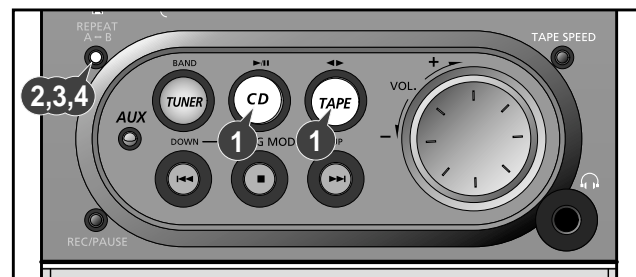



# Timer Function

GB

The timer enables you to switch the system on or off at specific times.  
Example: You wish to wake up to music every morning.

- If you no longer want the system to be switched on or off automatically, you must cancel the timer.
- 👉 ♦ Before setting the timer, check that the current time is correct.
- ♦ For each step, you have a few seconds to set the required options. If you exceed this time, you must start again.

- 1 Switch the system on by pressing **Standby/On** (⏻/⏻).
- 2 Press **Timer/Clock** until **TIMER** is displayed.
- 3 Press **PROGRAM/SET**.  
Result: **ON TIME** is displayed for a few seconds, followed by any switch-on time already set; you can set the timer switch-on time.
- 4 Set the timer switch-on time.
  - a Set the hour by pressing **∨** and **∧**.
  - b Press **PROGRAM/SET**.  
Result: The minutes flash.
  - c Set the minutes by pressing **∨** and **∧**.
  - d Press **PROGRAM/SET**.  
Result: **OFF TIME** is displayed for a few seconds, followed by any switch-off time already set; you can now set the timer switch-off time.
- 5 Set the timer switch-off time.
  - a Set the hour by pressing **∨** and **∧**.
  - b Press **PROGRAM/SET**.  
Result: The minutes flash.
  - c Set the minutes by pressing **∨** and **∧**.
  - d Press **PROGRAM/SET**.  
Result: **VOL 10** is displayed, where **10** corresponds to the volume already set.
- 6 Press **∨** and **∧** to adjust the volume level and press **PROGRAM/SET**.  
Result: The source to be selected is displayed.
- 7 Press **∨** and **∧** to select the source to be played when the system switches on.

If you select...	You must also...
TAPE (cassette) .....	Insert a recorded cassette in the deck.
TUNER (radio) .....	Select the FM or AM (MW/LW) frequency band by pressing <b>∨</b> and <b>∧</b> . • Press <b>PROGRAM/SET</b> . • Select a preset station by pressing <b>∨</b> and <b>∧</b>

- 8 CD (compact disc).....Load a compact disc.
- 9 Press **PROGRAM/SET** to confirm the timer.  
 Press **Standby/On** to set the system to standby mode.  
Result: **⏻** is displayed on the top right of the time, indicating that the timer has been set. The system will switch on and off automatically at the required times.

- If the timer switch on and off times are identical, the word **ERROR** is displayed.
- You can use **⏮/⏭** button on the front panel instead of **∨/∧** button on the remote control in step 4,5,6,7.

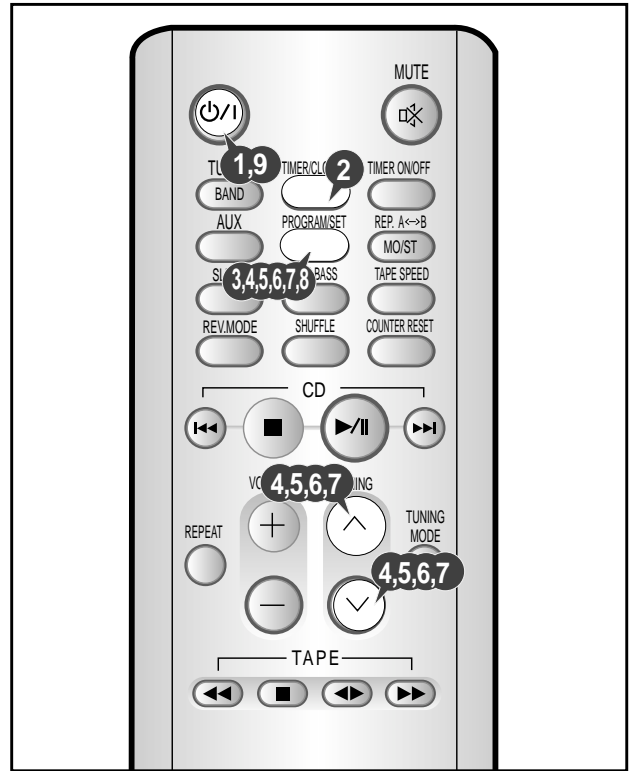

## Cancelling the Timer

After having set the timer, it will start automatically as shown by the timer indication on the display. If you no longer wish to use the timer, you must cancel it.

- You can stop the timer at any time (system on or in standby mode).

To...	Press <b>TIMER ON/OFF...</b>
Cancel the timer.....	Once. <u>Result:</u> <b>⏻</b> is no longer displayed.
Restart the timer.....	Twice. <u>Result:</u> <b>⏻</b> is displayed again.

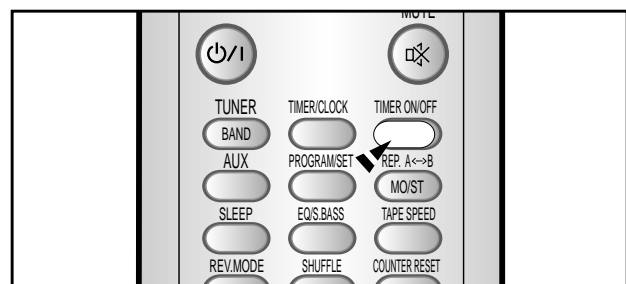



## Power sound function

This machine is equipped with the function of POWER SOUND, which amplifies bass treble output to twice as much for powerful surround-sound.

- 1 Press the **POWER SOUND** button on the front panel.  
Result: ♦ **P.SOUND** is displayed for a few seconds.  
 ♦ A more powerful resonant sound is diffused.
- 2 To cancel this function, press **POWER SOUND** again.  
Result: ♦ **OFF** is displayed for a few seconds.



## EQ /S.BASS (Super Bass) Function

Your Micro Component system has a bass amplification function and equipped with a preset equaliser that allows you to choose the most appropriate balance between treble and bass frequencies, according to the type of music you are listening to. That is called EQ/S.BASS.

This function makes the sound more powerful and real.

Press **EQ/S. BASS** on the front panel or **EQ/S. BASS** on the remote control until the required option is selected.

To obtain a...	Select...
Normal balance (linear).....	PASS
Balance suitable for pop music.....	POP
Balance suitable for rock music .....	ROCK
Balance suitable for classic music.....	CLASSIC
Balance suitable for s-bass music.....	S-BASS

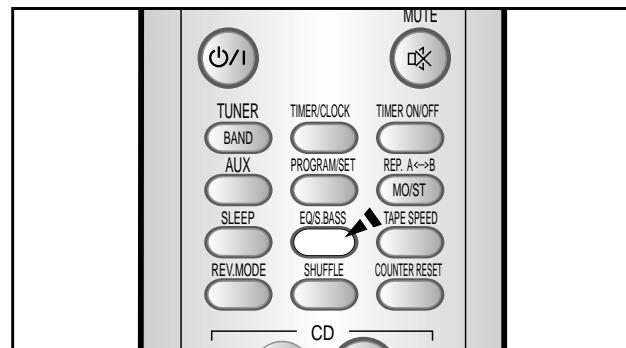
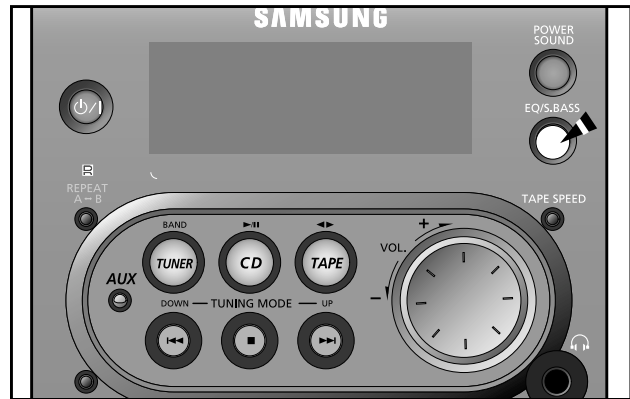

## Sleep Timer

GB

You can set the system to switch off automatically.  
**Example:** You wish to fall a sleep to music.

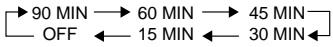
- Press **SLEEP** on the remote control.  
**Result:** The following indications are displayed:  

- Press **SLEEP** one or more times to indicate how long the system should continue playing before it switches off:  

  - At any time, you can:
    - ◆ Check the remaining time by pressing **SLEEP**
    - ◆ Change the remaining time by repeating Steps 1 and 2
- To cancel the sleep timer function, press **SLEEP** one or more times until **OFF** is displayed and the word **SLEEP** disappears.



## Connecting Headphones

You can connect a set of headphones to your micro component system so that you can listen to music or radio programs without disturbing other people in the room. The headphones must have a 3.5 mm connector or appropriate adaptor.

Connect the headphones to the Phones connector on the rear panel (or top right corner).

**Result:** The loudspeakers are no longer used for sound output.

- Prolonged use of headphones at a high volume may damage your hearing.

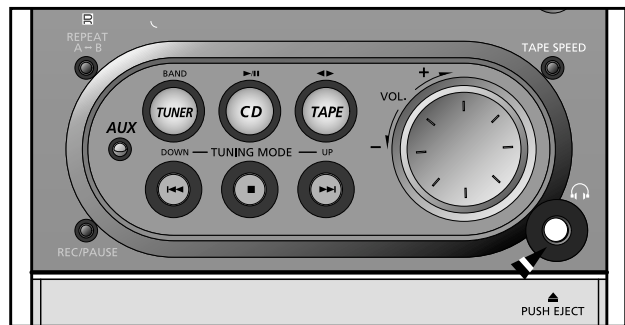

## Microphone Function (option)

The microphone enables the user to mix in his or her vocals to sing -along with the music.

**Preparation**  
 Plug the microphone with a 3.5mm jack into microphone terminal.

## MUTE Function

You can turn the sound off temporarily.  
**Example:** You wish to answer a telephone call.

- Press **MUTE**.
- To switch the sound back on (at the same volume as before), press **MUTE** again, or press the **VOLUME +, -** button.

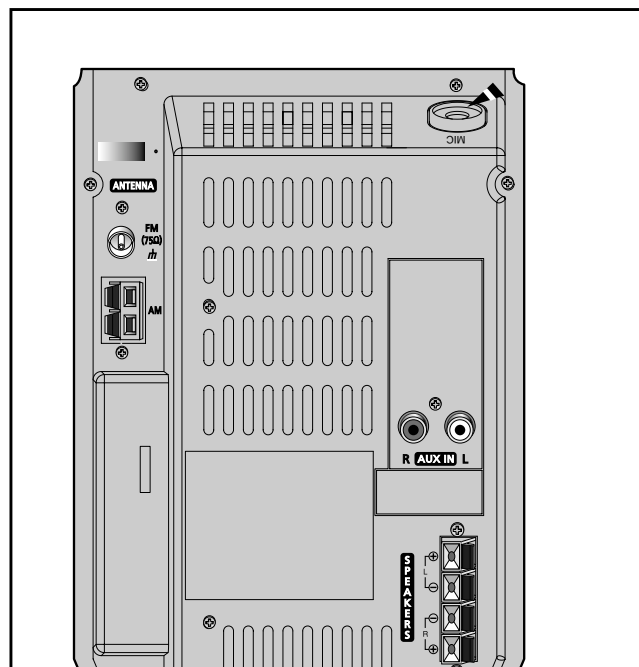
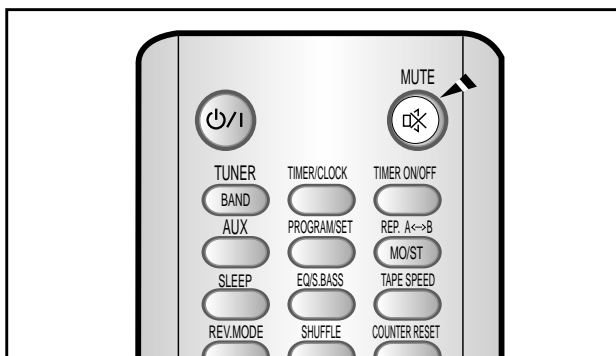

## Safety Precautions

The following diagrams illustrate the precautions to be taken when using or moving your micro-component system.

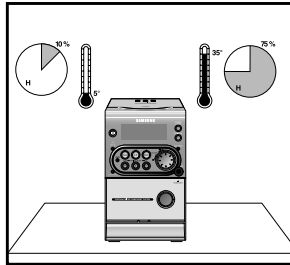

Ambient operating conditions:  
Ambient temperature 5°C-35°C  
Humidity 10-75%

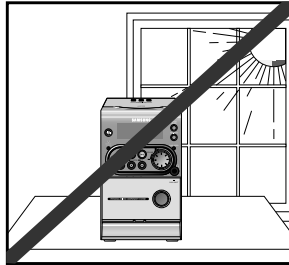

Do not expose the unit to direct sun radiation or other heat sources. This could lead to overheating and malfunction of the unit.

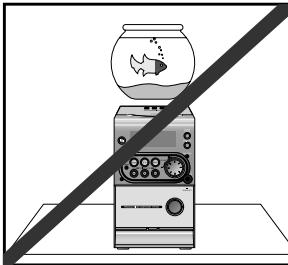

Do not place potted plants or vases on top of the unit. Moisture entering the unit could lead to dangerous electric shock and can cause equipment damage. In such events immediately disconnect the main plug from the socket.

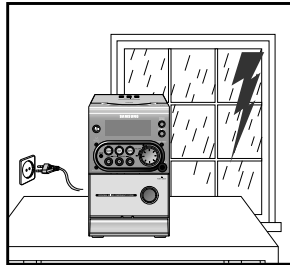

During thunderstorms, disconnect the main plug from the socket. Main voltage peaks due to lightning could damage the unit.

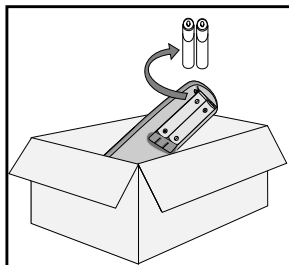

Remove the batteries from the remote control, if not used for any extended period. Leaking batteries can cause serious damage to the remote control.

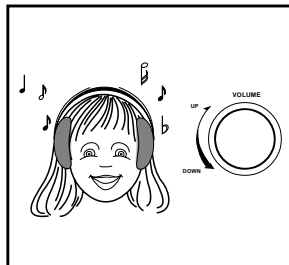

When using headphones, take care not to listen at excessive volumes. Extended use of headphones at high volumes will lead to hearing damage.

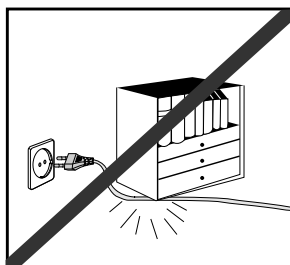

Do not place heavy items on the main lead. Main cable damage can lead to damage of the equipment (fire hazard) and can cause electric shock.

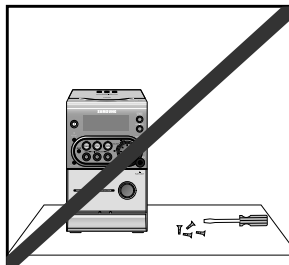

Do not remove any equipment panels. The inside of the unit contains live components, which cause electric shock.

## Cleaning Your Micro-Component System

GB

To obtain the best possible results from your micro-component system, you must clean the following elements regularly:

- ◆ The outer casing
  - ◆ The compact disc player
  - ◆ The cassette players (heads, rollers and drive capstans)
- ☛ Always unplug the system from the wall outlet:
- ◆ Before cleaning it
  - ◆ If you are not going to be using it for a long time

### Outer Casing

Clean the outer casing regularly using a soft cloth and a light detergent. Do not use abrasive powders, liquids or aerosol cleaners. Never let any liquids get into the system.

### Compact Disc Player

- 1 Before playing a compact disc, clean it with a special CD cleaning agent. Do not use the same cleaning agents as for vinyl LP records. Carefully wipe the disc from the centre outward.
- 2 Regularly clean the player with a special cleaning disc (available from your local dealer).

### Tape Decks

- 1 Press **PUSH EJECT** (▲) to open the cassette deck.
- 2 Use a cotton bud and a special cassette cleaning agent to clean the:
  - ◆ Head (1)
  - ◆ Rollers (2)
  - ◆ Drive capstans (3)

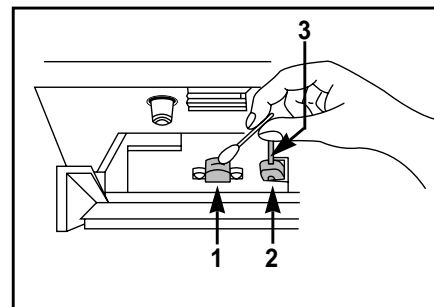

- ☛ If you will not be using the remote control for a long time, remove the batteries to prevent corrosion.
- ◆ Although your system is very hard-wearing, it should not be used in an excessively dusty environment or subjected to shocks or extreme heat (close to heating appliances or in direct sunlight, etc.).
- ◆ If the unit emits an unpleasant odour when in use, unplug it from the main supply and contact the after-sales service.

## Precautions When Using Compact Discs

GB

- ◆ Handle your compact discs with care. Always hold them by the edges to avoid leaving fingerprints on the shiny surface.
- ◆ When you have finished playing a compact disc, always put it back in its case.
- ◆ Do not fix paper or adhesive tape to the discs and do not write on the label.
- ◆ Clean them with a special-purpose cloth.
- ◆ Store your compact discs in a clean place, out of direct sunlight, where they will not be exposed to high temperatures.
- ◆ Always use compact discs marked .

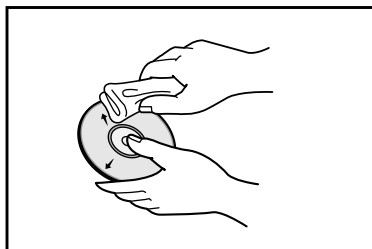

## Precautions When Using Audio Cassettes

- ◆ Check that the tape in the cassette is sufficiently taut.
- ◆ To prevent erasing a cassette that you wish to keep, remove the safety tab on the upper edge of the cassette. To record a cassette, where the tab has been broken, simply cover the opening with adhesive tape.
- ◆ When you have finished playing a cassette, always put it back in its case.
- ◆ Store your cassettes in a clean place, out of direct sunlight, where they will not be exposed to high temperatures.
- ◆ Avoid using 120-minute cassettes as they place unnecessary strain on the tape mechanism.

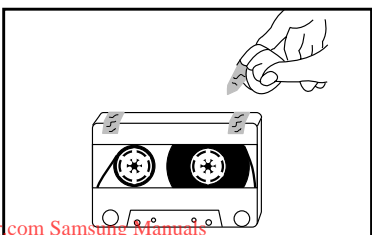
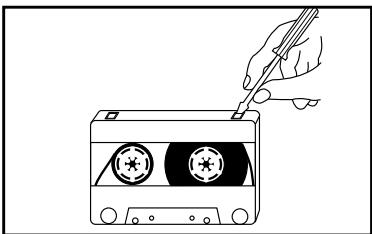
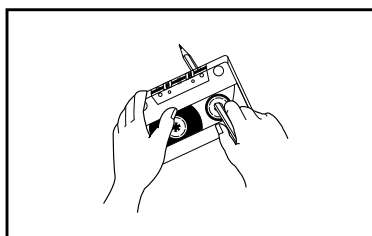

## Before Contacting the After-Sales Service

It always takes a little time to become familiar with a new appliance. If you have any of the problems listed below, try the solutions given. They may save you the time and inconvenience of an unnecessary service call.

Problem	Checks/Explanation
The system does not work	<ul style="list-style-type: none"> <li>• The main lead is not correctly plugged into a wall socket or the wall socket is not switched on.</li> <li>• The remote control batteries need replacing or the polarity has not been respected.</li> <li>• The <b>STANDBY/ON</b> button has not been pressed.</li> </ul>
There is no sound	<ul style="list-style-type: none"> <li>• The volume has been completely turned down.</li> <li>• The correct function (TUNER, CD, TAPE, AUX) has not been selected.</li> <li>• You have connected a set of earphones.</li> <li>• The loudspeaker wires have been disconnected.</li> <li>• The <b>MUTE</b> button has been pressed.</li> </ul>
The Timer does not work	<ul style="list-style-type: none"> <li>• The timer has been stopped by pressing <b>TIMER ON/OFF</b>.</li> </ul>
In case it does not work, even the action is taken as above.	<ul style="list-style-type: none"> <li>• Press the <b>P.SOUND</b> button for 5 seconds in power 'OFF'(standby), then it is returned the original position (RESET)</li> </ul>
The compact disc player does not start playing	<ul style="list-style-type: none"> <li>• The CD function has not been selected.</li> <li>• The disc has been inserted face down or is either dirty or scratched.</li> <li>• The laser sensor is dirty or dusty.</li> <li>• The system has not been installed on a flat, horizontal surface.</li> <li>• Condensation has formed in the player; leave the system in a warm, airy room for at least one hour.</li> </ul>
The tape does not start playing	<ul style="list-style-type: none"> <li>• The <b>TAPE</b> function has not been selected.</li> <li>• The cassette has not been inserted correctly.</li> <li>• The cassette player has not been closed.</li> <li>• The tape is either slack or broken.</li> </ul>
The volume falls off The cassette is not erased correctly There is excessive wow and flutter	<ul style="list-style-type: none"> <li>• The audio heads are dirty.</li> <li>• The rollers or drive capstans are dirty.</li> <li>• The tape is worn.</li> </ul>
Reception is poor or no radio stations are received at all	<ul style="list-style-type: none"> <li>• The <b>TUNER</b> function has not been selected.</li> <li>• The radio frequency has not been correctly selected.</li> <li>• The aerial has been disconnected or is not facing the right way. Turn it until you find the best orientation.</li> <li>• You are in a building that blocks radio waves; you must use an outside aerial.</li> </ul>

If the above guidelines do not allow you to solve the problem, take a note of:

- ◆ The model and serial numbers, normally printed on the rear of the system
- ◆ Your warranty details
- ◆ A clear description of the problem

Then contact your local dealer or SAMSUNG after-sales service.

# Technical Specifications

GB

SAMSUNG strives to improve its products at all times. Both the design specifications and these user instructions are thus subject to change without notice.

---

## RADIO

### **SW(option)**

Usable sensitivity 40 dB

### **LW(option)**

Usable sensitivity 60 dB

### **AM (MW)**

Signal/noise ratio 40 dB

Usable sensitivity 56 dB

Total harmonic distortion 2 %

### **FM**

Signal/noise ratio 54 dB

Usable sensitivity 16 dB

Total harmonic distortion 0.5 %

---

## COMPACT DISC PLAYER

Frequency range 20 Hz - 20 KHz

Signal/noise ratio 80 dB (at 1 KHz) with filter

Distortion 0.1 % (at 1 KHz)

Channel separation 75 dB

Disc sizes Diameter: 120 or 80 mm. Thickness: 1.2 mm

---

## TAPE DECK

Frequency range 125 Hz ~ 8 KHz

Signal/noise ratio 40 dB

Channel separation 30 dB

Erasing effect 50 dB

---

## AMPLIFIER

Output power (6  $\Omega$ ) 2 X 10 Watts RMS (total harmonic distortion : 10%)

Channel separation 40 dB

Signal/noise ratio 70 dB

---

## GENERAL

Dimensions 145(W) x 226 (H) x 282(D) mm

---

**THIS APPLIANCE IS MANUFACTURED BY:**

