



CT-XBT0x

Intel® Atom™ E3800 Industrial Mini-ITX Motherboard

User's Manual

Version 101

December 21, 2014

C&T Solution Inc.

17F-2, No. 700, Zhongzheng Rd., Zhonghe Dist., New Taipei City 235, Taiwan

Tel: +886-2-7731-7888

<http://www.candtsolution.com>

Preface

Revision History

Rev.	Date	Description
100	05/11/2014	Initial release
101	21/12/2014	Update BIOS chapter: LPSS & SCC Configuration, LCD Control

Disclaimer

All specifications and information in this User's Manual are believed to be accurate and up to date. C&T Solution Inc. does not guarantee that the contents herein are complete, true, accurate or non-misleading. The information in this document is subject to change without notice and does not represent a commitment on the part of C&T Solution Inc.

C&T Solution Inc. disclaims all warranties, express or implied, including, without limitation, those of merchantability, fitness for a particular purpose with respect to contents of this User's Manual. Users must take full responsibility for the application of the product.

Copyright Notice

All rights reserved. No part of this manual may be reproduced or transmitted in any form or by any means, electronic or mechanical, including photocopying, recording, or information storage and retrieval systems, without the prior written permission of C&T Solutions Inc.

Copyright © 2014 C&T Solutions Inc.

Trademarks Acknowledgment

Intel®, Celeron® and Pentium® are trademarks of Intel Corporation.

Windows® is registered trademark of Microsoft Corporation.

AMI is trademark of American Megatrend Inc.

IBM, XT, AT, PS/2 and Personal System/2 are trademarks of International Business Machines Corporation

All other products and trademarks mentioned in this manual are trademarks of their respective owners.

Environmental Protection Announcement

Do not dispose this electronic device into the trash while discarding. Please recycle to minimize pollution and ensure environment protection.



Safety Precautions

Before installing and using the equipment, please read the following precautions:

- Put this equipment on a reliable surface during installation. Dropping it or letting it fall could cause damage.
- The power outlet shall be installed near the equipment and shall be easily accessible.
- Turn off the system power and disconnect the power cord from its source before making any installation. Be sure both the system and the external devices are turned OFF. Sudden surge of power could ruin sensitive components. Make sure the equipment is properly grounded.
- When the power is connected, never open the equipment. The equipment should be opened only by qualified service personnel.
- Make sure the voltage of the power source is correct before connecting the equipment to the power outlet.
- Disconnect this equipment from the power before cleaning. Use a damp cloth. Do not use liquid or spray detergents for cleaning.
- Avoid the dusty, humidity and temperature extremes.
- Do not place heavy objects on the equipment.
- If the equipment is not used for long time, disconnect it from the power to avoid being damaged by transient over-voltage.
- The storage temperature shall be above -20°C and below 80°C .
- The computer is provided with a battery-powered real-time clock circuit. There is a danger of explosion if incorrectly replaced. Replace only with the same or equivalent type recommended by the manufacturer.
- If one of the following situation arises, get the equipment checked by service personnel:
 - The power cord or plug is damaged.
 - Liquid has penetrated into the equipment.
 - The equipment has been exposed to moisture.
 - The equipment does not work well or it cannot work according the user's manual.
 - The equipment has been dropped and damaged.
 - The equipment has obvious signs of breakage.

Table of Contents

Preface	2
Revision History	2
Disclaimer.....	2
Copyright Notice.....	2
Trademarks Acknowledgment.....	3
Environmental Protection Announcement.....	3
Safety Precautions	4
1. Introduction	8
1.1 Product Description	8
1.2 Specifications	9
1.3 Available Models	11
1.4 Block Diagram	12
2. Mechanical Specifications	13
2.1 Dimensions.....	13
2.2 Board Layout	14
2.2.1 Connectors.....	14
2.2.2 Jumpers	15
2.3 External Connectors	16
2.3.1 DC Power In.....	16
2.3.2 USB 3.0 Connector	16
2.3.3 DisplayPort Connector.....	16
2.3.4 VGA Connector.....	17
2.3.5 USB 2.0 Connectors	17
2.3.6 LAN Connector	17
2.3.7 Front Audio Jacks	17
2.4 Internal Connectors	18
2.4.1 CPU Power Connector: ATX	18
2.4.2 Backlight Control Connector: CN2.....	18
2.4.3 PS/2 Keyboard/Mouse Connector: CN4.....	18
2.4.4 Front Panel Pin Header: CN5	18
2.4.5 COM1 Serial Port: COM1	19
2.4.6 COM2~6 Serial Ports: COM2~6	19
2.4.7 LPC Connector: DBG.....	20
2.4.8 Fan Connectors: FAN1/2.....	20

2.4.9	Front Panel Audio Connector: Front_Audio.....	20
2.4.10	GPIO Connector: GPIO	20
2.4.11	I2C Pin Header: JP5	21
2.4.12	LAN LED "Link" Pin Header: JP6	21
2.4.13	LAN LED "Speed" Pin Header: JP7.....	21
2.4.14	LVDS Connector: LVDS	22
2.4.15	Mini-PCIe Connectors: MINI_PCIE1/2.....	23
2.4.16	SATA Signal Connectors: SATA1~2	23
2.4.17	SATA Power Connectors: SATA1_PWR/ SATA2_PWR	24
2.4.18	UART Serial IO Connector: UART.....	24
2.4.19	USB 2.0 Pin Header: USB_1	24
2.4.20	USB 2.0 Wafer Connector: USB_2/USB_3	24
2.5	Jumper Settings.....	25
2.5.1	Clear CMOS: JP2	25
2.5.2	Backlight Power: JP3.....	25
2.5.3	Panel Power: JP4	25
3.	Features & Interfaces	26
3.1	Processor	26
3.2	BIOS	26
3.3	System Memory.....	26
3.4	Graphics	26
3.5	USB	27
3.6	Ethernet	27
3.7	SATA	27
3.8	Audio	27
3.9	Expansion.....	27
3.10	General Purpose Input Output.....	28
3.10.1	GPIO Configuration.....	28
3.11	Watchdog Timer	30
3.11.1	Board Design	30
3.11.2	Psuedo Code	30
4.	Driver Installation	31
5.	System BIOS	32
5.1	Advanced.....	33
5.1.1	ACPI Settings.....	34
5.1.2	F81866 Super IO Configuration.....	35
5.1.3	Hardware Monitor	36

5.1.4	Serial Port Console Redirection.....	37
5.1.5	CPU Configuration	38
5.1.6	SATA Configuration	39
5.1.7	Miscellaneous Configuration.....	40
5.1.8	LPSS & SCC Configuration	41
5.1.9	CSM Configuration.....	42
5.1.10	SDIO Configuration.....	43
5.1.11	USB Configuration	44
5.1.12	Security Configuration.....	45
5.2	Chipset	46
5.2.1	Northbridge Configuration.....	47
5.2.2	Southbridge Configuration	50
5.3	Security.....	53
5.3.1	Secure Boot Menu	54
5.4	Boot	55
5.5	Save and Exit	56
6.	Address Map	57
6.1	I/O Port Address Map	57
6.2	Interrupt Controller (IRQ) Map.....	58
6.3	Memory Map.....	65

1. Introduction

1.1 Product Description



The CT-XBT0x is a single board computer in the Mini-ITX form factor featuring the Intel® Atom™ Processor E3800 Series in FCBGA1170 package on 22nm process technology in a single chip solution. The two 240-pin SODIMM sockets are for dual channel DDR3L 1333MHz memory with maximum capacity up to 8GB. The Intel HD graphics controller integrated within the processor supports three independent displays (VGA, DisplayPort, LVDS). The CT- XBT0x provides Gigabit Ethernet, USB 3.0/2.0, COM, GPIO, two Mini-PCIe slots, microSD card slot, and SIM card slot to support a variety of industrial applications.

1.2 Specifications

■ CPU

Intel® Atom™ Processor E3800 Series and Intel® Celeron® Processor J1900/N2807 in FCBGA1170 package

- Atom™ E3845: 4-core, 1.91GHz, TDP 10W (CT-XBT01)
- Atom™ E3827: 2-core, 1.75GHz. TDP 8W (CT-XBT02)
- Atom™ E3815: 1-core, 1.46GHz, TDP 5W (CT-XBT03)
- Celeron® J1900: 4-core, 2.00GHz, TDP 10W (CT-XBT04)
- Celeron® N2807: 2-core, 1.58GHz, TDP 4.3W (CT-XBT05)

■ System Memory

- Two 240-pin DDR3L SODIMM sockets
- 1333MHz, non-ECC unbuffered
- Data transfer rates up to 1333MT/s
- Up to 8GB

■ BIOS

- AMI uEFI BIOS
- 8MB SPI flash ROM

■ TPM

- TPM 1.2 support (optional)

■ Graphics

- Intel® HD Graphics Gen 7 integrated in CPU
- 1x VGA, resolution up to 2560x1600@60Hz
- 1x DisplayPort supports DP1.2, up to 2560x1600@60Hz
- 1x 2-ch 24-bit LVDS up to 1920x1200

■ Ethernet

- One Intel® I210IT GbE Controller
- 10/100/1000BASE-TX Ethernet
- WOL/PXE support

■ Audio

- Realtek ALC886
- Line-In, Line-Out and Mic-In

■ Expansion Interfaces

- 2x Mini-PCIe slots (one full size and one half size)
- 1x microSD card slot
- 1x SIM card slot

■ **Internal I/O**

- 1x 2-ch 24-bit LVDS
- 2x SATA 3Gb/s ports
- 4x USB 2.0 ports (2 shared with Mini-PCIe)
- 1x RS-232/422/485 port (BIOS selectable, supports auto-flow)
- 5x RS-232 ports
- 1x 8-bit GPIO
- 1x PS/2 keyboard and mouse
- 1x front panel audio
- 1x LVDS backlight control
- 1x front panel interface
- 1x battery socket for CR-2032 battery
- 2x 4-pin fan connectors

■ **External I/O**

- +12V DC power input
- 1x DisplayPort
- 1x VGA
- 1x GbE
- 1x USB 3.0
- 2x USB 2.0
- 1x Line-Out
- 1x Mic-In

■ **Watchdog Timer**

- H/W Reset, 1-65535 sec./min.
- 1 sec. or 1min. increments

■ **Hardware Monitor**

- CPU/Memory power
- System voltages
- Temperatures
- Smart Fan support

■ **Power Management**

- ACPI 5.0 compliant

■ **Form Factor**

- Mini-ITX, 170mmx 170mm

- **Operating Temp.**
 - -20°C to 70°C
- **Storage Temp.**
 - -40°C to 85°C
- **Operating Humidity**
 - 10% to 90% relative humidity, non-condensing
- **Certifications**
 - CE
 - FCC Class A

1.3 Available Models

Model Number	Processor	Features
CT-XBT01	Atom™ E3845	4-core, 1.91GHz, TDP 10W
CT-XBT02	Atom™ E3827	2-core, 1.75GHz, TDP 8W
CT-XBT03	Atom™ E3815	1-core, 1.46GHz, TDP 5W
CT-XBT04	Celeron® J1900	4-core, 2.00GHz, TDP 10W
CT-XBT05	Celeron® N2807	2-core, 1.58GHz, TDP 4.3W

1.4 Block Diagram

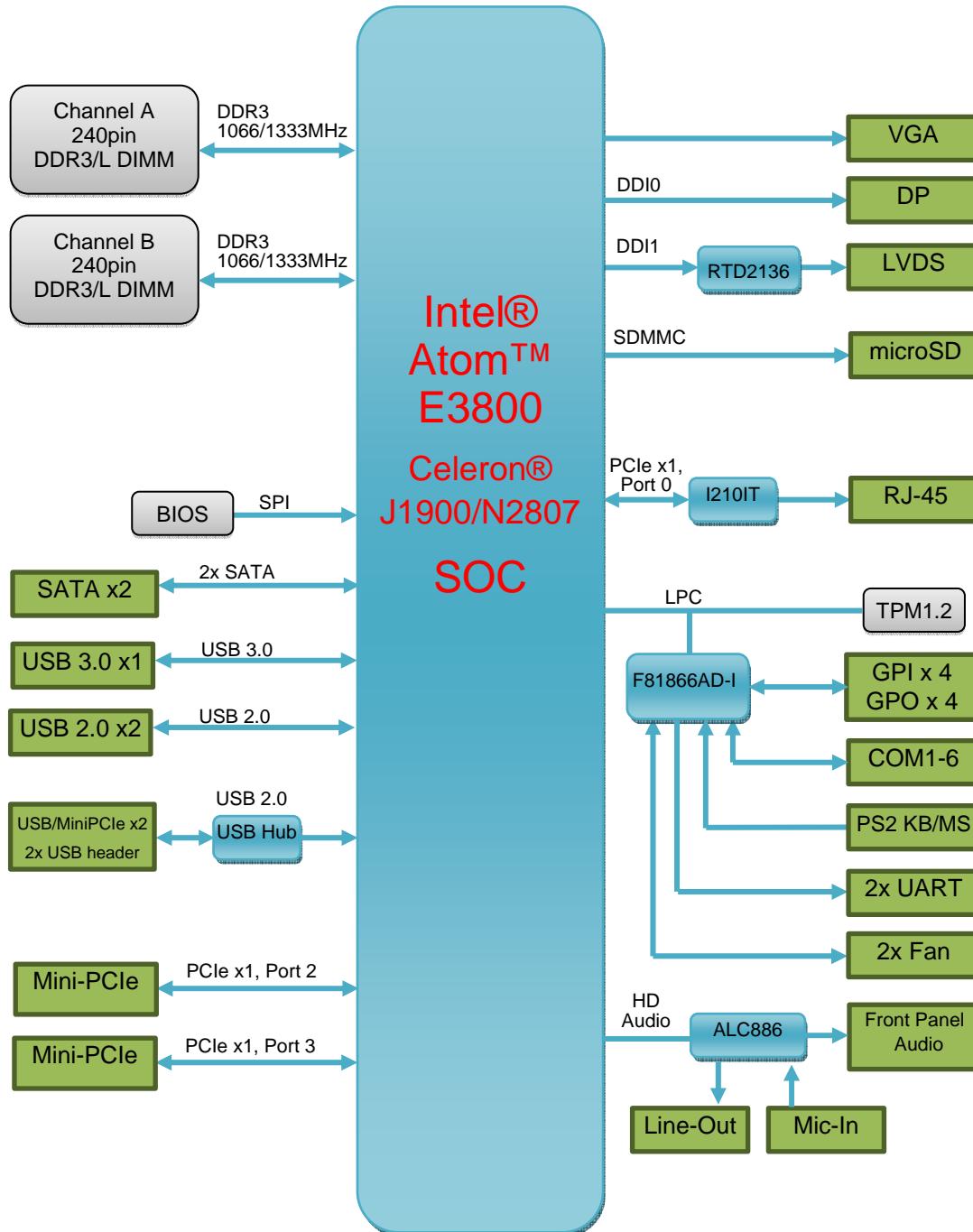

2. Mechanical Specifications

2.1 Dimensions

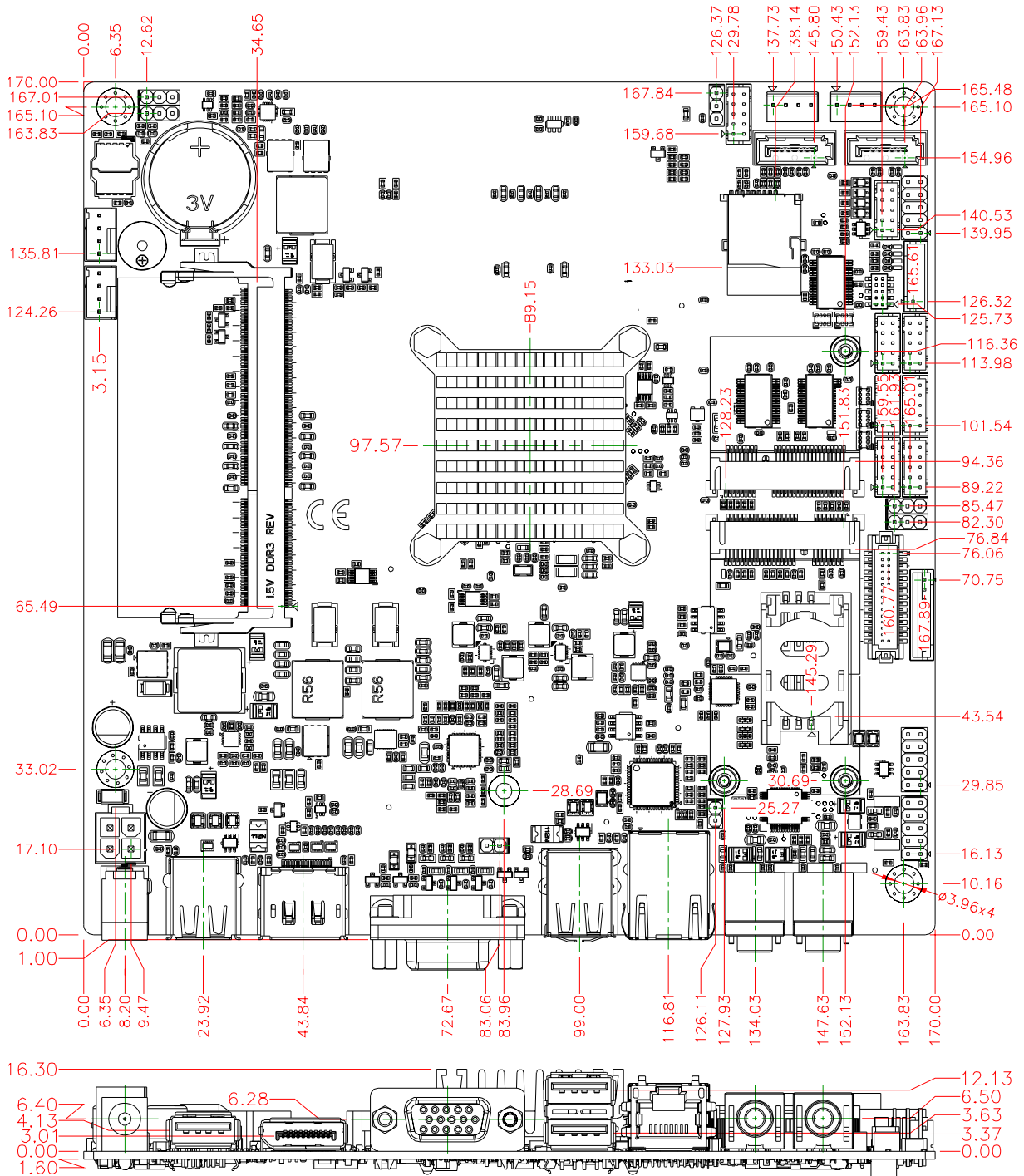

Units: mm

2.2 Board Layout

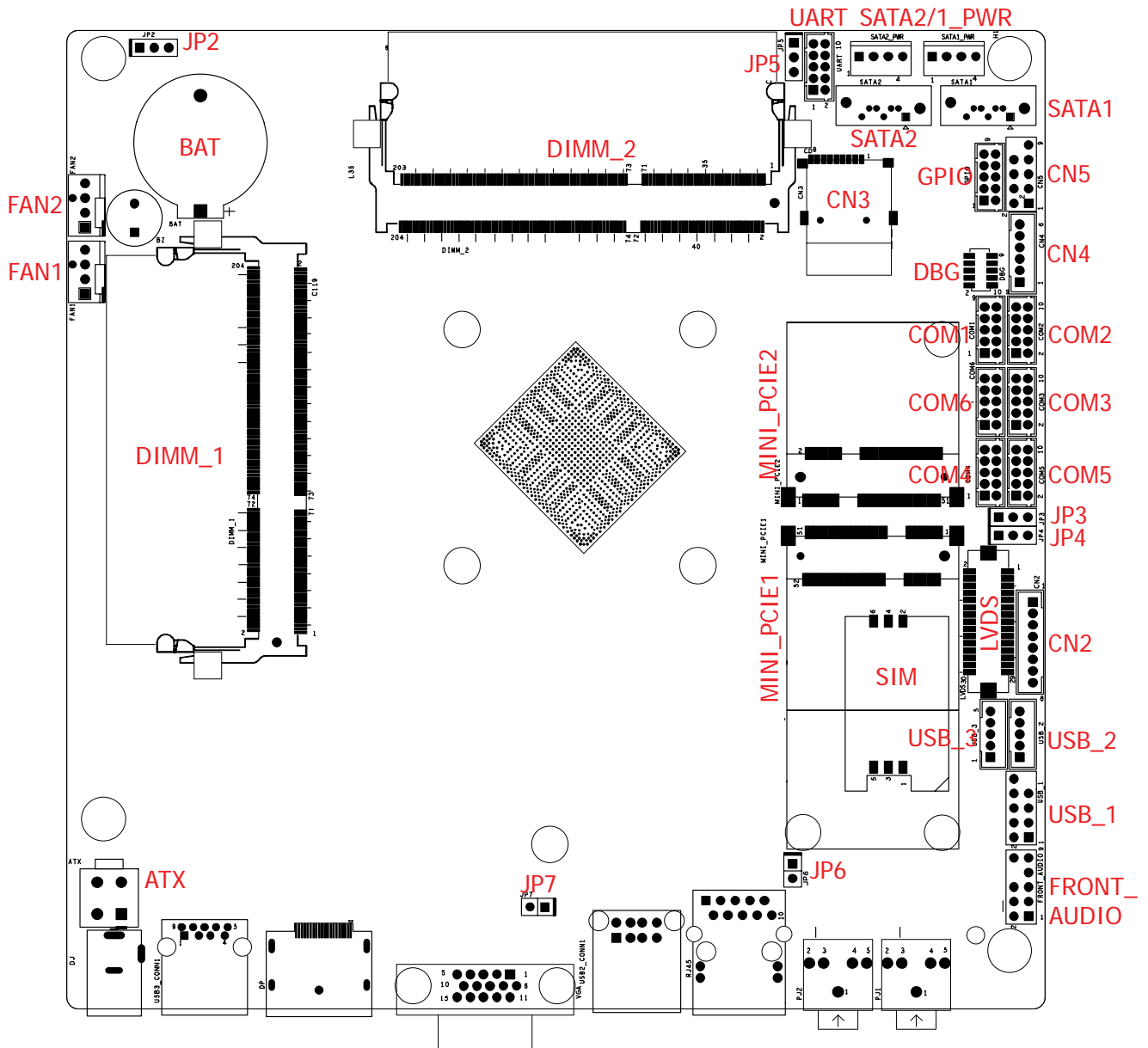

2.2.1 Connectors

Connector	Description
ATX	CPU Power connector
BAT	Battery socket
CN2	Backlight Control connector
CN3	microSD card slot
CN4	PS/2 Keyboard/Mouse wafer connector

Connector	Description
CN5	Front Panel pin header
COM1	COM1 connectors (RS-232/422/485)
COM2~6	COM2~6 connectors (RS-232)
DBG	LPC connector
DIMM_1	240-pin SODIMM socket
DIMM_2	240-pin SODIMM socket
FAN1	CPU fan connector
FAN2	System fan connector
FRONT_AUDIO	Front Audio connector
GPIO	GPIO wafer connector
JP5	I2C pin header
JP6	LAN LED "Link" pin header
JP7	LAN LED "Speed" pin header
LVDS	LVDS connector
MINI_PCIE1	Mini PCI Express slot 1 (full size)
MINI_PCIE2	Mini PCI Express slot 2 (half size)
SATA1	SATA Port 1 signal connector
SATA1_PWR	SATA Port 1 power connector
SATA2	SATA Port 2 signal connector
SATA2_PWR	SATA Port 2 power connector
SIM	SIM card slot
UART	2 UART Serial IO ports wafer connector
USB_1	Two USB 2.0 ports
USB_2	One USB 2.0 port (shared with Mini-PCle)
USB_3	One USB2.0 port (shared with Mini-PCle)

2.2.2 Jumpers

Jumper	Description
JP2	Clear CMOS
JP3	Backlight Power Selection
JP4	Panel Power Selection

2.3 External Connectors

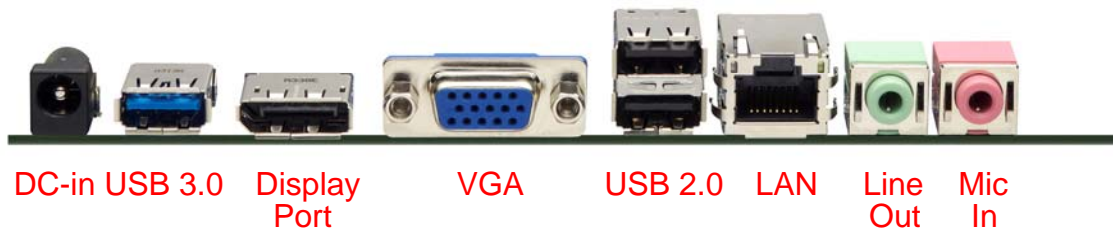

2.3.1 DC Power In

DC-Jack (Ø=2.5mm) for DC +12V power input

2.3.2 USB 3.0 Connector

Pin	Signal	Pin	Signal
1	USB +5V	5	USB_SSRX-
2	USB_D-	6	USB_SSRX+
3	USB_D+	7	GND_DRAIN
4	GND	8	USB_SSTX-
		9	USB_SSTX+

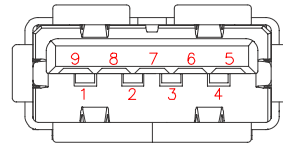

2.3.3 DisplayPort Connector

Pin	Signal	Pin	Signal
1	CN_DP0_P	2	Ground
3	CN_DP0_N	4	CN_DP1_P
5	Ground	6	CN_DP1_N
7	CN_DP2_P	8	Ground
9	CN_DP2_N	10	CN_DP3_P
11	Ground	12	CN_DP3_N
13	CN_CAD-L	14	CN_CEC
15	CN_AUX_P	16	Ground
17	CN_AUX_N	18	DDP_HPDP
19	Ground	20	P3V3

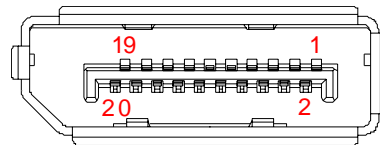

2.3.4 VGA Connector

15-pin D-sub Female Connector

Pin	Signal	Pin	Signal
1	VGA_RED	9	VCC
2	VGA_GRN	10	GND
3	VGA_BLU	11	NC
4	NC	12	VGA_DDC_DAT
5	GND	13	VGA_HSYNC
6	GND	14	VGA_VSYNC
7	GND	15	VGA_DCC_CLK
8	GND		

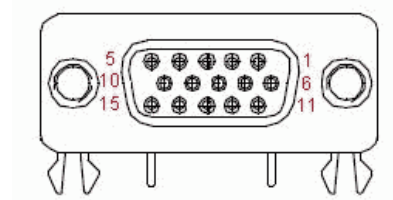

2.3.5 USB 2.0 Connectors

Pin	Signal
1	USB +5V
2	USB_D-
3	USB_D+
4	GND

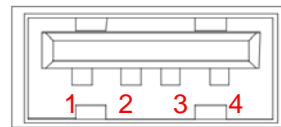

2.3.6 LAN Connector

Pin	Signal	Pin	Signal
1	MDI0+	5	MDI2-
2	MDI0-	6	MDI1-
3	MDI1+	7	MDI3+
4	MDI2+	8	MDI3-
A	Active LED (Yellow)	B	10 LAN LED (OFF) 100 LAN LED (Green) 1000 LAN LED (Orange)

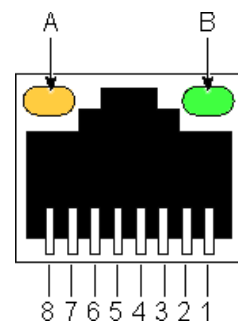

2.3.7 Front Audio Jacks

Pin	Signal
Green	Line-Out
Pink	Mic-In



2.4 Internal Connectors

2.4.1 CPU Power Connector: ATX

Connector Type: 2x2-pin ATX power connector

Pin	Signal	Pin	Signal
1	GND	3	+12V
2	GND	4	+12V



2.4.2 Backlight Control Connector: CN2

Connector Type: 1x8-pin pitch 2.0mm wafer connector

Pin	Signal	Pin	Signal
1	Backlight Enable	2	Backlight CTRL
3	Backlight PWR	4	Backlight PWR
5	GND	6	GND
7	Brightness UP	8	Brightness DOWN

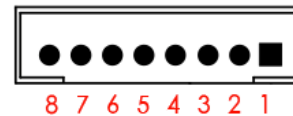

2.4.3 PS/2 Keyboard/Mouse Connector: CN4

Connector Type: 1x6-pin pitch 2.0mm wafer connector

Pin	Signal	Pin	Signal
1	KB_DATA	2	KB_CLK
3	+5V	4	GND
5	MS_DATA	6	MS_CLK

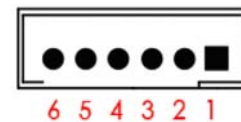

2.4.4 Front Panel Pin Header: CN5

Connector Type: 2x5-pin pitch 2.54mm pin header connector

Pin	Signal	Pin	Signal
1	+5V	2	+5V
3	HDDLED	4	GND
5	GND	6	PWRBT
7	Reset BTN	8	GND
9	+5V	10	Key

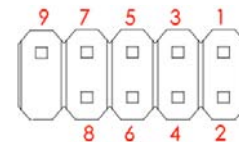

2.4.5 COM1 Serial Port: COM1

Connector Type: 2x5-pin pitch 2.0mm wafer connector

RS-232

Pin	Signal	Pin	Signal
1	DCD, Data Carrier Detect	2	DSR, Data Set Ready
3	RXD, Receive Data	4	RTS, Request To Send
5	TXD, Transmit Data	6	CTS, Clear To Send
7	DTR, Data Terminal Ready	8	RI, Ring Indicator
9	GND	10	NC

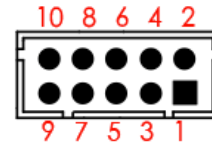

RS-422

Pin	Signal	Pin	Signal
1	TXD-, Transmit Data	2	NA
3	TXD+, Transmit Data	4	NA
5	RXD+, Receive Data	6	NA
7	RXD-, Receive Data	8	NA
9	NA	10	NC

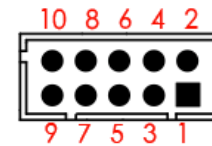

RS-485

Pin	Signal	Pin	Signal
1	Data-, Transmit Data	2	NA
3	Data+, Transmit Data	4	NA
5	NA	6	NA
7	NA	8	NA
9	NA	10	NC

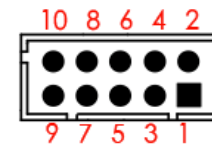

2.4.6 COM2~6 Serial Ports: COM2~6

Connector Type: 2x5-pin pitch 2.0mm wafer connector

RS-232

Pin	Signal	Pin	Signal
1	DCD, Data Carrier Detect	2	DSR, Data Set Ready
3	RXD, Receive Data	4	RTS, Request To Send
5	TXD, Transmit Data	6	CTS, Clear To Send
7	DTR, Data Terminal Ready	8	RI, Ring Indicator
9	GND	10	NC

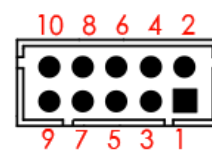

2.4.7 LPC Connector: DBG

Connector Type: 2x5 pin pitch 1.27mm

Pin	Signal	Pin	Signal
1	GND	2	+3.3V
3	LPC_AD3	4	NC
5	LPC_AD2	6	RESET_DBG
7	LPC_AD1	8	CLOCK_DEBUG
9	LPC_AD0	10	LPC_FRAME

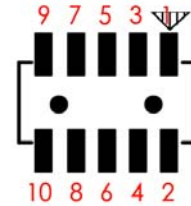

2.4.8 Fan Connectors: FAN1/2

FAN1: CPU Fan; FAN2: System Fan

Pin	Signal
1	GND
2	+12V Fan Power
3	Fan Sensor
4	Fan PWM

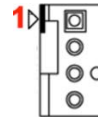

2.4.9 Front Panel Audio Connector: Front_Audio

Connector Type: 2x5-pin pitch 2.54mm pin header connector

Pin	Signal	Pin	Signal
1	MIC-IN-L	2	AGND
3	MIC-IN-R	4	PRESENCE#
5	LINE-IN-R	6	MIC-IN Detect
7	SENSE_SEND	8	KEY
9	LINE-IN-L	10	LINE-IN Detect

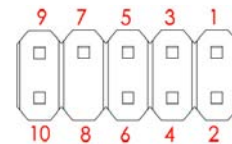

2.4.10 GPIO Connector: GPIO

Connector Type: 2x5-pin pitch 2.0mm wafer connector

Pin	Signal	Pin	Signal
1	+5V	2	GND
3	GPO0	4	GPI0
5	GPO1	6	GPI1
7	GPO2	8	GPI2
9	GPO3	10	GPI3

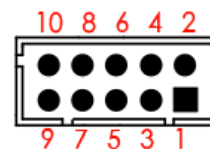

2.4.11 I2C Pin Header: JP5

Connector Type: 1x3-pin pitch 2.54mm pin header connector

Pin	Signal
1	CLOCK
2	GND
3	DATA

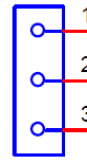

2.4.12 LAN LED "Link" Pin Header: JP6

Connector Type: 1x2-pin pitch 2.54mm pin header connector

Pin	Signal
1	+3.3V
2	LINK/ACTIVE



2.4.13 LAN LED "Speed" Pin Header: JP7

Connector Type: 1x2-pin pitch 2.54mm pin header connector

Pin	Signal
1	Speed 100
2	Speed 1000



2.4.14 LVDS Connector: LVDS

Connector Type: 2x15pin pitch1.25mm LVDS connector

Pin	Signal	Pin	Signal
1	LVDS_B3-	2	LVDS_B3+
3	LVDS_B_CLK-	4	LVDS_B_CLK+
5	LVDS_B2-	6	LVDS_B2+
7	LVDS_B1-	8	LVDS_B1+
9	LVDS_B0-	10	LVDS_B0+
11	LVDS_I2C_DAT	12	LVDS_I2C_CK
13	GND	14	GND
15	GND	16	GND
17	LVDS_A3+	18	LVDS_A3-
19	LVDS_A_CLK+	20	LVDS_A_CLK-
21	LVDS_A2+	22	LVDS_A2-
23	LVDS_A1+	24	LVDS_A1-
25	LVDS_A0+	26	LVDS_A0-
27	Panel PWR	28	Panel PWR
29	Panel PWR	30	Panel PWR
31	GND	32	GND



2.4.15 Mini-PCle Connectors: MINI_PCIE1/2

Pin	Signal	Pin	Signal	Pin	Signal
1	WAKE#	19	Reserved	37	Reserved
2	+3.3V	20	Reserved	38	USB_D+
3	Reserved	21	GND	39	Reserved
4	GND	22	PERST#	40	GND
5	Reserved	23	PERn0	41	Reserved
6	+1.5V	24	+3.3Vaux	42	LED_WWAN#
7	CLKREQ#	25	PERp0	43	Reserved
8	UIM_PWR	26	GND	44	LED_WLAN#
9	GND	27	GND	45	Reserved
10	UIM_DATA	28	+1.5V	46	LED_WPAN#
11	REFCLK-	29	GND	47	Reserved
12	UIM_CLK	30	SMB_CLK	48	+1.5V
13	REFCLK+	31	PETn0	49	Reserved
14	UIM_RESET	32	SMB_DATA	50	GND
15	GND	33	PETp0	51	Reserved
16	UIM_VPP	34	GND	52	+3.3V
17	Reserved	35	GND	53	GND
18	GND	36	USB_D-	54	GND

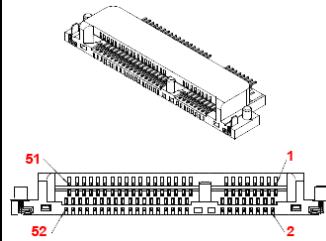

2.4.16 SATA Signal Connectors: SATA1~2

Connector Type: 7-pin SATA connector

Pin	Signal
1	GND
2	SATA_TX+
3	SATA_TX-
4	GND
5	SATA_RX-
6	SATA_RX+
7	GND

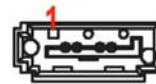

2.4.17 SATA Power Connectors: SATA1_PWR/ SATA2_PWR

Connector Type: 4-pin pitch 2.54mm connector

Pin	Signal
1	+5V
2	GND
3	GND
4	+12V

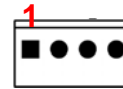

2.4.18 UART Serial IO Connector: UART

Connector Type: 2x5-pin pitch 2.0mm wafer connector

Pin	Signal	Pin	Signal
1	+3.3V	2	GND
3	UART1_RXD	4	UART2_RXD
5	UART1_TXD	6	UART2_TXD
7	UART1_RTS	8	UART2_RTS
9	UART1_CTS	10	UART2_CTS

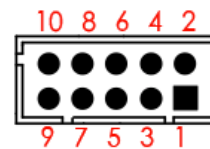

2.4.19 USB 2.0 Pin Header: USB_1

Connector Type: 2x5-pin pitch 2.54mm pin header connector

Pin	Signal	Pin	Signal
1	USB +5V	2	USB +5V
3	USB_D-	4	USB_D-
5	USB_D+	6	USB_D+
7	GND	8	GND
9	KEY	10	N.C.

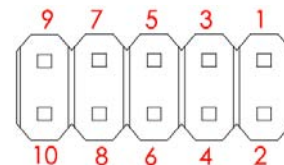

2.4.20 USB 2.0 Wafer Connector: USB_2/USB_3

Connector Type: 2x5-pin pitch 2.54mm pin header connector

Pin	Signal
1	USB +5V
2	USB_D-
3	USB_D+
4	GND
5	N.C.

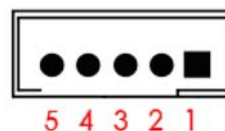

2.5 Jumper Settings

2.5.1 Clear CMOS: JP2

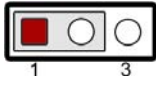
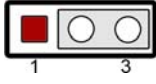
Function	Setting	Jumper
Normal (Default)	1-2 closed	
Clear CMOS	2-3 closed	

2.5.2 Backlight Power: JP3

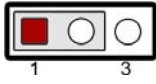
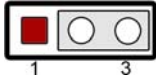
Function	Setting	Jumper
+12V	1-2 closed	
+5V (Default)	2-3 closed	

2.5.3 Panel Power: JP4

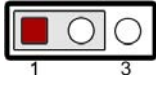
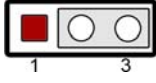
Function	Setting	Jumper
+3.3V (Default)	1-2 closed	
+5V	2-3 closed	

3. Features & Interfaces

3.1 Processor

The cPCI-3620 Series supports the Intel® Atom™ processor E3800 Series which utilizes 22nm process technology with 3-D Tri-Gate transistors to deliver significant improvement in computational performance and energy-efficiency. Based on a new micro-architecture, the processor is designed for a one-chip platform. This system-on-chip (SoC) solution platform brings enhanced graphics, greater performance, lower cost, easier validation, and improved x-y footprint to a broad range of intelligent systems. The processor includes an Integrated Display Engine, Processor Graphics and Integrated Memory Controller.

3.2 BIOS

AMI uEFI BIOS on 8MB SPI Flash ROM is used on the CT-XBT0x.

3.3 System Memory

The Integrated Memory Controller (IMC) of the processor supports single channel, non-ECC, unbuffered DDR3L-1333 memory up to 8GB with data transfer rates up to 1333MT/s.

3.4 Graphics

The graphics is integrated in the processor and based on Intel® HD Graphics 4000 technology, enabling substantial gains in performance and lower power consumption.

- DirectX 11 support
- OpenGL 4.0 support
- Graphics Base Frequency: 542 MHz
- Graphics Max Dynamic Frequency: 792 MHz
- Full HD video playback
- Maximum resolution of 2560x1600@60Hz

LVDS support is provided by a Realtek RTD2136R-CG DP-to-LVDS converter with dual channel 24-bit output up to 1920x1200 resolution.

3.5 USB

The CT-XBT0x supports 1x USB 3.0 and 2x USB 2.0 external ports, and 4x internal USB 2.0 ports (2 shared with Mini-PCIe).

3.6 Ethernet

The CT-XBT0x features 1x 10/100/1000BASE-TX Ethernet by Intel 1210IT GbE Controller supporting WOL/PXE.

3.7 SATA

The CT-XBT0x supports 2x SATA 3Gb/s ports.

3.8 Audio

The CT-XBT0x supports HD audio via Realtek ALC886 codec.

3.9 Expansion

The CT-XBT0x provides the following expansion interfaces.

- 2x Mini-PCIe slots
- 1x microSD card slot
- 1x SIM card slot

3.10 General Purpose Input Output

GPI and GPO pins may be implemented as GPIO. GPI and GPO pins may be implemented as SDIO.

Signal	I/O	Description
GPO[0:3]	O	General purpose output pins. Upon a hardware reset, these outputs should be low.
GPI[0:3]	I	General purpose input pins. Pulled high internally on the Module.

3.10.1 GPIO Configuration

Board Design

Pin#	GPIO#	Default Configuration
1		VCC3
2		GND
3	DIO_PH_OUT0	GPO0
4	DIO_PH_IN0	GPI0
5	DIO_PH_OUT1	GPO1
6	DIO_PH_IN1	GPI1
7	DIO_PH_OUT2	GPO2
8	DIO_PH_IN2	GPI2
9	DIO_PH_OUT3	GPO3
10	DIO_PH_IN3	GPI3

Notes

1. Output pin default setting is **"HIGH"**

The GPIO function is provided by a Fintek F81866 AD-I, and it can be accessed through its GPIO index/data port. The index port is the base address +0 and the data port is the base address +1. To access the GPIO register, write index to the index port, and then read/write from/to data port. The configuration on the CT- XBT0x is described as below.

Index Port	0xA00
Data Port	0xA01

Registers Description

GPIO Input/Output Select

- GPIO8x Configuration Registers

(Index port=0xA00, Data port=0xA01, Offset=0x88)

Bit 7	Bit 6	Bit 5	Bit 4	Bit 3	Bit 2	Bit 1	Bit 0
GPO3	GPO2	GPO1	GPO0	GPI3	GPI2	GPI1	GPI0

Note.

Bit X = 0 means Input Mode

Bit X = 1 means Output Mode

GPIO Output Data Select

- GPIO Output Data Register

(Index port=0xA00, Data port=0xA01, Offset=0x89)

Bit 7	Bit 6	Bit 5	Bit 4	Bit 3	Bit 2	Bit 1	Bit 0
GPO3	GPO2	GPO1	GPO0	GPI3	GPI2	GPI1	GPI0

Note.

Bit X = 0 outputs 0 when in output mode

Bit X = 1 outputs 1 when in output mode

3.11 Watchdog Timer

3.11.1 Board Design

The Watchdog Timer (WDT) is implemented by Fintek F81866AD-I.

Register	Address
WDT Base Address	0xA10

3.11.2 Psuedo Code

■ Set WDT Time Unit (Second Unit)

Step1: <i>ByteData = ReadIOByte(0xA15)</i>	<i>//Read current setting</i>
Step2: <i>ByteData = ByteData & 0xF7</i>	<i>//Set time unit to "second"</i>
Step3: <i>WriteIOByte(0xA15, ByteData)</i>	<i>//Write back</i>

■ Set WDT Time Value

Step1: <i>WriteIOByte(0xA16, Time)</i>	<i>//Set watch dog time value</i>
--	-----------------------------------

■ Enable WDT

Step1: <i>ByteData = ReadIOByte(0xA15)</i>	<i>//Read current setting</i>
Step2: <i>ByteData = ByteData 0x20</i>	<i>//Enable WDT</i>
Step3: <i>WriteIOByte(0xA15, ByteData)</i>	<i>//Write back</i>

4. Driver Installation

The drivers for the CT-XBT0x can be found on the driver DVD included with the system.

Install the following drivers in the order listed.

1. Chipset
2. Graphics
3. Audio
4. LAN
5. Intel Trusted Execution Engine (Intel TXE)
6. Intel Sideband Fabric Device (Intel MBI)
7. Intel Serial IO
8. Intel Processor IO Controllers
9. USB 3.0
10. TPM

5. System BIOS

The system BIOS software is stored on EEPROM. The BIOS provides an interface to modify the configuration. When the battery is removed, all the parameters will be reset.

Turn on the computer and press or <F2> to enter the setup screens.

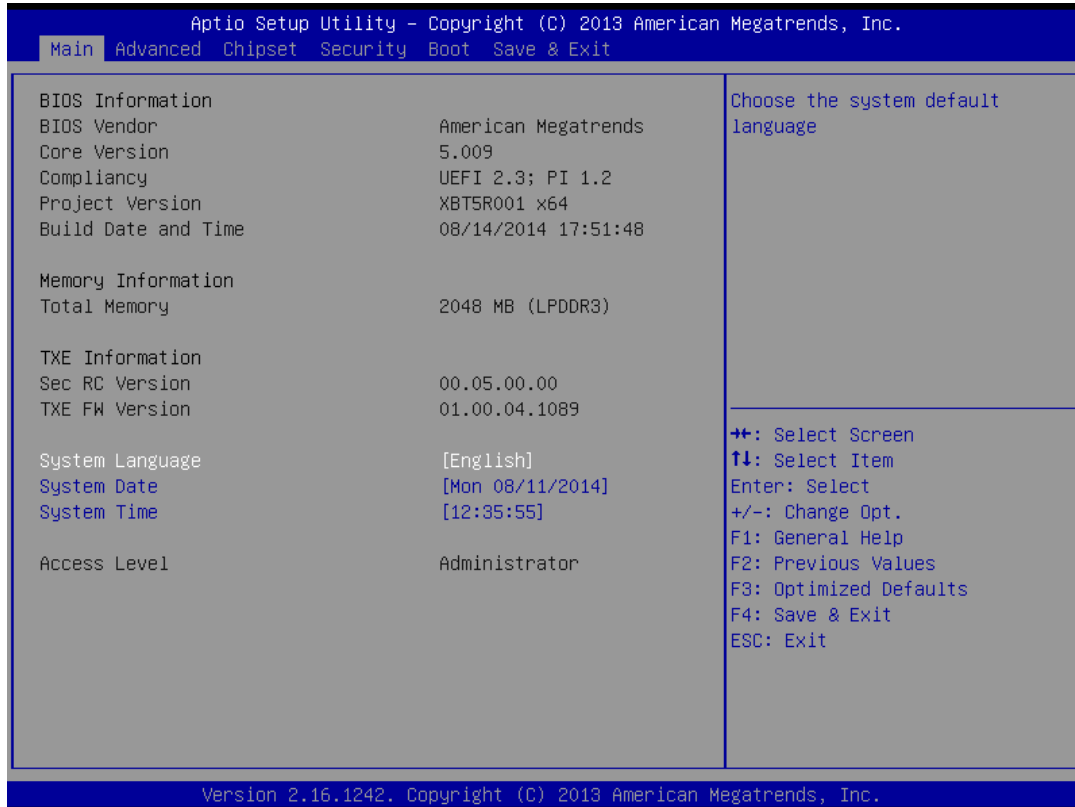

System Date: MM/DD/YYYY

System Time: HH:MM:SS

Use Tab to switch between Date and Time elements.

5.1 Advanced

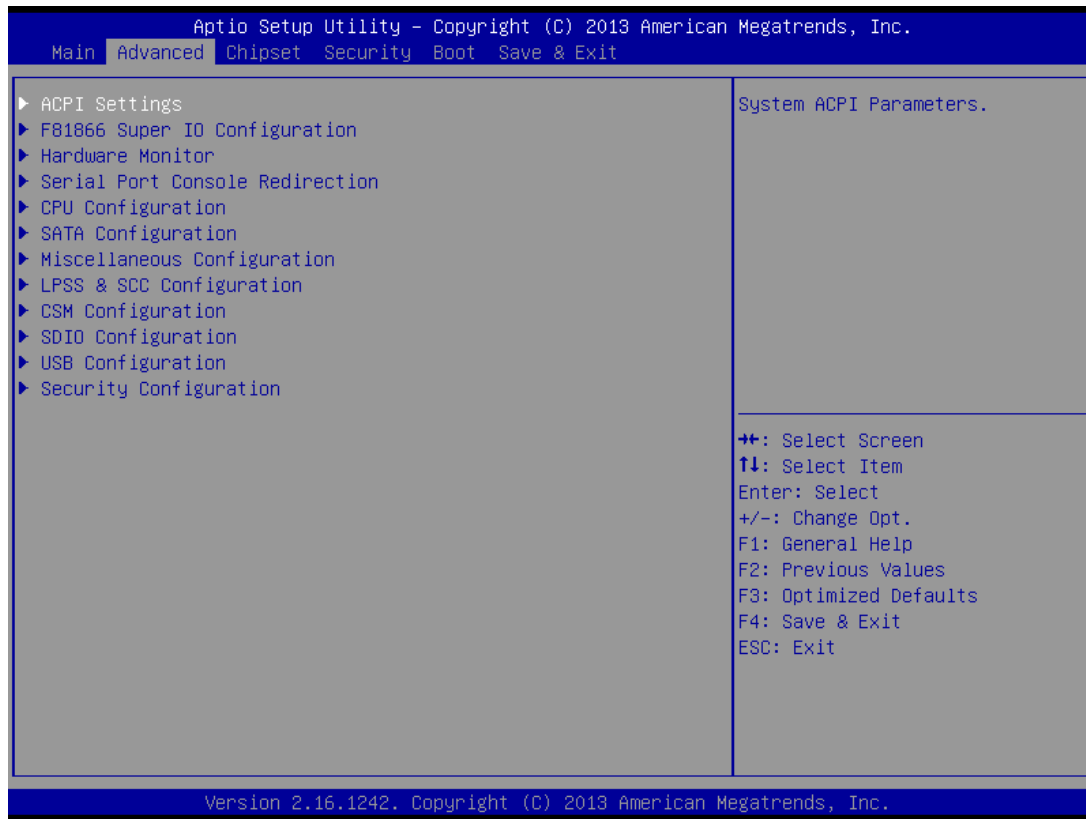

5.1.1 ACPI Settings

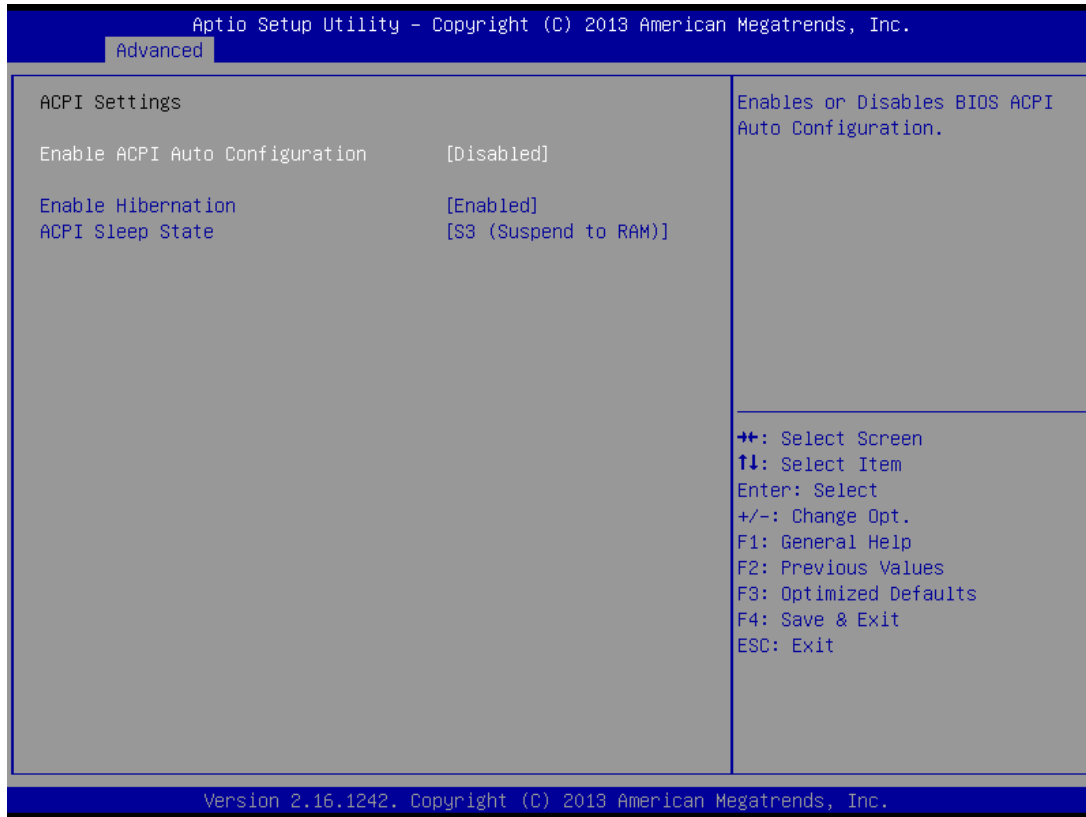

Enable ACPI Auto Configuration: Enables or disables BIOS ACPI Auto Configuration.

Enable Hibernation: Enable or Disable system ability to Hibernate.

ACPI Sleep state: Select the highest ACPI sleep state the system will enter when the SUSPEND button is pressed. Options: Suspend Disable, S3 (Suspend to RAM).

5.1.2 F81866 Super IO Configuration

Enable/disable and configure the serial ports.

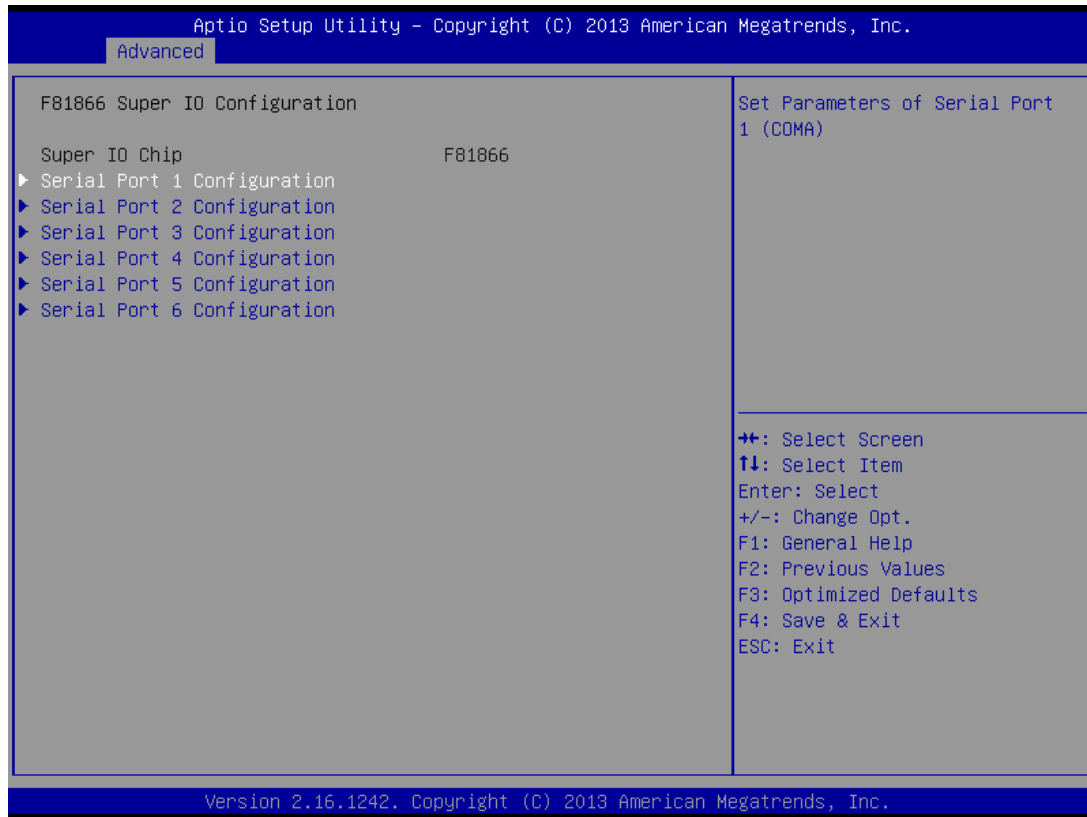

5.1.2.1 Serial Port 1 Configuration

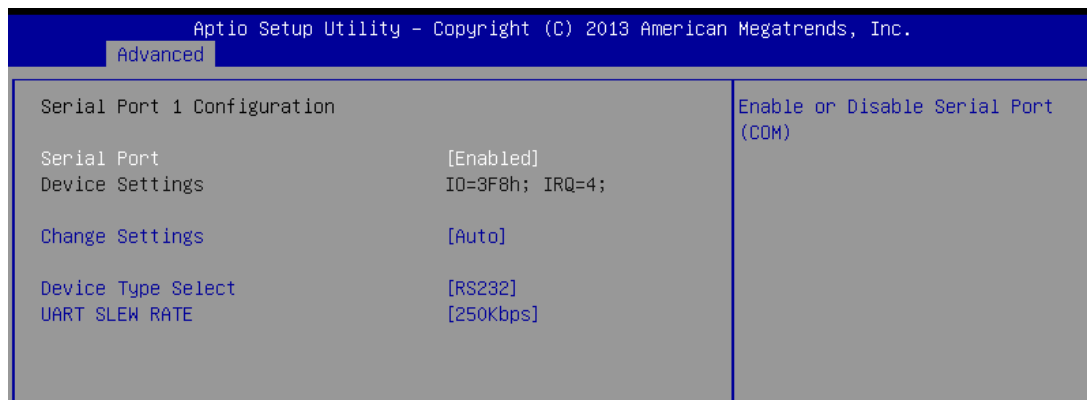

Device Type Select: Choose from RS-232, RS-422 and RS-485.

5.1.2.2 Serial Port 2~6 Configuration

Aptio Setup Utility - Copyright (C) 2013 American Megatrends, Inc.

Advanced

<p>Serial Port 2 Configuration</p> <p>Serial Port [Enabled]</p> <p>Device Settings ID=2F8h; IRQ=3;</p> <p>Change Settings [Auto]</p>	<p>Enable or Disable Serial Port (COM)</p> <hr/> <p> ++: Select Screen ↑↓: Select Item Enter: Select +/-: Change Opt. F1: General Help F2: Previous Values F3: Optimized Defaults F4: Save & Exit ESC: Exit </p>
--	--

Version 2.16.1242. Copyright (C) 2013 American Megatrends, Inc.

5.1.3 Hardware Monitor

Aptio Setup Utility - Copyright (C) 2013 American Megatrends, Inc.

Advanced

<p>Pc Health Status</p> <p>CPU Temperature : +28 °C</p> <p>System Temperature : +25 °C</p> <p>Fan1 Speed : N/A</p> <p>Fan2 Speed : N/A</p> <p>VCORE : +0.752 V</p> <p>VIO : +1.813 V</p> <p>VDDR : +1.366 V</p> <p>VIN : +12.144 V</p> <p>VCC3V3 : +3.344 V</p> <p>VCC5V : +5.112 V</p>	<hr/> <p> ++: Select Screen ↑↓: Select Item Enter: Select +/-: Change Opt. F1: General Help F2: Previous Values F3: Optimized Defaults F4: Save & Exit ESC: Exit </p>
---	---

Version 2.16.1242. Copyright (C) 2013 American Megatrends, Inc.

5.1.4 Serial Port Console Redirection

Serial port console redirection settings.

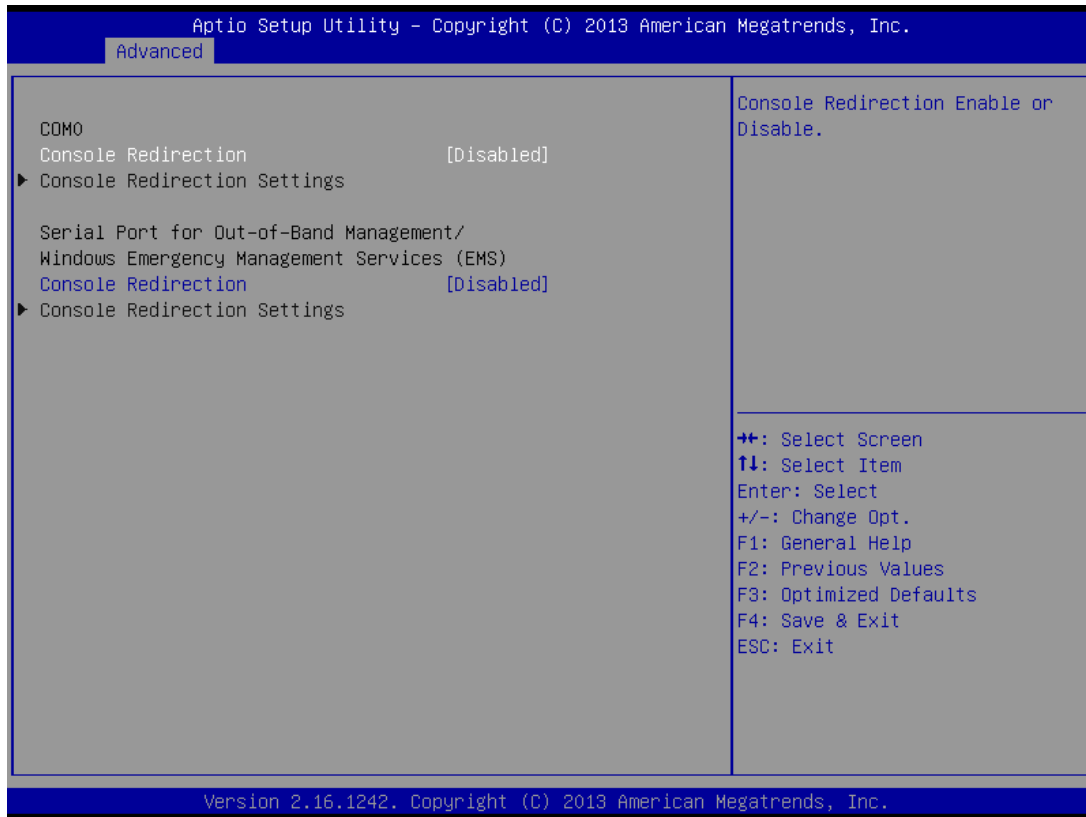

5.1.5 CPU Configuration

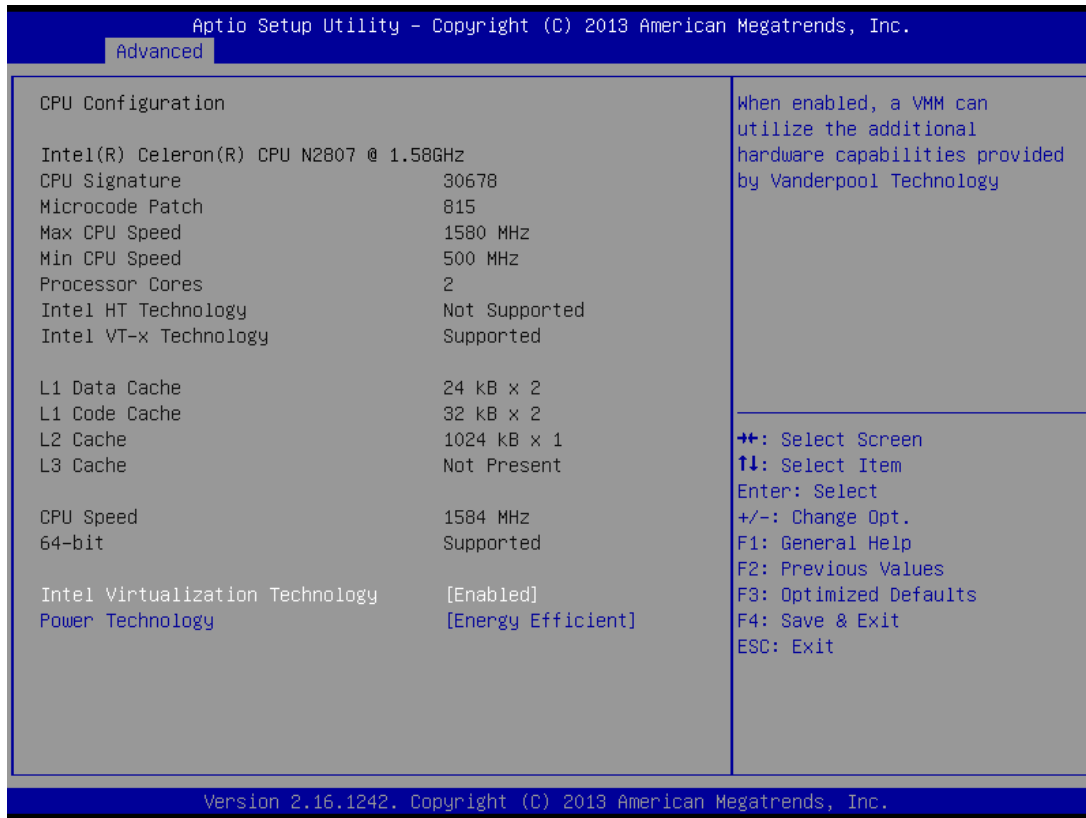

Intel Virtualization Technology: When enabled, a VMM can utilize the additional hardware capabilities provided by Vanderpool Technology

Execute Disable Bit: XP can prevent certain classes of malicious buffer overflow attacks when combined with a supporting OS (Windows Server 2003 SP1, Windows XP SP2, SusE Linux 9.2, RedHat Enterprise 3 Update 3.)

Power Technology: Configure the power management features.

5.1.6 SATA Configuration

The BIOS automatically detects the presence of SATA device and the hardware installed in the SATA ports will be showed in the configuration. Each port can be enabled or disabled individually.

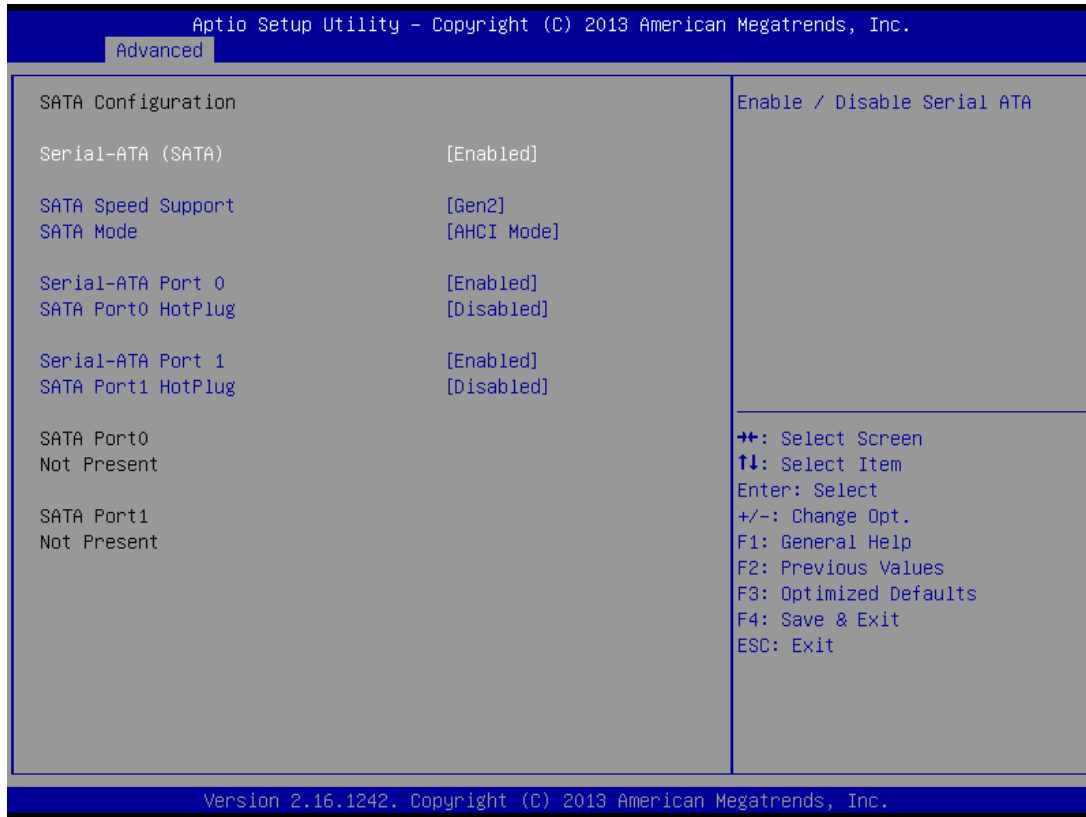

SATA Speed Support: Options: Gen 1, Gen 2.

SATA Mode: Select IDE or AHCI Mode

SATA Port Hot Plug: Enable/disable the port as Hot Pluggable.

5.1.7 Miscellaneous Configuration

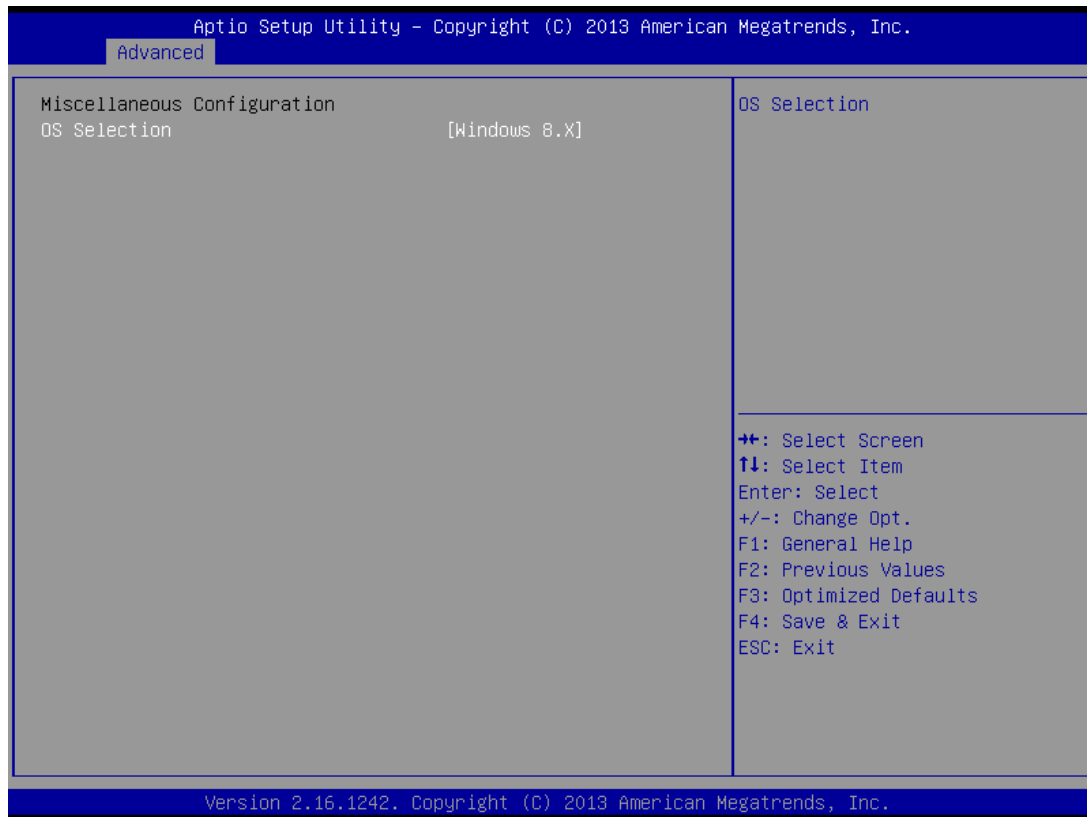

OS Selection: Select the OS.

5.1.8 LPSS & SCC Configuration

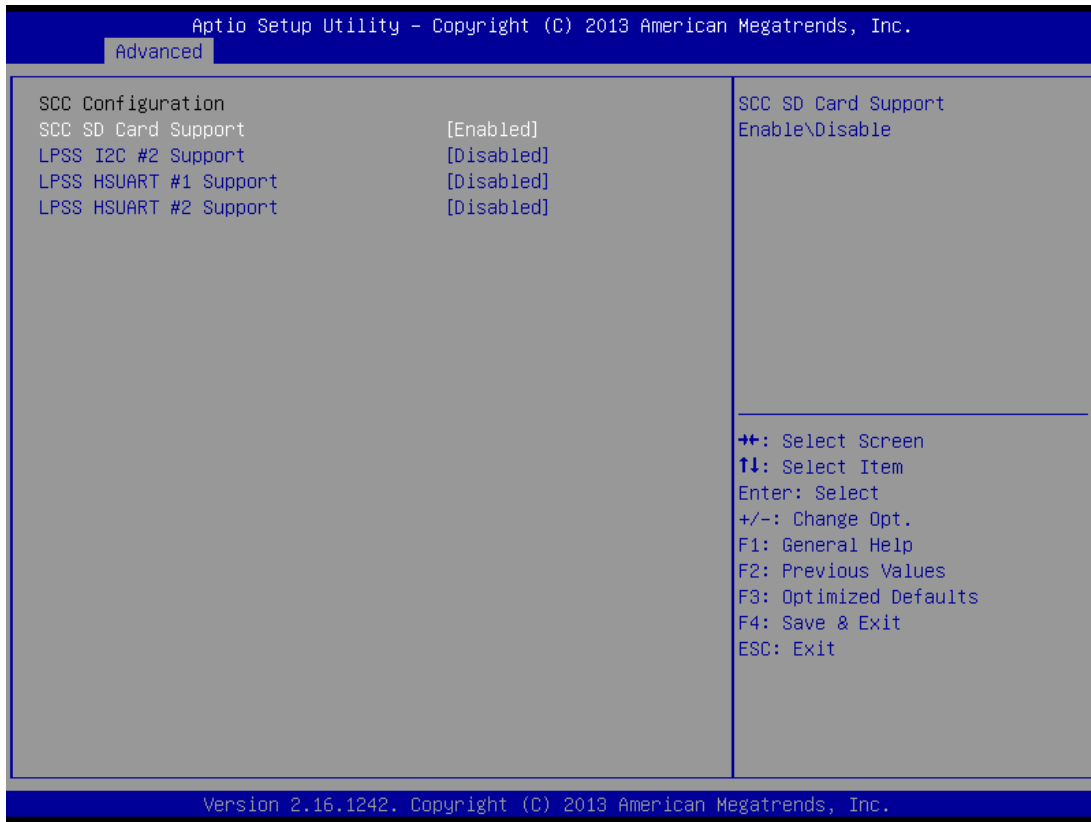

SCC SD Card Support: Options: Disable, Enable.

LPSS I2C #2 Support: Options: Disable, Enable.

LPSS HSUART Support: Options: Disable, Enable.

5.1.9 CSM Configuration

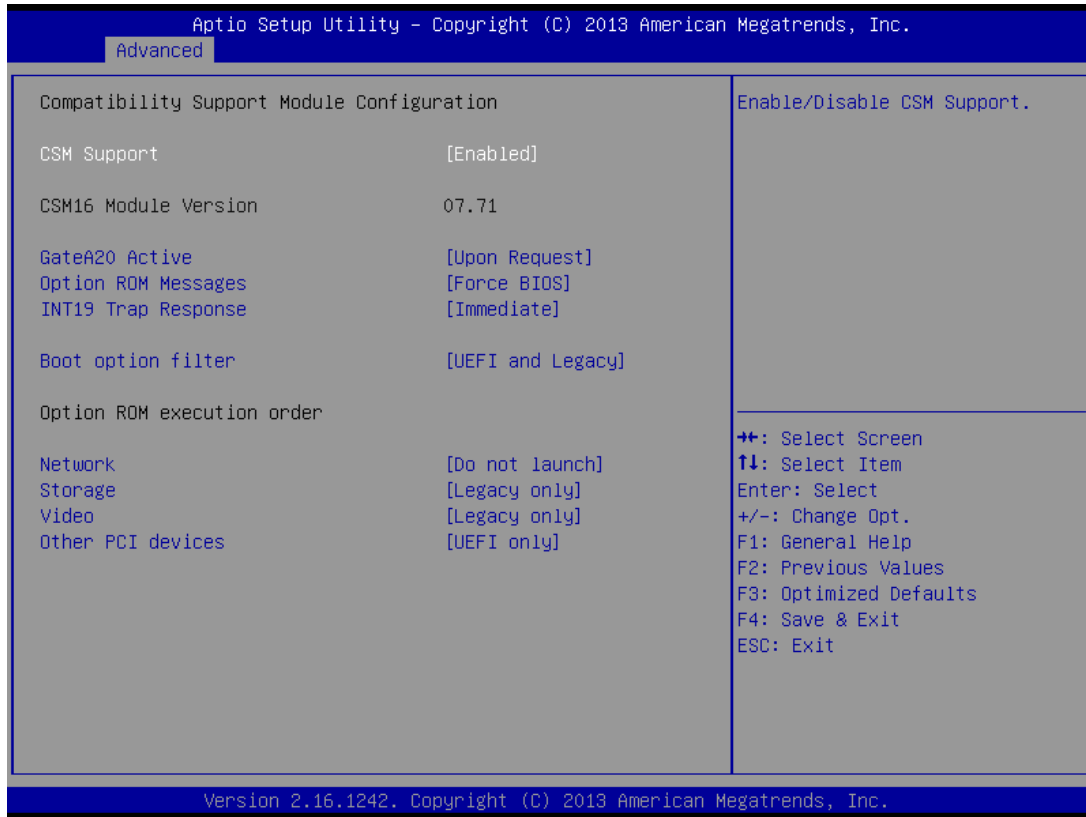

GateA20 Active:

[Upon Request] – GA20 can be disabled using BIOS services.

[Always] – do not allow disabling GA20; this option is useful when any RT code is executed above 1MB.

Option ROM Message: Set display mode [Force BIOS] or [Keep Current] for Option ROM.

INT19 Trap Response: BIOS reaction on INT19 trapping by Option ROM: IMMEDIATE – execute the trap right away; POSTPONED – execute the traps during legacy boot.

Boot option filter: This option controls what devices system can boot to [UEFI and Legacy], [Legacy only] or [UEFI only].

Option ROM Execution Order: Controls the execution Option ROM, [Do not launch], [UEFI only] or [Legacy only].

5.1.10 SDIO Configuration

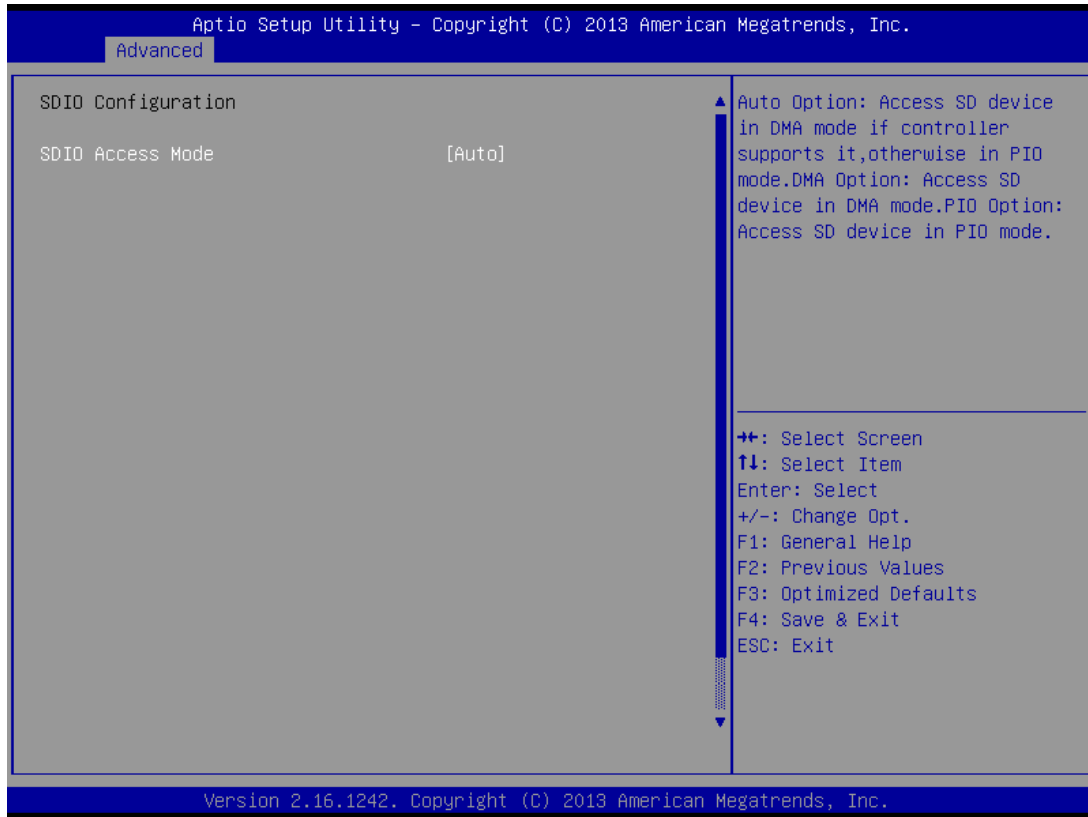

SDIO Access Mode: Auto Option: Access SD device in DMA mode if controller supports it, otherwise in PIO mode. DMA Option: Access SD device in DMA mode. PIO Option: Access SD device in PIO mode.

5.1.11 USB Configuration

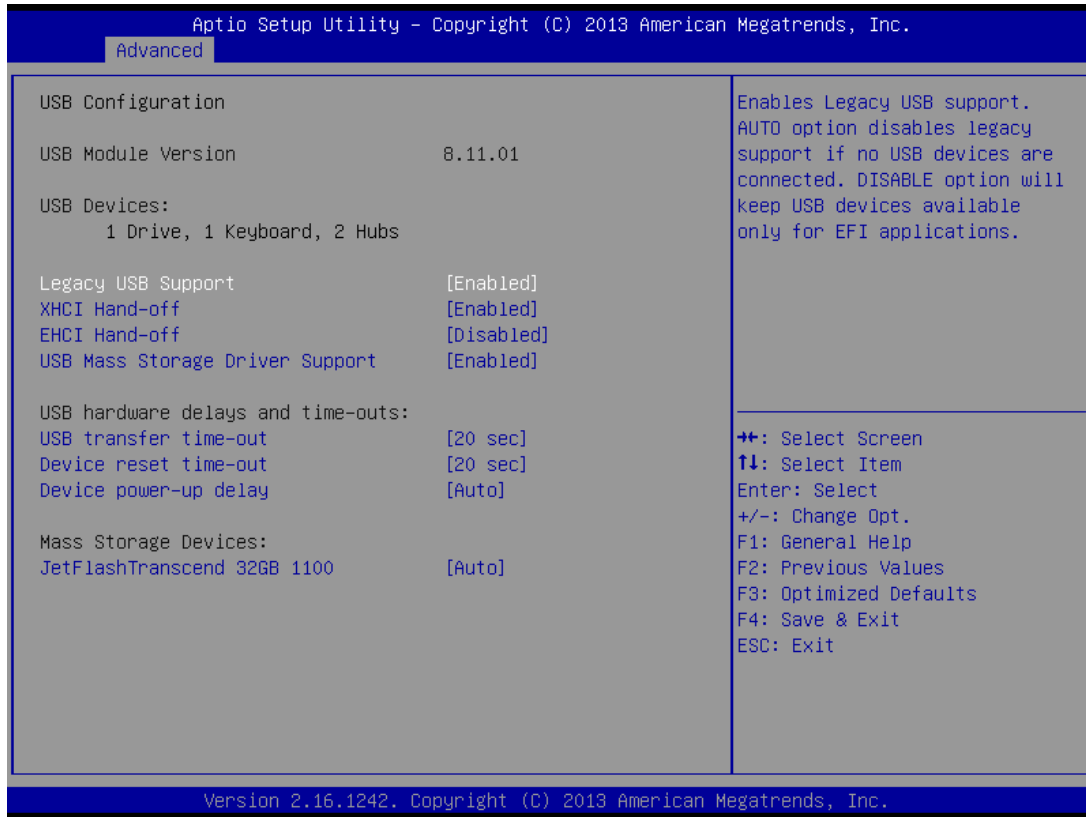

Legacy USB Support: Auto option disables legacy support if no USB devices are connected. Disable option will keep USB devices available only for EFI applications.

XHCI Hand-off: This is a workaround for OSeS without XHCI hand-off support. The XHCI ownership change should be claimed by XHCI driver.

EHCI Hand-off: This is a workaround for OSeS without EHCI hand-off support. The EHCI ownership change should be claimed by EHCI driver.

USB Mass Storage Driver Support: Enable/Disable USB Mass Storage Driver Support.

USB transfer time-out: The time-out value for Control, Bulk, and Interrupt transfers.

Device reset time-out: USB mass storage device Start Unit command time-out.

Device power-up delay: Maximum time the device will take before it properly reports itself to the Host Controller. "Auto" uses default value: for a Root port it is 100ms, for a Hub port the delay is taken from Hub descriptor.

5.1.12 Security Configuration

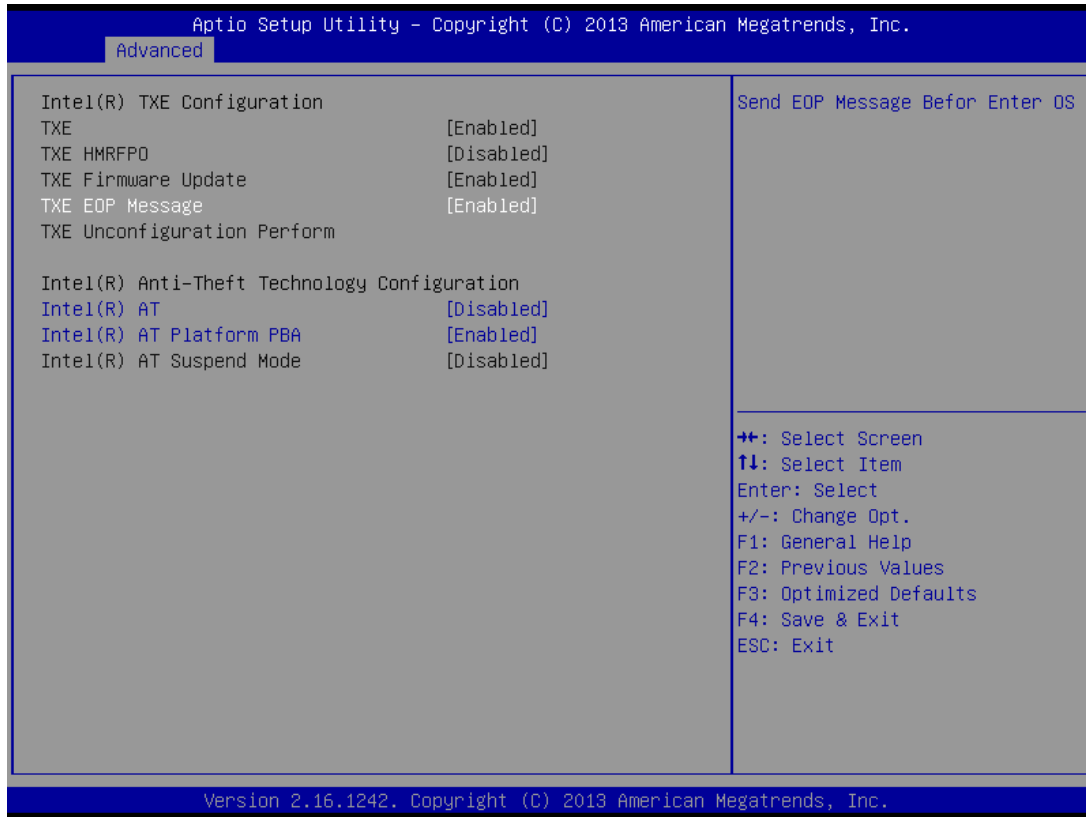

TXE EOP Message: Send EOP Message Before Enter OS.

Intel® AT: Enable/Disable BIOS AT Code from Running.

Intel® AT Platform PBA: Enable/Disable BIOS AT Code from Running.

5.2 Chipset

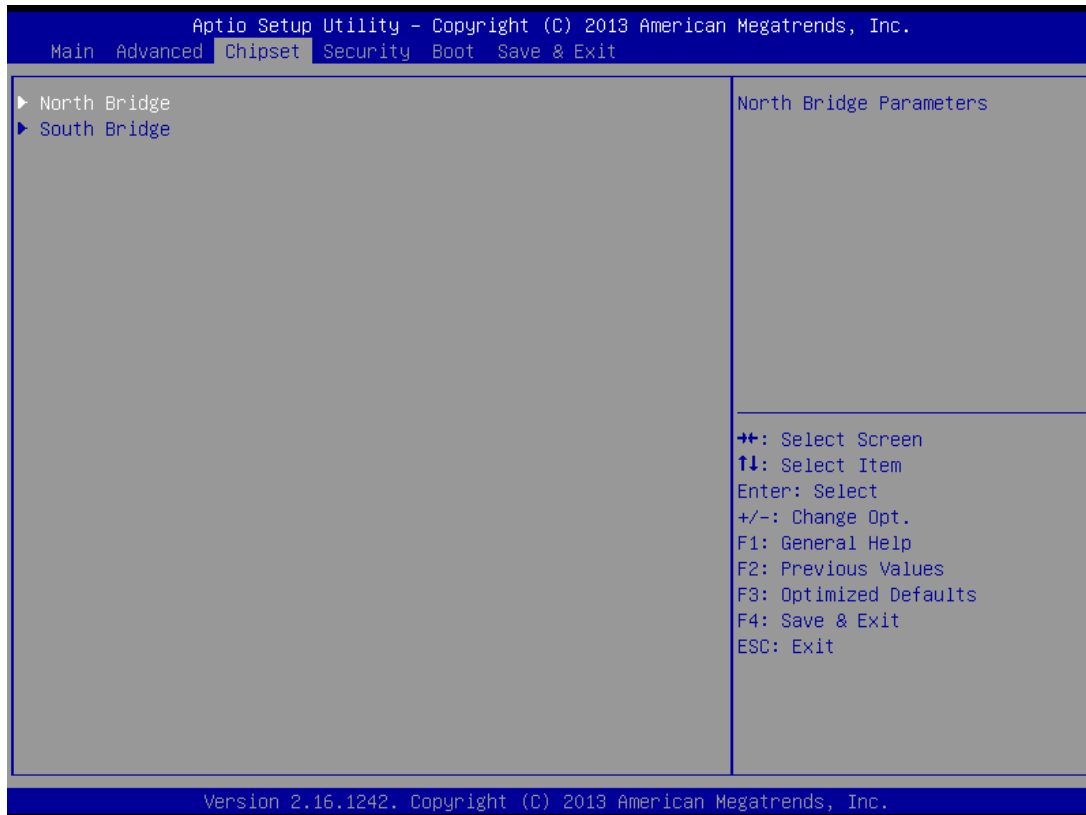

5.2.1 Northbridge Configuration

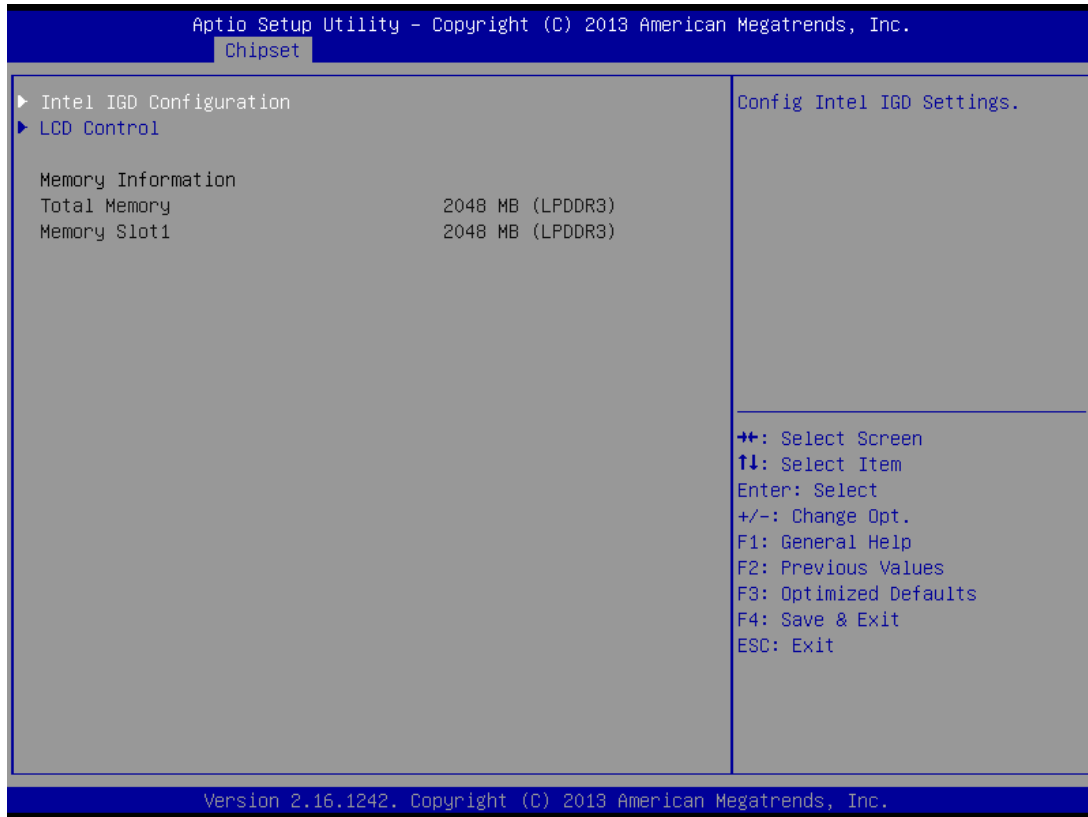

5.2.1.1 Intel IGD Configuration

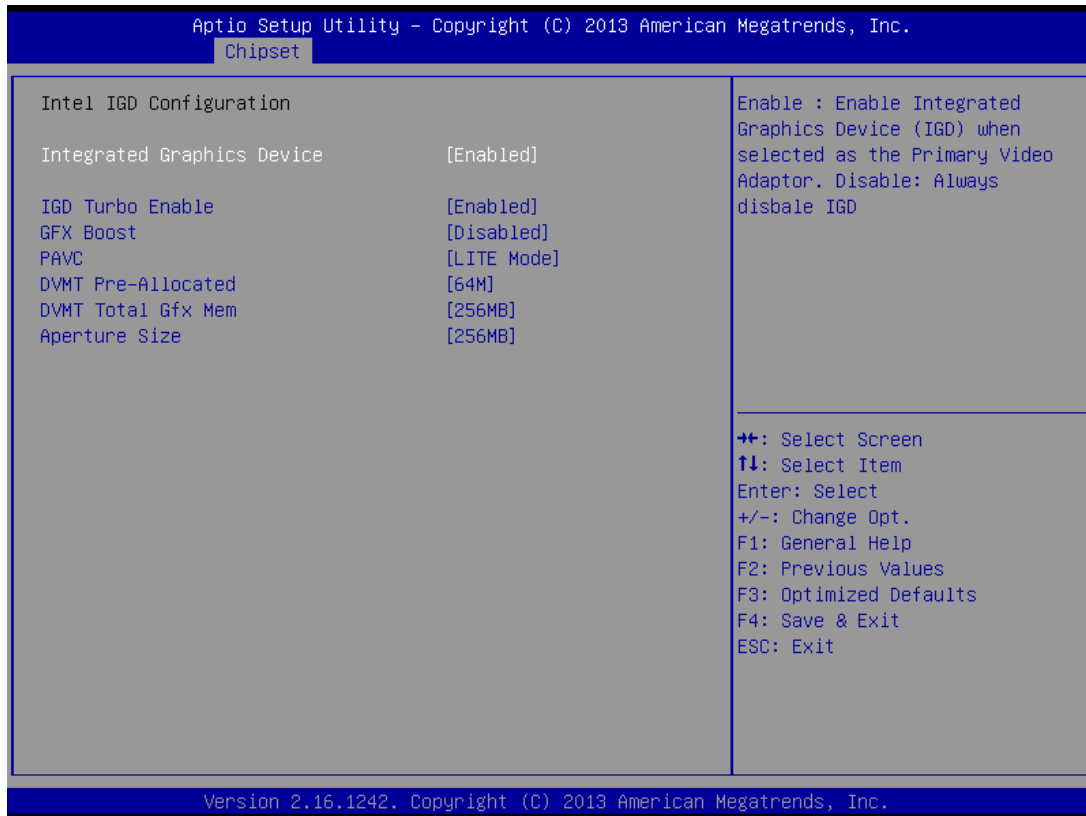

Integrated Graphics Device: Enable: Enable Integrated Graphics Device (IGD) when selected as the Primary Video Adaptor. Disable: Always disable IGD.

IGD Turbo Enable: Enable/Disable: IGD Turbo.

GFX Boost: Enable/Disable GFX Boost.

PAVC: Enable/Disable Protected Audio Video Control.

DVMT Pre-Allocated: Select DVMT 5.0 Pre-Allocated (Fixed) Graphics Memory size used by the Internal Graphics Device.

DVMT Total Gfx Mem: Select DVMT 5.0 Total Graphics Memory size used by the Internal Graphics Device.

Aperture Size: Select the Aperture Size.

5.2.1.2 LCD Control



Primary IGFX Boot Display: Default setting is “VBIOS Default”. “CRT”selects VGA, “EFP” selects DisplayPort, “LFP” selects LVDS.

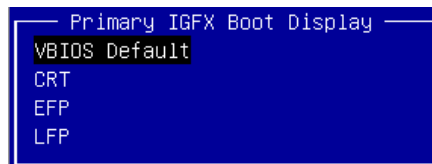

LCD Panel Type: Default setting is “1024x768 LVDS2”.

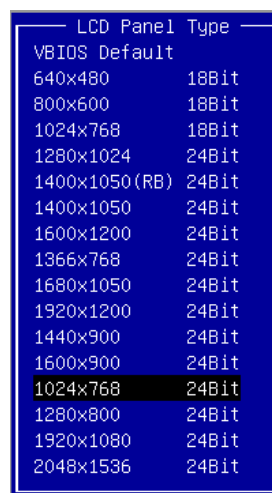

5.2.2 Southbridge Configuration

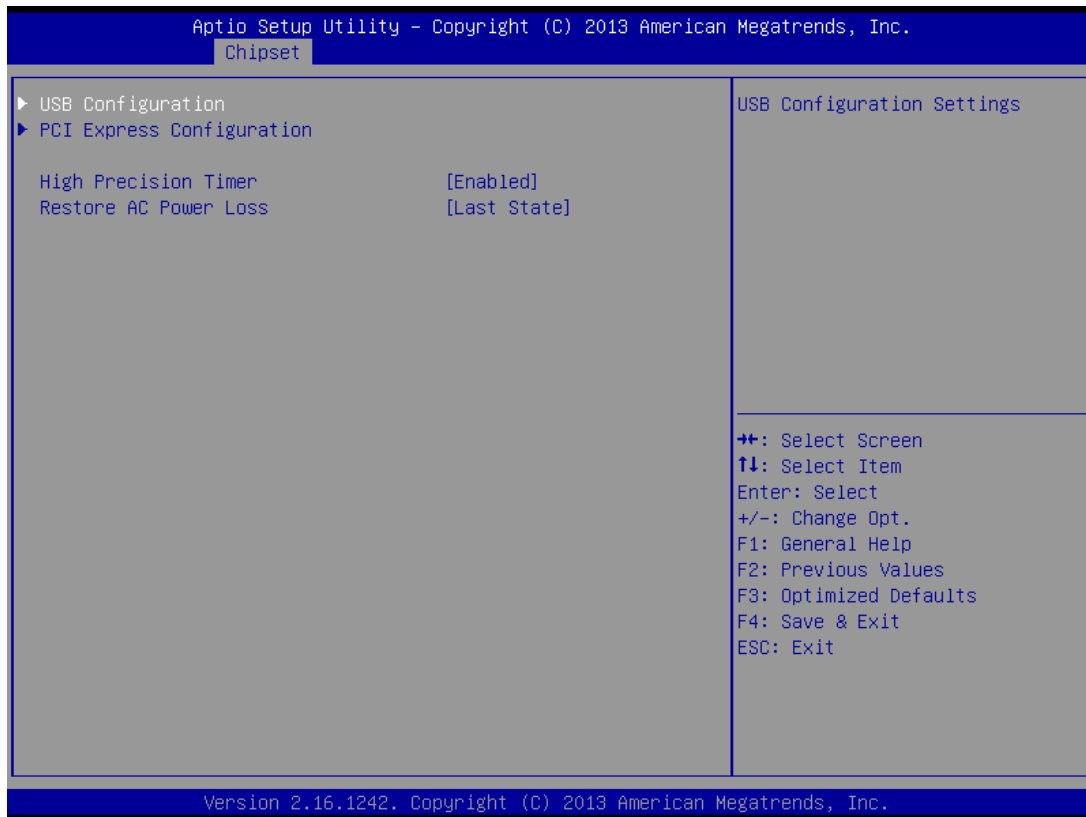

High Precision Timer: Enable or Disable the High Precision Event Timer.
Restore AC Power Loss: Select AC power state when power is re-applied after a power failure.

5.2.2.1 USB Configuration

```

Aptio Setup Utility - Copyright (C) 2013 American Megatrends, Inc.
Chipset
-----
USB Configuration
XHCI Mode                [Disabled]
USB 2.0(EHCI) Support    [Enabled]
USB RMH Mode             [Enabled]
USB EHCI debug           [Disabled]
USB Per Port Control     [Enabled]
USB Port 0 (USB3_CONN1)  [Enabled]
USB Port 1 (USB2_CONN1)  [Enabled]
USB Port 2 (USB2_CONN1)  [Enabled]
USB Port 3 (USB Onboard HUB) [Enabled]

Control the USB EHCI (USB 2.0)
functions. One EHCI
controller must always be
enabled

--+: Select Screen
↑↓: Select Item
Enter: Select
+/-: Change Opt.
F1: General Help
F2: Previous Values
F3: Optimized Defaults
F4: Save & Exit
ESC: Exit

Version 2.16.1242. Copyright (C) 2013 American Megatrends, Inc.

```

5.2.2.2 PCI Express Configuration

Aptio Setup Utility - Copyright (C) 2013 American Megatrends, Inc.		
Chipset		
PCI Express Configuration		Enable or Disable the PCI Express Port 0 in the Chipset. ⇄: Select Screen ↑↓: Select Item Enter: Select +/-: Change Opt. F1: General Help F2: Previous Values F3: Optimized Defaults F4: Save & Exit ESC: Exit
PCI Express Port 0	[Enabled]	
Hot Plug	[Disabled]	
Speed	[Auto]	
PCI Express Port 2	[Enabled]	
Hot Plug	[Disabled]	
Speed	[Auto]	
PCI Express Port 3	[Enabled]	
Hot Plug	[Disabled]	
Speed	[Auto]	
Version 2.16.1242. Copyright (C) 2013 American Megatrends, Inc.		

5.3 Security

Administrator's and User's passwords could be set.

If ONLY the Administrator's password is set, then this only limits access to Setup and is only asked for when entering Setup. If ONLY the User's password is set, then this is a power on password and must be entered to boot or enter Setup. In Setup, the user will have administrator rights. The minimum length of the password is 3 and the maximum length is 20.

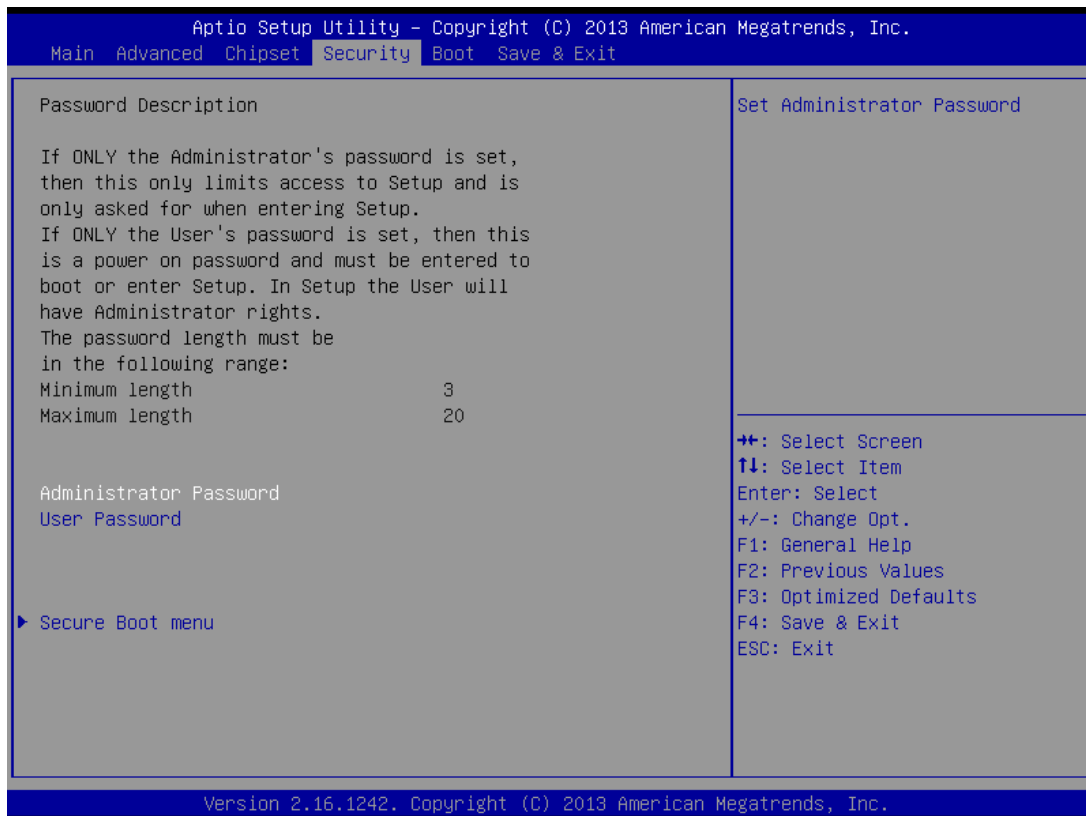

5.3.1 Secure Boot Menu

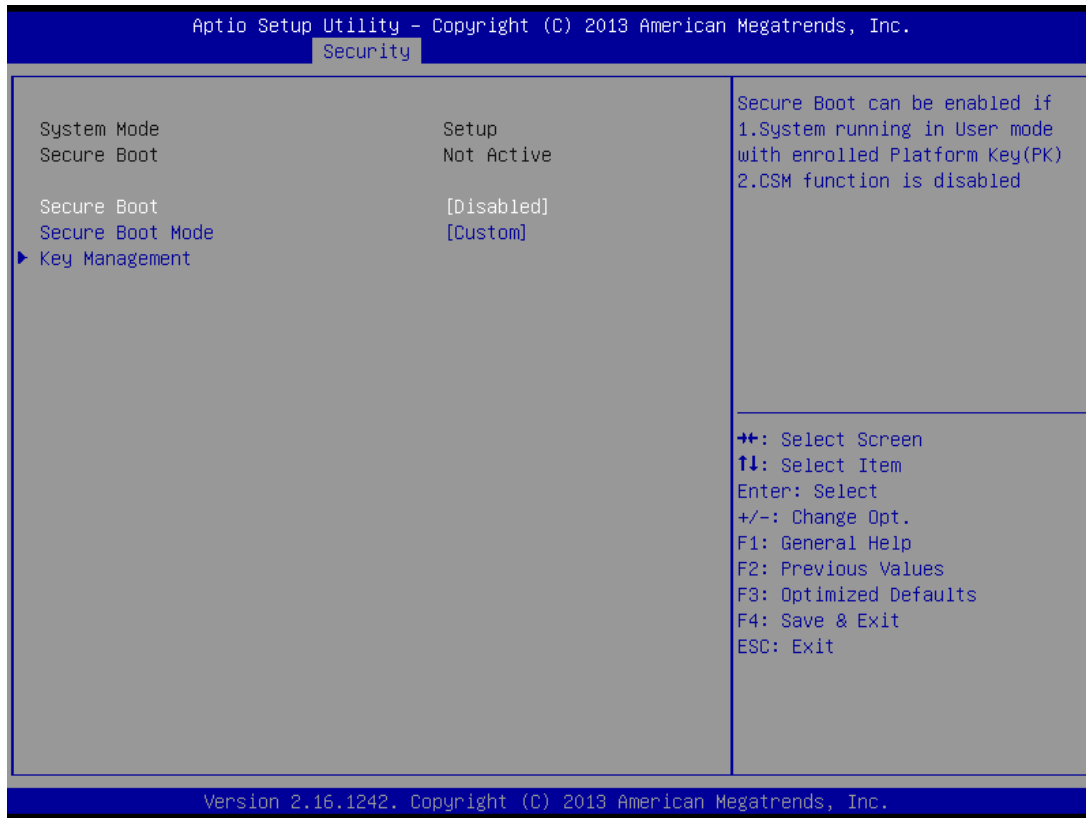

Secure Boot: Secure Boot can be enabled if the System running in User mode with enrolled Platform Key (PK) and CSM function is disabled.

Secure Boot Mode: Secure Boot mode selector. 'Custom' Mode enables users to change Image Execution policy and manage Secure Boot Keys.

5.4 Boot

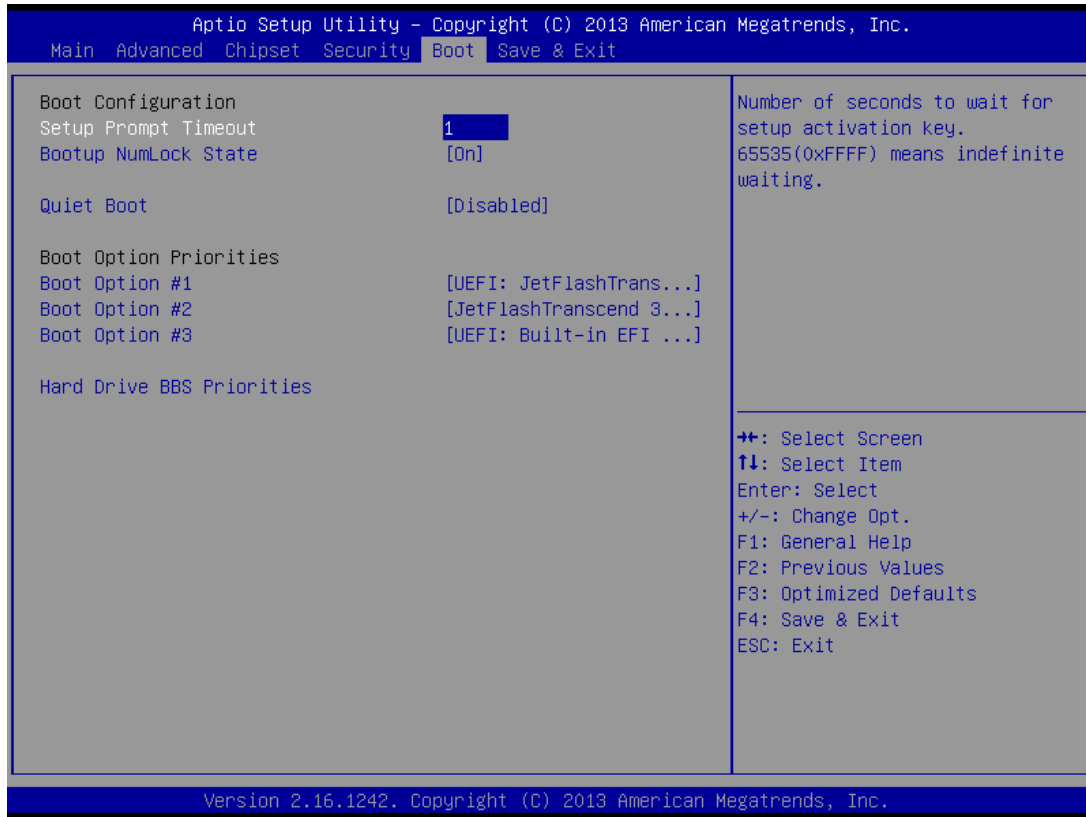

Setup Prompt Timeout: Number of seconds to wait for setup activation key. 65535 (0xFFFF) means indefinite waiting.

Bootup NumLock State: Select [Enable] or [Disable] for the keyboard NumLock state.

Quiet Boot: Enables or disables Quiet Boot option.

Boot Order Priorities: Set the system boot order.

Hard Drive BBS Priorities: Set the order of the legacy devices in this group.

5.5 Save and Exit

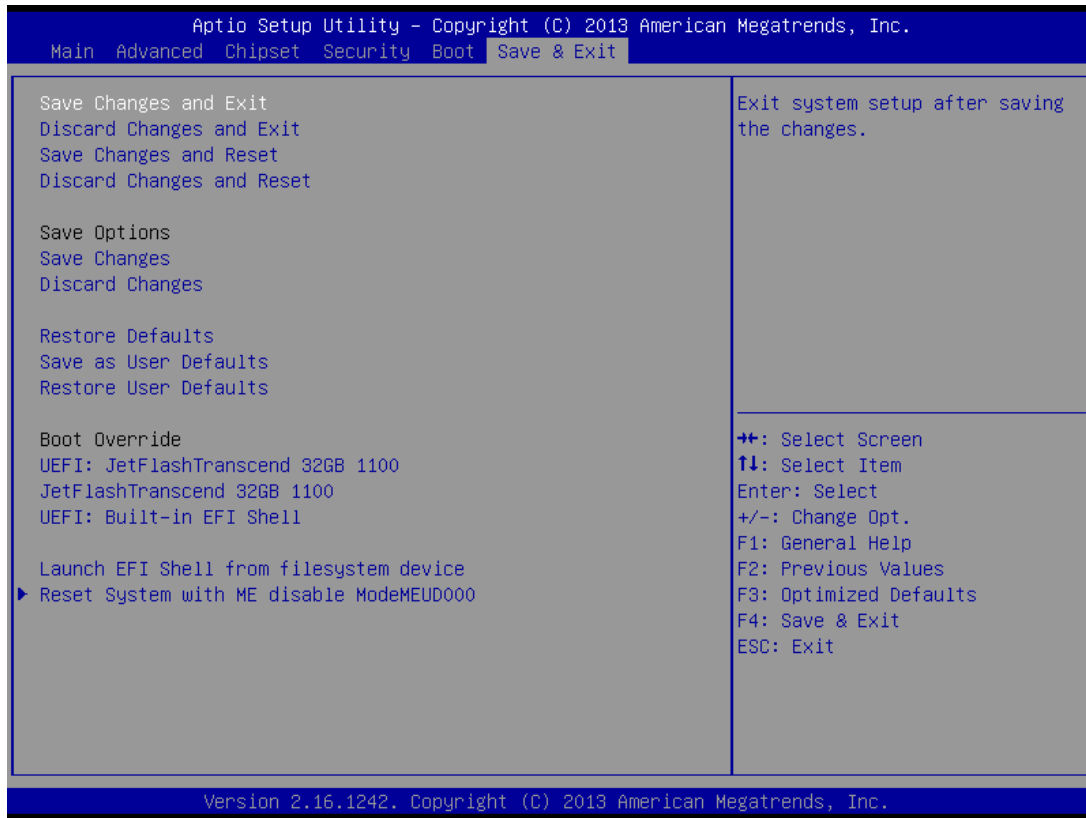

6. Address Map

6.1 I/O Port Address Map

The assignments of the I/O port addresses for the CT-XBT0x under Windows® 7 Ultimate 64-bit are shown below.

Input/output (IO)	
[0000000000000000 - 000000000000006F]	PCI Express Root Complex
[0000000000000020 - 0000000000000021]	Programmable interrupt controller
[0000000000000024 - 0000000000000025]	Programmable interrupt controller
[0000000000000028 - 0000000000000029]	Programmable interrupt controller
[000000000000002C - 000000000000002D]	Programmable interrupt controller
[0000000000000030 - 0000000000000031]	Programmable interrupt controller
[0000000000000034 - 0000000000000035]	Programmable interrupt controller
[0000000000000038 - 0000000000000039]	Programmable interrupt controller
[000000000000003C - 000000000000003D]	Programmable interrupt controller
[0000000000000040 - 0000000000000043]	System timer
[000000000000004E - 000000000000004F]	Motherboard resources
[0000000000000050 - 0000000000000053]	System timer
[0000000000000060 - 0000000000000060]	Standard PS/2 Keyboard
[0000000000000061 - 0000000000000061]	Motherboard resources
[0000000000000063 - 0000000000000063]	Motherboard resources
[0000000000000064 - 0000000000000064]	Standard PS/2 Keyboard
[0000000000000065 - 0000000000000065]	Motherboard resources
[0000000000000067 - 0000000000000067]	Motherboard resources
[0000000000000070 - 0000000000000070]	Motherboard resources
[0000000000000070 - 0000000000000077]	System CMOS/real time clock
[0000000000000078 - 00000000000000CF7]	PCI Express Root Complex
[0000000000000080 - 000000000000008F]	Motherboard resources
[0000000000000092 - 0000000000000092]	Motherboard resources
[00000000000000A0 - 00000000000000A1]	Programmable interrupt controller
[00000000000000A4 - 00000000000000A5]	Programmable interrupt controller
[00000000000000A8 - 00000000000000A9]	Programmable interrupt controller
[00000000000000AC - 00000000000000AD]	Programmable interrupt controller
[00000000000000B0 - 00000000000000B1]	Programmable interrupt controller
[00000000000000B2 - 00000000000000B3]	Motherboard resources
[00000000000000B4 - 00000000000000B5]	Programmable interrupt controller
[00000000000000B8 - 00000000000000B9]	Programmable interrupt controller
[00000000000000BC - 00000000000000BD]	Programmable interrupt controller
[00000000000002E0 - 00000000000002E7]	Communications Port (COM6)
[00000000000002E8 - 00000000000002EF]	Communications Port (COM4)
[00000000000002F0 - 00000000000002F7]	Communications Port (COM5)
[00000000000002F8 - 00000000000002FF]	Communications Port (COM2)
[00000000000003E8 - 00000000000003EF]	Communications Port (COM3)
[00000000000003F8 - 00000000000003FF]	Communications Port (COM1)
[0000000000000400 - 000000000000047F]	Motherboard resources
[00000000000004D0 - 00000000000004D1]	Programmable interrupt controller
[0000000000000500 - 00000000000005FE]	Motherboard resources
[0000000000000680 - 000000000000069F]	Motherboard resources
[0000000000000A00 - 0000000000000A0F]	Motherboard resources
[0000000000000A10 - 0000000000000A1F]	Motherboard resources
[0000000000000A20 - 0000000000000A2F]	Motherboard resources
[0000000000000D00 - 0000000000000FFF]	PCI Express Root Complex

I/O Port Address Map (cont'd)





























































[000000000000D000 - 000000000000DFFF]	Intel(R) Atom(TM)/Celeron(R)/Pentium(R) Processor PCI Express - Root Port 1 - 0F48
[000000000000E000 - 000000000000E01F]	Intel(R) Atom(TM)/Celeron(R)/Pentium(R) Processor Platform Control Unit - SMBus Port - 0F12
[000000000000E020 - 000000000000E03F]	Intel(R) Atom(TM)/Celeron(R)/Pentium(R) Processor AHCI - 0F23
[000000000000E040 - 000000000000E043]	Intel(R) Atom(TM)/Celeron(R)/Pentium(R) Processor AHCI - 0F23
[000000000000E050 - 000000000000E057]	Intel(R) Atom(TM)/Celeron(R)/Pentium(R) Processor AHCI - 0F23
[000000000000E060 - 000000000000E063]	Intel(R) Atom(TM)/Celeron(R)/Pentium(R) Processor AHCI - 0F23
[000000000000E070 - 000000000000E077]	Intel(R) Atom(TM)/Celeron(R)/Pentium(R) Processor AHCI - 0F23
[000000000000E080 - 000000000000E087]	Intel(R) HD Graphics

6.2 Interrupt Controller (IRQ) Map



























































The interrupt controller map for the CT-XBT0x under Windows® 7 Ultimate 64-bit is shown below.

IRQ	Device
(ISA) 0x00000000 (00)	System timer
(ISA) 0x00000001 (01)	Standard PS/2 Keyboard
(ISA) 0x00000003 (03)	Communications Port (COM2)
(ISA) 0x00000004 (04)	Communications Port (COM1)
(ISA) 0x00000007 (07)	Communications Port (COM3)
(ISA) 0x00000007 (07)	Communications Port (COM4)
(ISA) 0x00000007 (07)	Communications Port (COM5)
(ISA) 0x00000007 (07)	Communications Port (COM6)
(ISA) 0x00000008 (08)	High precision event timer
(ISA) 0x0000000C (12)	PS/2 Compatible Mouse
(ISA) 0x0000002B (43)	Intel(R) Atom(TM)/Celeron(R)/Pentium(R) Processor Serial IO (SIO) - DMA - 9C60
(ISA) 0x00000030 (48)	GPIO Controller
(ISA) 0x00000031 (49)	GPIO Controller
(ISA) 0x00000032 (50)	GPIO Controller
(ISA) 0x00000051 (81)	Microsoft ACPI-Compliant System
(ISA) 0x00000052 (82)	Microsoft ACPI-Compliant System
(ISA) 0x00000053 (83)	Microsoft ACPI-Compliant System
(ISA) 0x00000054 (84)	Microsoft ACPI-Compliant System
(ISA) 0x00000055 (85)	Microsoft ACPI-Compliant System
(ISA) 0x00000056 (86)	Microsoft ACPI-Compliant System
(ISA) 0x00000057 (87)	Microsoft ACPI-Compliant System
(ISA) 0x00000058 (88)	Microsoft ACPI-Compliant System
(ISA) 0x00000059 (89)	Microsoft ACPI-Compliant System
(ISA) 0x0000005A (90)	Microsoft ACPI-Compliant System
(ISA) 0x0000005B (91)	Microsoft ACPI-Compliant System
(ISA) 0x0000005C (92)	Microsoft ACPI-Compliant System
(ISA) 0x0000005D (93)	Microsoft ACPI-Compliant System
(ISA) 0x0000005E (94)	Microsoft ACPI-Compliant System
(ISA) 0x0000005F (95)	Microsoft ACPI-Compliant System
(ISA) 0x00000060 (96)	Microsoft ACPI-Compliant System
(ISA) 0x00000061 (97)	Microsoft ACPI-Compliant System
(ISA) 0x00000062 (98)	Microsoft ACPI-Compliant System
(ISA) 0x00000063 (99)	Microsoft ACPI-Compliant System
(ISA) 0x00000064 (100)	Microsoft ACPI-Compliant System
(ISA) 0x00000065 (101)	Microsoft ACPI-Compliant System
(ISA) 0x00000066 (102)	Microsoft ACPI-Compliant System
(ISA) 0x00000067 (103)	Microsoft ACPI-Compliant System
(ISA) 0x00000068 (104)	Microsoft ACPI-Compliant System
(ISA) 0x00000069 (105)	Microsoft ACPI-Compliant System
(ISA) 0x0000006A (106)	Microsoft ACPI-Compliant System
(ISA) 0x0000006B (107)	Microsoft ACPI-Compliant System
(ISA) 0x0000006C (108)	Microsoft ACPI-Compliant System
(ISA) 0x0000006D (109)	Microsoft ACPI-Compliant System





























































Interrupt Controller (IRQ) Map (cont'd)

	(ISA) 0x0000006E (110)	Microsoft ACPI-Compliant System
	(ISA) 0x0000006F (111)	Microsoft ACPI-Compliant System
	(ISA) 0x00000070 (112)	Microsoft ACPI-Compliant System
	(ISA) 0x00000071 (113)	Microsoft ACPI-Compliant System
	(ISA) 0x00000072 (114)	Microsoft ACPI-Compliant System
	(ISA) 0x00000073 (115)	Microsoft ACPI-Compliant System
	(ISA) 0x00000074 (116)	Microsoft ACPI-Compliant System
	(ISA) 0x00000075 (117)	Microsoft ACPI-Compliant System
	(ISA) 0x00000076 (118)	Microsoft ACPI-Compliant System
	(ISA) 0x00000077 (119)	Microsoft ACPI-Compliant System
	(ISA) 0x00000078 (120)	Microsoft ACPI-Compliant System
	(ISA) 0x00000079 (121)	Microsoft ACPI-Compliant System
	(ISA) 0x0000007A (122)	Microsoft ACPI-Compliant System
	(ISA) 0x0000007B (123)	Microsoft ACPI-Compliant System
	(ISA) 0x0000007C (124)	Microsoft ACPI-Compliant System
	(ISA) 0x0000007D (125)	Microsoft ACPI-Compliant System
	(ISA) 0x0000007E (126)	Microsoft ACPI-Compliant System
	(ISA) 0x0000007F (127)	Microsoft ACPI-Compliant System
	(ISA) 0x00000080 (128)	Microsoft ACPI-Compliant System
	(ISA) 0x00000081 (129)	Microsoft ACPI-Compliant System
	(ISA) 0x00000082 (130)	Microsoft ACPI-Compliant System
	(ISA) 0x00000083 (131)	Microsoft ACPI-Compliant System
	(ISA) 0x00000084 (132)	Microsoft ACPI-Compliant System
	(ISA) 0x00000085 (133)	Microsoft ACPI-Compliant System
	(ISA) 0x00000086 (134)	Microsoft ACPI-Compliant System
	(ISA) 0x00000087 (135)	Microsoft ACPI-Compliant System
	(ISA) 0x00000088 (136)	Microsoft ACPI-Compliant System
	(ISA) 0x00000089 (137)	Microsoft ACPI-Compliant System
	(ISA) 0x0000008A (138)	Microsoft ACPI-Compliant System
	(ISA) 0x0000008B (139)	Microsoft ACPI-Compliant System
	(ISA) 0x0000008C (140)	Microsoft ACPI-Compliant System
	(ISA) 0x0000008D (141)	Microsoft ACPI-Compliant System
	(ISA) 0x0000008E (142)	Microsoft ACPI-Compliant System
	(ISA) 0x0000008F (143)	Microsoft ACPI-Compliant System
	(ISA) 0x00000090 (144)	Microsoft ACPI-Compliant System
	(ISA) 0x00000091 (145)	Microsoft ACPI-Compliant System
	(ISA) 0x00000092 (146)	Microsoft ACPI-Compliant System
	(ISA) 0x00000093 (147)	Microsoft ACPI-Compliant System
	(ISA) 0x00000094 (148)	Microsoft ACPI-Compliant System
	(ISA) 0x00000095 (149)	Microsoft ACPI-Compliant System
	(ISA) 0x00000096 (150)	Microsoft ACPI-Compliant System
	(ISA) 0x00000097 (151)	Microsoft ACPI-Compliant System
	(ISA) 0x00000098 (152)	Microsoft ACPI-Compliant System
	(ISA) 0x00000099 (153)	Microsoft ACPI-Compliant System
	(ISA) 0x0000009A (154)	Microsoft ACPI-Compliant System
	(ISA) 0x0000009B (155)	Microsoft ACPI-Compliant System
	(ISA) 0x0000009C (156)	Microsoft ACPI-Compliant System
	(ISA) 0x0000009D (157)	Microsoft ACPI-Compliant System
	(ISA) 0x0000009E (158)	Microsoft ACPI-Compliant System
	(ISA) 0x0000009F (159)	Microsoft ACPI-Compliant System
	(ISA) 0x000000A0 (160)	Microsoft ACPI-Compliant System
	(ISA) 0x000000A1 (161)	Microsoft ACPI-Compliant System
	(ISA) 0x000000A2 (162)	Microsoft ACPI-Compliant System
	(ISA) 0x000000A3 (163)	Microsoft ACPI-Compliant System
	(ISA) 0x000000A4 (164)	Microsoft ACPI-Compliant System
	(ISA) 0x000000A5 (165)	Microsoft ACPI-Compliant System
	(ISA) 0x000000A6 (166)	Microsoft ACPI-Compliant System
	(ISA) 0x000000A7 (167)	Microsoft ACPI-Compliant System
	(ISA) 0x000000A8 (168)	Microsoft ACPI-Compliant System
	(ISA) 0x000000A9 (169)	Microsoft ACPI-Compliant System
	(ISA) 0x000000AA (170)	Microsoft ACPI-Compliant System



























































Interrupt Controller (IRQ) Map (cont'd)

	(ISA) 0x000000AB (171)	Microsoft ACPI-Compliant System
	(ISA) 0x000000AC (172)	Microsoft ACPI-Compliant System
	(ISA) 0x000000AD (173)	Microsoft ACPI-Compliant System
	(ISA) 0x000000AE (174)	Microsoft ACPI-Compliant System
	(ISA) 0x000000AF (175)	Microsoft ACPI-Compliant System
	(ISA) 0x000000B0 (176)	Microsoft ACPI-Compliant System
	(ISA) 0x000000B1 (177)	Microsoft ACPI-Compliant System
	(ISA) 0x000000B2 (178)	Microsoft ACPI-Compliant System
	(ISA) 0x000000B3 (179)	Microsoft ACPI-Compliant System
	(ISA) 0x000000B4 (180)	Microsoft ACPI-Compliant System
	(ISA) 0x000000B5 (181)	Microsoft ACPI-Compliant System
	(ISA) 0x000000B6 (182)	Microsoft ACPI-Compliant System
	(ISA) 0x000000B7 (183)	Microsoft ACPI-Compliant System
	(ISA) 0x000000B8 (184)	Microsoft ACPI-Compliant System
	(ISA) 0x000000B9 (185)	Microsoft ACPI-Compliant System
	(ISA) 0x000000BA (186)	Microsoft ACPI-Compliant System
	(ISA) 0x000000BB (187)	Microsoft ACPI-Compliant System
	(ISA) 0x000000BC (188)	Microsoft ACPI-Compliant System
	(ISA) 0x000000BD (189)	Microsoft ACPI-Compliant System
	(ISA) 0x000000BE (190)	Microsoft ACPI-Compliant System
	(ISA) 0x000000BF (191)	Microsoft ACPI-Compliant System
	(ISA) 0x00000100 (256)	Microsoft ACPI-Compliant System
	(ISA) 0x00000101 (257)	Microsoft ACPI-Compliant System
	(ISA) 0x00000102 (258)	Microsoft ACPI-Compliant System
	(ISA) 0x00000103 (259)	Microsoft ACPI-Compliant System
	(ISA) 0x00000104 (260)	Microsoft ACPI-Compliant System
	(ISA) 0x00000105 (261)	Microsoft ACPI-Compliant System
	(ISA) 0x00000106 (262)	Microsoft ACPI-Compliant System
	(ISA) 0x00000107 (263)	Microsoft ACPI-Compliant System
	(ISA) 0x00000108 (264)	Microsoft ACPI-Compliant System
	(ISA) 0x00000109 (265)	Microsoft ACPI-Compliant System
	(ISA) 0x0000010A (266)	Microsoft ACPI-Compliant System
	(ISA) 0x0000010B (267)	Microsoft ACPI-Compliant System
	(ISA) 0x0000010C (268)	Microsoft ACPI-Compliant System
	(ISA) 0x0000010D (269)	Microsoft ACPI-Compliant System
	(ISA) 0x0000010E (270)	Microsoft ACPI-Compliant System
	(ISA) 0x0000010F (271)	Microsoft ACPI-Compliant System
	(ISA) 0x00000110 (272)	Microsoft ACPI-Compliant System
	(ISA) 0x00000111 (273)	Microsoft ACPI-Compliant System
	(ISA) 0x00000112 (274)	Microsoft ACPI-Compliant System
	(ISA) 0x00000113 (275)	Microsoft ACPI-Compliant System
	(ISA) 0x00000114 (276)	Microsoft ACPI-Compliant System
	(ISA) 0x00000115 (277)	Microsoft ACPI-Compliant System
	(ISA) 0x00000116 (278)	Microsoft ACPI-Compliant System
	(ISA) 0x00000117 (279)	Microsoft ACPI-Compliant System
	(ISA) 0x00000118 (280)	Microsoft ACPI-Compliant System
	(ISA) 0x00000119 (281)	Microsoft ACPI-Compliant System
	(ISA) 0x0000011A (282)	Microsoft ACPI-Compliant System
	(ISA) 0x0000011B (283)	Microsoft ACPI-Compliant System
	(ISA) 0x0000011C (284)	Microsoft ACPI-Compliant System
	(ISA) 0x0000011D (285)	Microsoft ACPI-Compliant System
	(ISA) 0x0000011E (286)	Microsoft ACPI-Compliant System
	(ISA) 0x0000011F (287)	Microsoft ACPI-Compliant System
	(ISA) 0x00000120 (288)	Microsoft ACPI-Compliant System
	(ISA) 0x00000121 (289)	Microsoft ACPI-Compliant System
	(ISA) 0x00000122 (290)	Microsoft ACPI-Compliant System
	(ISA) 0x00000123 (291)	Microsoft ACPI-Compliant System
	(ISA) 0x00000124 (292)	Microsoft ACPI-Compliant System
	(ISA) 0x00000125 (293)	Microsoft ACPI-Compliant System
	(ISA) 0x00000126 (294)	Microsoft ACPI-Compliant System
	(ISA) 0x00000127 (295)	Microsoft ACPI-Compliant System



























































Interrupt Controller (IRQ) Map (cont'd)

 (ISA) 0x00000128 (296)	Microsoft ACPI-Compliant System
 (ISA) 0x00000129 (297)	Microsoft ACPI-Compliant System
 (ISA) 0x0000012A (298)	Microsoft ACPI-Compliant System
 (ISA) 0x0000012B (299)	Microsoft ACPI-Compliant System
 (ISA) 0x0000012C (300)	Microsoft ACPI-Compliant System
 (ISA) 0x0000012D (301)	Microsoft ACPI-Compliant System
 (ISA) 0x0000012E (302)	Microsoft ACPI-Compliant System
 (ISA) 0x0000012F (303)	Microsoft ACPI-Compliant System
 (ISA) 0x00000130 (304)	Microsoft ACPI-Compliant System
 (ISA) 0x00000131 (305)	Microsoft ACPI-Compliant System
 (ISA) 0x00000132 (306)	Microsoft ACPI-Compliant System
 (ISA) 0x00000133 (307)	Microsoft ACPI-Compliant System
 (ISA) 0x00000134 (308)	Microsoft ACPI-Compliant System
 (ISA) 0x00000135 (309)	Microsoft ACPI-Compliant System
 (ISA) 0x00000136 (310)	Microsoft ACPI-Compliant System
 (ISA) 0x00000137 (311)	Microsoft ACPI-Compliant System
 (ISA) 0x00000138 (312)	Microsoft ACPI-Compliant System
 (ISA) 0x00000139 (313)	Microsoft ACPI-Compliant System
 (ISA) 0x0000013A (314)	Microsoft ACPI-Compliant System
 (ISA) 0x0000013B (315)	Microsoft ACPI-Compliant System
 (ISA) 0x0000013C (316)	Microsoft ACPI-Compliant System
 (ISA) 0x0000013D (317)	Microsoft ACPI-Compliant System
 (ISA) 0x0000013E (318)	Microsoft ACPI-Compliant System
 (ISA) 0x0000013F (319)	Microsoft ACPI-Compliant System
 (ISA) 0x00000140 (320)	Microsoft ACPI-Compliant System
 (ISA) 0x00000141 (321)	Microsoft ACPI-Compliant System
 (ISA) 0x00000142 (322)	Microsoft ACPI-Compliant System
 (ISA) 0x00000143 (323)	Microsoft ACPI-Compliant System
 (ISA) 0x00000144 (324)	Microsoft ACPI-Compliant System
 (ISA) 0x00000145 (325)	Microsoft ACPI-Compliant System
 (ISA) 0x00000146 (326)	Microsoft ACPI-Compliant System
 (ISA) 0x00000147 (327)	Microsoft ACPI-Compliant System
 (ISA) 0x00000148 (328)	Microsoft ACPI-Compliant System
 (ISA) 0x00000149 (329)	Microsoft ACPI-Compliant System
 (ISA) 0x0000014A (330)	Microsoft ACPI-Compliant System
 (ISA) 0x0000014B (331)	Microsoft ACPI-Compliant System
 (ISA) 0x0000014C (332)	Microsoft ACPI-Compliant System
 (ISA) 0x0000014D (333)	Microsoft ACPI-Compliant System
 (ISA) 0x0000014E (334)	Microsoft ACPI-Compliant System
 (ISA) 0x0000014F (335)	Microsoft ACPI-Compliant System
 (ISA) 0x00000150 (336)	Microsoft ACPI-Compliant System
 (ISA) 0x00000151 (337)	Microsoft ACPI-Compliant System
 (ISA) 0x00000152 (338)	Microsoft ACPI-Compliant System
 (ISA) 0x00000153 (339)	Microsoft ACPI-Compliant System
 (ISA) 0x00000154 (340)	Microsoft ACPI-Compliant System
 (ISA) 0x00000155 (341)	Microsoft ACPI-Compliant System
 (ISA) 0x00000156 (342)	Microsoft ACPI-Compliant System
 (ISA) 0x00000157 (343)	Microsoft ACPI-Compliant System
 (ISA) 0x00000158 (344)	Microsoft ACPI-Compliant System
 (ISA) 0x00000159 (345)	Microsoft ACPI-Compliant System
 (ISA) 0x0000015A (346)	Microsoft ACPI-Compliant System
 (ISA) 0x0000015B (347)	Microsoft ACPI-Compliant System
 (ISA) 0x0000015C (348)	Microsoft ACPI-Compliant System
 (ISA) 0x0000015D (349)	Microsoft ACPI-Compliant System
 (ISA) 0x0000015E (350)	Microsoft ACPI-Compliant System
 (ISA) 0x0000015F (351)	Microsoft ACPI-Compliant System
 (ISA) 0x00000160 (352)	Microsoft ACPI-Compliant System
 (ISA) 0x00000161 (353)	Microsoft ACPI-Compliant System
 (ISA) 0x00000162 (354)	Microsoft ACPI-Compliant System
 (ISA) 0x00000163 (355)	Microsoft ACPI-Compliant System

















































Interrupt Controller (IRQ) Map (cont'd)

 (ISA) 0x00000164 (356)	Microsoft ACPI-Compliant System
 (ISA) 0x00000165 (357)	Microsoft ACPI-Compliant System
 (ISA) 0x00000166 (358)	Microsoft ACPI-Compliant System
 (ISA) 0x00000167 (359)	Microsoft ACPI-Compliant System
 (ISA) 0x00000168 (360)	Microsoft ACPI-Compliant System
 (ISA) 0x00000169 (361)	Microsoft ACPI-Compliant System
 (ISA) 0x0000016A (362)	Microsoft ACPI-Compliant System
 (ISA) 0x0000016B (363)	Microsoft ACPI-Compliant System
 (ISA) 0x0000016C (364)	Microsoft ACPI-Compliant System
 (ISA) 0x0000016D (365)	Microsoft ACPI-Compliant System
 (ISA) 0x0000016E (366)	Microsoft ACPI-Compliant System
 (ISA) 0x0000016F (367)	Microsoft ACPI-Compliant System
 (ISA) 0x00000170 (368)	Microsoft ACPI-Compliant System
 (ISA) 0x00000171 (369)	Microsoft ACPI-Compliant System
 (ISA) 0x00000172 (370)	Microsoft ACPI-Compliant System
 (ISA) 0x00000173 (371)	Microsoft ACPI-Compliant System
 (ISA) 0x00000174 (372)	Microsoft ACPI-Compliant System
 (ISA) 0x00000175 (373)	Microsoft ACPI-Compliant System
 (ISA) 0x00000176 (374)	Microsoft ACPI-Compliant System
 (ISA) 0x00000177 (375)	Microsoft ACPI-Compliant System
 (ISA) 0x00000178 (376)	Microsoft ACPI-Compliant System
 (ISA) 0x00000179 (377)	Microsoft ACPI-Compliant System
 (ISA) 0x0000017A (378)	Microsoft ACPI-Compliant System
 (ISA) 0x0000017B (379)	Microsoft ACPI-Compliant System
 (ISA) 0x0000017C (380)	Microsoft ACPI-Compliant System
 (ISA) 0x0000017D (381)	Microsoft ACPI-Compliant System
 (ISA) 0x0000017E (382)	Microsoft ACPI-Compliant System
 (ISA) 0x0000017F (383)	Microsoft ACPI-Compliant System
 (ISA) 0x00000180 (384)	Microsoft ACPI-Compliant System
 (ISA) 0x00000181 (385)	Microsoft ACPI-Compliant System
 (ISA) 0x00000182 (386)	Microsoft ACPI-Compliant System
 (ISA) 0x00000183 (387)	Microsoft ACPI-Compliant System
 (ISA) 0x00000184 (388)	Microsoft ACPI-Compliant System
 (ISA) 0x00000185 (389)	Microsoft ACPI-Compliant System
 (ISA) 0x00000186 (390)	Microsoft ACPI-Compliant System
 (ISA) 0x00000187 (391)	Microsoft ACPI-Compliant System
 (ISA) 0x00000188 (392)	Microsoft ACPI-Compliant System
 (ISA) 0x00000189 (393)	Microsoft ACPI-Compliant System
 (ISA) 0x0000018A (394)	Microsoft ACPI-Compliant System
 (ISA) 0x0000018B (395)	Microsoft ACPI-Compliant System
 (ISA) 0x0000018C (396)	Microsoft ACPI-Compliant System
 (ISA) 0x0000018D (397)	Microsoft ACPI-Compliant System
 (ISA) 0x0000018E (398)	Microsoft ACPI-Compliant System
 (ISA) 0x0000018F (399)	Microsoft ACPI-Compliant System
 (ISA) 0x00000190 (400)	Microsoft ACPI-Compliant System
 (ISA) 0x00000191 (401)	Microsoft ACPI-Compliant System
 (ISA) 0x00000192 (402)	Microsoft ACPI-Compliant System
 (ISA) 0x00000193 (403)	Microsoft ACPI-Compliant System
 (ISA) 0x00000194 (404)	Microsoft ACPI-Compliant System
 (ISA) 0x00000195 (405)	Microsoft ACPI-Compliant System
 (ISA) 0x00000196 (406)	Microsoft ACPI-Compliant System
 (ISA) 0x00000197 (407)	Microsoft ACPI-Compliant System
 (ISA) 0x00000198 (408)	Microsoft ACPI-Compliant System
 (ISA) 0x00000199 (409)	Microsoft ACPI-Compliant System
 (ISA) 0x0000019A (410)	Microsoft ACPI-Compliant System
 (ISA) 0x0000019B (411)	Microsoft ACPI-Compliant System
 (ISA) 0x0000019C (412)	Microsoft ACPI-Compliant System
 (ISA) 0x0000019D (413)	Microsoft ACPI-Compliant System
 (ISA) 0x0000019E (414)	Microsoft ACPI-Compliant System
(ISA) 0x0000019F (415)	Microsoft ACPI-Compliant System

Interrupt Controller (IRQ) Map (cont'd)

 (ISA) 0x000001A0 (416)	Microsoft ACPI-Compliant System
 (ISA) 0x000001A1 (417)	Microsoft ACPI-Compliant System
 (ISA) 0x000001A2 (418)	Microsoft ACPI-Compliant System
 (ISA) 0x000001A3 (419)	Microsoft ACPI-Compliant System
 (ISA) 0x000001A4 (420)	Microsoft ACPI-Compliant System
 (ISA) 0x000001A5 (421)	Microsoft ACPI-Compliant System
 (ISA) 0x000001A6 (422)	Microsoft ACPI-Compliant System
 (ISA) 0x000001A7 (423)	Microsoft ACPI-Compliant System
 (ISA) 0x000001A8 (424)	Microsoft ACPI-Compliant System
 (ISA) 0x000001A9 (425)	Microsoft ACPI-Compliant System
 (ISA) 0x000001AA (426)	Microsoft ACPI-Compliant System
 (ISA) 0x000001AB (427)	Microsoft ACPI-Compliant System
 (ISA) 0x000001AC (428)	Microsoft ACPI-Compliant System
 (ISA) 0x000001AD (429)	Microsoft ACPI-Compliant System
 (ISA) 0x000001AE (430)	Microsoft ACPI-Compliant System
 (ISA) 0x000001AF (431)	Microsoft ACPI-Compliant System
 (ISA) 0x000001B0 (432)	Microsoft ACPI-Compliant System
 (ISA) 0x000001B1 (433)	Microsoft ACPI-Compliant System
 (ISA) 0x000001B2 (434)	Microsoft ACPI-Compliant System
 (ISA) 0x000001B3 (435)	Microsoft ACPI-Compliant System
 (ISA) 0x000001B4 (436)	Microsoft ACPI-Compliant System
 (ISA) 0x000001B5 (437)	Microsoft ACPI-Compliant System
 (ISA) 0x000001B6 (438)	Microsoft ACPI-Compliant System
 (ISA) 0x000001B7 (439)	Microsoft ACPI-Compliant System
 (ISA) 0x000001B8 (440)	Microsoft ACPI-Compliant System
 (ISA) 0x000001B9 (441)	Microsoft ACPI-Compliant System
 (ISA) 0x000001BA (442)	Microsoft ACPI-Compliant System
 (ISA) 0x000001BB (443)	Microsoft ACPI-Compliant System
 (ISA) 0x000001BC (444)	Microsoft ACPI-Compliant System
 (ISA) 0x000001BD (445)	Microsoft ACPI-Compliant System
 (ISA) 0x000001BE (446)	Microsoft ACPI-Compliant System
 (ISA) 0x000001BF (447)	Microsoft ACPI-Compliant System
 (ISA) 0x000001C0 (448)	Microsoft ACPI-Compliant System
 (ISA) 0x000001C1 (449)	Microsoft ACPI-Compliant System
 (ISA) 0x000001C2 (450)	Microsoft ACPI-Compliant System
 (ISA) 0x000001C3 (451)	Microsoft ACPI-Compliant System
 (ISA) 0x000001C4 (452)	Microsoft ACPI-Compliant System
 (ISA) 0x000001C5 (453)	Microsoft ACPI-Compliant System
 (ISA) 0x000001C6 (454)	Microsoft ACPI-Compliant System
 (ISA) 0x000001C7 (455)	Microsoft ACPI-Compliant System
 (ISA) 0x000001C8 (456)	Microsoft ACPI-Compliant System
 (ISA) 0x000001C9 (457)	Microsoft ACPI-Compliant System
 (ISA) 0x000001CA (458)	Microsoft ACPI-Compliant System
 (ISA) 0x000001CB (459)	Microsoft ACPI-Compliant System
 (ISA) 0x000001CC (460)	Microsoft ACPI-Compliant System
 (ISA) 0x000001CD (461)	Microsoft ACPI-Compliant System
 (ISA) 0x000001CE (462)	Microsoft ACPI-Compliant System
 (ISA) 0x000001CF (463)	Microsoft ACPI-Compliant System
 (ISA) 0x000001D0 (464)	Microsoft ACPI-Compliant System
 (ISA) 0x000001D1 (465)	Microsoft ACPI-Compliant System
 (ISA) 0x000001D2 (466)	Microsoft ACPI-Compliant System
 (ISA) 0x000001D3 (467)	Microsoft ACPI-Compliant System
 (ISA) 0x000001D4 (468)	Microsoft ACPI-Compliant System
 (ISA) 0x000001D5 (469)	Microsoft ACPI-Compliant System
 (ISA) 0x000001D6 (470)	Microsoft ACPI-Compliant System
 (ISA) 0x000001D7 (471)	Microsoft ACPI-Compliant System
 (ISA) 0x000001D8 (472)	Microsoft ACPI-Compliant System
 (ISA) 0x000001D9 (473)	Microsoft ACPI-Compliant System
 (ISA) 0x000001DA (474)	Microsoft ACPI-Compliant System
(ISA) 0x000001DB (475)	Microsoft ACPI-Compliant System

Interrupt Controller (IRQ) Map (cont'd)

 (ISA) 0x000001DC (476)	Microsoft ACPI-Compliant System
 (ISA) 0x000001DD (477)	Microsoft ACPI-Compliant System
 (ISA) 0x000001DE (478)	Microsoft ACPI-Compliant System
 (ISA) 0x000001DF (479)	Microsoft ACPI-Compliant System
 (ISA) 0x000001E0 (480)	Microsoft ACPI-Compliant System
 (ISA) 0x000001E1 (481)	Microsoft ACPI-Compliant System
 (ISA) 0x000001E2 (482)	Microsoft ACPI-Compliant System
 (ISA) 0x000001E3 (483)	Microsoft ACPI-Compliant System
 (ISA) 0x000001E4 (484)	Microsoft ACPI-Compliant System
 (ISA) 0x000001E5 (485)	Microsoft ACPI-Compliant System
 (ISA) 0x000001E6 (486)	Microsoft ACPI-Compliant System
 (ISA) 0x000001E7 (487)	Microsoft ACPI-Compliant System
 (ISA) 0x000001E8 (488)	Microsoft ACPI-Compliant System
 (ISA) 0x000001E9 (489)	Microsoft ACPI-Compliant System
 (ISA) 0x000001EA (490)	Microsoft ACPI-Compliant System
 (ISA) 0x000001EB (491)	Microsoft ACPI-Compliant System
 (ISA) 0x000001EC (492)	Microsoft ACPI-Compliant System
 (ISA) 0x000001ED (493)	Microsoft ACPI-Compliant System
 (ISA) 0x000001EE (494)	Microsoft ACPI-Compliant System
 (ISA) 0x000001EF (495)	Microsoft ACPI-Compliant System
 (ISA) 0x000001F0 (496)	Microsoft ACPI-Compliant System
 (ISA) 0x000001F1 (497)	Microsoft ACPI-Compliant System
 (ISA) 0x000001F2 (498)	Microsoft ACPI-Compliant System
 (ISA) 0x000001F3 (499)	Microsoft ACPI-Compliant System
 (ISA) 0x000001F4 (500)	Microsoft ACPI-Compliant System
 (ISA) 0x000001F5 (501)	Microsoft ACPI-Compliant System
 (ISA) 0x000001F6 (502)	Microsoft ACPI-Compliant System
 (ISA) 0x000001F7 (503)	Microsoft ACPI-Compliant System
 (ISA) 0x000001F8 (504)	Microsoft ACPI-Compliant System
 (ISA) 0x000001F9 (505)	Microsoft ACPI-Compliant System
 (ISA) 0x000001FA (506)	Microsoft ACPI-Compliant System
 (ISA) 0x000001FB (507)	Microsoft ACPI-Compliant System
 (ISA) 0x000001FC (508)	Microsoft ACPI-Compliant System
 (ISA) 0x000001FD (509)	Microsoft ACPI-Compliant System
 (ISA) 0x000001FE (510)	Microsoft ACPI-Compliant System
 (ISA) 0x000001FF (511)	Microsoft ACPI-Compliant System
 (PCI) 0x00000010 (16)	Intel(R) Atom(TM)/Celeron(R)/Pentium(R) Processor PCI Express - Root Port 1 - 0F48
 (PCI) 0x00000012 (18)	SDA Standard Compliant SD Host Controller
 (PCI) 0x00000013 (19)	Intel(R) Atom(TM)/Celeron(R)/Pentium(R) Processor AHCI - 0F23
 (PCI) 0x00000016 (22)	High Definition Audio Controller
 (PCI) 0xFFFFFFFF6 (-10)	Intel(R) I210 Gigabit Network Connection
 (PCI) 0xFFFFFFFF7 (-9)	Intel(R) I210 Gigabit Network Connection
 (PCI) 0xFFFFFFFF8 (-8)	Intel(R) I210 Gigabit Network Connection
 (PCI) 0xFFFFFFFF9 (-7)	Intel(R) I210 Gigabit Network Connection
 (PCI) 0xFFFFFFFFA (-6)	Intel(R) I210 Gigabit Network Connection
 (PCI) 0xFFFFFFFFB (-5)	Intel(R) I210 Gigabit Network Connection
 (PCI) 0xFFFFFFFFC (-4)	Intel(R) Trusted Execution Engine Interface
 (PCI) 0xFFFFFFFFD (-3)	Intel(R) USB 3.0 eXtensible Host Controller - 0100 (Microsoft)
 (PCI) 0xFFFFFFFFE (-2)	Intel(R) HD Graphics

6.3 Memory Map

The memory map of DRAM for the CT-XBT0x under Windows® 7 Ultimate 64-bit is shown below.

Address Range	Device Name
[0000000000A0000 - 0000000000BFFFFF]	PCI Express Root Complex
[0000000000C0000 - 0000000000DFFFFF]	PCI Express Root Complex
[0000000000E0000 - 0000000000FFFFFF]	PCI Express Root Complex
[00000000A0000000 - 00000000AFFFFFFF]	Intel(R) HD Graphics
[00000000A0000000 - 00000000B071CFFE]	PCI Express Root Complex
[00000000B0000000 - 00000000B03FFFFF]	Intel(R) HD Graphics
[00000000B0400000 - 00000000B04FFFFF]	Intel(R) Trusted Execution Engine Interface
[00000000B0500000 - 00000000B05FFFFF]	Intel(R) Trusted Execution Engine Interface
[00000000B0600000 - 00000000B06FFFFF]	Intel(R) Atom(TM)/Celeron(R)/Pentium(R) Processor PCI Express - Root Port 1 - 0F48
[00000000B067C000 - 00000000B067FFFF]	Intel(R) I210 Gigabit Network Connection
[00000000B0680000 - 00000000B06FFFFF]	Intel(R) I210 Gigabit Network Connection
[00000000B0700000 - 00000000B070FFFF]	Intel(R) USB 3.0 eXtensible Host Controller - 0100 (Microsoft)
[00000000B0709000 - 00000000B07093FF]	Standard Enhanced PCI to USB Host Controller
[00000000B0710000 - 00000000B0713FFF]	High Definition Audio Controller
[00000000B0718000 - 00000000B071801F]	Intel(R) Atom(TM)/Celeron(R)/Pentium(R) Processor Platform Control Unit - SMBus Port - 0F12
[00000000B0719000 - 00000000B0719FFF]	SDA Standard Compliant SD Host Controller
[00000000B071A000 - 00000000B071A7FF]	Intel(R) Atom(TM)/Celeron(R)/Pentium(R) Processor AHCI - 0F23
[00000000B071B000 - 00000000B071BFFF]	SDA Standard Compliant SD Host Controller
[00000000B0720000 - 00000000B0723FFF]	Intel(R) Atom(TM)/Celeron(R)/Pentium(R) Processor Serial IO (SIO) - DMA - 9C60
[00000000E0000000 - 00000000EFFFFFFF]	Motherboard resources
[00000000FED00000 - 00000000FED003FF]	High precision event timer
[00000000FED01000 - 00000000FED01FFF]	Motherboard resources
[00000000FED03000 - 00000000FED03FFF]	Motherboard resources
[00000000FED04000 - 00000000FED04FFF]	Motherboard resources
[00000000FED08000 - 00000000FED08FFF]	Motherboard resources
[00000000FED0C000 - 00000000FED0CFFF]	GPIO Controller
[00000000FED0D000 - 00000000FED0DFFF]	GPIO Controller
[00000000FED0E000 - 00000000FED0EFFF]	GPIO Controller
[00000000FED1C000 - 00000000FED1CFFF]	Motherboard resources
[00000000FEE00000 - 00000000FEEFFFFFFF]	Motherboard resources
[00000000FEF00000 - 00000000FEFFFFFFF]	Motherboard resources
[00000000FF000000 - 00000000FFFFFFFF]	Intel(R) 82802 Firmware Hub Device