

AND

Digital Blood Pressure Monitor

Model UA-852

Instruction Manual
Original

ENGLISH

Manuel d'instructions
Traduction

FRANÇAIS

Manual de Instrucciones
Traducción

ESPAÑOL

Manuale di Istruzioni
Traduzione

ITALIANO

Bedienungsanleitung
Übersetzung

DEUTSCH

使用手冊
翻譯

中文

Contents

Dear Customers.....	2
Preliminary Remarks	2
Precautions.....	2
Parts Identification.....	4
Symbols.....	5
Operation Mode.....	6
Using The Monitor	7
Installing / Changing The Batteries	7
Connecting The Air Hose	7
Connecting The AC Adapter.....	7
Adjusting The Built-in Clock	8
Setting Three Reminders	8
Alarm ON/OFF Mark On The Display	9
Selecting the Correct Cuff Size	9
Applying The Arm Cuff	10
How To Take Proper Measurements	10
Measurement.....	10
After Measurement	10
Measurements	11
Normal Measurement.....	11
Measurement With The Desired Systolic Pressure	12
Notes For Proper Measurement	12
Recalling Memory Data	13
Clearing the memory data.....	13
What Is An Irregular Heartbeat	14
Pressure Bar Indicator	14
WHO Classification Indicator	14
About Blood Pressure.....	15
What Is Blood Pressure?	15
What Is Hypertension And How Is It Controlled?	15
Why Measure Blood Pressure At Home?	15
WHO Blood Pressure Classification	15
Blood Pressure Variations.....	15
Troubleshooting	16
Maintenance	17
Technical Data.....	17

Dear Customers

Congratulations on purchasing a state-of-the-art A&D blood pressure monitor, one of the most advanced monitors available today. Designed for ease of use and accuracy, this device will facilitate your daily blood pressure regimen.

We recommend that you read through this manual carefully before using the device for the first time.

Preliminary Remarks

- This device conforms to the European Directive 93/42 EEC for Medical Products. This is made evident by the **CE**₀₁₂₃ mark of conformity. (0123: The reference number to the involved notified body)
- The device is designed for use on adults only, not newborns or infants.
- Environment for use: The device is for use in the home healthcare environment.
- This device is designed to measure blood pressure and pulse rate of people for diagnosis.

Precautions

- Precision components are used in the construction of this device. Extremes in temperature, humidity, direct sunlight, shock or dust should be avoided.
- Clean the device and cuff with a dry, soft cloth or a cloth dampened with water and a neutral detergent. Never use alcohol, benzene, thinner or other harsh chemicals to clean the device or cuff.
- Avoid tightly folding the cuff or storing the hose tightly twisted for long periods, as such treatment may shorten the life of the components.
- The device and cuff are not water resistant. Prevent rain, sweat and water from soiling the device and cuff.
- Measurements may be distorted if the device is used close to television, microwave ovens, cellular telephones, X-ray or other devices with strong electrical fields.
- Used equipment, parts and batteries are not treated as ordinary household waste, and must be disposed of according to the applicable local regulations.
- When the AC adapter is used, make sure that the AC adapter can be readily removed from the electrical outlet when necessary.

- ❑ When reusing the device, confirm that the device is clean.
- ❑ Do not modify the device. It may cause accidents or damage to the device.
- ❑ To measure blood pressure, the arm must be squeezed by the cuff hard enough to temporarily stop blood flow through the artery. This may cause pain, numbness or a temporary red mark to the arm. This condition will appear especially when measurement is repeated successively. Any pain, numbness, or red marks will disappear with time.

Contraindications

The following are precautions for proper use of the device.

- ❑ Do not apply the cuff on an arm with another medical electrical equipment attached. The equipment may not function properly.
- ❑ People who have a severe circulatory deficit in the arm must consult a doctor before using the device, to avoid medical problems.
- ❑ Do not self-diagnose the measurement results and start treatment by yourself. Always consult your doctor for evaluation of the results and treatment.
- ❑ Do not apply the cuff on an arm with an unhealed wound.
- ❑ Do not apply the cuff on an arm receiving an intravenous drip or blood transfusion. It may cause injury or accidents.
- ❑ Do not use the device where flammable gases such as anesthetic gases are present. It may cause an explosion.
- ❑ Do not use the device in highly concentrated oxygen environments, such as a high-pressure oxygen chamber or an oxygen tent. It may cause a fire or explosion.



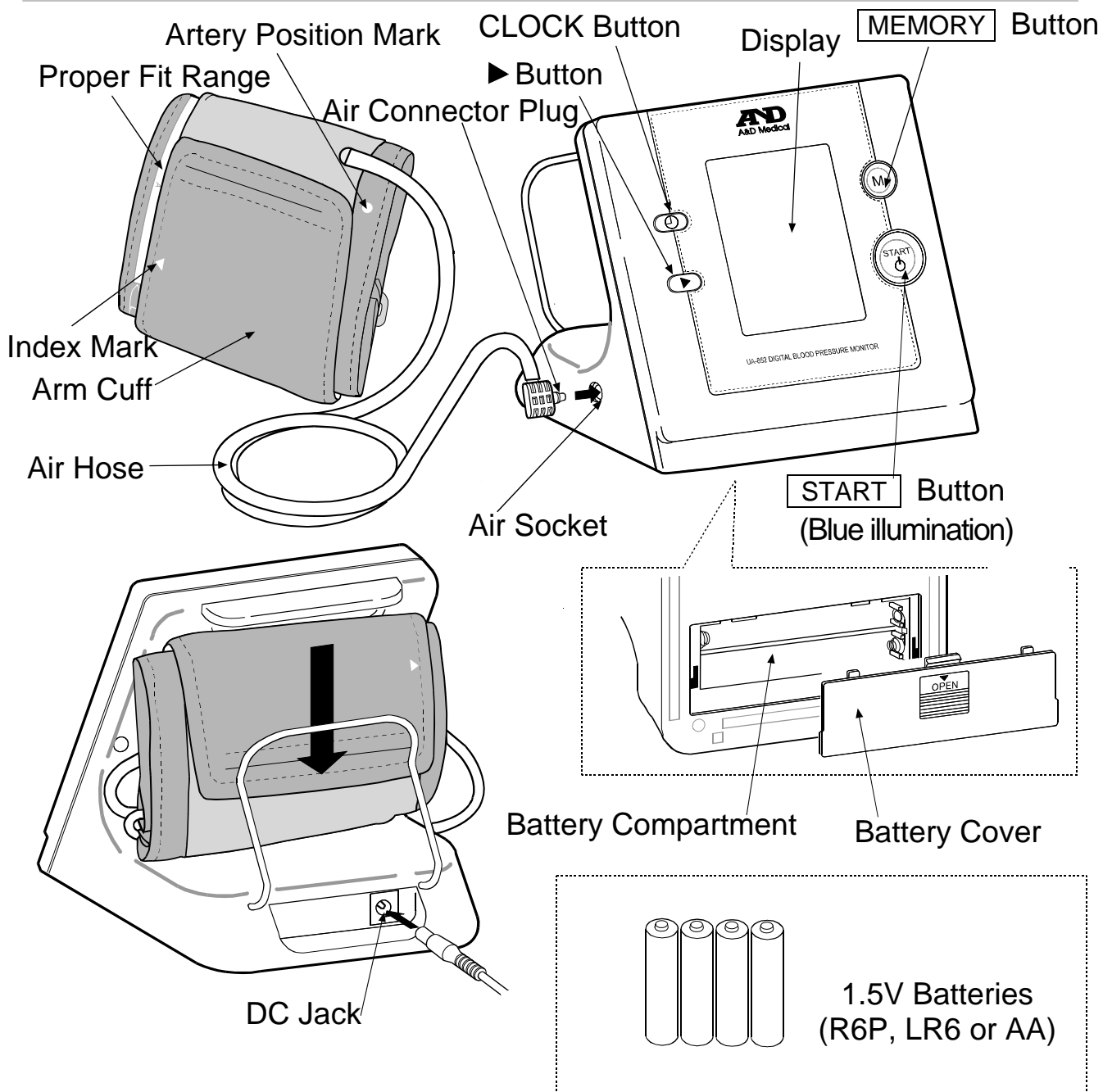



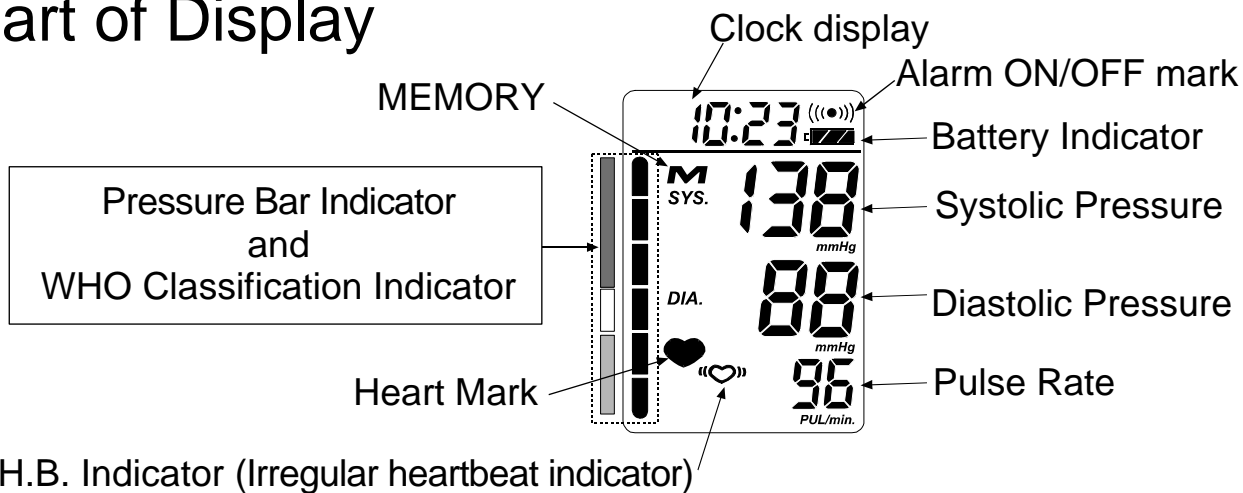



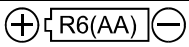

Parts Identification







Part of Display



Symbols

Symbols	Function / Meaning	Recommended Action
	Standby and Turn the device on.	_____
	Battery installation guide	_____
	Direct current	_____
SN	Serial number	_____
2007 	Date of manufacture	_____
	Type BF: Device, cuff and tubing are designed to provide special protection against electrical shocks.	_____
	The indicator while measurement is in progress. It blinks while detecting the pulse.	Measurement is in progress. Remain as still as possible.
	Irregular Heartbeat indicator. (I.H.B.) The indicator that appears when an irregular heartbeat or any excessive body movement is detected during the measurement.	_____
M	Previous measurements stored in MEMORY.	_____
 Full Battery	The battery power indicator during measurement.	_____
 Low Battery	The battery is low when it blinks.	Replace all batteries with new ones, when the indicator blinks.
<i>Err</i>	Unstable blood pressure due to movement during the measurement.	Try the measurement again. Remain very still during the measurement.
	The systolic and diastolic values are within 10 mmHg of each other.	Fasten the cuff correctly, and try the measurement again.
	The pressure value did not increase during inflation.	
<i>Err</i> <i>CUF</i>	The cuff is not fastened correctly.	Fasten the cuff correctly, and try the measurement again.
<i>Err</i> PUL. DISPLAY ERROR	The pulse is not detected correctly.	
SYS.	Systolic blood pressure in mmHg	_____
DIA.	Diastolic blood pressure in mmHg	_____
PUL./min.	Pulse per minute	_____
	CLOCK button mark	_____
	▶ button mark	_____
	Alarm ON/OFF mark	If you want to stop the sound, press any button.
 0123	EC directive medical device label	_____
	WEEE label	_____

Symbols	Function / Meaning	Recommended Action
	EU-representative	_____
	Manufacturer	_____
	Class II device	_____
	Refer to instruction manual/booklet	_____
	Polarity of DC jack	

Operation Mode

1. Normal Measurement With Storing Data *(Refer to page 11)*

Press the **START** button. Blood pressure is measured and data is stored within the device. The device can store the last ninety sets of data in memory.

2. Recalling The Data *(Refer to page 13)*

Press the **MEMORY** button to recall the data. First, average of all the data is shown.

Each time the **MEMORY** button is pressed, the memory data is displayed from the most recent.

For details on recalling data, refer to “Recalling Memory Data” on page 13.

The device can store the last ninety sets of data in memory.

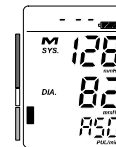
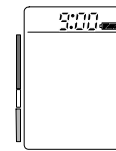

Average of
Systolic pressure
Diastolic pressure
Nos. of Data



Systolic pressure
Diastolic pressure
Pulse rate

3. Clearing The Data *(Refer to page 13)*

Press and hold the **MEMORY** button until the “**M**” (memory) mark blinks to clear the stored data.

4. Measurement With The Desired Systolic Pressure

Refer to page 12 for the measurement with the desired systolic pressure.



Using The Monitor

Installing / Changing The Batteries

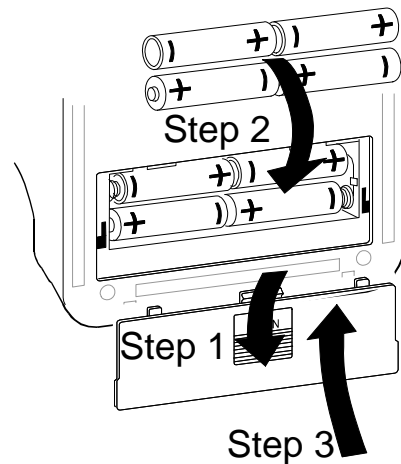
1. Slide the battery cover to open it.
2. Remove the used batteries and insert new batteries into the battery compartment as shown, taking care that the polarities (+) and (-) are correct.
3. Slide the battery cover to close it.
Use only R6P, LR6 or AA batteries.



CAUTION

- Insert the batteries as shown in the battery compartment. If not, the device will not work.
- When  (LOW BATTERY mark) blinks on the display, replace all batteries with new ones. Do not mix old and new batteries. It may shorten the battery life, or cause the device to malfunction.
-  (LOW BATTERY mark) does not appear when the batteries are drained.
- Battery life varies with the ambient temperature and may be shorter at low temperatures.
- Use the specified batteries only. The batteries provided with the device are for testing monitor performance and may have a limited life.
- Remove the batteries if the device is not to be used for a long time. The batteries may leak and cause a malfunction.
- Stored data are cleared when the batteries are removed.

Connecting The Air Hose

Insert the air connector plug into the air socket firmly.

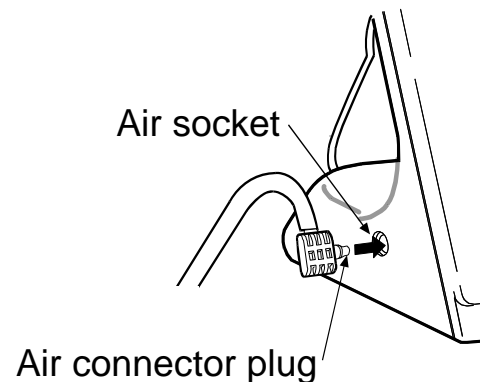

Connecting The AC Adapter

Insert the AC adapter plug into the DC jack.
Then, insert the AC adapter into an electrical outlet.

The AC adapter, the model TB-233, is sold separately.

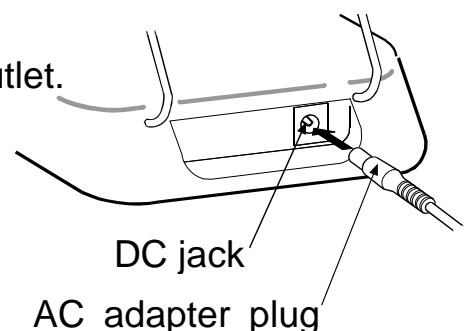

Using The Monitor

Adjusting The Built-in Clock

The monitor has a built-in 24-hour clock. We recommend that you adjust the clock prior to use.

1. Press and hold the CLOCK button until the digits start blinking.
2. Select the year using the ► button. Press the CLOCK button to set the current year and move to month/day selection. The date can be set anywhere between the years 2006 and 2056.
3. Select the month using the ► button. Press the CLOCK button to set the current month and move to day selection.
4. Select the day using the ► button. Press the CLOCK button to set the current day and move to hour/minute selection.
5. Select the hour using the ► button. Press the CLOCK button to set the current hour and move to minute selection.
6. Select the minute using the ► button. Press the CLOCK button to set the current minute and activate the clock.

Press and hold the CLOCK button

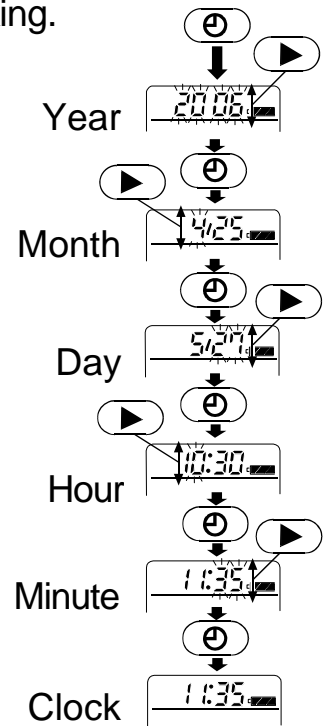

Setting Three Reminders

This monitor has 3 reminder alarms. You can set 3 different reminder alarms within a 24-hour period.

1. Press and hold the CLOCK button until the digits start blinking. Then press the MEMORY button. "P-1" is shown at the middle line of the display.
2. Select the hour using the ► button and press the CLOCK button to set the hour and move to minute selection. Press the MEMORY button to complete the reminder setting after selecting minute.
3. Then the display shows "P-2" and the ((●)) mark for the second reminder. Repeat the above process if you need a second reminder.
4. A third reminder can be set as well.

Press and hold ⌚

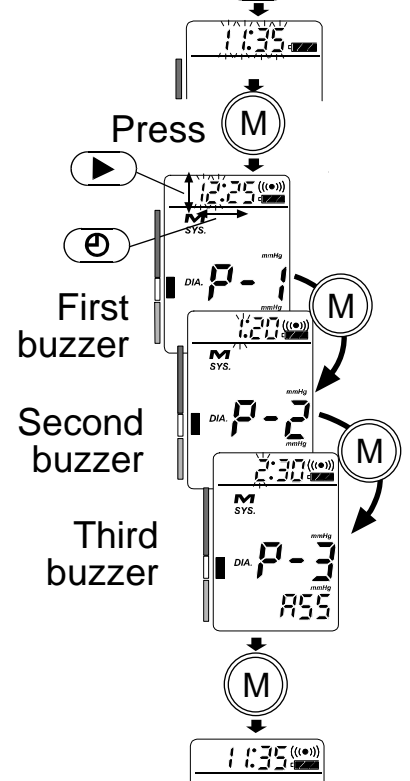

Using The Monitor

Alarm ON/OFF Mark On The Display

When the alarm is on, a “ ((•)) ” appears on the LCD. To turn the alarm off, simply press the CLOCK button once.

The alarm will sound for 1 minute. To stop the alarm sound, press any button once.

Selecting the Correct Cuff Size

Using the correct cuff size is important for an accurate reading. If the cuff is not the proper size, the reading may yield an incorrect blood pressure value.

- The arm size is printed on each cuff.
- The index ▲ and proper fit range, on the cuff, tell you if you are applying the correct cuff. (Refer to "Symbols that are printed on the cuff".)
- If the index ▲ points outside of the range, contact your local dealer to purchase a replacement cuff.
- The arm cuff is a consumable. If it becomes worn, purchase a new one.

Arm Size	Recommended Cuff Size	Catalog Number
32 cm to 45 cm	Large adult cuff	CUF-D-LA
22 cm to 32 cm	Adult Cuff	CUF-D-A
18 cm to 22 cm	Small adult Cuff	CUF-D-SA

Arm size: The circumference of the biceps.

Symbols that are printed on the cuff

Symbols	Function/Meaning	Recommended Action
●	Artery position mark	Set the ● mark on the artery of the upper arm or in line with the ring finger on the inside of the arm.
▲	Index	_____
REF	Catalog number	_____
A	Proper fit range for the adult cuff. It's printed on the adult cuff.	_____
L	Range to use the large adult cuff. Over range printed on the adult cuff.	Use the large adult cuff instead of the adult cuff.
L	Proper fit range for the large adult cuff. It's printed on the large adult cuff.	_____
S	Under range printed on the adult cuff.	_____
S	Proper fit range for the small adult cuff. It's printed on the small adult cuff.	_____
A	Range to use the adult cuff. It's printed on the large adult cuff.	Use the adult cuff instead of the large adult cuff.
LOT	Lot number	_____



Using The Monitor

Applying The Arm Cuff

1. Wrap the cuff around the upper arm, about 1-2 cm above the inside of the elbow, as shown.
Place the cuff directly against the skin, as clothing may cause a faint pulse, and result in a measurement error.
2. Constriction of the upper arm, caused by tightly rolling up a shirtsleeve, may prevent accurate readings.
3. Confirm that the index ▲ points within the proper fit range.

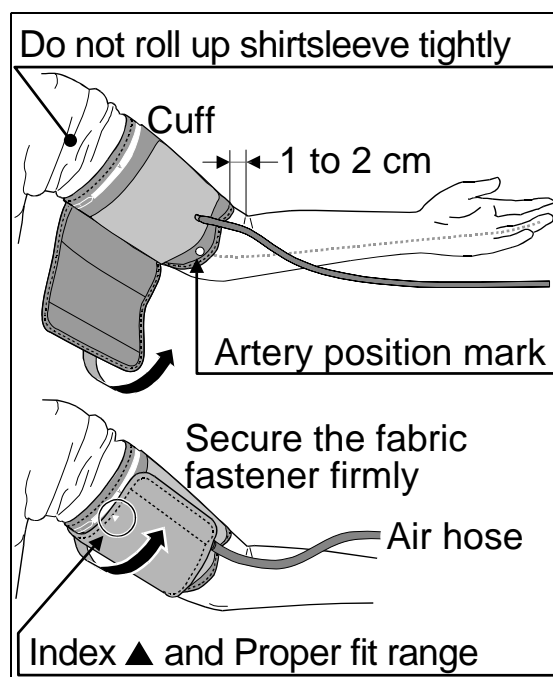

How To Take Proper Measurements

For the most accurate blood pressure measurement:

- Sit comfortably on a chair. Rest your arm on the table. Do not cross your legs. Keep your feet on the floor and straighten your back.
- Relax before measurement.
- Place the center of the cuff at the same height as your heart.
- Remain still and keep quiet during measurement.
- Do not measure immediately after physical exercise or a bath. Rest before taking the measurement.
- Try to measure your blood pressure at the same time every day.

Measurement

During measurement, it is normal for the cuff to feel very tight. (Do not be alarmed)

After Measurement

After measurement, press the **START** button to turn off the power. Remove the cuff and record your data.

Note: The device has an automatic power shut-off function, which turns the power off approximately two minute after measurement.
Allow at least three minutes between measurements on the same person.

Measurements

Model UA-852 is designed to detect the pulse and to inflate the cuff to a systolic pressure level automatically.

If your systolic pressure is expected to exceed 230 mmHg or you use the optional small cuff, read "Measurement With The Desired Systolic Pressure" on the next page.

Normal Measurement

1. Place the cuff on the arm (preferably the left arm).
Sit quietly during measurement.

2. Press the **START** button.
0 (zero) is displayed blinking briefly. Then the display changes, as indicated in the figure at the right, as the measurement begins. The cuff starts to inflate. It is normal for the cuff to feel very tight.

A pressure bar indicator is displayed, as in the figure at the right, during inflation.

Note: If you wish to stop inflation at any time, press the **START** button again.

3. When inflation is complete, deflation starts automatically and  (heart mark) blinks, indicating that the measurement is in progress. Once the pulse is detected, the mark blinks with each pulse beat.

Note: If an appropriate pressure is not obtained, the device starts to inflate again automatically.

4. When the measurement is complete, the systolic and diastolic pressure readings and pulse rate are displayed. The cuff exhausts the remaining air and deflates completely.

5. Press the **START** button again to turn off the power.

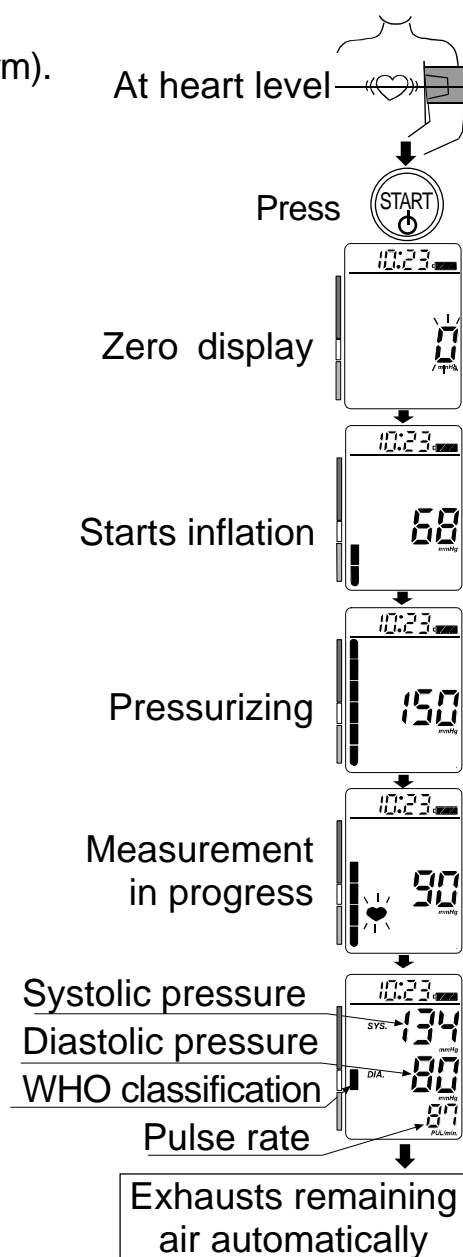

Note: Model UA-852 is provided with an automatic power shut-off function. The clock display remains on the LCD. Allow at least ten minutes between measurements on the same person.

Measurements

Measurement With The Desired Systolic Pressure

If your systolic pressure is expected to exceed 230 mmHg or you use the optional small cuff, use this procedure.

1. Place the cuff on the arm (preferably the left arm).
2. Press and hold the **START** button until a number about 30 to 40 mmHg higher than your expected systolic pressure appears.
3. Release the **START** button to start measurement, when the desired number is reached. Then continue to measure your blood pressure as described on the previous page.

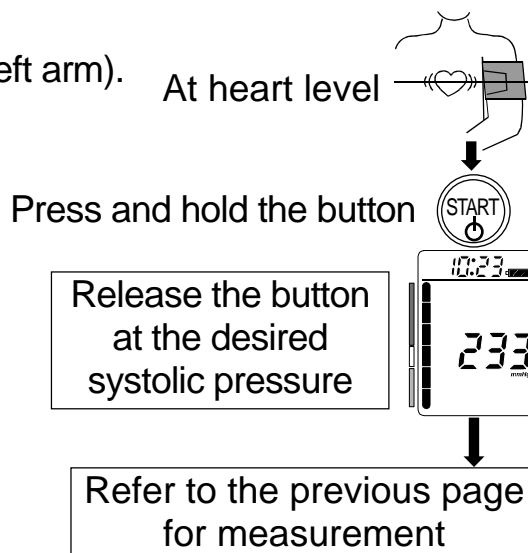

Notes For Proper Measurement

- Sit down in a comfortable position. Place the arm to be used for the measurement on a table or other support so that the center of the cuff will be at the same height as your heart.
- Relax for about five or ten minutes before taking a measurement. If you are excited or depressed by emotional stress, the measurement will reflect this stress as a higher (or lower) than normal blood pressure reading and the pulse reading will usually be faster than normal.
- An individual's blood pressure varies constantly, depending on what you are doing and what you have eaten. What you drink can have a very strong and rapid effect on your blood pressure.
- This device bases its measurements on the heartbeat. If you have a very weak or irregular heartbeat, the device may have difficulty determining your blood pressure.
- Should the device detect a condition that is abnormal, it will stop the measurement and display an error symbol. Refer to page 5 for the description of symbols.
- This blood pressure monitor is intended for use by adults only. Consult with your physician before using this device on a child. A child should not use this device unattended.

Recalling Memory Data

Note: This device stores the last ninety measurements in memory. The data is retained as long as the batteries are in the device. When you remove the batteries or the batteries are drained, the data will be erased.

1. Press the **MEMORY** button.
Average of stored data is shown.
2. Press the **MEMORY** button.
The most recent data is displayed.
3. Then, each time the **MEMORY** button is pressed, the previous data is displayed.
4. After the last data is displayed, the display returns to the clock display.

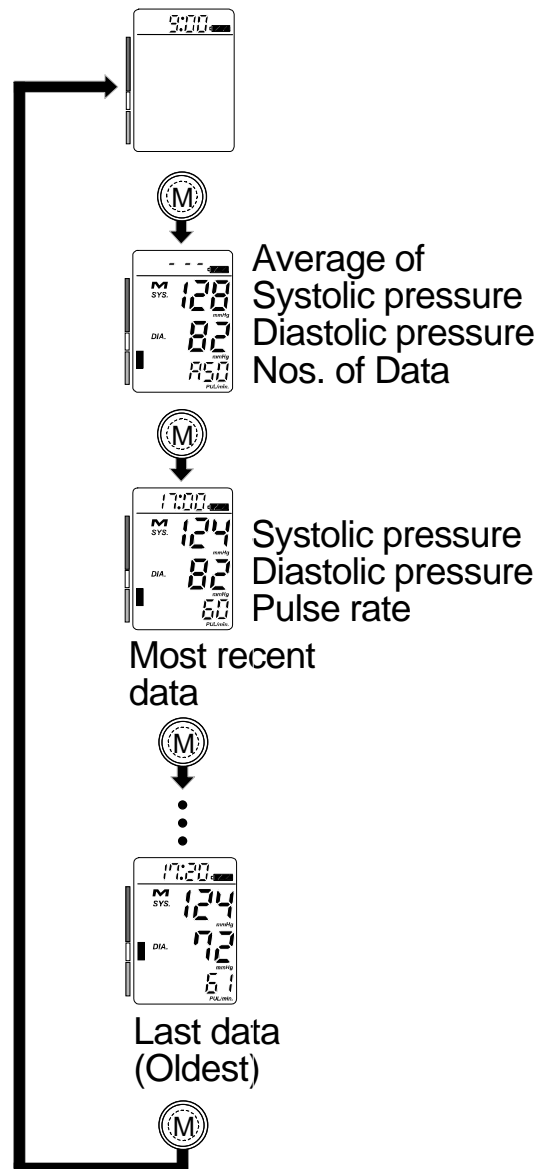

Clearing the memory data

5. Press and hold the **MEMORY** button until the “**M**” (memory) mark blinks to clear the stored data.

Note: Pressing the **START** button while the memory data is displayed initiates the UA-852 to start taking a measurement.

What Is An Irregular Heartbeat

Model UA-852 blood pressure monitor provides a blood pressure and pulse rate measurement even when an irregular heartbeat occurs. An irregular heartbeat is defined as a heartbeat that varies by 25% from the average of all heartbeats during the blood pressure measurement. It is important that you be relaxed, remain still and do not talk during measurements.

Note: We recommend contacting your physician if you see this ((♡)) indicator frequently.

Pressure Bar Indicator

The indicator monitors the progress of pressure during measurement.

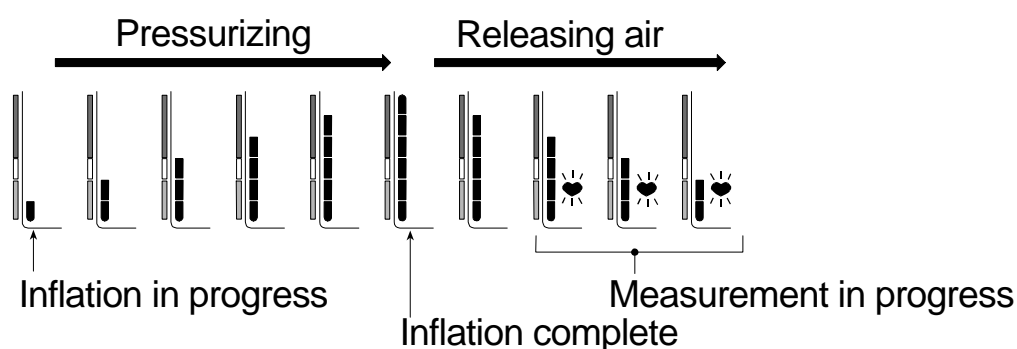

WHO Classification Indicator

Each segment of the bar indicator corresponds to the WHO blood pressure classification described on the next page.

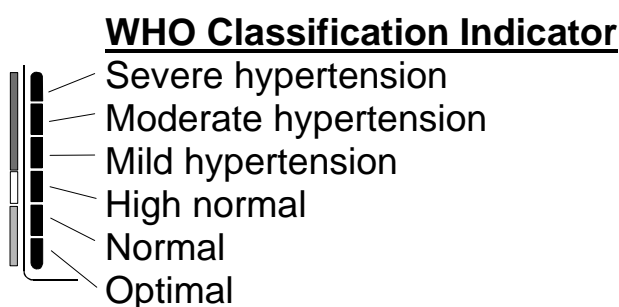

■ : The indicator displays a segment, based on the current data, corresponding to the WHO classification.

Example:

Moderate hypertension
 SYS: 174
 DIA: 102
 PUL: 87

Mild hypertension
 SYS: 147
 DIA: 98
 PUL: 87

High normal
 SYS: 134
 DIA: 87
 PUL: 87

About Blood Pressure

What Is Blood Pressure?

Blood pressure is the force exerted by blood against the walls of the arteries. Systolic pressure occurs when the heart contracts. Diastolic pressure occurs when the heart expands. Blood pressure is measured in millimeters of mercury (mmHg). One's natural blood pressure is represented by the fundamental pressure, which is measured first thing in the morning while one is still at rest and before eating.

What Is Hypertension And How Is It Controlled?

Hypertension, an abnormally high arterial blood pressure, if left unattended, can cause many health problems including stroke and heart attack. Hypertension can be controlled by altering lifestyle, avoiding stress, and with medication under a doctor's supervision.

To prevent hypertension or keep it under control:

- Do not smoke
- Reduce salt and fat intake
- Maintain proper weight
- Exercise regularly
- Have regular physical checkups

Why Measure Blood Pressure At Home?

Blood pressure measured at a clinic or doctor's office may cause apprehension and can produce an elevated reading, 25 to 30 mmHg higher than that measured at home. Home measurement reduces the effects of outside influences on blood pressure readings, supplements the doctor's readings and provides a more accurate, complete blood pressure history.

WHO Blood Pressure Classification

Standards to assess high blood pressure, without regard to age, have been established by the World Health Organization (WHO), as shown in the chart.

Reference Material: Journal of Hypertension 1999, Vol 17 No.2

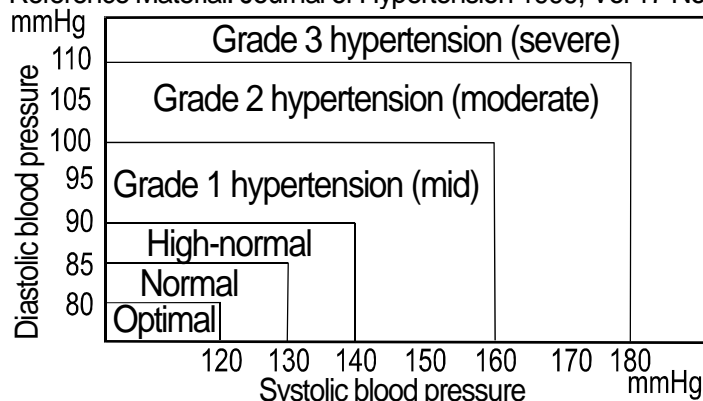

Blood Pressure Variations

An individual's blood pressure varies greatly on a daily and seasonal basis. It may vary by 30 to 50 mmHg due to various conditions during the day. In hypertensive individuals, variations are even more pronounced. Normally, the blood pressure rises while at work or play and falls to its lowest levels during sleep. So, do not be overly concerned by the results of one measurement.

Take measurements at the same time every day using the procedure

described in this manual to get to know your normal blood pressure.

Regular readings give a more comprehensive blood pressure history. Be sure to note date and time when recording your blood pressure. Consult your doctor to interpret your blood pressure data.

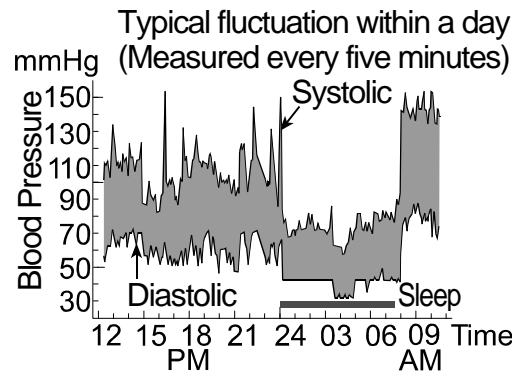

Troubleshooting

Problem	Possible Reason	Recommended Action
Nothing appears on the display, even when the power is turned on.	Batteries are drained.	Replace all batteries with new ones.
	Battery terminals are not in the correct position.	Reinstall the batteries with negative and positive terminals matching those indicated on the battery compartment.
The cuff does not inflate.	Battery voltage is too low.  (LOW BATTERY mark) blinks. [If the batteries are drained completely, the mark does not appear.]	Replace all batteries with new ones.
The unit does not measure. Readings are too high or too low.	The cuff is not fastened properly.	Fasten the cuff correctly.
	You moved your arm or body during the measurement.	Make sure you remain very still and quiet during the measurement.
	The cuff position is not correct.	Sit comfortably and still. Raise your hand so that the cuff is at the same level as your heart.
	_____	If you have a very weak or irregular heart beat, the device may have difficulty in determining your blood pressure.
Other	The value is different from that measured at a clinic or doctor's office.	Refer to "Why measure blood pressure at home".
	_____	Remove the batteries. Place them back properly and try the measurement again.

Note: If the actions described above do not solve the problem, contact the dealer. Do not attempt to open or repair this product, as any attempt to do so will make your warranty invalid.

Maintenance

Do not open the device. It uses delicate electrical components and an intricate air unit that could be damaged. If you cannot fix the problem using the troubleshooting instructions, request service from your dealer or from the A&D service group. The A&D service group will provide technical information, spare parts and units to authorized dealers.

The device was designed and manufactured for a long service life. However it is generally recommended to have the device inspected every 2 years, to ensure proper functioning and accuracy. Please contact either your authorized dealer or A&D for maintenance.

Technical Data

Type	UA-852
Measurement method	Oscillometric measurement
Measurement range	Pressure: 20 - 280 mmHg Pulse: 40 - 180 beats / minute
Measurement accuracy	Pressure: ± 3 mmHg Pulse: $\pm 5\%$
Power supply	4 x 1.5V batteries (R6P, LR6 or AA) or AC adapter (TB-233) (Not included)
Number of measurements	Approx. 450 measurements, when AA Alkaline batteries are used, with pressure value of 180 mmHg at room temperature of 23°C
Classification	Internally powered ME equipment (Supplied by batteries) Class II (Supplied by adapter) Continuous operation mode
Clinical test	According to ANSI / AAMI SP-10 1992
EMC	IEC 60601-1-2: 2007
Memory	Last 90 measurements
Operating condition	+10°C to +40°C / 15%RH to 85 %RH 800-1060hPa
Transport / Storage conditions	-10°C to +60°C / 15%RH to 85 %RH
Dimensions	Approx. 150 [W] x 156 [H] x 120 [D] mm
Weight	Approx. 500 g, excluding the batteries
Applied part	Cuff Type BF 
Useful life	Device: 5 years (when used six times a day) Cuff: 2 years (when used six times a day)

Accessory AC adapter

TB-233

The adapter is to connect the blood pressure monitor to a power source at home.

Please contact your local A&D dealer for purchasing.

The AC adapter is required to be inspected or replaced periodically.

TB-233C

Input: 100-240V





Output: 6V  500mA

TB-233BF

Input: 240V

Output: 6V  500mA

Accessories sold separately

Cuff

Catalog Number	Cuff Size	Arm Size
CUF-D-LA	Large adult cuff	32 cm to 45 cm
CUF-D-A	Adult cuff	22 cm to 32 cm
CUF-D-SA	Small adult cuff	18 cm to 22 cm

AC adapter

Catalog Number	Plug
TB-233C	Type C
TB-233BF	Type BF

Note: Specifications are subject to change without prior notice.

EMC table information is listed on our website:

http://www.aandd.jp/products/manual/medical/emc_acadapter_en.pdf



 **A&D Company, Limited**

1-243 Asahi , Kitamoto-shi, Saitama 364-8585, JAPAN
Telephone: [81] (48) 593-1111 Fax: [81] (48) 593-1119

 **A&D INSTRUMENTS LIMITED**

Unit 24/26 Blacklands Way, Abingdon Business Park, Abingdon, Oxfordshire OX14 1DY United Kingdom
Telephone: [44] (1235) 550420 Fax: [44] (1235) 550485

A&D ENGINEERING, INC.

1756 Automation Parkway, San Jose, California 95131, U.S.A.
Telephone: [1] (408) 263-5333 Fax: [1] (408)263-0119

A&D AUSTRALASIA PTY LTD

32 Dew Street, Thebarton, South Australia 5031, AUSTRALIA
Telephone: [61] (8) 8301-8100 Fax: [61] (8) 8352-7409