

# USER'S MANUAL

# ELECTRON

Model: LCD2622E

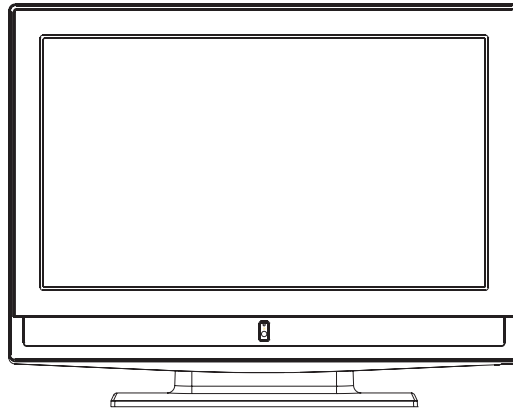

Please read this User Manual carefully to ensure the proper use of this product and keep this manual for future reference

## Contents

1、 Safety and warnings.....	2-6
2、 Introduction.....	7
3、 Installation.....	8-12
4、 Remote Control .....	13
5、 TV Operation.....	14-15
6、 TV Trouble shooting.....	16
7、 Wall Mounting Holes Spacing and Location.....	17
8、 Base Stand Disassemble Illustration.....	17

## ***SAFETY AND WARNINGS***

### **IMPORTANT SAFETY INSTRUCTION**

1. Read these safety instructions.
2. Keep these safety instructions.
3. Heed all warnings.
4. Follow all safety instructions.
5. Do not use this apparatus near water.
6. Clean only with dry cloth.
7. Do not block any ventilation openings. Install in accordance with the manufacturers instructions.
8. Do not install near any heat sources such as radiators, stoves, or other apparatus (including amplifiers) that produce heat.



9. Protect the power cord from being walked on or pinched particularly at power outlets, and the point where they exit from the apparatus.
10. Only use attachments/accessories specified by the manufacturer.
11. Unplug this apparatus during lightning storms or when unused for long periods of time.
12. Refer all servicing to qualified service personnel. Servicing is required when the apparatus has been damaged in any way, such as the power-supply cord or plug is damaged, liquid has been spilled or objects have fallen into the apparatus, the apparatus has been exposed to rain or moisture, does not operate normally, or has been dropped.
13. Apparatus must not be exposed to dripping or splashing and no objects filled with liquids, such as vases, should be placed on the apparatus.
14. **WARNING:** The battery (battery or batteries or battery pack) shall not be exposed to excessive heat such as sunshine, fire or the like.
15. The mains plug is used as disconnect device, the disconnect device shall remain readily operable.

## ***SAFETY AND WARNINGS***

 This symbol indicates that this product incorporates double insulation between hazardous mains voltage and user accessible parts. When servicing use only identical replacement parts.  
WARNING: To reduce the risk of fire or electric shock, do not expose this apparatus to rain or cords.

 Correct Disposal of this product. This marking indicates that this product should not be disposed with other household wastes throughout the EU. To prevent possible harm to the environment or human health from uncontrolled waste disposal, recycle it responsibly to promote the sustainable reuse of material resources. To return your used device, please use the return and collection systems or contact the retailer where the product was purchased. They can take this product for environmental Safe recycling.

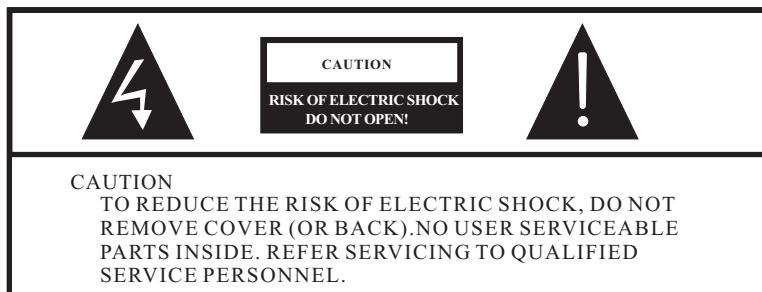

The symbol indicates that dangerous voltages constituting a risk of electric shock are present within this unit.



The symbol indicates that there are important operating and maintenance instructions in the literature accompanying this unit.

### **WARNING:**

To prevent fire or shock hazard, do not expose this appliance to rain or moisture.

***SAFETY AND WARNINGS***

---



Warning

High voltages are used in the operation of this television receiver. Do not remove the cabinet back from your set. Refer servicing to qualified service personnel.

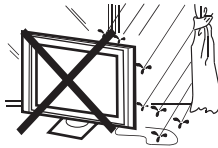

Warning

To prevent fire or electrical shock hazard, do not expose the television receiver to rain or moisture.



Warning

Do not drop or push objects into the television cabinet slots or openings. Never spill any kind of liquid on the television receiver.



Caution

Do not block the ventilation holes in the back cover. Adequate ventilation is essential to prevent failure of electrical components.



Caution

Do not trap the power supply cord under the television receiver.

***SAFETY AND WARNINGS***

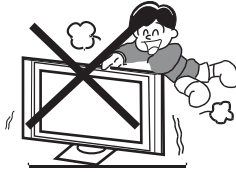

 Caution

Never stand on, lean on, or suddenly push the television or its stand. You should pay special attention to children. Serious injury may result if it falls.

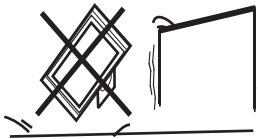

 Caution

Do not place your television on an unstable cart, stand, shelf or table. Serious injury to an individual, and damage to the television, may result if it falls.

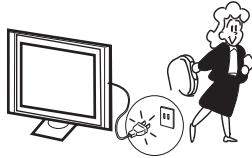

 Caution

When the television receiver is not used for an extended period of time, it is advisable to disconnect the AC power cord from the AC outlet.

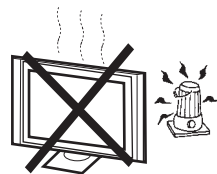

 Caution

Avoid exposing the television receiver to direct sunlight and other sources of heat. Do not stand the television receiver directly on other products which give off heat, e.g. video cassette players and audio amplifiers. Do not place naked flame sources, such as lighted candles on the television.

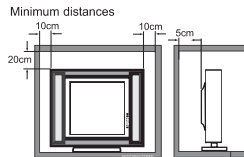

 Caution

If the television is to be built into a compartment or similar enclosure, the minimum distances must be maintained. Heat build-up can reduce the service life of your television, and can also be dangerous.

## ***SAFETY AND WARNINGS***

Thank you very much for purchasing this TV. To enjoy your product from the very beginning, read this manual carefully and keep it handy for easy reference.



### **INSTALLATION**

- Locate the TV in the room where light does not strike the screen directly.
- Total darkness or a reflection on the picture screen can cause eyestrain. Soft and indirect lighting is recommended for comfortable viewing.
- Allow enough space between the TV and the wall to permit ventilation.
- Avoid extremely warm locations to prevent possible damage to the cabinet or premature component failure.
- This TV can be connected to AC 100-240 Volts, 50/60 Hz. Never connect to a DC supply or any other power supply.
- Do not cover the ventilation openings when using the TV.

### **CAUTION**

Never tamper with any components inside the TV, or any other adjustment controls not mentioned in this manual. All LCD-TVs are high voltage instruments. When you clean up dust or water drops on the LCD PANEL or CABINET, the power cord should be pulled out from the receptacle, then wipe the TV with a dry soft cloth. During thunder and lightning, unplug the power cord and antenna cord to prevent damage to your TV.

All repairs to this TV should only be performed by qualified TV service personnel.

Earthing connection--- The apparatus shall be connected to MAINS socket outlet with a protective earthing connection.

MAINS plug or appliance coupler of the apparatus is used as disconnect device, it should remain readily operable.

Warning: Change or modifications to this unit not expressly by the part responsible for compliance could void the user's authority to operate the Equipment.

**Main features**

- ① Used as Television, display terminal, PC display;
- ② High luminance, wide viewing angle;
- ③ Can store AIR 2-69, HRC 1-125, IRC 1-125, CATV 2-125 TV programs
- ④ HDMI interface :

**Accessories**

- AC Power Cord..... 1
- Infrared Remote Controller..... 1
- Battery(AAA).....2
- User's Manual.....1

**Main parameter**

Viewing Picture Size(diagonal)	26"
Resolution	1366x768
Aspect Ratio	16 : 9
TV System	NTSC-M
Video Signal System	PAL/NTSC/SECAM
Receiving Channel	AIR 2-69 HRC 1-125 IRC 1-125 CATV 2-125
Response Time	8ms
Viewing Angle	160 °H/150 °V
Brightness	400cd/m <sup>2</sup>
Input Power Voltage	AC 100 V-240 V~ 50/60Hz
Power consumption	130W
Audio Output Power (THD≤7%)	2x3W
Signal Input	Analog RGB(VGA) x1 High-Definition Multimedia Interface (HDMI) x1 Rear AV x1 Audio Input x1 YCb (Pb)Cr (Pr) x1 Side AV x1 Side HEAD PHONE x1
Horizontal definition (TV line)	Composite Video input ≥350 S-Video Input ≥400 Y Cb(Pb) Cr(Pr) ≥400



**Front panel**

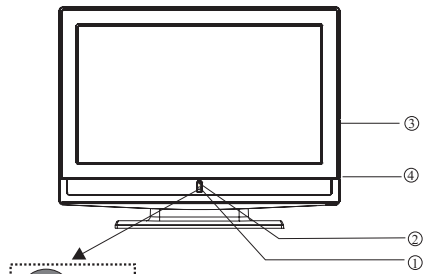

- 1: Remote control sensor.
- 2: Indicator LED: GREEN ● POWER ON.  
RED ● STAND BY.
- 3: Control Panel (see next page).
- 4: Power: Press this button to turn the unit ON from STANDBY mode. Press it again to turn the set back to STANDBY.
- 5: when TV is in standby mode, press CH + or CH - button in TV control panel will power on the TV.

**KEYBOARD**

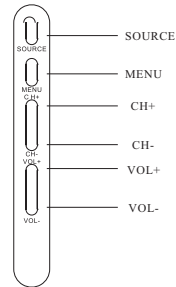

1. **SOURCE:** Display the input source menu.
2. **MENU:** To display main MENU.
3. **CH+/CH-**  
In Analogue TV mode, press “CH+” or “CH-” to change the channel up and down.  
In MENU,press “CH+” or “CH-” to select items in MENU.  
In standby mode, it can turn on the TV.
4. **VOL+/VOL-**  
Adjust sound level.  
In MENU,adjust the item that you selected.

**SIDE PANEL(LEFT)**

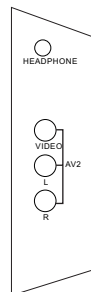

All the terminals are(from up to down):  
HEAD PHONE, Av2.

**REAR AV PASTER**



All the terminals are(from left to right):  
AC POWER SOCKET,ANTENNA , PC AUDIO INPUT,AUDIO INPUT,  
YPbPr,AV1,VGA , HDMI .

- Note: 1.AV1 and YPbPr share one audio channel.  
2. When HDMI port get DVI signal, the “PC Audio” channel is changed to receive the audio for HDMI port.

ANTENNA

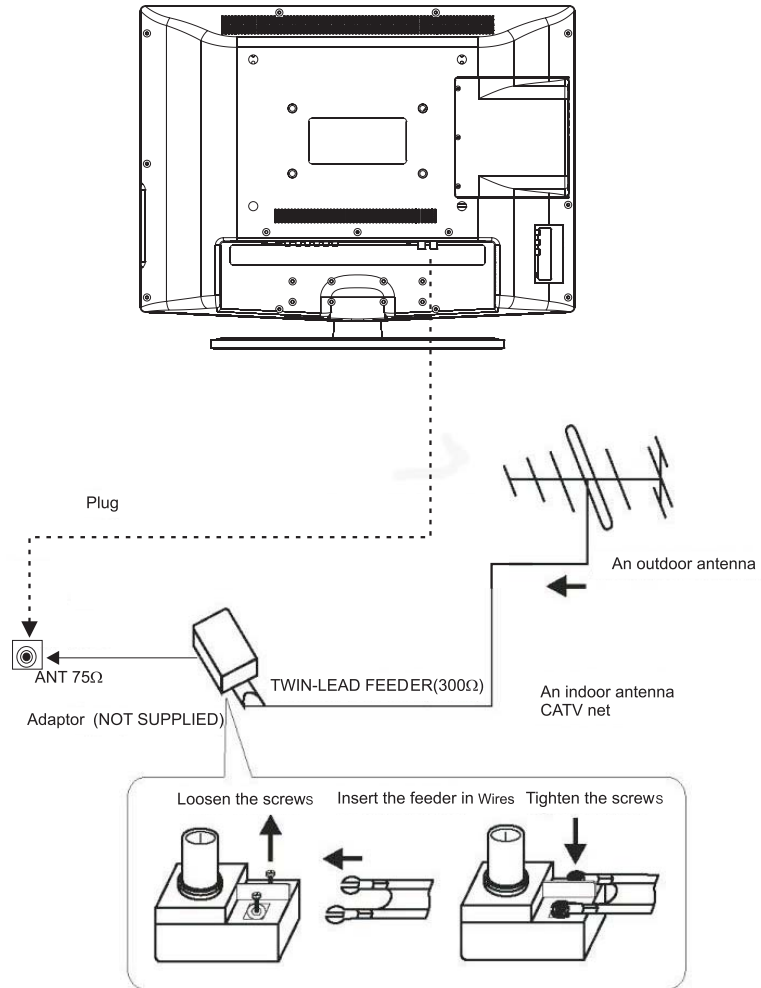

Note:  
Aerial connections:IEC(female).  
Input impedance:75Ω unbalanced.

**PC**

**STEPS:**

Be sure both the TV and computer are Power off.

- 1.Connect VGA and audio cable
- 2.Connect power cord
- 3.Power on the TV, switch to PC mode
- 4.Power on the PC

This sequence is very important.

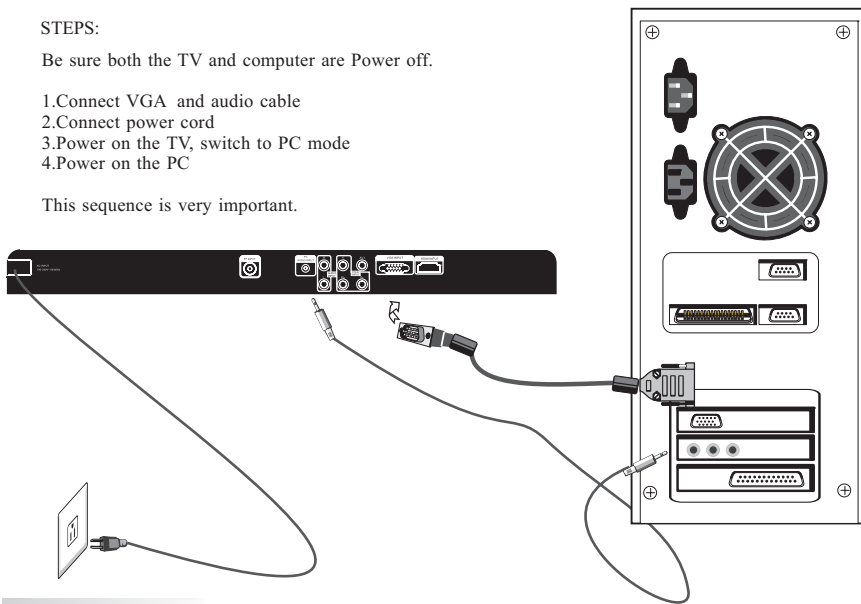

**PC**

**PRESET MODE**

	<b>RESOLUTION</b>	<b>V.Freq.(Hz)</b>	<b>H.Freq.(KHz)</b>
1	800*600	60	37.88
2	1024*768	60	48.36
3	1280*768	60	47.3

**NOTE:**

PC V.Freq.(Hz) not more than 60Hz.

**AV EQUIPMENT**

This TV provides three groups of AV ,one S-Video,one group of YPbPr and for convenient connection to VCR,DVD or other video equipment. Please refer to the owner's manual of the equipment to be connected as well.

You can use the input terminals on TV set rear as follows.

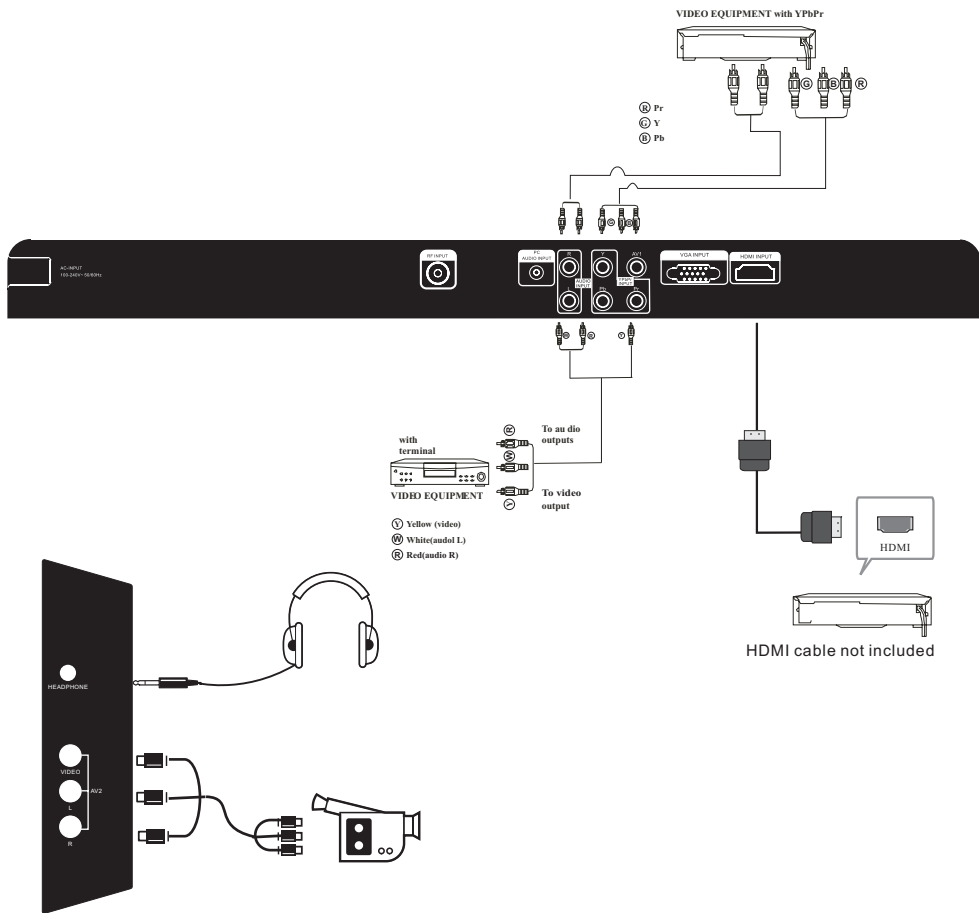

It can be connected to the following appliances: VCR, multi disc player, DVD, camcorder, video game or stereo system, etc.....

YPbPr can support these video formats:480i,576i,480p,576p,720p,1080i,1080p.

### Insert Batteries Into the Remote Control

1. Remove the battery cover.
2. Insert the 2 AAA 1.5V batteries making sure the polarity (+ or -) of the batteries matches the polarity marks inside the unit.
3. Mount the battery cover.

Replace with new batteries when the TV set begins to show the following symptoms:  
Operation is unsteady or erratic. Sometimes the TV set does not function with Remote Control Unit.

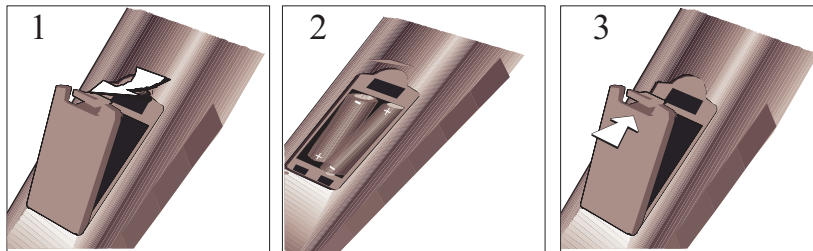

#### Remark:

- 1) Alkaline Battery Recommended.
- 2) Remove batteries when they are exhausted or if the remote control is not to be used for a long time.

REMOTE CONTROL

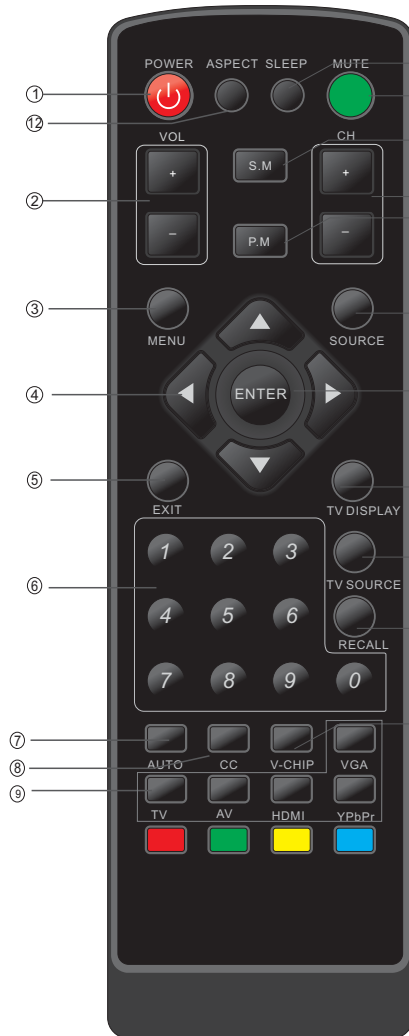

- 1: **POWER**  
To set the TV standby or on.
- 2: **VOL +/-**  
To adjust sound level.
- 3: **MENU**  
To display TV menu.
- 4: **CURSOR**  
To move within the menu.
- 5: **EXIT**  
Used to return to the previous menu or exit menu.
- 6: **NUMBER KEY:**  
For direct access to program. For a 2 (3) digit program number, The second (third) digit must be entered before the dash disappears. Channel number will be displayed for a few seconds.
- 7: **AUTO**  
Auto adjust in PC mode.
- 8: **CC**  
Display caption during closed caption
- 9: Direct key to change input Source.
- 10: **SLEEP**  
Set time to turn off the TV
- 11: **MUTE**  
To disable or enable the sound.
- 12: **ASPECT**  
To change picture aspect
- 13: **S.M**  
To switch sound mode. program.
- 14: **CH+/CH-**  
To access the next or previous Program. Menu.
- 15: **P.M**  
To switch picture mode.
- 16: **SOURCE**  
To display or exit TV input source
- 17: **ENTER**  
Confirms selection.
- 18: **TV DISPLAY**  
Displays/removes the program Information
- 19: **TV SOURCE**  
To change TV SOURCE [CABLE,AIR]
- 20: **RECALL**  
To access the previously viewed
- 21: **V-CHIP**  
Enter parent ctrl

**1. PICTURE MENU**

The first item of the MENU is picture menu. You can adjust picture here, such as contrast, brightness, etc. press ◀▶ to move, press ⏴⏵ To Adjust.

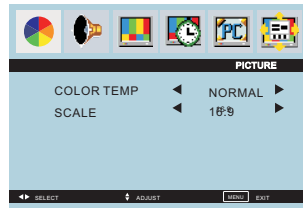
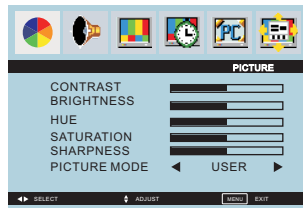

Note:

1. Three color temperatures: NORMAL, WARM, COOL.
2. Four picture modes: STANDARD, MOVIE, VIVID, USER.
3. HUE is available in NTSC system only.

**2. SOUND MENU**

The second item of the MENU is SOUND MENU. You can adjust sound here. Press ◀▶ to move, press ⏴⏵ to adjust.

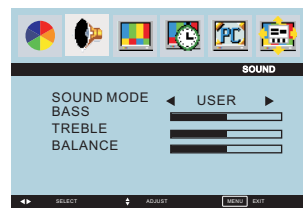

**3. CHANNEL MENU**

The third item of the MENU is channel menu (Only in TV mode). You can complete channel Search and setting here.

1. AUTO SCAN: Search all the channels automatically.
2. ADD/ERASE: To skip the current channel yes or not.
3. SOURCE: CABLE, AIR.
4. C. CAPTION: adjust c.c. Type.
5. PARENTAL CTRL: enter parent ctrl menu, The default password is 6666.

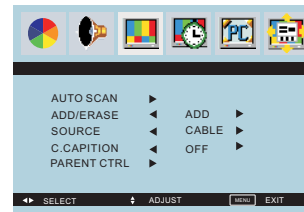

**4. FUNCTION MENU**

The fourth item of the MENU is function menu. You can adjust settings below.

1. SLEEP TIMER: adjust sleep time
2. DNR: noise reduction
3. MEMORY RECALL: Reset all the Settings to default value.

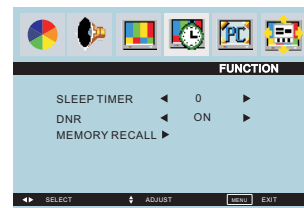

**PARENTAL CTRL**

You can adjust setting below .

- 1.PASSWORD:you can change the current PARENTAL CTRL password.
- 2.PARENTAL CTRL, you can turn off or On it .
- 3.TV-RATING ,you can enter TV rating Menu to adjust.

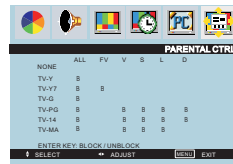
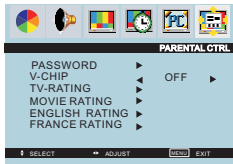

Rating	Content	Content				
		FV (Fantasy violence)	V (Violence)	S (Sexual situation)	L (Adult language)	D (Sexually suggestive dialog)
Suggesto age	TV-Y (All children)					
	TV-Y7(Direct to under children)	X				
	TV-G(General audience)					
	TV-PG(Parental Guidance suggested)		X	X	X	X
	TV-14(Parents strongly cautioned)		X	X	X	X
TV-MA(Mature audience only)		X	X	X		

And use ENTER key to switch Block/ Unblock Parental Control feature.

- 2).MPAA:switch the movie-rating control level: N/A, G, PG, PG-13,R,NC-17,X.

Rating	Description
G	General audiences, All Ages admitted
PG	Parental Guidance suggested. Some material may not be Suitable for children.
PG-13	Parents strongly cautioned. Some material .may be Inappropriate for children under 13.
R	Restrict. Under 17 requires accompanying parent or adult guardian(age varies in some jurisdictions)
NC-17	No one 17 and under admitted.
X	X is an order rating that is unified with NC-17 but may be encoded in the data of order movies.

**5.OSD MENU**

The sixth item of the MENU is OSD Menu.



**6.PC MENU**



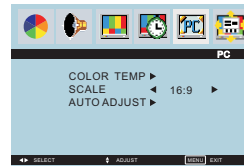
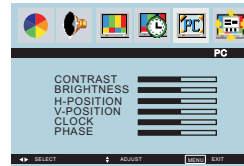













This MENU is available in PC only. You can adjust the PC effect and position.



Auto adjust in PC mode only.

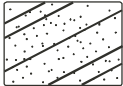

## Trouble shooting

Trouble phenomenon		Inspection
Picture	Audio	
 Snow	 Noise	antenna position, direction or connection
 Ghost	 Normal audio	antenna position, direction or connection
 Interfere	 Noise	electronic equipment, car/ motorcycle, fluorescent light
 Normal Picture	 Mute	Volume (inspect whether the mute function on the remote control are started, or audio system are correct or not)
 No picture	 Mute	Power cord is not inserted Power switch is not opened Contrast and brightness/volume setup Press standby key on the remote control for inspecting
 No color	 Normal audio	color control
 Scramble	 Normal audio or weak	retune channel
 No color	 Noise	Audio system

The LCDTV panel is built with very high precision technology giving you fine picture details in vibrant color. Occasionally, a few non-active pixels may appear on the screen as a fixed point of red, green, blue, black or white. Please note this does not affect the performance of the product.

## Wall Mounting Holes Spacing and Location

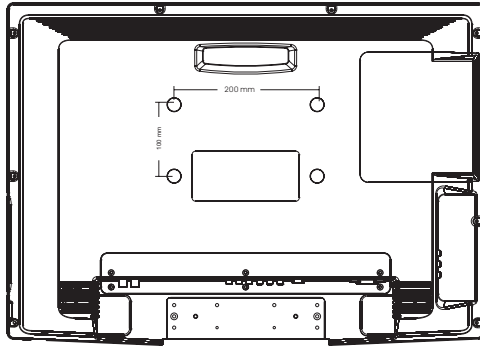

## Base Stand Disassemble Illustration

How to remove the stand from the TV

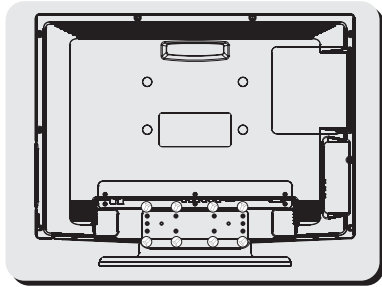

1. Use the screwdriver to remove the screws from the screw location.

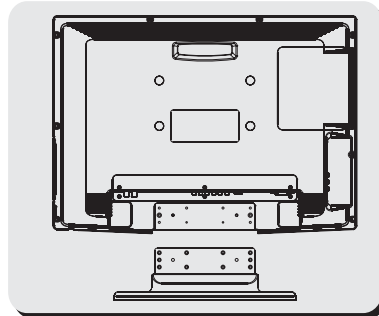

1. Remove the base stand from the Main body.

Main accessories

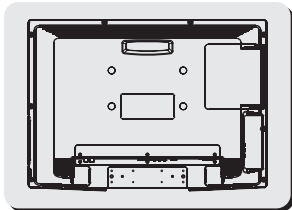

Main body

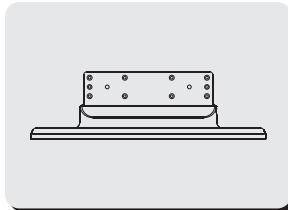

Base Stand

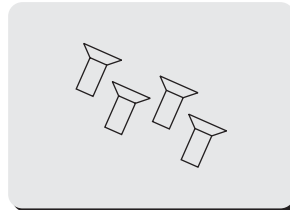

8 Screws



This symbol on the product or in the instructions means that your electrical and electronic equipment should be disposed at the end of life separately from your household waste. There are separate collection systems for recycling in the EU. For more information, please contact the local authority or your retailer where you purchased the product.