

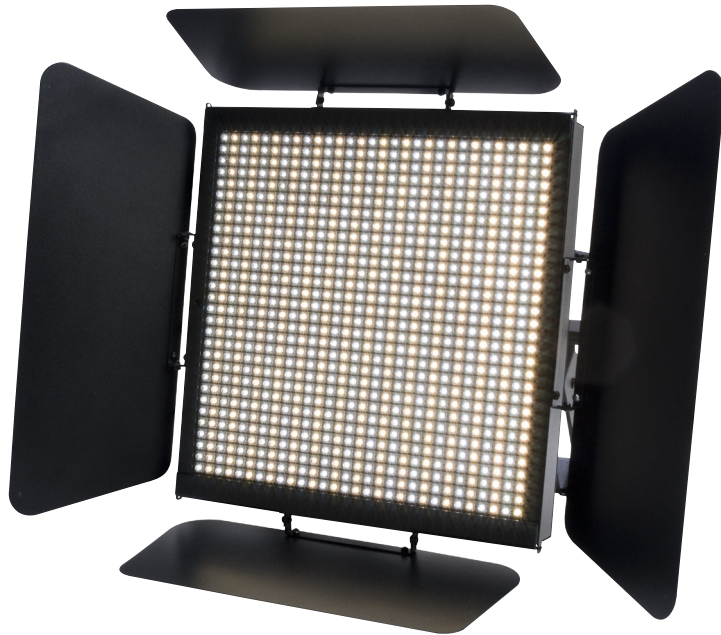

TVL2000 II



User Manual 1.0

TVL2000 II

General Information

Unpacking: Thank you for purchasing the TVL2000 II by Elation Professionals®. Every TVL2000 II has been thoroughly tested and has been shipped in perfect operating condition. Carefully check the shipping carton for damage that may have occurred during shipping. If the carton appears to be damaged, carefully inspect your fixture for any damage and be sure all equipment necessary to operate the unit has arrived intact. In the event damage has been found or parts are missing, please contact our toll free customer support number for further instructions. Please do not return this unit to your dealer without contacting customer support first.

Introduction: The TVL2000 II DMX intelligent LED fixture. The TVL2000 II has 3 DMX Modes; Two 2 Channel DMX Modes, and a 3 Channel Mode. The fixture two operating modes; manual mode or DMX controlled. The TVL2000 II can only be run as stand alone unit. This fixture is suitable for theaters, studios, retail stores, and other similar locations. *For best results use fog or special effects smoke to enhance the light projections.*

Customer Support: Elation Professionals® provides a toll free customer support line, to provide help and to answer any question should you encounter problems during your set up or initial operation. You may also visit us on the web at www.elationlighting.com for any comments or suggestions. Service Hours are Monday through Friday 8:00 a.m. to 4:30 p.m. Pacific Standard Time.

Voice: (323) 582-3322

Fax: (323) 832-9142

E-mail: support@elationlighting.com

To purchase parts online visit <http://parts.elationlighting.com>

Warning! To prevent or reduce the risk of electrical shock or fire, do not expose this unit to rain or moisture.

Warning! *This may cause severe eye damage. Avoid looking directly into the light source at all times!*

TVL2000 II

General Instructions

To optimize the performance of this product, please read these operating instructions carefully to familiarize yourself with the basic operations of this unit. These instructions contain important safety information regarding the use and maintenance of this unit. Please keep this manual with the unit, for future reference.

TVL2000 II

Features

- 3 DMX Channel Modes; Two 2 Channel Modes & 3 Channel Mode
- 2 Operating Modes - Manual Mode & DMX Control
- Digital Display for Address and Function Setting
- Power Cord Daisy Chain

TVL2000 II

Warranty Registration

The TVL2000 II carries a 2 year (730 days) limited warranty. Please fill out the enclosed warranty card to validate your purchase and warranty. You may also register your product online at www.elationlighting.com. All returned service items whether under warranty or not, must be freight pre-paid and accompany a return authorization (R.A.) number. If the unit is under warranty you must provide a copy of your proof of purchase invoice. Please contact Elation® customer support for a R.A. number.

TVL2000 II

Handling Precautions

Caution! There are no user serviceable parts inside this unit. Do not attempt any repairs yourself, doing so will void your manufacturer's warranty. In the unlikely event your unit may require service please contact Elation Professionals®.

During operation the housing may become hot. Avoid touching the unit with bare hands while in use.

Elation Professionals® will not accept any liability for any resulting damages caused by the non-observance of this manual or any unauthorized modification to this unit.

TVL2000 II

Safety Precautions

For Your Own Personal Safety, Please Read and Understand This Manual Completely Before You Attempt To Install Or Operate This Unit!

- To reduce the risk of electrical shock or fire, do not expose this unit rain or moisture
- Do not spill water or other liquids into or on to your unit.
- Be sure that the local power outlet match that of the required voltage for your unit.
- Do not attempt to operate this unit if the power cord has been frayed or broken.
- Do not attempt to remove or break off the ground prong from the electrical cord. This prong is used to reduce the risk of electrical shock and fire in case of an internal short.
- Disconnect from main power before making any type of connection.
- Do not remove the cover under any conditions. There are no user serviceable parts inside.
- Never operate this unit when it's cover is removed.
- Always be sure to mount this unit in an area that will allow proper ventilation. Allow about 6" (15cm) between this device and a wall.
- Do not attempt to operate this unit, if it becomes damaged.
- This unit is intended for indoor use only, use of this product outdoors voids all warranties.
- Always mount this unit in safe and stable matter.
- Power-supply cords should be routed so that they are not likely to be walked on or pinched by items placed upon or against them, paying particular attention to cords at plugs, convenience receptacles, and the point where they exit from the appliance.
- Cleaning -The fixture should be cleaned only as recommended by the manufacturer. See page 15 for cleaning details.
- Heat -This fixture should be situated away from heat sources such as radiators, heat registers, stoves, or other appliances (including amplifiers) that produce heat.
- The fixture should be serviced by qualified service personnel when:
 - A. Objects have fallen, or liquid has been spilled into the appliance.
 - B. The appliance has been exposed to rain or water.
 - C. The appliance does not appear to operate normally or exhibits a marked change in performance.

Power Supply: The Elation Professionals® TVL2000 II contains an electronic ballast, which will auto sense the voltage when it is plugged into the power source. With the electronic ballast you do not need to worry about wall voltage, this unit can be plugged in anywhere. Also be sure to only use the included I.E.C. power cable supplied with the unit.

DMX-512: DMX is short for Digital Multiplex. This is a universal protocol used by most lighting and controller manufactures as a form of communication between intelligent fixtures and controllers. A DMX controller sends DMX data instructions from the controller to the fixture. DMX data is sent as serial data that travels from fixture to fixture via the DATA “IN” and DATA “OUT” XLR terminals located on all DMX fixtures (most controllers only have a DATA “OUT” terminal).

DMX Linking: DMX is a language allowing all makes and models of different manufactures to be linked together and operate from a single controller, as long as all fixtures and the controller are DMX compliant. To ensure proper DMX data transmission, when using several DMX fixtures try to use the shortest cable path possible. The order in which fixtures are connected in a DMX line does not influence the DMX addressing. For example; a fixture assigned a DMX address of 1 may be placed anywhere in a DMX line, at the beginning, at the end, or anywhere in the middle. When a fixture is assigned a DMX address of 1, the DMX controller knows to send DATA assigned to address 1 to that unit, no matter where it is located in the DMX chain.

Data Cable (DMX Cable) Requirements (For DMX and Master/Slave Operation): The TVL2000 II 3 DMX channel modes. The DMX address is set electronically using the controls on the side of the unit. Your unit and your DMX controller require a approved DMX-512 110 Ohm Data cable for data input and data output. We recommend Accu-Cable DMX cables. If you are making your own cables, be sure to use standard 110-120 Ohm shielded cable (This cable may be purchased at almost all professional sound and lighting stores). Your cables should be made with a male and female XLR connector on either end of the cable. Also remember that DMX cable must be daisy chained and cannot be split.



Figure 1

Notice: Be sure to follow figures two and three when making your own cables. Do not use the ground lug on the XLR connector. Do not connect the cable’s shield conductor to the ground lug or allow the shield conductor to come in contact with the XLR’s outer casing. Grounding the shield could cause a short circuit and erratic behavior.

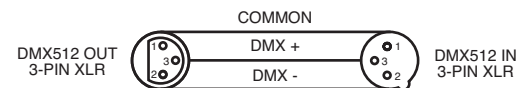

Figure 2

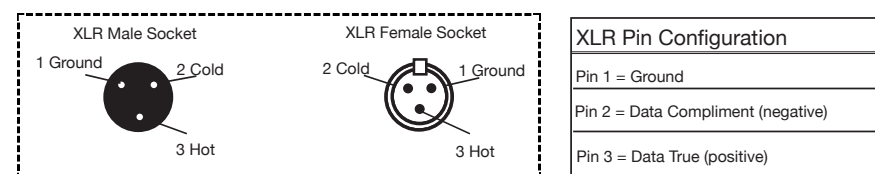

Figure 3

Special Note: Line Termination. When longer runs of cable are used, you may need to use a terminator on the last unit to avoid erratic behavior. A terminator is a 90-120 ohm 1/4 watt resistor which is connected between pins 2 and 3 of a male XLR connector (DATA + and DATA -). This unit is inserted in the female XLR connector of the last unit in your daisy chain to terminate the line. Using a cable terminator (ADJ part number Z-DMX/T) will decrease the possibilities of erratic behavior.



Termination reduces signal errors and avoids signal transmission problems and interference. It is always advisable to connect a DMX terminal, (Resistance 120 Ohm 1/4 W) between PIN 2 (DMX-) and PIN 3 (DMX +) of the last fixture.

Figure 4

5-Pin XLR DMX Connectors. Some manufactures use 5-pin XLR connectors for DATA transmission in place of 3-pin. 5-pin XLR fixtures may be implemented in a 3-pin XLR DMX line. When inserting standard 5-pin XLR connectors in to a 3-pin line a cable adaptor must be used, these adaptors are readily available at most electric stores. The chart below details a proper cable conversion.

3-Pin XLR to 5-Pin XLR Conversion		
Conductor	3-Pin XLR Female (Out)	5-Pin XLR Male (In)
Ground/Shield	Pin 1	Pin 1
Data Compliment (- signal)	Pin 2	Pin 2
Data True (+ signal)	Pin 3	Pin 3
Not Used		Pin 4 - Do Not Use
Not Used		Pin 5 - Do Not Use

The unit should be mounted using a mounting clamp (not provided), affixing it to the mounting bracket that is provided with the unit. Always ensure that the unit is firmly fixed to avoid vibration and slipping while operating. Always ensure that the structure to which you are attaching the unit is secure and is able to support a weight of 10 times the unit's weight. Also, always use a safety cable that can hold 12 times the weight of the unit when installing the fixture. The equipment must be installed by a professional, and it must be installed in a place where it is out of the reach of people's grasp.

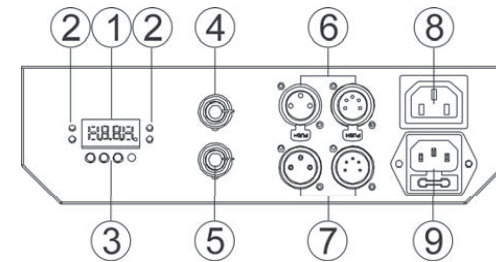

1 Display: Shows the various menus and the selected functions

2 Indicator LED:

DMX	On	DMX input present
MASTER	On	Master Mode
SLAVE	On	Slave Mode
COLOR TEMP.	On	Max. power consumption of CW/WW

3 Button:

MENU	To select the programming functions
DOWN	To go backward in the selected functions
UP	To go forward in the selected functions
ENTER	To confirm the selected functions

4 Color Temperature Adjustment: Adjust the color temperature from 3200k to 6500k, 25K as a step. When the value is between 4825K and 4875K the green LED indicator will light. It means the power consumption of CW/WW color has reached the maximum.

5 Dimmer Adjust knob: Adjust the intensity of the unit.

6 DMX output: For DMX512 link, use 3/5-pin XLR plug cable to link the next unit.

7 DMX input: For DMX512 link, use 3/5-pin XLR plug cable to input DMX signal

8 Mains output: Connect to supply main power for the next unit.

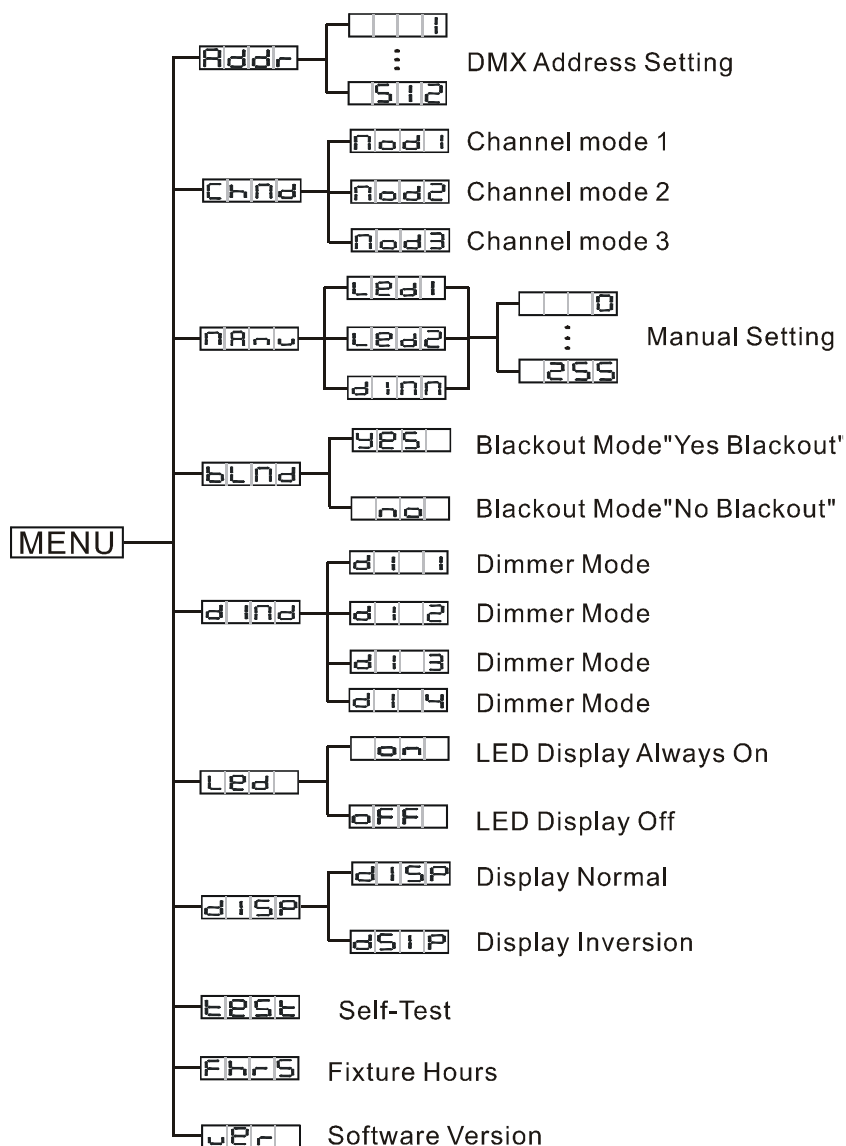

System Menu. The TVL2000 II comes with an easy to navigate system menu. This next section will detail the functions of each command in the system menu. **Please read the next section thoroughly!**

To access the main menu press the MENU button. Tap the UP or DOWN buttons until you reach function you wish to change. When you reach the function you wish to change press the ENTER button. When a function is selected use the UP or DOWN buttons to change the function settings. Once your changes are made press the ENTER button, and then press and hold the MENU button for at least three seconds to confirm and lock the change into the system memory. If the MENU button is not pressed and held within eight seconds the fixture will automatically confirm and lock the change into the system memory. To exit without making any changes press the MENU button.

ADDR - DMX Address Setting.

1. First set the unit to your desired DMX Channel mode.
2. To set your address, tap either the MENU, UP, or DOWN buttons until "ADDR" is displayed, press ENTER. "1" will now be displayed and flashing.
3. Press the UP or DOWN buttons to find your desired address. When you have found your desired DMX address press ENTER, and connect your DMX Controller.

CHND - Switch between the 3 DMX Channel Modes.

1. Press the MENU button until "CHND" is displayed, press ENTER. Either "MOD 1" (2 Channel Mode), "MOD 2" (2 Channel Mode), or "MOD 3" (3 Channel Mode) will be displayed
2. Press the UP or DOWN buttons to choose your desired DMX mode and press ENTER to confirm and exit.

MANU - Manually adjust the intensity of the LEDs.

1. Press the MENU button until "MANU" is displayed, press ENTER. "LED1", "LED2" or "DIMM" will be displayed. LED 1 is warm white, LED 2 is cool white, and DIMM is the master dimmer for this mode.

2. Use the UP or DOWN buttons to scroll to the color you would like adjust first, and press ENTER.
3. Use the UP or DOWN buttons to adjust the intensity of the chosen color, and press ENTER after the adjustment.
4. Continue to make adjustments to the two colors until your desired color is reached. Once your desired color is reached do not leave this mode.
5. To leave this mode, press the MENU button. Once you leave this mode, all settings will be reset.

BLND - Blackout or Stand by mode.

1. Press the MENU button until "BLND" is displayed, press ENTER. Either Yes or No will be displayed.
2. To activate Blackout press the UP or DOWN buttons until Yes is displayed, press ENTER to confirm and exit. The fixture will now be in Blackout mode. To deactivate Blackout mode, select No and press Enter.

DLND - Dimmer Modes.

1. Press the MENU button until "DLND" is displayed, press ENTER.
2. The display will show either "DI 1", "DI 2", "DI 3", "DI 4". (see Dimmer Mode diagrams below) To activate a Dimmer Mode, press the UP or DOWN buttons to select Dimmer Mode "DI 1", "DI 2", "DI 3", or "DI 4", then press ENTER to confirm.
3. Press MENU to exit and reset the Dimmer Mode setting.

Dimmer Modes

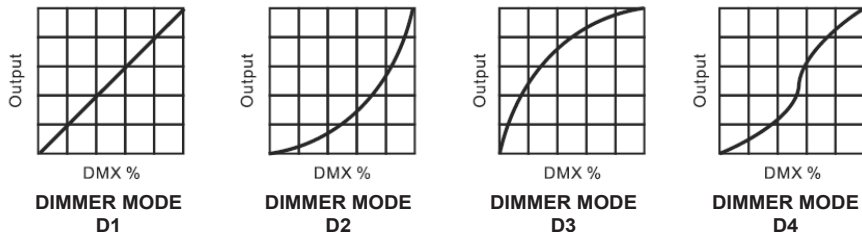

LED - Turn off the LED display after 20 seconds.

1. Press the MENU button until "LED" is displayed, press ENTER.
2. The display will show either "ON" or "OFF". Press the UP or DOWN buttons to select "ON" to keep the LED display On at all times, or "OFF" so that the LED display turns off after 20 seconds.
3. Press ENTER to confirm.

DISP - Reverse the display 180°.

1. Press the MENU button until "DISP" is displayed, press ENTER.
2. Press the UP button to select "DISP" to activate this function, or "DISP" to deactivate this function.
3. Press ENTER to confirm.

TEST - Run a self test program.

1. Tap the MENU button until "TEST" is displayed, press ENTER.
2. The fixture will now run a self test program. To stop the self test press either the MENU or ENTER button.

FHRS - Display the running time of the unit.

1. Press the MENU button until "FHRS" is displayed, press ENTER.
2. The display shows the running time of the unit. Press MENU to exit.

VER - Display Software version of the unit.

1. Press the MENU button until "VER" is displayed, press ENTER.
2. The display will show the software version.

TVL2000 II

Universal DMX Control

Universal DMX Control: This function allows you to use a Elation® universal DMX-512 controller to create unique programs tailored to your individual needs.

1. The TVL2000 II has three DMX channel modes. To set the channel mode see page 10. See page 14 for the DMX modes & traits.
2. To control your fixture in DMX mode, follow the set-up procedures on pages 5-7 as well as the set-up specifications that are included with your DMX controller.
3. Use the controller's faders to control the various DMX fixture traits.
4. This will allow you to create your own programs.
5. Follow the instructions on page 10 to set the DMX address.
6. For longer cable runs (more than a 100 feet) use a terminator on the last fixture.
7. For help operating in DMX mode consult the manual included with your DMX controller.

Manual Mode: This mode allows the user to adjust the color intensity to create their own desired color temperature.

1. Press the MENU button until "MENU" is displayed, and press ENTER.
2. Follow the instructions on pages 10-11 to operate this mode.
3. You can also use the Color Adjust Knob and Dimmer Knob to manually create your desired color temperature. Please see the Control Panel on page 8.

TVL2000 II

Power Cord Daisy Chain

With this feature you can connect the fixtures to one another using the IEC input and output sockets. The quantity that can be connected is 4 fixtures maximum. After 4 fixtures you will need to use a new power outlet. They must be the same fixtures. DO NOT mix fixtures.

TVL2000 II

DMX Modes

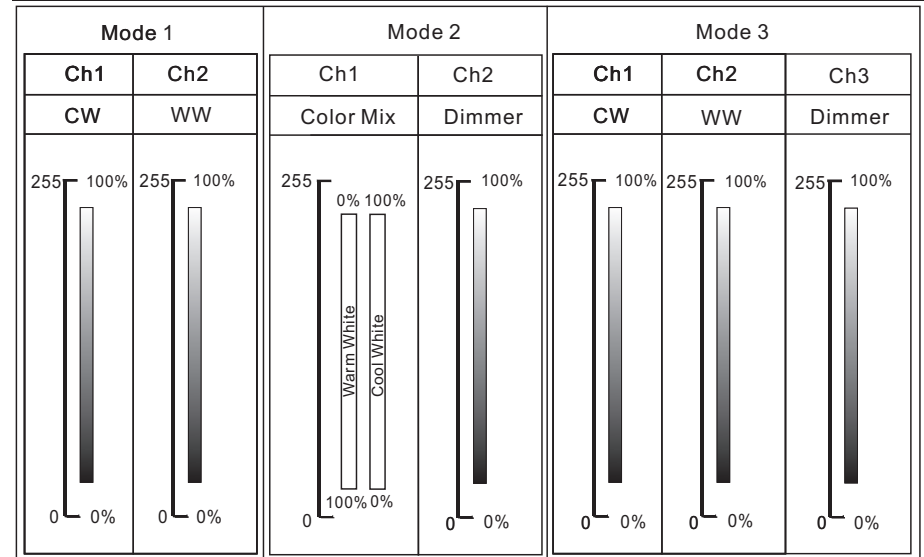

TVL2000 II

Photometric Chart

WARM WHITE (3200K)	237 FC / 2550 LUX	70 FC / 750 LUX	30 FC / 320 LUX	19 FC / 200 LUX	12 FC / 130 LUX
COOL WHITE (6500K)	418 FC / 4500 LUX	121 FC / 1300 LUX	52 FC / 560 LUX	31 FC / 330 LUX	20 FC / 214 LUX
FULL ON (4500-5000K)	660 FC / 7100 LUX	186 FC / 2000 LUX	80 FC / 860 LUX	47 FC / 510 LUX	31 FC / 330 LUX

LUX x 0.0929 = FC

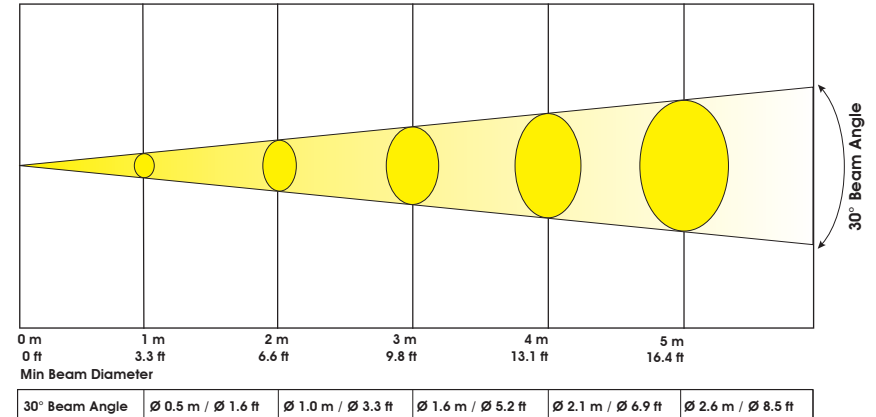

First unplug the power. Locate and remove the unit's power cord. Once the cord has been removed locate the fuse holder located inside the power socket. Insert a flat-head screw driver into the power socket and gently pry out the fuse holder. Remove the bad fuse and replace with a new one. The fuse holder has a built-in socket for a spare fuse be sure not to confuse the spare fuse with active fuse.

Fixture Cleaning: Due to fog residue, smoke, and dust cleaning the internal and external optical lenses and mirror should be carried out periodically to optimize light output. Cleaning frequency depends on the environment in which the fixture operates (i.e. smoke, fog residue, dust, dew). In heavy club use we recommend cleaning on a monthly basis. Periodic cleaning will ensure longevity, and crisp output.

1. Use normal glass cleaner and a soft cloth to wipe down the outside casing.
2. Use a brush to wipe down the cooling vents and fan grill.
3. Clean the external optics and mirror with glass cleaner and a soft cloth every 20 days.
4. Clean the internal optics with glass cleaner and a soft cloth every 30-60 days.
5. Always be sure to dry all parts completely before plugging the unit back in.

Trouble Shooting: Listed below are a few common problems that you may encounter, with solutions.

No light output from the unit;

1. Be sure the external fuse has not blown. The fuse is located on the rear panel of the unit.
2. Be sure the fuse holder is completely and properly seated.

2-YEAR LIMITED WARRANTY

A. Elation® Architectural hereby warrants, to the original purchaser, Elation® Professionals® products to be free of manufacturing defects in material and workmanship for a period of two years (730 days) from the date of purchase. This warranty shall be valid only if the product is purchased within the United States of America, including possessions and territories. It is the owner's responsibility to establish the date and place of purchase by acceptable evidence, at the time service is sought.

B. For warranty service, send the product only to the Elation® Professionals® factory. All shipping charges must be pre-paid. If the requested repairs or service (including parts replacement) are within the terms of this warranty, Elation® Professionals® will pay return shipping charges only to a designated point within the United States. If the entire instrument is sent, it must be shipped in its original package. No accessories should be shipped with the product. If any accessories are shipped with the product, Elation® Professionals® shall have no liability whatsoever for loss of or damage to any such accessories, nor for the safe return thereof.

C. This warranty is void if the serial number has been altered or removed; if the product is modified in any manner which Elation® Professionals® concludes, after inspection, affects the reliability of the product; if the product has been repaired or serviced by anyone other than the Elation® Professionals® factory unless prior written authorization was issued to purchaser by Elation® Professionals®; if the product is damaged because not properly maintained as set forth in the instruction manual.

D. This is not a service contract, and this warranty does not include maintenance, cleaning or periodic check-up. During the period specified above, Elation® Professionals® will replace defective parts at its expense, and will absorb all expenses for warranty service and repair labor by reason of defects in material or workmanship. The sole responsibility of Elation® Professionals® under this warranty shall be limited to the repair of the product, or replacement thereof, including parts, at the sole discretion of Elation® Professionals®. All products covered by this warranty were manufactured after January 1, 1990, and bear identifying marks to that effect.

E. Elation® Professionals® reserves the right to make changes in design and/or improvements upon its products without any obligation to include these changes in any products theretofore manufactured.

F. No warranty, whether expressed or implied, is given or made with respect to any accessory supplied with products described above. Except to the extent prohibited by applicable law, all implied warranties made by Elation® Professionals® in connection with this product, including warranties of merchantability or fitness, are limited in duration to the warranty period set forth above. And no warranties, whether expressed or implied, including warranties of merchantability or fitness, shall apply to this product after said period has expired. The consumer's and or Dealer's sole remedy shall be such repair or replacement as is expressly provided above; and under no circumstances shall Elation® Professionals® be liable for any loss or damage, direct or consequential, arising out of the use of, or inability to use, this product.

G. This warranty is the only written warranty applicable to Elation® Professionals® Products and supersedes all prior warranties and written descriptions of warranty terms and conditions heretofore published.

©2014 **ELATION PROFESSIONAL** all rights reserved. Information, specifications, diagrams, images, and instructions herein are subject to change without notice. **ELATION PROFESSIONAL** logo and identifying product names and numbers herein are trademarks of **ELATION PROFESSIONAL**. Copyright protection claimed includes all forms and matters of copyrightable materials and information now allowed by statutory or judicial law or hereinafter granted. Product names used in this document may be trademarks or registered trademarks of their respective companies and are hereby acknowledged. All non-ELATION brands and product names are trademarks or registered trademarks of their respective companies.

ELATION PROFESSIONAL and all affiliated companies hereby disclaim any and all liabilities for property, equipment, building, and electrical damages, injuries to any persons, and direct or indirect economic loss associated with the use or reliance of any information contained within this document, and/or as a result of the improper, unsafe, insufficient and negligent assembly, installation, rigging, and operation of this product.

ORDER CODE	ITEM
TRIGGER CLAMP	Heavy Duty Wrap Around Hook Clamp
TVL2B180	180° Dual Yoke / Bracket
LSF536	Light Shaping Filter 30° 20" x 24" Sheet
LSF537	Light Shaping Filter 20° 20" x 22" Sheet
LSF538	Light Shaping Filter 60° x 1° 20" x 24" Sheet
LSF559	Light Shaping Filter 10° 20" x 24" Sheet
ECCOM-10	Power Link Cables
AC3PDMX10PRO	10 ft. (3m) 3pin PRO DMX Cable
AC3PDMX25PRO	25 ft. (7.5m) 3pin PRO DMX Cable
AC3PDMX50PRO	50 ft. (15.2m) 3pin PRO DMX Cable
AC5PDMX10PRO	10 ft. (3m) 5pin PRO DMX Cable
AC5PDMX25PRO	25 ft. (7.5m) 5pin PRO DMX Cable
AC5PDMX50PRO	50 ft. (15.2m) 5pin PRO DMX Cable

Model:	TVL2000 II
Voltage:	100 - 240V~50/60Hz
LEDs:	900 LEDs (450 Cool White & 450 Warm White)
Power Consumption:	90W
Fuse:	7A
Power Cord Daisy Chain:	4 Fixtures Max.
Dimensions:	14.6"(L) x 13.3"(W) x 4.4"(H) 376mm x 337mm x 113mm
Weight:	15.0 Lbs. / 6.8 kgs.
Colors:	Cool White & Warm White
Duty Cycle:	None
DMX:	3 DMX Channel Modes: 2 Channel Mode, 2 Channel Mode, & 3 Channel Mode
Sound Active:	Yes
Working Position:	Any Safe, Secure Position
Warranty:	2 Year (730 days)

Please Note: Specifications and improvements in the design of this unit and this manual are subject to change without any prior written notice.

Auto Sensing Voltage: This fixture contains a electronic ballast, which will auto sense the voltage when it is plugged into the power source.

©Elation Professionals®
 A Division of the AmericanDJ® Group of Companies
 World Headquarters:
 6122 S. Eastern Ave. Los Angeles, CA 90040 USA
 Tel: 323-582-3322 Fax: 323-832-9142
 Web: www.elationlighting.com E-mail: info@elationlighting.com
 American DJ Europe
 Junostraat 2
 6468 EW Kerkrade
 Netherlands
service@adjgroup.eu / www.adj.eu
 Tel: +31 45 546 85 00 / Fax: +31 45 546 85 99