

# PROMATRIX

DIGITAL CONTROL

---

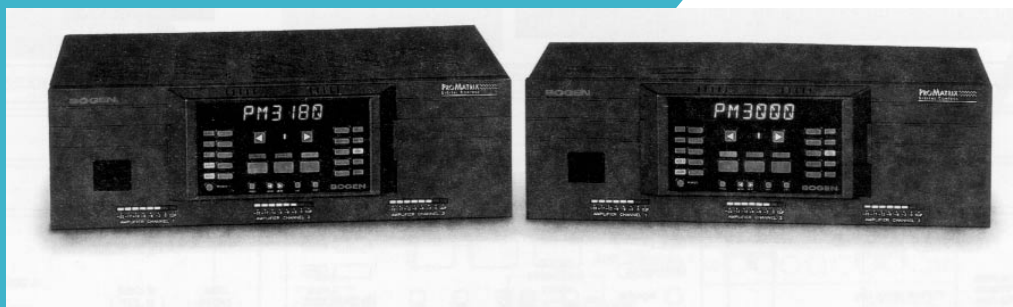

**User's guide**



# ADDENDUM TO BOGEN MODEL PM3180



**NOTE: Model PM3000  
has been discontinued.**

## SAFETY INFORMATION

**NOTICE:** Every effort was made to ensure that the information in this guide was complete and accurate at the time of printing. However, information is subject to change.

**WARNING:** To reduce the risk of Fire or Electric Shock, Do Not Expose this apparatus to rain or moisture. Apparatus shall not be exposed to dripping or splashing and no objects filled with liquids, such as vases shall be placed on the apparatus.

**WARNING:** Only connect unit to AC mains outlet providing protective earthing connection.

**NOTE:** Mains plug is used as disconnect device from the mains and shall remain readily accessible and operable.

**CAUTION:** These servicing instructions are for use by qualified service personnel only. To reduce the risk of electric shock, do not perform any servicing other than that contained in the operating instructions unless you are qualified to do so.

**CAUTION: DO NOT INSTALL OR PLACE THIS UNIT IN A BOOKCASE, BUILT-IN CABINET, OR IN ANOTHER CONFINED SPACE. ENSURE THE UNIT IS WELL VENTILATED. TO PREVENT THE RISK OF SHOCK OR FIRE HAZARD DUE TO OVER-HEATING, ENSURE THAT CURTAINS AND ANY OTHER MATERIALS DO NOT OBSTRUCT THE VENTILATION VENTS.**

Always follow these basic safety precautions when installing and using the unit:

### IMPORTANT SAFETY INSTRUCTIONS

1. Read these instructions.
2. Keep these instructions.
3. Heed all warnings.
4. Follow all instructions.
5. Do not use this apparatus near water.
6. Clean unit with dry cloth.
7. Do not block any ventilation openings. Install in accordance with the manufacturer's instructions.
8. Do not install near any heat sources such as radiators, heat registers, stoves, or other apparatus (including amplifiers) that produce heat.
9. Do not defeat the safety purpose of the polarized or grounding-type plug. A polarized plug has two blades with one wider than the other. A grounding-type plug has two blades and a third grounding prong. The wide blade, or the third prong, are provided for your safety. If the provided plug does not fit into your outlet, consult an electrician for replacement of the obsolete outlet.
10. Protect the power cord from being walked on or pinched particularly at plugs, convenience receptacles, and the point where they exit from the apparatus.
11. Only use attachments/accessories specified by the manufacturer.
12. Unplug this apparatus during lightning storms or when not used for long periods of time.
13. Refer all servicing to qualified service personnel. Servicing is required when the apparatus has been damaged in any way, such as power-supply cord or plug is damaged, liquid has been spilled or objects have fallen into the apparatus, the apparatus has been exposed to rain or moisture, does not operate normally, or has been dropped.

### CAUTION

RISK OF ELECTRIC  
SHOCK DO NOT OPEN



**CAUTION: TO PREVENT THE RISK OF ELECTRIC SHOCK, DO NOT REMOVE ANY FRONT/BACK COVERS OR PANELS. NO USER-SERVICEABLE PARTS INSIDE. REFER SERVICING TO QUALIFIED PERSONNEL.**

The lightning flash with arrowhead symbol, within an equilateral triangle, is intended to alert the user to the presence of uninsulated "dangerous voltage" within the product's enclosure that may be of sufficient magnitude to constitute a risk of electric shock to persons.



The exclamation point within an equilateral triangle is intended to alert the user to the presence of important operating and maintenance (servicing) instructions.

### WARNING

Batteries (battery pack or batteries installed) shall not be exposed to excessive heat such as sunshine, fire or the like.

**BOGEN®**  
COMMUNICATIONS, INC.

50 Spring Street, Ramsey, NJ 07446, USA  
Tel. 201-934-8500 • Fax: 201-934-9832  
[www.bogen.com](http://www.bogen.com)

Specifications subject to change without notice.  
© 2012 Bogen Communications, Inc.  
54-6710-10A 1206

# PROMATRIX

DIGITAL CONTROL

---

## Models PM-3000 & PM-3180

### User's Guide

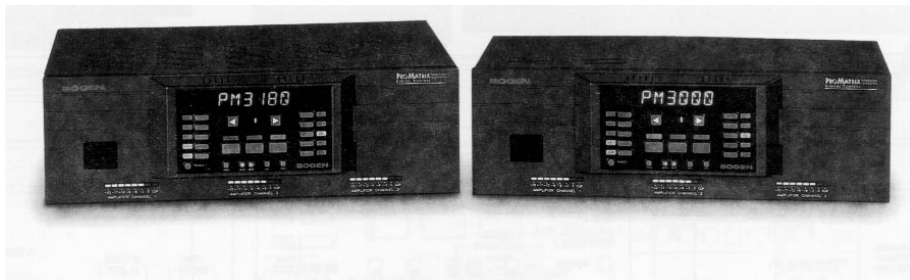

**BOGEN**®

Part No. 54-5003-02  
9707

© 1996 Bogen Communications, Inc.  
50 Spring St., Ramsey, NJ 07446

All rights are reserved. No part of this document may be photocopied, reproduced, or translated to another language without the prior written consent of Bogen Communications Inc.

**Notice:** The information contained in this document is subject to change without notice and should not be construed as a commitment by Bogen Communication, Inc.

**Bogen Communications Inc. assumes no responsibility for any errors that may appear in this document nor does it make expressed or implied warranty of any kind with regard to this material, including, but not limited to, the implied warranties of merchantability and fitness for a particular purpose.**

Bogen Communications Inc. shall not be liable for incidental or consequential damages in connection with, or arising out of the furnishing, performance, or use of this document and the equipment which is describes

Complete product warranty information is provided on a separate product registration card.

### **WARNING**

The Warning label calls attention to a procedure, practice, or the like, which, if not correctly performed or adhered to, could result in damage to the unit or **personal injury**. Do not proceed beyond a warning label until the indicated conditions are fully understood and met.

**Warning:** Changes or modifications to this unit not expressly approved by the party responsible for compliance could void the user's authority to operate the equipment..

**Note:** This equipment has been tested and found to comply with the limits for a Class A digital device, pursuant to Part 15 of the FCC Rules. These limits are designed to provide reasonable protection against harmful interference when the equipment is operated in a commercial environment. This equipment generates, uses, and can radiate radio frequency energy and, if not installed and used in accordance with the instruction manual, may cause harmful interference to radio communications. Operation of this equipment in a residential area is likely to cause harmful interference in which case the user will be required to correct the interference at his own expense.

*This Class A digital apparatus meets all requirements of the Canadian Interference-Causing Equipment Regulations*

*Cet appareil numérique de la classe A respecte toutes les exigences du Règlement sur le matériel brouilleur du Canada.*

Publication No. 54-5003-02  
July 1997  
Printed in Korea



## **Models PM-3000 & PM-3180**

---

### **User's Guide**

#### **Owner's Information**

Model Number \_\_\_\_\_

Serial Number \_\_\_\_\_

Date of Purchase \_\_\_\_\_

Place of Purchase \_\_\_\_\_

Address \_\_\_\_\_

\_\_\_\_\_

# Contents

---

<b>Unpacking</b> .....	1
Packing List .....	1
Accessories .....	1
Conventions .....	1
<b>Introduction</b> .....	2
Description .....	2
Features .....	3
<b>Quick Start</b> .....	4
Install Control Panel .....	4
Basic Wiring .....	5
Factory Programmed Configuration .....	6
Basic Operation .....	7
Aux Input Trim Adjustment .....	10
Important Operational Notes .....	10
<b>Rear Panel Model PM-3000</b> .....	11
<b>Rear Panel Model PM-3180</b> .....	12
<b>Front Panel</b> .....	13
<b>Infrared Remote Controller</b> .....	14
<b>Wiring Information</b> .....	15
Outputs for Model PM-3000 .....	15
Outputs for Model PM-3180 .....	16
Aux Inputs .....	17
Aux Input Trim Controls .....	17
Audio Process Link Wiring (PM-3180 Only) .....	17
Mic Inputs .....	18
<b>User Operation</b> .....	19
The ProMatrix Control Panel .....	19
<b>Programming</b> .....	22
Enter Program Mode .....	22
Programming Menu .....	23
Assignment .....	24
Mic Set Up .....	26
Presets .....	28
Volume Limit .....	30
Inhibit .....	32
Aux Mute .....	33
Amplifier Link (PM-3180 Only) .....	34
Password .....	35
Labels .....	36
Factory Defaults .....	37
<b>Testing &amp; Troubleshooting</b> .....	38
Testing .....	38
Troubleshooting .....	39
<b>Getting Help</b> .....	41
<b>Specifications</b> .....	42

# Unpacking

---

## Packing List

The ProMatrix carton contains the following components:

- 1 - ProMatrix unit
- 1 - Removable Control Panel\*
- 1 - Wireless Infrared Remote Controller
- 2 - AAA Batteries
- 1 - 25-foot Control Panel Cable
- 1 - AC Power Cord
- 2 - Wall Anchors
- 1 - User Manual
- 1 - Product Registration Card

\*The control panel must be connected to the amplifier chassis prior to operation. See page 4 to install control panel.

## Accessories

A front panel mount kit and rack mount kit are available for this product.

- The front panel mounting kit lets you customize installation by locating the control panel remotely from the amplifier chassis (up to 250 feet when in-wall wiring is used). Front Panel Mounting Kit Part No.: RMPWMK3
- The rack kit permits installation of the amplifier chassis in standard equipment racks. Rack Panel Kit Part No.: RPK79

## Conventions

This users guide covers the ProMatrix amplifier, model PM-3180 and the ProMatrix Preamplifier, model PM-3000. Each of these units incorporates three channels — amplifier channels in PM-3180 and preamplifier channels in PM-3000. This manual refers to the three channels as amp/channels to indicate that the instruction refers to either the three amplifier channels or three preamplifier channels.

# Introduction

## Description

The ProMatrix products are designed for sound reinforcement/distribution in multi-room applications. The PM-3180 consists of three independent amplifiers, rated at 20, 60 and 100 watts. The PM-3000 is a three channel pre-amplifier unit designed to offer the flexibility for applications with power requirements that exceed the limits of the PM-3180. Both units have a programmable interface that lets you selectively assign priority levels to inputs and custom configure features. As inputs become active or inactive they are automatically switched onto or off of the channel.

Four Aux inputs and two Mic inputs lets you connect to a wide variety of program sources. One of the Mic inputs can be set to accept input from a telephone paging interface. The PM-3180 has outputs for 4- and 8-ohm loads as well as 25V and 70V distributed systems, and includes provisions to connect external signal processing equipment. The PM-3000 provides both balanced and unbalanced line level output for each channel.

**Here is an application example for a typical restaurant/bar establishment using the PM-3180 amplifier:** The 20-watt amp channel plays to the entrance area/waiting room, the 60-watt amp channel to the dining area, and the 100-watt amp channel to the bar/lounge. The area served by each amp channel hears program material according to the priority level for the inputs assigned to the amp channel. This example is illustrated below:

Amplifier Channel		Amp 1 (100W)	Amp 2 (60W)	Amp 3 (20W)
Area Served		Lounge	Dining Area	Waiting Room
<b>PM-3180 Input</b>	<b>Audio Source</b>	<b>Assigned Input Priorities</b>		
Aux A	Juke Box	3	—	—
Aux B	CD Player	4	2	3
Aux C	Radio	5	3	4
Aux D	TV Feed	6	—	—
Mic A	Emerg. Mic	1	1	1
Mic B	Page Mic	2	—	2

1 = Highest Priority, 6 = Lowest Priority, — = Input not assigned to amp.

The lounge audio sources and microphones are prioritized as shown, with the Mics having the highest priorities and the music source with descending priorities. The dining area has completely different audio needs where certain audio sources (like the paging mic and juke box) are inhibited from use in that area while the CD and radio are permitted to play. Likewise for the waiting area where the inputs are assigned and prioritized for that area.



# Introduction

---

## Features

### **The ProMatrix units have the following features:**

- 2 Lo-Z balanced Mic inputs (Mic A is female XLR, Mic B is screw terminals). Mic B can be configured as a 600-Ohm transformer balanced input for telephone paging applications.
- Automatic level control for Mic inputs.
- Choice of microphone precedence activation (VOX, Normally Open, Normally Closed).
- Phantom power for use with condenser microphones.
- 4 Aux inputs (RCA unbalanced).
- Aux Input trim controls to adjust for differing audio source input levels.
- Automatic switching of inputs based on input activity.
- Flexible priority assignments for each input on each amplifier channel
- Fade-in of audio source after Mic page or when switching to a lower priority input.
- Adjustable paging over music level.
- Wireless infrared remote control unit with the same functions as the control panel.
- Front-mounted, removable control panel with soft-touch buttons to:
  - select a channel
  - provide manual override selection of input source
  - control volume, treble and bass.
  - program unit functions
- Preset power-up volume level of each input for each channel.
- Password protected programming mode.
- Preset bass and treble response of each input on each channel (the same input can have different EQ settings on different channels).
- Preset maximum volume level the user can achieve.
- Lock out or inhibit volume bass and treble controls for each channel.
- Non-volatile memory to retain user control settings.
- Change the access code.
- Create custom display names for input sources.
- Front panel mounted LED output level meters for each amp channel.
- Reset to factory default values.

### **The PM-3000 includes:**

- Balanced & unbalanced Line Level outputs for each channel
- Ground lift switch

### **The PM-3180 has these additional features**

- Independent 20, 60 & 100 watt amplifiers in one package.
- 4, 8 $\Omega$ , 25V & 70V outputs on each amp.
- Thermostatically-controlled cooling fan.
- Audio process links permit installation of signal processing equipment.

# Quick Start

This Quick Start section is intended to assist you in getting the ProMatrix unit up and running quickly so that you can become familiar with it.

**Important:** Do not place any objects directly on top of the unit. Leave at least 2 inches of space above the unit to assure proper ventilation. When locating the PM-3180, be sure to leave at least 2 inches of space on the right side of the unit to allow for fan exhaust.

## Install Control Panel

The unit is shipped with the control panel disassembled from the chassis. You have the option of attaching the control panel to the front panel or mounting it in a convenient location and connecting it to the unit using the 25-foot telephone cable included. For longer cable runs, use accessory RMPWMK3 for secure and attractive mounting of the front panel up to 250 feet from the main unit.

**Warning:** Use only the telephone cable supplied. Use of any other cable may damage the unit.

To attach the control panel to the chassis, position the panel as shown. Line up the tabs on the control panel with the slots on the chassis. Push in on the grooved areas on each side of the plastic panel and push the control panel onto the chassis to engage the locking tabs.

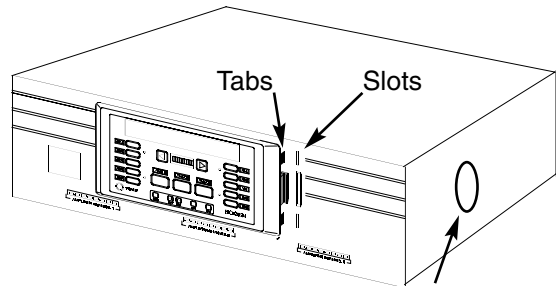

### To mount the control panel in a remote location:

1. Install two wall anchors 4-inches apart and level in the desired location. The screws should protrude 1/2".
2. BE SURE THAT POWER IS OFF WHEN YOU INSTALL OR REMOVE THE CONTROL PANEL. Plug one end of the 25-foot remote cable into the jack on the bottom right corner of the control panel. Plug the other end into the jack labeled REMOTE on the rear panel of the ProMatrix unit.
3. Place the control panel keyhole slots over the protruding screw heads and pull down slightly to secure the panel.

**Note:** The panel must be oriented vertically to ensure proper cooling of the internal electronic components.

# Quick Start

## Basic Wiring

1. Temporarily set the AUX INPUT TRIM controls on the rear panel to their full counterclockwise position. Trims will be adjusted later.

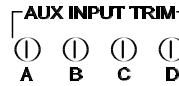

2. Be sure that the voltage select switch is set correctly. Connect the power cord to the AC LINE INPUT

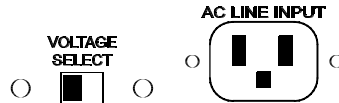

3. Connect outputs.  
**For the PM-3000**, connect the correct style output (balanced or unbalanced) to the input of the external amp or other signal processing equipment. Refer to page 15 for wiring balanced or unbalanced outputs.

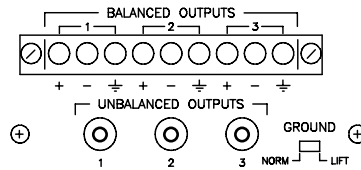

**For the PM-3180**, connect loads between COM and the desired output tap (8Ω, 25V or 70V). If connecting a 4-ohm load, refer to the Wiring Information section on page 16 for information on the 4Ω link.

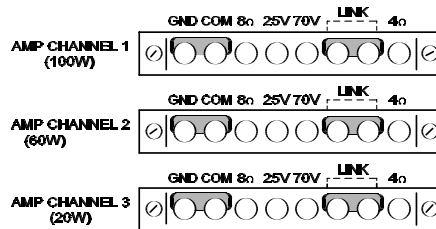

4. Connect unbalanced music input sources. The lines from the sources to the amplifier should be terminated with RCA-type plugs.

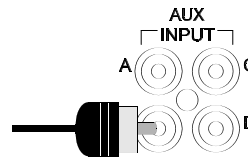

5. Connect balanced, low-impedance microphones. For the 3-pin Mic A connector, pin 1 is ground (shield).
6. Plug the ProMatrix into a properly grounded wall outlet.

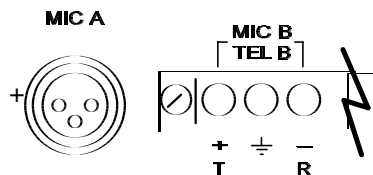

# Quick Start

---

## Factory Programmed Configuration

When the ProMatrix unit is first powered up, the factory default settings are loaded.

The factory default priority table is listed below. If you want to change any of these priority levels, you will have to use the ASSIGNMENT function in the programming mode. See the Programming section of these instructions (Page 22) to set priority levels.

<b>Input</b>	<b>Priority Level</b>	
MIC A	1	
MIC B	2	
AUX A	3	
AUX B	4	<b>(1 = highest, 6 = lowest)</b>
AUX C	5	
AUX D	6	

The microphone input settings are listed below:

<b>Microphone</b>	<b>Feature</b>	<b>Default</b>	<b>Options</b>
<b>MIC 1</b>	Precedence	VOX	N.O., N.C., VOX
	ALC	ON	ON, OFF
	Phantom	ON	OFF, ON
<b>MIC 2</b>	Precedence	VOX	N.O., N.C., VOX
	ALC	ON	ON, OFF
	MIC/TEL	MIC	MIC, TEL
	Phantom	ON	OFF, ON

See the Programming section of these instructions (starts on page 22) if you want to configure the microphones for other than the default values.

# Quick Start

## Basic Operation

This section will show you how to:

- Apply power to the unit
- Understand the Control Panel (See page 12 for full description)
- Select which channel the control panel affects
- Change volume
- Change Bass and Treble response
- Manually select an input or allow priority-based switching
- Adjust Aux Input Trim Controls

## To Apply Power to the Unit

**Important Note: For PM-3000, make sure any power amplifiers connected to the unit are off when the unit is first plugged in.**

Connect the AC supply cord to the unit and plug it into an outlet (the unit will turn on and display the software part number for 2 seconds and then the unit will shut down). To apply power, press the button labeled POWER on the control panel or on the wireless infrared remote controller.

## Understanding the Control Panel

The ProMatrix unit consists of 3 channels but only one control panel. Therefore, you must select the channel that the panel will effect. Once the unit is powered, a number of indicators will light and the alphanumeric panel will display status information.

The illuminated AMP 1 indicator means that it is the “current”

amp/channel — the one that the front panel controls will now effect. AUX A is the current active input and VOL is the current active control function. AUTO indicates that the inputs will auto switch. The pointer LED segment (between the large arrow keys) shows the approximate volume level.

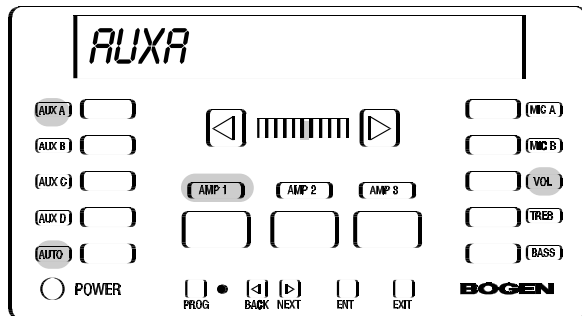

## To Select an Amp or Preamp Channel

To make another amp/channel current (under effect by the control panel), press the desired button (AMP 2, AMP 3); its indicator will illuminate.

Once selected, the user can adjust the VOL, BASS or TREB control for the selected amp/channel.

# Quick Start

## To Control Volume

**Note:** Changing any of the volume, bass or treble levels will effect all inputs associated with that amp/channel channel. Turning up the volume for the current amp/channel will cause other inputs assigned to that amp/channel to play louder when they become active. Likewise for bass and treble.

Be sure VOL is the current control (this is the normal default function). If BASS or TREB are lit, press the VOL button. Its indicator will light brightly and the volume level is displayed on the LED pointer.



Press the arrow buttons on either side of the pointer (left to decrease, right to increase).

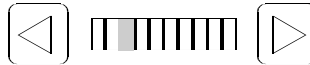

The display shows *RI* (the active amp/channel), *VOL*, and a 2-digit volume level number (00-25). The number (and pointer) changes in response to the arrow buttons.



After 5 seconds of no adjustment, the control panel display will again show the current input (VOL remains the current control and can be adjusted at any time simply by pressing an arrow key).

## To Control Bass or Treble.

Select the desired function by pressing the BASS or TREB button – its indicator lights.



The display shows *BASS* (or *TREB*), the current active amp/channel (*RI*) and a 1-digit level number (-7 to +7). The pointer shows the approximate level.

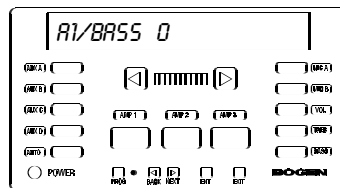

Press the arrow buttons on either side of the pointer. The number on the display changes in response to the arrow buttons.



After 5 seconds of no adjustment, the amplifier display will again show the current input and VOL will again become the current function.

# Quick Start

---

## To Select a Specific Input

The ProMatrix unit is normally set to monitor input activity and, based on the default or installer-created priority table, automatically switches the proper input for each amp/channel. You can override the priority switching feature of any amp/channel to select a specific input to be on continuously.

1. Press the AUTO button. Its indicator LED will flash, and the alphanumeric display will show *SEL INPUT*.
2. Press the desired input selector button (MIC A/B, AUX A/B/C/D). The selected input will appear on the display and its indicator will flash (50% on/50% off) in sync with the AUTO indicator.

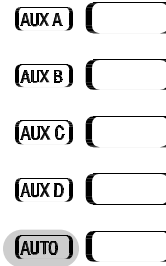

**Note:** If a different amp/channel is selected, the AUTO LED will flicker (90% on/10% off) to indicate that one or more of the other amp/channels is under manual control.

## To identify which amplifier is under manual control

Press each AMP button until the AUTO indicator and input indicator (AUX A, B, etc.) flash together.

## To Return to Auto Switching

Find the amp/channel that is under manual control.

Press the AUTO button once. The current input (based on priority) will appear on the display. Its indicator will light steady as will the AUTO indicator (unless another channel is in manual mode, in which case the indicator will flicker). This sets only the current amp/channel into the auto-switch mode. Any other amp/channels that have manually selected inputs will need to be returned to auto-switch mode using the same procedure described above.

**Note:** The amp/channel must be in AUTO mode before another manual input can be selected.

# Quick Start

---

## Aux Input Trim Adjustment

By adjusting the Trim controls as follows, inputs with different signal levels are set approximately equal within the ProMatrix unit.

**Important:** You must properly set the Aux Input Trim Controls. Improperly adjusted trims can result in high distortion levels, poor volume balance between different inputs or false triggering of inputs.

To adjust trims, follow the procedure below:

1. Make sure the various input sources are attached and operating at their normal output levels.
2. Select Amp 3 as the current amp/channel.
3. Press the AUTO button and manually select one of the Aux inputs (Start with Aux A).
4. Raise the volume of Amp 3/Aux A to 25 (this can be done without a load, if desired).
5. Rotate the Aux A Input Trim control while watching the Amp 3 output level meter. Adjust the trim control so that the red LED is briefly flashing **only** on loud music peaks.
6. Repeat steps 3, 4, and 5 for the other Aux inputs. Since the inputs are common to all three amplifier channels, the trims only need be set for one of the amp channels.
7. For PM-3000, you must also set each of the external amplifiers volume controls for the maximum sound level desired while the PM-3000 volume is set to 25.

## Important Operational Notes

- Phantom power is turned on from the factory. To turn it off, see the Programming Section, starting on page 22.
- When a microphone becomes active (through Vox or contact closure), the current Aux input will be muted to a preset level. No Aux input switching is allowed when the Aux mute is active.



# Rear Panel Model PM-3000

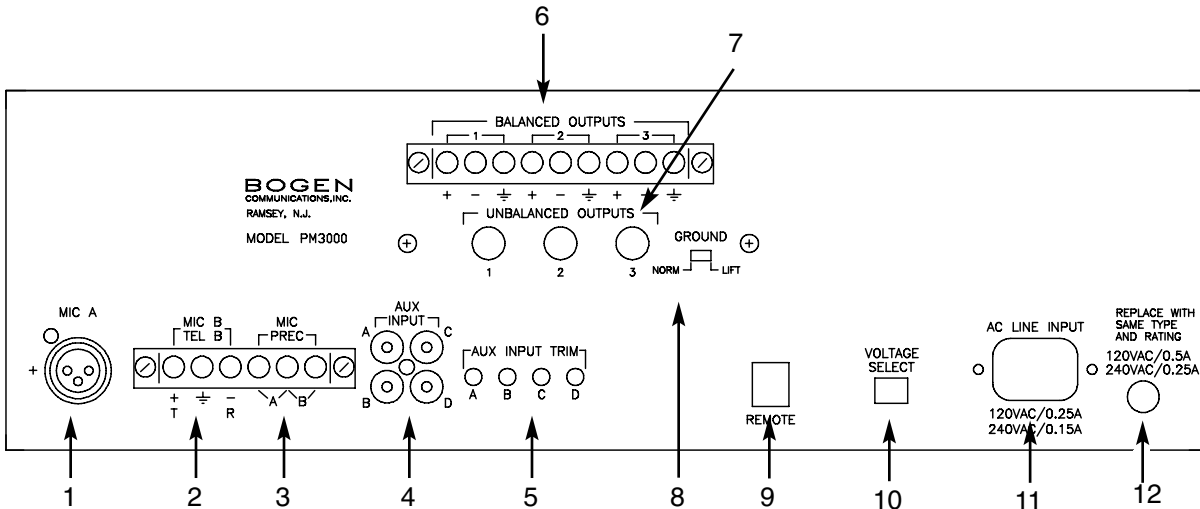

1. MIC A — Female XLR-type connector for balanced, LO-Z microphone input. Pin 1 is Gnd.
2. MIC B/TEL B — Screw terminal Input for Lo-Z balanced microphone. Software configurable as a 600Ω transformer coupled paging interface.
3. MIC PREC — Microphone precedence terminals for contact closure activation.
4. AUX INPUT — Unbalanced input jacks (RCA type) for program sources.
5. AUX INPUT TRIM — Variable attenuators for adjusting input source levels.
6. BALANCED OUTPUTS — Balanced Preamp output screw terminals for each channel.
7. UNBALANCED OUTPUTS — Unbalanced preamp output RCA jacks.
8. GROUND LIFT — Disconnects output grounds from chassis ground.
9. REMOTE — Jack for use when mounting amplifier front control panel in a remote location.
10. VOLTAGE SELECT — Voltage Selector switch.
11. AC LINE INPUT — Power cord socket.
12. Fuse — 120VAC/0.5A, 240VAC/0.25A

# Rear Panel Model PM-3180

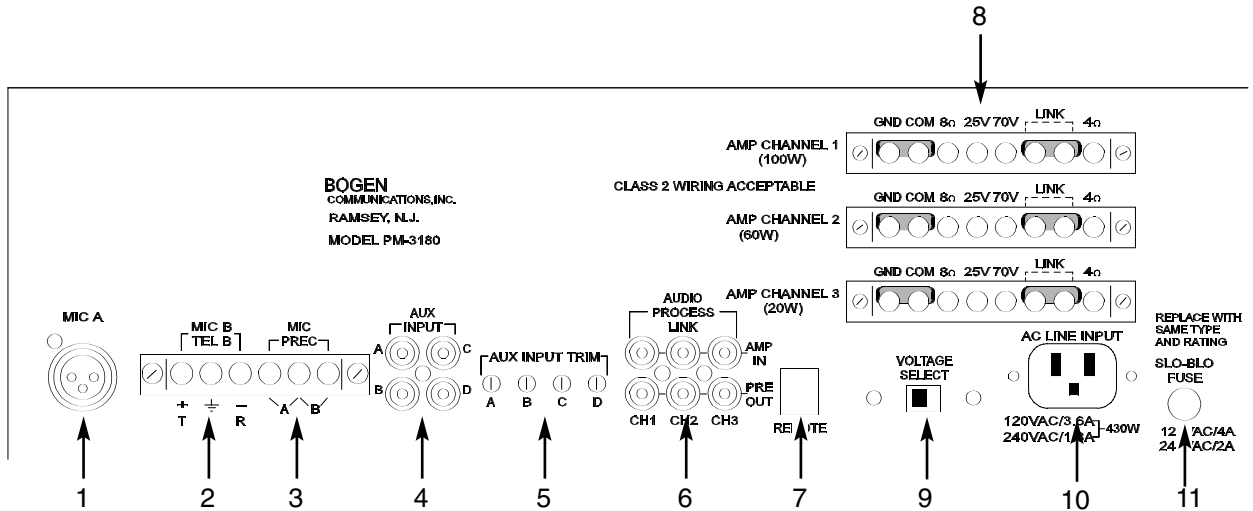

1. MIC A — XLR-type connector for balanced, LO-Z microphone input. Pin 1 is Gnd.
2. MIC B/TEL B — Input for Lo-Z balanced microphone. Software configurable as a 600Ω transformer coupled paging interface.
3. MIC PREC — Microphone precedence terminals for contact closure activation.
4. AUX INPUT — Unbalanced input jacks (RCA type) for program sources.
5. AUX INPUT TRIM — Variable attenuators for adjusting input source levels.
6. AUDIO PROCESS LINKS — Permits the connection of external signal processing equipment.
7. REMOTE — Jack for use when mounting amplifier front control panel in a remote location.
8. Amplifier output screw terminals.
9. VOLTAGE SELECT — Voltage selector switch.
10. AC LINE INPUT — Power cord socket.
11. Fuse — 120VAC/4A, 240VAC/2A.

# Front Panel

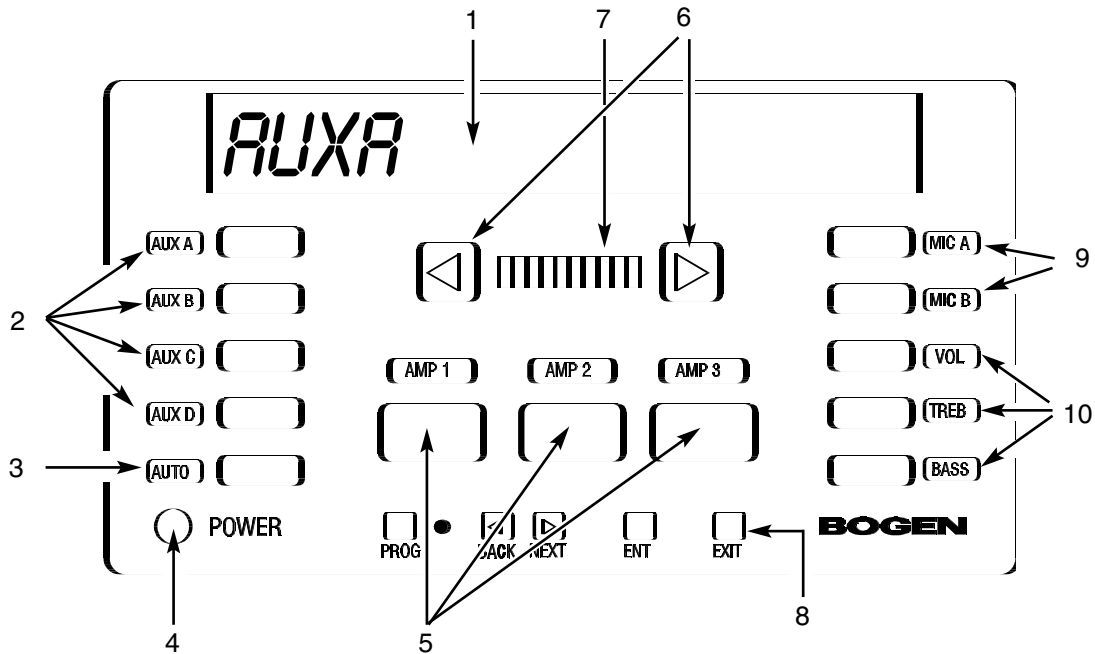

1. Alphanumeric display area.
2. AUX A/B/C/D — Input selector buttons & indicators.
3. AUTO — Controls manual or automatic input selection.
4. POWER — Applies power to the ProMatrix unit.
5. AMP 1/2/3 — Amp/Preamp Channel Selector Buttons.
6. Level control Arrow buttons.
7. LED pointer area.
8. PROG, NEXT, BACK, ENT & EXIT — Programming buttons.
9. MIC A/MIC B — Microphone input selector buttons.
10. VOL/BASS/TREB — Function control selector buttons.

# Infrared Remote Controller

The infrared remote controller provides all of the functions of the front panel.

Before using the controller, install two AAA-size batteries in the battery compartment of the controller. Be sure to observe correct polarity.

To use the controller, point the controller at the infrared receiver window on the left side of the front panel of the ProMatrix chassis and press the desired button.

1. POWER — Controls power to the ProMatrix unit.
2. MIC A & MIC B — Manual microphone selector buttons.
3. AUTO — Toggles between auto input selection and manual input selection.
4. AUX A/B/C/D — Manual input selector buttons.
5. AMP 1/2/3 — Amp/channel selector buttons
6. TREB/BASS/VOL — Function selector buttons
7. Up/down Arrows — Used to adjust level of TREB/BASS or VOL.
8. Programming buttons.

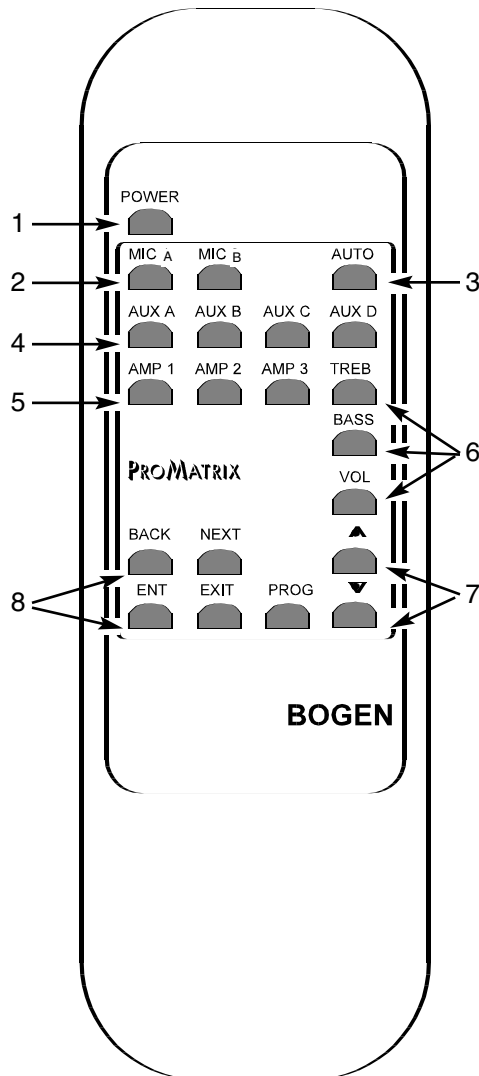

# Wiring Information

## Outputs For PM-3000 Preamplifier

Each preamplifier channel has its own balanced output terminals and unbalanced RCA output jacks on the rear panel to handle different amplifier and signal processing inputs.

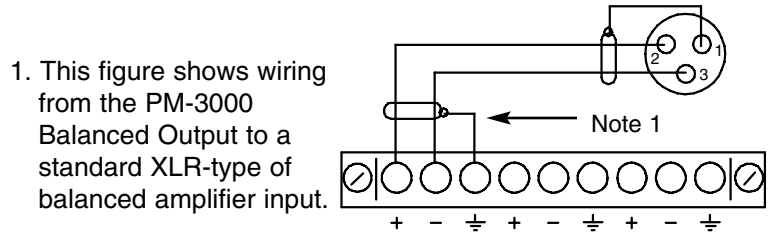

Note 1. In some instances, connecting the cable shield to both the PM-3000 ground and the amplifier's input ground may cause ground loops. In that case, remove the shield connections to the PM-3000.

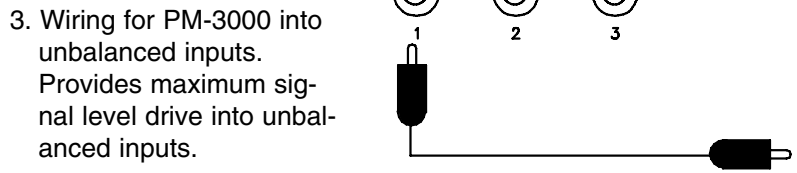
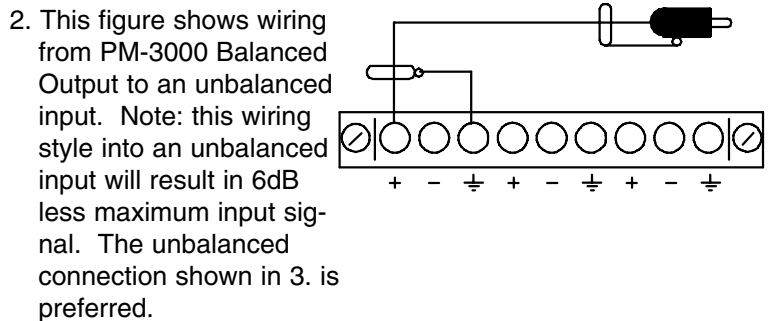

# Wiring Information

## Outputs For PM-3180 Amplifier

Each amplifier channel has its own output terminal strip on the rear panel. Each terminal strip can handle a different type of speaker load. All amps can handle 70V & 25V distributed or 8- $\Omega$  or 4- $\Omega$  loads. The 70V, 25V and 8- $\Omega$  outputs are transformer-coupled. The 4- $\Omega$  output is directly connected to the amplifier output. The 4- $\Omega$  output provides a wider frequency response with better bass reproduction and lower distortion.

To connect an 8- $\Omega$ , 25V or 70V load, attach one lead to the COM terminal and the other to the terminal corresponding to the output desired. Ensure that the shorting clip connects COM and GND and that the shorting clip for the LINK is installed.

The transformer-coupled outputs (70V, 25V, 8- $\Omega$ ) can be made to float by disconnecting the shorting clip between GND and COM. This may be desirable in certain situations where a balanced output is needed. In general, it is best to keep the shorting clip installed between GND and COM.

To connect a 4- $\Omega$  load, first remove the shorting clip between the two screw terminals marked LINK. Connect one lead of the 4- $\Omega$  load to the 4- $\Omega$  terminal and the other lead to the GND terminal.

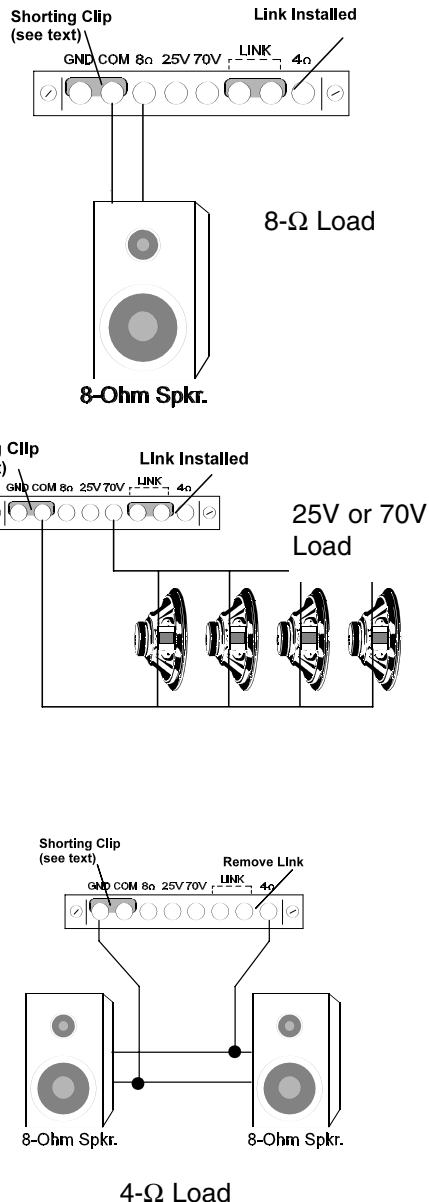

# Wiring Information

## AUX Inputs

Unbalanced input sources other than microphones are connected to the AUX INPUT jacks. The output lead from the source must be terminated in an RCA-type plug. The input signal range is 100mVrms to 3Vrms and is adjusted using the AUX TRIM controls.

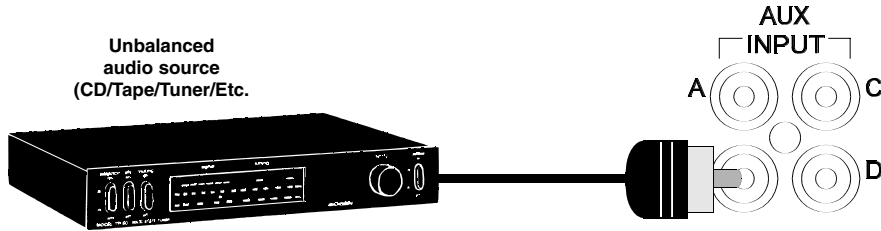

## Aux Input Trim Controls

See page 10 for adjustment procedure

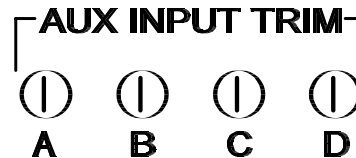

## Audio Process Link Wiring (PM-3180 Only)

Typical Audio Process Link wiring is illustrated below. See page 32 in the Programming section to deactivate the internal connection between the pre-amp out and power amp in so that the external equipment can be inserted.

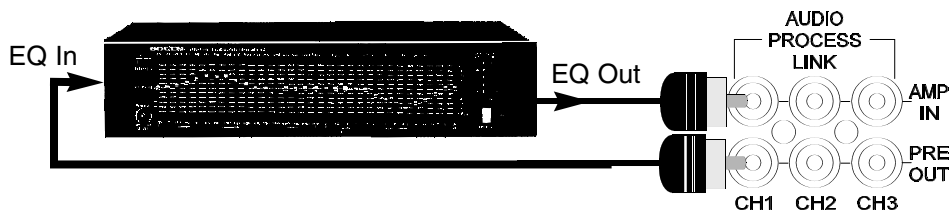

# Wiring Information

## MIC Inputs

### Mic A

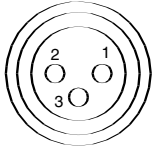

Pin 1 is GND  
 Pin 2 (+)  
 Pin 3 (-)

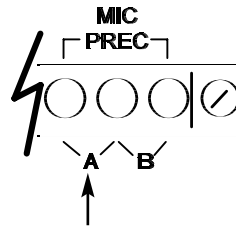

If Mic A has a push-to-talk switch, use these terminals for the switch connection (see Mic Precedence Setup in the Programming Section).

### Mic B

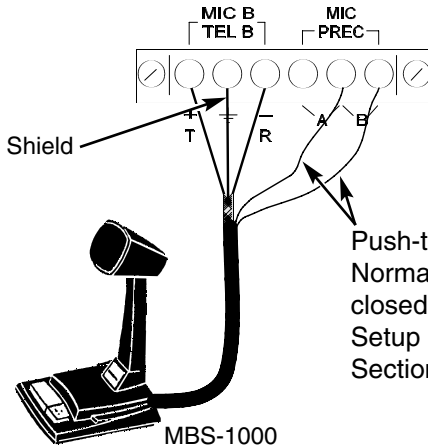

Push-to-talk switch pair. Normally open or normally closed (see Mic Precedence Setup in Programming Section).

### Mic B/Tel

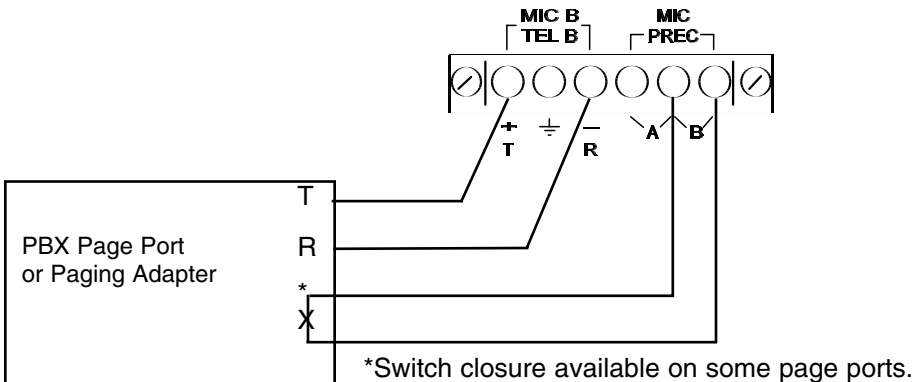

\*Switch closure available on some page ports.

Program the unit for correct switch precedence or use VOX precedence if no switch closure is available.



# User Operation

---

## The ProMatrix Control Panel

The control panel is the interface between the user and the unit functions. Since there are three channels (amp or preamp) and only one control panel, the ProMatrix uses selector buttons, indicators and an alphanumeric display to provide control of the overall functions. The information below will familiarize you with the operation of the control panel.

The control panel typically shows the following information:

- The currently active amp/channel — the one that is currently under control panel control — by means of an indicator lamp.
- The currently active input — shown on the alphanumeric display and indicator lamp.
- Input selection status — either automatic or manual selection
- The currently active control — VOL, BASS or TREB — which can be adjusted by pressing the arrow buttons.

If the arrow keys are not touched for 5 seconds, the unit defaults to the VOL control; you have to first select BASS or TREB to use these controls.

When the ProMatrix is in User Mode, the user can perform the following functions

- Apply power
- Select a channel
- Adjust volume and tone for all inputs on the selected amp/channel
- Manually select an input

### To Apply Power to the ProMatrix Unit

To apply power, press the button labeled POWER on the control panel. or on the wireless infrared remote controller.

### To Select an Amp/Channel

In order to change the volume or tone for an amplifier channel, the amp/channel must first be selected. To select, press the desired AMP button (AMP 1, AMP 2 or AMP 3). Its indicator will illuminate brightly. The current input for that amp will appear on the alphanumeric display panel.

Once an AMP is selected, the user can adjust the VOL, BASS or TREB control to the selected AMP.

# User Operation

---

## To Control Volume, Bass or Treble

**Note:** Changing any of the volume, bass or treble levels will effect all inputs associated with that amplifier channel. Turning up the volume for the current amplifier will cause other inputs to play louder when they become active. Likewise for bass and treble.

1. To control volume, bass, or treble you must first select the desired control (VOL, BASS, TREB so that its indicator LED lights. The LED pointer will light to indicate the approximate level setting.
2. Press the arrow buttons on either side of the pointer. The display will show (assuming Amp 1 is the selected amplifier):

**For Volume:** *A1/VOL-XX*, where XX is a 2-digit number from 00 to 25, corresponding to the volume level.

**For Treble:** *A1/TREB X*, where X is a digit from -7 to +7, corresponding to the amount of cut or boost.

**For Bass:** *A1/BASS X*, where X is a digit from -7 to +7, corresponding to the amount of cut or boost.

- 3 After 5 seconds of no adjustment, the alphanumeric display will return to the previous display and show only the current input.

**Note:** The volume and tone controls for a particular amplifier can be programmed so that they do not respond to the control panel (or infrared remote) buttons. If this programming has been performed, the word *INHIBITED* will appear on the alphanumeric display when the controls are pressed.

**Note:** The volume of the ProMatrix is affected by three constraints: 1) the preset level, 2) volume changes made by the user and 3) the volume limits if set. The case may occur where the user raises the volume level to the limit set for the current input. If the input then changes, the volume level and limit for the new input may allow further increase of the volume. If the original input once again becomes active, it will still be held at the limit for the second input. Now, if the user lowers the volume of this input, the levels of all the other inputs will change to reestablish the differences set by programming. In so doing, all other non-active inputs may change by more than the amount

# User Operation

---

the current input was lowered by. This is because the levels set by the user are temporary and the ProMatrix always strives to maintain volume differences set by the preset programming. Typically, this will only occur when the inputs or limits are set vastly different for the inputs assigned to an amp channel. The same applies to the tone controls where the amp tries to maintain the EQ differences.

## To Select a Specific Input

The amplifier monitors active inputs and, based on the default or installer-created priority table, automatically switches the proper input for each channel. You can override the priority switching feature to select a specific input.

1. Press the AUTO button. Its indicator LED will flash and *SEL INPUT* appears on the display panel.
2. Press the desired input selector button (MIC A/B, AUX A/B/C/D). The AUTO LED and selected input LED will flash to indicate that auto-switching is off for this channel.

**Note:** You must return to auto-switching before manually selecting another input.

**Note:** If one amp is manually selected but the current amp is in Auto-switch mode, the AUTO indicator will flicker to indicate that another channel is under manual control. When the manually selected amp is again made current, both the AUTO and selected input LEDs will flash.

## To Return to Auto Switching

Make the amplifier under manual control the current amp by pressing the appropriate AMP button.

Press the AUTO button. The current input (based on priority) will appear on the display and its indicator LED will light. The AUTO LED will light steady.

## Important Operational Notes

When a microphone becomes active (through Vox or contact closure), the current Aux input will be muted to a preset (Aux Mute function) level. No input switching is allowed when the Aux mute is active.

When a higher priority input becomes active, ProMatrix changes to that input. If that input goes silent for more than approx. 16 seconds, the unit will fade in the next lower priority active input. (Mics in VOX mode take approx. 4 seconds to switch back. In contact closure mode, the switchback is immediate.) One exception is the AUX D input which allows approx 30 seconds of silence before switching back. This extra delay is provided for equipment, such as Juke boxes that may have a considerable delay between music selections. If the extra delay is needed, simply give AUX D the desired priority level for the source connected to it. If the extra delay is not needed, leave AUX D as the lowest priority level or remove it from the priority list if it is not needed.

# Programming

---

## Enter Programming Mode

The programming mode lets the installer custom configure the ProMatrix unit. The installer uses the programming buttons on the front panel or the infrared remote controller.



Programming Buttons

1. Press PROG. The LED next to the button lights and the display shows 3 dashes. The unit requires a 3-digit password. The factory default is 0 0 0.
2. Press the NEXT or BACK buttons to increment or decrement the first flashing digit position until “0” appears and then press ENT.

Note: Pressing any button other than NEXT, BACK or ENT will exit the password entry function.

3. Repeat Step 2 for the second and third digits.

Note: There is no way to correct an error when entering the password. If an error is made, simply press PROG or EXIT and then start over.

4. Once the complete password is entered, the display shows the first menu selection – *ASSIGNMENT*.
5. To program the function shown, press ENT. To select a different function, press the NEXT or BACK buttons to scroll through the list of available functions (The menu tree of available function is shown on the next page).
5. After you have finished programming a function, press EXIT once to return to the function menu. You can use the NEXT or BACK buttons to select functions or you can press EXIT again to return to the user mode.

# Programming

## Programming Menu

The ProMatrix programming menu is illustrated below:

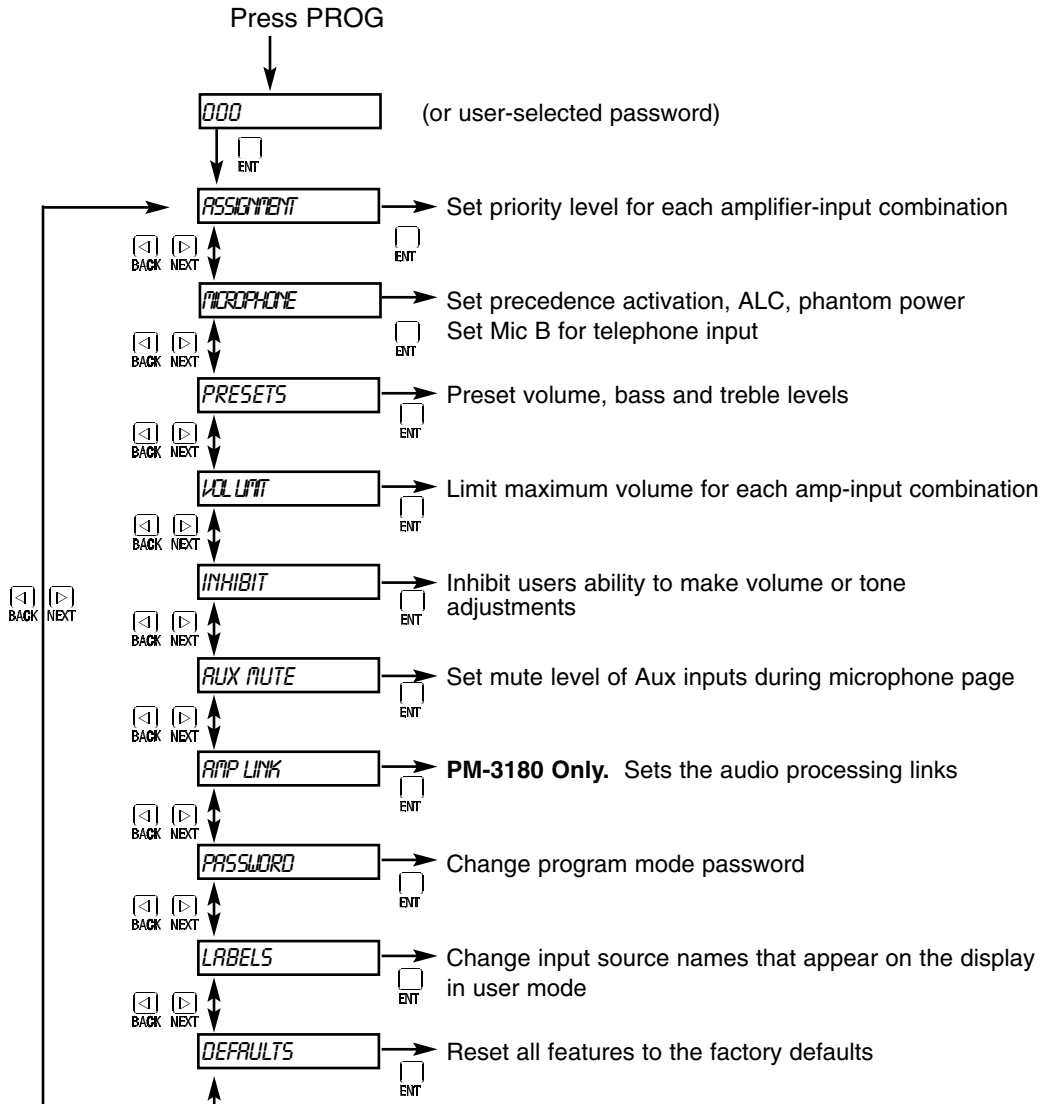

# Programming

## Assignment

The ASSIGNMENT function lets you assign a priority levels to each amplifier-input combination. This function lets you create a variety of configuration schemes and obtain maximum versatility to meet application needs.

The factory default priority levels are listed below:

Input	Factory Priority Level	
MIC A	1	
MIC B	2	
AUX A	3	1 = highest priority
AUX B	4	6 = lowest priority
AUX C	5	
AUX D	6	

**Note:** Mic A and Mic B can only be assigned priority 1 or 2; Aux inputs can only be assigned priority 3, 4, 5, or 6. Therefore, mics will always have higher priority than Aux inputs. AUXD takes approx. 30 sec to switch to lower priority input (all other Aux inputs take approx. 16 seconds, Mics take approx. 5 seconds).

1. Enter programming mode and press ENT when the function title *ASSIGNMENT* appears on the display.

2. When the function is entered, the *AM1/AUX A* (Amp 1 and Aux A) amp-input combination is always shown, along with that combination's current priority assignment number (3). To select another combination, use the AMP buttons and Input buttons. The new combination appears on the display with its associated priority level.

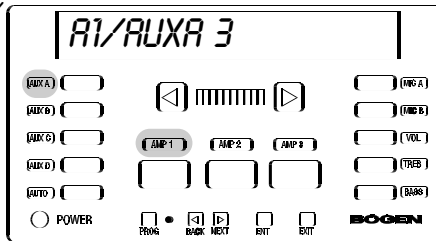

3. **A priority level can only be assigned when it is not in use by another input.** To eliminate an input priority so that it is available for use by another, select the amp-input combination that has the desired priority number. Press NEXT or BACK until a dash (—) appears and then press ENT. This disconnects that input from the amp so that its priority level is available for use with the other input.
4. Now you can select the desired amp-input combination and then press the NEXT or BACK buttons to increment through available priority levels (for Mics, 1 & 2; for Aux inputs, 3, 4, 5 or 6).

# Programming

---

5. Select a level and **press ENT to save the selection** (PROG LED will blink when selection has been entered).

**Important:** You must press ENT after **every** change you make in order to save the new setting. This is true for all programming procedures.

6. Repeat Step 3, 4 and 5 to assign any other inputs to the amplifier channel. Note that priority level numbers become unavailable from the selection list as they are assigned to a particular input.

**Note:** Priority levels do not need to be assigned consecutively. For example, an installer could assign only 2 inputs to an amplifier channel and give one the highest priority (1) and the other the lowest (6). If the priority 1 input went inactive, the amplifier would switch to the input with the next lowest priority (6). At least one input source must be assigned to each amp channel for proper operation.

7. Once you have finished assigning priorities for one amplifier, you can press a different AMP button and proceed to program inputs for this amplifier channel.
8. To exit the function, press EXIT. The display will again show *ASSIGNMENT*.
9. Press the NEXT or BACK buttons to scroll through the function menu or press EXIT to return to users mode.

# Programming

## Mic Set Up

This function lets you set the Microphone features:

- Precedence Activation:
  - N.O. = Normally Open - requires short between precedence terminals to activate mic
  - N.C. = Normally Closed - requires short between precedence terminals to deactivate mic
  - VOX = Voice Activated switch activation)
- Automatic Level Control (ALC)
- Phantom Power (PPS)
- For MIC B, it also permits setting the input as a transformer-balanced 600-Ohm input for telephone paging applications.

**Note: Changes made during MIC Setup will not be activated until you exit the programming mode.**

The factory defaults are listed below:

Feature	MIC A	MIC B
Precedence Activation	VOX	VOX
Automatic Level Control	On	On
Phantom Power	On	On

1. Enter the programming mode and press the NEXT or BACK buttons until *MICROPHONE* appears on the display.
2. Press ENT to enter the function.

### To Set MIC Parameters

1. Select the Mic to be configured by pressing either the MIC A or MIC B buttons. If, for example, you press MIC A, the display shows the precedence setting for MIC A: *A PREC VOX*, which indicates that the MIC A-precedence activation is set to VOX.

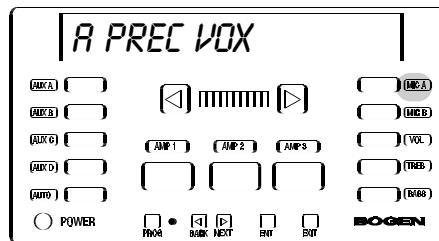

2. Press the NEXT or BACK buttons to scroll available options: *VOX, N.O.* and *N.C.*
3. **Press ENT to store the selection** and proceed to the next feature. The PROG LED will blink to indicate that data was stored.



# Programming

- The display shows *A ALC ON* indicating that MIC A ALC status is ON.
- Press the NEXT or BACK buttons to select *ON* or *OFF*.
- Press ENT to store the selection.**
- The display shows *A PPS OFF* indicating that the MIC A phantom power is OFF. If Mic B is set as a TEL input (see below), *PPS* will not be shown since it does not apply to tel inputs.
- Press the NEXT or BACK buttons to select *ON* or *OFF*.

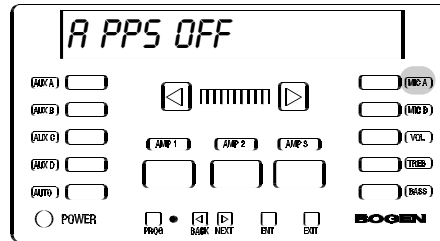
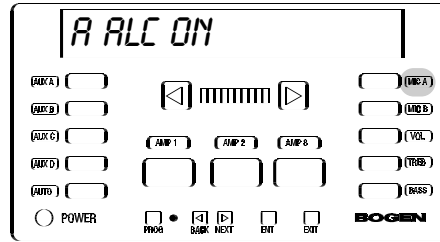

- Press ENT to store the selection.** At this point, the display again shows the precedence display. Press EXIT to return to the function menu or press the MIC B button to configure MIC B.

**Note:** During mic configuration, you can switch between MIC A or MIC B. For example, when the display shows *PPS* (phantom power) for MIC A, you can press MIC B and set the phantom power feature for MIC B. The same holds true for the *PREC* and *ALC* features.

## To Set MIC B for TEL Operation

Located between the ALC and PHAN features is the MIC B TEL setup feature:

- The display shows *B IN-MIC* which indicates that MIC B is set for use with microphones.
- Press the NEXT or BACK buttons to select *MIC* or *TEL*.

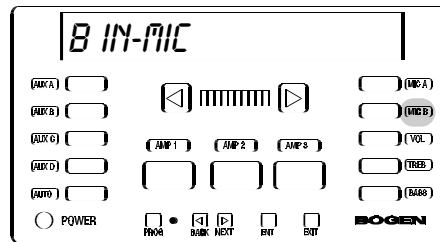

- Press ENT to store the selection.** If set for MIC, the next display shows *PPS*. If set to *TEL*, the next display shows *PREC*.
- Press EXIT to get to the main menu or continue with other functions.

# Programming

## Presets

This feature lets the installer adjust the power-up volume, bass and treble of each amp/channel-input combination. It also sets the relative volume levels between different inputs on a particular amplifier channel. The same inputs can have different volume and EQ settings on different amps.

**Note:** The system should be completely wired before making any of these adjustments, since the installer will normally want to listen to the output in order to make the adjustment. Additionally, the input trim levels should be set correctly; see page 10 for information on adjusting trim levels.

1. Enter programming mode and press the NEXT or BACK buttons until *PRESETS* appears on the display.
2. Select the desired control (VOL, BASS or TREB) by pressing the corresponding button.
3. Select the amplifier and input you wish to adjust by pressing the appropriate selector buttons.

4. Press ENT to enter the function. The display shows the current amp-input combination and preset level for the selected control. In the illustration at right, VOL is the selected control. The display *A1/AUXA10*. indicates that the preset volume level for the Amp 1-Aux A combination is 10 (on a scale of 00 - 25; 10 is the factory default level).

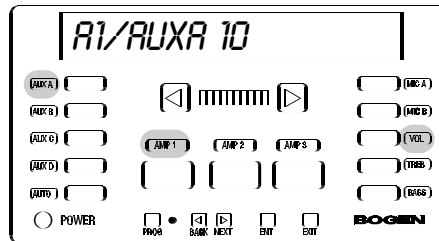

4. Press the arrow buttons to increase/decrease the volume. The preset number will increase or decrease, and the pointer will move left or right in response to the changes made.



# Programming

**Note:** Press and hold arrow buttons to effect rapid changes in volume. Quick presses of the buttons will effect single-step changes in volume.

5. **Once you have set the desired volume for an input, press ENT.** The PROG light will blink to indicate that the data was stored.
6. At this point, you can select another amp/channel-input combination and repeat Steps 4 and 5 to set other volume levels. You can also select the BASS or TREB control and set the levels for these controls.

When you press the BASS or TREB button, the display shows the current amp/channel-input combination and preset level (-7 to +7, corresponding to the amount of cut or boost; 0 is the default).

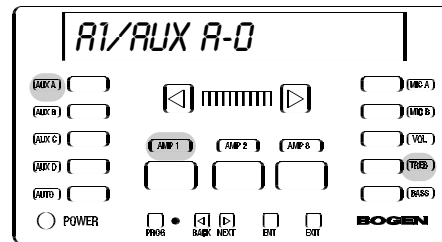

Press the arrow buttons to increase/decrease the tone control. The level number will increase or decrease, and the pointer will move left or right in response to the changes made.

**Remember to press ENT after setting each level.**

7. Once all levels are set, press EXIT to return to the function menu. At this point you can exit the programming mode or press NEXT or BACK to select another function.

**Note:** You should preset the level and tone for all inputs, even those that are not assigned to an amp channel. This is because a user can select an unassigned input using the manual input selection feature.

# Programming

## Volume Limit

This function sets the maximum volume level that a user can select for an amp/channel-input combination.

**Warning:** The Volume Limit function will cause the amp-input combination in the PM-3180 to play at the maximum limit (default value is 25, full volume). This will normally be quite loud. Be careful that people are not next to speakers and that the power rating of the speakers is high enough to handle full amplifier power. Since the PM-3000 can only control the maximum input signal to an amplifier, the VOL limits are only valid if the external power amplifier volume is not changed.

**Note:** The system should be completely wired before making any of these adjustments, since the installer will normally want to listen to the output in order to make the adjustment.

1. Enter programming mode and press the NEXT or BACK buttons until *VOL LIMIT* appears on the display.

2. Press ENT to enter the function.

3. Select the amplifier and input you wish to limit by pressing its selector buttons. The display shows the current amp-input and its current volume limit setting. The 2-digit volume level can range between 00 and 25. The factory default is 25, allowing full volume. Subsequently, the display will show the current setting.

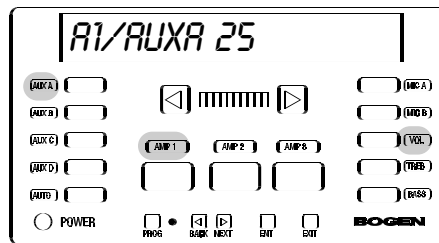

5. Press the arrow buttons to increase or decrease the volume. The level number will increase or decrease, and the pointer will move left or right in response to the changes made.



**Note:** Press and hold arrow buttons to effect rapid changes in volume. Quick presses of the buttons will effect single-step changes in volume.

# Programming

---

6. **Once you have set the desired limit for an input, press ENT.** The PROG light will blink to indicate that data was stored.
7. Select another amp/channel-input combination and repeat Steps 4 and 5 to set other levels. **Remember to press ENT after setting each level.**
8. Once all levels are set, press EXIT to return to the function menu. At this point you can exit the programming mode or press the NEXT/BACK buttons to select another function.

**Note 1:** If the Volume Limit is set below the Preset volume level, the Volume Limit will control the power on output level.

**Note 2:** Unassigned inputs for an amp can still have their Volume Limit set. This is allowed since an input can be manually selected even if it is not assigned a priority level.

# Programming

## Inhibit

This function lets the installer inhibit the user's ability to change the preset volume and tone settings for a particular amplifier (Bass and Treble are always inhibited together as Tones). Pressing BASS or TREB does the same thing). Once set, the unit will not respond to commands from the front panel or remote controller for this amplifier channel in the user mode.

1. Enter programming mode and press the NEXT or BACK buttons until *INHIBIT* appears on the display.
2. Press ENT to enter the function.
3. Select an amp/channel by pressing one of the AMP buttons.

4. Press one of the control buttons (VOL, BASS or TREB). The display shows the current amplifier and the inhibit status for the selected control. You should hear program over the speakers.

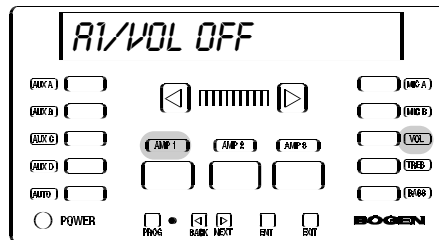

5. In the illustration at right, VOL is the selected control. Press the NEXT or BACK buttons to toggle between *VOL ON* and *VOL OFF*. (*ON* means that the volume function inhibit is on and no user volume control is available on AMP 1. Likewise for the other functions.)
6. **Press ENT to store the selection.** The PROG LED will blink to indicate that data was stored.

**Note:** Volume and tone inhibit status for each amplifier can be performed at one time. Simply press one of the other buttons (VOL, BASS or TREB) after completing Step 6 and continue as before :

7. Once the Inhibit function has been set, press EXIT to return to the function menu. At this point you can exit the programming mode or press NEXT or BACK to select another function.

# Programming

## Aux Mute

The Aux Mute allows paging over music. This function sets the volume level of each AUX input when a page is made. Upon completion of the page, the music level fades up to the previous level. The levels can be set differently for each Aux input on each amplifier.

**Note:** The system should be completely wired before making any of these adjustments, since the installer will normally want to listen to the output in order to make the adjustment.

1. Enter programming mode and press the NEXT or BACK buttons until *AUX MUTE* appears on the display.

2. Press ENT to enter the function. The display shows the current amp/channel-input combination and a two-digit number representing the volume level of the muted input. The default is 00 (total muting) and can be adjusted to 25 (no muting).

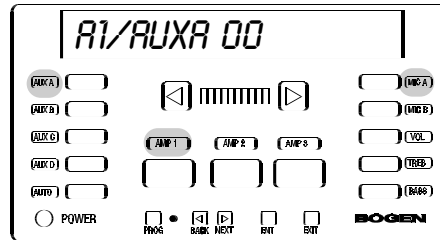

3. Select the desired amp/channel-input combination and also a paging mic.
4. Make a page with the microphone (or telephone input) and use the arrow buttons to adjust the Aux source to the desired level. If the Aux Mute level is set to 00 the program will be completely muted.

**Note:** The mic level for adjusting this feature is set at its preset level for the mic and amp combination.

5. Press ENT to store the level. The PROG LED will blink to indicate that data was stored
6. Repeat steps 3, 4, and 5 for additional inputs/amp/channels and mics.
7. Once the Aux Mute function has been set for all inputs on all amp/channels, press EXIT to return to the function menu. You can exit the programming mode or press NEXT or BACK to select another function.

**Note:** The Aux Mute level will only decrease the Aux output level when a page is made. If set higher than the current user volume level or the Vol Limit level, no change in level will occur.

# Programming

## Amplifier Link (PM-3180 Only)

This function disconnects the power amplifier input from the preamp processing circuit and permits the addition of outboard signal processing equipment (such as an equalizer or ambient noise response unit) to the Audio Process RCA connectors on the rear of the amplifier chassis. The link is illustrated graphically below:

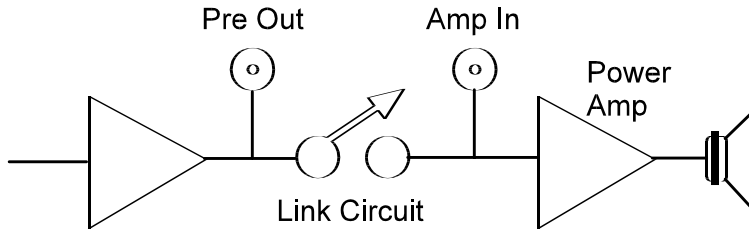

1. Enter programming mode and press the NEXT or BACK buttons until *AMP LINK* appears on the display.

2. Press ENT to enter the function. The display shows the the current amplifier and link status (the default is Amp 1, Link In).

3. Select the desired amp by pressing the appropriate AMP button.

4. Press the NEXT/BACK buttons to toggle the status between *IN* and *OUT*.

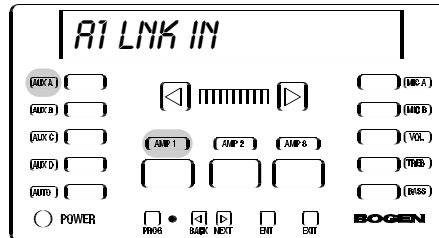

5. **Press ENT to store the selection.** The PROG light will blink to indicate that data was stored.
6. Repeat steps 3, 4, and 5 for additional links.
7. Once the Amp Link function has been set, press EXIT to return to the function menu. At this point you can exit the programming mode or press NEXT or BACK to select another function.

**Note:** “IN” means that the internal connection between the power amp and the preamp is connected. Set status to OUT when inserting external equipment.

**Note:** The change in status only becomes effective after exiting the program mode.



# Programming

## Password

This function lets the installer change the program mode password.

1. Enter programming mode and press the NEXT or BACK buttons until *PASSWORD* appears on the display.
2. Press ENT to enter the function. The display shows the the current 3-digit password (The default is 0 0 0.) The first numeral will be flashing.
3. Press the NEXT or BACK buttons to increment the first numeral from 0 to 9.
4. **Press ENT to store the selection.**
5. The second numeral flashes. Repeat steps 3 and 4.
6. The third numeral flashes. Repeat steps 3 and 4 for the third numeral.

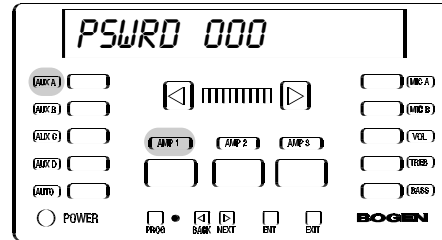

After entering the third numeral, the first numeral will begin to flash again. You can go through the digits as many times as you wish or you can exit this function and save the currently displayed password.

**Note: Make sure to press ENT for each changed digit before exiting otherwise the original digit will remain, resulting in a password different from the one planned.**

**Note:** If you forget the password, enter the number 4 5 7 for the password. This will send you directly to the password setting function. You can then change the password or simply read it to refresh your memory. When you exit this function, you automatically return to the user mode. **Do not use 4 5 7 as a password since you will not be given access to the rest of the menu features when using this number.**

# Programming

## Labels

This function lets you modify the names displayed for the current input source during user operation. For example, you can change the name of *AUX A* to *TAPE*.

1. Enter programming mode and press the NEXT or BACK buttons until *LABELS* appears on the display.
2. Press ENT to enter the function. The display shows *AUXA* or a previously entered label. The first character will be flashing.
3. If desired, select another input by pressing the appropriate button.
4. Press the NEXT or BACK buttons to scroll through the available characters (A-Z, 0-9, —, [space]) and stop at the desired character.
5. **Press ENT to store the letter selection.** The PROG light will blink to indicate that data was stored.
6. The second character position flashes. Repeat Steps 4 and 5.
7. The third character position will flash and so on. Repeat steps 4 and 5 for each letter in turn, to a maximum of 10 characters.

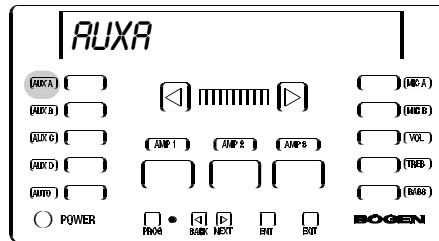

**Note:** To edit a label press the ENT key to skip over character positions until the one you want to change is flashing. Press the NEXT or BACK buttons to change the character and then press ENT to save it.

8. When you have finished entering all the desired characters, press EXIT or select a different input.
9. Press EXIT to return to the function menu. At this point you can exit the programming mode or press NEXT or BACK to select another function.

# Programming

## Factory Defaults

This function lets you quickly erase all current configuration programming and return the amplifier to its out-of-box configuration.

1. Enter programming mode and press the NEXT or BACK buttons until *DEFAULTS* appears on the display.

2. Press ENT to enter the function.  
The display shows: *CLR ALL NO*, referring to Clear All (stored programming)? = No.

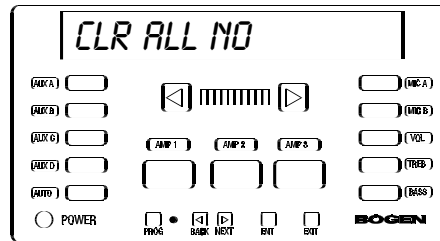

3. Press the NEXT/BACK buttons to toggle between *NO* or *YES* (for YES).

4. **Press ENT to confirm the selection.**

5. If *YES* is selected, the display asks *U-SURE NO.* for a second confirmation.

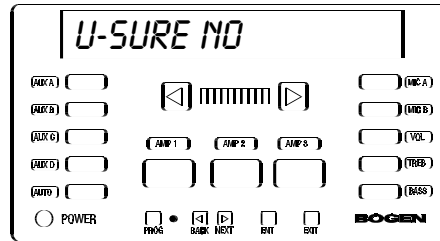

6. Again, press the NEXT/BACK buttons to select *YES* and press ENT.

If YES, the defaults will be reset and you return to the function menu.

If No is selected, programmed defaults are left intact and you return to the function menu.

7. Press EXIT to leave program mode or NEXT or BACK to select another function.

**Note:** The defaults will be installed immediately without exiting the program mode. They can then be viewed and adjusted by selecting the different functions from the function menu. Remember however, that changes in microphone input configuration and amp link status will not become effective until you exit the program mode.

# Testing & Troubleshooting

---

## Testing

### Assignment

**Test:** Remove all audio sources from Aux inputs. Connect an active audio source to the lowest priority input for the current amp/channel. Move the active source through the inputs in the order of priority that was previously set.

**Result:** The input source should immediately change as the audio source is moved between inputs. If the unit delays in switching between aux inputs then the priority schedule is set differently than expected. Reorder the priorities using ASSIGNMENT.

### Input Activity

**Test:** Set all audio sources so that they are active. Manually select each input (see page 9) and check that the source plays through the amp.

**Result:** This checks that all used inputs are active. If certain inputs do not play during normal operation, they may not have been assigned to an amp channel. Reassign the input using ASSIGNMENT.

### Amp Links - Internal (PM-3180 Only)

**Test:** Disconnect external audio processing equipment connections.

**Result:** No output from amps until external equipment is reconnected.

### Preset Parameters

**Test:** Turn unit off and on. Manually select each input assigned for each amp and check VOL, BASS and TREB settings by pushing the function buttons.

**Result:** VOL, BASS and TREBLE setting shown in display for the current amp/channel-input combination should be what was expected. If not, enter PRESET (see page 28) and correct settings.

### Aux Mute

**Test:** Make one of the Aux inputs active by turning on only its source. Select an amp and manually select a mic input. Repeat this for all Aux/Mic/Amp combinations of interest.

**Result:** The active Aux input will play through the amp at the volume set by the AUX MUTE function (see page 33). The level balance between the mic and the muted Aux input can also be checked this way.

# Testing & Troubleshooting

---

## Vol Limit

**Test:** Manually select an Aux or Mic input. Press and hold the right arrow button until the display stops incrementing.

**Result:** The display stops incrementing at the volume limit for the particular input and amp combination (see page 30). Turn the Promatrix power off and then on to return volume levels to their initial preset levels.

## Troubleshooting

### Display shows COM ERROR or a series of 0, +, X

- Unplug the unit, wait 5 seconds then restore power.
- Display communication problem. Look for bent, broken or dirty pins on display panel rear connector.
- Display cable broken or bent or dirty contacts in jacks.

### False triggering of non-active higher priority inputs

- Aux signal is overloading the input (see above).
- Overloaded amplifier outputs. Check that the correct output tap is used. Recheck speaker power settings and connections.

### No output from an amp (PM-3180 Only)

- Assuming that power is on, volume is turned up and input is active — check that the shorting clip across LINK on the amplifier output terminal strip is in place (except 4-ohm operation).
- Check that the shorting clip is in place between COM and GND and that the speaker load returns to one of these. If the shorting clip is removed, make sure the speaker load returns to the correct terminal (see page 14).
- Check that the internal audio processing links are set to IN (see page 34).

### Pop when microphone is turned on

- If the microphone is not a condenser type, be sure that phantom power is turned off for that input.
- Some pop noise can be caused by the mechanical switching of the mic's on/off switch.

### Mic always active

- Microphone input precedence set to N.C. (see page 26).
- Hum and noise on mic line. Check mic wiring.
- Mic manually selected (see page 9).

# Testing & Troubleshooting

---

## **Mic never active**

- Check that the type of precedence setting is correct for the application (See page 26).
- If mic is a condenser type, check that phantom power is applied to mic input (see page 27)
- Check that mic is assigned to the amp in question (see page 24).
- If Mic B is the problem, check that it is not set for Tel operation (see page 27).

## **Mic distorted**

- Reduce volume until output is not distorted.
- Check if ALC for that mic is turned on (see page 27).

## **Tel input distorted**

- Make sure no DC voltage is connected to the Tel input.
- Check that Mic B is set for Tel operation (see page 27).

## **Aux always active**

- Check if Aux is manually selected.
- Check for high levels of hum and noise from source.

## **Aux never active**

- Check if Aux is assigned to amp in question (see page 24).
- No or very low audio signal present at aux input in question.

## **Music cuts in late**

- Trim pad set incorrectly (see page 10).
- Energy content of music very low.

## **No control over volume or tone**

- Check that the correct amp is selected (see page 7).
- If INHIBIT appears on the display when arrow buttons are pushed, the function has been programmed not to respond. (see page 32).

## **Forgot password**

- Reset password (see page 35).

# Getting Help

---

Bogen has support available in case you have a problem with your ProMatrix. In order to make the most effective use of this service, please be sure to fill out and return the product registration card included with this unit.

Best results are obtained when you:

- Read the User's Guide before operating
- Remember that certain functions can be "locked out" when the amplifier is in operation.
- Ensure all input and output wiring is correctly installed. If using the PM-3180 4-ohm output, be sure to remove the output link (see instructions).
- Make sure that input sources are active. Microphones may require software setup (see instructions).

For warranty service, refer to the product registration card. Our customer service support center can be reached at (201) 934-8500, extension 1310, weekdays from 9AM to 8PM, Eastern time. Or you can e-mail [support@bogen.com](mailto:support@bogen.com).

# Specifications

---

## PM-3180

### Power Output:

Amp 1: 100 wrms  
Amp 2: 60 wrms  
Amp 3: 20 wrms

### Output Taps:

8-ohms, 25V and 70V transformer-coupled (balanced or unbalanced)  
4-ohms direct coupled (unbalanced)

**Output Regulation:** <2dB from no load to full load (all amps)

### Input Sensitivities:

Mic Inputs: 750 $\mu$ Vrms (no ALC)  
Aux Input: 100mVrms to 2.5Vrms (trimmer adjustable)  
Tel Input: 170mVrms

### Input Impedance:

Mic Inputs: 200-ohms balanced  
Tel Input: 600-ohms transformer balanced  
Aux Input: 50Kilohms unbalanced

### Frequency Response & Distortion (20Hz to 20KHz):

Amp 1: Aux Inputs: 20Hz to 20KHz  $\pm$ 2dB, <0.5% THD+N, direct output  
Aux Inputs: 70Hz to 20KHz  $\pm$ 2dB, <0.5% THD+N, transformer output  
Mic Inputs: 100Hz to 10KHz  $\pm$ 2dB, <0.5% THD+N, all outputs  
Amp 2: Aux Inputs: 20Hz to 20KHz  $\pm$ 2dB, <0.5% THD+N, direct output  
Aux Inputs: 70Hz to 20KHz  $\pm$ 2dB, <0.5% THD+N, transformer output  
Mic Inputs: 100Hz to 10KHz  $\pm$ 2dB, <0.5% THD+N, all outputs  
Amp 3: Aux Inputs: 20Hz to 15KHz  $\pm$ 2dB, <1% THD+N, direct output  
Aux Inputs: 100Hz to 15KHz  $\pm$ 2dB, <1% THD+N, transformer output  
Mic Inputs: 100Hz to 10KHz  $\pm$ 2dB, <1% THD+N, all outputs

### Signal To Noise (20Hz to 20KHz):

Mic Inputs: -55dBr  
Tel Input: -55dBr  
Aux Inputs: -70dBr

**Volume Control:** 25 step digital

### Tone Controls:

Bass:  $\pm$ 10dB @ 50Hz in 15 steps  
Treble:  $\pm$ 10dB @ 15KHz in 15 steps

### Audio Process Jacks

Pre-Out: 300-ohms, 750mV @ full volume (all amp channels)  
Amp-In: 5Kilohms, 750mV sensitivity (all amp channels)

**Phantom Power Supply:** 13VDC switchable, all mic inputs

**Overload Protection:** Automatic reset, electronic

**Thermal Protection:** Thermistor heat sink sensing, 105°C

**Power Consumption:** 430W, 120VAC @ 3.6A, 240VAC @ 1.8A



# Specifications

---

## PM-3000

### Outputs:

0dBV balanced outputs via screw terminal strips (all channels)

0dBV unbalanced outputs via RCA jacks (all channels)

**Maximum Output:** 15dBV into 600Ω balanced

**Maximum Gain:** 17.7dB (Vol. control @ 25)

### Input Sensitivities:

Mic Inputs: 750μVrms (no ALC);

Tel Input: 170mVrms;

Aux Input: 100mVrms to 2.5Vrms

### Input Impedance:

Mic Inputs: 200-ohms balanced;

Tel Input: 600-ohms transformer balanced

Aux Input: 50Kilohms unbalanced

### Frequency Response & Distortion (20Hz to 20KHz):

Aux Inputs: 20Hz to 20KHz ±2dB, <0.1% THD+N

Mic Inputs: 100Hz to 10KHz ±2dB, <0.1% THD+N

### Signal To Noise (20Hz to 20KHz):

Mic Inputs: -55dBr;

Tel Input: -55dBr;

Aux Inputs: -70dBr

**Volume Control:** 25 step digital

### Tone Controls:

Bass: ±10dB @ 50Hz in 15 steps;

Treble: ±10dB @ 15KHz in 15 steps

**Phantom Power Supply:** 13VDC switchable, all mic inputs

**Power Consumption:** 120VAC @ .25A, 240VAC @ .15A

**BOGEN®**

50 Spring Street • Ramsey, NJ 07446

[www.bogen.com](http://www.bogen.com)