

# INSTALLATION & OPERATION GUIDE

---

# 1F92W-51

Multi-stage/Heat Pump Electronic  
Digital Thermostat



**WHITE-RODGERS**

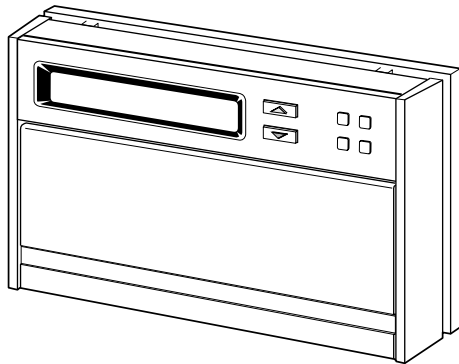

**Operator: Save this booklet for future use!**

---

## About Your New Thermostat . . .

---

Your new White-Rodgers Digital Multi-stage/Heat Pump Thermostat uses the technology of a solid-state microcomputer to provide precise time/temperature control. This thermostat offers you the flexibility to design heating and cooling programs that fit your needs.

Please read this manual thoroughly before operating or programming your thermostat. If you have questions, contact us at the address shown on the back cover of this manual.

---

## In This Guide . . .

---

<b>YOUR NEW THERMOSTAT'S FEATURES</b> .....	4	<b>OPERATING YOUR THERMOSTAT</b> .....	22
<b>PRECAUTIONS</b> .....	5	<b>PARTS OF THE THERMOSTAT</b>	
<b>THE THERMOSTAT'S SPECIFICATIONS</b> .....	6	The Back Of the Thermostat Body	
<b>INSTALLING YOUR THERMOSTAT</b> .....	7	The Display	
<b>NEW INSTALLATION</b>		The Thermostat Buttons	
Select Thermostat Location		<b>OPERATING FEATURES</b>	
Route Wires to Location		<b>PROGRAMMING YOUR</b>	
<b>REPLACEMENT INSTALLATION</b>		<b>THERMOSTAT</b> .....	34
Remove Old Thermostat		<b>PLANNING FOR YOUR NEEDS</b>	
Attach Subbase to Wall		<b>ENTERING YOUR PROGRAM</b>	
<b>SYSTEM CONFIGURATON</b>		Set Current Time and Day	
Set Option Switches		Enter Heating Program	
<b>CHECK THERMOSTAT OPERATION</b>		Enter Cooling Program	
Fan Operation		<b>CHECK YOUR PROGRAMMING</b>	
Heating System Operation		<b>QUESTIONS AND ANSWERS</b> .....	44
Cooling System Operation			
<b>LOCKOUT BYPASS OPTION</b>			
Compressor Long Term Cycle Protection			
Compressor Short Term Cycle Protection			

---

## YOUR NEW THERMOSTAT'S FEATURES

---

- Five-day/two-day programming capability
- Simultaneous heat and cool program storage
- Four separate time and temperature settings per 24-hour period
- Up to 2 stages of heat and up to 1 stage of cool
- Computed Energy Management Recovery (EMR)
- Automatic changeover (operator selectable)
- Two hour temperature override
- Manual program override (HOLD temperature)
- "Advance Program" button
- Armchair programming capability
- LCD displays continuous setpoint, time, and room temperature
- Adjustable cycle times
- 9 volt Energizer® alkaline battery backup
- Compressor long term cycle protection
- Compressor short cycle protection
- Blower delay in the cooling cycle
- Preprogrammed temperature control
- Visual prompting during operation
- Programmable blower control
- Temperature range 40° to 99°F
- °F/°C convertibility
- Electric Heat (installer-selectable)

---

## PRECAUTIONS

---

If in doubt about whether your wiring is millivolt, line, or low voltage, have it inspected by a qualified heating and air conditioning contractor, electrician, or someone familiar with basic electricity and wiring. Do not exceed the specification ratings.

All wiring must conform to local and national electrical codes and ordinances.

This control is a precision instrument, and should be handled carefully. Rough handling or distorting components could cause the control to malfunction.

### CAUTION

**To prevent electrical shock and/or equipment damage, disconnect electric power to system, at main fuse or circuit breaker box, until installation is complete.**

### WARNING

**Do not use on circuits exceeding specified voltage. Higher voltage will damage control and could cause shock or fire hazard.**

**Do not short out terminals on gas valve or primary control to test. Short or incorrect wiring will burn out thermostat and could cause personal injury and/or property damage.**

---

## THE THERMOSTAT'S SPECIFICATIONS

---

**THIS CONTROL IS DESIGNED FOR USE WHERE BOTH SIDES OF THE TRANSFORMER ARE PRESENT AT THE THERMOSTAT** (both the hot and common sides of the 24 VAC end of the transformer.)

### ELECTRICAL DATA

#### Electrical Rating:

20 to 30 VAC 50/60 Hz.

0.01 to 1.5 Amps (Load per terminal)

**2.5 Amps Maximum Total Load** (All terminals combined)

#### Anticipation:

Heating 4 to 40

Cooling 4 to 40

Auxiliary 4 to 40

### STAGING DATA

Up to 3 heating stages

Up to 1 cooling stage

### THERMAL DATA

#### Setpoint Temperature Range:

40°F to 99°F (4°C to 37°C)

#### Operating Ambient Temperature Range:

32°F to 105°F

#### Operating Humidity Range:

0 to 90% RH (non-condensing)

#### Shipping Temperature Range:

-40°F to 150°F

### ACCESSORIES

#### Thermostat Guard:

W. R. Part No. F29-0198 (clear)

or F29-0238 (opaque)

---

# INSTALLING YOUR THERMOSTAT

---

## NEW INSTALLATION

**WE RECOMMEND THAT YOU PROGRAM THE THERMOSTAT WITH BATTERY INSTALLED BEFORE ATTACHING ON SUBBASE. SEE OPERATION SECTION FOR PROGRAMMING INSTRUCTIONS.**

### SELECT THERMOSTAT LOCATION

Proper location insures that the thermostat will provide a comfortable building temperature. Observe the following general rules when selecting a location:

1. Locate thermostat about 5 ft. above the floor.
2. Install thermostat on a partitioning wall, not on an outside wall.
3. Never expose thermostat to direct light from lamps, sun, fireplaces or any temperature radiating equipment.

4. Avoid locations close to windows, adjoining outside walls, or doors that lead outside.
5. Avoid locations close to air registers or in the direct path of air from them.
6. Make sure there are no pipes or duct work in that part of the wall chosen for the thermostat location.
7. Never locate thermostat in a room that normally warmer or cooler than the rest of the building.
8. Avoid locations with poor air circulation, such as behind doors or in alcoves.

### ROUTE WIRES TO LOCATION

#### **NOTE**

All wiring must conform with local and national electrical codes and ordinances.

1. Probe for obstructions in partition before drilling  $\frac{1}{2}$ " hole in wall at selected location. Take up quarter round and drill a small guide hole for sighting (see fig. 1). From basement, drill  $\frac{3}{4}$ " hole in partition floor next to guide hole. In buildings without basements, drill  $\frac{1}{2}$ " hole through ceiling and into partition from above (see fig. 1).
2. Through this hole drop a light chain, or 6" chain attached to a strong cord. Snag cord in basement with hooked wire. In buildings without basements, drop cord through hole in ceiling and down partitioning; snag cord at the thermostat location.
3. Attach thermostat wires to cord and pull wires through hole in wall so that 6" of wire comes out of the wall.

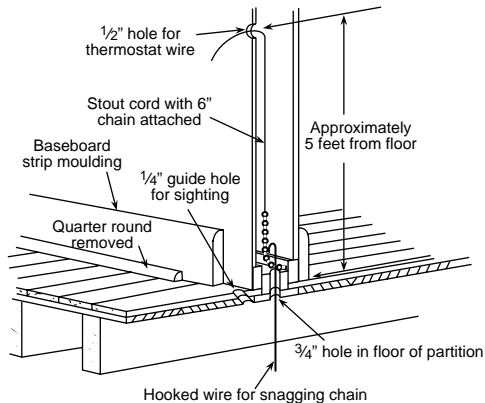

**Figure 1. Routing thermostat wires**



# REPLACEMENT INSTALLATION

## REMOVE OLD THERMOSTAT

1. Shut off electricity at the main fuse box until installation is complete. Verify power is off with a voltmeter.
2. Remove the front cover of the old thermostat. **With wires still attached**, remove wall plate from the wall.
3. If the old thermostat has a wall mounting plate, remove the thermostat and the wall mounting plate as an assembly.
4. Use the Cross Reference Guide to find the thermostat type you are replacing.
5. **Identify each wire attached to the old thermostat using the labels enclosed with the new thermostat (see Table 1). Record the identification of the wire on the corresponding blank in Table 2.**

**TABLE 1. WIRE IDENTIFICATION LABELS**

1 G	2 C	3 L	4 R	5 O	6 B	7 E1	8 E2
G 1	C 2	L 3	R 4	O 5	B 6	E1 7	E2 8
9 Y1	10 Y2	11 W1	12 W2	13 W3	14 S1	15 S2	16 S3
Y1 9	Y2 10	W1 11	W2 12	W3 13	S1 14	S2 15	S3 16

6. Disconnect the wires from old thermostat **one at a time**. Pull **at least 6 inches** of wire out of the wall. **DO NOT LET WIRES FALL BACK INTO THE WALL.**
7. Install new thermostat using the following procedures.

**TABLE 2. TERMINAL REFERENCE**

<b>LABEL NUMBER</b>	<b>NEW THERMOSTAT TERMINAL DESIGNATION</b>	<b>FUNCTION</b>	<b>OLD THERMOSTAT TERMINAL DESIGNATION</b>
(1)	G	Fan Output	_____
(2)	C	Transformer 24 VAC Common	_____
(3)	L	(this terminal not used)	_____
(4)	R	Transformer 24 VAC Hot	_____
(5)	O	Changeover Output (Cooling)	_____
(6)	B	Changeover Output (Heating)	_____
(7)	E1	Emergency Heat Relay (cycles on 1st stage in Emergency Mode)	_____
(8)	E2	Emergency Heat Relay (continually energized in Emergency Mode)	_____
(9)	Y1	Stage 1 Cool	_____
(10)	Y2	(this terminal not used)	_____
(11)	W1	Stage 1 Heat (Compressor)	_____
(12)	W2	Stage 2 Heat (Auxiliary)	_____
(13)	W3	(this terminal not used)	_____

## ATTACH SUBBASE TO WALL

1. Remove the packing material from the thermostat. Place the fingers of one hand on the center top and bottom portion of the thermostat. Grasp the subbase in the other hand on the top and bottom center, and gently pull straight out (see fig. 2). The thermostat has pin and socket connectors. Forcing or prying on the thermostat will cause damage to the unit.
2. Connect wires beneath terminal screws on subbase using wiring schematic for your particular application (see figs. 3 through 6).
3. Place subbase over hole in wall and mark mounting hole locations on wall using subbase as a template.
4. Move subbase out of the way. Drill mounting holes.
5. Fasten subbase loosely to wall, as shown in fig. 3, using two mounting screws. Place a level against bottom of subbase, adjust until level, and

then tighten screws. (Leveling is for appearance only and will not affect thermostat operation.) If you are using existing mounting holes, or if holes drilled are too large and do not allow you to tighten subbase snugly, use plastic expansion plugs to secure subbase.

6. Push excess wire into wall and plug hole with a fire-resistant material (such as fiberglass insulation) to prevent drafts from affecting thermostat operation.

(Instructions continue on page 16).

**⚠ WARNING**

**DO NOT EXCEED MAXIMUM VOLTAGE OR CURRENT RATINGS. FIRE, PERSONAL INJURY, AND/OR EQUIPMENT DAMAGE COULD RESULT.**

**⚠ CAUTION**

**To prevent electrical shock and/or equipment damage, disconnect electrical power at the main fuse box until installation is complete. Verify power is off with a voltmeter.**

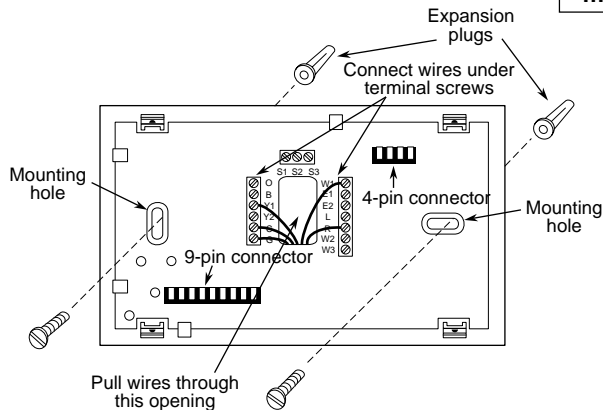

**Figure 3. Subbase**

## NOTE

The following wiring diagrams show **typical** terminal identification and wiring. For proper installation, refer to the original manufacturers' instructions.

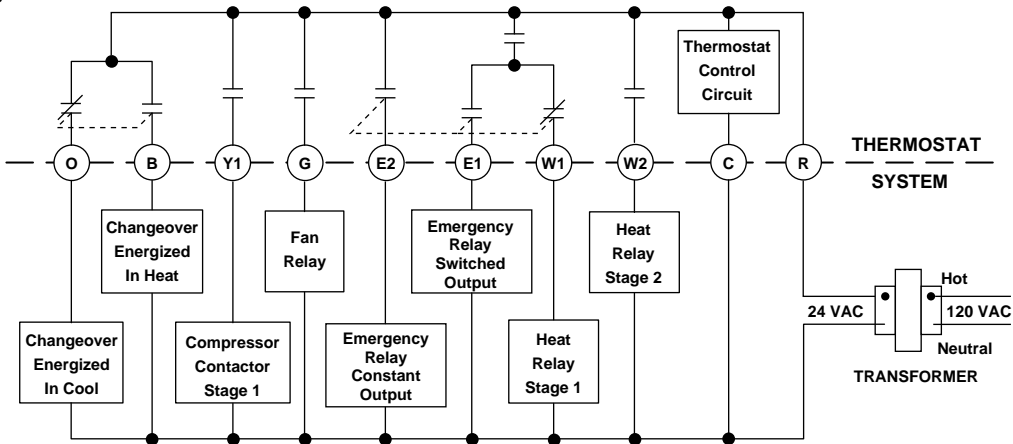

Figure 4. Typical wiring diagram for single transformer systems

## NOTE

IF SAFETY CIRCUITS ARE IN ONLY ONE OF THE SYSTEMS, REMOVE THE TRANSFORMER OF THE SYSTEM WITH **NO** SAFETY CIRCUITS.

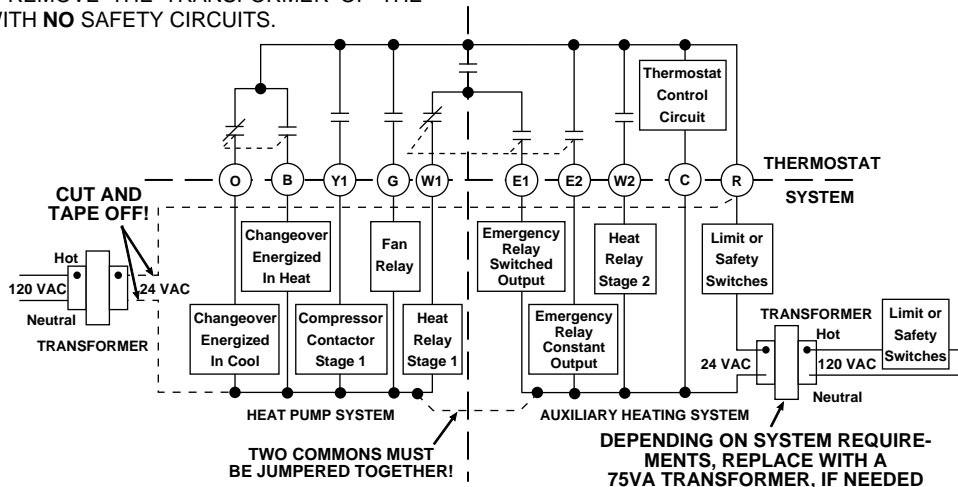

Figure 5. Typical wiring diagram for two transformer systems with NO safety circuits

**NOTE**

Relay contacts shown are thermostatically operated. The accessory relay scheme is required when safety circuits exist in both systems.

**CAUTION**

Polarity must be observed. If the HOT side of the second transformer is jumpered to the COMMON side of the first transformer a short will be made. Damage to equipment will occur when power is restored.

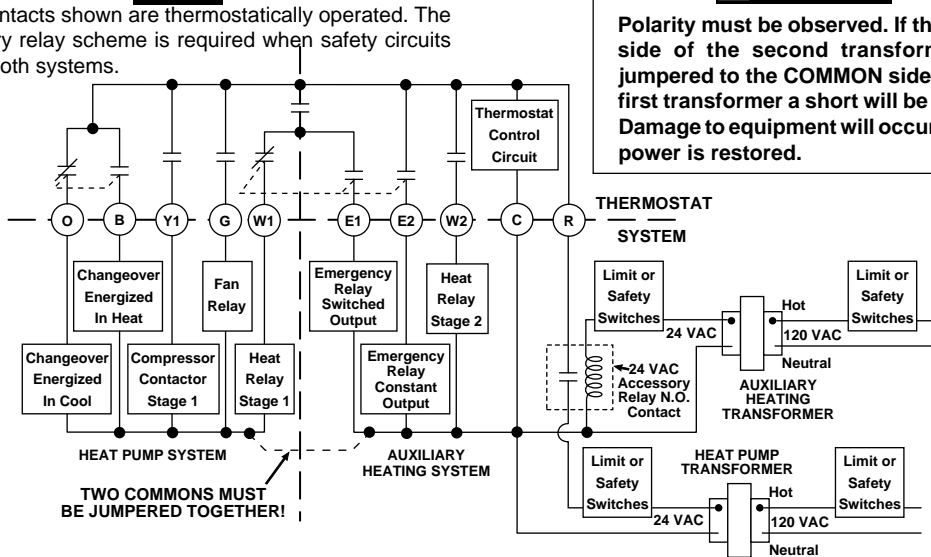



Figure 6. Typical wiring diagram for two transformer systems with safety circuits in BOTH systems

## ATTACH THERMOSTAT TO SUBBASE

**WE RECOMMEND THAT YOU SET OPTION SWITCHES TO DESIRED POSITION BEFORE ATTACHING ON SUBBASE** (see OPERATION). **WE ALSO RECOMMEND THAT YOU PROGRAM THE THERMOSTAT WITH BATTERY INSTALLED BEFORE ATTACHING ON SUBBASE** (see OPERATION section for programming instructions).

USE  TO TURN THERMOSTAT OFF BEFORE ATTACHING TO WALL. FAILURE TO TURN OFF THERMOSTAT BEFORE ATTACHING TO WALL MAY CAUSE EQUIPMENT DAMAGE DUE TO RAPID COMPRESSOR CYCLING.

To attach thermostat to subbase, line up the plastic snap guides at the top of the thermostat and the 4 connector pins on the thermostat with the connectors near the top right section of the subbase (when viewed from the front). Gently pivot the thermostat down until the 9-pin connectors and the plastic

snaps lock into place (see fig. 7). **Be gentle when attaching thermostat.** If the thermostat does not seem to be attaching to the subbase easily, make sure that the connector pins and plastic snaps are properly aligned, and that excess wire is pushed into the wall. **Damage to the thermostat may occur if force is used.**

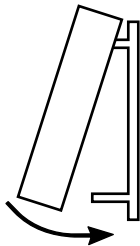

ENGAGE TWO UPPER GUIDES; PIVOT DOWN  
**Figure 7. Attaching thermostat to subbase**



# SYSTEM CONFIGURATION

## NOTE

ANY TIME AN OPTION SWITCH IS CHANGED, THE 9 VOLT ENERGIZER® BATTERY MUST BE REMOVED FOR A MINIMUM OF 2 MINUTES.

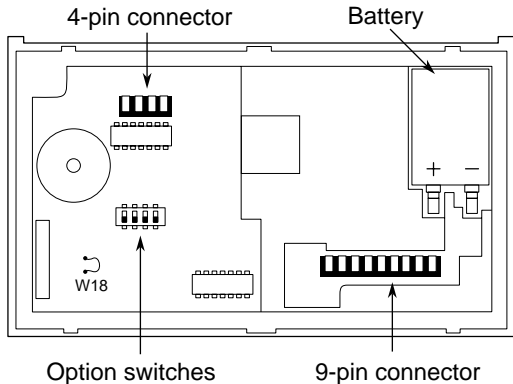
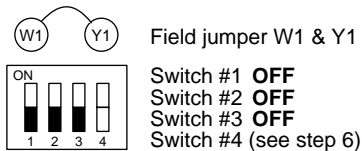

Figure 8. Back of thermostat

# SET OPTION SWITCHES

1. **Single Stage Compressor Heat Pump** — with reversing valve energized through **B** or **O** terminals



2. **Two Compressor (Split) System**

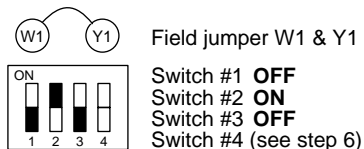

3. **Multi-stage (Fossil Fuel) System** — up to 2 heat stages and 1 cool stage

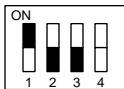

Switch #1 **ON**  
Switch #2 **OFF**  
Switch #3 **OFF**  
Switch #4 (see step 6)

4. **Multi-stage (Electric Heat) System** — up to 2 heat stages and 1 cool stage

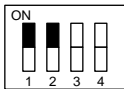

Switch #1 **ON**  
Switch #2 **ON**  
Switch #3 (see step 5)  
Switch #4 (see step 6)

5. **Automatic Changeover from Heat to Cool**



Switch #1 (see steps 1-4)  
Switch #2 (see steps 1-4)  
Switch #3 (see step 5)  
Switch #4 **ON**

### **NOTE**

The battery maintains the stored program in the event of a power failure. When attached to the wall with 24 VAC power applied, the thermostat will function normally without the battery. However, the program will be lost in the event of power interruption or failure if the battery is **not** installed. When power is restored, the thermostat will automatically maintain a temperature of 64°F or a cooling temperature of 82°F (factory preprogrammed) as needed.

## CHECK THERMOSTAT OPERATION

When checking thermostat, option switch #4 for automatic changeover must be in the **OFF** position. This will allow temporary setting of heat set points above cool settings. After system checkout, reset option switch to **ON** position if automatic changeover is desired (see **SET OPTION SWITCHES**).

### FAN OPERATION



1. Turn on power to the system. If the auxiliary heat source has a standing pilot, be sure to light it.
2. Press  until **FAN** ■ is displayed. The

### NOTE

blower should begin to operate.

3. Press  until **FAN** □ is displayed. The blower should stop operating within approximately one minute.



## HEATING SYSTEM OPERATION

1. Press  until **HEAT** is displayed. (It should already be displayed.)
2. Press  to adjust thermostat to 99°F. All stages of the heating system should come on within approximately five minutes. However, if the PUMP LED is flashing, the compressor lock-out feature is operating (see **Lockout Bypass Option** to temporarily override the compressor lockout feature during testing).
3. Press  until **EMER** is displayed. Repeat step 2.
4. To program the thermostat, see **PROGRAMMING YOUR THERMOSTAT**.

## COOLING SYSTEM OPERATION

### CAUTION

To prevent compressor and/or property damage, if power to the compressor has been off or interrupted for more than 1 hour and the outdoor temperature is below 50°F, DO NOT operate the system for at least the amount of time the compressor was off! This will allow the compressor heaters to warm the compressor oils to avoid damage due to slugging.

1. Press  until **COOL** is displayed.
2. Press  to adjust thermostat to 40°F. The cooling system should come on within approximately five minutes. However, if the fan is running but the compressor is not, the compressor lockout feature is operating (see **Lockout By-**

**pass Option** to temporarily override the compressor lockout feature during testing).

3. To program the thermostat, see **PROGRAMMING YOUR THERMOSTAT**.

After heating and cooling system have been checked and are running properly, determine if automatic changeover is desired. When option switch #4 is in the proper position, automatic changeover is en-

abled by pressing  until **AUTO** is displayed (see **SET OPTION SWITCHES**). In the **AUTO** mode, the setpoint temperature is not displayed.

## LOCKOUT BYPASS OPTION

### CAUTION

**FOR QUALIFIED SERVICE TECHNICIANS' USE ONLY. OPERATORS SHOULD NOT USE THIS FEATURE DUE TO POSSIBILITY OF EQUIPMENT OR PROPERTY DAMAGE, OR PERSONAL INJURY.**

**DO NOT USE THE LOCKOUT BYPASS OPTION UNLESS THE COMPRESSOR OIL HEATERS HAVE BEEN OPERATIONAL FOR 6 HOURS AND THE SYSTEM HAS NOT BEEN OPERATIONAL FOR AT LEAST 5 MINUTES.**

### COMPRESSOR LONG TERM CYCLE PROTECTION

To protect the compressor from potential damage due to temperature change of crankcase oil, this thermostat has a built-in time delay of one hour less

than the power loss to the unit (up to 12 hours maximum lockout). During this time, auxiliary heat will be used when necessary to maintain setpoint temperature. **DO NOT** attempt to override this delay feature before crankcase temperature has stabilized (for example, if power has been out for three hours, the compressor should remain locked out for two hours).

### COMPRESSOR SHORT TERM CYCLE PROTECTION

This thermostat has a built-in short term (5-minute) time delay. During this 5-minute period, the thermostat will lock out the compressor to allow head pressure to stabilize. If you want to override this feature while testing thermostat operation, simply

press  and  at the same time at initial startup.

---

## OPERATING YOUR THERMOSTAT

---

Before you begin programming your new thermostat, you should be familiar with its features and with the display and the location and operation of the thermostat buttons. The information in this section will help you become familiar with your thermostat so that you can easily program it.

Your thermostat consists of two parts: the **thermostat body** and the **subbase**.

**⚠ CAUTION**

Use  to turn the thermostat OFF before removing or attaching the thermostat body. Equipment damage and/or personal injury could occur.

The subbase is attached to the wall, but you can remove the thermostat body for easy programming. To remove the thermostat body from the subbase, grasp the thermostat body and gently pull it straight out from the subbase (see fig. 9). To attach the thermostat body, line up the four terminal pins on the upper section of the thermostat back with the matching connector on the subbase. Insert these, then gently pivot the thermostat body down to connect the

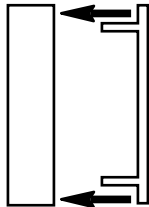

PULL STRAIGHT OUT

Figure 9. Removing thermostat from subbase

nine pin connectors on the lower portion of the thermostat back. Gently push until the snap connectors engage (see fig. 10). **DO NOT FORCE OR PRY THE THERMOSTAT**, as this may damage the unit.



ENGAGE TWO UPPER GUIDES; PIVOT DOWN

**Figure 10. Attaching thermostat to subbase**

## PARTS OF THE THERMOSTAT

### The Back of the Thermostat Body

Turn the thermostat body over. On the back are the 9 volt Energizer® alkaline battery and the option switches.

1. The 9 volt Energizer® alkaline battery provides power to the thermostat when the 24 VAC power is interrupted (for example, when you remove the thermostat from the wall for programming). A fresh battery will maintain the stored program for approximately one week. If power loss is long enough for the program to be lost, the thermostat will automatically maintain a factory pre-programmed heating temperature of 64°F and a cooling temperature of 82°F after power is restored. You must re-program the thermostat if this happens.



If the word **BAT** is flashing in the display window, the battery is low and should be replaced with a fresh 9 volt Energizer® alkaline battery. The

battery will provide power for all functions. If the word **BAT** is displayed continuously (non-flashing), the thermostat is not being supplied with 24 VAC power and is being powered by the battery alone.

 **CAUTION**

Use  to turn thermostat **OFF** before removing thermostat from the wall to replace the battery.

2. You may adjust option switch #4 for automatic changeover from heating to cooling (see **OPERATING FEATURES**).

Other than  and , the buttons are located behind the thermostat door. To open the door, use your fingernail in the indentation at the top center of the door. Pull the door out, then swing the door down on its hinges.

Following are brief descriptions of the display and the thermostat buttons.

### The Display

- ① Continuously displays system mode (**HEAT, EMER, OFF, COOL, AUTO, HOLD**). During programming, the program period is displayed (**MOR, DAY, EVE, NHT**).
- ② Alternately displays room temperature (**F** denotes degrees Fahrenheit and **C** denotes degrees Celsius) and time of day (**A** denotes AM time and **P** denotes PM time).
- ③ Displays the setpoint temperature.
- ④ **5 DAY** indicates that the displayed program is the weekday program. **2 DAY** indicates that the displayed program is the weekend program.
- ⑤ The word **BAT** flashes on the display when the 9 volt alkaline battery is weak and should be



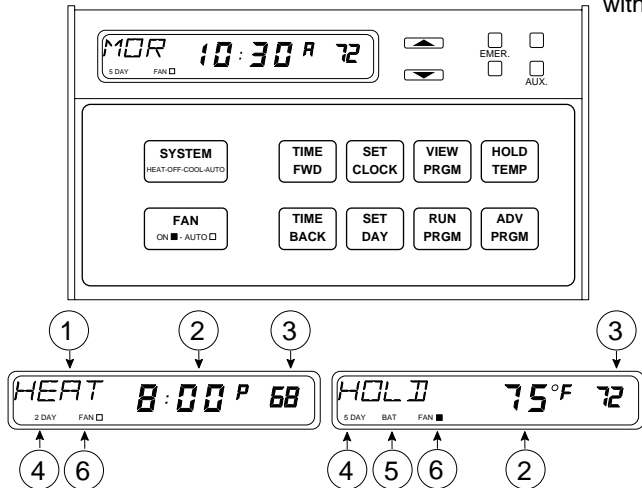

replaced. The word **BAT** will be displayed continuously (non-flashing) when the thermostat is operating on battery power only.

- ⑥ **FAN ■** is displayed when the blower is operating continuously, regardless of heating or cooling system cycling. **FAN □** is displayed during automatic fan operation (when the blower cycles with the heating or cooling system).



## The Thermostat Buttons and Lights

- ⑦ Sets the system mode (**HEAT**ing, **EMER**gency backup, **OFF**, **COOL**ing, or **AUTO**matic changeover [user selectable feature]).
- ⑧ Selects fan operation (see #6, previous page). This button is also used to program the fan to run continuously during a program period.
- ⑨ Runs display forward or backward through time, day, or anticipation settings during programming.
- ⑩ Used with  and  to set current time and day of the week.
- ⑪ Used during programming to set the day of the week. Also used with  to enter anticipation setting mode.
- ⑫ Used to initiate or review thermostat programming.
- ⑬ Used to start program operation after programming. Also used to return thermostat to program operation after being in **HOLD** mode.
- ⑭ Used to manually override programming to hold at a selected temperature (when **HOLD** is displayed).
- ⑮ Used to advance thermostat program to the next program period (for example, from the **MOR** program to the **DAY** program).
- ⑯ (Blue arrow) Lowers temperature setting (40°F or 4°C minimum).
- ⑰ (Red arrow) Raises temperature setting (99°F or 37°C maximum)

⑱ **EMER** light indicates that the system is in the emergency mode (the heat pump compressor is off and the auxiliary system is maintaining

setpoint temperature — there is a 5 to 10 minute startup delay on the first emergency cycle). **AUX** light indicates that the auxiliary system is operating.

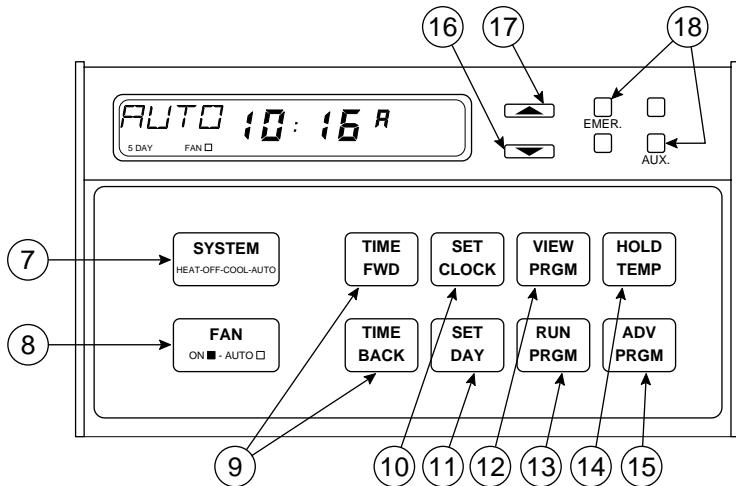

## OPERATING FEATURES

Now that you are familiar with the thermostat display and buttons, read the following information to learn about the many features of the thermostat.

- **COMPUTED ENERGY MANAGEMENT RECOVERY (EMR)** - The thermostat's microcomputer automatically calculates the time it will take to change the temperature to the next program setting. Then the thermostat will activate the heating or cooling system to change the temperature so that the desired temperature is reached at the beginning of the next program period. As an example of this feature, assume that you have programmed your thermostat to provide an overnight heating temperature of 62°F, and that during the next program period, beginning at 6:00 AM, you have programmed a temperature of 70°F. The thermostat will automatically activate the heating

system at about 5:00 AM, so that the programmed 70°F temperature is reached by about 6:00 AM.

- **AUTOMATIC CHANGEOVER** — You can set the thermostat to automatically switch the system from heating to cooling as needed. First, you must move option switch #4 (located on the back of the thermostat body) to the **ON** position, if it has not already been done. To do this, press



until thermostat is OFF. Then, remove the thermostat body from the wall. Check the position of switch #4 (the last switch on the right). If it is **ON** (up), simply put the thermostat back on the wall and restore 24 VAC power. If the switch is **OFF** (down), use a pencil or small screwdriver to move the switch to the **ON** position (see figure at right). Leave the battery out of the thermostat for at least **two minutes**, to allow the thermostat to reset itself. **DO NOT MOVE ANY OTHER OPTION SWITCH**, as it may

affect thermostat operation. Replace the battery, re-program the thermostat if necessary, put the thermostat back on the wall, and use



to set thermostat for desired operation. To set the thermostat for automatic changeover after programming, press



to set the thermostat to **AUTO** (the setpoint display is blank in the **AUTO** mode). The system will now automatically switch between heating and cooling depending on the actual room temperature.

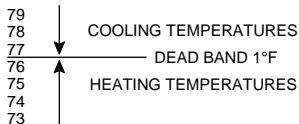



## AUTOMATIC CHANGEOVER (ON)



Switch #1 set at installation (**DO NOT CHANGE**)  
Switch #2 set at installation (**DO NOT CHANGE**)  
Switch #3 set at installation (**DO NOT CHANGE**)  
Switch #4 **ON**

## NOTE



In the **AUTO** mode, the thermostat will not allow the temperature separation between the highest heat setting and the lowest cool setting to be less than 1°F. For example, if the highest heat setting is 76°F, the lowest cool setting cannot be below 77°F (see diagram at left).

If the automatic changeover feature is enabled, and you wish to disable it, press  until thermostat is OFF. Then, remove the thermostat body from the wall. Move the switch to the **ON** position (see figure at right). Leave the battery out of the thermostat for at least **two minutes**, to allow the thermostat to reset itself. **DO NOT MOVE ANY OTHER OPTION SWITCH**, as it may affect thermostat operation. Replace the battery, re-program the thermostat if necessary, put the thermostat back on the wall, and use  to set the thermostat as desired.

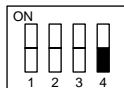

## AUTOMATIC CHANGEOVER (OFF)



Switch #1 set at installation (**DO NOT CHANGE**)  
Switch #2 set at installation (**DO NOT CHANGE**)  
Switch #3 set at installation (**DO NOT CHANGE**)  
Switch #4 **OFF**

- **TWO HOUR TEMPERATURE OVERRIDE** — Press  or  until the display shows the temperature you want. The thermostat will override current programming and keep the room temperature at the selected temperature for two hours. After two hours, the thermostat will automatically revert to the program.
- **HOLD TEMPERATURE** — The thermostat can hold any temperature within its range for an indefinite period, without reverting to the pro-

gram. Press **HOLD TEMP**. **HOLD** will be displayed.

Then choose the desired hold temperature by pressing  or . The thermostat will hold the room temperature at the selected setting until you press

**HOLD TEMP** to start program operation again. This feature is ideal for energy conservation when the building is unoccupied for an extended period of time.

- **°F/°C CONVERTIBILITY** — Press **TIME FWD** and **TIME BACK** at the same time until the temperature display is in °C (Celsius). To display °F, repeat the process.
- **ADJUSTABLE HEATING AND COOLING CYCLE TIMES (ANTICIPATION)**— If the heating/cooling system is turning on and off too often (short cycles) or not often enough (long

cycles), you may want to adjust the anticipation setting.











### **CAUTION**

**An anticipation setting of less than 10 may cause decreased compressor life.**

To adjust **HEAT** anticipation, press **SET CLOCK** and

**SET DAY** at the same time. The display will show **HEAT 18**. You may select any anticipation setting from 4 to 40 (**note that for add-on heat pump systems, a minimum anticipation of 10 is recommended**). When you adjust anticipation, increase or decrease the displayed number by only one or two digits, then let the system run for a while to see if the adjustment is sufficient. If the heat cycles are too short, press



**TIME FWD** to increase the cycle time. If the heat

cycles are too long, press  to decrease the cycle time. To set **COOL** anticipation, press  and  at the same time again. The display will show **COOL 14** (factory preprogrammed cooling anticipation). Use  and  to adjust anticipation. To set **AUXILIARY** heat anticipation (not applicable to multi-stage use), press  and  at the same time again. The display will show **AUX 8** (factory preprogrammed auxiliary anticipation). Use  and  to adjust anticipation. Press  to return to your program.

- **LOW BATTERY INDICATOR** — The word **BAT** will flash on the display if the battery is low and should be replaced. When **BAT** is displayed

continuously (non-flashing), 24 VAC power is not being supplied and the thermostat is working on battery power only.

- **COMPRESSOR SHORT CYCLE PROTECTION** — To protect your compressor from potential damage due to rapid cycling, this thermostat has a built-in delay of 5 minutes between cooling cycles. The following may cause a time delay in **COOL** or **HEAT**:

- a) Return of power after a momentary power outage.
- b) Pressing  to change operating modes.
- c) Pressing  or  to create a call for **COOL** or **HEAT** too soon after a previous call.

During lockout in the **COOL** mode, the blower will operate, but compressor operation will be delayed.



Auxiliary heat is functional during the compressor lockout and can be used as needed to maintain room temperature.

- **COMPRESSOR LONG TERM CYCLE PROTECTION** — If your system begins to operate too soon after an extended power outage, the compressor may be damaged due to crankcase oil temperature change. This thermostat has a built-in time delay of one hour less than the power loss (up to 12 hours). When power is restored to the system, heaters in the system will begin to heat the crankcase oils. The thermostat's time delay will lock out the compressor to prevent its operation until the compressor oil is sufficiently warmed. During the lockout time period, the auxiliary heating system will operate to maintain setpoint temperature.

For example, if a power outage of three hours occurs, the compressor will be locked out for two hours.

- **SYSTEM INDICATOR LIGHTS** — The lights on the upper right part of the thermostat indicate system operation (see **PARTS OF THE THERMOSTAT** for specific descriptions of what each light indicates).
- **PROGRAMMABLE BLOWER CONTROL** — You may program the fan blower to run continuously during any given program period, regardless of the cycling of the heating or cooling system. During programming, after entering the time and temperature for the time period, press



until **FAN** ■ is displayed. To override constant fan, press  until **FAN** □ is displayed.

---

## PROGRAMMING YOUR THERMOSTAT

---

Now you are ready to program your thermostat. This section will help you plan and program your thermostat to meet your needs.

For maximum comfort and efficiency, keep the following guidelines in mind when planning your program.

- When heating (cooling) your building, program the temperatures to be cooler (warmer) when the building is vacant or during periods of low activity.
- During early morning hours, the need for cooling is usually minimal.

### PLANNING FOR YOUR NEEDS

This thermostat will store separate heating and cooling programs for five-day (weekday) and two-day (weekend) operation. Usually, the five-day program is set to run Monday through Friday, and the

two-day program is set to run Saturday and Sunday. However, you may choose any five consecutive days to be your weekday program days (such as Sunday through Thursday; in this case, your weekend program would run on Friday and Saturday).

First, you should answer the following questions to help you decide what your needs are. If you are using the thermostat for a commercial application (a store, office building, etc.), answer questions 1 through 4. If you are using the thermostat in your home, answer questions 5 through 8. Keep in mind that you should plan for both weekday and weekend programs.

FOR COMMERCIAL APPLICATIONS:

1a. What time does the first person arrive at the building in the morning?

- b. What temperature should the building be at this time? (heating? cooling?) These will be your **MOR** (morning) temperature settings.
- 2a. What time do the building occupants reach a maximum activity level (using lights, equipment, meeting rooms, etc.)?
- b. What temperature should the building be at this time? These will be your **DAY** temperature settings.
- 3a. What time do the building occupants reach a minimum activity level (limited personnel in building)? These will be your **EVE** (evening) temperature settings.
- b. What temperature should the building be at this time?
- 4a. What time does the building become vacant?
- b. What temperature should the building be at this time? These will be your **NHT** (night) temperature settings.

#### IN YOUR HOME:

- 5a. What time does the first person get up in the morning?
- b. What temperature should the house be at this time? These will be your **MOR** (morning) temperature settings.
- 6a. What time does the last person leave the house in the morning?
- b. What temperature should the house be at this time? These will be your **DAY** temperature settings.
- 7a. What time does the first person arrive home in the evening?
- b. What temperature should the house be at this time? These will be your **EVE** (evening) temperature settings.

8a. What time does the last person go to bed at night?

b. What temperature should the house be at this time? These will be your **NHT** (night) temperature settings.

Now look at the factory preprogrammed times and temperatures shown below. If this program will suit

your needs, simply press  to begin running the factory preset program.

If you want to change the preprogrammed times and temperatures, do the following.

## NOTE

To operate properly in the **AUTO** mode, there must be a **minimum 1°F separation** between the highest heat temperature and the lowest cool temperature (see diagram below).

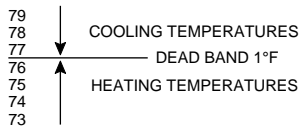

Determine the time periods and heating and cooling temperatures for your weekday program. You must program 4 periods for each day (**MOR**, **DAY**, **EVE**, and **NHT**). However, you may use the same heating

---

### Heating Program for ALL days of the Week:

PERIOD	TIME	TEMP
MOR	5:00 AM	70
DAY	9:00 AM	70
EVE	4:00 PM	70
NHT	10:00 PM	64

### Cooling Program for ALL Days of the Week:

PERIOD	TIME	TEMP
MOR	5:00 AM	78
DAY	9:00 AM	82
EVE	4:00 PM	78
NHT	10:00 PM	78

and cooling temperatures for consecutive time periods. You can choose start times, heating temperatures, and cooling temperatures independently for both weekday and weekend programs (for example, you may select 5:00 AM and 70° as the weekday **MOR heating** start time and temperature, and choose 7:00 AM and 76° as the weekday **MOR cooling** start time and temperature). Use the table on the next page to plan your program time periods, and the temperatures you want during each period. You may also want to look at the sample program table to get an idea of how the thermostat can be programmed.

## ENTERING YOUR PROGRAM

Follow these steps to enter the heating and cooling programs you have selected.

### NOTE

We recommend that you remove the thermostat from the wall for programming (especially for entering cooling programming). A fresh 9 volt Energizer® alkaline battery must be installed to perform off-wall

programming. **BE SURE TO PRESS**  **TO TURN THERMOSTAT OFF BEFORE REATTACHING TO SUBBASE!**

You cannot program the thermostat with the **SYSTEM SWITCH** in the **AUTO** position.

(Instructions continue on page 40).

## Heating/Cooling Schedule Plan

	WEEKDAY (5 DAY)		WEEKEND (2 DAY)	
	Start Time	Temperature	Start Time	Temperature
<b>MOR HEAT</b>				
<b>DAY HEAT</b>				
<b>EVE HEAT</b>				
<b>NHT HEAT</b>				
<b>MOR COOL</b>				
<b>DAY COOL</b>				
<b>EVE COOL</b>				
<b>NHT COOL</b>				

**SAMPLE  
Heating/Cooling Schedule Plan**

	<b>WEEKDAY (5 DAY)</b>		<b>WEEKEND (2 DAY)</b>	
	Start Time	Temperature	Start Time	Temperature
<b>MOR HEAT</b>	5:30 AM	68°	7:00 AM	68°
<b>DAY HEAT</b>	8:00 AM	65°	11:00 AM	70°
<b>EVE HEAT</b>	5:00 PM	70°	6:00 PM	70°
<b>NHT HEAT</b>	10:30 PM	65°	11:30 PM	65°
<b>MOR COOL</b>	6:30 AM	76°	7:00 AM	76°
<b>DAY COOL</b>	2:00 PM	78°	12:30 PM	74°
<b>EVE COOL</b>	5:00 PM	72°	6:00 PM	72°
<b>NHT COOL</b>	10:30 PM	78°	11:30 PM	78°

## Set Current Time and Day

1. Press **SET CLOCK** once. The display will show minutes only.

EXAMPLE: 

2. Press and hold either **TIME FWD** or **TIME BACK** until you reach the correct minutes.

3. Press **SET CLOCK** once. The display window will show the hour only.

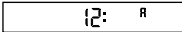
EXAMPLE: 

4. Press and hold either **TIME FWD** or **TIME BACK** until you reach the correct hour and AM/PM designation (**AM** begins at midnight; **PM** begins at noon).

5. Press **SET DAY** once. The display will show the day of the week as an abbreviation (**MO** for Monday, **TU** for Tuesday, etc.).

6. Press and hold either **TIME FWD** or **TIME BACK** until you reach the current day of the week.



7. Press **RUN PRGM** once. The display will show the correct time and room temperature alternately.

## Enter Heating Program

During programming, if you don't press any buttons for 5 minutes, the thermostat will enter the **HOLD** mode and will maintain a constant temperature. The display will revert to the alternating time/temperature display. To resume programming after this happens, press **VIEW PRGM** until you are at the point where you stopped programming. Then you may continue to enter your programs normally. If you









want to stop programming at any time, simply press  to resume program operation.

1. Press  until **HEAT** is displayed.
2. Press  once. **5 DAY** (indicating weekday program), and **MOR**, representing the **morning** heating period, will appear in the display. Also displayed are the currently programmed start time for the **MOR** period and the currently programmed temperature.

EXAMPLE: 

This display window shows that for the weekday **MOR** period, the start time is 5:00 AM, and 64° is the programmed temperature (this example reflects factory preprogramming).

3. To change the displayed start time to your selected start time for weekday **MOR** heat program, press  or  until your selected time appears. The time will change in 15 minute increments.
4. Press  or  until you reach your selected weekday **MOR** heating temperature.
5. If you want the fan to run continuously during this period, press  until **FAN ■** is displayed.
6. Press . The currently programmed start time and heating temperature for weekday **DAY** will be displayed.
7. Repeat steps 3 through 5 to select the start time and heating temperature for the weekday **DAY** program.
8. Repeat steps 3 through 7 for the weekday **EVE** and **NHT** heating programs.

9. After entering your weekday heating program, repeat steps 1 through 8 for your weekend programming (keep in mind that for weekend programming, the display should be changed from **5 DAY** to **2 DAY**).
10. When you have completed entering your heating program, press  .

## Enter Cooling Program



If outside temperature is below 50°F, we recommend that you remove the thermostat from the wall before proceeding with the following steps to program cooling temperatures. Personal injury or property damage may occur due to air conditioner compressor slugging. A fresh 9 volt Energizer® alkaline battery must be installed to perform off-wall programming. Programming away from the wall should prevent accidental compressor operation. **BE SURE TO USE**







**TO TURN THERMOSTAT OFF BEFORE REATTACHING TO SUBBASE!**

1. Press  until **COOL** is displayed.
2. Follow the procedure for entering your heating program, using your selected cooling times and temperatures.



## CHECK YOUR PROGRAMMING

Follow these steps to check your thermostat programming one final time before beginning thermostat operation.

1. Press  until **HEAT** is displayed.
2. Press and hold  to view the heating period times and temperatures in sequence for week-day, then weekend **MOR**, **DAY**, **EVE**, and **NHT** program periods.
3. Press  .

4. Press  until **COOL** is displayed.
5. Repeat step 2 to check cooling temperatures.
6. Press  to begin program operation.

**YOUR THERMOSTAT IS NOW COMPLETELY PROGRAMMED AND READY TO AUTOMATICALLY PROVIDE MAXIMUM COMFORT AND EFFICIENCY!**





Press  until **OFF** is displayed. Reattach thermostat to subbase. Then press  to select the operation mode you want (**HEAT**, **COOL**, **AUTO**). Press  until **FAN**  is displayed (automatic cycling).

---

## QUESTIONS AND ANSWERS

---

1. How can I permanently change a part of my program?



Press  until you reach the time/temperature schedule you want. Then press  or  and  and  to change the program. See **PROGRAMMING YOUR THERMOSTAT**.

2. How can I have no change in temperature from one time period to another?

Simply select the same temperature for each consecutive time period. For example, you may select the same weekday **EVE** cooling temperature as you did for weekday **DAY**, which means the temperature will not change when the **EVE** period begins. See **PROGRAMMING YOUR THERMOSTAT**.

3. How can I finish my programming if the display has already changed to time/temperature?

During programming, if no buttons are pressed for five minutes, the thermostat will enter the **HOLD** mode and maintain a constant temperature. The display will change to the time/temperature mode. To resume programming, press

 until you return to the point where you stopped programming. Then you may continue to program the thermostat normally. If you want to stop programming at this point, press  to start the normal program function. See **PROGRAMMING YOUR THERMOSTAT**.

**4. What happens if the electricity goes off or is manually shut off?**

If you have not installed a 9 volt alkaline battery, the display will go blank and the program will be lost in approximately one minute. When electricity is restored, the thermostat will maintain a heating temperature of 64°F and a cooling temperature of 82°F until you reenter your program. Setpoint temperature will not be displayed.

If a fresh 9 volt Energizer® alkaline battery is installed, the program will be maintained for about one week with no 24 VAC power present to the thermostat. See **OPERATING YOUR THERMOSTAT**.

**5. Why can't I program the thermostat in the AUTO mode?**

The thermostat can only be programmed in the **HEAT** and **COOL** modes. See **PROGRAMMING YOUR THERMOSTAT**.

**6. What can cause the thermostat display to freeze or go blank?**

A completely blank display may indicate that power has been lost to the thermostat and the backup battery is also dead. However, if there is power to the thermostat and the display is blank or frozen, static discharge is probably the cause.

During periods of low humidity (especially during cold weather), you may feel or see a spark discharge when you touch the thermostat. This may cause the program to be lost or the thermostat to display incorrectly. To correct this, remove the thermostat from the wall and disconnect the battery. Wait about one minute, then re-connect the battery. The thermostat will revert to the factory preset program until you re-program the thermostat. If you don't want to re-program the

thermostat immediately, press  until **OFF** is displayed and replace the thermostat on

the wall. Then press



for desired sys-

tem operation, and press



to begin the

factory preset program. Or you may re-program the thermostat, then replace it on the wall.

To prevent further static discharge problems, touch another object to release static build-up before touching the thermostat. See **OPERATING YOUR THERMOSTAT**.

#### 7. Why won't the setpoint temperature go to the temperature I want?

In the **AUTO** mode, the highest heating setpoint temperature you select must be at least 1°F lower than the lowest cooling setpoint temperature you select (for example, if 70°F is your lowest selected cooling temperature, you cannot select a heating temperature any higher than 69°F). If such a conflict exists, you must set the lowest cooling temperature higher in order to set

the heating temperature higher. To set a lower cooling temperature, you must select a lower heating temperature. See **PROGRAMMING YOUR THERMOSTAT**.



#### 8. The display is flashing BAT. What does this mean?

The 9 volt battery installed in the thermostat is low and should be replaced with a fresh 9 volt Energizer® alkaline battery. See **OPERATING YOUR THERMOSTAT**.



#### 9. The display shows a continuous (non-flashing) BAT. What does this mean?

The thermostat is not being supplied with 24 VAC power. The thermostat is operating on battery power alone. See **OPERATING YOUR THERMOSTAT**.

## 10. Why won't the system turn on, even though the thermostat display is functioning normally?

Either the compressor lockout feature is in operation or the thermostat is not currently calling for heat or cool. Wait about 5 minutes for the compressor lockout to expire. If the system is still not running, read the cautionary statement below. Then, **if conditions permit**, use the  or  buttons to move the temperature above or below the setpoint temperature. See **OPERATING YOUR THERMOSTAT**.

### CAUTION

If the outside temperature is below 50°F, **DO NOT** use  or  to move the temperature above or below the setpoint temperature. Property damage may result due to compressor slugging.

## 11. Why doesn't the temperature change at the time I programmed?

There may be a number of causes for this situation. The following are primary reasons.

- The **EMR** function is operating. The **EMR** function will automatically bring on the system automatically to bring the temperature to the selected level by the beginning of the next program period. See **OPERATING YOUR THERMOSTAT**.
- You have programmed the incorrect day or time. Check your programming (be sure that the times you programmed are correct AM or PM times). See **PROGRAMMING YOUR THERMOSTAT**.
- The thermostat is in the **HOLD** mode. Press  to start program operation. See **OPERATING YOUR THERMOSTAT**.

- The compressor lockout feature is operating; wait about 5 minutes for system to begin running. See **OPERATING YOUR THERMOSTAT**.

### 12. Why does the blower fan keep running after the system has turned off?



- You have programmed the fan to run continuously during this period. See **PROGRAMMING YOUR THERMOSTAT**.
- The blower delay feature is operating. This energy saving feature continues to blow conditioned air through the ducts after the system has turned off, rather than letting the air dissipate.

### 13. Why is the system turning on and off so frequently (seldom)?

The anticipation setting is too low (high). To change anticipation settings, see **OPERATING YOUR THERMOSTAT**.

### 14. Between heating and cooling seasons, I want to turn my system off. Can I do this without affecting my thermostat programming?

Any time you wish to turn your system off, simply

press  until **OFF** is displayed. This will not affect your thermostat's programming in any way. To turn the system back on, press 

until **HEAT**, **COOL**, etc. is displayed. The system will automatically begin operating according to the current thermostat program, unless the thermostat is in the **HOLD** mode. See **OPERATING YOUR THERMOSTAT**.





**15. I live in an area where daylight savings time is observed. How do I change the thermostat clock twice a year without affecting thermostat programming?**

To change your clock, follow the instructions for setting current time and day. See **ENTERING YOUR PROGRAM**. Thermostat programming is not affected when you change the clock.

**17. Do I have to re-program my thermostat after I change the battery?**

When the thermostat is on the wall and the system has power, the thermostat is being powered by a 24v AC source. If power is lost, or if the thermostat is removed from the wall, the program will be retained for approximately **one minute** if there is no battery installed or if the installed battery is dead. If you are changing the battery after seeing a flashing **BAT** on the display, the installed battery may be dead. If you remove the old battery and install a fresh one

within one minute, you may not lose your thermostat programming. After installing a new battery, follow the procedures in **CHECK YOUR PROGRAMMING** to determine whether your programming was maintained. If the thermostat maintains programming, press  until **OFF** is displayed, put the thermostat back on the wall, press  to select the operating mode you want, then press  to start program operation. If the program is lost, re-program the thermostat. See **PROGRAMMING YOUR THERMOSTAT**.

---

## NOTES

---

---

## NOTES

---

---

---

---

---

---

---

---

---

---

---

If you need further information about this product, please write to

**White-Rodgers Division, Emerson Electric Co.**

9797 Reavis Road

St. Louis, MO 63123-5398

Attn: Technical Service Department

**Part No. 37-5414A**

9513